

WARNING:
CHOKING HAZARD - Small parts
Not for Children under 3 years.

KidzLabs™ Animation Praxinoscope

Rebuild the 100-year-old optical toy which demonstrates the working principle of modern animations. View animation discs provided and be amazed how still pictures come alive. Comes with an LED lamp which "flashes" like early movies. It's an inspiring optical science kit.

A. SAFETY MESSAGES

1. Please read through these instructions before you start.
2. Adults assistance and supervision is recommended.
3. This kit and its finished product contain small parts which may cause a choking hazard if misused. Keep away from children under 3 years old.
4. This kit is intended for children of aged above 8.

B. USE OF BATTERIES

1. Use 2 x 1.5V LR44 button cell batteries.
2. Unscrew the battery case cover to replace batteries. Adult supervision is required.
3. Non-rechargeable batteries are not to be recharged.
4. Rechargeable batteries are to be removed from the toy before being recharged.
5. Rechargeable batteries are only to be recharged under adult supervision.
6. Different types of batteries or new and used batteries are not to be mixed.
7. Only batteries of the same or equivalent type as recommended are to be used.
8. Batteries are to be inserted with the correct polarity.
9. Exhausted batteries are to be removed from the toy.
10. The supply terminals are not to be short-circuited.

C. OTHER MATTERS ATTENTIONS FOR

Do not touch the spinning drum as it will leave finger prints on its surface. Clean it with damp soft cotton if required.

D. CONTENTS

- 1 x set of praxinoscope body parts, batteries included, assembly required, (height about 13cm when assembled)
- 6 x animation discs (double-sided and printed featuring 12 animations)
- 6 x blank animation discs (3 blank with a cross printed on it and 3 with a grid printed, double-sided and printed for producing 12 animations)
- 1 x set of detailed instructions with fun facts

E. ASSEMBLY

Follow the diagram to build your animation praxinoscope.

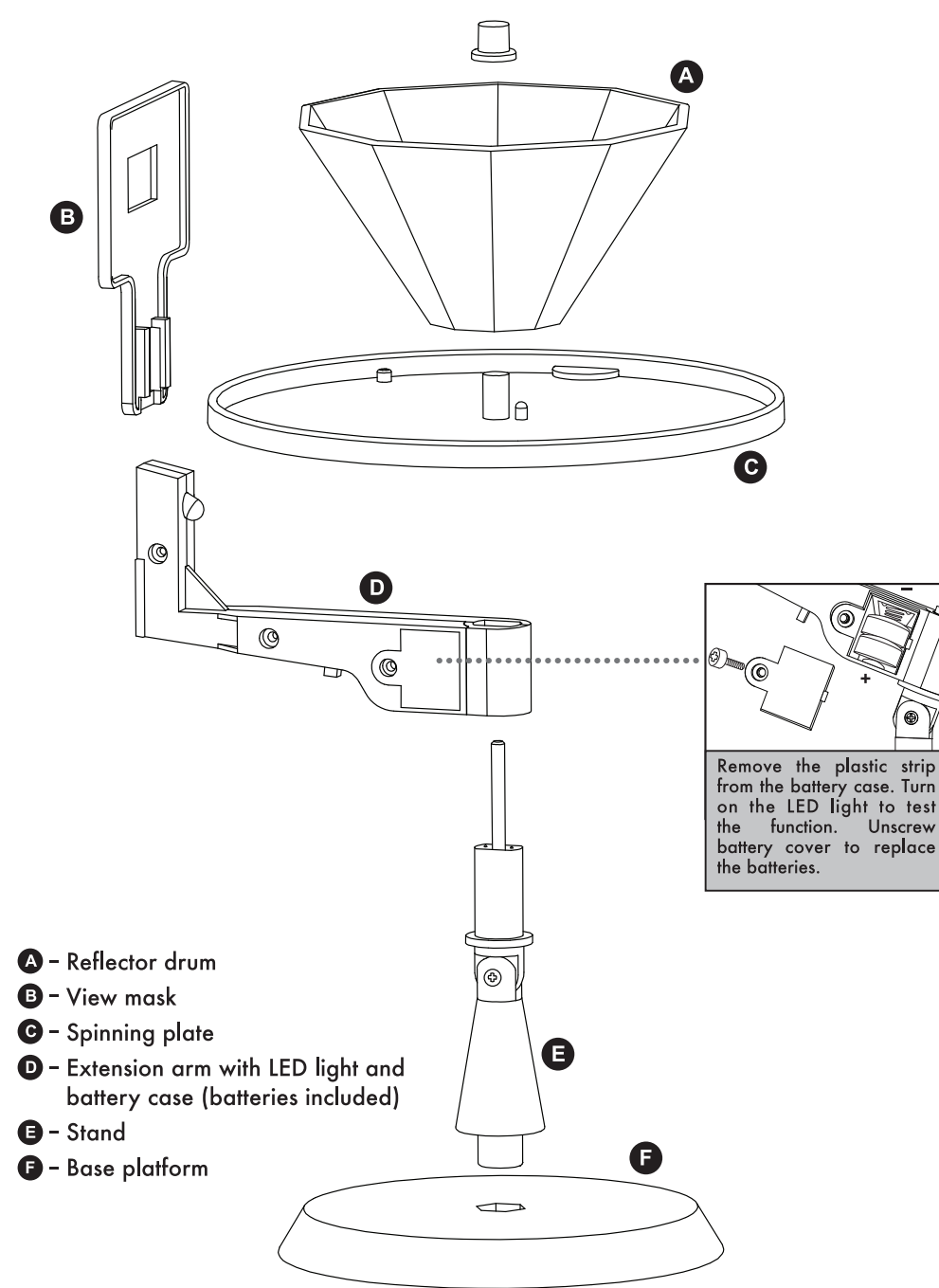

F. HOW TO VIEW ANIMATIONS

- Place the animation disc on the spinning plate. Secure it underneath the slots at the rim. There is an extrusion point on the edge of the spinning plate. Make sure the corresponding hole (marked a triangle next to it) on the animation disc is aligned with this extrusion point. This is to align the animation frames with the reflector drum surfaces. It also prevents the animation discs from moving when the spinning plate is in motion.
- Adjust the stand angle, turn the spinning plate gently, look through the view mask and you will be amazed how the still pictures now come alive. Most of the animations supplied are designed for anticlockwise spinning, but you could also try to spin clockwise to view the animation in reverse. Different animations will work better with different speeds. Experiment and find out the right speed for different animations. At night, turn the LED light on. You will be amazed by the flashing effect which simulates early movies.

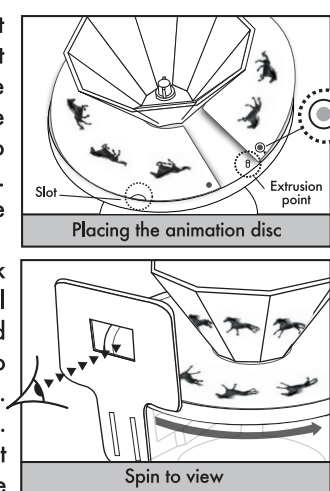

G. CREATE YOUR OWN ANIMATIONS

What is an animation? Animation is a moving action which is a sequence of still pictures. Each of these still pictures depicts a part of the whole action at one time. When these pictures are run and viewed in sequence at high speed, they produce an illusion as if they are moving in a continuous sequence. For example, now produce a bouncing ball action with a 10 frame animation. The ball first starts from the left upper corner, then drops to the middle and bounces to the right upper corner to end. The 10 still pictures will be drawn as follows. When these pictures are run and viewed at high speed, e.g. one tenth of a second per frame, you will see the ball bouncing as intended. For those elements which are intended to be still in the animation, just draw them in the same position throughout the 10 animation frames, e.g. like the goal as in the bouncing ball animation. They will appear still when the animation is run. The quality of an animation will be improved by increasing the running speed or by increasing the quantity of the still pictures used. This bouncing ball animation disc is supplied in this kit. View it with the praxinoscope and see how still pictures come alive. Drawings are flipped on the disc so as to reverse back the flip caused by the reflector drum.

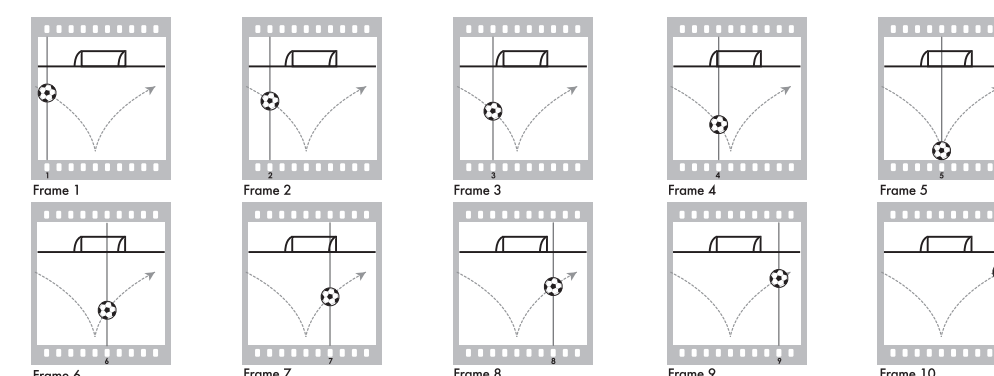

Now it's your turn to create your own animations.

- Handy hints: Before you start making your own animations, take a few photocopies of the blank discs and keep them for future use.
- The praxinoscope provided is for running a 10-frame animation. Since it's a very short animation, the designed motions should not be too complicated. An animation with a repeating motion cycle on a still background will be the optimum for the praxinoscope.
- It is recommended that you first draft your animation plot on a piece of paper. Fine tune them before finalising them on the animation disc.
- Please note the animation image will be flipped when viewed. If your animation contains letters or numbers, please make sure they are flipped on the animation disc. It is recommended that you start with drawings which work in both direction so that you have no need to take into account the flipping effect when you first start.
- If your animations are sequenced to be viewed under anticlockwise spinning as those supplied, you will need to arrange the frames in a clockwise sequence as the diagram shows.
- There are two kinds of blank discs provided. One is printed with a grid and the other with a cross printed at the centre. They are designed for dot matrix and free hand drawn animations respectively as suggested below:

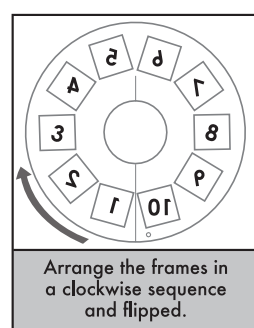

1. Dot matrix

If you are a beginner with regard to animation or free hand drawings, it is recommended you start by using the blank disc with grids printed. The grid will help to control precise positions of different frames, producing a better smooth animation.

- Plan your 10 frame animation on a piece of blank paper before you start. Slightly outline the first animation with a pencil on the dot matrix grid. After the outline is completed, fill the entrapped grids with a solid colour. That will make your first animation frame.
- Continue with the other 9 frames until the whole animation is complete. You may also first outline all 10 frames, then fine tune them before starting to fill them in with solid colour in the grids.
- Check every detail then place the disc on the spinning plate. Spin the wheel and here goes your first animation. It will look like a digital one.

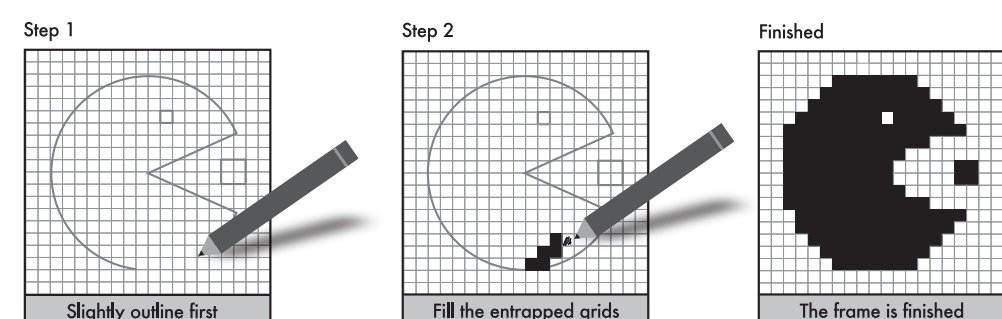

Here are some suggestions which you could start on with the dot matrix. The first two and the last frames are provided as drawing hints; please draw the 3rd to 9th frames to complete the animation.

An early TV Game monster ...

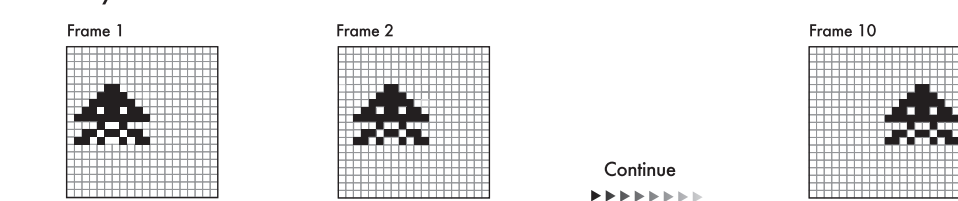

A running word banner saying "HEY"...

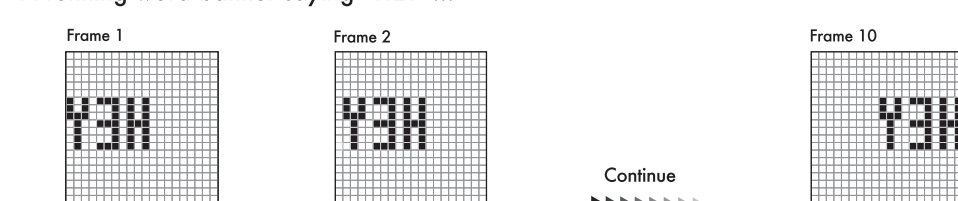

2. Free hand drawing

You could also make your animation with free hand drawing, but certainly it requires more skill in drawing and positioning. There are some blank discs with just a cross mark printed at the centre. Use them for your free hand drawing animation. The centre cross mark is a position reference. Here are some suggestions for simple free hand drawings which you could start with:

A simple face expression from smile to sad...



A simple raising of arms action by a "stick man"...

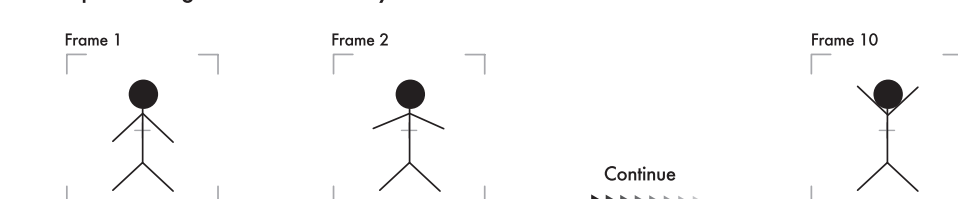

H. FURTHER ACTIVITIES

1. You could create other animations without drawings. You need a computer to do the following:
 - Ask an adult to scan the blank disc into any image processing software.
 - Extract continuous photos from a home digital video strip. Most digital video recorders come with software for image editing on a computer. Adjust the photos' sizes to fit the disc. Paste them onto the disc. Print and cut them out and make a praxinoscope version of the video strip. The fun is different.
 - There are lots of short animations on the internet. Download them as still picture files, adjust their sizes and paste them on the disc. You may search for some animation sites, but make sure there is no copyright issue before you do any downloading. Ask for an adult's supervision when using the internet.
2. You may decorate your view mask to make your animation more interesting. For example, if your animation is about car racing, you may draw a still picture frame of a countryside scene and paste it in front of the view mask, etc. This will add to your animation a more "professional cinema touch". The fun is unlimited.
3. You may also enlarge the discs with a photocopier. Draw on the enlarged disc to allow you more detail in your animation. After you finish the animation drawing, reduce it to the original size.

I. FUN FACTS

How does a praxinoscope work? Invented in 1877 by Frenchman Emile Reynaud, the more-than-100-year-old optical toy demonstrates the working principle for all animations we view in the modern day. The principle is called the Persistence of Vision. This simple theory states that when an image is perceived, the retina captures the image for about one tenth of a second before processing the next image. If a series of stationary pictures (an animation) flashes at a speed of quicker than 10 frames per second, the brain will be confused and will "bind" all the stationary pictures and create the perception of movement. The animations we view these days are more complicated in the sense that they may contain more than hundreds of thousands of detailed stationary pictures to make up the length of a standard movie. However, the underlying working principle is no different to the praxinoscope introduced in this kit.

QUESTION AND COMMENTS

We treasure you as a customer and your satisfaction with this product is important to us. In case you have any comments or questions, or you find any parts of this kit missing or defective, please do not hesitate to contact our distributor in your country, whose address is printed on the package. You are also welcome to contact our marketing support team at Email: infodesk@4M-IND.com, Fax (852) 25911566, Tel (852) 28936241, Web site: WWW.4M-IND.COM