

BUBBLE SCIENCE

⚠ WARNING:
CHOKING HAZARD - Small parts.
Not for Children under 3 years.

To Parents: Please read through these instructions before giving guidance to your children.

A. SAFETY MESSAGES

1. Read carefully through all these instructions before you start. Adult supervision is always required.
2. This kit is intended for children aged over 5.
3. Always wash your hand after playing with bubbles. Avoid contact between bubble mixture and your mouth or eyes.
4. Playing with bubble solution can be messy, so it is best to carry out all the experiments outdoors. If you have to work indoors, cover surfaces with newspapers before you start.
5. Use of scissors required. Adult supervision is required when using scissors.

B. CONTENTS

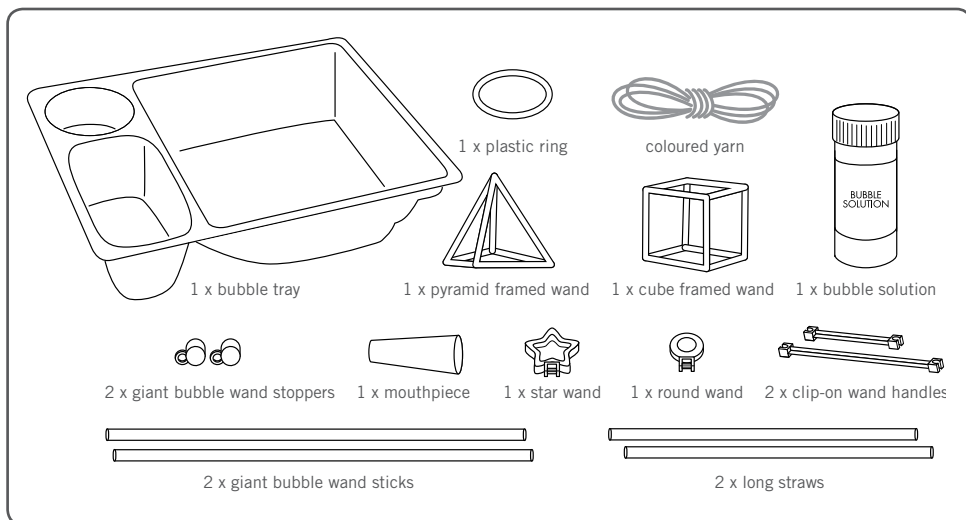

Remarks: Also required for some activities, but not included in this kit: plain paper, sticky tape, scissors, poster paints, a jar or container, a container or measuring jug. A bottle of bubble solution is included in this kit. However, you will need to mix extra bubble solution to perform some of the tricks, such as making the mega bubble and bubble film. Detergent and a few other household items are required from home to make bubble solution (recipes are included in the instructions).

BUBBLE ACTIVITIES

Here are instructions for lots of great activities to enjoy with your bubble kit. You do not have to do them in this order. Read the instructions for each activity before you start.

C. MIX YOUR OWN BUBBLE SOLUTION

A bubble solution is included in this kit. However, you need to mix additional bubble solution for some of the tricks below, such as the mega bubble, the bubble film, and bubble geometry. You could buy bulk bubble solution from a toy store or follow the recipes below to mix your own bubble solution. As a quick start, you can simply dilute dish-washing detergent to make a basic solution. But if you want to make large bubbles and bubble films, you will need to mix a better bubble solution.

Making your own bubble solution is fun. Here are two recipes which produce good-quality bubble solution. For both recipes you need a good-quality dish-washing detergent. These have different names in different countries (e.g. Joy, Fairy, Ivory, Morning Fresh and Fairy Dawn). They also often come in different strengths: standard and ultra. Tap water is okay for making bubble solution, but distilled water is better if you can get it. You will need a measuring jug and a spoon to prepare the mixture.

MIXTURE 1

Materials required: standard or ultra dish-washing detergent, sugar, glycerin (available from your local pharmacy, this is optional), a container for mixing.

Put 200 ml (6.7 fl oz) of warm water into a measuring jug. Stir in a tablespoon of sugar until the sugar has dissolved. Add 50 ml (1.5 fl.oz) of standard dish-washing liquid or 30 ml (1 fl.oz) of ultra dish-washing detergent to the water. Stir in a tablespoon of glycerin, if you have some. Finally, add 300ml (10 fl.oz) of water into the mixture and stir well.

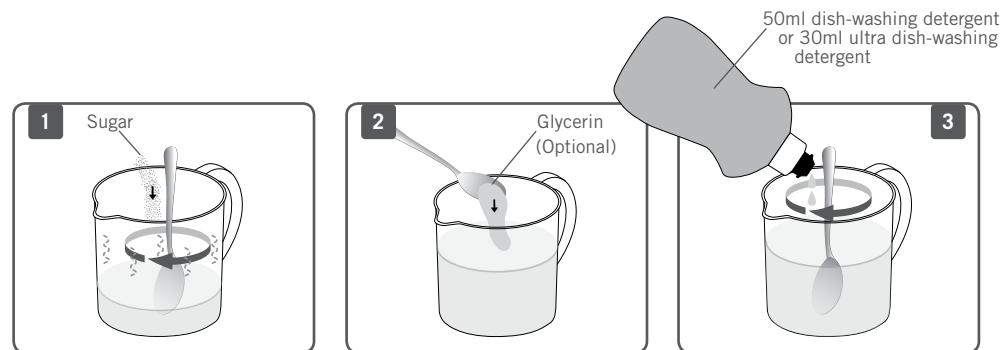

MIXTURE 2

Materials required: standard or ultra dish-washing detergent, baking powder and a container for mixing.

Put 500ml water into a container. Add 50 ml of (1.5 fl.oz) standard dish-washing detergent or 30 ml (1 fl.oz) of ultra dish-washing detergent to the container. Stir in a tablespoon of baking powder.

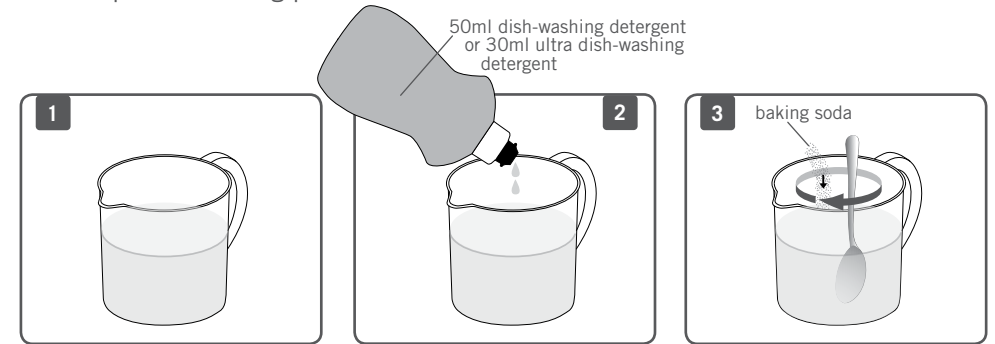

If you keep this home-made bubble solution undisturbed for 24 hours, you will find it performs better.

What is a bubble?

A bubble is film (a thin layer) of soapy water that contains air. The skin is stretchy, which is why you can blow up a bubble. As you blow, the skin stretches. It's similar to how the skin of a balloon stretches as you blow it up.

Why are bubbles coloured?

You can often see bands and swirls of colour in a bubble. They happen because light rays bounce off the outside and inside walls of the bubble. The rays combine or cancel each other out to make rays of different colours. Scientists call this effect interference. The colours change as the bubble's skin gets thinner.

D. BASIC BUBBLE FUN

Materials required from the kit: bubble tray, bubble solution, star wand, round wand, clip-on wand handles.

1. Pour some bubble solution into the small cavity of the bubble tray.
2. Clip wand handles onto the round and star wands.
3. Dip a wand into the bubble solution, then lift it out and shake off any excess solution.
4. Blow through the wand to make bubbles. Blow gently to make a larger bubble, and blow a bit harder to make a stream of smaller bubbles.

Can you make a star-shaped bubble with the star-shaped wand? Why not?

Why are bubbles round?

Single bubbles are always a round shape (called a sphere). This is because the skin of a bubble always tries to shrink to the smallest surface area possible to contain the air inside it. When you blow a giant bubble, you can see that it slowly turns from a wobbly shape into a sphere. When two bubbles stick together, they keep making smallest surface area, which is why you see flat walls between the bubbles.

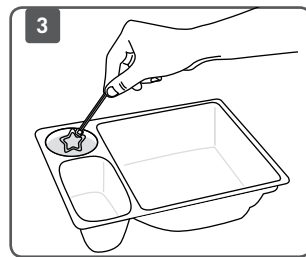
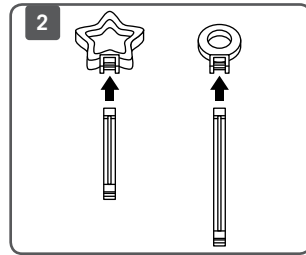
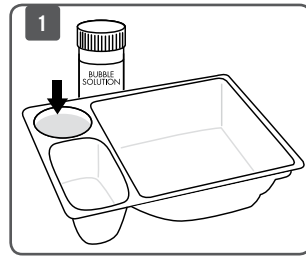

E. MAGIC PAPER WAND

Materials required from the kit: bubble tray, bubble solution, mouthpiece, and long straw.

Materials required from home: 2 x A4-sized sheets of paper (e.g. photocopier or printer paper), sticky tape, and scissors.

1. Place one paper sheet on top of the other and line up their edges.
2. Starting at one of the narrow sides of the paper, roll the paper into a narrow cone. Roll one edge of the paper very tightly and the other edge less tightly. You should end up with a cone with one pointed end and one end about 4 cm (1.6 inches) across.
3. To stop the cone unrolling, stick down the edge of the paper about halfway along the cone.
4. Carefully snip off the narrow end of the cone to leave an opening about 1.5 cm (0.6 inches) across.
5. Carefully trim the wide end of the tube to leave a neat circle. Trim away any rough edges.
6. Push the plastic mouthpiece onto the narrow end of the tube, tightly enough that the tube stays in place when you hold up the mouthpiece. That's the paper wand complete.

7. Pour some bubble solution into medium cavity of the bubble tray. Now you're ready to blow some bubbles with the neat magic paper wand!

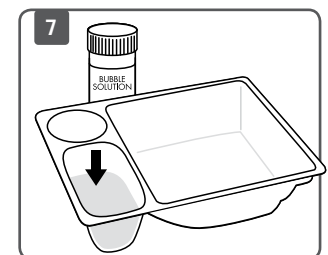
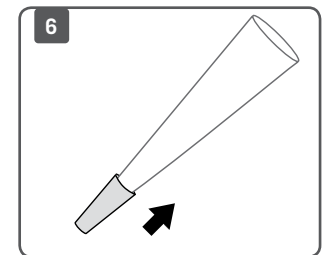
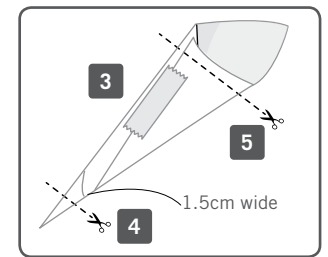
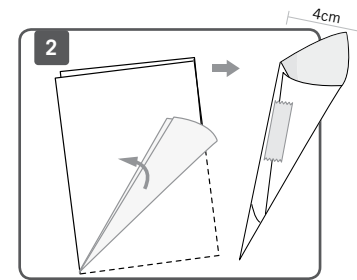
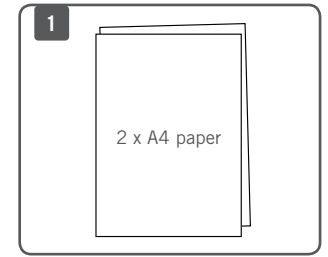

BIG BUBBLES

8. Dip the wide end of the paper wand into the bubble solution, to a depth of about 1 cm (0.4 inches), leave it there for a couple of seconds, and then lift it out.

9. Blow gently into the mouthpiece and watch a bubble grow. Keep blowing gently to make the bubble bigger.

What's the biggest bubble you can blow?

You will notice that you blow bigger bubbles with this paper wand. Why? The paper absorbs a large amount of bubble solution which allows the bubble to grow bigger than the plastic wands do.

BUBBLE CHAINS

10. Using the paper wand, blow a bubble about 10 cm (4 inches) across. Put your finger over the mouthpiece to stop the air escaping from the bubble.

11. Dip the end of the long straw into the bubble solution. Hold the end close to the bottom of the first bubble and blow gently to grow a new bubble that attaches to the first bubble and hangs below it.

12. Add more bubbles to the bottom of the chain.

How many more bubbles can you add to the chain before your bubbles burst?

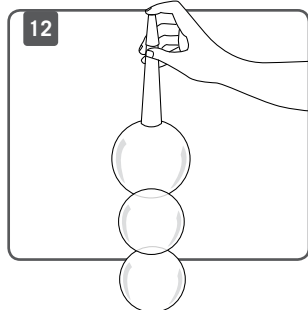
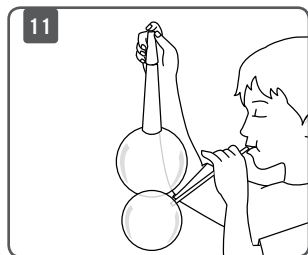
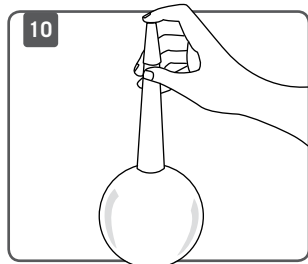
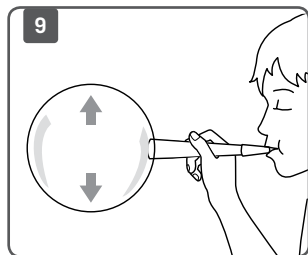
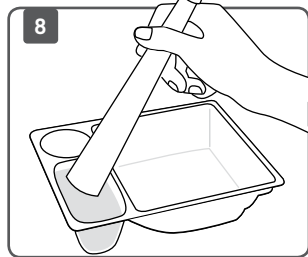

A BUNCH OF BUBBLES

13. Start as for the bubble chain above, but keep adding bubbles with the straw around the bubble from the paper wand.

How many bubbles can you add to the bunch before your bubbles burst?

BUBBLE IN A BUBBLE

14. Using the paper wand, blow a bubble about 15 cm (6 inches) across. Put your finger over the mouthpiece to stop the air escaping from the bubble.

15. Dip the end of the long straw into the bubble solution. Slowly push the end of the straw through the skin of the bubble. Blow gently into the straw to make a new bubble inside the first bubble!

Remarks: Eventually your paper wand may become saturated and the paper may begin to fall apart. If this happens, simply make a new wand from two sheets of fresh paper.

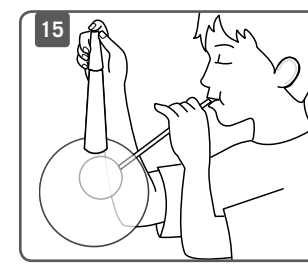
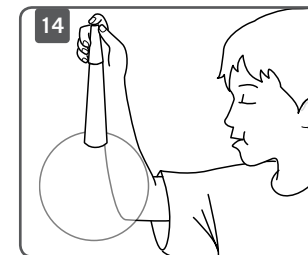
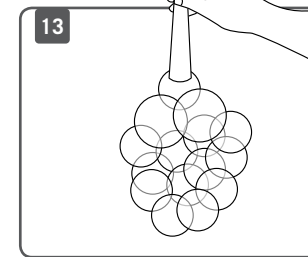

What is the skin stretchy?

The stretchiness of water is caused by an effect called surface tension. It happens because the tiny particles (called molecules) that water is made from cling to each other. They pull the molecules at the surface of water inwards, making the surface like a skin.

F. BUBBLE FILM

Materials required from kit: bubble tray, 1 x long straw, 50 cm (20 inches) of yarn. (Cut it from the yarn supplied. Leave the rest for the next activity.)

Materials required from home: home made bubble solution.

1. First you need to make a frame. Cut the long straw into two equal halves.

2. Thread one end of the yarn through the straw. Feed the yarn through the other straw in the same way.

3. You should now have the two straws on the yarn. Tie the two ends of the yarn together with an overhand knot. Cut off any spare ends of yarn.

MAKING A FILM IN THE FRAME

4. Pour bubble solution into the large cavity of the bubble tray.

5. Hold the frame by the straws (one in each hand) and dip it into the bubble solution, make sure that the yarn gets soaked with solution. Gently and slowly lift the frame from the solution and pull the straws apart to straighten the yarn and make a rectangle shape. There should be a film of bubble solution in the frame.

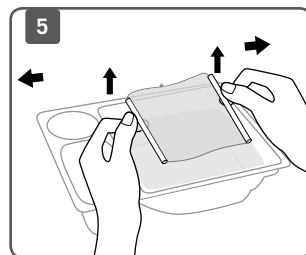
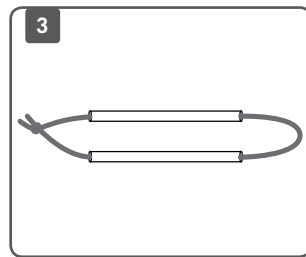
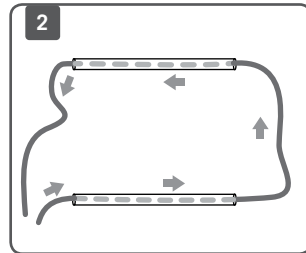
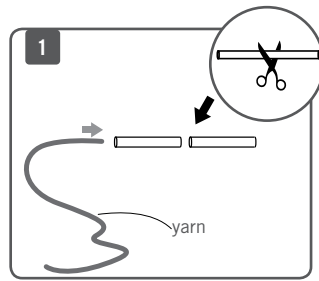

MAKING A BIG BUBBLE

6. Make a bubble film as in step 5 above, then slowly pull the frame through the air. The film should stretch and form a big bubble. When the bubble has grown, pull the frame quickly to release it into the air.

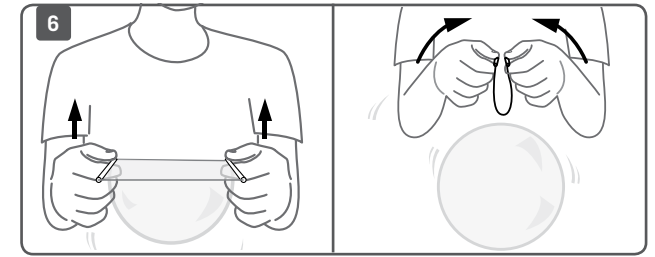

MAKING SMALL BUBBLES

7. Make a bubble film as in step 5 above, then blow gently on the centre of the film. You should get a stream of small bubbles without the film breaking.

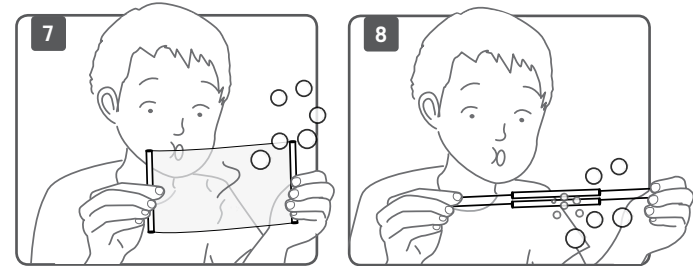

8. You can also make small bubbles by holding the straws a few millimetres apart, dipping them into the bubble solution and blowing gently between them.

BOUNCING BUBBLES

9. You will need a helper for this step. Make a bubble film as in step 5 above. Ask your helper to dip the round wand into the bubble solution, and then gently blow into wand to make a small bubble in the air.

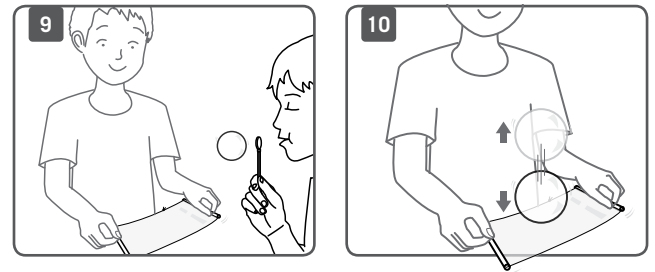

10. Hold the bubble frame under the small bubble. Move the frame upwards as the bubble floats down towards it. You should see the bubble bounce off the film. It's like a bubble trampoline!

G. MEGA BUBBLE

Materials required from kit: bubble tray, 2 x giant bubble wand sticks, 2 x giant bubble wand stoppers, 200 cm (78 inches) of yarn, 1 x plastic ring.

Materials required from home: home made bubble solution.

1. First you need to make a large bubble wand. Start by threading the yarn through the ring and tie the ends together with an overhand knot.

2. Thread a loop of yarn down through the eye in one of the bubble wand stoppers. Bring the loop over the top of the stopper and pull the yarn tight so that it becomes attached to the eye.

3. Attach the other stopper to the yarn in the same way, leaving about 50 cm (20 inches) of yarn between the two stoppers.

4. Push the two bubble wand sticks into the stoppers.

5. Pour bubble solution into large cavity of the bubble tray. Lower the giant bubble wand into the bubble solution, making sure all the yarn gets soaked in solution.

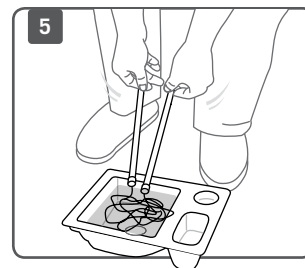
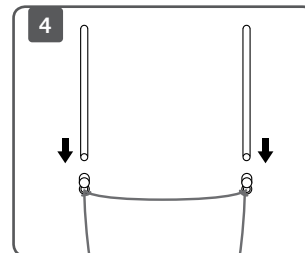
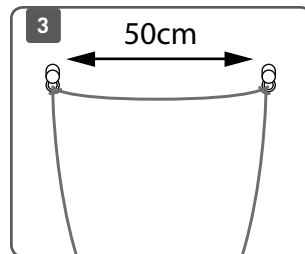
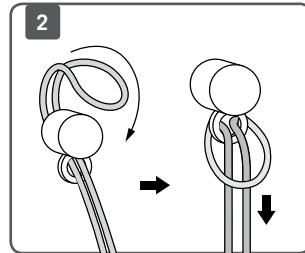
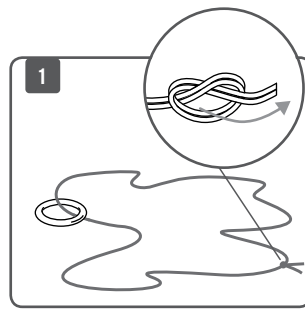

6. Lift the wand out of the solution and move the sticks apart. You should get a triangle of yarn with a film of bubble solution inside it. Hold the two sticks, one in each hand, with the yarn between them taut and horizontal. The ring should pull the lower part of the yarn down, so that the yarn forms a triangle. Make sure the yarn is not twisted anywhere.

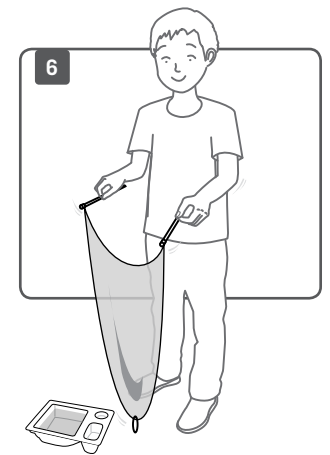

7. Pull the giant bubble wand through the air by slowly walking backwards. The wand should leave a monster bubble behind it. Pull the wand quickly to detach the bubble from the wand.

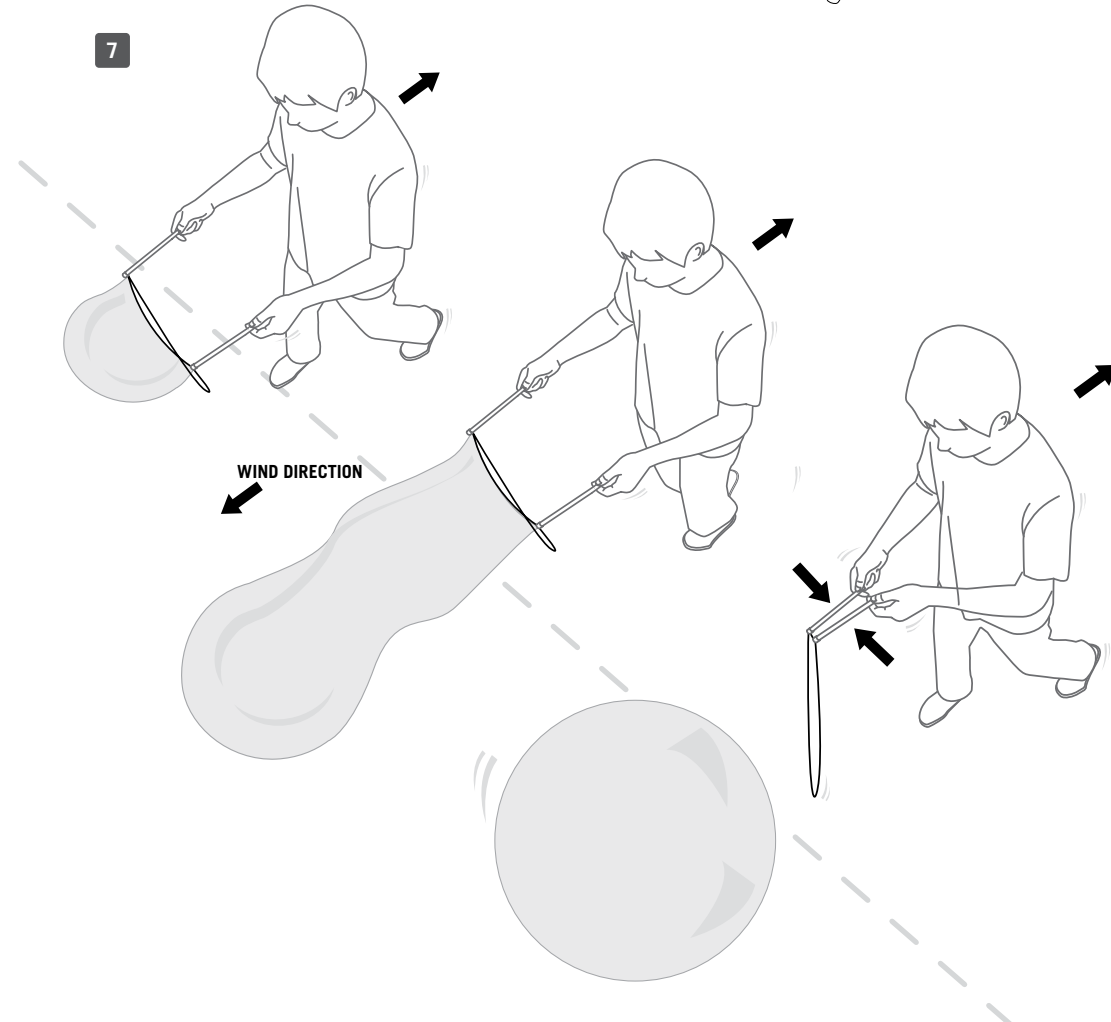

H. BUBBLE GEOMETRY

Materials required from kit: bubble tray, cube framed wand, pyramid framed wand, long straw.

Materials required from home: home made bubble solution.

1. Pour bubble solution into the large cavity of the bubble tray.

2. Holding the cube by its edges and place it into the solution so that one face is submerged in solution. Roll the cube onto another face. The first face should now have a film of solution over it.

3. Keep rolling until each face has a film of solution. Lift the cube out of the solution. What happens to the films of solution? Amazingly, you should see films of solution leading into the centre of the cube, where there will be a small film.

4. Dip the end of the straw into the solution. Push the end into the film at the centre of the cube and blow gently. With luck, you'll make a cube-shaped bubble at the centre of the cube!

5. Repeat the activity with the pyramid. This time try to make a pyramid-shaped bubble in the centre of the shape.

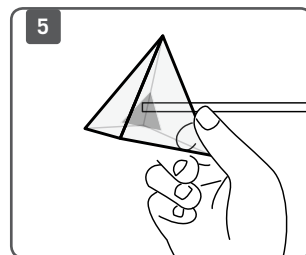
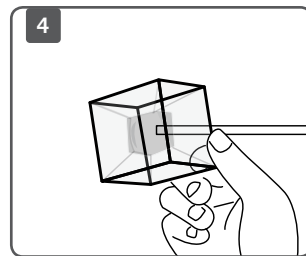
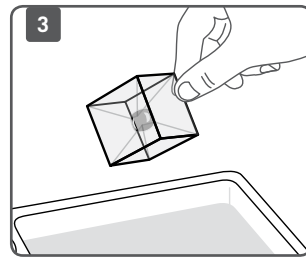
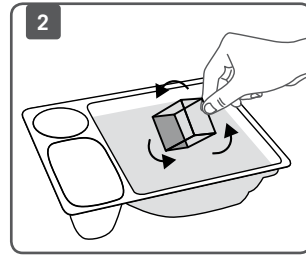
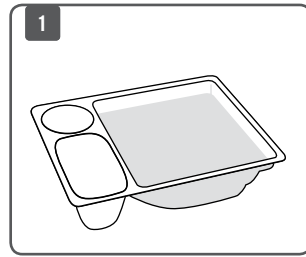

Why do bubbles burst?

Sadly, bubbles don't last forever! They burst because the water they are made from slowly evaporates. The water turns to water vapour and mixes with the air. As the water evaporates, the skin gets thinner and thinner, until it breaks. In dry, warm weather, evaporation is quicker, so bubbles don't last long.

I. UNBREAKABLE BUBBLE

Materials required from kit: bubble tray, bubble solution, long straw, round wand, star wand, wand handle.

Materials required from home: an empty jar with a lid (or a glass and a plate).

1. Clip the round wand onto one end of the longer of the two wand handles, then clip the star wand onto the other end. This will be the stand for your bubble.

2. Pour a little bubble solution into the jar, put the lid on, and then shake the jar. This will coat the inside of the jar with bubble solution.

3. Wet both ends of the stand, then place it in the jar, with the star at the bottom, so that the circle wand is not touching the sides of the jar.

4. Dip the end of the long straw into bubble solution and carefully blow a bubble onto the round wand. The bubble should be about 5 cm (2 inches) across and not touching the sides of the jar.

5. Put the lid on the jar quickly.

Check your bubble every few minutes. How long did it last? It might last for more than an hour. Why? Because the air inside the jar is moist, which means the bubble does not evaporate and burst.

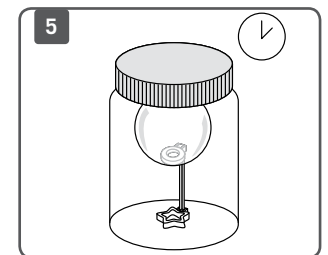
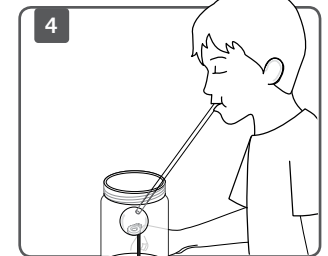
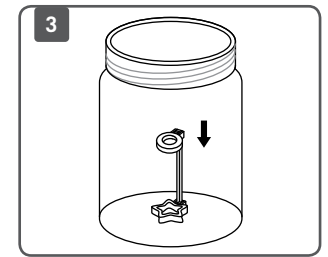
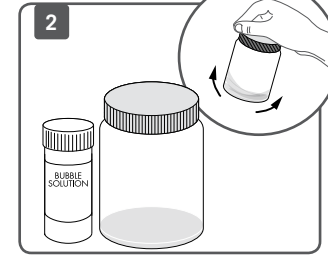
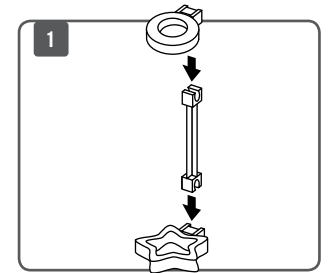

J. BUBBLE SCULPTURE

Materials required from kit: bubble tray, bubble solution, long straw.

1. Pour bubble solution into the bubble tray until the bottom of the tray is covered with solution.

2. Dip the end of the long straw just into the solution and blow gently. You should be able to blow a dome-shaped bubble about 10 cm (4 inches) across. Keep the straw off the bottom of the tray, or you will blow lots of small bubbles.

3. Now add some other bubbles around the first one to make a bubble sculpture.

Can you make a bubble bug (one large bubble for the body and one small one for the head)? What about a flower (one central bubble and six petals around it)?

4. Try blowing a bubble in a bubble. Start with a large dome about 10 cm (4 inches) across. Carefully push the straw through it and blow another dome inside it. Are your bubble-blowing skills good enough to add a third dome inside the second?

You can use a dry finger to burst any bubble you no longer want.

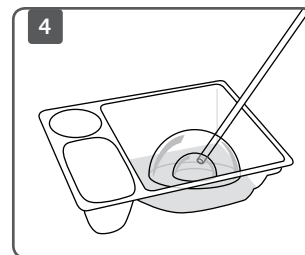
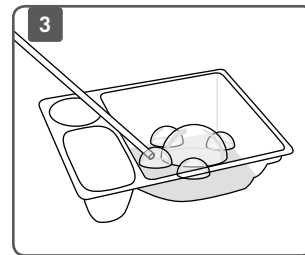
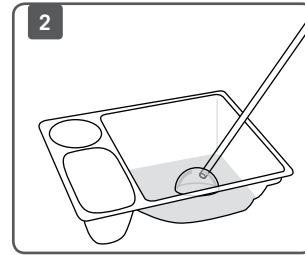
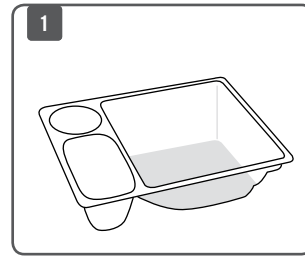

K. BUBBLE ART

Materials required from kit: long straw, bubble solution.

Materials required from home: food coloring, small plastic pots, old spoon, and clean white paper.

1. Pour bubble solution into a small plastic pot until the solution is about 1 cm deep.

2. Add two tablespoons of food coloring (choose your favourite colour) to the bubble solution and mix it in.

3. Push the long straw into the mixture and blow quickly until bubbles rise out of the pot.

4. Carefully lower a sheet of paper onto the bubbles. Be careful not to let the paper touch the pot. Lift the paper off again.

5. You should be left with a beautiful bubble print on the paper. Let it dry.

By using different colours of bubbly paint in separate pots, you can put one set of bubble prints over another to make amazing patterns.

Try making greetings cards, party invitation and thank you notes with bubble art. To make a card, fold a piece of white card in half, then make bubble prints on the front.

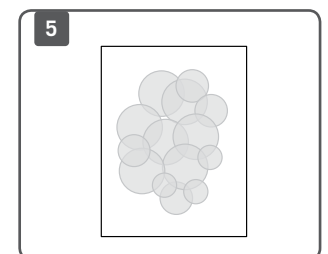
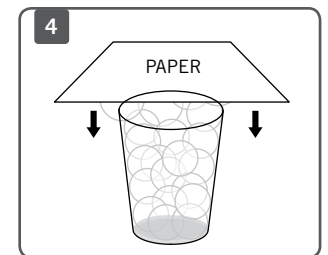
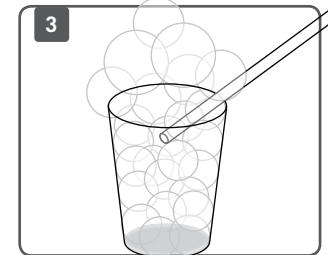
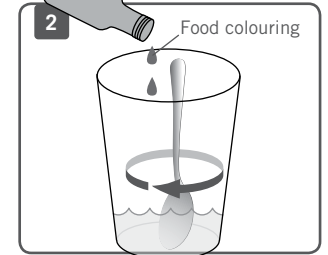
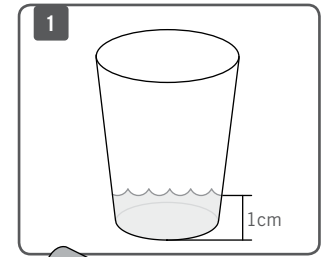

L. TROUBLESHOOTING

If your bubbles burst quickly, or you are having problems making a film of bubble solution in the various wands in the kit:

- Clean your wands thoroughly with soap water.
- The problem may be the weather. When it is very dry, the water in a bubble will evaporate very quickly, making the bubble burst. Wait until the weather is wetter, with drizzly rain or fog.
- Bubble making will also be tricky on windy days. Try blowing your bubbles at somewhere sheltered from the wind e.g. a semi covered playground.
- If you are using your own bubble solution, check that you have made it according to the instructions.

M. FUN FACTS

- The skin of a bubble is less than a thousandth of a millimetre thick. That means you would need to put the skins of a thousand bubbles together to make a layer a millimetre thick.
- You can tell when a bubble is about to burst because the colours of its skin disappear. That means its skin has got extremely thin and it's about the break.
- The world record longest-lasting bubble didn't burst for 341 days — nearly a year!
- The world's biggest bubble was blown in 2005. Its volume was 3 cubic metres. It could have contained 3 tonnes of water!
- The walls of joined-up bubbles always meet at an angle of 120°.

QUESTIONS & COMMENTS

We treasure you as a customer and your satisfaction with this product is important to us. In case you have any comments or questions, or you find any parts of this kit missing or defective, please do not hesitate to contact our distributor in your country, whose address is printed on the package. You are also welcome to contact our marketing support team at Email: infodesk@4M-IND.com, Fax (852) 25911566, Tel (852) 28936241, Web site: WWW.4M-IND.COM