

FEEDBACK DESTROYER[®] PRO DSP1124P

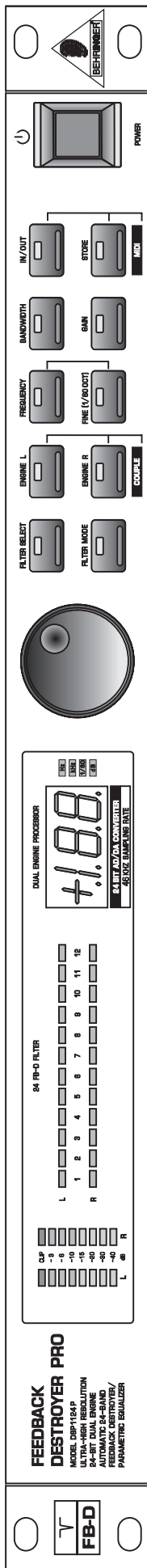

User's Manual

Version 1.0 February 2001

ENGLISH



www.behringer.com

SAFETY INSTRUCTIONS

CAUTION: To reduce the risk of electrical shock, do not remove the cover (or back). No user serviceable parts inside; refer servicing to qualified personnel.



WARNING: To reduce the risk of fire or electrical shock, do not expose this appliance to rain or moisture.



This symbol, wherever it appears, alerts you to the presence of uninsulated dangerous voltage inside the enclosure - voltage that may be sufficient to constitute a risk of shock.



This symbol, wherever it appears, alerts you to important operating and maintenance instructions in the accompanying literature. Read the manual.

DETAILED SAFETY INSTRUCTIONS:

All the safety and operation instructions should be read before the appliance is operated.

Retain Instructions:

The safety and operating instructions should be retained for future reference.

Heed Warnings:

All warnings on the appliance and in the operating instructions should be adhered to.

Follow instructions:

All operation and user instructions should be followed.

Water and Moisture:

The appliance should not be used near water (e.g. near a bathtub, washbowl, kitchen sink, laundry tub, in a wet basement, or near a swimming pool etc.).

Ventilation:

The appliance should be situated so that its location or position does not interfere with its proper ventilation. For example, the appliance should not be situated on a bed, sofa rug, or similar surface that may block the ventilation openings, or placed in a built-in installation, such as a bookcase or cabinet that may impede the flow of air through the ventilation openings.

Heat:

The appliance should be situated away from heat sources such as radiators, heat registers, stoves, or other appliance (including amplifiers) that produce heat.

Power Source:

The appliance should be connected to a power supply only of the type described in the operating instructions or as marked on the appliance.

Grounding or Polarization:

Precautions should be taken so that the grounding or polarization means of an appliance is not defeated.

Power-Cord Protection:

Power supply cords should be routed so that they are not likely to be walked on or pinched by items placed upon or against them, paying particular attention to cords and plugs, convenience receptacles and the point where they exit from the appliance.

Cleaning:

The appliance should be cleaned only as recommended by the manufacturer.

Non-use Periods:

The power cord of the appliance should be unplugged from the outlet when left unused for a long period of time.

Object and Liquid Entry:

Care should be taken so that objects do not fall and liquids are not spilled into the enclosure through openings.

Damage Requiring Service:

The appliance should be serviced by qualified service personnel when:

- The power supply cord or the plug has been damaged; or
- Objects have fallen, or liquid has been spilled into the appliance; or
- The appliance has been exposed to rain; or
- The appliance does not appear to operate normally or exhibits a marked change in performance; or
- The appliance has been dropped, or the enclosure damaged.

Servicing:

The user should not attempt to service the appliance beyond that is described in the Operating Instructions. All other servicing should be referred to qualified service personnel.

FOREWORD

Dear Customer,

Welcome to the team of FEEDBACK DESTROYER PRO users and thank you very much for expressing your confidence in BEHRINGER products by purchasing the DSP1124P. It is one of my most pleasant tasks to write this letter to you, because it is the culmination of many months of hard work delivered by our engineering team to reach a very ambitious goal: making an outstanding and extremely flexible device for studios and P.A. rental companies better still.

The task to design our new FEEDBACK DESTROYER PRO certainly meant a great deal of responsibility, which we assumed by focusing on you, the discerning user and musician. It also meant a lot of work and night shifts to accomplish this goal. But it was fun, too. Developing a product usually brings a lot of people together, and what a great feeling it is when everybody who participated in such a project can be proud of what we've achieved.

It is our philosophy to share our joy with you, because you are the most important member of the BEHRINGER family. With your highly competent suggestions for new products you've greatly contributed to shaping our company and making it successful. In return, we guarantee you uncompromising quality (manufactured under ISO9000 certified management system) as well as excellent technical and audio properties at an extremely favorable price. All of this will enable you to fully unfold your creativity without being hampered by budget constraints.

We are often asked how we can make it to produce such high-grade devices at such unbelievably low prices. The answer is quite simple: it's you, our customers! Many satisfied customers means large sales volumes enabling us to get better conditions of purchase for components, etc. Isn't it only fair to pass this benefit back to you? Because we know that your success is our success, too!

I would like to thank all people whose help on "Project FEEDBACK DESTROYER PRO" has made it all possible. Everybody has made very personal contributions, starting from the designers of the unit via the many staff members in our company to you, the user of BEHRINGER products.

My friends, it's been worth the trouble!

Thank you very much,

A handwritten signature in black ink, appearing to read 'U. Behringer', with a long horizontal flourish extending to the right.

Uli Behringer

FEEDBACK DESTROYER® PRO

24-Bit Dual Engine Digital Feedback Destroyer / Parametric EQ Model DSP1124P

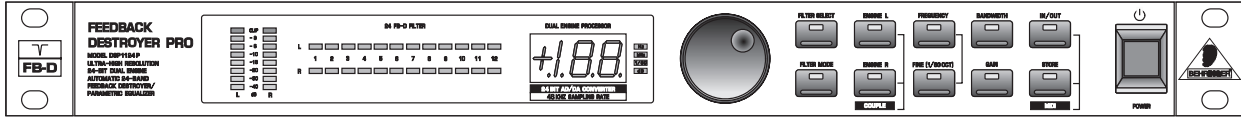

- ▲ Ultra-high performance 2-channel digital Feedback Destroyer / parametric EQ powered by a 24-bit high-speed DSP
- ▲ 24-bit A/D and D/A converters with 64/128 times oversampling for ultra-high headroom and resolution
- ▲ Automatically and “intelligently” searches out and destroys up to 12 frequencies per channel
- ▲ 24 fully programmable parametric filters that can be set manually or via MIDI
- ▲ “Set-and-forget” default setting enables immediate and super-easy Feedback Destroyer performance
- ▲ Single-Shot mode automatically searches and destroys feedback and locks the filter until you reset it manually
- ▲ Auto mode continuously monitors the mix, resetting programmed filters automatically
- ▲ Manual mode allows for setting up to 2 x 12 fully parametric filters including frequency, bandwidth and gain
- ▲ Single-Shot, Auto and Manual modes are assignable for each filter
- ▲ Free FEEDBACK DESTROYER design software allows for total remote control via PC (download at www.behringer.com)
- ▲ Two digital processing engines give you independent or coupled functions on left and right channels
- ▲ Servo-balanced inputs and outputs on gold plated XLR and 1/4" TRS connectors for high signal integrity
- ▲ Internal 24-bit processing with professional 46 kHz sampling rate
- ▲ Full MIDI capability and user preset memories to store programs for instant recall
- ▲ Accurate eight-segment LED level meters simplify level setting for optimum performance
- ▲ “Future-proof” software-upgradeable architecture
- ▲ High-quality components and exceptionally rugged construction ensure long life and durability
- ▲ Internal power supply design for professional application
- ▲ Manufactured under ISO9000 certified management system

TABLE OF CONTENTS

1. INTRODUCTION	6
1.1 The design concept	6
1.2 Before you begin	6
1.3 Background: How is feedback produced?	7
1.3.1 Background: front of house mix (FOH)	7
1.3.2 Background: monitor mix	7
2. APPLICATIONS	8
2.1 Level setting	8
2.2 Using the FEEDBACK DESTROYER PRO in the monitor path	8
2.3 Using the FEEDBACK DESTROYER PRO in the FOH mix	9
2.4 Using the FEEDBACK DESTROYER PRO in a studio environment	10
3. A FEW QUICK STEPS TO ELIMINATE FEEDBACK	10
4. CONTROL ELEMENTS	10
5. DSP1124P ARCHITECTURE: PRESETS, FILTERS, OPERATING MODES	13
5.1 “Priming” the DSP1124P for P.A. and monitor applications	13
6. OPERATING MODES OF THE DSP1124P	14
6.1 Off mode “OF”	14
6.2 Manual filters (“PA”) / parametric equalizer	14
6.3 Automatic filters (“SI” and “AU”)	14
6.4 Locked mode (“LO”)	15
7. WORKING WITH PRESETS	15
7.1 Recalling Presets	15
7.2 Selecting the filter operating mode	15
7.3 Editing filter parameters	16
7.4 Storing presets	16
7.5 Restoring the factory presets	16
8. PROBLEMS DO HAVE A CAUSE	17
9. MIDI CONTROL	17
10.INSTALLATION	18
10.1 Audio connections	18
10.2 MIDI connections	20
11.APPENDIX	20
11.1 Frequency chart	20
11.2 Preset table	21
11.3 MIDI implementation	22
12.SPECIFICATIONS	23
13.WARRANTY	24

1. INTRODUCTION

Thank you very much for expressing your confidence in BEHRINGER products by purchasing the FEEDBACK DESTROYER PRO DSP1124P. With the FEEDBACK DESTROYER PRO you have acquired a highly useful device for the control of sound reinforcement systems, which will enable you to focus your attention on what is essential: your music. The fully featured DSP1124P not only suppresses feedback but also incorporates a wealth of additional functions in one single unit. Its 24 separate filters can be edited in all parameters, and automatically detect and suppress feedback frequencies. With its pro-level internal processing circuitry, the unit can also be used as a high-end equalizer for stage and studio applications. The MIDI interface allows for integrating the DSP1124P into any MIDI system, and the open system architecture enables you to update the system software whenever you want. In short: the DSP1124P will be your reliable “workhorse” over many years to come.

 **This manual first describes the terminology used, so that you can fully understand the FEEDBACK DESTROYER PRO and its functions. Please read the manual carefully and keep it for future reference.**

1.1 The design concept

The philosophy behind BEHRINGER products guarantees a no-compromise circuit design and employs the best choice of components. A 24-bit DSP is used as the heart of the FEEDBACK DESTROYER PRO, which belongs to the best components available owing to its outstanding specifications and excellent sonic characteristics. What is more, high-quality 24-bit A/D and D/A converters ensure the accurate processing of all signals. Additionally, the FEEDBACK DESTROYER uses high-quality resistors and capacitors with very tight tolerances, high-grade switches, and further selected components.

The FEEDBACK DESTROYER PRO employs SMD technology (Surface Mounted Device). These subminiature components known from aerospace technology allow for an extreme packing density and improve the unit's reliability even further. Additionally, the DSP1124P was manufactured in compliance with an ISO9000 certified management system.

1.2 Before you begin

Your FEEDBACK DESTROYER PRO was carefully packed in the factory and the packaging was designed to protect the unit from rough handling. Nevertheless, we recommend that you carefully examine the packaging and its contents for any signs of physical damage, which may have occurred in transit.

 **If the unit is damaged, please do not return it to us, but notify your dealer and the shipping company immediately, otherwise claims for damage or replacement may not be granted. Shipping claims must be made by the consignee.**

The BEHRINGER FEEDBACK DESTROYER PRO requires one standard 19" unit of rack space. Please allow at least an additional 4" depth for the connectors on the back panel.

Be sure that there is enough space around the unit for cooling and please do not place the FEEDBACK DESTROYER PRO on high-temperature devices such as power amplifiers, etc. to avoid overheating.

 **Before you connect your FEEDBACK DESTROYER PRO to the mains, please make sure that your local voltage matches the voltage required by the unit:**

The fuse holder on the female mains connector has 3 triangular markings, with two of these triangles opposing each other. The FEEDBACK DESTROYER PRO is set to the operating voltage printed next to these markers and can be set to another voltage by turning the fuse holder by 180°. **CAUTION: This instruction does not apply to export models exclusively designed, e.g. for 115-V operation!**

Please use the enclosed power cord to connect the unit to the mains. The cord complies with all applicable safety standards.

⚠ Please note that all units must be grounded properly. For your own safety, you should never remove any ground connectors from electrical devices or power cords or render them inoperative.

As a standard, the BEHRINGER FEEDBACK DESTROYER PRO is equipped with electronically servo-balanced inputs and outputs. The circuit design features automatic hum and noise reduction for balanced signals and thus allows for trouble-free operation, even at high operating levels. Externally induced mains hum, etc. will be effectively suppressed. The automatic servo-function recognizes the presence of unbalanced connectors and adjusts the nominal level internally to avoid level differences between the input and output signals (6-dB correction).

The MIDI interfaces IN, OUT, and THRU are on standardized DIN connectors. Data are transmitted via potential-free opto couplers.

1.3 Background: How is feedback produced?

A feedback loop is produced when a microphone signal is reproduced by an amplification system and is subsequently picked up again (with identical phase) by the microphone. If this happens repeatedly, such a feedback loop can become ever more persistent.

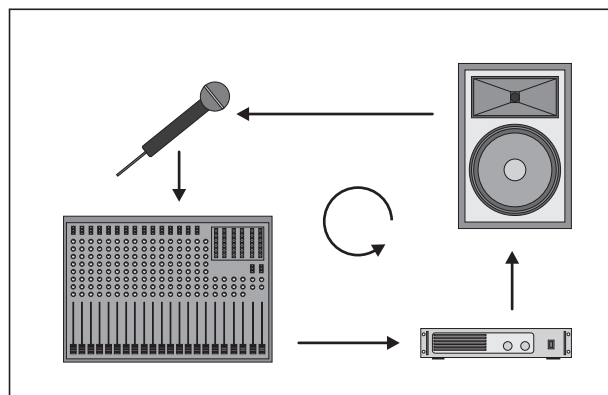

Fig. 1.1: How a feedback loop is produced

1.3.1 Background: front of house mix (FOH)

There are two main sections in any sound reinforcement system, which are liable to produce feedback: the first section is the so-called front of house mix (FOH), i.e. the “public address” mix, which is reproduced by one or several amplifiers plus several loudspeakers directed at the audience.

1.3.2 Background: monitor mix

The monitor mix, which is often derived from the same console, feeds one or several stage-mount monitor speakers. Unlike FOH systems, stage monitors are used to provide the individual musicians with a monitor signal, because it is often difficult to hear oneself or each other on the stage, which can be due to the high volume levels produced by the FOH systems, or to different volume levels of the stage-mount instruments and amplifiers. It is therefore not unusual to give each musician his or her own monitor speaker, which is why there are usually several monitor speakers placed along the stage. This is the only way to provide each musician with a directed and focused monitor signal. In an ideal situation, each monitor provides a specific mix, comprising e.g. vocals, drums and keyboards, for each individual musician on the stage.



Unfortunately, it is anything but easy to find perfect positions for the various stage monitors, because the distance between speaker and microphone must be kept very short, which in turn increases the risk of feedback.

⚠ In contrast to FOH systems, it is common practice to create two or even more dedicated monitor mixes, which also involves the use of several monitor speakers. Again, this can lead to increased feedback.

2. APPLICATIONS

The DSP1124P is used **exclusively to eliminate feedback in FOH and monitor mixes**.

Before you go on, please note the following two remarks:



-  **The FEEDBACK DESTROYER PRO is not intended to be connected directly to the microphones! If this is unavoidable, then we recommend our proven BEHRINGER SHARK DSP110 instead, which is equipped with a dedicated microphone preamplifier.**
-  **No processing device can undo the mistakes made when placing the microphones! So, when you set up your mics, use them according to their directivity and feedback susceptibility (see chapter 8 “PROBLEMS DO HAVE A CAUSE ...”).**

2.1 Level setting

Take care to set levels properly on the DSP1124P, so as to successfully employ the FEEDBACK DESTROYER PRO to remove feedback. Use the LED LEVEL METER . Make sure that the top Clip LEDs flicker only rarely, but never light up all the time.

Low levels deteriorate the dynamics of the music signal, which results in a poor, weak and noisy sound. On the other hand, excess levels overdriving the converters in the FEEDBACK DESTROYER PRO should also be avoided. Digital distortion is (unlike its analog counterpart) very unpleasant to hear as it does not occur gradually but abruptly.

2.2 Using the FEEDBACK DESTROYER PRO in the monitor path



Your DSP1124P is equipped with two channels. In *Couple* mode (see control elements  and ), these two channels are linked. But you can also use them separately, for example, to protect two dedicated monitor paths against feedback.

Monitor mixes are realized either via the pre-fader Aux Sends on an FOH console, or via a (usually stage-mount) monitor mixer. When using an additional monitor mixer on the stage, you need a so-called splitter to route the single microphone signals both to the FOH console and to the monitor mixer. When using the FOH console for the monitor mix, the stage microphones are connected directly to the console (if necessary, via a so-called stage box).

In both cases, separate monitor mixes are created for the musicians, which can then be provided from the console outputs (usually via the Aux Send outputs). Owing to its 2-channel design, your FEEDBACK DESTROYER PRO allows you to protect two monitor paths against feedback. To do so, connect the pre-fader Aux Send outputs on your console to the inputs of the DSP1124 (as shown in fig. 2.1). Then, connect the inputs of the monitor power amps to the outputs of the FEEDBACK DESTROYER PRO (see fig. 2.1).

As already mentioned, monitor paths are particularly susceptible to feedback. When vocal microphones are not installed in a fixed position, things become even worse, so it really makes sense to protect the monitor paths against feedback. Another positive side effect of using the DSP1124P in the monitor path is the fact that you can raise the volume levels considerably.

As you can see, your DSP1124P is a perfect tool to protect two independent monitor paths. But why is that so important? Because “monitoring” is a complex task. Usually, each monitor path is used for an independent mix comprising a variety of signal sources. This is the only way to ensure that each performer on the stage can hear exactly what he or she wants.

-  **Owing to its 2-channel design, the DSP1124P is the perfect tool for application in two separate monitor paths. However, if you need to protect four monitors against feedback, we recommend that you use a second DSP1124P.**
-  **If possible, all monitor paths should be set pre-fader, as this leaves the monitor mix unaffected from any changes made to the FOH mix.**

FEEDBACK DESTROYER PRO DSP1124P

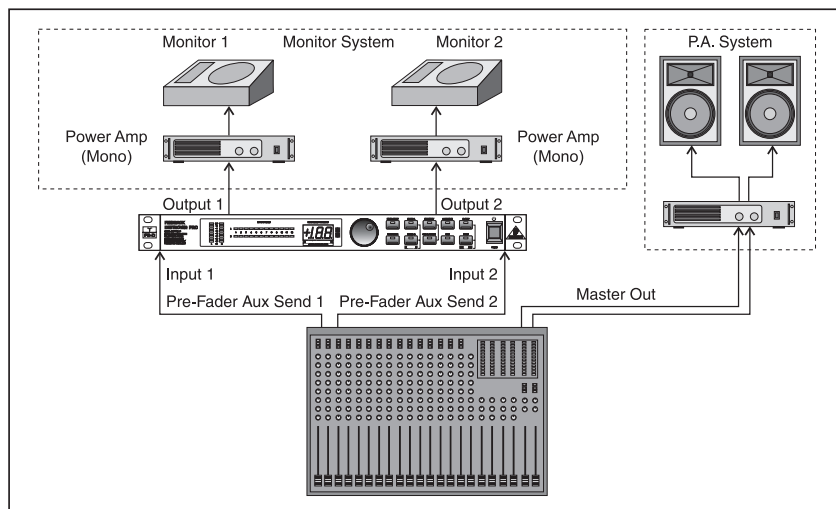

Fig. 2.1: Using the DSP1124P in the monitor sends

2.3 Using the FEEDBACK DESTROYER PRO in the FOH mix

Since you want to make sure that deliberately produced feedback signals, such as “guitar feedback”, are not eliminated, you should try inserting the DSP1124P into those channels that are susceptible to feedback. For example, you could process a vocal microphone that is liable to produce feedback by connecting the DSP1124P to the insert points of the respective channel.

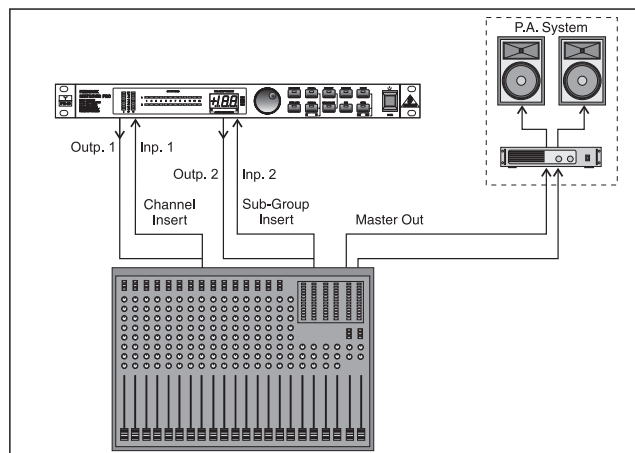



Fig. 2.2: Using the DSP1124P for specific mics (connecting the FEEDBACK DESTROYER PRO in either channel or sub-group inserts)

 **When processing a microphone signal with the DSP1124P and a compressor inserted into the same channel insert point, the FEEDBACK DESTROYER PRO should always be used pre-compressor: in this way, the signal is taken at the insert jack, passes the DSP1124P, then the compressor, and is finally routed back to the insert jack.**

Ideally, your mixer has sub-groups with dedicated insert points to connect the DSP1124P! Route all channels that are susceptible to feedback (e.g. all vocal mics) to one sub-group. While the other signals (e.g. line level signals, low-level instrumental mics) pass unaffected, all critical microphone channels are monitored by the DSP1124P.

If your mixer has no sub-group inserts, we recommend that you connect the DSP1124P as follows: connect the sub-group output to one input on the DSP1124P, and the corresponding output to a free line input of a mixing console channel or one of the Aux Return inputs on the console. As long as ENGINE L and ENGINE R are not linked, you would even have the second channel of your FEEDBACK DESTROYER PRO free for other applications (e.g. channel inserts).

2.4 Using the FEEDBACK DESTROYER PRO in a studio environment

With its highly flexible configuration the DSP1124P also delivers good results in a professional studio or home recording environment, as it provides a maximum of 12 fully parametric equalizers per channel in **Parametric EQ** mode. Thus, you can realize any application ranging from slight processing to the total manipulation of music signals. For example, you can use the DSP1124P as an equalizer for your studio monitors or to enhance the EQs in your mixing console, as these are often only semi-parametric.

3. A FEW QUICK STEPS TO ELIMINATE FEEDBACK

Irrespective of whether you need the DSP1124P to protect the FOH or the monitor mix against feedback, the following procedure is always the same and should be done before the concert, so as to eliminate basic feedback problems right before the show begins:

- ▲ Check the setting of the OPERATING LEVEL switch on the rear of the unit. For most P.A. systems, this switch should be set to **+4 dB**. In doubt, please consult the user's manual of your mixing console. Always make sure that the audio signal levels are set correctly (see control element 1).
- ▲ Switch on the unit, and use the JOG WHEEL (rotary control) to select preset 1. The preset table (see table 11.3) lists the various DSP1124P presets available.
- ▲ Using the DSP1124P in the monitor path: Turn up the Aux Send or Mon. controls in the first mic channel, until the microphone starts to produce feedback. If more than one monitor paths is being used, this procedure must be done separately for each path. Repeat for each susceptible mic channel.
- ▲ Using the DSP1124P on channel/sub-group inserts: Deliberately induce feedback by setting the channel/sub-group faders to 0 dB and raising the gain controls for the individual microphones in turn.

In either case, the FEEDBACK DESTROYER PRO will suppress feedback as soon as it is produced—the corresponding LED will stop flashing and stay lit. The various edit options available are described in chapter 7. But don't let us do the second step before the first:

4. CONTROL ELEMENTS

The BEHRINGER FEEDBACK DESTROYER PRO is equipped with ten parameter keys, one JOG WHEEL (rotary control) and a numeric LED DISPLAY. By means of an 8-segment LED meter, each of the two fully independent channels can be monitored. Each of the 24 filters has one LED assigned to it, which informs about the status of the filter.

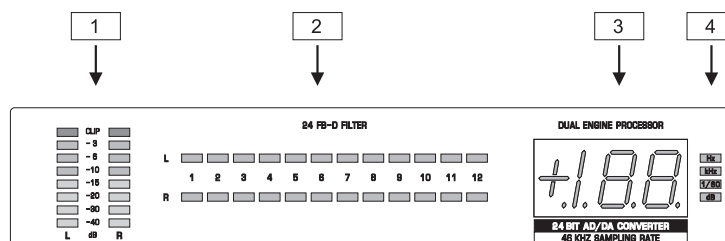

Fig. 4.1: Display section of the FEEDBACK DESTROYER PRO

- 1 The **LED METER** is used to monitor the output level. Each channel has eight LEDs assigned to it. When the Clip LED lights up frequently, this warns you of digital distortion. If the DSP1124P is set to Total Bypass mode (see 14), the level meter reads the input level.

⚠ Please always use appropriate level settings, as this is essential for successful feedback elimination.

- 2 The DSP1124P features 24 filters, i.e. 12 filters per channel. These filters can be monitored conveniently with the *STATUS INDICATOR* next to the DISPLAY. 12 LEDs inform you about the status of the filters on each channel (left/right). A constantly lit LED signals the following conditions:

▲ A filter has been “set”, i.e. it is already suppressing feedback; or:

▲ A filter is set to **Parametric EQ** mode (gain \neq 0 dB).

Cyclically flashing LEDs signal that a filter is searching feedback frequencies in **Single-Shot** or **Auto** mode (see chapters 5 and 6.3). Inactive filters (“OF”) and filters in **Parametric EQ** mode (see 6.2), with a gain setting of 0 dB, are indicated by unlit LEDs.

- 3 The *LED DISPLAY* consists of a clearly visible, two-digit numeric display. After power-up, it reads the number of the last preset used. Additionally, the LED-DISPLAY shows the absolute values of the parameters that are being edited.
- 4 The *INDICATORS* to the right of the DISPLAY (*Hz*, *kHz*, *1/60* and *dB*) light up when you edit the associated parameters in Edit mode. For example, when you raise the level of a filter, the “dB” indicator lights up.

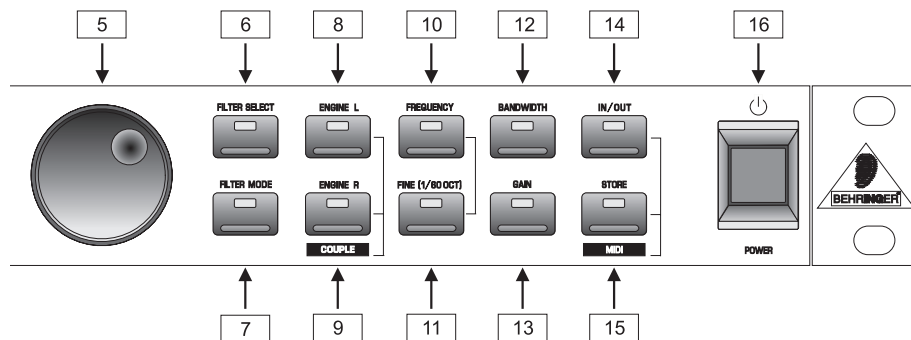

Fig. 4.2: Function keys and JOG WHEEL



- 5 With the *JOG WHEEL*, a continuous rotary control, you can freely edit the selected parameters. Turn the wheel clockwise to increase the values, or counterclockwise to reduce them.
- 6 With the *FILTER SELECT* key activated, you can use the JOG WHEEL to select one of the 12 filters per channel. Subsequently, you can edit the filters.
- 7 The *FILTER MODE* key gives you access to the four operating modes for the individual filters: “Off mode (OF)”, “Parametric EQ (PA)”, “Single-Shot mode (SI)” and “Auto mode (AU)”. Please read chapter 6 “OPERATING MODES OF THE DSP1124P”.

Pressing the FILTER MODE and GAIN keys simultaneously allows you to adjust the sensitivity of the feedback suppression trigger circuit. The setting range is from -3 through -9 dB and can be adjusted with the JOG WHEEL. The default value is -6 dB, as this setting usually delivers the best results.

- 8 Use the *ENGINE L* key to select the left audio channel.
- 9 Use the *ENGINE R* key to select the right audio channel. If you wish to process both channels at the same time (*Couple* mode), press both ENGINE keys together. In Couple mode both ENGINE LEDs light up. Whenever you edit one of the two audio channels and then switch to Couple mode, the parameters of the active channel will be copied to the other, i.e. if you press ENGINE L before ENGINE R, left will be copied to right.

Items 10 through 13 refer to **Parametric EQ** mode only (see chapters 5 and 7.3).

- 10 Press the *FREQUENCY* key to select the frequency you wish to process. The adjustable frequency range is from 20 Hz through 20 kHz, which are split up by the DSP1124P into the 31 standard ISO values of a graphic equalizer (see chapter 11.1 in the appendix).
- 11 The *FINE* key allows you to fine tune the standard ISO frequencies (in 1/60-octave steps), within a tuning range of 1/3 octave (-9/60 to +10/60).
- 12 *BANDWIDTH* determines the filter bandwidth (Q factor) of the selected filter. This adjustable filter quality ranges from 1/60 octave to 2 octaves (120/60 octave).

- 13 The *GAIN* key sets the desired boost/cut of the selected filter in dB (+16 dB/-48 dB).
- 14 The *IN/OUT* key allows for optional bypassing of the parametric filters or all filters. By shortly pressing the *IN/OUT* key, only the **Parametric EQ** filters will be deactivated, and the green LED goes out. Hold down the key for about two seconds to deactivate all filters. This “Total Bypass” mode is indicated by the cyclic flashing of the green LED. Another short *IN/OUT* key press reactivates all filters. Additionally, the LED flashes when relevant MIDI data are being received.
-  **If the control LED of the *IN/OUT* key flashes, all functions (including all automatic filters used for feedback suppression) are disabled (“Total Bypass”). In all other modes, at least the Single-Shot and Auto filters are active (“Bypass”).**
-  **Please use the “Total Bypass” function only with caution, because the deactivation of the filters possibly unlocks suppressed feedback.**
- 15 Any modifications made to a preset can be stored with the *STORE* key, in accordance with the number shown by the *DISPLAY*. Ten presets are available on the DSP1124P. Press the *IN/OUT* and *STORE* keys simultaneously to enter MIDI Setup mode.
- 16 Use the *POWER* switch to switch the FEEDBACK DESTROYER PRO on or off.

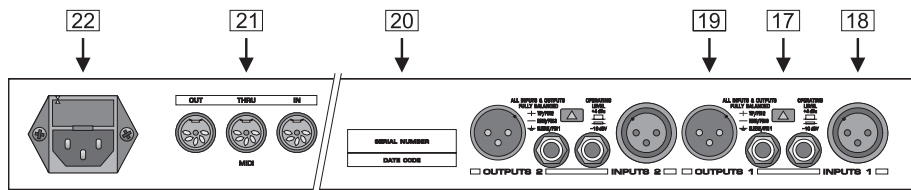

Fig. 4.3: Rear panel connectors and control elements

- 17 Use the *OPERATING LEVEL* switch to change from home recording level (-10 dBV) to studio level (+4 dBu), and vice versa. The level meters are adapted automatically to the selected nominal level, so that the FEEDBACK DESTROYER PRO will always work in its optimum operating range.
- 18 These are the balanced *INPUTS* of the DSP1124P, which are on 1/4" TRS and XLR connectors.
- 19 The two *OUTPUTS* of your FEEDBACK DESTROYER PRO are also on balanced 1/4" TRS and XLR connectors.
- 20 *SERIAL NUMBER*. Please take the time to fill in and return the warranty card within 14 days after the date of purchase, so as to benefit from our extended warranty. Or use our online registration option available on the World Wide Web at www.behringer.com.
- 21 The DSP1124P features a complete set of MIDI functions. In addition to the usual *MIDI IN* and *MIDI OUT* ports, the *MIDI THRU* allows you to loop through MIDI data.
- 22 *FUSE HOLDER / VOLTAGE SELECTOR*. Please make sure that your local voltage matches the voltage indicated on the unit, before you attempt to connect and operate the unit. Blown fuses may only be replaced by fuses of the same type and rating. Some models allow for inserting the fuse holder in two different positions, in order to switch over from 230-V to 115-V operation, and vice versa. Please note that for 115-V operation outside Europe, you need to use a fuse of a higher rating (see chapter 1.2). Use the enclosed power cord to connect the unit to the mains.

5. DSP1124P ARCHITECTURE: PRESETS, FILTERS, OPERATING MODES

In order to avoid confusion, let us give you a concise description of the DSP1124P's operating principle, so as to make the three relevant points clear right from the start. Example: You have set up your P.A. system and connected all signal sources to the console. The DSP1124P has been inserted into the monitor path (see fig. 2.1) or in single channel or sub-group inserts (see fig. 2.2); after power-up preset 1 was loaded with the JOG WHEEL. Now, you can start to purposefully produce feedback, as described in chapter 3. Depending on the room acoustics, various feedback frequencies can occur. What exactly does the DSP1124P do?

As can be seen from table 11.3, each of the ten presets on your DSP1124P comprises 24 separate filters, which can, however, be set to different operating modes: In our example, the first nine filters of the selected preset are set to **Single-Shot** mode ("SI", see chapter 6.3). This mode is designed to detect feedback frequencies at fixed resonance values, and to suppress them consistently. So, these filters cannot be unlocked (status "LO" (locked)). Their bandwidth and gain reduction can be adapted if required, however, the frequency setting remains the same. In our example, the DSP1124P is used to prevent nine fixed frequencies from "making trouble".

The three remaining filters (all set to **Auto** mode "AU", see chapter 6.3) are used to detect and suppress new feedback frequencies, which can be produced, e.g. when the singer moves around the stage with the vocal mic in his/her hand. Since the DSP1124P can by no means "know" whether or not the risk of feedback has been eliminated (e.g. when the singer moves to another position), the first AU filter of the unit locks to the detected frequency, while the remaining two AU filters are used to suppress any new trouble frequencies that may occur. Only when all AU filters have been used, will the first AU filter used (here: 10) be unlocked, so as to be able to detect new feedback frequencies.

Basically, all active filters (both in "AU" or "SI" mode) are represented by flashing LEDs in the STATUS INDICATOR . When feedback has been detected and is being suppressed, the associated filter LED lights up constantly. Filters set to **Parametric EQ** mode (see chapter 6.2) also have constantly lit LEDs.

 **Please read the detailed description of all operating modes (chapter 6)!**

5.1 "Priming" the DSP1124P for P.A. and monitor applications

With the DSP1124P you can improve the protection against feedback even before the show begins, by "tuning in" your sound reinforcement system. We already dealt with this in chapter 3. But now it's not about using a preset, but about how to determine in which modes the filters are used: Set some of the filters to **Single-Shot** mode (see .

First, let's take a look at the monitor path: Open all microphone channels, turn up the Aux Send controls on all channels you wish to route to the monitor mix, then slowly move up the monitor master faders. For the front mix do as follows: Slowly move up the channel and master faders. In both cases, the first feedback frequencies can be heard after some time.

Without the FEEDBACK DESTROYER PRO you could not increase the volume level of your system any further. With the DSP1124P, however, you can considerably enhance the system headroom! Let the **Single-Shot** filters on the DSP1124P suppress feedback as it occurs. Then cut back the volume to the level required for the show. In this way, you can be sure that there is enough system headroom should it become necessary to raise the volume level during the concert.

Experience has shown that musicians want to have the volume of their instrument increased on the monitor as the concert goes on. With the FEEDBACK DESTROYER PRO you can turn up the volume without having to fear feedback problems. When the show begins you should set several filters to **Auto** mode, in order to suppress feedback produced by "moving" (vocal) microphones. More information on **Auto** mode can be found in chapters 5 and 6.3.

6. OPERATING MODES OF THE DSP1124P

The individual filters on the BEHRINGER FEEDBACK DESTROYER PRO can operate in four different modes (see [7]). An additional mode called “Locked” mode will be described specifically. **Basically, each of the 2 x 12 filters on the DSP1124P can be set to any of the four operating modes.** To meet more complex requirements with regard to flexible signal processing, these modes can be combined in a program and stored in a preset.

6.1 Off mode “OF”

In **Off** mode, the corresponding filter is deactivated and can be activated by selecting one of the modes described below.

6.2 Manual filters (“PA”) / parametric equalizer

To raise or lower specific frequencies in level, you can select these frequencies directly by setting the manual filters to **Parametric EQ** mode. Each filter has the functionality of a fully parametric EQ, i.e. you can set the center frequency (FREQUENCY key [10]), the bandwidth (BANDWIDTH key [12]) and the amount of boost/cut (in dB) using the GAIN key [13].

6.3 Automatic filters (“SI” and “AU”)

Automatic filters operate in two modes: **Single-Shot** (SI) and **Auto** mode (AU). In order to find a feedback frequency, the FEEDBACK DESTROYER PRO divides the entire frequency band into 1/60 octave steps (20 Hz to 20 kHz) and determines the respective level of these individual bands. The unit then compares this value to the level of the entire signal. The difference between these levels determines whether a filter is set or not. The FEEDBACK DESTROYER PRO gives you the unique possibility of adapting this parameter according to your own needs. You can edit the feedback sensitivity (i.e. the difference value) within a range from -3 to -9 dB, in 1-dB steps: Simultaneously press the FILTER MODE and GAIN keys, then use the JOG WHEEL to select a value. The standard value for this parameter is -6 dB, which provides for an optimum detection of feedback in most applications.

Example: During a pure speech transmission, the feedback sensitivity can be lowered to -9 dB. In this way, the algorithm would recognize and suppress feedback even faster. On the other hand, a higher setting, e.g. -3 dB, allows you to leave those signals unaffected which you don't want to suppress (e.g. guitar or keyboard signals).

Filters in **Single-Shot** mode automatically analyze the music signal to detect feedback frequencies. Having detected such a frequency, the filter automatically configures its parameters to suppress feedback as efficiently as possible. As the filter is locked to the detected frequency, this mode is ideally suited to suppress feedback of constant frequency. Possible applications are “fixed-position” microphones (e.g. on the drums). After the filter has adjusted itself automatically, it enters a special **Locked** mode (see chapter 6.4), which means that although the frequency remains fixed, the width and depth of the filter are still being adapted to the feedback frequency, i.e. the width is increased as soon as the feedback frequency begins to shift, and the gain is cut if feedback prevails. The gain is not reduced to prevent feedback from recurring.

All microphones that are moved during a performance (e.g. vocal mics) very often have varying feedback frequencies. This type of feedback should be suppressed in **Auto** mode. As in **Single-Shot** mode, the filter automatically selects an ideal setting for feedback suppression. However, in Auto mode the first AU filter set is unlocked to suppress new feedback. The optimum frequency is selected automatically and the filter is set to narrow-band mode, so as to influence the music signal as little as possible. If your music contains wanted feedback elements (e.g. guitar feedback), it is highly probable that these will be suppressed too in Auto mode, because it is impossible from a physical point of view to distinguish “wanted” from “unwanted” feedback. Please read chapter 2.3 to find some information on how to work around this situation.

6.4 Locked mode (“LO”)

When the DSP1124P detects a feedback frequency in **Single-Shot** mode (see chapter 6.3), it automatically enters **Locked** mode, i.e. the filter locks to the trouble frequency and “keeps an eye” on it. To unlock such a filter, you need to switch it back to **Single-Shot** mode (see [7] and chapter 7.2).

7. WORKING WITH PRESETS

In order to store your favorite settings, the DSP1124P has ten user presets and one default preset. All operating parameters can be stored, so that your programs are recalled in full detail. Owing to state-of-the-art circuitry, no internal battery is needed, hence the memory contents will not get lost. In the default preset (DISPLAY: “--”), which serves as a starting point for your own programs, all filters remain in **Parametric EQ** mode, with bandwidth set to 1 octave, frequency to 500 Hz and 0 dB gain.

7.1 Recalling Presets

The FEEDBACK DESTROYER PRO has ten presets, which can be overwritten. After power-up, the unit restores the last preset used. Use the JOG WHEEL to select another preset. The default preset is located before the first program.

 Please note that the FEEDBACK DESTROYER PRO generally activates the newly selected presets only after about one second, which is indicated by a dot in the lower right corner of the DISPLAY. After loading the data, the FEEDBACK DESTROYER PRO enables the preset and the dot disappears. This brief interruption of the signal path avoids the direct activation of each preset, as you scroll through the preset list with the JOG WHEEL. Thus, the DSP1124P makes sure that no “unwanted” programs are loaded unintentionally. Additionally, you can rotate the JOG WHEEL at high speed and still have the time to specifically select the preset of your choice, instead of any of its “neighbors”.

7.2 Selecting the filter operating mode



Each filter mode has two letters assigned to it, which appear in the DISPLAY after pressing the FILTER MODE key. The following display messages are available:

Display	Operating mode
OF	Off
PA	Parametric EQ
AU	Auto
SI	Single-Shot
LO	Locked



Tab. 7.1: FEEDBACK DESTROYER PRO filter operating modes

As already mentioned, the operating mode of a filter can be changed as follows: Press the FILTER SELECT key and specify the filter number (1 through 12) with the JOG WHEEL. Using the two ENGINE keys, you can select the left (ENGINE L) or right audio channel (ENGINE R), or both at the same time by pressing the two ENGINE keys simultaneously.

Now, press the FILTER MODE key and select the mode of your choice with the JOG WHEEL. The display message “LO” (= “Locked”) informs you that a filter set to **Single-Shot** mode before is already suppressing feedback. As described in chapter 6.4, this filter is set to **Locked** mode automatically. You can unlock such a filter by switching it back to **Single-Shot** mode. As soon as a new feedback frequency will be found, the FEEDBACK DESTROYER PRO switches the filter from the old frequency to the new one. If you leave **Auto** or **Single-Shot** mode and enter **parametric EQ** mode, the filter’s parameter settings remain unchanged.

-  To avoid inadvertent changing of filter modes, the filter mode selection takes place after about one second, which is indicated by a dot in the lower right corner of the DISPLAY.
-  Press the FILTER MODE and GAIN keys at the same time, and use the JOG WHEEL to adjust the feedback threshold (= feedback sensitivity) within a range from -3 to -9 dB.

7.3 Editing filter parameters

-  Remember: Your DSP1124P has ten pre-configured user presets, each comprising 12 filters per channel. Each individual filter can be selected in any of the four operating modes!
-  However, the “Locked” mode cannot be selected directly: when a filter which was selected as “Single-Shot” detects a feedback frequency, the filter is automatically set and “locked”, i.e. the filter is locked to the problem frequency and “keeps an eye” on it.
-  In Single-Shot and Auto modes, the filter parameter cannot be edited but only displayed. Editing can be done in Parametric EQ mode only:

To change filter settings manually, the respective filter must be set to **Parametric EQ** mode. Press and keep the FILTER MODE key for about one second. Now, you can adapt the frequency after pressing FREQUENCY. Depending on the preset frequency, either the “Hz” or the “kHz” indicator to the right of the DISPLAY lights up. For example, when the filter is set to 160 Hz, the numeric DISPLAY will read the value and the “Hz” indicator lights up. To raise the frequency to 2,700 Hz, turn the JOG WHEEL clockwise until the ISO frequency (2.5 kHz; see Tab. 11.2) next to this value appears in the DISPLAY and the “kHz” indicator lights up. The FINE key allows you to fine tune the chosen standard ISO frequency within a tuning range of 1/3 octave (in 1/60-octave steps). The mathematical proportion between the displayed value and the absolute frequency, as well as a guide to find the desired frequency quickly, are listed in the appendix (chapter 11.1 – frequency chart). The bandwidth of the filter (quality) can be adjusted by selecting the BANDWIDTH key. The adjustable bandwidth ranges from 2 octaves down to 1/60 octave. By pressing the GAIN key, it is possible to set the desired boost or cut of the selected frequency. A “+” or “-” signals that the level is being increased or decreased respectively.

-  Filters in Single-Shot or Auto mode can be transformed into parametric filters with the same frequency, quality and 0 dB gain by pressing the FILTER MODE key for about one second. Only then will it be possible to edit the filter parameters.

7.4 Storing presets

Whenever you edit a preset, the LED in the STORE key starts flashing. Basically, all edits in **Parametric EQ** mode and the filter deactivation in **Off** mode can be stored. Filters in **Single-Shot** or **Auto** mode adjust and store their parameters automatically. However, these data will get lost when you switch off the unit. To avoid that, please write the edited setting to a preset before you switch the DSP1124P off:

Press the STORE key once, so that the DISPLAY starts flashing. If you wish to preserve the original preset, use the JOG WHEEL to select another preset number, which can be overwritten. Then, press STORE again to save your edits to the selected preset. If you wish to overwrite the original preset, simply press the STORE key twice after editing, so as to save all edits to the same preset.

7.5 Restoring the factory presets

Press and keep the FILTER SELECT and STORE keys pressed before you switch on the FEEDBACK DESTROYER PRO. After power-up keep the switches pressed for another second. The preset numbers are counted up and the presets are reset to their original default values.

8. PROBLEMS DO HAVE A CAUSE ...

Feedback is one of the major problems encountered in live P.A. applications. In a worst-case scenario every microphone signal passing an amplifier can cause feedback. Still, there's a lot you can do even before the show begins:

- ▲ Place the microphones at some distance to the FOH and monitor speakers.
- ▲ Make sure that the levels of the microphone channels are adjusted correctly (see user's manual of your console).
- ▲ Use the microphones according to their polar patterns (e.g. omnidirectional, cardioid, super-cardioid).
- ▲ Poor room acoustics should be improved. Tiled walls and floors, which are highly reflective, can be covered with curtains or carpet.
- ▲ Use a graphic equalizer to adapt the overall sound to the room acoustics.
- ▲ To a certain degree, feedback can also be suppressed manually with a graphic EQ.

9. MIDI CONTROL

Use the MIDI key combination to select the MIDI parameters you wish to adjust. To do so, press and keep the IN/OUT and STORE keys at the same time. All parameters can be edited with the JOG WHEEL and these two keys. The MIDI menu includes six pages, which you can select by pressing the IN/OUT key (forward) and the STORE key (backward) several times.

On the first page, you can select the MIDI channel. The DISPLAY reads a small "c" (= channel). The JOG WHEEL adjusts a channel from 1 through 16. To switch off the MIDI function, simply select "0" (displayed as "-").

On the second page, you can select MIDI Omni mode, i.e. the unit transmits/receives on all 16 MIDI channels. The DISPLAY reads "O" (= Omni). Use the JOG WHEEL to activate ("1") or deactivate ("0") MIDI Omni mode.

The third page allows for the configuration of controller commands. On its right-hand side, the DISPLAY reads a capital "C" (= Controller). The JOG WHEEL selects one of the five controller modes shown below:

Display	Mode
0	No controller data are transmitted
1	Controller data are received but not transmitted
2	Controller data are transmitted but not received
3	Controller data are transmitted and received
4	As 3, with additionally the automatic filter parameters

Tab. 9.1: Controller settings

 **When you choose value "4", the FEEDBACK DESTROYER PRO will send the automatic filter values in addition to the parameter values.**

For details on the controller functions, see Tab. 11.5 in the appendix.

The fourth page gives you access to the Program Changes. The DISPLAY reads a capital "P" (= Program). Four modes are available, which can be selected with the JOG WHEEL, as follows:

Display	Mode
0	No program change data are transmitted
1	Program change data are received but not transmitted
2	Program change data are transmitted but not received
3	Program change data are transmitted and received

Tab. 9.2: Program change settings

The fifth page of the MIDI menu shows the “Store Enable” flag represented by a capital “S” in the DISPLAY. Available values are “0” and “1”. If set to “1”, the FEEDBACK DESTROYER PRO receives controller 18 as a direct save command, i.e. the current settings will be stored without further confirmation in the preset number that corresponds to this controller value. If set to “0”, the DSP1124P ignores all incoming commands referring to controller 18.

 **ATTENTION! Store Enable mode has been designed to transmit several presets as conveniently as possible from an external PC to the FEEDBACK DESTROYER PRO. In this mode, it is possible that stored presets will be replaced or altered if controller 18 messages are sent via MIDI! We therefore recommend that you disable this mode as soon as the intended data transfer has been completed. During power-up, this mode is automatically disabled (mode “0”).**

On the sixth, and presently the last page you can access the “System Exclusive” functions, which is indicated by a “d” (= dump) in the DISPLAY. To the left of this “d”, you can see a “0” if no sys-ex data can be received or transmitted. When you enter mode “1”, the DSP1124P will be able to receive sys-ex data. In mode “2”, the DSP1124P is ready to dump its entire memory contents with all parameter settings to an external MIDI storage medium. Start your sequencer software, and press the STORE key. To load the data back, select mode “1”, and start your sequencer software to restore the settings in your FEEDBACK DESTROYER PRO.

If you press the IN/OUT key again on the sixth page, the FEEDBACK DESTROYER PRO quits MIDI mode. You can also use any other key to leave the MIDI setup menu.

The full-featured MIDI implementation of the FEEDBACK DESTROYER PRO allows for easily integrating the unit into any MIDI system.

▲ MIDI IN

All MIDI data sent to the DSP1124P (sequencer, MIDI foot controller, etc.) are received via the MIDI IN jack. For example, if you wish to use the DSP1124P as an effects device for your guitar rack, you can connect the MIDI IN jack to a MIDI foot controller that allows for selecting program presets. If your rack includes another MIDI effects device, the data sent from the MIDI foot controller can be passed on to that device through the MIDI THRU port of the FEEDBACK DESTROYER PRO.

▲ MIDI THRU

The MIDI THRU jack is used to loop through incoming MIDI data, i.e. any controller data received at the MIDI IN of the FEEDBACK DESTROYER PRO will be transmitted via the MIDI THRU jack to other MIDI devices/instruments.

▲ MIDI OUT

The MIDI OUT jack allows for transmitting MIDI data that originate from the DSP1124P.

The FEEDBACK DESTROYER Design Editor software enables you to control the DSP1124P from an external PC. What is more, you can use the FEEDBACK DESTROYER PRO to control the editor software, so that both units communicate with each other. Download the editor free of charge from our web site at www.behringer.com.

10. INSTALLATION

10.1 Audio connections

As a standard, the audio inputs and outputs on the BEHRINGER FEEDBACK DESTROYER PRO are fully balanced. If possible, connect the unit to other devices in a balanced configuration to allow for maximum interference immunity.

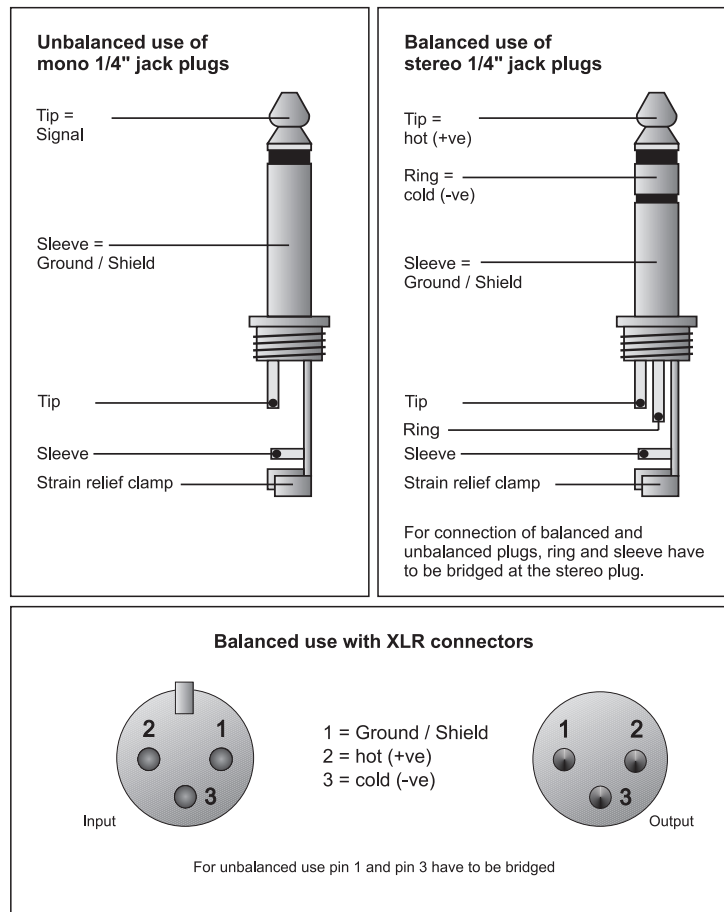

Fig. 10.1: Different plug types

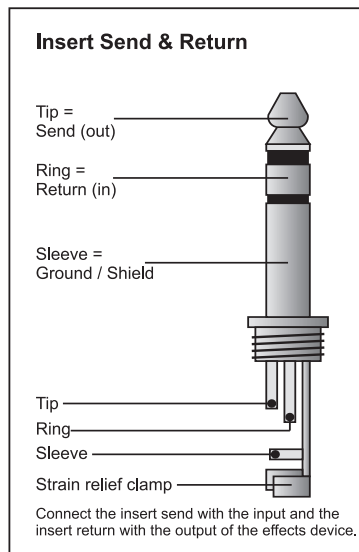

Fig. 10.2: Wiring an insert cable



Please ensure that only qualified persons install and operate the FEEDBACK DESTROYER PRO. During installation and operation the user must have sufficient electrical contact to earth. Electrostatic charges might affect the operation of the unit.

10.2 MIDI connections

The MIDI connectors found on the rear panel are on internationally standardized 5-pin DIN jacks. You need dedicated MIDI cables to connect the FEEDBACK DESTROYER PRO to other MIDI equipment. Normally, complete cables will be purchased for this use, but you can also make your own, using a high-quality two-conductor shielded cables (e.g. microphone cable) and two rugged 180° DIN plugs: pin 2 (center) = shield, pins 4 and 5 (right and left of pin 2) = internal conductors, pins 1 and 3 (the two outer pins) are not used. MIDI cables should have a maximum length not exceeding 15 meters.

MIDI IN: Receives MIDI control data. The receive channel is determined in the SETUP menu.

MIDI THRU: Provides an unchanged copy of the signal received at the MIDI IN, for example, to daisy-chain several FEEDBACK DESTROYER PROs.

MIDI OUT: Transmits MIDI data to a connected computer or other FEEDBACK DESTROYER PROs. Transmitted are program data as well as status information for signal processing.

11. APPENDIX

11.1 Frequency chart

Display	-9/60	-8/60	-6/60	-4/60	-2/60	ISO	+2/60	+4/60	+6/60	+8/60	+10/60	Display
20 Hz						20	20,5	21	21,5	22	22,5	20 Hz
25 Hz	22,8	23	23,5	24	24,5	25	25,7	26,3	27	27,6	28,3	25 Hz
32 Hz	28,6	28,9	29,6	30,2	30,9	31,5	32,4	33,2	34,1	34,9	35,8	32 Hz
40 Hz	36,2	36,6	37,5	38,3	39,2	40	41	42	43	44	45	40 Hz
50 Hz	45,5	46	47	48	49	50	51	53	54	55	57	50 Hz
63 Hz	57	58	59	60	62	63	65	66	68	70	71,5	63 Hz
80 Hz	72,4	73	75	77	78	80	82	84	86	88	90	80 Hz
100 Hz	91	92	94	96	98	100	103	105	108	110	113	100 Hz
125 Hz	114	115	118	120	123	125	129	132	136	139	143	125 Hz
160 Hz	144	146	150	153	157	160	164	168	172	176	180	160 Hz
,20 kHz	182	184	188	192	196	200	205	210	215	220	225	,20 kHz
,25 kHz	228	230	235	240	245	250	257	263	270	276	283	,25 kHz
,32 kHz	286	289	296	302	309	315	324	332	341	349	358	,32 kHz
,40 kHz	362	366	375	383	392	400	410	420	430	440	450	,40 kHz
,50 kHz	455	460	470	480	490	500	513	526	539	552	565	,50 kHz
,63 kHz	572	578	591	604	617	630	647	664	681	698	715	,63 kHz
,80 kHz	724	732	749	766	783	800	820	840	860	880	900	,80 kHz
1,00 kHz	910	920	940	960	980	1000	1025	1050	1075	1100	1125	1,00 kHz
1,25 kHz	1138	1150	1175	1200	1225	1250	1285	1320	1355	1390	1425	1,25 kHz
1,60 kHz	1443	1460	1495	1530	1565	1600	1640	1680	1720	1760	1800	1,60 kHz
2,0 kHz	1820	1840	1880	1920	1960	2000	2050	2100	2150	2200	2250	2,0 kHz
2,5 kHz	2275	2300	2350	2400	2450	2500	2565	2630	2695	2760	2825	2,5 kHz
3,2 kHz	2858	2890	2955	3020	3085	3150	3235	3320	3405	3490	3575	3,2 kHz
4,0 kHz	3618	3660	3745	3830	3915	4000	4100	4200	4300	4400	4500	4,0 kHz
5,0 kHz	4550	4600	4700	4800	4900	5000	5130	5260	5390	5520	5650	5,0 kHz
6,3 kHz	5715	5780	5910	6040	6170	6300	6470	6640	6810	6980	7150	6,3 kHz
8,0 kHz	7235	7320	7490	7660	7830	8000	8200	8400	8600	8800	9000	8,0 kHz
10,0 kHz	9100	9200	9400	9600	9800	10000	10250	10500	10750	11000	11250	10,0 kHz
12,5 kHz	11375	11500	11750	12000	12250	12500	12850	13200	13550	13900	14250	12,5 kHz
16,0 kHz	14425	14600	14950	15300	15650	16000	16400	16800	17200	17600	18000	16,0 kHz
20 kHz	18200	18400	18800	19200	19600	20000						20 kHz

Tab. 11.1: Frequency chart

In order to maintain a better survey only every second value is registered in the table. The adjustable values do not exactly fit into a 1/60 octave interval, because also the ISO frequencies do not perfectly fit into a physical 1/3 octave interval. Rather a linear approximation is used to specify the values.

Background f_1, f_2, \dots ISO frequencies
 1 third = 20/60 octave (idealized ISO interval)

$$\text{increment } \Delta f_n = \frac{(f_{n+1} - f_n)}{20}$$

Hz	20	25	31.5	40	50	63	80	100	125	160	200	250	315	400	500	630	800
kHz	1	1.25	1.6	2	2.5	3.15	4	5	6.3	8	10	12.5	16	20			

Tab. 11.2: Standard ISO frequencies

11.2 Preset table

Preset	Filter 1	Filter 2	Filter 3	Filter 4	Filter 5	Filter 6	Filter 7	Filter 8	Filter 9	Filter 10	Filter 11	Filter 12
1	MONO: 9 single shot filters attenuate room resonances before 3 automatic filters destroy variable feedbacks											
L	SI	SI	SI	SI	SI	SI	SI	SI	SI	AU	AU	AU
R	SI	SI	SI	SI	SI	SI	SI	SI	SI	AU	AU	AU
2	2 x MONITOR AS FEEDBACK DESTROYER ONLY: 7 single shots / 5 automatic filters for most monitor setups											
L	SI	SI	SI	SI	SI	SI	SI	AU	AU	AU	AU	AU
R	SI	SI	SI	SI	SI	SI	SI	AU	AU	AU	AU	AU
3	MONO AUTO PILOT: 12 Filters per channel constantly chase and destroy feedbacks											
L	AU	AU	AU	AU	AU	AU	AU	AU	AU	AU	AU	AU
R	AU	AU	AU	AU	AU	AU	AU	AU	AU	AU	AU	AU
4	STEREO PARAMETRIC EQ: Preset with 12 ISO frequencies, all set to 1/3 Oct., Gain + 0 dB											
Couple	125 Hz	160 Hz	200 Hz	250 Hz	315 Hz	400 Hz	500 Hz	630 Hz	800 Hz	1 k	1.25 k	1.6 k
5	STEREO PARAMETRIC EQ: Preset with 12 ISO frequencies, all set to 2/3 Oct., Gain + 0 dB											
Couple	40 Hz	63 Hz	100 Hz	160 Hz	250 Hz	400 Hz	630 Hz	1 k	1.6 k	2.5 k	4 k	6.3 k
6	2 x MONO: Sample monitoring, left for handheld (lead) microphone(s), right for fixed (backing) ones											
L	SI	SI	SI	AU	AU	AU	AU	AU	PA def	PA def	PA def	PA def
R	SI	SI	SI	SI	SI	AU	AU	AU	PA def	PA def	PA def	PA def
7	MONO PARAMETRIC AND SINGLE SHOT FILTERS: A good start for a monitor equalization											
L	SI	SI	SI	SI	SI	SI	SI	SI	PA def	PA def	PA def	PA def
R	SI	SI	SI	SI	SI	SI	SI	SI	PA def	PA def	PA def	PA def
8	STEREO FOH EQ, providing 4 parametric EQ's (low roll off in filter 1 and 2), plus 8 single shot filters											
Couple	PA	PA	PA d.	PA d.	SI	SI	SI	SI	SI	SI	SI	SI
	40 Hz	80 Hz	Channels coupled, changes on one channel are valid for both									
	1 Oct.	1 Oct.										
	-8 dB	-4 dB										
9	MONO FREE											
L, R	SI	SI	SI	SI	SI	SI	SI	AU	AU	PA	PA	PA
	SI	SI	SI	SI	SI	SI	SI	AU	AU	PA	PA	PA
10	STEREO FREE											
Couple	SI	SI	SI	SI	SI	SI	SI	AU	AU	PA	PA	PA

Tab. 11.3: Preset table

11.3 MIDI implementation

Function		Transmitted	Recognized	Remarks
Basic Channel	Default	OFF, 1 - 16	OFF, 1 - 16	memorized
	Changed	OFF, 1 - 16	OFF, 1 - 16	
Mode	Default	1,2,3,4	1,2,3,4	
	Messages	X	X	
	Altered	X	X	
Note Number		X	X	
	True Voice	X	X	
Velocity	Note ON	X	X	
	Note OFF	X	X	
After Touch	Key's	X	X	
	Ch's	X	X	
Pitch Bender		X	X	
Control		O 10 - 19	O 10 - 19	see add. Table
Progr. Change		O (0-9)	O (0-9)	
	True #	1-10	1-10	
System Exclusive		O	O	
System Common	Song Pos	X	X	
	Song Sel	X	X	
	Tune	X	X	
System Real Time	Clock	X	X	
	Commands	X	X	
Aux Messages	Local ON/OFF	X	X	
	All notes OFF	X	X	
	Active Sense	X	X	
	Reset	X	X	
Notes				

O = YES, X = NO

- Mode 1: OMNI ON, POLY
- Mode 2: OMNI ON, MONO
- Mode 3: OMNI OFF, POLY
- Mode 4: OMNI OFF, MONO

Tab. 11.4: MIDI implementation chart

Parameter Name	Display Range	Midi Control Number	Control Value Range	LEDs					
				Couple	Left	Right	IN on	IN off	IN flashing
Filter Select	1..12	10	0..11						
Filter Mode	OF, PA, AU, SI	11	0..3						
Engine		12	0,1,2	0	1	2			
Frequency	20 (Hz)..20 (kHz)	13	0..30						
Fine (1/60 Oct)	-9..+10	14	0..19						
Bandwidth	1..120	15	0..119						
Gain	-48..+16	16	0..64						
Feedback Sensitivity	-3..-9	17	0..6						
Store	1..10	18	0..9						
In/Out		19	0..2				2	1	0

Tab. 11.5: Controller functions with MIDI

12. SPECIFICATIONS

AUDIO INPUTS

Connectors	XLR and 1/4" TRS
Type	RF filtered, servo-balanced input
Impedance	60 kOhms balanced, 30 kOhms unbalanced
Nominal Operating Level	-10 dBV to +4dBu (switchable)
Max. Input Level	+16 dBu at +4 dB nominal level, +2 dBV at -10 dBV nominal level

AUDIO OUTPUTS

Connectors	XLR and 1/4" TRS
Type	Electronically servo-balanced output stage
Impedance	60 Ohms balanced, 30 Ohms unbalanced
Max. Output Level	+16 dBu at +4 dB nominal level, +2 dBV at -10 dBV nominal level

SYSTEM SPECIFICATIONS

Bandwidth	20 Hz to 20 kHz, -3 dB
Noise	> 94 dB, unweighted, 20 Hz to 20 kHz
THD	0.0075 % typ. @ +4 dBu, 1 kHz, Gain 1
Crosstalk	< -76 dB

MIDI INTERFACE

Type	5-Pin-DIN-Socket IN / OUT / THRU
------	----------------------------------

DIGITAL PROCESSING

Converters	24-bit Sigma-Delta, 64/128-times Oversampling
Sampling Rate	46,875 kHz

DISPLAY

Type	2 ½-digit numeric LED-Display
------	-------------------------------

POWER SUPPLY

Mains Voltages	USA/Canada	120 V ~, 60 Hz
	U.K./Australia	240 V ~, 50 Hz
	Europe	230 V ~, 50 Hz
	General Export Model	100 - 120 V ~, 200 - 240 V ~, 50 - 60 Hz
Power Consumption	approx. 15 Watts max.	
Fuse	100 - 120 V ~:	T 200 mA H
	200 - 240 V ~:	T 100 mA H
Mains Connection	Standard IEC receptacle	

PHYSICAL

Dimensions (H x W x D)	approx. 1 3/4" (44.5 mm) x 19" (482.6 mm) x 7 1/2" (190.5 mm)
Net Weight	approx. 2 kg
Shipping Weight	approx. 3 kg

BEHRINGER is constantly striving to maintain the highest professional standards. As a result of these efforts, modifications may be made from time to time to existing products without prior notice. Specifications and appearance may differ from those listed or illustrated.

13. WARRANTY

§ 1 WARRANTY CARD/ONLINE REGISTRATION

To be protected by the extended warranty, the buyer must complete and return the enclosed warranty card within 14 days of the date of purchase to BEHRINGER Spezielle Studioteknik GmbH, in accordance with the conditions stipulated in § 3. Failure to return the card in due time (date as per postmark) will void any extended warranty claims.

Based on the conditions herein, the buyer may also choose to use the online registration option via the Internet (www.behringer.com or www.behringer.de).

§ 2 WARRANTY

1. BEHRINGER (BEHRINGER Spezielle Studioteknik GmbH including all BEHRINGER subsidiaries listed on the enclosed page, except BEHRINGER Japan) warrants the mechanical and electronic components of this product to be free of defects in material and workmanship for a period of one (1) year from the original date of purchase, in accordance with the warranty regulations described below. If the product shows any defects within the specified warranty period that are not due to normal wear and tear and/or improper handling by the user, BEHRINGER shall, at its sole discretion, either repair or replace the product.

2. If the warranty claim proves to be justified, the product will be returned to the user freight prepaid.

3. Warranty claims other than those indicated above are expressly excluded.

§ 3 RETURN AUTHORIZATION NUMBER

1. To obtain warranty service, the buyer (or his authorized dealer) must call BEHRINGER (see enclosed list) during normal business hours **BEFORE** returning the product. All inquiries must be accompanied by a description of the problem. BEHRINGER will then issue a return authorization number.

2. Subsequently, the product must be returned in its original shipping carton, together with the return authorization number to the address indicated by BEHRINGER.

3. Shipments without freight prepaid will not be accepted.

§ 4 WARRANTY REGULATIONS

1. Warranty services will be furnished only if the product is accompanied by a copy of the original retail dealer's invoice. Any product deemed eligible for repair or replacement by BEHRINGER under the terms of this warranty will be repaired or replaced within 30 days of receipt of the product at BEHRINGER.

2. If the product needs to be modified or adapted in order to comply with applicable technical or safety standards on a national or local level, in any country which is not the country for which the product was originally developed and manufactured, this modification/adaptation shall not be considered a defect in materials or workmanship. The warranty does not cover any such modification/adaptation, irrespective of whether it was carried out properly or not. Under the terms of this warranty, BEHRINGER shall not be held responsible for any cost resulting from such a modification/adaptation.

3. Free inspections and maintenance/repair work are expressly excluded from this warranty, in particular, if caused by improper handling of the product by the user.

This also applies to defects caused by normal wear and tear, in particular, of faders, potentiometers, keys/buttons and similar parts.

4. Damages/defects caused by the following conditions are not covered by this warranty:

- ▲ misuse, neglect or failure to operate the unit in compliance with the instructions given in BEHRINGER user or service manuals.

- ▲ connection or operation of the unit in any way that does not comply with the technical or safety regulations applicable in the country where the product is used.

- ▲ damages/defects caused by force majeure or any other condition that is beyond the control of BEHRINGER.

5. Any repair or opening of the unit carried out by unauthorized personnel (user included) will void the warranty.

6. If an inspection of the product by BEHRINGER shows that the defect in question is not covered by the warranty, the inspection costs are payable by the customer.

7. Products which do not meet the terms of this warranty will be repaired exclusively at the buyer's expense. BEHRINGER will inform the buyer of any such circumstance. If the buyer fails to submit a written repair order within 6 weeks after notification, BEHRINGER will return the unit C.O.D. with a separate invoice for freight and packing. Such costs will also be invoiced separately when the buyer has sent in a written repair order.

§ 5 WARRANTY TRANSFERABILITY

This warranty is extended exclusively to the original buyer (customer of retail dealer) and is not transferable to anyone who may subsequently purchase this product. No other person (retail dealer, etc.) shall be entitled to give any warranty promise on behalf of BEHRINGER.

§ 6 CLAIM FOR DAMAGES

Failure of BEHRINGER to provide proper warranty service shall not entitle the buyer to claim (consequential) damages. In no event shall the liability of BEHRINGER exceed the invoiced value of the product.

§ 7 OTHER WARRANTY RIGHTS AND NATIONAL LAW

1. This warranty does not exclude or limit the buyer's statutory rights provided by national law, in particular, any such rights against the seller that arise from a legally effective purchase contract.

2. The warranty regulations mentioned herein are applicable unless they constitute an infringement of national warranty law.

The information contained in this manual is subject to change without notice. No part of this manual may be reproduced or transmitted in any form or by any means, electronic or mechanical, including photocopying and recording of any kind, for any purpose, without the express written permission of BEHRINGER Spezielle Studioteknik GmbH.

BEHRINGER, FEEDBACK DESTROYER, FB-D and SHARK are registered trademarks. ALL RIGHTS RESERVED.

© 2001 BEHRINGER Spezielle Studioteknik GmbH.

BEHRINGER Spezielle Studioteknik GmbH, Hanns-Martin-Schleyer-Str. 36-38, 47877 Willich-Münchheide II, Germany

Tel. +49 (0) 21 54 / 92 06-0, Fax +49 (0) 21 54 / 92 06-30

FEDERAL COMMUNICATIONS COMMISSION COMPLIANCE INFORMATION



Responsible party name: **MUSIC Group Services USA, Inc.**
Address: **18912 North Creek Parkway,
Suite 200 Bothell, WA 98011,
USA**
Phone/Fax No.: **Phone: +1 425 672 0816
Fax: +1 425 673 7647**

FEEDBACK DESTROYER PRO DSP1124P

complies with the FCC rules as mentioned in the following paragraph:

This equipment has been tested and found to comply with the limits for a Class B digital device, pursuant to part 15 of the FCC Rules. These limits are designed to provide reasonable protection against harmful interference in a residential installation. This equipment generates, uses and can radiate radio frequency energy and, if not installed and used in accordance with the instructions, may cause harmful interference to radio communications. However, there is no guarantee that interference will not occur in a particular installation. If this equipment does cause harmful interference to radio or television reception, which can be determined by turning the equipment off and on, the user is encouraged to try to correct the interference by one or more of the following measures:

- Reorient or relocate the receiving antenna.
- Increase the separation between the equipment and receiver.
- Connect the equipment into an outlet on a circuit different from that to which the receiver is connected.
- Consult the dealer or an experienced radio/TV technician for help.

This device complies with Part 15 of the FCC rules. Operation is subject to the following two conditions:

- (1) this device may not cause harmful interference, and
- (2) this device must accept any interference received, including interference that may cause undesired operation.

Important information:

Changes or modifications to the equipment not expressly approved by MUSIC Group can void the user's authority to use the equipment.