



# User Manual

## Vigilance HD Outdoor PoE Mini Bullet Camera

DCS-4701E

---

# Preface

D-Link reserves the right to revise this publication and to make changes in the content hereof without obligation to notify any person or organization of such revisions or changes. Information in this document may become obsolete as our services and websites develop and change.

## Manual Revisions

Revision	Date	Description
1.0	April 21, 2015	DCS-4701E Revision A1 with firmware version 1.00

## Trademarks

D-Link and the D-Link logo are trademarks or registered trademarks of D-Link Corporation or its subsidiaries in the United States or other countries. All other company or product names mentioned herein are trademarks or registered trademarks of their respective companies.

Copyright © 2015 D-Link Corporation.

All rights reserved. This publication may not be reproduced, in whole or in part, without prior expressed written permission from D-Link Corporation.







---

# Table of Contents

Product Overview.....	4	Advanced.....	45
Package Contents.....	4	ICR and IR.....	45
Introduction.....	5	HTTPS.....	46
System Requirements .....	5	Access List.....	47
Features.....	6	SNMP .....	48
Hardware Overview .....	7	Maintenance.....	50
Front and Back.....	7	Device Management .....	50
Sides .....	8	System .....	51
Mounting the Camera.....	9	Firmware Upgrade.....	52
Waterproofing Your Installation .....	11	Status .....	53
Software Installation.....	14	Device Info .....	53
Configuration.....	17	Logs .....	54
Using the Configuration Interface.....	17	Help.....	55
Live Video .....	19	Technical Specifications .....	56
Setup .....	21		
Setup Wizard .....	21		
Network Setup.....	26		
Dynamic DNS .....	29		
Image Setup .....	30		
Video .....	32		
Preset.....	34		
Motion Detection .....	36		
Time and Date.....	37		
Event Setup.....	38		

# Product Overview

## Package Contents

-  DCS-4701E Vigilance HD Outdoor PoE Mini Bullet Camera
-  Cable Waterproofing Connector
-  Rubber Power Connector Plug
-  Mounting Kit
-  CD-ROM with User Manual and software
-  Quick Installation Guide



If any of the above items are missing, please contact your reseller.

**Safety Notice:** Installation and servicing should be done by certified technicians so as to conform to all local codes and prevent voiding your warranty.

## Introduction

Congratulations on your purchase of the DCS-4701E Vigilance HD Outdoor PoE Mini Bullet Camera. The DCS-4701E is a professional surveillance and security solution for small, medium, and large enterprises alike. The DCS-4701E uses an HD progressive scan CMOS sensor; the professional sensor results in low noise and high sensitivity capabilities ideal for surveillance applications.

The DCS-4701E is a complete system with a built-in CPU and incorporates a web server, allowing it to transmit excellent real-time Full HD resolution video for security and outdoor surveillance.

The DCS-4701E can be accessed remotely, controlled and configured from any PC/Notebook over your local network or through the Internet via a web browser. The simple installation and intuitive web-based interface offer easy configuration across the full range of its advanced feature set, including granular control over multiple video streams with different configurations and multicast video streams which helps you manage your network load.

The DCS-4701E has an IP66 certified weatherproof housing designed for both indoor and outdoor applications. The built-in removable IR-cut filter and IR LEDs give the DCS-4701E the capability to view up to 30M at night. The DCS-4701E also incorporates Power over Ethernet (PoE), allowing it to be easily installed in a variety of locations without the need for supplemental power cabling. The combination of IP66 weatherproof housing, IR-Cut Filter, IR LEDs, and PoE make the DCS-4701E an ideal solution for a dependable and cost-effective 24 hour surveillance solution with easy clutter-free installation.

## System Requirements

- Computer with Microsoft Windows® 8, 7, or Vista® (for CD-ROM Setup Wizard), Mac OS or Linux
- Internet Explorer 7, Firefox 20, Chrome 20, or Safari 6 or higher
- Existing 10/100 Ethernet-based network with an available 802.3af Power over Ethernet (PoE) port

## Features

### **Simple to Maintain**

The DCS-4701E is a stand-alone system with a built-in CPU, requiring no special hardware or software. The DCS-4701E can be viewed and managed through most web browsers, including Internet Explorer®, Chrome®, Firefox®, and Safari®.

### **Supports a Variety of Platforms**

With support for TCP/IP networking, HTTP, and other Internet related protocols, the DCS-4701E can also be integrated easily into other Internet/ Intranet applications because of its standards-based features. The DCS-4701E works with any 10/100 Ethernet network, making the DCS-4701E easy to integrate into your existing network environment.

### **Advanced Event Management**

The DCS-4701E can be set up to send e-mail notifications with snapshots when an event occurs, such as when motion is detected. Events can be triggered from several sources, such as motion detection and time based events.

### **IR LEDs for Day and Night Functionality**

The built-in infrared LEDs enable night time viewing of up to 30 meters.

### **IP66 Weatherproof Housing**

The DCS-4701E uses an IP66 weatherproof housing, allowing you to rest assured that in the toughest of conditions, it will continue to provide round-the-clock surveillance.

### **PoE (Power over Ethernet) for Flexible Installation**

The DCS-4701E can draw all the power it needs from a PoE switch or PoE injector for a simple and clutter-free installation.

### **Remote Monitoring Utility**

The D-ViewCam application adds enhanced features and functionality for the Network Camera and allows administrators to configure and access the Network Camera from a remote site via Intranet or Internet. Other features include image monitoring, recording images to a hard drive, viewing up to 32 cameras on one screen, and taking snapshots.

## Hardware Overview Front and Back

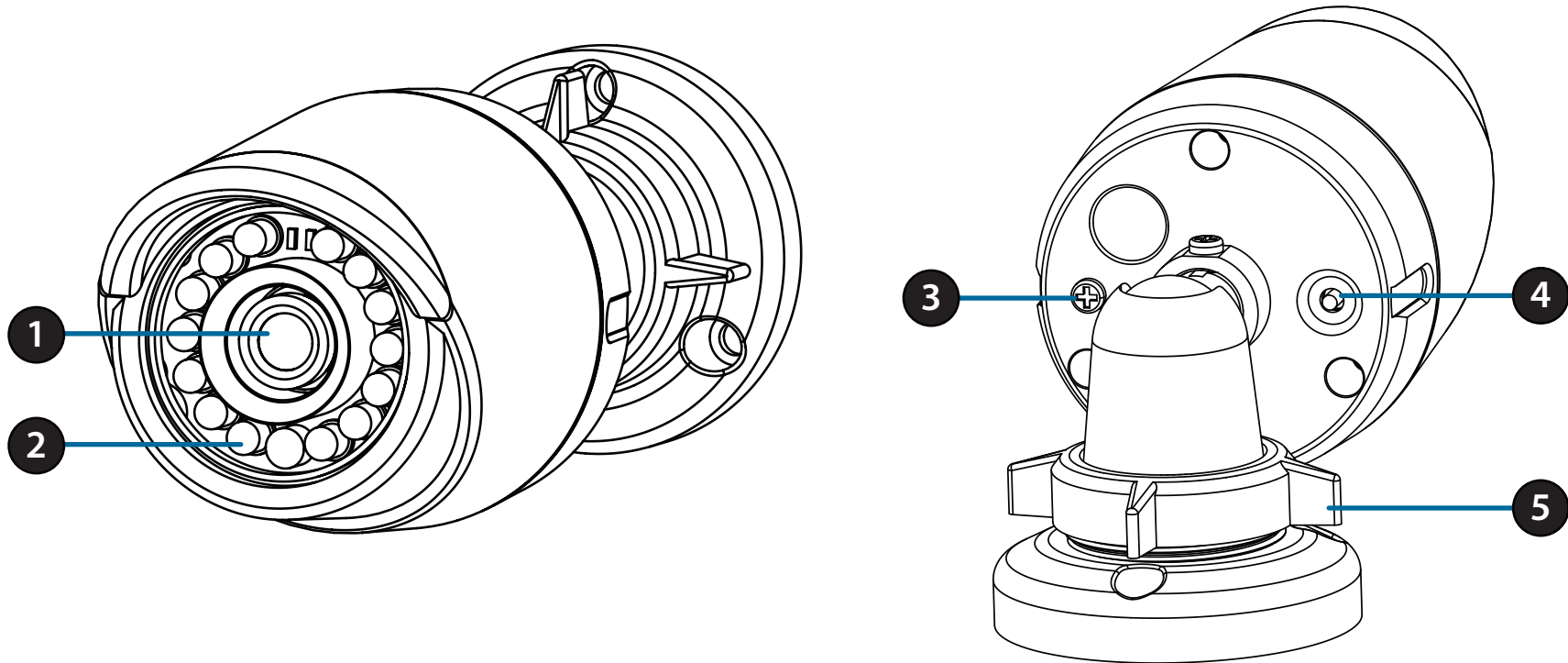

1	<b>Camera Lens</b>	Fixed lens to record video of the surrounding area
2	<b>IR LEDs</b>	Infrared LEDs illuminate the camera's field of view at night
3	<b>Grounding Screw</b>	Can be attached to a grounding wire if desired
4	<b>Reset Button</b>	Press and hold for 10 seconds to reset camera back to the factory default settings
5	<b>Adjustment Ring</b>	Loosen to adjust camera angle and tighten to lock camera angle

## Sides

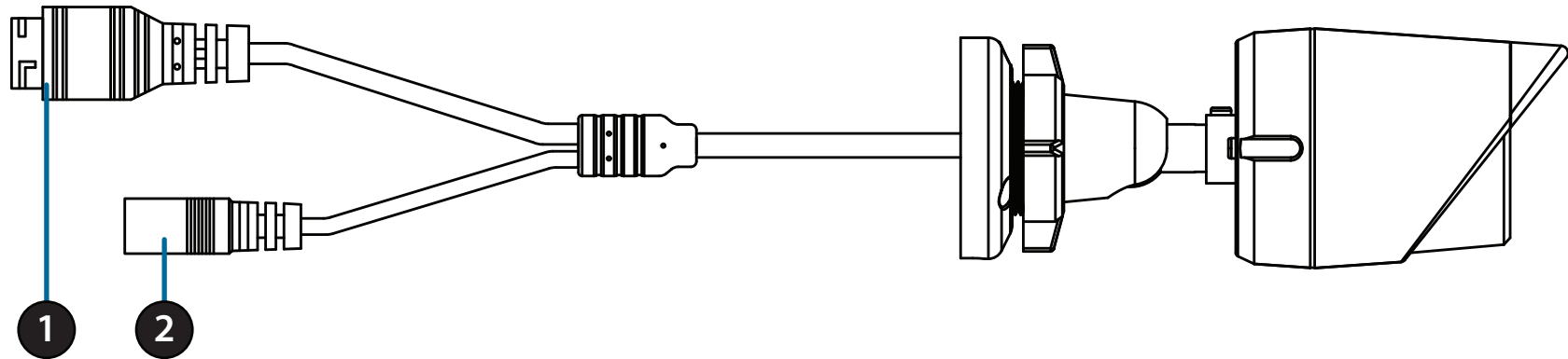

1	<b>Ethernet Jack</b>	RJ-45 connector for Ethernet, can also be used to power the camera using Power over Ethernet (PoE)
2	<b>Power Connector</b>	Connects to an optional 12 V / 1.5 A power adapter (not included)

## Mounting the Camera

It is highly recommended that you configure and test your camera before mounting it.

### Step 1

Place the mounting sticker where you want to position the camera. Make sure the camera base will be positioned so that the cable channel is on the bottom.

Use a 6 mm drill bit to make the required holes approximately 25 mm deep, then insert the wall anchors into the holes.

**If you are running the camera cables through the wall,** drill a hole in the center and pull the cables through the hole.

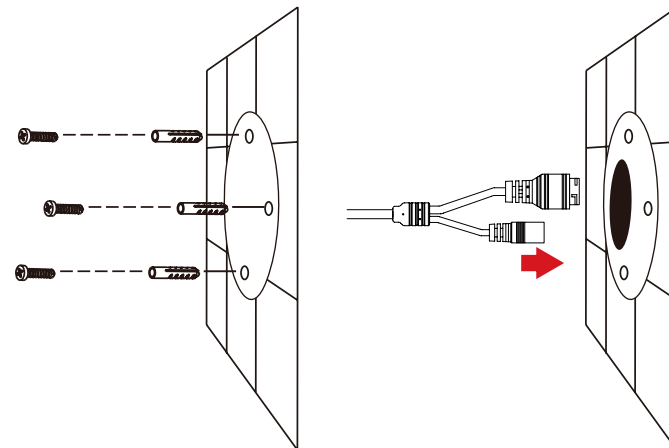

### Step 2

Use the screws provided to mount the camera to the wall.

If you are running the camera cables out the side of the camera, guide the camera cables through the cable channel on the base.

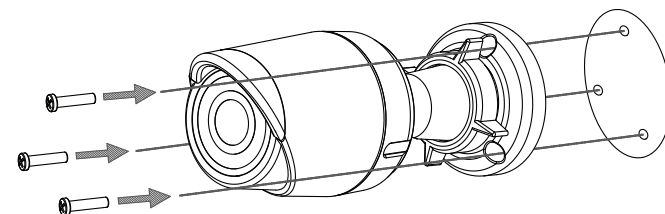

### Step 3

Connect the power and Ethernet cables, or just the Ethernet cable if you are using a PoE connection.

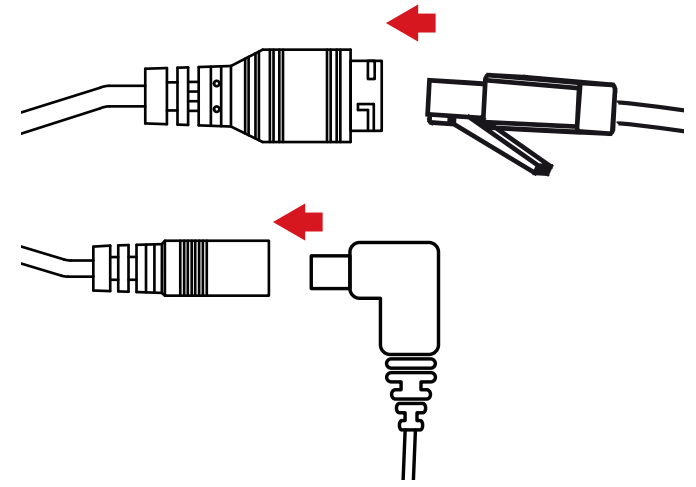

### Step 4

To adjust the camera's angle, turn the adjustment ring counterclockwise to loosen it, then move the camera to the desired position and angle. When you are finished, turn the adjustment ring clockwise to tighten it.

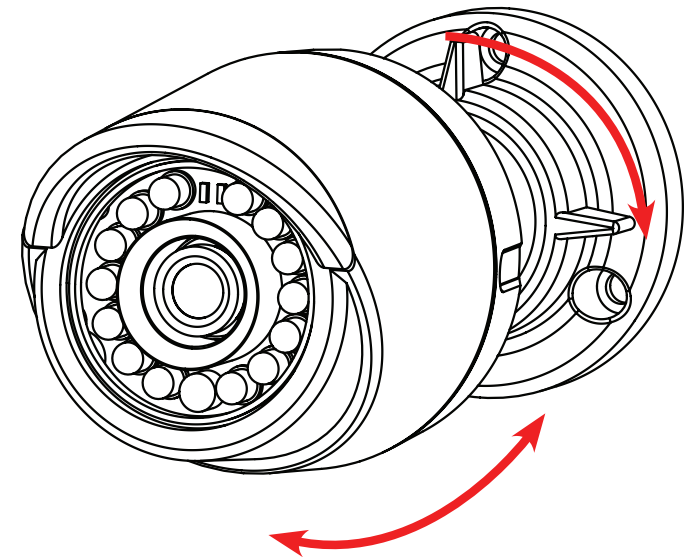

If you need to waterproof your installation, please continue to the next page.

## Waterproofing Your Installation

To waterproof your camera installation, follow the instructions below. Round Ethernet cable, a crimping tool, and RJ-45 plugs are required for this procedure.

### Step 1

Place the washer around the base of the Ethernet connector as shown.

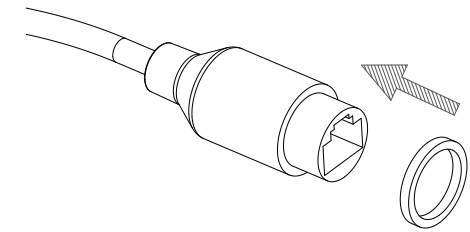

### Step 2

Thread bare Ethernet cable through the waterproof connector as shown, then crimp an RJ-45 plug onto the cable.

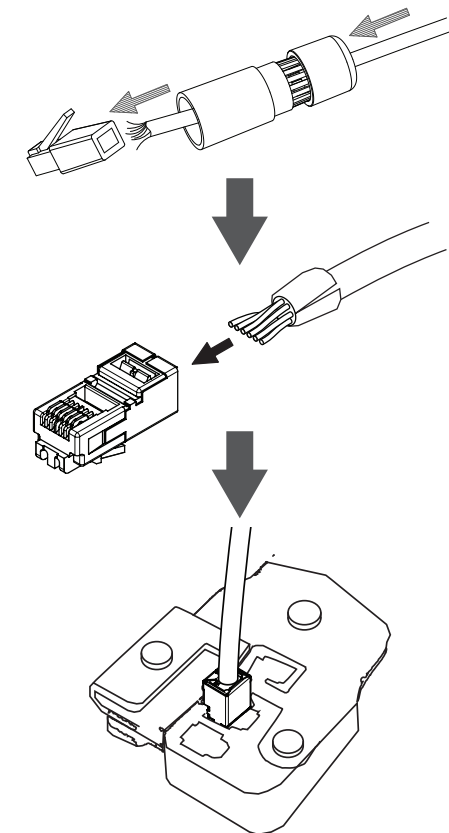

**Step 3**

Connect the RJ-45 plug into the Ethernet connector, then screw the waterproof connector to the Ethernet connector by turning it about a half-turn clockwise.

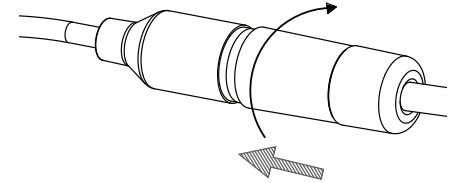
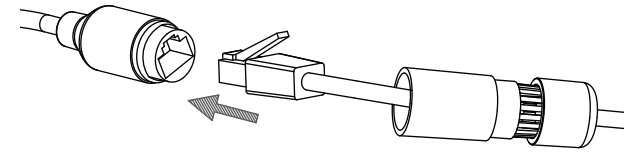

**Step 4**

Screw the back part of the waterproof connector clockwise until there is a tight seal around the Ethernet cable.

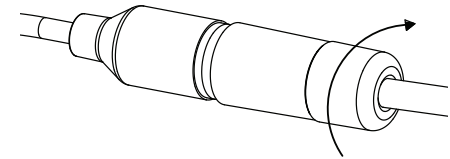

**If you are using PoE to power your camera,** use the included rubber power connector plug to the power connector.

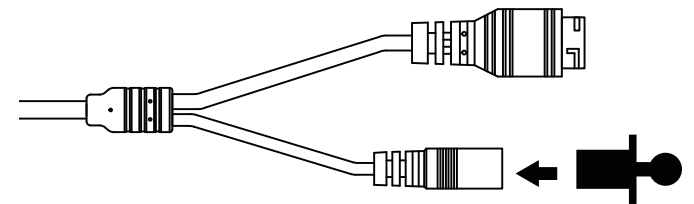

**If you are using a power adapter(not included) to power your camera, wind waterproof tape around the connection in an overlapping manner to cover it.**

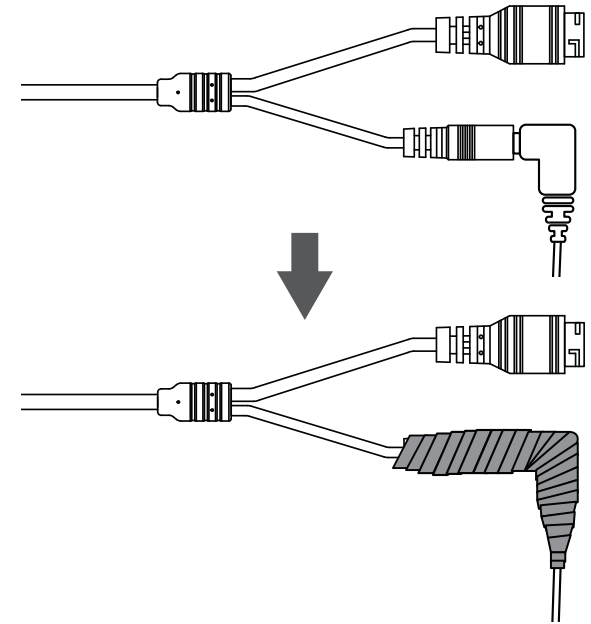

## Software Installation

### Step 1

Insert the DCS-4701E CD into your computer's CD-ROM drive to begin the installation.

If the Autorun function on your computer is disabled, or if the D-Link Launcher fails to start automatically, click the Start button and type **D:\autorun.exe** (where D: represents the drive letter of your CD-ROM drive) and press Enter.



### Step 2

Click on the **D-Link Setup Wizard SE** icon that was created in your Windows Start menu (**Start > D-Link > Setup Wizard SE**).

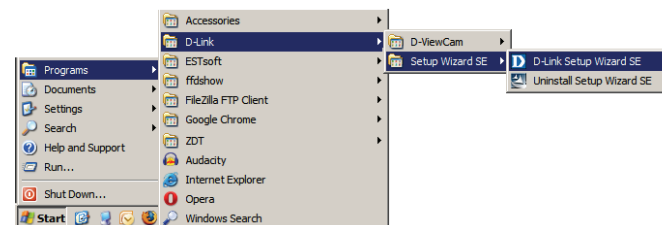

### Step 3

The Setup Wizard will appear and display the MAC address and IP address of your camera(s). If you have a DHCP server on your network, a valid IP Address will be displayed. If your network does not use a DHCP server, the network camera's default static IP **192.168.0.20** will be displayed.

Select your camera, then click the **Wizard** button to continue.

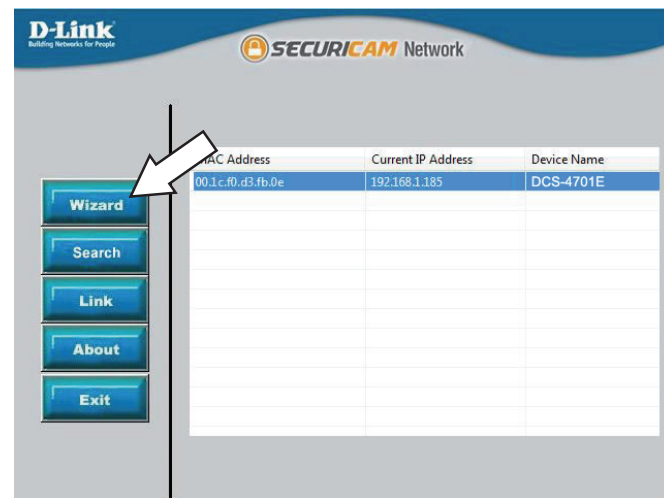

### Step 4

Enter the Admin ID and password. When logging in for the first time, the default Admin ID is **admin** with the password left blank.

Click the checkboxes if you wish to change the admin ID and password for the camera, and enter the new ID and password you wish to use.

Click **Next** to continue.

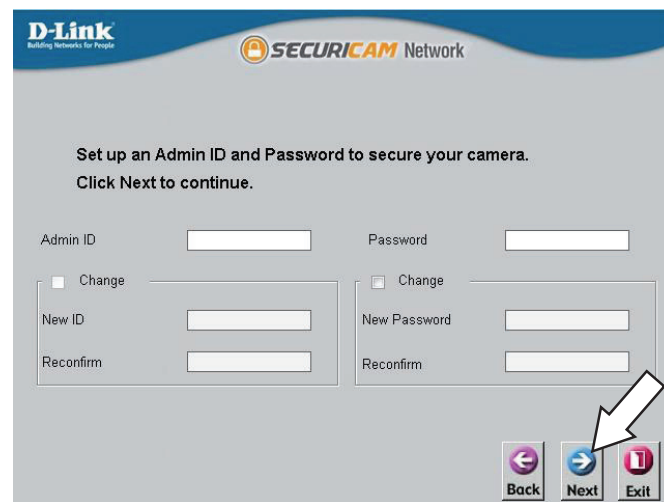

### Step 5

Select **DHCP** if your camera obtains an IP address automatically from a DHCP server such as a router. Select **Static IP** if you want to manually enter the IP settings for the camera.

Click **Next** to continue.

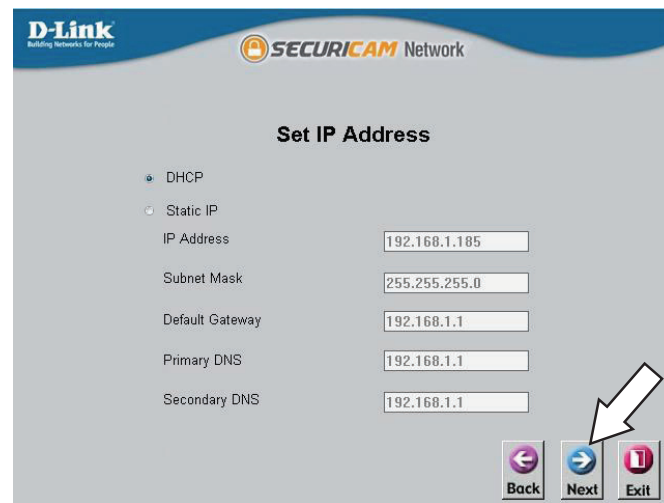

### Step 6

Take a moment to confirm your settings and click **Restart**.

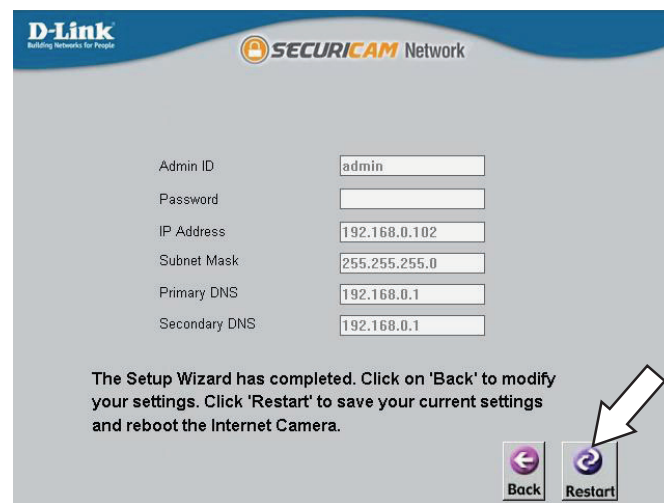

# Configuration

## Using the Configuration Interface

After completing the Camera Installation Wizard, you are ready to use your camera. The camera's built-in Web configuration utility is designed to allow you to easily access and configure your DCS-4701E. At the end of the wizard, click **Link**, or enter the IP address of your camera into a web browser, such as Mozilla Firefox. To log in, use the User name **admin** and the password you created in the Installation Wizard. If you did not create a password, the default password is blank. After entering your password, click **OK**.

### Step 1

Click on the **D-Link Setup Wizard SE** icon that was created in your Windows Start menu (**Start > D-Link > Setup Wizard SE**).

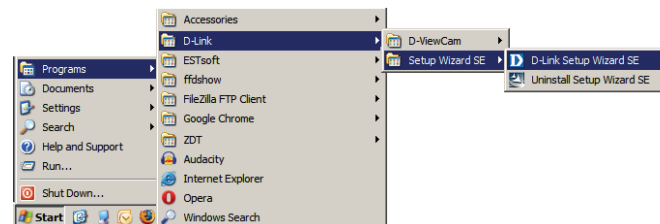

### Step 2

Select the camera and click **Link** to access the web configuration.

The Setup Wizard will automatically open your web browser to the IP address of the camera.

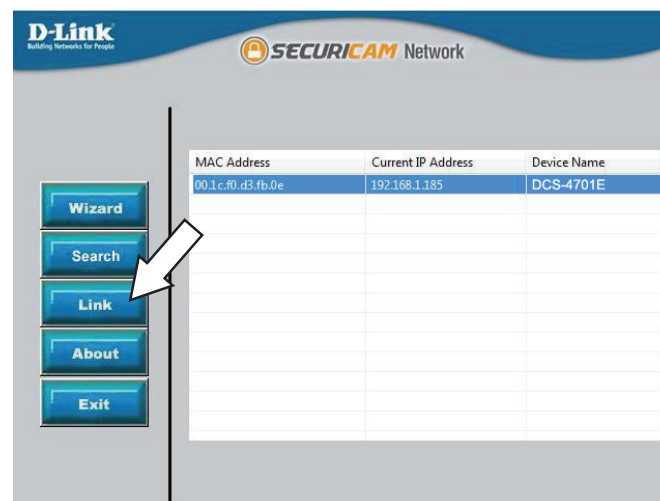

### Step 3

Enter **admin** as the default username and leave the password blank. Click **OK** to continue.



### Step 4



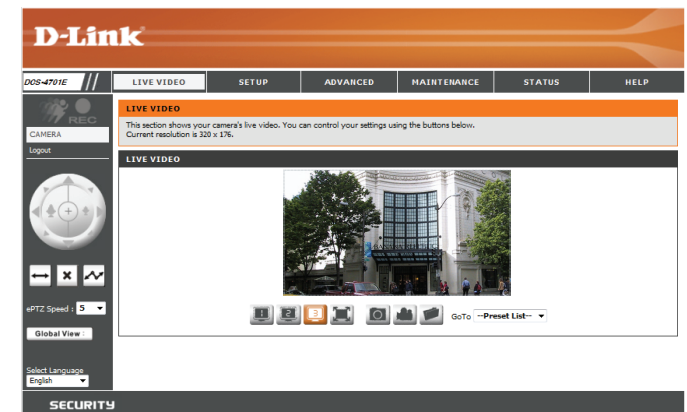



This section displays your camera's live video. You can select your video profile and view or operate the camera.



## Live Video

This section shows your camera's live video. You may select any of the available icons listed below to operate the camera. You may also select your language using the drop-down menu on the left side of the screen.

You can zoom in and out on the live video image using your mouse. Right-click to zoom out or left-click to zoom in on the image.



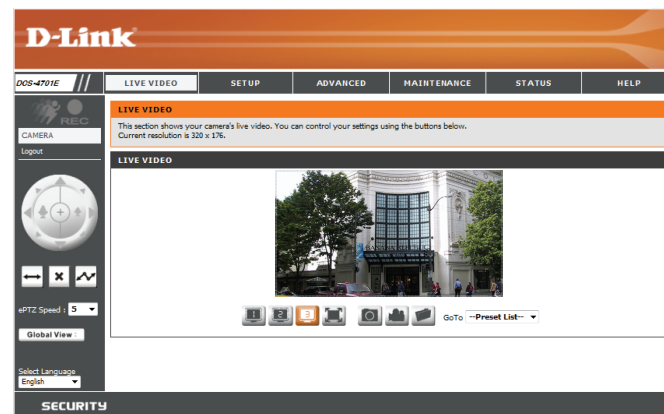



	<b>Motion Trigger Indicator</b>	This indicator will change color when a trigger event occurs.  <b>Note:</b> The video motion feature for your camera must be enabled.
	<b>Recording Indicator</b>	When a recording is in progress, this indicator will change color.
	<b>Control Pad</b>	This control pad can be used to electronically pan, tilt, and zoom (ePTZ) within the camera's predefined view area, if one has been defined.
	<b>Auto Pan</b>	Starts the automatic panning function. The ROI will pan from back and forth within the FOV.
	<b>Stop</b>	Stops the camera ePTZ motion.
	<b>Preset Path</b>	Starts the camera's motion along the predefined path.



**ePTZ Speed:** You may select a value between 0 and 10. 0 is the slowest and 10 is the fastest.

**Global View:** This window indicates the total field of view (FOV) of the camera. The red box indicates the visible region of interest (ROI).

**Language:** You may select the interface language using this menu.

- |   |                  |   |                      |
|---|------------------|---|----------------------|
|  | Video Profile 1  |  | Record a Video Clip  |
|  | Video Profile 2  |  | Set a Storage Folder |
|  | Video Profile 3  |   |                      |
|  | Full screen mode |   |                      |
|  | Take a Snapshot  |   |                      |

**Go To:** If any presets have been defined, you can select them here to move the **(Preset List)** camera to the selected preset.

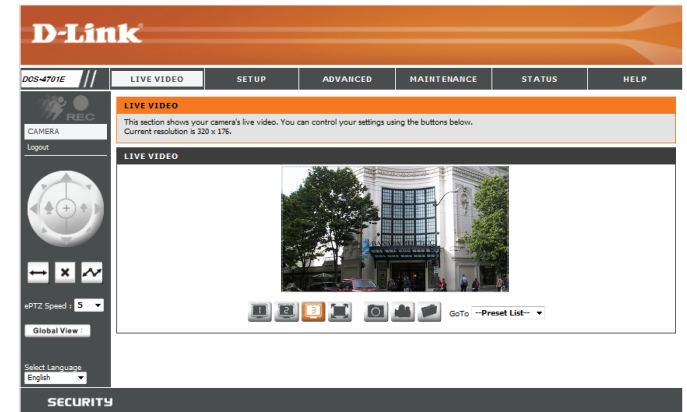

# Setup Setup Wizard

To configure your Network Camera, click **Internet Connection Setup Wizard**. Alternatively, you may click **Manual Internet Connection Setup** to manually configure your Network Camera and skip to "Network Setup" on page 26.

To quickly configure your Network Camera's motion detection settings, click **Motion Detection Setup Wizard**. If you want to enter your settings without running the wizard, click **Manual Motion Detection Setup** and skip to "Motion Detection" on page 36.

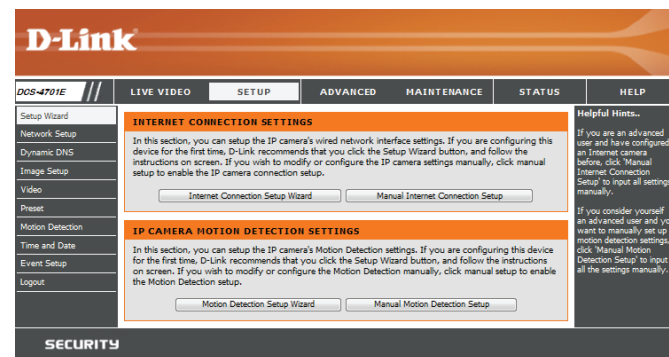

## Internet Connection Setup Wizard

This wizard will guide you through a step-by-step process to configure your new D-Link Camera and connect the camera to the internet. Click **Next** to continue.

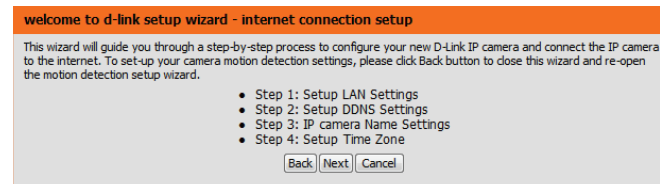

Select how the camera will connect to the Internet.

**If your camera is connected to a router, or you are unsure how your camera will connect to the Internet, select DHCP Connection.**

Select **Static IP** if your Internet Service Provider has provided you with connection settings, or if you wish to set a static address within your home network. Enter the correct configuration information and click **Next** to continue.

If you are using PPPoE, select **Enable PPPoE** and enter your user name and password.

Click **Next** to continue.

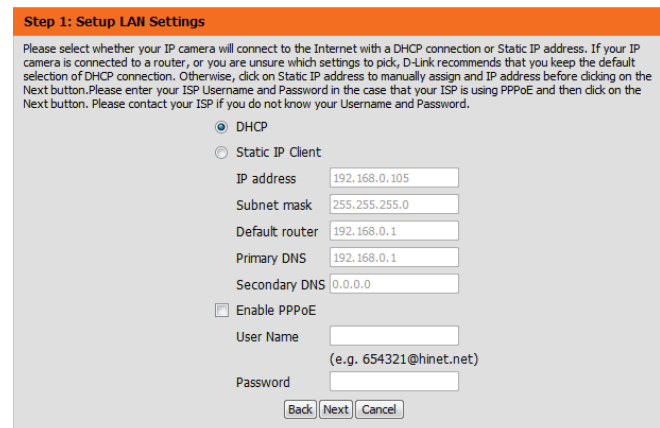

## Section 3: Configuration

If you have a Dynamic DNS account and would like the camera to update your IP address automatically, Select **Enable DDNS** and enter your host information. Click **Next** to continue.

**Step 2: Setup DDNS Settings**

If you have a Dynamic DNS account and would like the IP camera to update your IP address automatically, enable DDNS and enter in your host information below. Please click on the Next button to continue.

Enable DDNS

Server Address  <<

Host Name

User Name

Password

Verify Password

Timeout  (hours)

Enter a name for your camera and click **Next** to continue.

**Step 3: IP camera Name Settings**

D-Link recommends that you rename your IP camera for easy accessibility. You can then identify and connect to your IP camera via this name. Please assign a name of your choice before clicking on the Next button.

IP camera Name

Configure the correct time to ensure that all events will be triggered as scheduled. Click **Next** to continue.

**Step 4: Setup Time Zone**

Please configure the correct time to ensure that all events are triggered, captured and scheduled at the correct time and day and then click on the Next button.

Time Zone

Enable Daylight Saving

If you have selected DHCP, you will see a summary of your settings, including the camera's IP address. Please write down all of this information as you will need it in order to access your camera.

Click **Apply** to save your settings.

**Step 5: Setup complete**

Below is a summary of your IP camera settings. Click on the Back button to review or modify settings or click on the Apply button if all settings are correct. It is recommended to note down these settings in order to access your IP camera on the network or via your web browser.

IP Address	DHCP
IP camera Name	DCS-4701E
Time Zone	(UTC+08:00) Taipei
DDNS	Disable
PPPoE	Disable

## Motion Detection Setup Wizard

This wizard will guide you through a step-by-step process to configure your camera's motion detection functions.

Click **Next** to continue.

### Step 1

This step will allow you to enable or disable motion detection, specify the detection sensitivity, and adjust the camera's ability to detect movement.

You may specify whether the camera should capture a snapshot or a video clip when motion is detected.

Refer to "Motion Detection" on page 36 for information about how to configure motion detection.

### Step 2

This step allows you to enable motion detection based on a customized schedule. Specify the day and hours. You may also choose to always record whenever motion is detected.

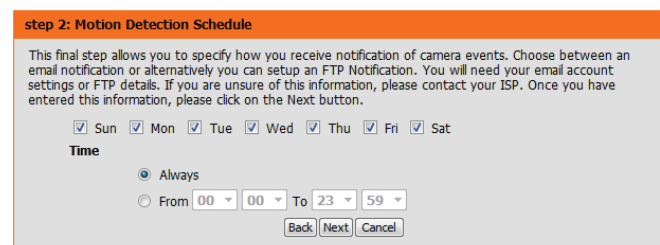
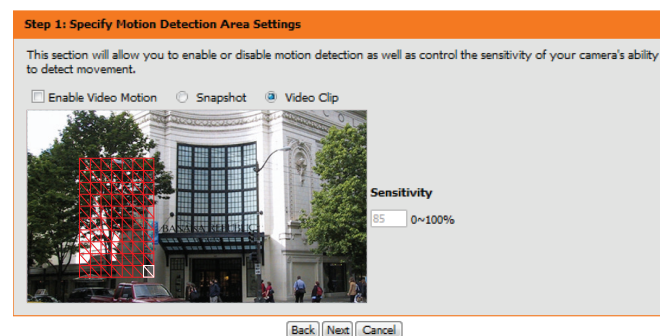
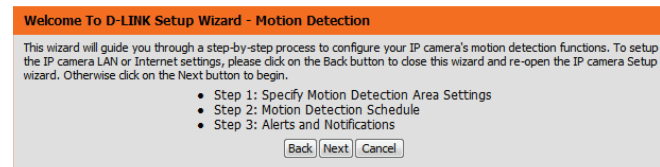

## Section 3: Configuration

### Step 3

This step allows you to specify how you will receive event notifications from your camera. You may choose not to receive notifications, or to receive notifications via e-mail or FTP.

Please enter the relevant information for your e-mail or FTP account.

Click **Next** to continue.

**Step 3: Alerts and Notification**

This final step allows you to specify how you receive notification of camera events. Choose between an email notification or alternatively you can setup an FTP Notification. You will need your email account settings or FTP details. If you are unsure of this information, please contact your ISP. Once you have entered this information, please click on the Next button.

Do not notify me

Email

Sender email address

Recipient email address

Server address

User name

Password

Port

This server requires a secure connection (StartTLS)

FTP

Server address

Port

User name

Password

Remote folder name

### Step 4

You have completed the Motion Detection Wizard.

Please verify your settings and click **Apply** to save them.

**Step 4: Setup Complete**

You have completed your IP camera setup. Please click the Back button if you want to review or modify your settings or click on the Apply button to save and apply your settings.

Motion Detection : Enable

EVENT : Video Clip

Schedule Day : Sun , Mon , Tue , Wed , Thu , Fri , Sat ,

Schedule Time : Always

Alerts and Notification : Email

Please wait a few moments while the camera saves your settings and restarts.

**Step 4: Setup Complete**

You have completed your IP camera setup. Please click the Back button if you want to review or modify your settings or click on the Apply button to save and apply your settings.

Changes saved. IP camera's network is restarting, please wait for 6 seconds ...

# Network Setup

Use this section to configure the network connections for your camera. All relevant information must be entered accurately. After making any changes, click the **Save Settings** button to save your changes.

**LAN Settings:** This section lets you configure settings for your local area network.

**DHCP:** Select this connection if you have a DHCP server running on your network and would like your camera to obtain an IP address automatically.

If you choose DHCP, you do not need to fill out the IP address settings.

**Static IP Client:** You may obtain a static or fixed IP address and other network information from your network administrator for your camera. A static IP address may simplify access to your camera in the future.

**IP Address:** Enter the fixed IP address in this field.

**Subnet Mask:** This number is used to determine if the destination is in the same subnet. The default value is 255.255.255.0.

**Default Gateway:** The gateway used to forward frames to destinations in a different subnet. Invalid gateway settings may cause the failure of transmissions to a different subnet.

**Primary DNS:** The primary domain name server translates names to IP addresses.

**Secondary DNS:** The secondary DNS acts as a backup to the primary DNS.

**D-Link**

DCS-4701E // LIVE VIDEO SETUP ADVANCED MAINTENANCE STATUS HELP

Setup Wizard  
Network Setup  
Dynamic DNS  
Image Setup  
Video  
Preset  
Motion Detection  
Time and Date  
Event Setup  
Logout

**NETWORK SETUP**  
You can configure your LAN and Internet settings here.  
Save Settings Don't Save Settings

**LAN SETTINGS**

DHCP  
 Static IP Client

IP address: 192.168.0.101  
Subnet mask: 255.255.255.0  
Default router: 192.168.0.1  
Primary DNS: 192.168.0.1  
Secondary DNS: 0.0.0.0

Enable UPnP presentation  
 Enable UPnP port forwarding  
Forwarding Port: 1024 [Edit]  
Forwarding Status: UPnP forwarding is inactive

**PPPOE SETTINGS**

Enable  Disable  
User Name:   
Password:   
Confirm password:   
PPPOE Status: PPPOE is inactive.

**HTTP**

HTTP port: 80  
Access name for stream1: video1.mjpg  
Access name for stream2: video2.mjpg  
Access name for stream3: video3.mjpg

**HTTPS**

HTTPS port: 443

**RTSP**

Authentication: Digest  
RTSP port: 554  
Access name for stream1: live1.sdp  
Access name for stream2: live2.sdp  
Access name for stream3: live3.sdp

**CoS SETTINGS**

Enable CoS  
VLAN ID: 1 [0-4095]  
Live video: 0  
Live audio: 0  
Event/Alarm: 0  
Management: 0

**QoS SETTINGS**

Enable QoS  
Live video: 0  
Live audio: 0  
Event/Alarm: 0  
Management: 0

**Helpful Hints...**

Select DHCP Connection if you are running a DHCP server on your network and would like an IP address assigned to your IP camera automatically.

UPnP: Enabling UPnP settings will allow you to configure your IP camera as an UPnP device in the network.

PPPOE Settings: If you use the IP camera to connect directly to the Internet, you will need to enter the username and password, which were given to you when you set up your account with your Internet Service Provider. If the camera is behind a router or a gateway, you do not need to configure this setting.

HTTP: HTTP Port is the port you allocate in order to connect to the IP camera via a standard web browser.

HTTPS: HTTPS Port in a IP camera connects it with a PC via a secure web browser.

RTSP: RTSP Port is the port you allocate in order to connect to a IP camera by using streaming module device(s), such as a mobile phone or PDA.

CoS (Class of Service): Coarsely-grained traffic control based on the L2 protocol. Class of Service technologies do not guarantee a level of service in terms of bandwidth and delivery time, they offer a "best-effort".

QoS (Quality of Service): Finely-grained traffic control, a resource reservation control mechanism. Quality of service guarantees are important if the network capacity is insufficient, especially for real-time streaming multimedia applications.

Enable IPv6: Select this option and click Save to enable IPv6 setting. Please note that this only works if your network environment and hardware equipment support IPv6. The browser should be Microsoft's Internet Explorer 6.5, Mozilla Firefox 3.0 or above. When IPv6 is enabled, by default, the Network Camera will be listed to router advertisements and be assigned a link-local IPv6 address accordingly.

IPv6 Information: Click this button to obtain the IPv6 information. If your IPv6 setting was successful, the IPv6 address list will be listed in the pop-up window. Please follow the steps below to link to an IPv6.

**Enable UPnP Presentation:** Enabling this setting allows your camera to be configured as a UPnP device on your network.

**Enable UPnP Port Forwarding:** Enabling this setting allows the camera to add port forwarding entries into the router automatically on a UPnP capable network.

**Enable PPPoE:** Enable this setting if your network uses PPPoE.

**User Name / Password:** Enter the username and password for your PPPoE account. Re-enter your password in the Confirm Password field. You may obtain this information from your ISP.

**HTTP Port:** The default port number is 80.

**Access Name for Stream 1~3:** The default name is video#.mjpg, where # is the number of the stream.

**HTTPS Port:** You may use a PC with a secure browser to connect to the HTTPS port of the camera. The default port number is 443.

**Authentication:** Choose to enable or disable RTSP digest encryption. Digest encryption uses MD5 hashes.

**RTSP Port:** The port number that you use for RTSP streaming to mobile devices, such as mobile phones or PDAs. The default port number is 554. You may specify the address of a particular stream. For instance, live1.sdp can be accessed at rtsp://x.x.x.x/video1.sdp where the x.x.x.x represents the IP address of your camera.

**Enable CoS:** Enabling the Class of Service setting implements a best-effort policy without making any bandwidth reservations.

**LAN SETTINGS**

DHCP  
 Static IP Client

IP address: 192.168.0.101  
 Subnet mask: 255.255.255.0  
 Default router: 192.168.0.1  
 Primary DNS: 192.168.0.1  
 Secondary DNS: 0.0.0.0

Enable UPnP presentation  
 Enable UPnP port forwarding

Forwarding Port: 1024 [Test]  
 Forwarding Status: UPnP forwarding is inactive

**PPPOE SETTINGS**

Enable  Disable

User Name:   
 Password:   
 Confirm password:   
 PPPoE Status: PPPoE is inactive.

**HTTP**

HTTP port: 80  
 Access name for stream1: video1.mjpg  
 Access name for stream2: video2.mjpg  
 Access name for stream3: video3.mjpg

**HTTPS**

HTTPS port: 443

**RTSP**

Authentication: Digest  
 RTSP port: 554  
 Access name for stream1: live1.sdp  
 Access name for stream2: live2.sdp  
 Access name for stream3: live3.sdp

**COS SETTINGS**

Enable CoS

VLAN ID: 1 [0~4095]  
 Live video: 0  
 Live audio: 0  
 Event/Alarm: 0  
 Management: 0

**QoS SETTINGS**

Enable QoS

Live video: 0  
 Live audio: 0  
 Event/Alarm: 0  
 Management: 0

**Enable QoS:** Enabling QoS allows you to specify a traffic priority policy to ensure a consistent Quality of Service during busy periods. If the Network Camera is connected to a router that itself implements QoS, the router's settings will override the QoS settings of the camera.

**Enable IPv6:** Enabling this setting will enable use of the IPv6 protocol. Click the IPv6 Information button to see the camera's current IPv6 details, or you can check **Manually setup the IP address** to manually set up the IP address, specify a default router, and set the primary DNS.

**Enable Multicast for stream:** The DCS-4701E allows you to multicast each of the available streams via group address and specify the TTL value for each stream. Enter the port and TTL settings you wish to use if you do not want to use the defaults.

**Enable Bonjour:** Enable this to allow other network devices to connect to this camera using Bonjour.

**Bonjour Name:** Enter the name to identify this camera on Bonjour.

**QoS SETTINGS**

Enable QoS
 

Live video	0	▼
Live audio	0	▼
Event/Alarm	0	▼
Management	0	▼

---

**IPv6**

Enable IPv6  

Manually setup the IP address

Optional IP address / Prefix length:  / 64

Optional default router:

Optional primary DNS:

---

**MULTICAST**

Enable multicast for stream 1
 

Multicast group address	<input type="text" value="239.1.1.1"/>
Multicast video port	<input type="text" value="6550"/>
Multicast RTCP video port	<input type="text" value="6551"/>
Multicast audio port	<input type="text" value="6552"/>
Multicast RTCP audio port	<input type="text" value="6553"/>
Multicast TTL [1~255]	<input type="text" value="64"/>

Enable multicast for stream 2

Multicast group address	<input type="text" value="239.1.1.2"/>
Multicast video port	<input type="text" value="6554"/>
Multicast RTCP video port	<input type="text" value="6555"/>
Multicast audio port	<input type="text" value="6556"/>
Multicast RTCP audio port	<input type="text" value="6557"/>
Multicast TTL [1~255]	<input type="text" value="64"/>

Enable multicast for stream 3

Multicast group address	<input type="text" value="239.1.1.3"/>
Multicast video port	<input type="text" value="6558"/>
Multicast RTCP video port	<input type="text" value="6559"/>
Multicast audio port	<input type="text" value="6560"/>
Multicast RTCP audio port	<input type="text" value="6561"/>
Multicast TTL [1~255]	<input type="text" value="64"/>

---

**BONJOUR SETTINGS**

Enable Bonjour
 

Bonjour Name:  32 characters maximum

(Characters you may use in a Bonjour Name: "upper or lower case letters", "numbers" and "hyphens".)

## Dynamic DNS

DDNS allows you to access your camera using a domain name instead of an IP address. To do this, you will need to have an account with one of the DDNS services listed in the drop-down box on this page.

**Enable DDNS:** Select this checkbox to enable the DDNS function.

**Server Address:** Select your Dynamic DNS provider from the pull down menu or enter the server address manually.

**Host Name:** Enter the host name of the DDNS server.

**User Name:** Enter the user name or e-mail used to connect to your DDNS account.

**Password:** Enter the password used to connect to your DDNS server account.

**Timeout:** Enter the DNS timeout values you wish to use.

**Status:** Indicates the connection status, which is automatically determined by the system.

The screenshot shows the D-Link web interface for the DCS-4701E camera. The top navigation bar includes 'LIVE VIDEO', 'SETUP', 'ADVANCED', 'MAINTENANCE', 'STATUS', and 'HELP'. The left sidebar lists various setup options: Setup Wizard, Network Setup, Dynamic DNS, Image Setup, Video, Preset, Motion Detection, Time and Date, Event Setup, and Logout. The main content area is titled 'DYNAMIC DNS' and contains the following text:

The Dynamic DNS feature allows you to use a domain name that you have purchased (www.yourdomain.com) to access your IP camera with a dynamically assigned IP address. Most broadband Internet service providers assign dynamic (changing) IP addresses. By using a DDNS service, you can enter your domain name to connect to your IP camera no matter what your IP address is.

[Sign up for D-Link's Free DDNS service at www.DLinkDDNS.com.](http://www.dlinkddns.com)

Buttons: Save Settings, Don't Save Settings

**DYNAMIC DNS SETTING**

Enable DDNS:

Server Address:  <<

Host Name:

User Name:

Password:

Verify Password:

Timeout:  (hours)

Status: Inactive

Buttons: Save Settings, Don't Save Settings

At the bottom of the page, the word 'SECURITY' is visible.

## Image Setup

In this section, you may configure the video image settings for your camera. A preview of the image will be shown in Live Video.

**Enable Privacy Mask:** The Privacy Mask setting allows you to specify up to 3 rectangular areas on the camera's image to be blocked/excluded from recordings and snapshots.

You may click and drag the mouse cursor over the camera image to draw a mask area. Right clicking on the camera image brings up the following menu options:

- **Disable All:** Disables all mask areas
- **Enable All:** Enables all mask areas
- **Reset All:** Clears all mask areas.

**Mirror:** This will mirror the image horizontally.

**Flip:** This will flip the image vertically. When turning Flip on, you may want to consider turning Mirror on as well.

**Anti Flicker:** Select the frequency used by your power lines to avoid interference or distortion.

**White Balance:** Use the drop-down box to change white balance settings to help balance colors for different environments. You can choose from Auto, Outdoor, Indoor, Fluorescent, and Push Hold.

**Exposure Mode:** Changes the exposure mode. Use the drop-down box to set the camera for Indoor, Outdoor, or Night environments, or to Moving to capture moving objects. The Low Noise option will focus on creating a high-quality picture without noise. You can also create 3 different custom exposure modes. The Max Gain setting will allow you to control the maximum amount of gain to apply to brighten the picture.

**Denoise:** This setting controls the amount of noise reduction that will be applied to the picture.

**Brightness:** Adjust this setting to compensate for backlit subjects.

**Contrast:** Adjust this setting to alter the color intensity/strength.

**Saturation:** This setting controls the amount of coloration, from grayscale to fully saturated.

**Sharpness:** Specify a value from 0 to 8 to specify how much sharpening to apply to the image.

**WDR Level:** WDR makes it easier to see objects that may appear dark due to strong backlighting conditions during the daytime. Higher WDR levels will make it easier to see objects in shadows.

**3D Filter:** 3D filtering reduces the amount of image noise when viewing a low-light environment. Higher levels of 3D filtering will apply stronger levels of noise reduction.

**Reset Default:** Click this button to reset the image to factory default settings.

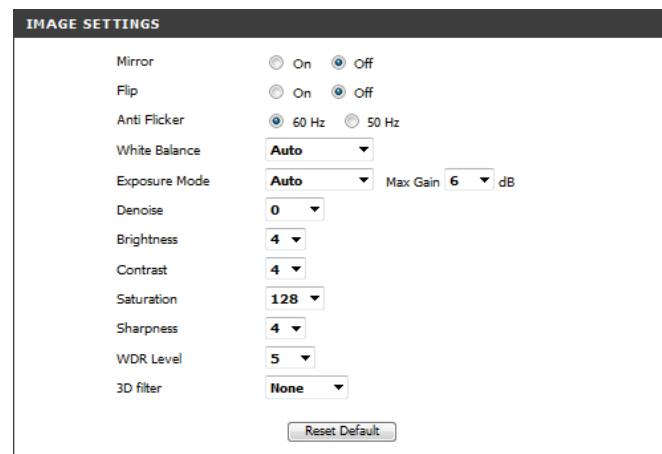

## Video

You may configure up to 3 video profiles with different settings for your camera. Hence, you may set up different profiles for your computer and mobile display. After making any changes, click the **Save Settings** button to save your changes.

**Aspect ratio:** Set the aspect ratio of the video to 4:3 standard or 16:9 widescreen.

**Mode:** Set the video codec to be used to JPEG, MPEG-4, or H.264.

**Frame size / View window area:** Frame size determines the total capture resolution, and View window area determines the Live Video viewing window size. If the Frame size is larger than the Live Video size, you can use the ePTZ controls to look around.

16:9	1280 x 720, 800 x 448, 640 x 360, 480 x 272, 320 x 176 up to 30 fps
4:3	960 x 720, 800 x 592, 640 x 480, 320 x 240 up to 30 fps

**Note:** If your View window area is the same as your Frame size, you will not be able to use the ePTZ function.

**Maximum frame rate:** A higher frame rate provides smoother motion for videos, and requires more bandwidth. Lower frame rates will result in stuttering motion, and requires less bandwidth.

**Video Quality:** This limits the maximum frame rate, which can be combined with the "Fixed quality" option to optimize

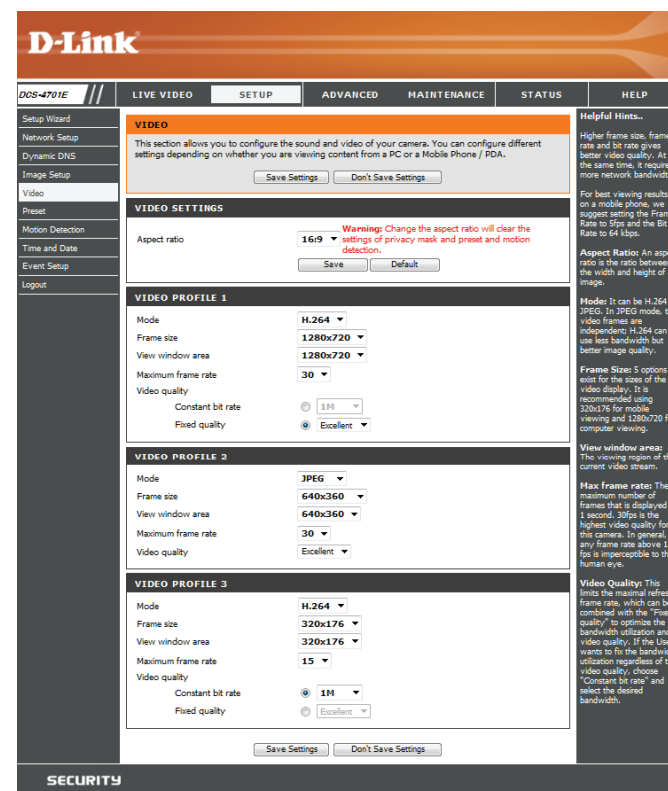

the bandwidth utilization and video quality. If fixed bandwidth utilization is desired regardless of the video quality, choose "Constant bit rate" and select the desired bandwidth.

**Constant bit rate:** The bps will affect the bit rate of the video recorded by the camera. Higher bit rates result in higher video quality.

**Fixed quality:** Select the image quality level for the camera to try to maintain. High quality levels will result in increased bit rates.

The screenshot displays a configuration interface for video profiles, organized into three sections: VIDEO PROFILE 1, VIDEO PROFILE 2, and VIDEO PROFILE 3. Each profile has a set of controls for Mode, Frame size, View window area, Maximum frame rate, and Video quality. The Video quality section includes radio buttons for Constant bit rate and Fixed quality, along with a dropdown menu for the selected option.

Profile	Mode	Frame size	View window area	Maximum frame rate	Video quality
VIDEO PROFILE 1	H.264	1280x720	1280x720	30	Constant bit rate (selected), 1M; Fixed quality, Excellent
VIDEO PROFILE 2	JPEG	640x360	640x360	30	Excellent
VIDEO PROFILE 3	H.264	320x176	320x176	15	Constant bit rate (selected), 1M; Fixed quality, Excellent

At the bottom of the interface, there are two buttons: "Save Settings" and "Don't Save Settings".

## Preset

This screen allows you to set preset points for the ePTZ function of the camera, which allows you to look around the camera's viewable area by using a zoomed view. Presets allow you to quickly go to and view a specific part of the area your camera is covering, and you can create preset sequences, which will automatically change the camera's view between the different presets according to a defined order and timing you can set.

**Note:** If your View window area is the same as your Frame size, you will not be able to use the ePTZ function.

**Video Profile:** This selects which video profile to use.

**ePTZ Speed:** You may select a value between 0 and 10. 0 is the slowest and 10 is the fastest.

**Arrow Buttons and Home Button:** Use these buttons to move to a specific part of the viewing area, which you can then set as a preset. Click the Home button to return to the center of the viewing area.

**Input Preset Name:** Enter the name of the preset you want to create, then click the **Add** button to make a new preset. If an existing preset has been selected from the Preset List, you can change its name by typing in a new name, then clicking the **Rename** button.

**Preset List:** Click this drop-down box to see a list of all the presets that have been created. You can select one, then click the **GoTo** button to change the displayed camera view to the preset. Clicking the **Remove** button will delete the currently selected preset.

**Preset Sequence:** This section allows you to create a preset sequence, which automatically moves the camera's view between a set of preset views.



**Preset List:** To add a preset to the sequence, select it from the drop-down box at the bottom of this window, set the **Dwell time** to determine how long the camera view will stay at that preset, then click the **Add** button. The preset name will appear in the list, followed by the dwell time to view that preset for.

You can rearrange your presets in the sequence by selecting a preset in the sequence, then clicking the arrow buttons to move it higher or lower in the current sequence.

Clicking the trash can button will remove the currently selected preset from the sequence.

If you want to change the dwell time for a preset, select it from the list, enter a new dwell time, then click the **Update** button.

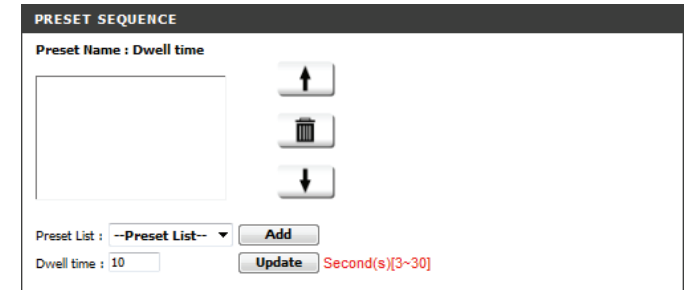

The screenshot shows a window titled "PRESET SEQUENCE". At the top, it says "Preset Name : Dwell time". Below this is a large empty rectangular box. To the right of this box are three vertically stacked buttons: an up arrow, a trash can, and a down arrow. At the bottom of the window, there is a "Preset List" dropdown menu currently showing "--Preset List--", an "Add" button, a "Dwell time" input field with the value "10", and an "Update" button. To the right of the "Update" button, the text "Second(s)[3~30]" is displayed in red.

## Motion Detection

Motion detection enables the camera to monitor the video feed for movement. Here, you can adjust the sensitivity settings that determine whether motion is detected by the camera or not. After making any changes, click the **Save Settings** button to save your changes.

**Enable Video Motion:** Select this box to enable the motion detection feature of your camera.

**Sensitivity:** Specifies how sensitive motion detection will be from 0% to 100%. A low sensitivity setting means that there must be large changes between two images in order to detect motion, and a high sensitivity setting means that even small changes will cause motion to be detected.

**Draw Motion Area:** Use your mouse to click and drag on the areas that you would like to monitor for motion.

**Erase Motion Area:** To erase a motion detection area, simply click on the red square that you wish to remove.

Right click on the camera image to bring up the following menu options:

**Select All:** Draws a motion detection area over the entire screen.

**Clear All:** Clears any motion detection areas that have been drawn.

**Restore:** Restores the previously specified motion detection areas.

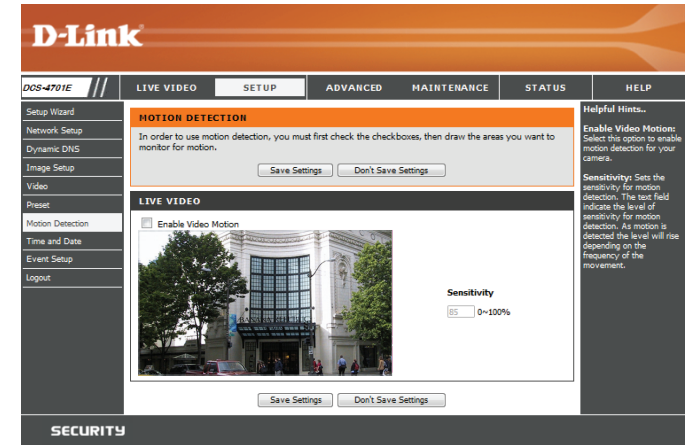

## Time and Date

This section allows you to automatically or manually configure, update, and maintain the internal system clock for your camera. After making any changes, click the **Save Settings** button to save your changes.

**Time Zone:** Select your time zone from the drop-down menu.

**Enable Daylight Saving:** Select this to enable Daylight Saving Time.

**Auto Daylight Saving:** Select this option to allow your camera to configure the Daylight Saving settings automatically.

**Set Date and Time Manually:** Selecting this option allows you to configure the Daylight Saving date and time manually.

**Offset:** Sets the amount of time to be added or removed when Daylight Saving is enabled.

**Synchronize with NTP Server:** Enable this feature to obtain time automatically from an NTP server.

**NTP Server:** Network Time Protocol (NTP) synchronizes the DCS-4701E with an Internet time server. Choose the one that is closest to your location.

**Set the Date and Time Manually:** This option allows you to set the time and date manually.

**Copy Your Computer's Time Settings:** This will synchronize the time information from your PC.



## Event Setup

In a typical application, when motion is detected, the DCS-4701E sends images to a FTP server or via e-mail as notifications. As shown in the illustration below, an event can be triggered by many sources, such as motion detection. When an event is triggered, a specified action will be performed. You can configure the Network Camera to send snapshots or videos to your e-mail address or FTP site.

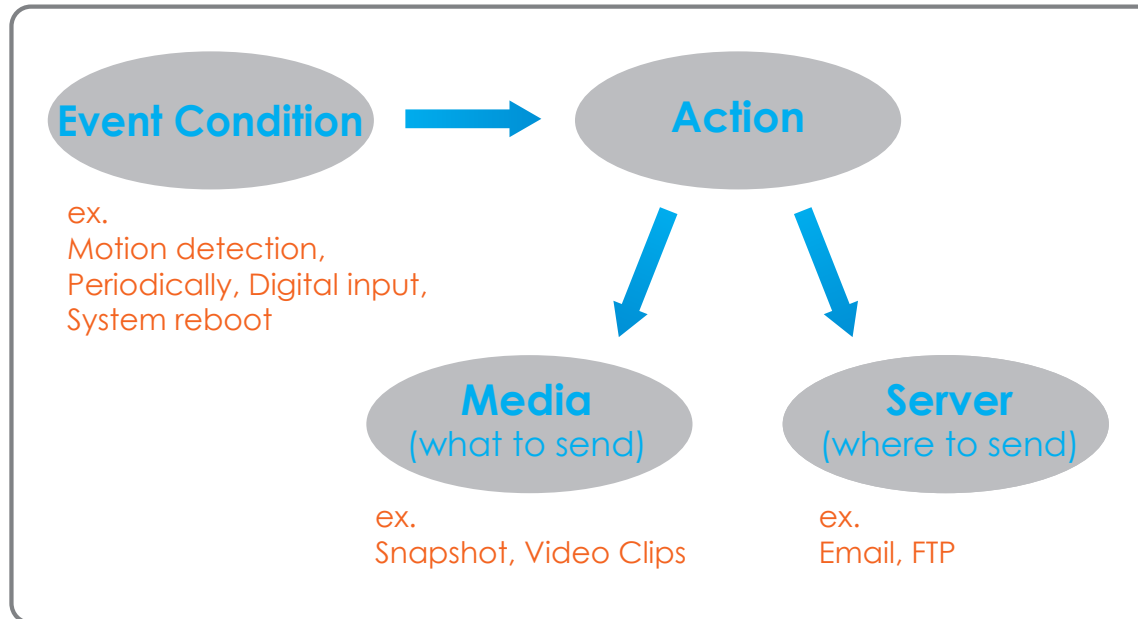

To start plotting an event, it is suggested to configure server and media columns first so that the Network Camera will know what action shall be performed when a trigger is activated.

The Event Setup page includes 4 different sections.

- Event
- Server
- Media
- Recording

1. To add a new item server, media, event, or recording item click **Add**. A screen will appear and allow you to update the fields accordingly.
2. To delete the selected item from the server, media, event, or recording drop-down menus, click the **Delete** button next to it.
3. Click on an item to edit it.

### Add Server

You can configure up to 5 servers to save snapshots and/or video to. After making any changes, click the **Save Settings** button to save your changes.

**Server Name:** Enter the unique name of your server.

**E-mail:** Enter the configuration for the target e-mail server account.

**FTP:** Enter the configuration for the target FTP server account.

**Network Storage:** Specify a network storage device. Only one network storage device is supported.



## Add Media

There are three types of media: **Snapshot**, **Video Clip**, and **System Log**. After making any changes, click the **Save Settings** button to save your changes.

**Media Name:** Enter a unique name for media type you want to create.

**Snapshot:** Select this option to set the media type to snapshots.

**Source:** Set the video profile to use as the media source. Refer to "Video" on page 32 for more information on video profiles.

**Send pre-event image(s) [0~4]:** Set the number of pre-event images to take. Pre-event images are images taken before the main event snapshot is taken.

**Send post-event image(s) [0~7]:** Set the number of post-event images to take. Post-event images are images taken after the main event snapshot is taken. You can set up to 7 post-event images to be taken.

For example:

If both the Send pre-event images and Send post-event images are set to four, a total of 9 images are generated after a trigger is activated.

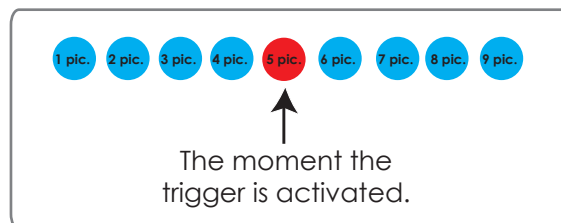

**File name prefix:** The prefix name will be added to the file name.

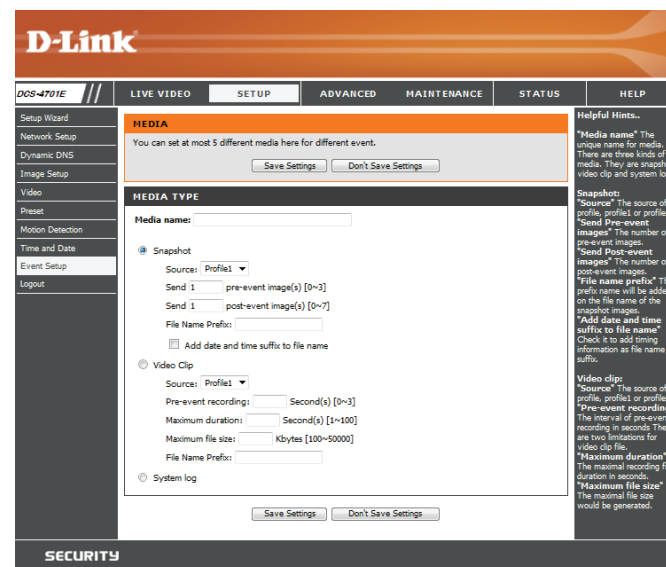

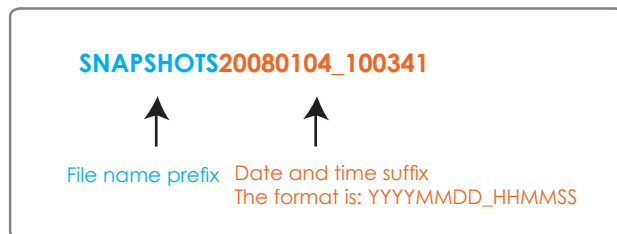

**Add date and time suffix to file name:** Check this to add the date and time the snapshot was recorded as a file name suffix.

**Video clip:** Select this option to set the media type to video clips.

**Source:** Set the video profile to use as the media source. Refer to "Video" on page 32 for more information on video profiles.

**Pre-event recording:** This sets how many seconds to record before the main event video clip starts. You can record up to 4 seconds of pre-event video.

**Maximum duration:** Set the maximum length of video to record for your video clips.

**Maximum file size:** Set the maximum file size to record for your video clips.

**File Name Prefix:** This is the prefix that will be added to the filename of saved video clips.

**System log:** Select this option to set the media type to system logs. This will save the event to the camera system log, but will not record any snapshots or video.

**MEDIA TYPE**

Media name:

Snapshot

Source: Profile1

Send 1  pre-event image(s) [0~3]

Send 1  post-event image(s) [0~7]

File Name Prefix:

Add date and time suffix to file name

Video Clip

Source: Profile1

Pre-event recording:  Second(s) [0~3]

Maximum duration:  Second(s) [1~100]

Maximum file size:  Kbytes [100~50000]

File Name Prefix:

System log

Save Settings Don't Save Settings

## Add Event

Create and schedule up to 3 events with their own settings here. After making any changes, click the **Save Settings** button to save your changes.

**Event name:** Enter a name for the event.

**Enable this event:** Select this box to activate this event.

**Priority:** Set the priority for this event. The event with higher priority will be executed first.

**Delay:** Select the delay time before checking the next event. It is being used for both events of motion detection and digital input trigger.

**Trigger:** Specify the input type that triggers the event.

**Video Motion Detection:** Motion is detected during live video monitoring. Select the windows that need to be monitored.

**Periodic:** The event is triggered in specified intervals. The trigger interval unit is in minutes.

**System Boot:** Triggers an event when the system boots up.

**Network Lost:** Triggers an event when the network connection is lost.

**Time:** Select **Always** or enter the time interval to monitor for the specified kind of event.

**Action:** If you have created Server and Media entries, you will see them appear here. Select which Server you want to send to and which Media you want the camera to send.

**D-Link**

DCS-4701E // LIVE VIDEO SETUP ADVANCED MAINTENANCE STATUS HELP

**EVENT**

You can set at most 2 events like motion detection or digital input trigger here and arrange the detection schedule at the same time.

Save Settings Don't Save Settings

**EVENT**

Event name:

Enable this event

Priority: normal

Delay for: 10 seconds before detecting next event [For motion detection]

**TRIGGER**

Video motion detection

Periodic

Trigger every 1 minutes

System boot

Network lost

**EVENT SCHEDULE**

Sun  Mon  Tue  Wed  Thu  Fri  Sat

Time

Always

From 00:00 To 23:59

**ACTION**

Save to e-mail

Attached media: Save snapshot

Save Settings Don't Save Settings

**Helpful Hints...**

**Priority:** The event with higher priority will be executed first.

There are five kinds of trigger supported.

**Video motion detection:** Select the windows which need to be monitored.

**Periodic:** The event is triggered in specified intervals. The unit of trigger interval is minute.

**System boot:** The event is triggered when the system boot up.

**Network lost:** The event is triggered when the network service is not available or disconnection.

Sun ~ Sat: Select the days of the week to perform the event.

Times show "Always" or input the time interval.

Note: Please Format SD card before use. The entire data in the SD card will be erased after formatting.

**SECURITY**

## Add Recording

Here you can configure and schedule the recording settings. After making any changes, click the **Save Settings** button to save your changes.

**Recording entry name:** Enter a name for the recording.

**Enable this recording:** Select this to enable the recording function.

**Priority:** Set the priority for this entry. An entry with a higher priority value will be executed first.

**Source:** Select the video profile to use as the recording source.

**Recording schedule:** Use the checkboxes to set which days to record video on. Select **Always** to record for the entire day, or select **From** and select what period of time you want to record using the dropdown boxes.

**Destination:** Select the folder where the recording file will be stored.

**Total cycling recording size:** Please input a HDD volume between 1MB and 2TB for recording space. The recording data will replace the oldest record when the total recording size exceeds this value. For example, if each recording file is 6MB, and the total cyclical recording size is 600MB, then the camera will record 100 files in the specified location (folder) and then will delete the oldest file and create new file for cyclical recording.

Please note that if the free HDD space is not enough, the recording will stop. Before you set up this option please make sure your HDD has enough space, and it is better to not save other files in the same folder as recording files.

**D-Link**

DCS-4701E // LIVE VIDEO SETUP ADVANCED MAINTENANCE STATUS HELP

**RECORDING**

You can setup schedule recording to network storage with your specify week day and time period.

Save Settings Don't Save Settings

**RECORDING**

Recording entry name:

Enable this recording

Priority: normal

Source: Profile 1

**RECORDING SCHEDULE**

Sun  Mon  Tue  Wed  Thu  Fri  Sat

**Time**

Always

From  :  To  :

**RECORDING SETTINGS**

Destination: None

Total cycling recording size: 1000 Mbytes [200~2000000]

Size of each file for recording: 10 Mbytes

Time of each file for recording: 1.0 seconds

File Name Prefix:

Save Settings Don't Save Settings

**Helpful Hints...**

**Recording:** Enable this option if you want to upload the recording to a shared folder on the network.

**Recording schedule:** Select the day(s) according to when you want the IP camera to make a video clip.

**Always:** This enables the IP camera to make video clips continuously.

**From:** The time range specified for the video clip.

**Total cycling recording size:** Please enter the maximum amount of storage that can be used for recording on the media. Files will be written to storage cyclically (eg. oldest files will be overwritten if necessary) so that the total recording size does not exceed this value.

**Note:** Please Format SD card before use. The entire data in the SD card will be erased after formatting.

**SECURITY**

**Size of each file for recording:** If this is selected, files will be separated based on the file size you specify.

**Time of each file for recording:** If this is selected, files will be separated based on the maximum length you specify.

**File Name Prefix:** The prefix name will be added on the file name of the recording file(s).

The screenshot displays a configuration interface for recording, divided into three main sections:

- RECORDING:** Contains a text field for "Recording entry name", a checkbox for "Enable this recording", a "Priority" dropdown menu set to "normal", and a "Source" dropdown menu set to "Profile 1".
- RECORDING SCHEDULE:** Features a row of checkboxes for days of the week (Sun, Mon, Tue, Wed, Thu, Fri, Sat), all of which are checked. Below this is a "Time" section with two radio button options: "Always" (selected) and "From" (with time pickers for hours and minutes) and "To" (with time pickers for hours and minutes).
- RECORDING SETTINGS:** Includes a "Destination" dropdown menu set to "None", a "Total cycling recording size" field set to "1000" Mbytes, and two radio button options for file separation: "Size of each file for recording" (set to "10" Mbytes, selected) and "Time of each file for recording" (set to "10" seconds). A "File Name Prefix" text field is also present.

At the bottom of the interface are two buttons: "Save Settings" and "Don't Save Settings".

# Advanced ICR and IR

Here you can configure the ICR and IR settings. The IR (Infrared) Cut-Removable (ICR) filter can be disengaged for increased sensitivity in low light environments.

**Automatic:** The Day/Night mode is set automatically. You can use the Sensitivity drop-down box to set when the camera will switch to Night mode. The text box to the right shows what lighting conditions are currently being detected by the camera for reference. You can refresh this status by clicking the **Refresh** button.

**Day Mode:** Day mode enables the IR Cut Filter.

**Night Mode:** Night mode disables the IR Cut Filter.

**Schedule Mode:** Set up the Day/Night mode using a schedule. The camera will enter Day mode at the starting time and return to Night mode at the ending time.

**IR Light Control:** The camera can enable or disable the IR (infrared) light according to your preferences. This setting provides additional controls depending on your specific application.

**Off:** The IR light will always be off.

**On:** The IR light will always be on.

**Sync with ICR:** The IR light will turn on when the ICR filter is disabled (night mode).

**Schedule:** The IR light will turn on or off according to the schedule that you specify below.

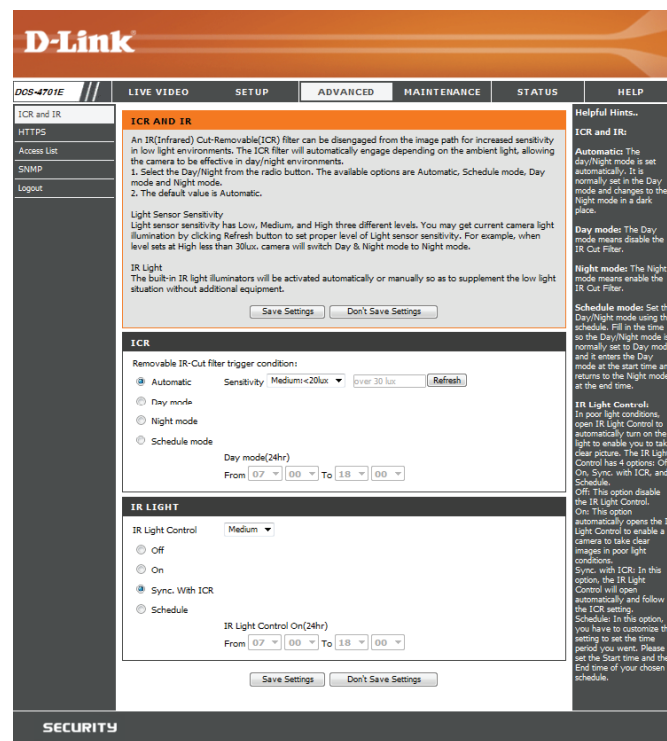

# HTTPS

This page allows you to install and activate an HTTPS certificate for secure access to your camera. After making any changes, click the **Save Settings** button to save your changes.

**Enable HTTPS Secure Connection:** Enable the HTTPS service.

**Create Certificate Method:** Choose the way the certificate should be created. Three options are available:

- Create a self-signed certificate automatically
- Create a self-signed certificate manually
- Create a certificate request and install

**Status:** Displays the status of the certificate.

**Note:** The certificate cannot be removed while HTTPS is still enabled. To remove the certificate, you must first uncheck **Enable HTTPS secure connection**.



## Access List

Here you can set access permissions for users to view your DCS-4701E.

**Allow list:** The list of IP addresses that have access rights to the camera.

**Note:** When adding entries to the Allow list, make sure the first entry includes the IP address of the computer or device you are using to access the camera. Otherwise, you may be blocked from accessing the camera after adding the entry to the Allow list.

**Start IP address:** The starting IP address of the IP address range for the devices (such as a computer) that have permission to access the video of the camera.

**End IP address:** The ending IP address of the IP address range for the devices (such as a computer) that have permission to access the video of the camera. Click **Add** to save your changes.

**Note:** A total of seven lists can be configured for both columns.

**Delete allow list:** Select an entry to remove from the Allow List, then click **Delete**.

**Deny list:** The list of IP addresses that have no access rights to the camera.

**Delete deny list:** Select an entry to remove from the Deny List, then click **Delete**.

**Note:** All addresses in the Deny List will be denied access, even if they are also in the Allow List.

# SNMP

Here you can set the SNMP settings for the camera, which allow for SNMP management of the camera.

**Enable SMNPv1, SNMPv2c:** Enable this option to allow for SNMPv1 and SNMPv2c management of the camera.

**Read/Write Community:** Enter a name for the read/write community of your SNMP server.

**Read Only Community:** Enter a name for the read-only community of your SNMP server.

**Enable SNMPv3:** Enable this option to allow SNMPv3 management of the camera.

**Read/Write Security Name:** Enter a name for the read/write community of your read/write SNMP server.

**Authentication Type:** Enter the type of authentication used by your read/write SNMP server.

**Authentication Password:** Enter the authentication password used for your read/write SNMP server.

**Encryption Password:** Enter the encryption password used for your read/write SNMP server.

**Read Only Security Name** Enter a name for the read-only community of your read-only SNMP server.

**D-Link**

DCS-4701E // LIVE VIDEO SETUP ADVANCED MAINTENANCE STATUS HELP

ICR and IR  
HTTPS  
Access List  
SNMP  
Logout

**SNMP**

The Simple Network Management Protocol is an application layer protocol that facilitates the exchange of management information between network devices. It helps network administrators to remotely manage network devices and find, solve network problems with ease.

Save Settings Don't Save Settings

**SNMP CONFIGURATION**

Enable SNMPv1, SNMPv2c

Read/Write community private

Read only community public

Enable SNMPv3

Read/Write Security name private

Authentication type SHA

Authentication password \*\*\*\*\*

Encryption password \*\*\*\*\*

Read only security name public

Authentication type SHA

Authentication password \*\*\*\*\*

Encryption password \*\*\*\*\*

Save Settings Don't Save Settings

**Helpful Hints...**

**Enable SNMPv1, SNMPv2c:** Select this option and enter the names of Read/Write community and Read Only community according to your NMS setting.

**Enable SNMPv3:** This option contains cryptographic security, a higher security level which allows you to set the Authentication password and the Encryption password.

**Security name:** According to your NMS setting, choose Read/Write or Read Only and enter the community name.

**Authentication type:** Select MD5 or SHA as the authentication method.

**Authentication password:** Enter the password for authentication (at least 8 characters).

**Encryption password:** Enter a password for encryption (at least 8 characters).

**SECURITY**

**Authentication Type:** Enter the type of authentication used by your read-only SNMP server.

**Authentication Password:** Enter the authentication password used for your read-only SNMP server.

**Encryption Password:** Enter the encryption password used for your read-only SNMP server.

The image shows a configuration window titled "SNMP CONFIGURATION". It contains two sections, each with a checkbox and several input fields. The first section is for "Enable SNMPv1, SNMPv2c" and the second is for "Enable SNMPv3".

Section	Field	Value
Enable SNMPv1, SNMPv2c	Read/Write community	private
	Read only community	public
Enable SNMPv3	Read/Write Security name	private
	Authentication type	SHA
	Authentication password	*****
	Encryption password	*****
	Read only security name	public
	Authentication type	SHA
	Authentication password	*****
	Encryption password	*****

At the bottom of the window are two buttons: "Save Settings" and "Don't Save Settings".

# Maintenance

## Device Management

You may modify the name and administrator's password of your camera, as well as add and manage the user accounts for accessing the camera. You may also use this section to create a unique name and configure the OSD settings for your camera.

**Admin Password Setting:** Set a new password for the administrator's account.

**Add User Account:** Add a new user account.

**User Name:** Enter the user name for the new account.

**Password:** Enter the password for the new account.

**User List:** All the existing user accounts will be displayed here. You may delete accounts included in the list, but you may want to reserve at least one as a guest account.

**IP Camera Name:** Create a unique name for your camera that will be added to the file name prefix when creating a snapshot or a video clip.

**Enable OSD:** Select this option to enable the On-Screen Display feature for your camera.

**Label:** Enter a label for the camera, which will be shown on the OSD when it is enabled.

**Show Time:** Select this option to enable the time-stamp display on the video screen.

**LED:** You may specify whether or not to illuminate the status LED on the camera.

**D-Link**

DCS-4701E // LIVE VIDEO SETUP ADVANCED MAINTENANCE STATUS HELP

Admin System Firmware Upgrade Logout

**ADMIN**

Here you can change the administrator's password for your IP camera as well as add and/or delete user account(s). You can configure the information, such as IP camera's name and time via this page. You can also enable the OSD (On-Screen Display) feature in order to display the IP camera name and time stamp for your video recordings.

**ADMIN PASSWORD SETTING**

New Password  32 characters maximum  
 Retype Password

**ADD USER ACCOUNT**

User Name  20 users maximum  
 New Password  32 characters maximum  
 Retype Password

**USER LIST**

User Name  -- User list --

**DEVICE SETTING**

IP Camera Name DCS-4701E 63 characters maximum  
 Enable OSD  
 Label DCS-4701E 30 characters maximum  
 Show Time

**LED**

LED  On  Off

**Helpful Hints...**

Enabling OSD, the IP camera name and time will be displayed on the video screen for the user.

For security purposes, it is recommended that you change the password for your administrator account. Be sure to write down the new password to avoid having to reset the IP camera in the event that it is forgotten.

LED: In the near panel of your camera there is a LED beside the network adapter. ON: The LED will flash in light to indicate if the network is working or not. OFF: No light will show. Forth option is turn off.

**SECURITY**

## System

In this section, you may backup, restore and reset the camera configuration, or reboot the camera.

**Save To Local Hard Drive:** You may save your current camera configuration as a file on your computer.

**Load From Local Hard Drive:** Locate a pre-saved configuration by clicking **Browse** and then restore the pre-defined settings to your camera by clicking **Load Configuration**.

**Restore to Factory Defaults:** You may reset your camera and restore the factory settings by clicking **Restore Factory Defaults**.

**Reboot Device:** This will restart your camera.

**Enable Schedule Reboot:** If you want your camera to reboot on a regular schedule, check the **Enable Schedule Reboot** checkbox, then select the days and time you want the camera to reboot on.



## Firmware Upgrade

The camera's current firmware version will be displayed on this screen. You may visit the D-Link Support Website to check for the latest available firmware version.

To upgrade the firmware on your DCS-4701E, please download and save the latest firmware version from the D-Link Support Page to your local hard drive. Locate the file on your local hard drive by clicking the **Browse** button. Select the file and click the **Upload** button to start upgrading the firmware.

**Current Firmware Version:** Displays the detected firmware version.

**Current Product Name:** Displays the camera model name.

**File Path:** Locate the file (upgraded firmware) on your hard drive by clicking **Browse**.

**Upload:** Uploads the new firmware to your camera.



# Status

## Device Info

This page displays detailed information about your device and network connection.

The screenshot shows the D-Link web interface for the DCS-4701E device. The top navigation bar includes links for LIVE VIDEO, SETUP, ADVANCED, MAINTENANCE, STATUS (selected), and HELP. The left sidebar contains links for Device Info (selected), Log, and Logout. The main content area is titled "DEVICE INFO" and contains a message: "All of your network connection details are displayed on this page. The firmware version is also displayed here." Below this is an "INFORMATION" table with the following data:

INFORMATION	
IP Camera Name	DCS-4701E
Time & Date	Fri Jan 16 03:34:49 2015
Firmware Version	0.02.01
Hardware Version	A
MAC Address	0A:00:47:01:00:01
IP Address	192.168.0.101
IP Subnet Mask	255.255.255.0
Default Gateway	192.168.0.1
Primary DNS	192.168.0.1
Secondary DNS	0.0.0.0
PPPoE	Disable
DDNS	Disable

On the right side, there is a "Helpful Hints.." section with the text: "This page displays all the information about the IP camera and network settings."

## Logs

This page displays the log information of your camera. You may download the information by clicking **Download**. You may also click **Clear** to delete the saved log information.

**D-Link**

DCS-4701E // LIVE VIDEO SETUP ADVANCED MAINTENANCE STATUS HELP

Device Info  
Log  
Logout

**SYSTEM LOG**  
The system log records IP camera events that have occurred.

**CURRENT LOG**

1. 2015-01-16 03:34:01 admin FROM 192.168.0.174 DELETE RECORDING 1
2. 2015-01-16 03:33:19 admin FROM 192.168.0.174 TURN ON RECORDING 1 to None ; Name : Night Recording
3. 2015-01-16 03:33:19 admin FROM 192.168.0.174 SET Size of each file for recording 10 Mbytes
4. 2015-01-16 03:32:06 admin FROM 192.168.0.174 SET EVENT TYPE 1 ; Trigger : Motion Detection
5. 2015-01-16 03:31:45 admin FROM 192.168.0.174 SET EVENT MEDIA 2 ; Name : Save to log, Type : System log
6. 2015-01-16 03:31:36 admin FROM 192.168.0.174 SET EVENT MEDIA 1 ; Name : Save snapshot, Type : Snapshot
7. 2015-01-16 03:31:22 admin FROM 192.168.0.174 SET EVENT SERVER 1 ; Name : Save to e-mail, Type : Email
8. 2015-01-16 02:45:17 admin FROM 192.168.0.174 LOGIN OK
9. 2015-01-16 02:45:15 DCS-4701E ACQUIRE DHCP IP 192.168.0.101
10. 2015-01-16 02:45:14 NETWORK RECONNECT
11. 2015-01-16 00:41:22 NETWORK LOSS
12. 2015-01-15 23:29:54 admin FROM 192.168.0.174 SET VIDEO CODEC Need Reset
13. 2015-01-15 23:29:48 admin FROM 192.168.0.174 SET PROFILE 3 FRAMERATE 15
14. 2015-01-15 23:29:48 admin FROM 192.168.0.174 SET PROFILE 3 Viewer window area 320x176
15. 2015-01-15 23:29:48 admin FROM 192.168.0.174 SET PROFILE 3 Frame Size 320x176
16. 2015-01-15 23:28:57 admin FROM 192.168.0.174 LOGIN OK
17. 2015-01-15 17:28:39 SYSTEM SET IR LIGHT OFF
18. 2015-01-15 17:28:39 SYSTEM SET IR LIGHT ON
19. 2015-01-15 17:28:39 SYSTEM SET IR LIGHT ON
20. 2015-01-15 06:59:31 SYSTEM SET IR LIGHT ON

First Page Previous 20 Next 20  
Clear Download

**Helpful Hints..**  
You can save the log to your local hard IP camera by clicking the Download button, and you can clear the log by clicking on the Clear button.

**SECURITY**

# Help

This page provides helpful information regarding camera operation.

The screenshot shows the D-Link DCS-4701E web interface. At the top is the D-Link logo. Below it is a navigation bar with tabs for LIVE VIDEO, SETUP, ADVANCED, MAINTENANCE, STATUS, and HELP. The HELP tab is selected. On the left side, there is a sidebar with 'Help' and 'Logout' links. The main content area is titled 'HELP' and contains a list of links for each menu item: LIVE VIDEO (Camera), SETUP (Setup Wizard, Network Setup, Dynamic DNS, Image Setup, Audio and Video, Preset, Motion Detection, Time and Date, Event Setup), ADVANCED (ICR and IR, HTTPS, Access List, SNMP), MAINTENANCE (Admin, System, Firmware Upgrade), and STATUS (Device Info, Log). At the bottom of the page, there is a 'SECURITY' section.

**D-Link**

DCS-4701E // LIVE VIDEO SETUP ADVANCED MAINTENANCE STATUS HELP

Help  
Logout

**HELP**

- [LIVE VIDEO](#)
- [SETUP](#)
- [MAINTENANCE](#)
- [ADVANCED](#)
- [STATUS](#)

**LIVE VIDEO**

- [Camera](#)

**SETUP**

- [Setup Wizard](#)
- [Network Setup](#)
- [Dynamic DNS](#)
- [Image Setup](#)
- [Audio and Video](#)
- [Preset](#)
- [Motion Detection](#)
- [Time and Date](#)
- [Event Setup](#)

**ADVANCED**

- [ICR and IR](#)
- [HTTPS](#)
- [Access List](#)
- [SNMP](#)

**MAINTENANCE**

- [Admin](#)
- [System](#)
- [Firmware Upgrade](#)

**STATUS**

- [Device Info](#)
- [Log](#)

**SECURITY**

# Technical Specifications

<b>Camera</b>	Camera Hardware Profile	<ul style="list-style-type: none"> <li>▪ 1/3" 1.3 Megapixel progressive CMOS sensor</li> <li>▪ 30 meter IR illumination distance</li> <li>▪ Minimum illumination: 0 lux with IR LED on</li> <li>▪ Built-in Infrared-Cut Removable (ICR) Filter module</li> <li>▪ 10x digital zoom</li> <li>▪ Minimum object distance 0.2M</li> </ul>	<ul style="list-style-type: none"> <li>▪ Focal length: 2.8 mm</li> <li>▪ Aperture: F1.8</li> <li>▪ Angle of view:               <ul style="list-style-type: none"> <li>▪ (H) 96°</li> <li>▪ (V) 54°</li> <li>▪ (D) 108°</li> </ul> </li> </ul>
	Camera Housing	<ul style="list-style-type: none"> <li>▪ IP-66 compliant weatherproof housing</li> </ul>	
	Image Features	<ul style="list-style-type: none"> <li>▪ Configurable image size, quality, frame rate, and bit rate</li> <li>▪ Time stamp and text overlays</li> <li>▪ Configurable motion detection windows</li> </ul>	<ul style="list-style-type: none"> <li>▪ Configurable privacy mask zones</li> <li>▪ Configurable shutter speed, brightness, saturation, contrast, and sharpness</li> </ul>
	Video Compression	<ul style="list-style-type: none"> <li>▪ Simultaneous H.264/MJPEG format compression</li> <li>▪ H.264/MJPEG multicast streaming</li> </ul>	<ul style="list-style-type: none"> <li>▪ JPEG for still images</li> </ul>
	Video Resolution	16:9 - 1280 x 720, 800 x 448, 640 x 360, 480 x 272, 320 x 176 up to 30 fps	4:3 - 960 x 720, 800 x 592, 640 x 480, 480 x 352, 320 x 240 up to 30 fps
	External Device Interface	<ul style="list-style-type: none"> <li>▪ 10/100 BASE-TX Fast Ethernet port</li> </ul>	<ul style="list-style-type: none"> <li>▪ Supports 802.3af PoE</li> </ul>
<b>Network</b>	Network Protocols	<ul style="list-style-type: none"> <li>▪ IPv6</li> <li>▪ IPv4</li> <li>▪ TCP/IP</li> <li>▪ UDP</li> <li>▪ ICMP</li> <li>▪ DHCP client</li> <li>▪ NTP client (D-Link)</li> <li>▪ DNS client</li> <li>▪ DDNS client (D-Link)</li> <li>▪ SMTP client</li> <li>▪ FTP client</li> </ul>	<ul style="list-style-type: none"> <li>▪ HTTP / HTTPS</li> <li>▪ Samba client</li> <li>▪ PPPoE</li> <li>▪ UPnP port forwarding</li> <li>▪ RTP / RTSP / RTCP</li> <li>▪ IP filtering</li> <li>▪ QoS</li> <li>▪ CoS</li> <li>▪ Multicast</li> <li>▪ IGMP</li> <li>▪ ONVIF compliant</li> </ul>
	Security	Administrator and user group protection Password authentication	HTTP and RTSP authentication

## Appendix A: Technical Specifications

<b>System Management</b>	System Requirements for Web Interface	<ul style="list-style-type: none"> <li>Browser: Internet Explorer, Firefox, Chrome, Safari</li> </ul>	
	Event Management	<ul style="list-style-type: none"> <li>Motion detection</li> <li>Event notification and uploading of snapshots/video clips via e-mail or FTP</li> </ul>	<ul style="list-style-type: none"> <li>Supports multiple SMTP and FTP servers</li> <li>Multiple event notifications</li> <li>Multiple recording methods for easy backup</li> </ul>
	Remote Management	<ul style="list-style-type: none"> <li>Take snapshots/video clips and save to local hard drive</li> </ul>	<ul style="list-style-type: none"> <li>Configuration interface accessible via web browser</li> </ul>
	D-ViewCam™ System Requirements	<ul style="list-style-type: none"> <li>Operating System: Microsoft Windows 8/7/Vista</li> <li>Web Browser: Internet Explorer 7 or higher</li> </ul>	<ul style="list-style-type: none"> <li>Protocol: Standard TCP/IP</li> </ul>
	D-ViewCam™ Software Functions	<ul style="list-style-type: none"> <li>Remote management/control of up to 32 cameras</li> <li>Viewing of up to 32 cameras on one screen</li> </ul>	<ul style="list-style-type: none"> <li>Supports all management functions provided in web interface</li> <li>Scheduled motion triggered, or manual recording options</li> </ul>
<b>General</b>	Weight	445 g ± 5%	
	External Power Adapter (not included)	Input: 100 to 240 V AC, 50/60 Hz	Output: 12 V DC 1.5 A
	Power Consumption	4.7 watts ± 5%	
	Temperature	Operating: -40 to 50 °C (-22 to 122 °F)	Storage: -20° to 70° C (-4° to 158° F)
	Humidity	Operating: 20% to 80% non-condensing	Storage: 5% to 95% non-condensing
	Certifications	CE CE LVD	FCC C-Tick

