

# **GA-H55M-D2H/ GA-H55M-S2H**

LGA1156 socket motherboard for Intel® Core™ i7 processors/Intel® Core™ i5 processors/Intel® Core™ i3 processors/Intel® Pentium® processors

## **User's Manual**

Rev. 1402

12ME-H55MD2H-1402R



## **Copyright**

© 2010 GIGA-BYTE TECHNOLOGY CO., LTD. All rights reserved.

The trademarks mentioned in this manual are legally registered to their respective owners.

## **Disclaimer**

Information in this manual is protected by copyright laws and is the property of GIGABYTE.

Changes to the specifications and features in this manual may be made by GIGABYTE without prior notice. No part of this manual may be reproduced, copied, translated, transmitted, or published in any form or by any means without GIGABYTE's prior written permission.

## **Documentation Classifications**

In order to assist in the use of this product, GIGABYTE provides the following types of documentations:

- For quick set-up of the product, read the Quick Installation Guide included with the product.
- For detailed product information, carefully read the User's Manual.
- For instructions on how to use GIGABYTE's unique features, read or download the information on/from the Support&Downloads\Motherboard\Technology Guide page on our website.

For product-related information, check on our website at:

<http://www.gigabyte.com>

## **Identifying Your Motherboard Revision**

The revision number on your motherboard looks like this: "REV: X.X." For example, "REV: 1.0" means the revision of the motherboard is 1.0. Check your motherboard revision before updating motherboard BIOS, drivers, or when looking for technical information.

Example:

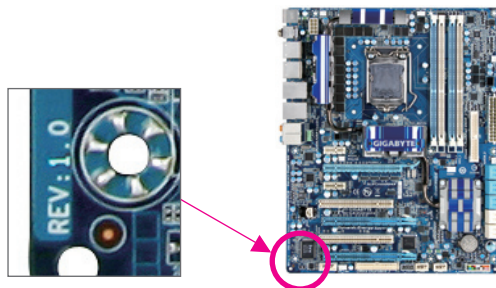

# Table of Contents

Box Contents .....	6
Optional Items .....	6
GA-H55M-D2H/GA-H55M-S2H Motherboard Layout .....	7
GA-H55M-D2H/GA-H55M-S2H Motherboard Block Diagram .....	8
Chapter 1 Hardware Installation .....	9
1-1 Installation Precautions .....	9
1-2 Product Specifications .....	10
1-3 Installing the CPU and CPU Cooler .....	13
1-3-1 Installing the CPU .....	13
1-3-2 Installing the CPU Cooler .....	15
1-4 Installing the Memory .....	16
1-4-1 Dual Channel Memory Configuration .....	16
1-4-2 Installing a Memory .....	17
1-5 Installing an Expansion Card .....	18
1-6 Back Panel Connectors .....	19
1-7 Internal Connectors .....	21
Chapter 2 BIOS Setup .....	31
2-1 Startup Screen .....	32
2-2 The Main Menu .....	33
2-3 MB Intelligent Tweaker(M.I.T.) .....	35
2-4 Standard CMOS Features .....	43
2-5 Advanced BIOS Features .....	45
2-6 Integrated Peripherals .....	47
2-7 Power Management Setup .....	50
2-8 PC Health Status .....	52
2-9 Load Fail-Safe Defaults .....	54
2-10 Load Optimized Defaults .....	54
2-11 Set Supervisor/User Password .....	55
2-12 Save & Exit Setup .....	56
2-13 Exit Without Saving .....	56

Chapter 3 Drivers Installation.....	57
3-1 Installing Chipset Drivers .....	57
3-2 Application Software .....	58
3-3 Technical Manuals.....	58
3-4 Contact.....	59
3-5 System .....	59
3-6 Download Center .....	60
3-7 New Utilities .....	60
 Chapter 4 Unique Features.....	 61
4-1 Xpress Recovery2.....	61
4-2 BIOS Update Utilities .....	64
4-2-1 Updating the BIOS with the Q-Flash Utility.....	64
4-2-2 Updating the BIOS with the @BIOS Utility .....	67
4-3 EasyTune 6 .....	68
4-4 Dynamic Energy Saver™ 2.....	69
4-5 Q-Share.....	71
4-6 Smart 6™ .....	72
4-7 Auto Green.....	75
 Chapter 5 Appendix.....	 77
5-1 Configuring Audio Input and Output.....	77
5-1-1 Configuring 2/4/5.1/7.1-Channel Audio.....	77
5-1-2 Configuring S/PDIF In/Out.....	79
5-1-3 Configuring Microphone Recording .....	81
5-1-4 Using the Sound Recorder .....	83
5-2 Troubleshooting.....	84
5-2-1 Frequently Asked Questions .....	84
5-2-2 Troubleshooting Procedure .....	85
5-3 Regulatory Statements.....	87

## Box Contents

- GA-H55M-D2H or GA-H55M-S2H motherboard
- Motherboard driver disk
- User's Manual
- Quick Installation Guide
- One IDE cable
- Two SATA cables
- I/O Shield

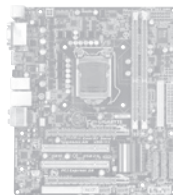

- The box contents above are for reference only and the actual items shall depend on the product package you obtain. The box contents are subject to change without notice.
- The motherboard image is for reference only.

## Optional Items

- Floppy disk drive cable (Part No. 12CF1-1FD001-7\*R)
- 2-port USB 2.0 bracket (Part No. 12CR1-1UB030-5\*R)
- 2-port SATA power cable (Part No. 12CF1-2SERPW-0\*R)
- S/PDIF In cable (Part No. 12CR1-1SPDIN-0\*R)
- COM port cable (Part No. 12CF1-1CM001-3\*R)

# GA-H55M-D2H/GA-H55M-S2H Motherboard Layout

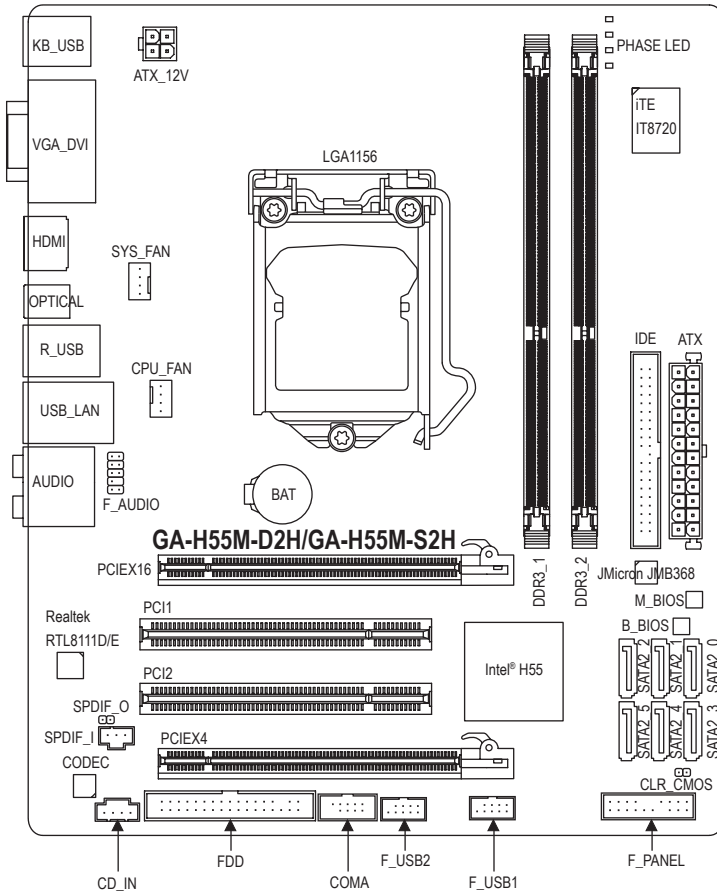

\*\*\* The GA-H55M-D2H adopts All-Solid Capacitor design.

# GA-H55M-D2H/GA-H55M-S2H Motherboard Block Diagram

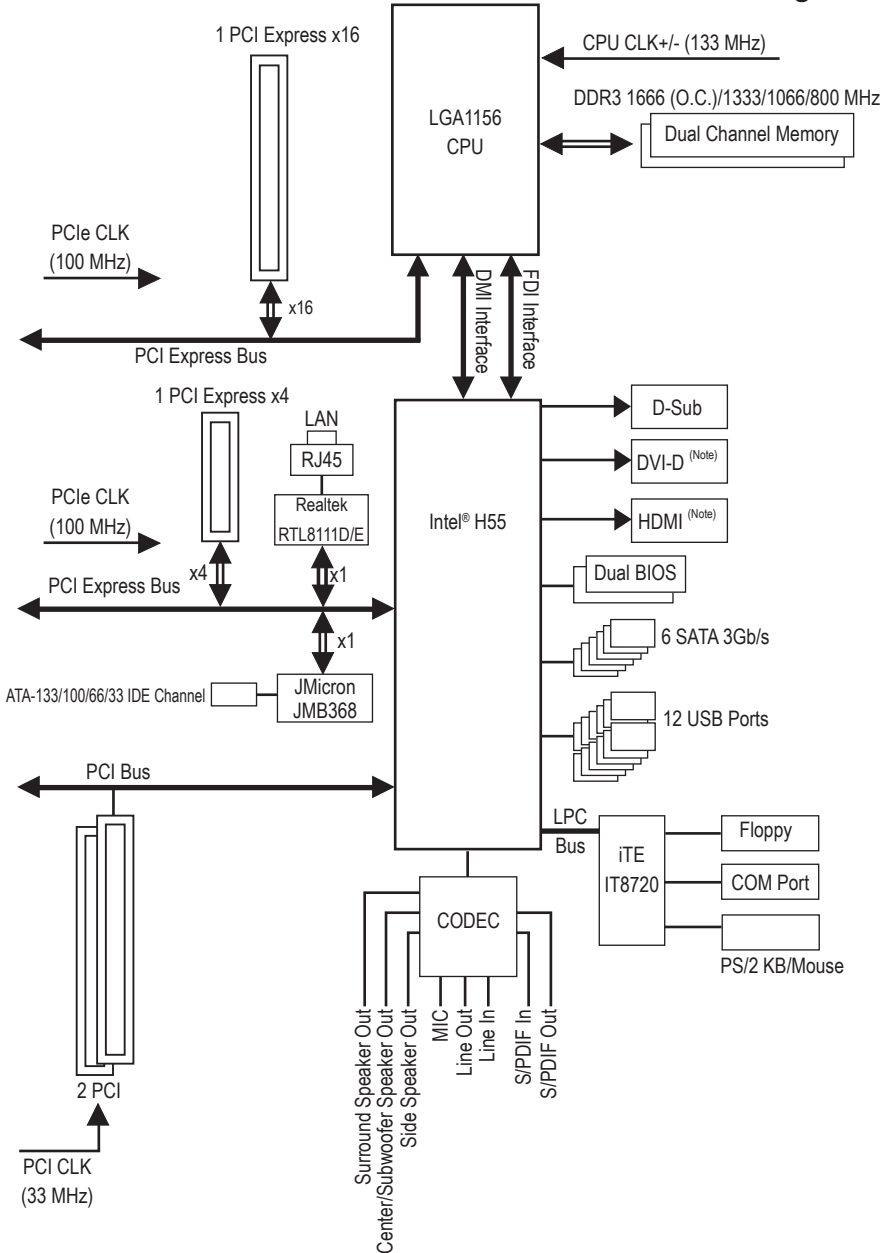

(Note) You can use only one of the onboard digital graphics ports (HDMI and DVI-D) for output when in the BIOS Setup program or when during the POST screens.









# Chapter 1 Hardware Installation

## 1-1 Installation Precautions





The motherboard contains numerous delicate electronic circuits and components which can become damaged as a result of electrostatic discharge (ESD). Prior to installation, carefully read the user's manual and follow these procedures:





- Prior to installation, do not remove or break motherboard S/N (Serial Number) sticker or warranty sticker provided by your dealer. These stickers are required for warranty validation.
- Always remove the AC power by unplugging the power cord from the power outlet before installing or removing the motherboard or other hardware components.
- When connecting hardware components to the internal connectors on the motherboard, make sure they are connected tightly and securely.
- When handling the motherboard, avoid touching any metal leads or connectors.
- It is best to wear an electrostatic discharge (ESD) wrist strap when handling electronic components such as a motherboard, CPU or memory. If you do not have an ESD wrist strap, keep your hands dry and first touch a metal object to eliminate static electricity.
- Prior to installing the motherboard, please have it on top of an antistatic pad or within an electrostatic shielding container.
- Before unplugging the power supply cable from the motherboard, make sure the power supply has been turned off.
- Before turning on the power, make sure the power supply voltage has been set according to the local voltage standard.
- Before using the product, please verify that all cables and power connectors of your hardware components are connected.
- To prevent damage to the motherboard, do not allow screws to come in contact with the motherboard circuit or its components.
- Make sure there are no leftover screws or metal components placed on the motherboard or within the computer casing.
- Do not place the computer system on an uneven surface.
- Do not place the computer system in a high-temperature environment.
- Turning on the computer power during the installation process can lead to damage to system components as well as physical harm to the user.
- If you are uncertain about any installation steps or have a problem related to the use of the product, please consult a certified computer technician.

## 1-2 Product Specifications

 CPU	<ul style="list-style-type: none"> <li>◆ Support for Intel® Core™ i7 processors/Intel® Core™ i5 processors/Intel® Core™ i3 processors/Intel® Pentium® processors in the LGA1156 package (Go to GIGABYTE's website for the latest CPU support list.)</li> <li>◆ L3 cache varies with CPU</li> </ul>
 Chipset	<ul style="list-style-type: none"> <li>◆ Intel® H55 Express Chipset</li> </ul>
 Memory	<ul style="list-style-type: none"> <li>◆ 2 x 1.5V DDR3 DIMM sockets supporting up to 16 GB of system memory <sup>(Note 1)</sup></li> <li>◆ Dual channel memory architecture</li> <li>◆ Support for DDR3 1666 (O.C.)/1333/1066/800 MHz memory modules</li> <li>◆ Support for non-ECC memory modules</li> <li>◆ Support for Extreme Memory Profile (XMP) memory modules (Go to GIGABYTE's website for the latest supported memory speeds and memory modules.)</li> </ul>
 Onboard Graphics	<ul style="list-style-type: none"> <li>◆ Integrated in the Chipset:             <ul style="list-style-type: none"> <li>- 1 x D-Sub port <sup>(Note 2)</sup></li> <li>- 1 x DVI-D port <sup>(Note 2)(Note 3) (Note 4)</sup></li> <li>- 1 x HDMI port <sup>(Note 2)(Note 4)</sup></li> </ul> </li> </ul>
 Audio	<ul style="list-style-type: none"> <li>◆ Realtek ALC888B/892 codec</li> <li>◆ High Definition Audio</li> <li>◆ 2/4/5.1/7.1-channel</li> <li>◆ Support for S/PDIF In/Out</li> <li>◆ Support for CD In</li> </ul>
 LAN	<ul style="list-style-type: none"> <li>◆ 1 x Realtek RTL8111D/E chip (10/100/1000 Mbit)</li> </ul>
 Expansion Slots	<ul style="list-style-type: none"> <li>◆ 1 x PCI Express x16 slot, running at x16 (PCIEX16) <sup>(Note 5)</sup> (The PCIEX16 slot conforms to PCI Express 2.0 standard.)</li> <li>◆ 1 x PCI Express x16 slot, running at x4 (PCIEX4)</li> <li>◆ 2 x PCI slots</li> </ul>
 Multi-Graphics Technology	<ul style="list-style-type: none"> <li>◆ Support for ATI CrossFireX™ technology <sup>(Note 6)</sup></li> </ul>
 Storage Interface	<ul style="list-style-type: none"> <li>◆ Chipset:             <ul style="list-style-type: none"> <li>- 6 x SATA 3Gb/s connectors supporting up to 6 SATA 3Gb/s devices</li> </ul> </li> <li>◆ JMicron JMB368 chip:             <ul style="list-style-type: none"> <li>- 1 x IDE connector supporting ATA-133/100/66/33 and up to 2 IDE devices</li> </ul> </li> <li>◆ iTE IT8720 chip:             <ul style="list-style-type: none"> <li>- 1 x floppy disk drive connector supporting up to 1 floppy disk drive</li> </ul> </li> </ul>

\*\*\* The GA-H55M-D2H adopts All-Solid Capacitor design.

	USB	<ul style="list-style-type: none"> <li>◆ Integrated in the Chipset</li> <li>- Up to 12 USB 2.0/1.1 ports (8 on the back panel, 4 via the USB brackets connected to the internal USB headers)</li> </ul>
	Internal Connectors	<ul style="list-style-type: none"> <li>◆ 1 x 24-pin ATX main power connector</li> <li>◆ 1 x 4-pin ATX 12V power connector</li> <li>◆ 1 x floppy disk drive connector</li> <li>◆ 1 x IDE connector</li> <li>◆ 6 x SATA 3Gb/s connectors</li> <li>◆ 1 x CPU fan header</li> <li>◆ 1 x system fan header</li> <li>◆ 1 x front panel header</li> <li>◆ 1 x front panel audio header</li> <li>◆ 1 x CD In connector</li> <li>◆ 1 x S/PDIF In header</li> <li>◆ 1 x S/PDIF Out header</li> <li>◆ 2 x USB 2.0/1.1 headers</li> <li>◆ 1 x serial port header</li> <li>◆ 1 x clearing CMOS jumper</li> </ul>
	Back Panel Connectors	<ul style="list-style-type: none"> <li>◆ 1 x PS/2 keyboard/mouse port</li> <li>◆ 1 x D-Sub port <sup>(Note 2)</sup></li> <li>◆ 1 x DVI-D port <sup>(Note 2)(Note 3) (Note 4)</sup></li> <li>◆ 1 x optical S/PDIF Out connector</li> <li>◆ 1 x HDMI port <sup>(Note 2)(Note 4)</sup></li> <li>◆ 8 x USB 2.0/1.1 ports</li> <li>◆ 1 x RJ-45 port</li> <li>◆ 6 x audio jacks (Center/Subwoofer Speaker Out/Rear Speaker Out/Side Speaker Out/Line In/Line Out/Microphone)</li> </ul>
	I/O Controller	<ul style="list-style-type: none"> <li>◆ iTE IT8720 chip</li> </ul>
	Hardware Monitor	<ul style="list-style-type: none"> <li>◆ System voltage detection</li> <li>◆ CPU/System temperature detection</li> <li>◆ CPU/System fan speed detection</li> <li>◆ CPU overheating warning</li> <li>◆ CPU/System fan fail warning</li> <li>◆ CPU/System fan speed control <sup>(Note 7)</sup></li> </ul>

 BIOS	<ul style="list-style-type: none"> <li>◆ 2 x 64 Mbit flash</li> <li>◆ Use of licensed AWARD BIOS</li> <li>◆ Support for DualBIOS™</li> <li>◆ PnP 1.0a, DMI 2.0, SM BIOS 2.4, ACPI 1.0b</li> </ul>
 Unique Features	<ul style="list-style-type: none"> <li>◆ Support for @BIOS</li> <li>◆ Support for Q-Flash</li> <li>◆ Support for Xpress BIOS Rescue</li> <li>◆ Support for Download Center</li> <li>◆ Support for Xpress Install</li> <li>◆ Support for Xpress Recovery2</li> <li>◆ Support for EasyTune<sup>(Note 8)</sup></li> <li>◆ Support for Dynamic Energy Saver™ 2</li> <li>◆ Support for Smart 6™</li> <li>◆ Support for Auto Green</li> <li>◆ Support for ON/OFF Charge</li> <li>◆ Support for Q-Share</li> </ul>
 Bundled Software	<ul style="list-style-type: none"> <li>◆ Norton Internet Security (OEM version)</li> </ul>
 Operating System	<ul style="list-style-type: none"> <li>◆ Support for Microsoft® Windows 7/Vista/XP</li> </ul>
 Form Factor	<ul style="list-style-type: none"> <li>◆ MicroATX Form Factor; 24.4cm x 21.0cm</li> </ul>

(Note 1) Due to Windows 32-bit operating system limitation, when more than 4 GB of physical memory is installed, the actual memory size displayed will be less than 4 GB.

(Note 2) To use the onboard D-Sub, DVI-D, and HDMI ports, you must install an Intel CPU with integrated graphics.

(Note 3) The DVI-D port does not support D-Sub connection by adapter.

(Note 4) You can use only one of the onboard digital graphics ports (HDMI and DVI-D) for output when in the BIOS Setup program or when during the POST screens.

(Note 5) For optimum performance, if only one PCI Express graphics card is to be installed, be sure to install it in the PCIEX16 slot.

(Note 6) The PCIEX16 slot operates at up to x4 mode when ATI CrossFireX™ is enabled.

(Note 7) Whether the CPU/system fan speed control function is supported will depend on the CPU/system cooler you install.

(Note 8) Available functions in EasyTune may differ by motherboard model.

## 1-3 Installing the CPU and CPU Cooler



Read the following guidelines before you begin to install the CPU:

- Make sure that the motherboard supports the CPU.  
(Go to GIGABYTE's website for the latest CPU support list.)
- Always turn off the computer and unplug the power cord from the power outlet before installing the CPU to prevent hardware damage.
- Locate the pin one of the CPU. The CPU cannot be inserted if oriented incorrectly. (Or you may locate the notches on both sides of the CPU and alignment keys on the CPU socket.)
- Apply an even and thin layer of thermal grease on the surface of the CPU.
- Do not turn on the computer if the CPU cooler is not installed, otherwise overheating and damage of the CPU may occur.
- Set the CPU host frequency in accordance with the CPU specifications. It is not recommended that the system bus frequency be set beyond hardware specifications since it does not meet the standard requirements for the peripherals. If you wish to set the frequency beyond the standard specifications, please do so according to your hardware specifications including the CPU, graphics card, memory, hard drive, etc.

### 1-3-1 Installing the CPU

A. Locate the alignment keys on the motherboard CPU socket and the notches on the CPU.

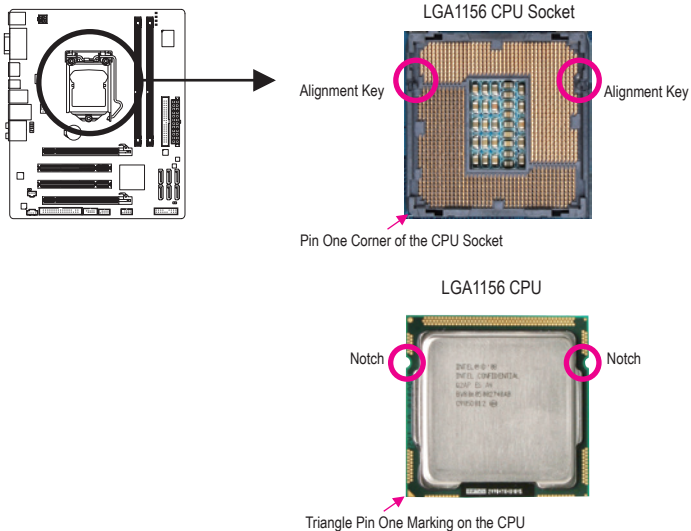

B. Follow the steps below to correctly install the CPU into the motherboard CPU socket.



**Before installing the CPU, make sure to turn off the computer and unplug the power cord from the power outlet to prevent damage to the CPU.**

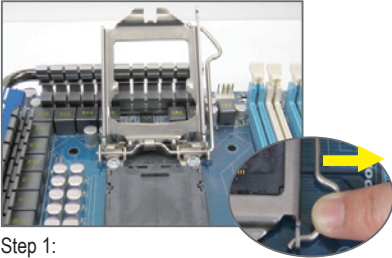

Step 1:

Gently press the CPU socket lever handle down and away from the socket with your finger. Then completely lift the CPU socket lever and the metal load plate will be lifted as well.

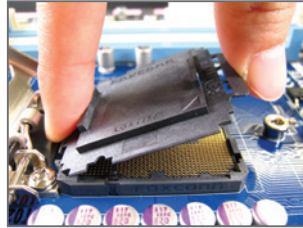

Step 2:

Remove the CPU socket cover as shown. Hold your index finger down on the rear grip of the socket cover and use your thumb to lift up the front edge (next to the "REMOVE" mark) and then remove the cover. (DO NOT touch socket contacts. To protect the CPU socket, always replace the protective socket cover when the CPU is not installed.)

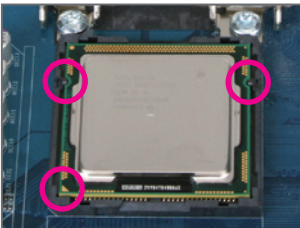

Step 3:

Hold the CPU with your thumb and index fingers. Align the CPU pin one marking (triangle) with the pin one corner of the CPU socket (or you may align the CPU notches with the socket alignment keys) and gently insert the CPU into position.

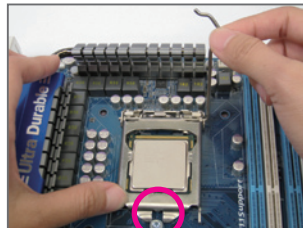

Step 4:

Once the CPU is properly inserted, use one hand to hold the socket lever and use the other to lightly replace the load plate. When replacing the load plate, make sure the front end of the load plate is under the shoulder screw.



Step 5:

Push the CPU socket lever back into its locked position.



**NOTE:**

Hold the CPU socket lever by the handle, not the lever base portion.

### 1-3-2 Installing the CPU Cooler

Follow the steps below to correctly install the CPU cooler on the motherboard. (The following procedure uses Intel® boxed cooler as the example cooler.)

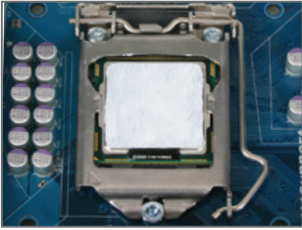

**Step 1:**  
Apply an even and thin layer of thermal grease on the surface of the installed CPU.

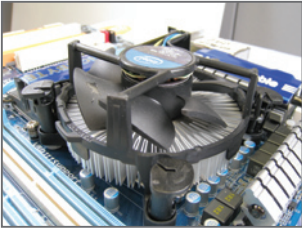

**Step 3:**  
Place the cooler atop the CPU, aligning the four push pins through the pin holes on the motherboard. Push down on the push pins diagonally.

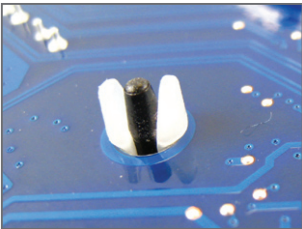

**Step 5:**  
After the installation, check the back of the motherboard. If the push pin is inserted as the picture above shows, the installation is complete.

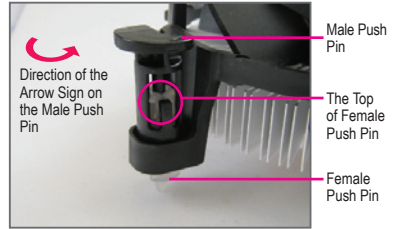

**Step 2:**  
Before installing the cooler, note the direction of the arrow sign ↶ on the male push pin. (Turning the push pin along the direction of arrow is to remove the cooler, on the contrary, is to install.)

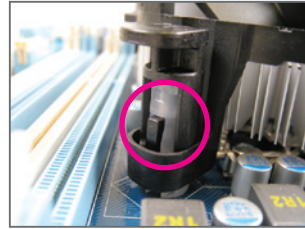

**Step 4:**  
You should hear a "click" when pushing down each push pin. Check that the Male and Female push pins are joined closely. (Refer to your CPU cooler installation manual for instructions on installing the cooler.)

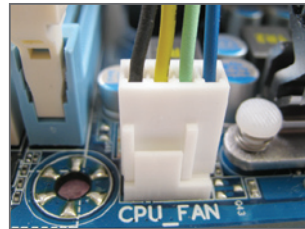

**Step 6:**  
Finally, attach the power connector of the CPU cooler to the CPU fan header (CPU\_FAN) on the motherboard.



Use extreme care when removing the CPU cooler because the thermal grease/tape between the CPU cooler and CPU may adhere to the CPU. Inadequately removing the CPU cooler may damage the CPU.

## 1-4 Installing the Memory



Read the following guidelines before you begin to install the memory:

- Make sure that the motherboard supports the memory. It is recommended that memory of the same capacity, brand, speed, and chips be used.  
(Go to GIGABYTE's website for the latest supported memory speeds and memory modules.)
- Always turn off the computer and unplug the power cord from the power outlet before installing the memory to prevent hardware damage.
- Memory modules have a foolproof design. A memory module can be installed in only one direction. If you are unable to insert the memory, switch the direction.

### 1-4-1 Dual Channel Memory Configuration

This motherboard provides two DDR3 memory sockets and supports Dual Channel Technology. After the memory is installed, the BIOS will automatically detect the specifications and capacity of the memory. Enabling Dual Channel memory mode will double the original memory bandwidth.

The two DDR3 memory sockets are divided into two channels and each channel has one memory socket as following:

- ▶▶ Channel 0: DDR3\_1
- ▶▶ Channel 1: DDR3\_2

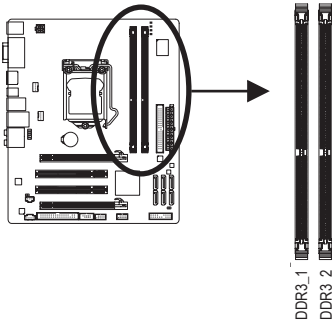

Due to CPU limitations, read the following guidelines before installing the memory in Dual Channel mode.

1. Dual Channel mode cannot be enabled if only one DDR3 memory module is installed.
2. When enabling Dual Channel mode with two memory modules, it is recommended that memory of the same capacity, brand, speed, and chips be used for optimum performance.

## 1-4-2 Installing a Memory



Before installing a memory module, make sure to turn off the computer and unplug the power cord from the power outlet to prevent damage to the memory module.

DDR3 and DDR2 DIMMs are not compatible to each other or DDR DIMMs. Be sure to install DDR3 DIMMs on this motherboard.

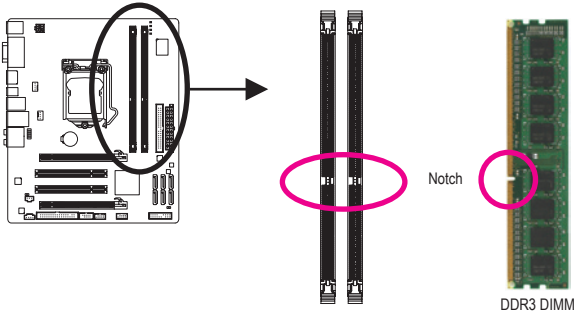

A DDR3 memory module has a notch, so it can only fit in one direction. Follow the steps below to correctly install your memory modules in the memory sockets.

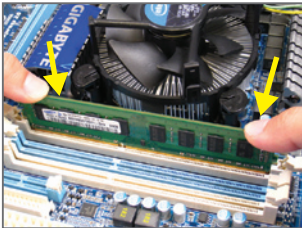

Step 1:

Note the orientation of the memory module. Spread the retaining clips at both ends of the memory socket. Place the memory module on the socket. As indicated in the picture on the left, place your fingers on the top edge of the memory, push down on the memory and insert it vertically into the memory socket.

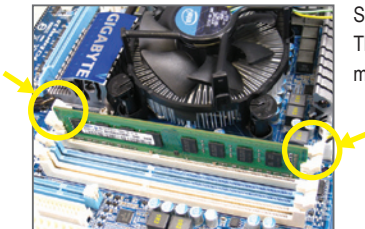

Step 2:

The clips at both ends of the socket will snap into place when the memory module is securely inserted.

# 1-5 Installing an Expansion Card



Read the following guidelines before you begin to install an expansion card:

- Make sure the motherboard supports the expansion card. Carefully read the manual that came with your expansion card.
- Always turn off the computer and unplug the power cord from the power outlet before installing an expansion card to prevent hardware damage.

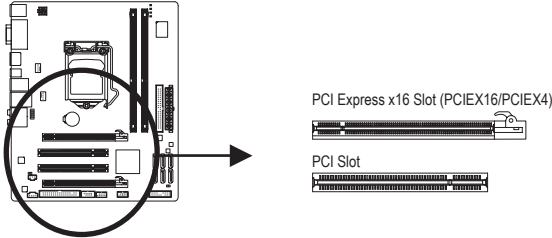

Follow the steps below to correctly install your expansion card in the expansion slot.

1. Locate an expansion slot that supports your card. Remove the metal slot cover from the chassis back panel.
2. Align the card with the slot, and press down on the card until it is fully seated in the slot.
3. Make sure the metal contacts on the card are completely inserted into the slot.
4. Secure the card's metal bracket to the chassis back panel with a screw.
5. After installing all expansion cards, replace the chassis cover(s).
6. Turn on your computer. If necessary, go to BIOS Setup to make any required BIOS changes for your expansion card(s).
7. Install the driver provided with the expansion card in your operating system.

Example: Installing and Removing a PCI Express Graphics Card:



- Installing a Graphics Card:  
Gently push down on the top edge of the card until it is fully inserted into the PCI Express slot. Make sure the card is securely seated in the slot and does not rock.

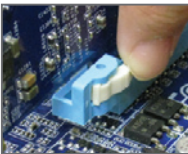

- Removing the Card:  
Press the white latch at the end of the PCI Express slot to release the card and then pull the card straight up from the slot.

# 1-6 Back Panel Connectors

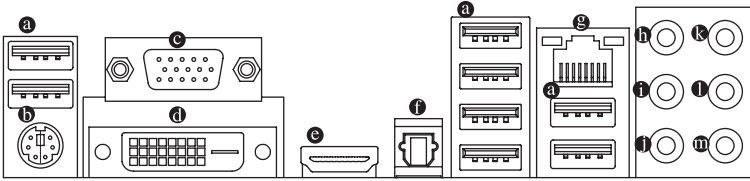

**a USB Port**

The USB port supports the USB 2.0/1.1 specification. Use this port for USB devices such as a USB keyboard/mouse, USB printer, USB flash drive and etc.

**b PS/2 Keyboard/Mouse Port**

Use this port to connect a PS/2 keyboard or mouse.

**c D-Sub Port (Note 1)**

The D-Sub port supports a 15-pin D-Sub connector. Connect a monitor that supports D-Sub connection to this port.

**d DVI-D Port (Note 1)(Note 2)(Note 3)**

The DVI-D port conforms to the DVI-D specification and supports a maximum resolution of 1920x1200 (the actual resolutions supported depend on the monitor being used). Connect a monitor that supports DVI-D connection to this port.

**e HDMI Port (Note 1)(Note 3)**

The HDMI (High-Definition Multimedia Interface) provides an all-digital audio/video interface to transmit the uncompressed audio/video signals and is HDCP compliant. Connect the HDMI audio/video device to this port. The HDMI Technology can support a maximum resolution of 1920x1200 but the actual resolutions supported depend on the monitor being used.



- After installing the HDMI device, make sure the default device for sound playback is the HDMI device. (The item name may differ from operating system. Refer to the figure below for details.)
- Please note the HDMI audio output only supports AC3, DTS and 2-channel-LPCM formats. (AC3 and DTS require the use of an external decoder for decoding.)



In Windows Vista, select Start>Control Panel>Sound>Playback, set Intel(R) Display Audio HDMI 2 to the default playback device.

- (Note 1) To use the onboard D-Sub, DVI-D, and HDMI ports, you must install an Intel CPU with integrated graphics.  
 (Note 2) The DVI-D port does not support D-Sub connection by adapter.  
 (Note 3) You can use only one of the onboard digital graphics ports (HDMI and DVI-D) for output when in the BIOS Setup program or when during the POST screens.

## Dual Display Configurations for the Onboard Graphics:

The table below shows the supported/unsupported dual display configurations for the onboard graphics ports in different environments.

Combination	POST/BIOS	Windows
DVI-D + D-Sub	Yes	Yes
DVI-D + HDMI	No	Yes
HDMI + D-Sub	Yes	Yes

### ❶ Optical S/PDIF Out Connector

This connector provides digital audio out to an external audio system that supports digital optical audio. Before using this feature, ensure that your audio system provides an optical digital audio in connector.

### ❷ RJ-45 LAN Port

The Gigabit Ethernet LAN port provides Internet connection at up to 1 Gbps data rate. The following describes the states of the LAN port LEDs.

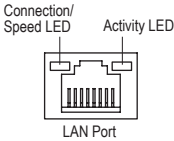

Connection/Speed LED:

State	Description
Orange	1 Gbps data rate
Green	100 Mbps data rate
Off	10 Mbps data rate

Activity LED:

State	Description
Blinking	Data transmission or receiving is occurring
Off	No data transmission or receiving is occurring

### ❸ Center/Subwoofer Speaker Out Jack (Orange)

Use this audio jack to connect center/subwoofer speakers in a 5.1/7.1-channel audio configuration.

### ❹ Rear Speaker Out Jack (Black)

Use this audio jack to connect rear speakers in a 4/5.1/7.1-channel audio configuration.

### ❺ Side Speaker Out Jack (Gray)

Use this audio jack to connect side speakers in a 7.1-channel audio configuration.

### ❻ Line In Jack (Blue)

The default line in jack. Use this audio jack for line in devices such as an optical drive, walkman, etc.

### ❼ Line Out Jack (Green)

The default line out jack. Use this audio jack for a headphone or 2-channel speaker. This jack can be used to connect front speakers in a 4/5.1/7.1-channel audio configuration.

### ❽ Mic In Jack (Pink)

The default Mic in jack. Microphones must be connected to this jack.



In addition to the default speakers settings, the ❶ ~ ❽ audio jacks can be reconfigured to perform different functions via the audio software. Only microphones still **MUST** be connected to the default Mic in jack (❽). Refer to the instructions on setting up a 2/4/5.1/7.1-channel audio configuration in Chapter 5, "Configuring 2/4/5.1/7.1-Channel Audio."



- When removing the cable connected to a back panel connector, first remove the cable from your device and then remove it from the motherboard.
- When removing the cable, pull it straight out from the connector. Do not rock it side to side to prevent an electrical short inside the cable connector.

# 1-7 Internal Connectors

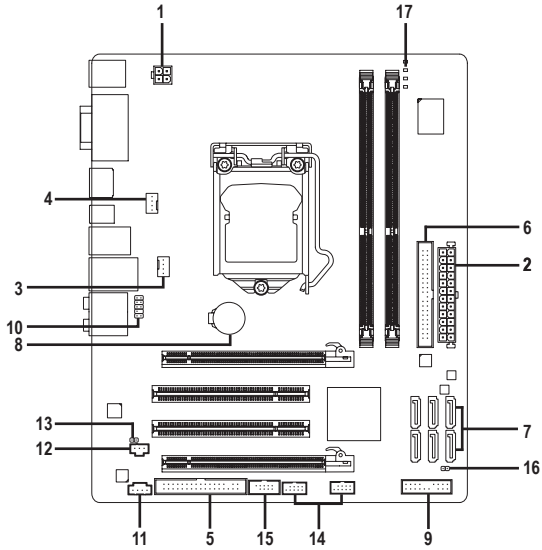

1)	ATX_12V	10)	F_AUDIO
2)	ATX	11)	CD_IN
3)	CPU_FAN	12)	SPDIF_I
4)	SYS_FAN	13)	SPDIF_O
5)	FDD	14)	F_USB1/F_USB2
6)	IDE	15)	COMA
7)	SATA_0/1/2/3/4/5	16)	CLR_CMOS
8)	BAT	17)	PHASE LED
9)	F_PANEL		



Read the following guidelines before connecting external devices:

- First make sure your devices are compliant with the connectors you wish to connect.
- Before installing the devices, be sure to turn off the devices and your computer. Unplug the power cord from the power outlet to prevent damage to the devices.
- After installing the device and before turning on the computer, make sure the device cable has been securely attached to the connector on the motherboard.

## 1/2) ATX\_12V/ATX (2x2 12V Power Connector and 2x12 Main Power Connector)

With the use of the power connector, the power supply can supply enough stable power to all the components on the motherboard. Before connecting the power connector, first make sure the power supply is turned off and all devices are properly installed. The power connector possesses a foolproof design. Connect the power supply cable to the power connector in the correct orientation. The 12V power connector mainly supplies power to the CPU. If the 12V power connector is not connected, the computer will not start.



To meet expansion requirements, it is recommended that a power supply that can withstand high power consumption be used (500W or greater). If a power supply is used that does not provide the required power, the result can lead to an unstable or unbootable system.

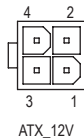
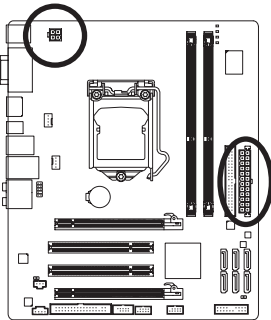

ATX\_12V:

Pin No.	Definition
1	GND
2	GND
3	+12V
4	+12V

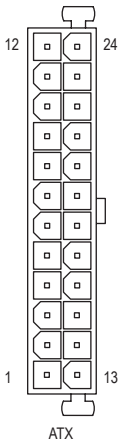

ATX:

Pin No.	Definition	Pin No.	Definition
1	3.3V	13	3.3V
2	3.3V	14	-12V
3	GND	15	GND
4	+5V	16	PS_ON (soft On/Off)
5	GND	17	GND
6	+5V	18	GND
7	GND	19	GND
8	Power Good	20	-5V
9	5VSB (stand by +5V)	21	+5V
10	+12V	22	+5V
11	+12V (Only for 2x12-pin ATX)	23	+5V (Only for 2x12-pin ATX)
12	3.3V (Only for 2x12-pin ATX)	24	GND (Only for 2x12-pin ATX)

### 3/4) CPU\_FAN/SYS\_FAN (Fan Headers)

The motherboard has a 4-pin CPU fan header (CPU\_FAN) and a 4-pin system fan header (SYS\_FAN). Most fan headers possess a foolproof insertion design. When connecting a fan cable, be sure to connect it in the correct orientation (the black connector wire is the ground wire). The motherboard supports CPU fan speed control, which requires the use of a CPU fan with fan speed control design. For optimum heat dissipation, it is recommended that a system fan be installed inside the chassis.

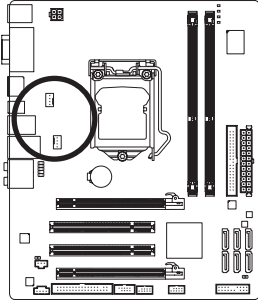

CPU\_FAN:

Pin No.	Definition
1	GND
2	+12V / Speed Control
3	Sense
4	Speed Control

SYS\_FAN:

Pin No.	Definition
1	GND
2	+12V / Speed Control
3	Sense
4	Reserve



- Be sure to connect fan cables to the fan headers to prevent your CPU and system from overheating. Overheating may result in damage to the CPU or the system may hang.
- These fan headers are not configuration jumper blocks. Do not place a jumper cap on the headers.

### 5) FDD (Floppy Disk Drive Connector)

This connector is used to connect a floppy disk drive. The types of floppy disk drives supported are: 360 KB, 720 KB, 1.2 MB, 1.44 MB, and 2.88 MB. Before connecting a floppy disk drive, be sure to locate pin 1 of the connector and the floppy disk drive cable. The pin 1 of the cable is typically designated by a stripe of different color. For purchasing the optional floppy disk drive cable, please contact the local dealer.

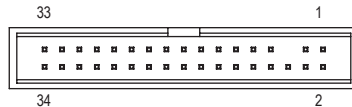
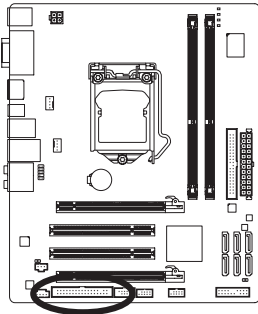

## 6) IDE (IDE Connector)

The IDE connector supports up to two IDE devices such as hard drives and optical drives. Before attaching the IDE cable, locate the foolproof groove on the connector. If you wish to connect two IDE devices, remember to set the jumpers and the cabling according to the role of the IDE devices (for example, master or slave). (For information about configuring master/slave settings for the IDE devices, read the instructions from the device manufacturers.)

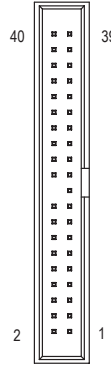
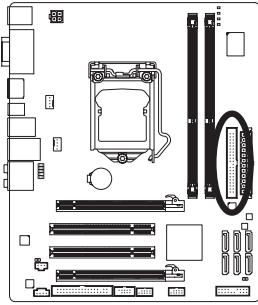

## 7) SATA2\_0/1/2/3/4/5 (SATA 3Gb/s Connectors, Controlled by H55 Chipset)

The SATA connectors conform to SATA 3Gb/s standard and are compatible with SATA 1.5Gb/s standard. Each SATA connector supports a single SATA device.

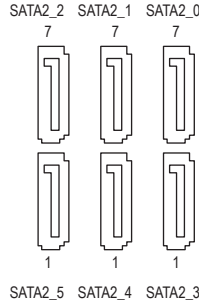
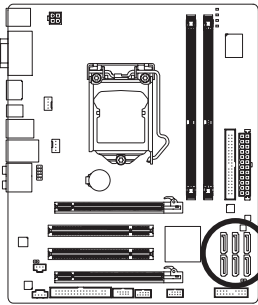

Pin No.	Definition
1	GND
2	TXP
3	TXN
4	GND
5	RXN
6	RXP
7	GND

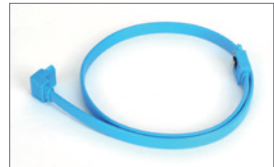

Please connect the L-shaped end of the SATA cable to your SATA hard drive.

## 8) BAT (Battery)

The battery provides power to keep the values (such as BIOS configurations, date, and time information) in the CMOS when the computer is turned off. Replace the battery when the battery voltage drops to a low level, or the CMOS values may not be accurate or may be lost.

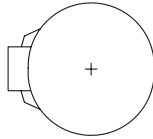
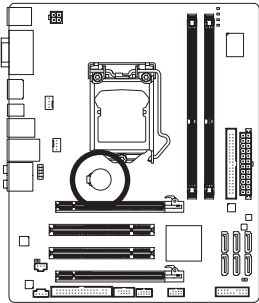

You may clear the CMOS values by removing the battery:

1. Turn off your computer and unplug the power cord.
2. Gently remove the battery from the battery holder and wait for one minute. (Or use a metal object like a screwdriver to touch the positive and negative terminals of the battery holder, making them short for 5 seconds.)
3. Replace the battery.
4. Plug in the power cord and restart your computer.



- Always turn off your computer and unplug the power cord before replacing the battery.
- Replace the battery with an equivalent one. Danger of explosion if the battery is replaced with an incorrect model.
- Contact the place of purchase or local dealer if you are not able to replace the battery by yourself or uncertain about the battery model.
- When installing the battery, note the orientation of the positive side (+) and the negative side (-) of the battery (the positive side should face up).
- Used batteries must be handled in accordance with local environmental regulations.

## 9) F\_PANEL (Front Panel Header)

Connect the power switch, reset switch, speaker, chassis intrusion switch/sensor and system status indicator on the chassis to this header according to the pin assignments below. Note the positive and negative pins before connecting the cables.

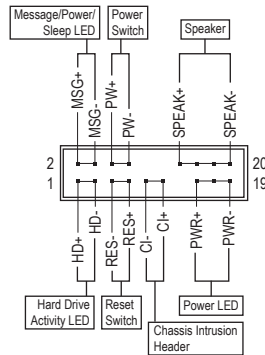
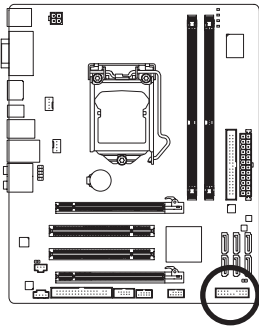

- **MSG/PWR** (Message/Power/Sleep LED, Yellow/Purple):

System Status	LED
S0	On
S1	Blinking
S3/S4/S5	Off

Connects to the power status indicator on the chassis front panel. The LED is on when the system is operating. The LED keeps blinking when the system is in S1 sleep state. The LED is off when the system is in S3/S4 sleep state or powered off (S5).

- **PW** (Power Switch, Red):

Connects to the power switch on the chassis front panel. You may configure the way to turn off your system using the power switch (refer to Chapter 2, "BIOS Setup," "Power Management Setup," for more information).

- **SPEAK** (Speaker, Orange):

Connects to the speaker on the chassis front panel. The system reports system startup status by issuing a beep code. One single short beep will be heard if no problem is detected at system startup. If a problem is detected, the BIOS may issue beeps in different patterns to indicate the problem. Refer to Chapter 5, "Troubleshooting," for information about beep codes.

- **HD** (Hard Drive Activity LED, Blue)

Connects to the hard drive activity LED on the chassis front panel. The LED is on when the hard drive is reading or writing data.

- **RES** (Reset Switch, Green):

Connects to the reset switch on the chassis front panel. Press the reset switch to restart the computer if the computer freezes and fails to perform a normal restart.

- **CI** (Chassis Intrusion Header, Gray):

Connects to the chassis intrusion switch/sensor on the chassis that can detect if the chassis cover has been removed. This function requires a chassis with a chassis intrusion switch/sensor.



The front panel design may differ by chassis. A front panel module mainly consists of power switch, reset switch, power LED, hard drive activity LED, speaker and etc. When connecting your chassis front panel module to this header, make sure the wire assignments and the pin assignments are matched correctly.

## 10) F\_AUDIO (Front Panel Audio Header)

The front panel audio header supports Intel High Definition audio (HD) and AC'97 audio. You may connect your chassis front panel audio module to this header. Make sure the wire assignments of the module connector match the pin assignments of the motherboard header. Incorrect connection between the module connector and the motherboard header will make the device unable to work or even damage it.

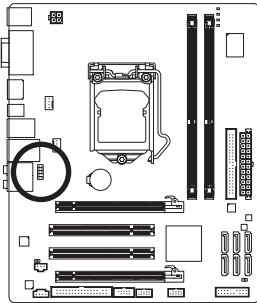

For HD Front Panel Audio:

Pin No.	Definition
1	MIC2_L
2	GND
3	MIC2_R
4	-ACZ_DET
5	LINE2_R
6	GND
7	FAUDIO_JD
8	No Pin
9	LINE2_L
10	GND

For AC'97 Front Panel Audio:

Pin No.	Definition
1	MIC
2	GND
3	MIC Power
4	NC
5	Line Out (R)
6	NC
7	NC
8	No Pin
9	Line Out (L)
10	NC



- The front panel audio header supports HD audio by default. If your chassis provides an AC'97 front panel audio module, refer to the instructions on how to activate AC'97 functionality via the audio software in Chapter 5, "Configuring 2/4/5.1/7.1-Channel Audio."
- Audio signals will be present on both of the front and back panel audio connections simultaneously. If you want to mute the back panel audio (only supported when using an HD front panel audio module), refer to Chapter 5, "Configuring 2/4/5.1/7.1-Channel Audio."
- Some chassis provide a front panel audio module that has separated connectors on each wire instead of a single plug. For information about connecting the front panel audio module that has different wire assignments, please contact the chassis manufacturer.

## 11) CD\_IN (CD In Connector)

You can connect the audio cable that came with your optical drive to the header.

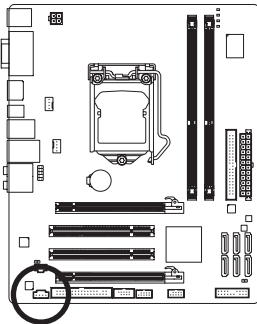

Pin No.	Definition
1	CD-L
2	GND
3	GND
4	CD-R

## 12) SPDIF\_I (S/PDIF In Header)

This header supports digital S/PDIF In and can connect to an audio device that supports digital audio out via an optional S/PDIF In cable. For purchasing the optional S/PDIF In cable, please contact the local dealer.

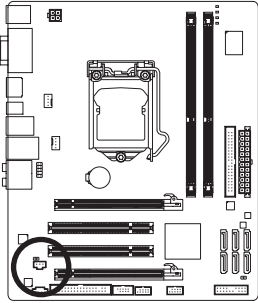

Pin No.	Definition
1	Power
2	SPDIFI
3	GND

## 13) SPDIF\_O (S/PDIF Out Header)

This header supports digital S/PDIF Out and connects a S/PDIF digital audio cable (provided by expansion cards) for digital audio output from your motherboard to certain expansion cards like graphics cards and sound cards. For example, some graphics cards may require you to use a S/PDIF digital audio cable for digital audio output from your motherboard to your graphics card if you wish to connect an HDMI display to the graphics card and have digital audio output from the HDMI display at the same time. For information about connecting the S/PDIF digital audio cable, carefully read the manual for your expansion card.

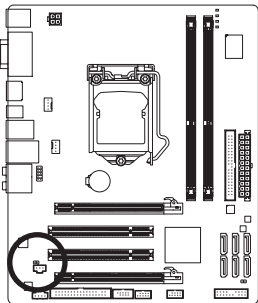

Pin No.	Definition
1	SPDIFO
2	GND

#### 14) F\_USB1/F\_USB2 (USB Headers)

The headers conform to USB 2.0/1.1 specification. Each USB header can provide two USB ports via an optional USB bracket. For purchasing the optional USB bracket, please contact the local dealer.

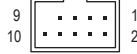
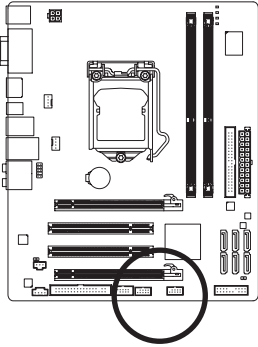

Pin No.	Definition
1	Power (5V)
2	Power (5V)
3	USB DX-
4	USB DY-
5	USB DX+
6	USB DY+
7	GND
8	GND
9	No Pin
10	NC



- Do not plug the IEEE 1394 bracket (2x5-pin) cable into the USB header.
- Prior to installing the USB bracket, be sure to turn off your computer and unplug the power cord from the power outlet to prevent damage to the USB bracket.

#### 15) COMA (Serial Port Header)

The COMA header can provide one serial port via an optional COM port cable. For purchasing the optional COM port cable, please contact the local dealer.

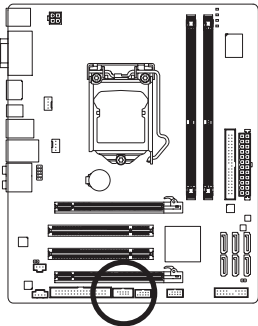

Pin No.	Definition
1	NDCC-
2	NSIN
3	NSOUT
4	NDTR-
5	GND
6	NDSR-
7	NRTS-
8	NCTS-
9	NRI-
10	No Pin

## 16) CLR\_CMOS (Clearing CMOS Jumper)

Use this jumper to clear the CMOS values (e.g. date information and BIOS configurations) and reset the CMOS values to factory defaults. To clear the CMOS values, place a jumper cap on the two pins or temporarily short the two pins or use a metal object like a screwdriver to touch the two pins for a few seconds.

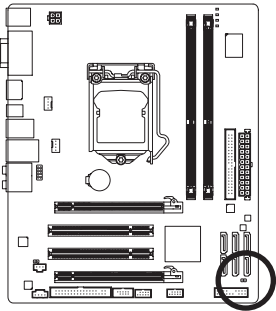

 Open: Normal

 Short: Clear CMOS Values



- Always turn off your computer and unplug the power cord from the power outlet before clearing the CMOS values.
- After clearing the CMOS values and before turning on your computer, be sure to remove the jumper cap from the jumper. Failure to do so may cause damage to the motherboard.
- After system restart, go to BIOS Setup to load factory defaults (select **Load Optimized Defaults**) or manually configure the BIOS settings (refer to Chapter 2, "BIOS Setup," for BIOS configurations).

## 17) PHASE LED

The number of lighted LEDs indicates the CPU loading. The higher the CPU loading, the more the number of lighted LEDs. To enable the Phase LED display function, please first enable Dynamic Energy Saver™ 2. Refer to Chapter 4, "Dynamic Energy Saver™ 2," for more details.

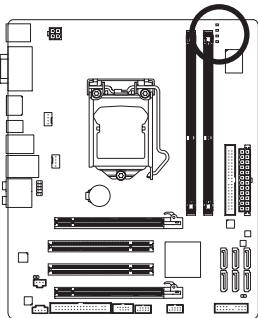

## Chapter 2 BIOS Setup

BIOS (Basic Input and Output System) records hardware parameters of the system in the CMOS on the motherboard. Its major functions include conducting the Power-On Self-Test (POST) during system startup, saving system parameters and loading operating system, etc. BIOS includes a BIOS Setup program that allows the user to modify basic system configuration settings or to activate certain system features. When the power is turned off, the battery on the motherboard supplies the necessary power to the CMOS to keep the configuration values in the CMOS.

To access the BIOS Setup program, press the <Delete> key during the POST when the power is turned on. To see more advanced BIOS Setup menu options, you can press <Ctrl> + <F1> in the main menu of the BIOS Setup program.

To upgrade the BIOS, use either the GIGABYTE Q-Flash or @BIOS utility.

- Q-Flash allows the user to quickly and easily upgrade or back up BIOS without entering the operating system.
- @BIOS is a Windows-based utility that searches and downloads the latest version of BIOS from the Internet and updates the BIOS.

For instructions on using the Q-Flash and @BIOS utilities, refer to Chapter 4, "BIOS Update Utilities."



- Because BIOS flashing is potentially risky, if you do not encounter problems using the current version of BIOS, it is recommended that you not flash the BIOS. To flash the BIOS, do it with caution. Inadequate BIOS flashing may result in system malfunction.
- BIOS will emit a beep code during the POST. Refer to Chapter 5, "Troubleshooting," for the beep codes description.
- It is recommended that you not alter the default settings (unless you need to) to prevent system instability or other unexpected results. Inadequately altering the settings may result in system's failure to boot. If this occurs, try to clear the CMOS values and reset the board to default values. (Refer to the "Load Optimized Defaults" section in this chapter or introductions of the clearing CMOS jumper/battery in Chapter 1 for how to clear the CMOS values.)

## 2-1 Startup Screen

The following screens may appear when the computer boots.

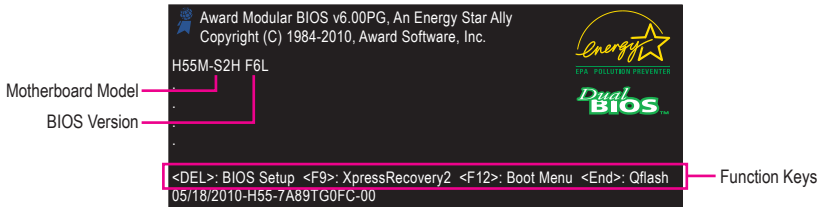

### Function Keys:

#### <DEL>: BIOS SETUP

Press the <Delete> key to enter BIOS Setup or to access the Q-Flash utility in BIOS Setup.

#### <F9>: XPRESS RECOVERY2

If you have ever entered Xpress Recovery2 to back up hard drive data using the driver disk, the <F9> key can be used for subsequent access to Xpress Recovery2 during the POST. For more information, refer to Chapter 4, "Xpress Recovery2."

#### <F12>: BOOT MENU

Boot Menu allows you to set the first boot device without entering BIOS Setup. In Boot Menu, use the up arrow key <↑> or the down arrow key <↓> to select the first boot device, then press <Enter> to accept. To exit Boot Menu, press <Esc>. The system will directly boot from the device configured in Boot Menu. Note: The setting in Boot Menu is effective for one time only. After system restart, the device boot order will still be based on BIOS Setup settings. You can access Boot Menu again to change the first boot device setting as needed.

#### <END>: Q-FLASH

Press the <End> key to access the Q-Flash utility directly without having to enter BIOS Setup first.

## 2-2 The Main Menu

Once you enter the BIOS Setup program, the Main Menu (as shown below) appears on the screen. Use arrow keys to move among the items and press <Enter> to accept or enter a sub-menu.

(Sample BIOS Version: GA-H55M-S2H, F6L)

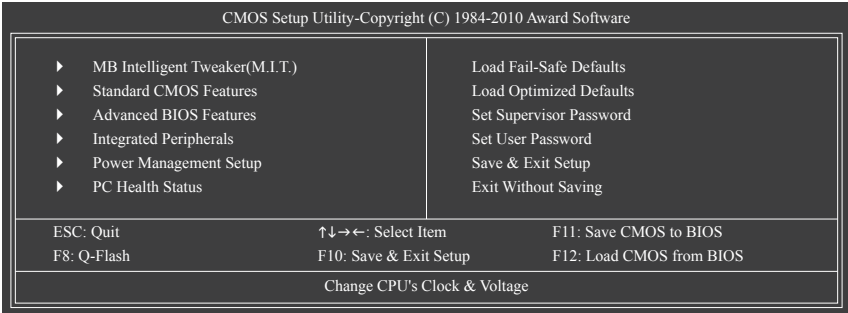

### BIOS Setup Program Function Keys

<↑><↓><←><→>	Move the selection bar to select an item
<Enter>	Execute command or enter the submenu
<Esc>	Main Menu: Exit the BIOS Setup program Submenus: Exit current submenu
<Page Up>	Increase the numeric value or make changes
<Page Down>	Decrease the numeric value or make changes
<F1>	Show descriptions of the function keys
<F2>	Move cursor to the Item Help block on the right (submenus only)
<F5>	Restore the previous BIOS settings for the current submenus
<F6>	Load the Fail-Safe BIOS default settings for the current submenu
<F7>	Load the Optimized BIOS default settings for the current submenu
<F8>	Access the Q-Flash utility
<F9>	Display system information
<F10>	Save all the changes and exit the BIOS Setup program
<F11>	Save CMOS to BIOS
<F12>	Load CMOS from BIOS

### Main Menu Help

The on-screen description of a highlighted setup option is displayed on the bottom line of the Main Menu.

### Submenu Help

While in a submenu, press <F1> to display a help screen (General Help) of function keys available for the menu. Press <Esc> to exit the help screen. Help for each item is in the Item Help block on the right side of the submenu.



- If you do not find the settings you want in the Main Menu or a submenu, press <Ctrl>+<F1> to access more advanced options.
- When the system is not stable as usual, select the **Load Optimized Defaults** item to set your system to its defaults.
- The BIOS Setup menus described in this chapter are for reference only and may differ by BIOS version.

## ■ The Functions of the <F11> and <F12> keys (For the Main Menu Only)

### ▶ F11: Save CMOS to BIOS

This function allows you to save the current BIOS settings to a profile. You can create up to 8 profiles (Profile 1-8) and name each profile. First enter the profile name (to erase the default profile name, use the SPACE key) and then press <Enter> to complete.

### ▶ F12: Load CMOS from BIOS

If your system becomes unstable and you have loaded the BIOS default settings, you can use this function to load the BIOS settings from a profile created before, without the hassles of reconfiguring the BIOS settings. First select the profile you wish to load, then press <Enter> to complete.

## ■ MB Intelligent Tweaker(M.I.T.)

Use this menu to configure the clock, frequency and voltages of your CPU, memory, etc.

## ■ Standard CMOS Features

Use this menu to configure the system time and date, hard drive types, floppy disk drive types, and the type of errors that stop the system boot, etc.

## ■ Advanced BIOS Features

Use this menu to configure the device boot order, advanced features available on the CPU, and the primary display adapter.

## ■ Integrated Peripherals

Use this menu to configure all peripheral devices, such as IDE, SATA, USB, integrated audio, and integrated LAN, etc.

## ■ Power Management Setup

Use this menu to configure all the power-saving functions.

## ■ PC Health Status

Use this menu to see information about autodetected system/CPU temperature, system voltage and fan speed, etc.

## ■ Load Fail-Safe Defaults

Fail-Safe defaults are factory settings for the most stable, minimal-performance system operations.

## ■ Load Optimized Defaults

Optimized defaults are factory settings for optimal-performance system operations.

## ■ Set Supervisor Password

Change, set, or disable password. It allows you to restrict access to the system and BIOS Setup.

A supervisor password allows you to make changes in BIOS Setup.

## ■ Set User Password

Change, set, or disable password. It allows you to restrict access to the system and BIOS Setup.

A user password only allows you to view the BIOS settings but not to make changes.

## ■ Save & Exit Setup

Save all the changes made in the BIOS Setup program to the CMOS and exit BIOS Setup. (Pressing <F10> can also carry out this task.)

## ■ Exit Without Saving

Abandon all changes and the previous settings remain in effect. Pressing <Y> to the confirmation message will exit BIOS Setup. (Pressing <Esc> can also carry out this task.)

## 2-3 MB Intelligent Tweaker(M.I.T.)

CMOS Setup Utility-Copyright (C) 1984-2010 Award Software  
MB Intelligent Tweaker(M.I.T.)

<ul style="list-style-type: none"> <li>▶ M.I.T Current Status [Press Enter]</li> <li>▶ Advanced Frequency Settings [Press Enter]</li> <li>▶ Advanced Memory Settings [Press Enter]</li> <li>▶ Advanced Voltage Settings [Press Enter]</li> <li>▶ Miscellaneous Settings [Press Enter]</li> </ul> <p>BIOS Version F6L            BCLK 133.27 MHz            CPU Frequency 3198.42 MHz            Memory Frequency 1332.80 MHz            Total Memory Size 1024 MB</p> <p>CPU Temperature 24°C            PCH Temperature 40°C</p> <p>Vcore 0.992V            DRAM Voltage 1.584V</p>	<p>Item Help</p> <p>Menu Level ▶</p>
↑↓→←: Move    Enter: Select    +/-/PU/PD: Value    F10: Save    ESC: Exit    F1: General Help F5: Previous Values    F6: Fail-Safe Defaults                                    F7: Optimized Defaults	



Whether the system will work stably with the overclock/overvoltage settings you made is dependent on your overall system configurations. Incorrectly doing overclock/overvoltage may result in damage to CPU, chipset, or memory and reduce the useful life of these components. This page is for advanced users only and we recommend you not to alter the default settings to prevent system instability or other unexpected results. (Inadequately altering the settings may result in system's failure to boot. If this occurs, clear the CMOS values and reset the board to default values.)

### ▶ M.I.T. Current Status

This screen provides information on CPU/memory frequencies/parameters.

### ▶ Advanced Frequency Settings

CMOS Setup Utility-Copyright (C) 1984-2010 Award Software  
Advanced Frequency Settings

<p>CPU Clock Ratio [22X]            CPU Frequency 2.93GHz (133x22)</p> <ul style="list-style-type: none"> <li>▶ Advanced CPU Core Features [Press Enter]</li> <li>QPI Clock Ratio [Auto]</li> <li>QPI Link Speed 4.8GHz</li> <li>&gt;&gt;&gt;&gt; Standard Clock Control</li> <li>Base Clock(BCLK) Control [Disabled]</li> <li>x BCLK Frequency (Mhz) 133</li> <li>Extreme Memory Profile (X.M.P.) (Note) [Disabled]</li> <li>System Memory Multiplier (SPD) [Auto]</li> <li>Memory Frequency (Mhz) 1333</li> <li>Internal Graphics Clock 733 [Auto]</li> <li>PCI Express Frequency (Mhz) [Auto]</li> <li>&gt;&gt;&gt;&gt; Advanced Clock Control</li> <li>CPU Clock Drive [900mV]</li> <li>PCI Express Clock Drive [900mV]</li> <li>CPU Clock Skew [0ps]</li> <li>PCH Clock Skew [0ps]</li> </ul>	<p>Item Help</p> <p>Menu Level ▶</p>
↑↓→←: Move    Enter: Select    +/-/PU/PD: Value    F10: Save    ESC: Exit    F1: General Help F5: Previous Values    F6: Fail-Safe Defaults                                    F7: Optimized Defaults	

(Note) This item appears only if you install a memory module that supports this feature.

## ☞ CPU Clock Ratio

Allows you to alter the clock ratio for the installed CPU. The adjustable range is dependent on the CPU being installed.

## ☞ CPU Frequency

Displays the current operating CPU frequency.

## ▶ Advanced CPU Core Features

CMOS Setup Utility-Copyright (C) 1984-2010 Award Software		Item Help
Advanced CPU Core Features		Menu Level ▶▶
Intel(R) Turbo Boost Tech. <sup>(Note)</sup>	[Auto]	
CPU Cores Enabled <sup>(Note)</sup>	[All]	
CPU Multi-Threading <sup>(Note)</sup>	[Enabled]	
CPU Enhanced Halt (C1E) <sup>(Note)</sup>	[Auto]	
C3/C6/C7 State Support <sup>(Note)</sup>	[Auto]	
CPU Thermal Monitor <sup>(Note)</sup>	[Auto]	
CPU EIST Function <sup>(Note)</sup>	[Auto]	
Bi-Directional PROCHOT <sup>(Note)</sup>	[Auto]	

↑↓→←: Move    Enter: Select    +/-/PU/PD: Value    F10: Save    ESC: Exit    F1: General Help  
F5: Previous Values    F6: Fail-Safe Defaults    F7: Optimized Defaults

## ☞ Intel(R) Turbo Boost Tech. <sup>(Note)</sup>

Allows you to determine whether to enable the Intel CPU Turbo Boost technology. **Auto** lets the BIOS automatically configure this setting. (Default: Auto)

## ☞ CPU Cores Enabled <sup>(Note)</sup>

Allows you to determine whether to enable all CPU cores.

- ▶▶ All      Enables all CPU cores. (Default)
- ▶▶ 1        Enables only one CPU core.
- ▶▶ 2        Enables only two CPU cores.
- ▶▶ 3        Enables only three CPU cores.

## ☞ CPU Multi-Threading <sup>(Note)</sup>

Allows you to determine whether to enable multi-threading technology when using an Intel CPU that supports this function. This feature only works for operating systems that support multi-processor mode. (Default: Enabled)

## ☞ CPU Enhanced Halt (C1E) <sup>(Note)</sup>

Enables or disables Intel CPU Enhanced Halt (C1E) function, a CPU power-saving function in system halt state. When enabled, the CPU core frequency and voltage will be reduced during system halt state to decrease power consumption. **Auto** lets the BIOS automatically configure this setting. (Default: Auto)

(Note) This item is present only if you install a CPU that supports this feature. For more information about Intel CPUs' unique features, please visit Intel's website.

### ☞ **C3/C6/C7 State Support** <sup>(Note 1)</sup>

Allows you to determine whether to let the CPU enter C3/C6/C7 mode in system halt state. When enabled, the CPU core frequency and voltage will be reduced during system halt state to decrease power consumption. The C3/C6/C7 state is a more enhanced power-saving state than C1. **Auto** lets the BIOS automatically configure this setting. (Default: Auto)

### ☞ **CPU Thermal Monitor** <sup>(Note 1)</sup>

Enables or disables Intel CPU Thermal Monitor function, a CPU overheating protection function. When enabled, the CPU core frequency and voltage will be reduced when the CPU is overheated. **Auto** lets the BIOS automatically configure this setting. (Default: Auto)

### ☞ **CPU EIST Function** <sup>(Note 1)</sup>

Enables or disables Enhanced Intel SpeedStep Technology (EIST). Depending on CPU loading, Intel EIST technology can dynamically and effectively lower the CPU voltage and core frequency to decrease average power consumption and heat production. **Auto** lets the BIOS automatically configure this setting. (Default: Auto)

### ☞ **Bi-Directional PROCHOT** <sup>(Note 1)</sup>

- ▶▶ Auto Lets the BIOS automatically configure this setting. (Default)
- ▶▶ Enabled When the CPU or chipset detects that an overheating is occurring, PROCHOT signals will be emitted to lower CPU performance to decrease heat production.
- ▶▶ Disabled Only allows the CPU to detect whether an overheating is occurring to emit PROCHOT signals.

### ☞ **QPI Clock Ratio**

Allows you to set the QPI clock ratio. Options are: Auto (default), x12~x44. The item is adjustable only if a CPU with unlocked clock ratio is installed. The adjustable range is dependent on the CPU being installed.

### ☞ **QPI Link Speed**

Displays the current operating QPI link speed.

## >>>> **Standard Clock Control**

### ☞ **Base Clock(BCLK) Control**

Enables or disables the control of CPU base clock. **Enabled** will allow the **BCLK Frequency(Mhz)** item below to be configurable. Note: If your system fails to boot after overclocking, please wait for 20 seconds to allow for automated system reboot, or clear the CMOS values to reset the board to default values. (Default: Disabled)

### ☞ **BCLK Frequency(Mhz)**

Allows you to manually set the CPU base clock. The adjustable range is from 100 MHz to 600 MHz. This item is configurable only if the **Base Clock(BCLK) Control** option is enabled.

**Important:** It is highly recommended that the CPU frequency be set in accordance with the CPU specifications.

### ☞ **Extreme Memory Profile (X.M.P.)** <sup>(Note 2)</sup>

Allows the BIOS to read the SPD data on XMP memory module(s) to enhance memory performance when enabled.

- ▶▶ Disabled Disables this function. (Default)
- ▶▶ Profile1 Uses Profile 1 settings.
- ▶▶ Profile2 <sup>(Note 2)</sup> Uses Profile 2 settings.

(Note 1) This item is present only if you install a CPU that supports this feature. For more information about Intel CPUs' unique features, please visit Intel's website.

(Note 2) This item appears only if you install a memory module that supports this feature.

### ☞ System Memory Multiplier (SPD)

Allows you to set the system memory multiplier. **Auto** sets memory multiplier according to memory SPD data. (Default: Auto)

### ☞ Memory Frequency(Mhz)

The first memory frequency value is the normal operating frequency of the memory being used; the second is the memory frequency that is automatically adjusted according to the **BCLK Frequency(Mhz)** and **System Memory Multiplier** settings.

### ☞ Internal Graphics Clock

Allows you to set the onboard graphics clock. The adjustable range is from 400 MHz to 2000 MHz. (Default: Auto)

### ☞ PCI Express Frequency(Mhz)

Allows you to manually set the PCIe clock frequency. The adjustable range is from 90 MHz to 150 MHz. **Auto** sets the PCIe clock frequency to standard 100 MHz. (Default: Auto)

## >>>>> Advanced Clock Control

### ☞ CPU Clock Drive

Allows you to adjust the amplitude of the CPU and the Chipset clock.  
Options are: 700mV, 800mV, 900mV (default), 1000mV.

### ☞ PCI Express Clock Drive

Allows you to adjust the amplitude of the PCI Express and Chipset clock.  
Options are: 700mV, 800mV, 900mV (default), 1000mV.

### ☞ CPU Clock Skew

Allows you to set the CPU clock prior to the Chipset clock.  
Options are: 0ps~750ps. (Default: 0ps)

### ☞ PCH Clock Skew

Allows you to set the Chipset clock prior to the CPU clock.  
Options are: 0ps~750ps. (Default: 0ps)

## ▶ Advanced Memory Settings

CMOS Setup Utility-Copyright (C) 1984-2010 Award Software		
Advanced Memory Settings		
Extreme Memory Profile (X.M.P.) <sup>(Note)</sup>	[Disabled]	Item Help
System Memory Multiplier (SPD)	[Auto]	Menu Level ▶▶
Memory Frequency (Mhz)	1333	
Performance Enhance	[Turbo]	
DRAM Timing Selectable (SPD)	[Auto]	
Profile DDR Voltage	1.5V	
Profile QPI Voltage	1.15V	
>>>>> Channel A		
▶ Channel A Timing Settings	[Press Enter]	
>>>>> Channel B		
▶ Channel B Timing Settings	[Press Enter]	

↑↓ → ←: Move    Enter: Select    +/-/PU/PD: Value    F10: Save    ESC: Exit    F1: General Help  
F5: Previous Values    F6: Fail-Safe Defaults    F7: Optimized Defaults

(Note) This item appears only if you install a memory module that supports this feature.

☞ **Extreme Memory Profile (X.M.P.)<sup>(Note)</sup>, System Memory Multiplier (SPD), Memory Frequency(Mhz)**

The settings under the three items above are synchronous to those under the same items on the **MB Intelligent Tweaker(M.I.T.)** main menu.

☞ **Performance Enhance**

Allows the system to operate at three different performance levels.

- ▶▶ Standard Lets the system operate at its basic performance level.
- ▶▶ Turbo Lets the system operate at its good performance level. (Default)
- ▶▶ Extreme Lets the system operate at its best performance level.

☞ **DRAM Timing Selectable (SPD)**

**Quick** and **Expert** allows the memory timing settings below to be configurable. Options are: Auto (default), Quick, Expert.

☞ **Profile DDR Voltage**

When using a non-XMP memory module or **Extreme Memory Profile (X.M.P.)** is set to **Disabled**, this item will display as **1.5V**. When **Extreme Memory Profile (X.M.P.)** is set to **Profile1** or **Profile2**, this item will display the value based on the SPD data on the XMP memory.

☞ **Profile QPI Voltage**

The value displayed here is dependent on the CPU being used.

**>>>> Channel A/B Timing Settings**

CMOS Setup Utility-Copyright (C) 1984-2010 Award Software			Channel A Timing Settings		Item Help
>>>> Channel A Standard Timing Control					Menu Level ▶▶▶
x	CAS Latency Time	7	Auto		
x	tRCD	7	Auto		
x	tRP	7	Auto		
x	tRAS	20	Auto		
>>>> Channel A Advanced Timing Control					
x	tRC	28	Auto		
x	tRRD	4	Auto		
x	tWTR	5	Auto		
x	tWR	10	Auto		
x	tWTP	21	Auto		
x	tWL	7	Auto		
x	tRFC	60	Auto		
x	tRTP	5	Auto		
x	tFAW	16	Auto		
x	Command Rate (CMD)	1	Auto		
>>>> Channel A Misc Timing Control					
x	Static tRD	1	Auto		
↑↓←→: Move    Enter: Select    +/-/PU/PD: Value    F10: Save    ESC: Exit    F1: General Help F5: Previous Values    F6: Fail-Safe Defaults    F7: Optimized Defaults					

**>>>> Channel A/B Standard Timing Control**

☞ **CAS Latency Time**

Options are: Auto (default), 5~15.

☞ **tRCD**

Options are: Auto (default), 1~15.

☞ **tRP**

Options are: Auto (default), 1~15.

☞ **tRAS**

Options are: Auto (default), 1~31.

(Note) This item appears only if you install a memory module that supports this feature.

>>>> Channel A/B Advanced Timing Control

⌂ **tRC**

Options are: Auto (default), 1~63.

⌂ **tRRD**

Options are: Auto (default), 1~7.

⌂ **tWTR**

Options are: Auto (default), 1~31.

⌂ **tWR**

Options are: Auto (default), 1~15.

⌂ **tWTP**

Options are: Auto (default), 1~31.

⌂ **tWL**

Options are: Auto (default), 1~10

⌂ **tRFC**

Options are: Auto (default), 1~255.

⌂ **tRTP**

Options are: Auto (default), 1~15.

⌂ **tFAW**

Options are: Auto (default), 1~63.

⌂ **Command Rate(CMD)**

Options are: Auto (default), 1~3.

>>>> Channel A/B Misc Timing Control

⌂ **Static tRD**

Options are: Auto (default), 1~31.

▶ **Advanced Voltage Settings**

CMOS Setup Utility-Copyright (C) 1984-2010 Award Software  
Advanced Voltage Settings

***** Mother Board Voltage Control *****			Item Help	
Voltage Types	Normal	Current		
<hr/>				
>>> CPU				
Load-Line Calibration		[Auto]		
CPU Vcore	1.17500V	[Auto]		
Dynamic Vcore(DVID)	+0.00000V	Auto		
QPI/Vtt Voltage	1.100V	[Auto]		
Graphics Core	1.112V	[Auto]		
>>> MCH/ICH				
PCH Core	1.050V	[Auto]		
CPU PLL	1.800V	[Auto]		
>>> DRAM				
DRAM Voltage	1.500V	[Auto]		
DRAM Termination	0.750V	[Auto]		
Ch-A Data VRef.	0.750V	[Auto]		
Ch-B Data VRef.	0.750V	[Auto]		
Ch-A Address VRef.	0.750V	[Auto]		
Ch-B Address VRef.	0.750V	[Auto]		
↑↓←→: Move    Enter: Select    +/-/PU/PD: Value    F10: Save    ESC: Exit    F1: General Help F5: Previous Values    F6: Fail-Safe Defaults    F7: Optimized Defaults				

## >>> CPU

### ☞ Load-Line Calibration

Enables or disables Load-Line Calibration. Enabling this feature adjusts Vdroop, keeping the CPU voltage more constant under light and heavy CPU load. **Disabled** sets the CPU voltage following Intel specifications. **Auto** lets the BIOS automatically configure this setting. (Default: Auto)

Note: Enabling Load-Line Calibration may result in damage to your CPU or reduce the useful life of the CPU.

### ☞ CPU Vcore

The default is **Auto**.

### ☞ Dynamic Vcore(DVID)

This option is configurable only when **CPU Vcore** is set to **Normal**. The default is **Auto**.

### ☞ QPI/Vtt Voltage

The default is **Auto**.

### ☞ Graphics Core

The default is **Auto**.

## >>> MCH/ICH

### ☞ PCH Core

The default is **Auto**.

### ☞ CPU PLL

The default is **Auto**.

## >>> DRAM

### ☞ DRAM Voltage

The default is **Auto**.

### ☞ DRAM Termination

The default is **Auto**.

### ☞ Ch-A Data VRef.

The default is **Auto**.

### ☞ Ch-B Data VRef.

The default is **Auto**.

### ☞ Ch-A Address VRef.

The default is **Auto**.

### ☞ Ch-B Address VRef.

The default is **Auto**.

► **Miscellaneous Settings**

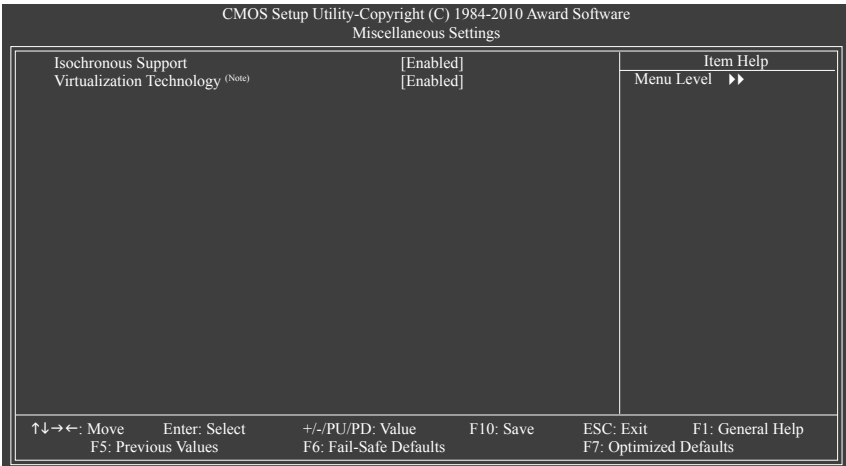

☞ **Isochronous Support**

Determines whether to enable specific streams within the CPU and Chipset. (Default: Enabled)

☞ **Virtualization Technology <sup>(Note)</sup>**

Enables or disables Intel Virtualization Technology. Virtualization enhanced by Intel Virtualization Technology will allow a platform to run multiple operating systems and applications in independent partitions. With virtualization, one computer system can function as multiple virtual systems. (Default: Enabled)

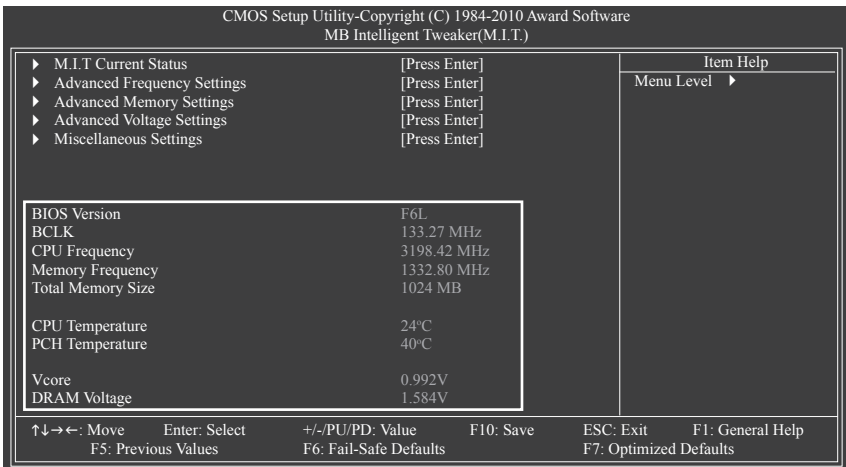

This section provides information on the BIOS version, CPU base clock, CPU frequency, memory frequency, total memory size, CPU temperature, Chipset temperature, Vcore, and memory voltage.

(Note) This item is present only if you install a CPU that supports this feature. For more information about Intel CPUs' unique features, please visit Intel's website.

## 2-4 Standard CMOS Features

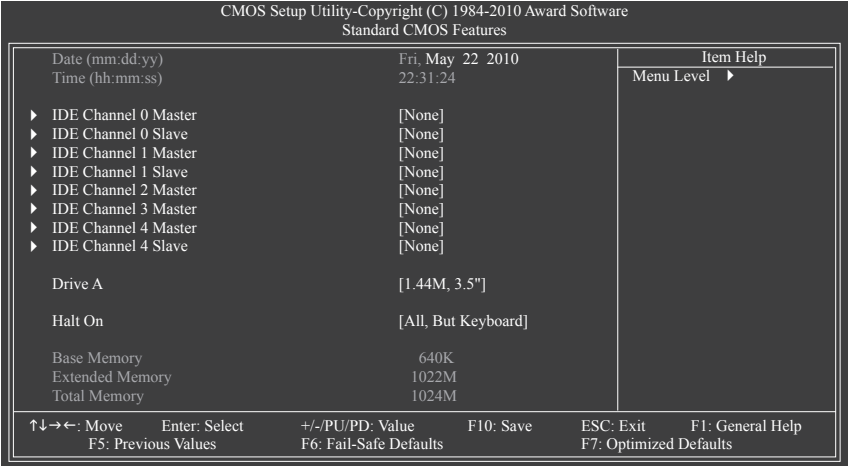

### ☞ Date (mm:dd:yy)

Sets the system date. The date format is week (read-only), month, date and year. Select the desired field and use the up arrow or down arrow key to set the date.

### ☞ Time (hh:mm:ss)

Sets the system time. For example, 1 p.m. is 13:0:0. Select the desired field and use the up arrow or down arrow key to set the time.

### ☞ IDE Channel 0, 1 Master/Slave

#### ▶▶ IDE Channel 0, 1 Master/Slave

Configure your IDE/SATA devices by using one of the three methods below:

- Auto                      Lets the BIOS automatically detect IDE/SATA devices during the POST. (Default)
- None                      If no IDE/SATA devices are used, set this item to **None** so the system will skip the detection of the device during the POST for faster system startup.
- Manual                    Allows you to manually enter the specifications of the hard drive when the hard drive access mode is set to **CHS**.

▶▶ Access Mode            Sets the hard drive access mode. Options are: Auto (default), CHS, LBA, Large.

### ☞ IDE Channel 2, 3 Master, 4 Master/Slave

#### ▶▶ Extended IDE Drive

Configure your IDE/SATA devices by using one of the two methods below:

- Auto                      Lets the BIOS automatically detect IDE/SATA devices during the POST. (Default)
- None                      If no IDE/SATA devices are used, set this item to **None** so the system will skip the detection of the device during the POST for faster system startup.

▶▶ Access Mode            Sets the hard drive access mode. Options are: Auto (default), Large.

The following fields display your hard drive specifications. If you wish to enter the parameters manually, refer to the information on the hard drive.

- ▶▶ Capacity                Approximate capacity of the currently installed hard drive.
- ▶▶ Cylinder                Number of cylinders.

- ▶▶ Head                      Number of heads.
- ▶▶ Precomp                 Write precompensation cylinder.
- ▶▶ Landing Zone            Landing zone.
- ▶▶ Sector                    Number of sectors.

#### ☞ **Drive A**

Allows you to select the type of floppy disk drive installed in your system. If you do not install a floppy disk drive, set this item to **None**. Options are: None, 360K/5.25", 1.2M/5.25", 720K/3.5", 1.44M/3.5", 2.88M/3.5".

#### ☞ **Halt On**

Allows you to determine whether the system will stop for an error during the POST.

- ▶▶ All Errors                 Whenever the BIOS detects a non-fatal error the system boot will stop.
- ▶▶ No Errors                 The system boot will not stop for any error.
- ▶▶ All, But Keyboard        The system boot will not stop for a keyboard error but stop for all other errors. (Default)
- ▶▶ All, But Diskette        The system boot will not stop for a floppy disk drive error but stop for all other errors.
- ▶▶ All, But Disk/Key        The system boot will not stop for a keyboard or a floppy disk drive error but it will stop for all other errors.

#### ☞ **Memory**

These fields are read-only and are determined by the BIOS POST.

- ▶▶ Base Memory             Also called conventional memory. Typically, 640 KB will be reserved for the MS-DOS operating system.
- ▶▶ Extended Memory        The amount of extended memory.
- ▶▶ Total Memory             The total amount of memory installed on the system.

## 2-5 Advanced BIOS Features

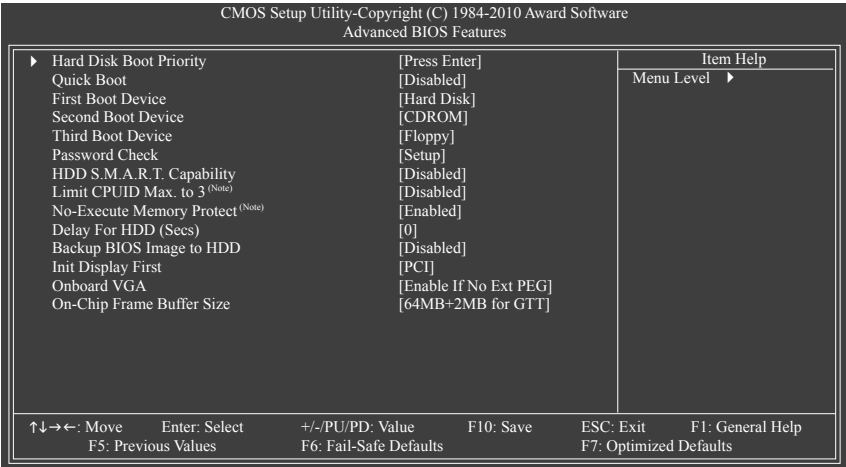

### ☞ Hard Disk Boot Priority

Specifies the sequence of loading the operating system from the installed hard drives. Use the up or down arrow key to select a hard drive, then press the plus key <+> (or <PageUp>) or the minus key <-> (or <PageDown>) to move it up or down on the list. Press <Esc> to exit this menu when finished.

### ☞ Quick Boot

Enables or disables the quick boot function to speed up the system boot-up process to shorten the waiting time for entering the operating system and to deliver greater efficiency for daily use. The settings here synchronize with the settings of the SMART QuickBoot of Smart 6™. (Default: Disabled)

### ☞ First/Second/Third Boot Device

Specifies the boot order from the available devices. Use the up or down arrow key to select a device and press <Enter> to accept. Options are: Floppy, LS120, Hard Disk, CDROM, ZIP, USB-FDD, USB-ZIP, USB-CDROM, USB-HDD, Legacy LAN, Disabled.

### ☞ Password Check

Specifies whether a password is required every time the system boots, or only when you enter BIOS Setup. After configuring this item, set the password(s) under the **Set Supervisor/User Password** item in the BIOS Main Menu.

- ▶▶ Setup            A password is only required for entering the BIOS Setup program. (Default)
- ▶▶ System            A password is required for booting the system and for entering the BIOS Setup program.

### ☞ HDD S.M.A.R.T. Capability

Enables or disables the S.M.A.R.T. (Self Monitoring and Reporting Technology) capability of your hard drive. This feature allows your system to report read/write errors of the hard drive and to issue warnings when a third party hardware monitor utility is installed. (Default: Disabled)

(Note) This item is present only if you install a CPU that supports this feature. For more information about Intel CPUs' unique features, please visit Intel's website.

☞ **Limit CPUID Max. to 3** <sup>(Note)</sup>

Allows you to determine whether to limit CPUID maximum value. Set this item to **Disabled** for Windows XP operating system; set this item to **Enabled** for legacy operating system such as Windows NT4.0. (Default: Disabled)

☞ **No-Execute Memory Protect** <sup>(Note)</sup>

Enables or disables Intel Execute Disable Bit function. This function may enhance protection for the computer, reducing exposure to viruses and malicious buffer overflow attacks when working with its supporting software and system. (Default: Enabled)

☞ **Delay For HDD (Secs)**

Allows you to set a delay time for the BIOS to initialize the hard drive as the system boots up. The adjustable range is from 0 to 15 seconds. (Default: 0)

☞ **Backup BIOS Image to HDD**

Allows the system to copy the BIOS image file to the hard drive. If the system BIOS is corrupted, it will be recovered from this image file. (Default: Disabled)

☞ **Init Display First**

Specifies the first initiation of the monitor display from the installed PCI graphics card, PCI Express graphics card or the onboard graphics.

- ▶▶ PCI                Sets the PCI graphics card as the first display. (Default)
- ▶▶ Onboard         Sets the onboard graphics as the first display.
- ▶▶ PEG                Sets the PCI Express graphics card on the PCIEX16 slot as the first display.
- ▶▶ PEG2              Sets the PCI Express graphics card on the PCIEX4 slot as the first display.

☞ **Onboard VGA**

Enables or disables the onboard graphics function.

- ▶▶ Enable If No Ext PEG

Activates the onboard graphics only if no PCI Express graphics card is installed. (Default)

- ▶▶ Always Enable

Always activates the onboard graphics, whether or not a PCI Express graphics card is installed. If you wish to set up a dual view configuration, set this item to Always Enable.

☞ **On-Chip Frame Buffer Size**

Frame buffer size is the total amount of system memory allocated solely for the onboard graphics controller. MS-DOS, for example, will use only this memory for display. Options are: 32MB+2MB for GTT, 64MB+2MB for GTT (default), 128MB+2MB for GTT.

(Note) This item is present only if you install a CPU that supports this feature. For more information about Intel CPUs' unique features, please visit Intel's website.

## 2-6 Integrated Peripherals

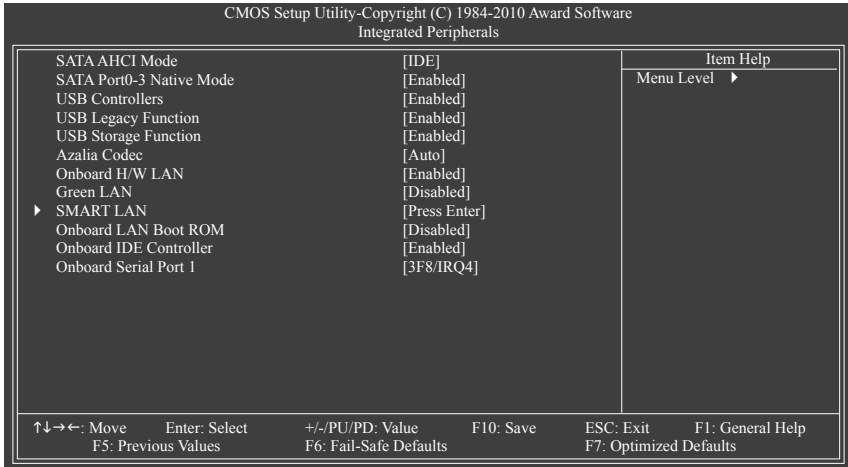

### ☞ SATA AHCI Mode (Intel H55 Chipset)

Allows you to decide whether to configure the SATA controllers integrated in the Intel H55 Chipset to AHCI mode.

- ▶▶ IDE                      Configures the SATA controllers to IDE mode. (Default)
- ▶▶ AHCI                     Configures the SATA controllers to AHCI mode. Advanced Host Controller Interface (AHCI) is an interface specification that allows the storage driver to enable advanced Serial ATA features such as Native Command Queuing and hot plug.

### ☞ SATA Port0-3 Native Mode (Intel H55 Chipset)

Specifies the operating mode of the integrated SATA controllers.

- ▶▶ Disabled                Allows the SATA controllers to operate in Legacy IDE mode. In Legacy mode the SATA controllers use dedicated IRQs that cannot be shared with other device. Set this option to **Disabled** if you wish to install operating systems that do not support Native mode.
- ▶▶ Enabled                 Allows the SATA controllers to operate in Native IDE mode. Enable Native IDE mode if you wish to install operating systems that support Native mode. (Default)

### ☞ USB Controllers

Enables or disables the integrated USB controllers. (Default: Enabled)

**Disabled** will turn off all of the USB functionalities below.

### ☞ USB Legacy Function

Allows USB keyboard to be used in MS-DOS. (Default: Enabled)

### ☞ USB Storage Function

Determines whether to detect USB storage devices, including USB flash drives and USB hard drives during the POST. (Default: Enabled)

### ☞ Azalia Codec

Enables or disables the onboard audio function. (Default: Auto)

If you wish to install a 3rd party add-in audio card instead of using the onboard audio, set this item to **Disabled**.

### ☞ Onboard H/W LAN

Enables or disables the onboard LAN function. (Default: Enabled)

If you wish to install a 3rd party add-in network card instead of using the onboard LAN, set this item to **Disabled**.

### ☞ Green LAN

When the onboard LAN function and **Green LAN** are enabled, the system will dynamically detect if a LAN cable is connected or not. If not, the corresponding LAN controller will be disabled automatically. (Default: Disabled)

### ☞ SMART LAN

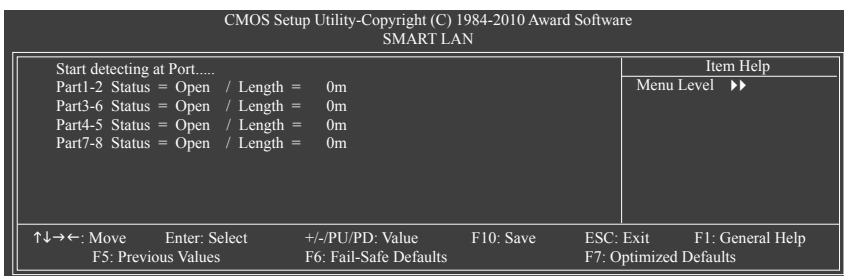

This motherboard incorporates cable diagnostic feature designed to detect the status of the attached LAN cable. This feature will detect cabling issue and report the approximate distance to the fault or short. Refer to the following information for diagnosing your LAN cable:

#### ☞ When No LAN Cable Is Attached...

If no LAN cable is attached to the motherboard, the **Status** fields of all four pairs of wires will show **Open** and the **Length** fields show **0m**, as shown in the figure above.

#### ☞ When LAN Cable Is Functioning Normally...

If no cable problem is detected on the LAN cable connected to a Gigabit hub or a 10/100 Mbps hub, the following message will appear:

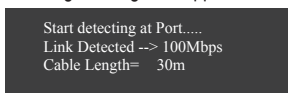

▶▶ Link Detected Displays transmission speed.

▶▶ Cable Length Displays the approximate length of the attached LAN cable.

Note: The Gigabit hub will only operate at a speed of 10/100 Mbps in MS-DOS mode; it will operate at a normal speed of 10/100/1000 Mbps in Windows mode or when the LAN Boot ROM is activated.

☞ **When a Cable Problem Occurs...**

If a cable problem occurs on a specified pair of wires, the **Status** field will show **Short** and then length shown will be the approximate distance to the fault or short.

Example: Part1-2 Status = Short / Length = 2m

Explanation: A fault or short might occur at about 2m on Part 1-2.

Note: Part 4-5 and Part 7-8 are not used in a 10/100 Mbps environment, so their **Status** fields will show **Open**, and the length shown is the approximate length of the attached LAN cable.

☞ **Onboard LAN Boot ROM**

Allows you to decide whether to activate the boot ROM integrated with the onboard LAN chip.  
(Default: Disabled)

☞ **Onboard IDE Controller (JMicron JMB368 Chip)**

Enables or disables the IDE controller integrated in the JMicron JMB368 chip. (Default: Enabled)

☞ **Onboard Serial Port 1**

Enables or disables the first serial port and specifies its base I/O address and corresponding interrupt.  
Options are: Auto, 3F8/IRQ4 (default), 2F8/IRQ3, 3E8/IRQ4, 2E8/IRQ3, Disabled.

## 2-7 Power Management Setup

CMOS Setup Utility-Copyright (C) 1984-2010 Award Software Power Management Setup		
ACPI Suspend Type	[S3(STR)]	Item Help
Soft-Off by PWR-BTTN	[Instant-Off]	Menu Level ▶
PME Event Wake Up	[Enabled]	
Power On by Ring	[Enabled]	
Resume by Alarm	[Disabled]	
x Date (of Month) Alarm	Everyday	
x Time (hh:mm:ss) Alarm	0 : 0 : 0	
HPET Support <sup>(Note)</sup>	[Enabled]	
HPET Mode <sup>(Note)</sup>	[32-bit mode]	
Power On By Mouse	[Disabled]	
Power On By Keyboard	[Disabled]	
x KB Power ON Password	Enter	
AC Back Function	[Soft-Off]	
ErP Support	[Disabled]	
↑↓←→: Move    Enter: Select    +/-/PU/PD: Value    F10: Save    ESC: Exit    F1: General Help F5: Previous Values    F6: Fail-Safe Defaults    F7: Optimized Defaults		

### ACPI Suspend Type

Specifies the ACPI sleep state when the system enters suspend.

- ▶▶ S1(POS)      Enables the system to enter the ACPI S1 (Power on Suspend) sleep state.  
In S1 sleep state, the system appears suspended and stays in a low power mode. The system can be resumed at any time.
- ▶▶ S3(STR)      Enables the system to enter the ACPI S3 (Suspend to RAM) sleep state (default).  
In S3 sleep state, the system appears to be off and consumes less power than in the S1 state. When signaled by a wake-up device or event, the system resumes to its working state exactly where it was left off.

### Soft-Off by PWR-BTTN

Configures the way to turn off the computer in MS-DOS mode using the power button.

- ▶▶ Instant-Off      Press the power button and then the system will be turned off instantly. (Default)
- ▶▶ Delay 4 Sec.      Press and hold the power button for 4 seconds to turn off the system. If the power button is pressed for less than 4 seconds, the system will enter suspend mode.

### PME Event Wake Up

Allows the system to be awakened from an ACPI sleep state by a wake-up signal from a PCI or PCIe device. Note: To use this function, you need an ATX power supply providing at least 1A on the +5VSB lead. (Default: Enabled)

### Power On by Ring

Allows the system to be awakened from an ACPI sleep state by a wake-up signal from a modem that supports wake-up function. (Default: Enabled)

### Resume by Alarm

Determines whether to power on the system at a desired time. (Default: Disabled)  
If enabled, set the date and time as following:

(Note) Supported on Windows 7/Vista operating system only.

▶▶ Date (of Month) Alarm: Turn on the system at a specific time on each day or on a specific day in a month.

▶▶ Time (hh: mm: ss) Alarm: Set the time at which the system will be powered on automatically.

Note: When using this function, avoid inadequate shutdown from the operating system or removal of the AC power, or the settings may not be effective.

#### ☞ **HPET Support** <sup>(Note)</sup>

Enables or disables High Precision Event Timer (HPET) for Windows 7/Vista operating system. (Default: Enabled)

#### ☞ **HPET Mode** <sup>(Note)</sup>

Allows you to select the HPET mode for your Windows 7/Vista operating system. Select **32-bit mode** when you install 32-bit Windows 7/Vista; select **64-bit mode** when you install 64-bit Windows 7/Vista. This item is configurable only if the **HPET Support** is set to **Enabled**. (Default: 32-bit mode)

#### ☞ **Power On By Mouse**

Allows the system to be turned on by a PS/2 mouse wake-up event.

Note: To use this function, you need an ATX power supply providing at least 1A on the +5VSB lead.

▶▶ Disabled Disables this function. (Default)

▶▶ Double Click Double click on left button on the PS/2 mouse to turn on the system.

#### ☞ **Power On By Keyboard**

Allows the system to be turned on by a PS/2 keyboard wake-up event.

Note: you need an ATX power supply providing at least 1A on the +5VSB lead.

▶▶ Disabled Disables this function. (Default)

▶▶ Password Set a password with 1~5 characters to turn on the system.

▶▶ Keyboard 98 Press POWER button on the Windows 98 keyboard to turn on the system.

#### ☞ **KB Power ON Password**

Set the password when **Power On by Keyboard** is set to **Password**. Press <Enter> on this item and set a password with up to 5 characters and then press <Enter> to accept. To turn on the system, enter the password and press <Enter>.

Note: To cancel the password, press <Enter> on this item. When prompted for the password, press <Enter> again without entering the password to clear the password settings.

#### ☞ **AC Back Function**

Determines the state of the system after the return of power from an AC power loss.

▶▶ Soft-Off The system stays off upon the return of the AC power. (Default)

▶▶ Full-On The system is turned on upon the return of the AC power.

▶▶ Memory The system returns to its last known awake state upon the return of the AC power.

#### ☞ **ErP Support**

Determines whether to let the system consume less than 1W power in S5 (shutdown) state. (Default: Disabled)

Note: When this item is set to Enabled, the following four functions will become unavailable:

PME event wake up, power on by mouse, power on by keyboard, and wake on LAN.

(Note) Supported on Windows 7/Vista operating system only.

## 2-8 PC Health Status

CMOS Setup Utility-Copyright (C) 1984-2010 Award Software		
PC Health Status		
		Item Help
Reset Case Open Status	[Disabled]	Menu Level ▶
Case Opened	No	
Vcore	1.172V	
DDR15V	1.584V	
+5V	5.026V	
+12V	12.112V	
Current System Temperature	30°C	
Current CPU Temperature	47°C	
Current CPU FAN Speed	3375 RPM	
Current SYSTEM FAN Speed	0 RPM	
CPU Warning Temperature	[Disabled]	
CPU FAN Fail Warning	[Disabled]	
SYSTEM FAN Fail Warning	[Disabled]	
CPU Smart FAN Control	[Enabled]	
CPU Smart FAN Mode	[Auto]	

↑↓→←: Move	Enter: Select	+/-/PU/PD: Value	F10: Save	ESC: Exit	F1: General Help
F5: Previous Values		F6: Fail-Safe Defaults		F7: Optimized Defaults	

### Reset Case Open Status

Keeps or clears the record of previous chassis intrusion status. **Enabled** clears the record of previous chassis intrusion status and the **Case Opened** field will show "No" at next boot. (Default: Disabled)

### Case Opened

Displays the detection status of the chassis intrusion detection device attached to the motherboard CI header. If the system chassis cover is removed, this field will show "Yes", otherwise it will show "No". To clear the chassis intrusion status record, set **Reset Case Open Status** to **Enabled**, save the settings to the CMOS, and then restart your system.

### Current Voltage(V) Vcore/DDR15V/+5V/+12V

Displays the current system voltages.

### Current System/CPU Temperature

Displays current system/CPU temperature.

### Current CPU/SYSTEM FAN Speed (RPM)

Displays current CPU/system fan speed.

### CPU Warning Temperature

Sets the warning threshold for CPU temperature. When CPU temperature exceeds the threshold, BIOS will emit warning sound. Options are: Disabled (default), 60°C/140°F, 70°C/158°F, 80°C/176°F, 90°C/194°F.

### CPU/SYSTEM FAN Fail Warning

Allows the system to emit warning sound if the CPU/system fan is not connected or fails. Check the fan condition or fan connection when this occurs. (Default: Disabled)

### CPU Smart FAN Control

Enables or disables the CPU fan speed control function. **Enabled** allows the CPU fan to run at different speed according to the CPU temperature. You can adjust the fan speed with EasyTune based on system requirements. If disabled, the CPU fan runs at full speed. (Default: Enabled)

## ☞ CPU Smart FAN Mode

Specifies how to control CPU fan speed. This item is configurable only if **CPU Smart FAN Control** is set to **Enabled**.

- ▶▶ Auto Lets the BIOS automatically detect the type of CPU fan installed and sets the optimal CPU fan control mode. (Default)
- ▶▶ Voltage Sets Voltage mode for a 3-pin CPU fan.
- ▶▶ PWM Sets PWM mode for a 4-pin CPU fan.

Note: The **Voltage** mode can be set for a 3-pin CPU fan or a 4-pin CPU fan. However, for a 4-pin CPU fan that is not designed following Intel PWM fan specifications, selecting **PWM** mode may not effectively reduce the fan speed.

## 2-9 Load Fail-Safe Defaults

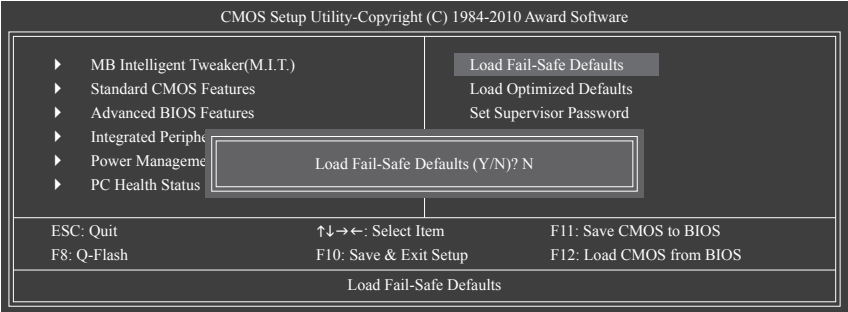

Press <Enter> on this item and then press the <Y> key to load the safest BIOS default settings. In case system instability occurs, you may try to load Fail-Safe defaults, which are the safest and most stable BIOS settings for the motherboard.

## 2-10 Load Optimized Defaults

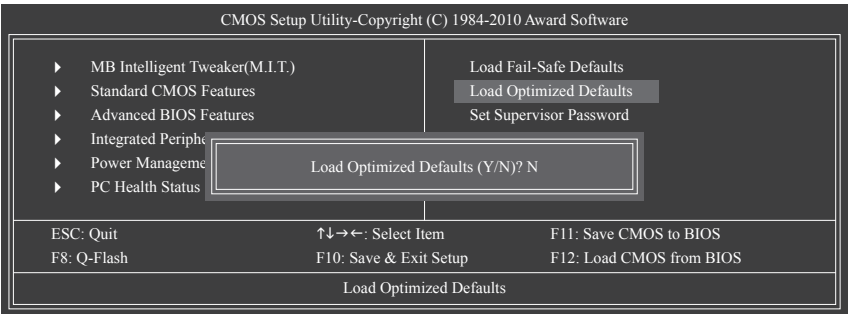

Press <Enter> on this item and then press the <Y> key to load the optimal BIOS default settings. The BIOS defaults settings help the system to operate in optimum state. Always load the Optimized defaults after updating the BIOS or after clearing the CMOS values.



## 2-12 Save & Exit Setup

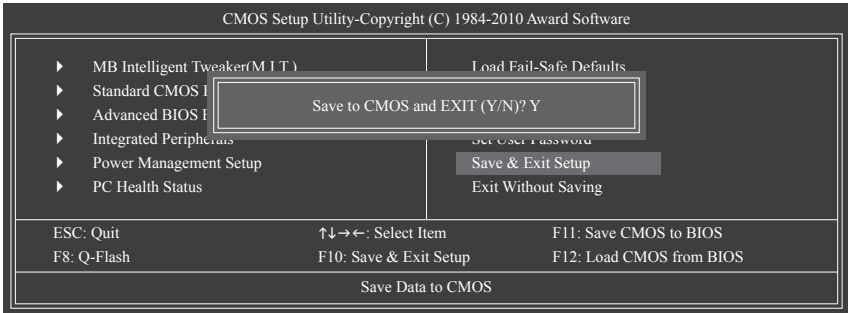

Press <Enter> on this item and press the <Y> key. This saves the changes to the CMOS and exits the BIOS Setup program. Press <N> or <Esc> to return to the BIOS Setup Main Menu.

## 2-13 Exit Without Saving

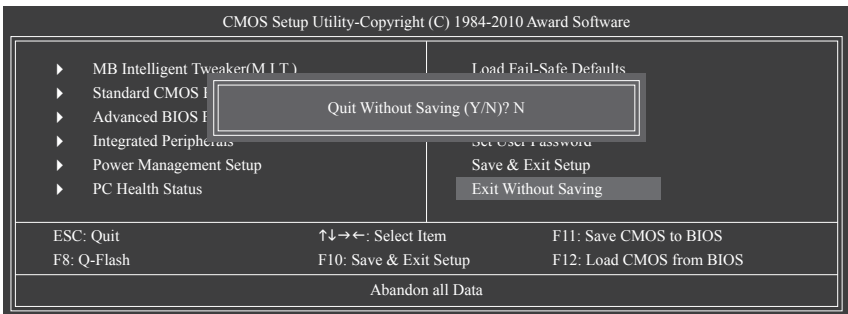

Press <Enter> on this item and press the <Y> key. This exits the BIOS Setup without saving the changes made in BIOS Setup to the CMOS. Press <N> or <Esc> to return to the BIOS Setup Main Menu.

## Chapter 3 Drivers Installation



- Before installing the drivers, first install the operating system.
- After installing the operating system, insert the motherboard driver disk into your optical drive. The driver Autorun screen is automatically displayed which looks like that shown in the screen shot below. (If the driver Autorun screen does not appear automatically, go to My Computer, double-click the optical drive and execute the **Run.exe** program.)

### 3-1 Installing Chipset Drivers



Now Loading Please wait...

After inserting the driver disk, "Xpress Install" will automatically scan your system and then list all the drivers that are recommended to install. You can click the **Install All** button and "Xpress Install" will install all the recommended drivers. Or click **Install Single Items** to manually select the drivers you wish to install.

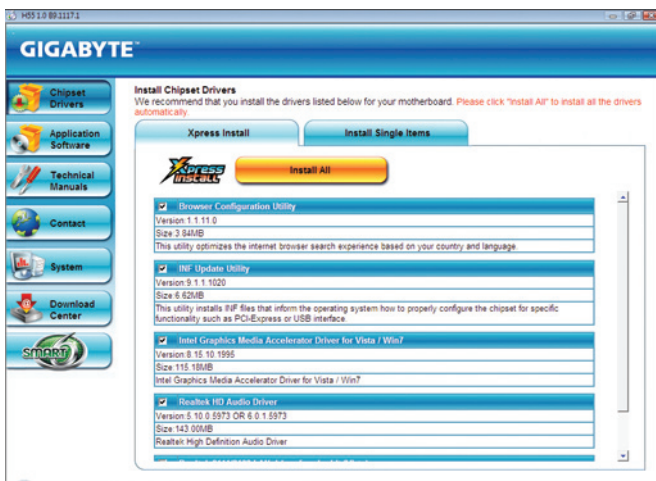

- Please ignore the popup dialog box(es) (e.g. the **Found New Hardware Wizard**) displayed when "Xpress Install" is installing the drivers. Failure to do so may affect the driver installation.
- Some device drivers will restart your system automatically during the driver installation. After the system restart, "Xpress Install" will continue to install other drivers.
- After "Xpress Install" installs all of the drivers, a dialog box will appear asking whether to install new GIGABYTE utilities. Click **Yes** to automatically install the utilities. Or click **No** if you want to manually select the utilities to install on the **Application Software** page later.
- For USB 2.0 driver support under the Windows XP operating system, please install the Windows XP Service Pack 1 or later. After installing the SP1 (or later), if a question mark still exists in **Universal Serial Bus Controller** in **Device Manager**, please remove the question mark (by right-clicking your mouse and select **Uninstall**) and restart the system. (The system will then autodetect and install the USB 2.0 driver.)

### 3-2 Application Software

This page displays all the utilities and applications that GIGABYTE develops and some free software. You can click the **Install** button on the right of an item to install it.

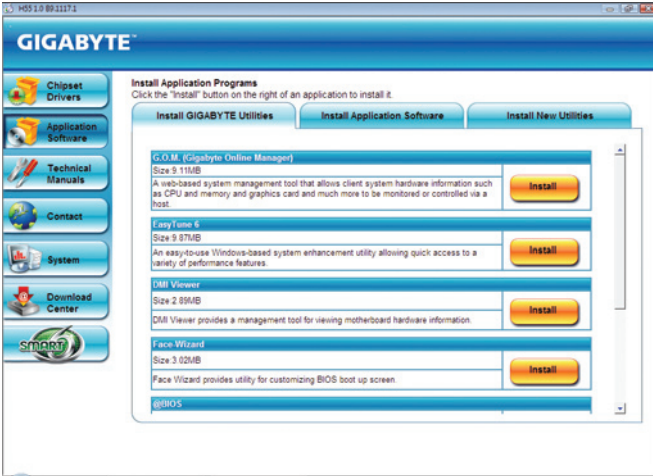

### 3-3 Technical Manuals

This page provides GIGABYTE's application guides, content descriptions for this driver disk, and the motherboard manuals.

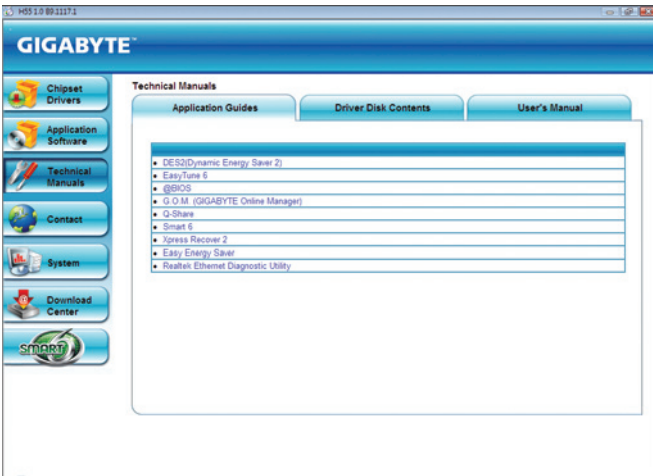

### 3-4 Contact

For the detailed contact information of the GIGABYTE Taiwan headquarter or worldwide branch offices, click the URL on this page to link to the GIGABYTE website.



### 3-5 System

This page provides the basic system information.

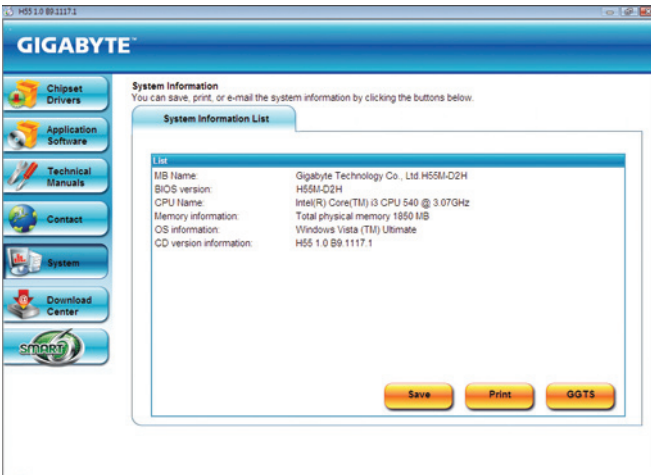

### 3-6 Download Center

To update the BIOS, drivers, or applications, click the **Download Center** button to link to the GIGABYTE website. The latest version of the BIOS, drivers, or applications will be displayed.

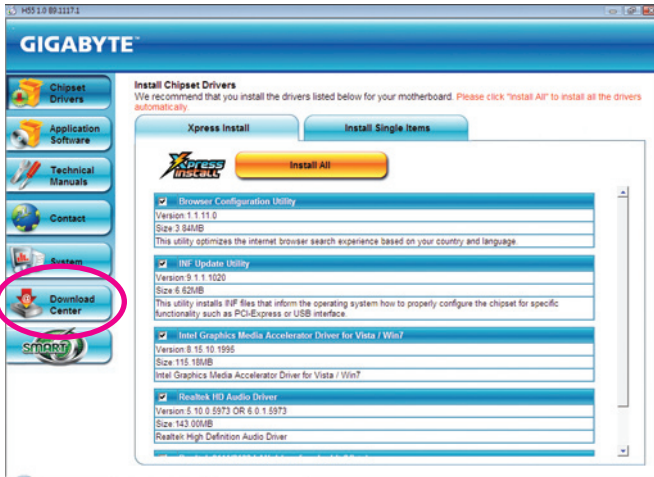

### 3-7 New Utilities

This page provides a quick link to GIGABYTE's lately developed utilities for users to install. You can click the **Install** button on the right of an item to install it.

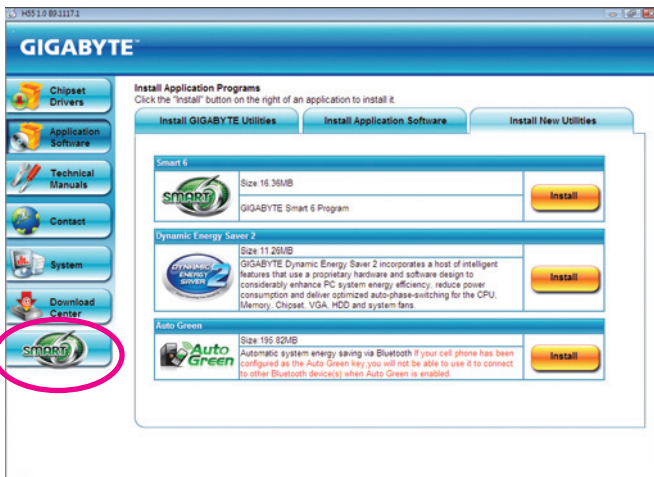

# Chapter 4 Unique Features

## 4-1 Xpress Recovery2



Xpress Recovery2 is a utility that allows you to quickly compress and back up your system data and perform restoration of it. Supporting NTFS, FAT32, and FAT16 file systems, Xpress Recovery2 can back up data on PATA and SATA hard drives and restore it.

### Before You Begin:

- Xpress Recovery2 will check the first physical hard drive<sup>(Note)</sup> for the operating system. Xpress Recovery2 can only back up/restore the first physical hard drive that has the operating system installed.
- As Xpress Recovery2 will save the backup file at the end of the hard drive, make sure to leave enough un-allocated space in advanced (10 GB or more is recommended; actual size requirements vary, depending on the amount of data).
- It is recommended to back up your system soon after the operating system and drivers are installed.
- The amount of data and hard drive access speed may affect the speed at which the data is backed up/ restored.
- It takes longer to back up a hard drive than to restore it.

### System Requirements:

- At least 512 MB of system memory
- VESA compatible graphics card
- Windows XP with SP1 or later, Windows Vista



- Xpress Recovery and Xpress Recovery2 are different utilities. For example, a backup file created with Xpress Recovery cannot be restored using Xpress Recovery2.
- USB hard drives are not supported.
- Hard drives in RAID/AHCI mode are not supported.

### Installation and Configuration:

Turn on your system to boot from the Windows Vista setup disk.

#### A. Installing Windows Vista and Partitioning the Hard Drive

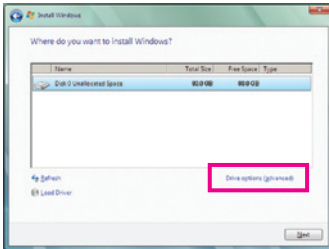

Step 1:

Click **Drive options**.

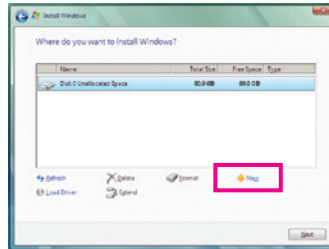

Step 2:

Click **New**.

(Note) Xpress Recovery2 checks the first physical hard drive in the following sequence: The first PATA IDE connector, the second PATA IDE connector, the first SATA connector, the second SATA connector and so forth. For example, when hard drives are attached to the first IDE and the first SATA connectors, the hard drive on the first IDE connector is the first physical drive. When hard drives are attached to the first and second SATA connectors, the hard drive on the first SATA connector is the first physical drive.

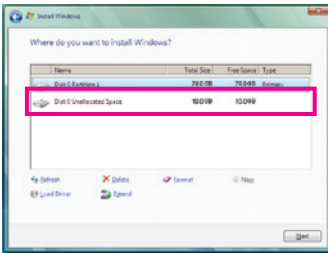

**Step 3:**

When partitioning your hard drive, make sure to leave unallocated space (10 GB or more is recommended; actual size requirements vary, depending on the amount of data) and begin the installation of the operating system.

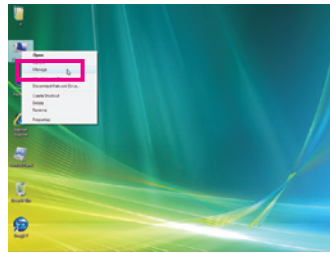

**Step 4:**

After the operating system is installed, right-click the **Computer** icon on your desktop and select the **Manage**. Go to **Disk Management** to check disk allocation.

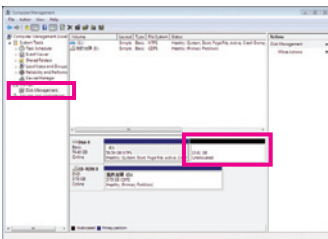

**Step 5:**

Xpress Recovery2 will save the backup file to the unallocated space (black stripe along the top). Please note that if there is not enough unallocated space, Xpress Recovery2 cannot save the backup file.

**B. Accessing Xpress Recovery2**

1. Boot from the motherboard driver disk to access Xpress Recovery2 for the first time. When you see the following message: *Press any key to startup Xpress Recovery2*, press any key to enter Xpress Recovery2.
2. After you use the backup function in Xpress Recovery2 for the first time, Xpress Recovery2 will set permanent in your hard drive. If you wish to enter Xpress Recovery2 later, simply press <F9> during the POST.

**C. Using the Backup Function in Xpress Recovery2**



**Step 1:**

Select **BACKUP** to start backing up your hard drive data.

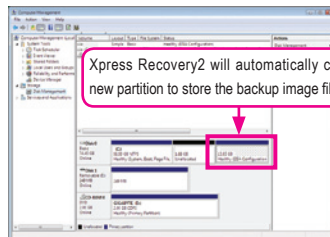

**Step 2:**

When finished, go to **Disk Management** to check disk allocation.

#### D. Using the Restore Function in Xpress Recovery2



Select **RESTORE** to restore the backup to your hard drive in case the system breaks down. The **RESTORE** option will not be present if no backup is created before.

#### E. Removing the Backup



Step 1:

If you wish to remove the backup file, select **REMOVE**.

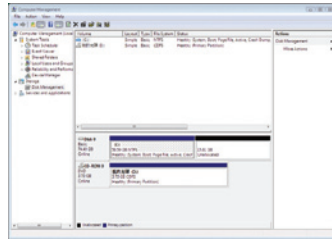

Step 2:

After the backup file is removed, no backup image file will be present in **Disk Management** and hard drive space will be freed up.

#### F. Exiting Xpress Recovery2



Select **REBOOT** to exit Xpress Recovery2.

## 4-2 BIOS Update Utilities

GIGABYTE motherboards provide two unique BIOS update tools, Q-Flash™ and @BIOS™. GIGABYTE Q-Flash and @BIOS are easy-to-use and allow you to update the BIOS without the need to enter MS-DOS mode. Additionally, this motherboard features the DualBIOS™ design, which enhances protection for the safety and stability of your computer by adding one more physical BIOS chip.



### What is DualBIOS™?

Motherboards that support DualBIOS have two BIOS onboard, a main BIOS and a backup BIOS. Normally, the system works on the main BIOS. However, if the main BIOS is corrupted or damaged, the backup BIOS will take over on the next system boot and copy the BIOS file to the main BIOS to ensure normal system operation. For the sake of system safety, users cannot update the backup BIOS manually.



### What is Q-Flash™?

With Q-Flash you can update the system BIOS without having to enter operating systems like MS-DOS or Window first. Embedded in the BIOS, the Q-Flash tool frees you from the hassles of going through complicated BIOS flashing process.



### What is @BIOS™?

@BIOS allows you to update the system BIOS while in the Windows environment. @BIOS will download the latest BIOS file from the nearest @BIOS server site and update the BIOS.

### 4-2-1 Updating the BIOS with the Q-Flash Utility

#### A. Before You Begin

1. From GIGABYTE's website, download the latest compressed BIOS update file that matches your motherboard model.
2. Extract the file and save the new BIOS file (e.g. h55ms2h.f1) to your USB flash drive or USB hard drive. Note: The USB flash drive or hard drive must use FAT32/16/12 file system.
3. Restart the system. During the POST, press the <End> key to enter Q-Flash. Note: You can access Q-Flash by either pressing the <End> key during the POST or pressing the <F8> key in BIOS Setup. However, if the BIOS update file is saved to a hard drive in RAID/AHCI mode or a hard drive attached to an independent IDE/SATA controller, use the <End> key during the POST to access Q-Flash.

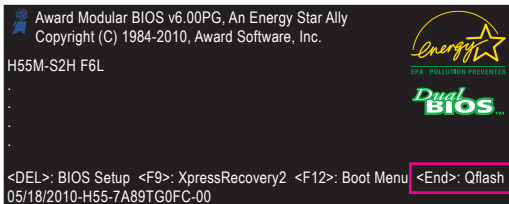

Because BIOS flashing is potentially risky, please do it with caution. Inadequate BIOS flashing may result in system malfunction.

## B. Updating the BIOS

When updating the BIOS, choose the location where the BIOS file is saved. The following procedure assumes that you save the BIOS file to a USB flash drive.

### Step 1:

1. Insert the USB flash drive containing the BIOS file into the computer. In the main menu of Q-Flash, use the up or down arrow key to select **Update BIOS from Drive** and press <Enter>.



- The **Save Main BIOS to Drive** option allows you to save the current BIOS file.
- Q-Flash only supports USB flash drive or hard drives using FAT32/16/12 file system.
- If the BIOS update file is saved to a hard drive in RAID/AHCI mode or a hard drive attached to an independent IDE/SATA controller, use the <End> key during the POST to access Q-Flash.

2. Select **HDD 0-0** and press <Enter>.

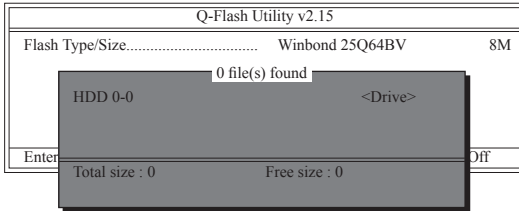

3. Select the BIOS update file and press <Enter>.



**Make sure the BIOS update file matches your motherboard model.**

### Step 2:

The process of the system reading the BIOS file from the USB flash drive is displayed on the screen. When the message "Are you sure to update BIOS?" appears, press <Enter> to begin the BIOS update. The monitor will display the update process.



- **Do not turn off or restart the system when the system is reading/updating the BIOS.**
- **Do not remove the USB flash drive or hard drive when the system is updating the BIOS.**

### Step 3:

When the update process is complete, press any key to return to the main menu.

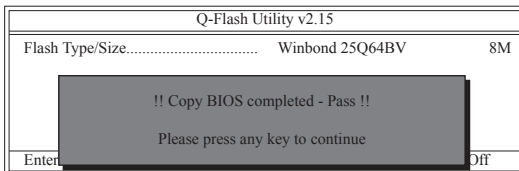

**Step 4:**

Press <Esc> and then <Enter> to exit Q-Flash and reboot the system. As the system boots, you should see the new BIOS version is present on the POST screen.

**Step 5:**

During the POST, press <Delete> to enter BIOS Setup. Select **Load Optimized Defaults** and press <Enter> to load BIOS defaults. System will re-detect all peripheral devices after a BIOS update, so we recommend that you reload BIOS defaults.

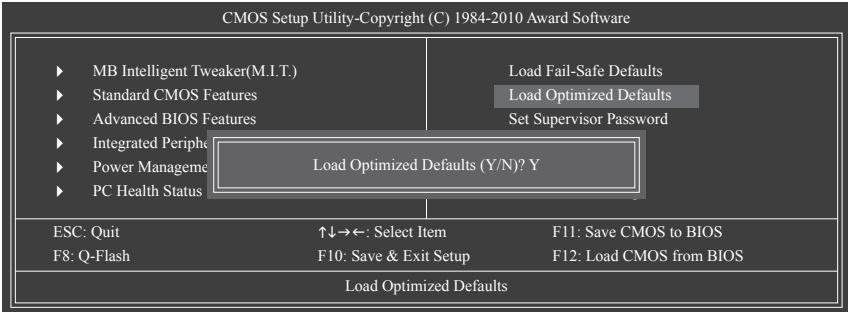

Press <Y> to load BIOS defaults

**Step 6:**

Select **Save & Exit Setup** and then press <Y> to save settings to CMOS and exit BIOS Setup. The procedure is complete after the system restarts.

## 4-2-2 Updating the BIOS with the @BIOS Utility

### A. Before You Begin

1. In Windows, close all applications and TSR (Terminate and Stay Resident) programs. This helps prevent unexpected failures when performing a BIOS update.
2. During the BIOS update process, ensure the Internet connection is stable and do NOT interrupt the Internet connection (for example, avoid a power loss or switching off the Internet). Failure to do so may result in a corrupted BIOS or a system that is unable to start.
3. Do not use the G.O.M. (GIGABYTE Online Management) function when using @BIOS.
4. GIGABYTE product warranty does not cover any BIOS damage or system failure resulting from an inadequate BIOS flashing.

### B. Using @BIOS

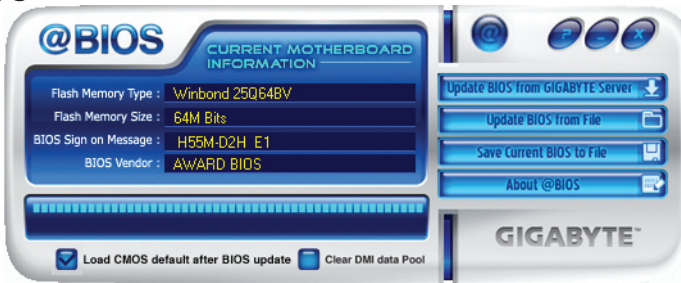

#### 1. Update the BIOS Using the Internet Update Function:

Click **Update BIOS from GIGABYTE Server**, select the @BIOS server site closest to your location and then download the BIOS file that matches your motherboard model. Follow the on-screen instructions to complete.



If the BIOS update file for your motherboard is not present on the @BIOS server site, please manually download the BIOS update file from GIGABYTE's website and follow the instructions in "Update the BIOS without Using the Internet Update Function" below.

#### 2. Update the BIOS without Using the Internet Update Function:

Click **Update BIOS from File**, then select the location where you save the BIOS update file obtained from the Internet or through other source. Follow the on-screen instructions to complete.

#### 3. Save the Current BIOS File:

Click **Save Current BIOS to File** to save the current BIOS file.

#### 4. Load BIOS Defaults after BIOS Update:

Select the **Load CMOS default after BIOS update** check box and then the system will automatically load BIOS defaults after BIOS update and after the system restarts.

### C. After Updating the BIOS

Restart your system after updating the BIOS.



**Make sure that the BIOS file to be flashed matches your motherboard model. Updating the BIOS with an incorrect BIOS file could cause your system not to boot.**

## 4-3 EasyTune 6

GIGABYTE's EasyTune 6 is a simple and easy-to-use interface that allows users to fine-tune their system settings or do overclock/overvoltage in Windows environment. The user-friendly EasyTune 6 interface also includes tabbed pages for CPU and memory information, letting users read their system-related information without the need to install additional software.

### The EasyTune 6 Interface



### Tabs Information

Tab	Function
CPU	The <b>CPU</b> tab provides information on the installed CPU and motherboard.
Memory	The <b>Memory</b> tab provides information on the installed memory module(s). You can select memory module on a specific slot to see its information.
Tuner	<p>The <b>Tuner</b> tab allows you to change system clock settings and voltages.</p> <ul style="list-style-type: none"> <li>• <b>Quick Boost mode</b> provides you with 3 levels of CPU frequency/base clock to choose to achieve desired system performance. <sup>(Note)</sup> After making changes in <b>Quick Boost mode</b> or clicking <b>Default</b> to restore to default values, be sure to restart your system for these changes to take effect.</li> <li>• <b>Easy mode</b> allows you to adjust the CPU base clock only.</li> <li>• <b>Advanced mode</b> allows you to individually change system clock settings and voltages settings using the sliders.</li> <li>• <b>Save</b> allows you to save the current settings to a new profile (.txt file).</li> <li>• <b>Load</b> allows you to load previous settings from a profile.</li> </ul> <p>After making changes in <b>Easy mode/Advanced mode</b>, be sure to click <b>Set</b> for these changes to take effect or click <b>Default</b> to restore to default values.</p>
Graphics	The <b>Graphics</b> tab allows you to change the core clock and memory clock for your ATI or NVIDIA graphics card.
Smart	The <b>Smart</b> tab allows you to specify a Smart Fan mode. <b>Smart Fan Advance Mode</b> allows the CPU fan speed to be changed linearly based on the CPU temperature thresholds you set.
HW Monitor	The <b>HW Monitor</b> tab allows you to monitor hardware temperature, voltage and fan speed and set temperature/fan speed alarm. You can choose the alert sound from the buzzer or use your own sound file (.wav file).

(Note) Due to the hardware limitation, you must install a DDR3 1066 MHz memory module(s) (or above) to enable support for Quick Boost.



Available functions in EasyTune 6 may differ by motherboard model. Grayed-out area(s) indicates that the item is not configurable or the function is not supported.



Incorrectly doing overclock/overvoltage may result in damage to the hardware components such as CPU, chipset, and memory and reduce the useful life of these components. Before you do the overclock/overvoltage, make sure that you fully know each function of EasyTune 6, or system instability or other unexpected results may occur.

## 4-4 Dynamic Energy Saver™ 2

GIGABYTE Dynamic Energy Saver™ 2 (Note 1) is a revolutionary technology that delivers unparalleled power savings with a click of the button. Featuring an advanced proprietary hardware and software design, GIGABYTE Dynamic Energy Saver™ 2 is able to provide exceptional power savings and enhanced power efficiency without sacrificing computing performance.

### The Dynamic Energy Saver™ 2 Interface

#### A. Meter Mode

In Meter Mode, GIGABYTE Dynamic Energy Saver™ 2 shows how much power they have saved in a set period of time.



#### Meter Mode - Button Information Table

	Button Description
1	Dynamic Energy Saver On/Off Switch (Default: Off)
2	Current CPU Power Consumption
3	Power Saving (Calculate power savings based on time)
4	Meter Time
5	Meter/Timer Reset Switch
6	Total Mode Switch
7	Meter Mode Switch
8	Dynamic Power Phase Status
9	Power Saving Status (Icons of the devices currently in power-saving mode will light on)
10	3-Level Power Saving Switch (Default:1) (Note 2)
11	Advanced Settings
12	Close (Application will enter Stealth Mode)
13	Minimize (Application will continue to run in taskbar)
14	INFO/Help
15	Motherboard Phase LED On/Off Switch (Default: On)
16	Live Utility Update (Check for the latest utility version)

- The above data is for reference only. Actual performance may vary depending on motherboard model.
- CPU Power and Power Scores are for reference only. Actual results may vary based on testing method.

## B. Total Mode

In Total Mode, users are able to see how much total power savings they have accumulated in a set period of time since activating Dynamic Energy Saver™ 2 for the first time <sup>(Note 3)</sup>.



### Total Mode - Button Information Table

	Button Description
1	Dynamic Energy Saver On/Off Switch (Default: Off)
2	Current CPU Power Consumption
3	Total Power Savings (Total power saving with Dynamic Energy Saver enabled) <sup>(Note 4)</sup>
4	Time/Date Dynamic Energy Saver Enabled
5	Total Mode Switch
6	Meter Mode Switch
7	Dynamic Power Phase Status
8	Power Saving Status (Icons of the devices currently in power-saving mode will light on)
9	3-Level Power Saving Switch (Default: 1) <sup>(Note 2)</sup>
10	Advanced Settings
11	Close (Application will enter Stealth Mode)
12	Minimize (Application will continue to run in taskbar)
13	INFO/Help
14	Motherboard Phase LED On/Off Switch (Default: On)
15	Live Utility Update (Check for the latest utility version)

## C. Stealth Mode

In Stealth Mode, the system continues to work with the user-defined power saving settings, even after the system is restarted. Re-enter the application only if you want to make any changes or completely close the application.

(Note 1) Before using the Dynamic Energy Saver™ 2 function, make sure the **CPU Enhanced Halt (C1E)** and **CPU EIST Function** items in the BIOS Setup program are set to **Enabled**.

(Note 2) 1: Smart FAN/CPU (default); 2: Smart FAN/CPU/VGA/HDD; 3: Smart FAN/CPU/VGA/HDD/Chipset/Memory.

(Note 3) The total amount of power saved will be recorded until re-activated when only the Dynamic Power Saver is under the enable status, and power savings meter is unable to reset to zero.

(Note 4) Dynamic Energy Saver Meter will automatically reset when the total power saving reaches 99999999 Watts.

## 4-5 Q-Share

Q-Share is an easy and convenient data sharing tool. After configuring your LAN connection settings and Q-Share, you are able to share your data with computers on the same network, making full use of Internet resources.



### Directions for using Q-Share

After installing Q-Share from the motherboard driver disk, go to Start>All Programs>GIGABYTE>Q-Share.exe to launch the Q-Share tool. Find the **Q-Share** icon  in the notification area and right-click on this icon to configure the data sharing settings.



Figure 1. Data Sharing Disabled



Figure 2. Data Sharing Enabled

### Options Descriptions

Option	Description
Connect ...	Displays the computers with data sharing enabled
Enable Incoming Folder ...	Enables data sharing
Disable Incoming Folder ...	Disables data sharing
Open Incoming Folder : C:\Q-ShareFolder	Accesses the shared data folder
Change Incoming Folder : C:\Q-ShareFolder	Changes the data folder to be shared <sup>(Note)</sup>
Update Q-Share ...	Updates Q-Share online
About Q-Share ...	Displays the current Q-Share version
Exit...	Exits Q-Share

(Note) This option is available only when data sharing is NOT enabled.

## 4-6 Smart 6™

GIGABYTE Smart 6™ (Note 1) is designed with user-friendliness in mind, and offers a combination of 6 innovative software utilities that provide easier and smarter PC system management. Smart 6™ allows you to speed up system performance, reduce boot-up time, manage a secure platform and recover specified files easily with a click of the mouse button.



### SMART QuickBoot

SMART QuickBoot speeds up the system boot-up process and shortens the waiting time for entering the operating system, delivering greater efficiency for daily use.



#### Instructions:

Select the **Enable** check box below the **BIOS QuickBoot** or **OS QuickBoot** item and then click **Save** to save the settings.



### SMART QuickBoost

SMART QuickBoost features quick and effortless CPU overclocking for novice and experienced users alike; users simply click on one of the three levels of CPU performance enhancement, and SMART QuickBoost automatically adjusts CPU performance.



#### Instructions:

Select a CPU performance boost level and restart your computer for the changes to take effect.



## SMART Recovery

With SMART Recovery, users can quickly create backups of changed data files <sup>(Note 2)</sup> or copy files from a specific backup on PATA and SATA hard drives (partitioned on NTFS file system) in Windows Vista.

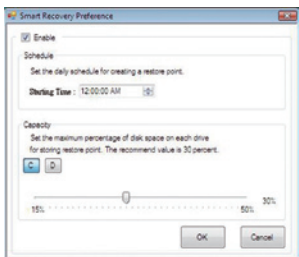

### Instructions:

In the main menu, click the **Config** button to open the **Smart Recovery Preference** dialog box.

The **Smart Recovery Preference** dialog box:

Button	Function
Enable	Enables automatic daily backup <sup>(Note 3)</sup>
Schedule	Sets a daily backup schedule
Capacity	Sets the percentage of hard drive space used for saving backups <sup>(Note 4)</sup>



- The hard drive must have more than 1 GB of capacity.
- Each partition can accommodate up to 64 backups (the actual limit depends on the size of each partition). When this limit is reached, the oldest backup will be overwritten.

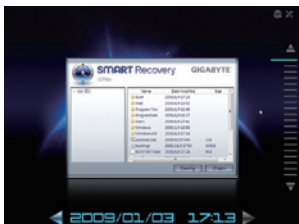

### Instructions for copying files/folders from a backup:

To browse through your backups made at different time, select a backup time using the time scroll bar on the right or at the bottom of the screen. If you want to copy back a file/folder, select the file/folder you wish to copy and click the **Copy** button.



The files/folders listed on the screen are read-only so you cannot edit their contents.



## SMART DualBIOS

SMART DualBIOS is a new feature that can record personal passwords and important dates, and remind users of the dates. It also stores the recorded data in the main and backup BIOS simultaneously, which can prevent loss of the data in case the system/hard drive fails.



### Instructions:

Enter the Smart 6™ password to launch the SMART DualBIOS utility. You can record personal passwords and important dates and set reminders of these dates. Click **Save** to save the settings and click **Exit** to exit.



## SMART Recorder

SMART Recorder monitors and records the activities in a system such as the time when the computer was turned on/off or even when large data files were moved within the hard drive or copied to an external storage device (Note 5).



### Instructions:

Select the **Enable** check box at the bottom of the **ON/OFF Recorder** or **File Monitor** tab to enable the recording of system on/off time or files copying. Entering the Smart 6™ password is required before you make any changes to the previous settings.



## SMART TimeLock

SMART TimeLock allows users to effectively manage computer usage time with simple rules and options.

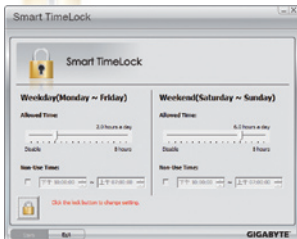

### Instructions (Note 6):

Click the lock icon  on the bottom left corner and enter the Smart 6™ password. Set the time when a user can or cannot use your computer for weekdays and weekends. Click **Save** to save the settings and click **Exit** to exit.



### The Smart TimeLock Alert:

An alert will appear 15 minutes and 1 minute prior to the default shutdown time. When the alert appears, you can enter the Smart 6™ password to extend the usage time or click **Cancel** to close the alert. If you respond **Cancel**, you will be requested to enter the password to extend the usage time again when the default shutdown time arrives, or the computer will shutdown right away.

- (Note 1) When launching Smart 6™ for the first time, the system will request you to set up a password. This password is required when you activate SMART DualBIOS or when you want to make changes to the SMART Recorder or SMART TimeLock settings.
- (Note 2) The changed data refers to the data that has been modified, deleted, or newly added since the last backup.
- (Note 3) The system will make an automatic backup on changed data only once everyday. If the computer is turned on for a long time, the backup will be performed at the scheduled backup time. If the computer is turned off before the scheduled backup time, the backup will be performed on the next boot.
- (Note 4) We recommend that you preserve at least 25 percent of the hard drive space to optimize the storage space for the backups. The backups of the changed data will be stored in the original partition of the data.
- (Note 5) You will not be able to use the "Safely Remove Hardware" feature in the operating system with SMART Recorder enabled. To remove an external storage device, unplug it directly from your computer (please note that doing so may result in damage to the hardware device or loss of data).
- (Note 6) You can set the User Password in the system BIOS Setup program to prevent the system time being changed by other users.

## 4-7 Auto Green

Auto Green is an easy-to-use tool that provides users with simple options to enable system power savings via a Bluetooth cell phone. When the phone is out of the range of the computer's Bluetooth receiver, the system will enter the specified power saving mode.

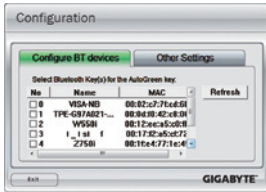

### The Configuration dialog box:

First, you have to set your Bluetooth cell phone as a portable key. On the Auto Green main menu, click **Configure** and then click **Configure BT devices**. Select the Bluetooth cell phone that you want to use as the portable key <sup>(Note 1)</sup>. (If the screen doesn't display your Bluetooth cell phone, click **Refresh** to let Auto Green re-detect the device.)



Before creating a Bluetooth cell phone key, make sure your motherboard has a Bluetooth receiver and you have turned on the search and Bluetooth functions on your phone.

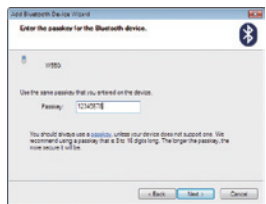

### Configuring the Bluetooth cell phone key:

After you select a cell phone, the **Add Bluetooth Device Wizard** as shown on the left will appear. Enter a passkey (8~16 digits recommended) which will be used for pairing with the cell phone. Then enter the same passkey on your cell phone.

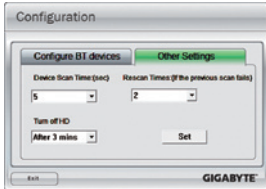

### Configuring other Bluetooth settings:

On the **Other Settings** tab, you can set how much time it takes to scan your Bluetooth cell phone key, how many times to rescan the key to make sure it is in range of your computer, and when to turn off the hard drive if the system energy saving state lasts over the predetermined period of time. After completing the settings, click **Set** for the settings to take effect and then click **Exit** to quit.

- **Device Scan Time (sec.):**  
Set the length of time Auto Green scans your Bluetooth cell phone key, ranging from 5 to 30 seconds in 5-second increment. Auto Green searches for the key based on the length of time you set.
- **Rescan Times:**  
Set how many times Auto Green will rescan your Bluetooth cell phone key if it does not detect it, ranging from 2 to 5 times. Auto Green will keep rescanning according to the times you set. When the times limit is reached and your Bluetooth cell phone key is still not detected, the system will enter the selected energy saving mode.
- **Turn off HD:**  
Set when to turn off the hard drive. If the system inactivity time exceeds the specified time limit, the hard drive will be turned off.



### Selecting a system energy saving mode:

Depending on your needs, select a system power saving mode on the Auto Green main menu and click **Save** to save the settings.

Button	Description
Standby	Enters Power on Suspend mode
Suspend	Enters Suspend to RAM mode
Disable	Disables this function



The Bluetooth dongle included in the motherboard package <sup>(Note 2)</sup> allows you to wake up the system from Suspend to RAM mode without the need to press the power button first.

(Note 1) If your cell phone has been configured as the Auto Green key, you'll not be able to use it to connect to other Bluetooth device(s) when Auto Green is enabled.

(Note 2) Whether the Bluetooth dongle is included depends on the motherboard models. Before installing the Bluetooth dongle, be sure to turn off other Bluetooth receiver on your computer.



# Chapter 5 Appendix

## 5-1 Configuring Audio Input and Output

### 5-1-1 Configuring 2/4/5.1/7.1-Channel Audio

The motherboard provides six audio jacks on the back panel which support 2/4/5.1/7.1-channel <sup>(Note)</sup> audio. The picture to the right shows the default audio jack assignments.

The integrated HD (High Definition) audio provides jack retasking capability that allows the user to change the function for each jack through the audio driver.

For example, in a 4-channel audio configuration, if a Rear speaker is plugged into the default Center/Subwoofer speaker out jack, you can retask the Center/Subwoofer speaker out jack to be Rear speaker out.



- To install a microphone, connect your microphone to the Mic in jack and manually configure the jack for microphone functionality.
- Audio signals will be present on both of the front and back panel audio connections simultaneously. If you want to mute the back panel audio (only supported when using an HD front panel audio module), refer to instructions on the next page.

### High Definition Audio (HD Audio)

HD Audio includes multiple high quality digital-to-analog converters (DACs) that support 44.1KHz/48KHz/96KHz/192KHz sampling rate. HD Audio features multistreaming capabilities that allow multiple audio streams (in and out) to be simultaneously processed. For example, users can listen to MP3 music, have an Internet chat, make a telephone call over the Internet, and etc. all at the same time.

### A. Configuring Speakers

(The following instructions use Windows Vista as the example operating system.)

Step 1:

After installing the audio driver, the **HD Audio Manager** icon  will appear in the notification area. Double-click the icon to access the **HD Audio Manager**.



(Note) 2/4/5.1/7.1-Channel Audio Configurations:

Refer to the following for multi-channel speaker configurations.

- 2-channel audio: Headphone or Line out.
- 4-channel audio: Front speaker out and Rear speaker out.
- 5.1-channel audio: Front speaker out, Rear speaker out, and Center/Subwoofer speaker out.
- 7.1-channel audio: Front speaker out, Rear speaker out, Center/Subwoofer speaker out, and Side speaker out.

**Step 2:**

Connect an audio device to an audio jack. The **The current connected device is** dialog box appears. Select the device according to the type of device you connect. Then click **OK**.

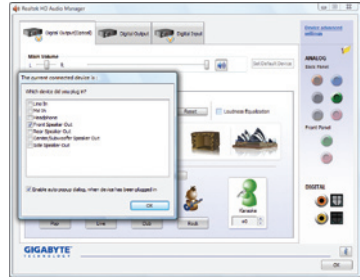

**Step 3:**

On the **Speakers** screen, click the **Speaker Configuration** tab. In the **Speaker Configuration** list, select **Stereo**, **Quadraphonic**, **5.1 Speaker**, or **7.1 Speaker** according to the type of speaker configuration you wish to set up. Then the speaker setup is completed.

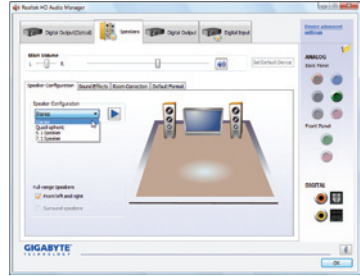

**B. Configuring Sound Effect**

You may configure an audio environment on the **Sound Effects** tab.

**C. Activating an AC'97 Front Panel Audio Module**

If your chassis provides an AC'97 front panel audio module, to activate the AC'97 functionality, click the tool icon on the **Speaker Configuration** tab. On the **Connector Settings** dialog box, select the **Disable front panel jack detection** check box. Click **OK** to complete.

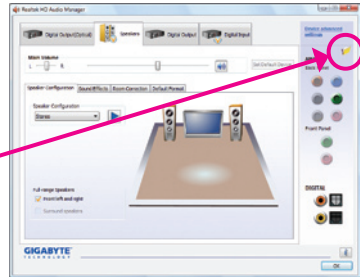
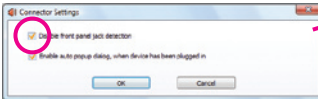

**D. Muting the Back Panel Audio (For HD Audio Only)**

Click **Device advanced settings** on the top right corner on the **Speaker Configuration** tab to open the **Device advanced settings** dialog box. Select the **Mute the rear output device, when a front headphone plugged in** check box. Click **OK** to complete.

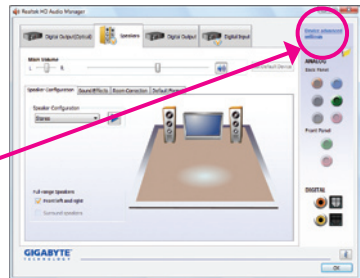
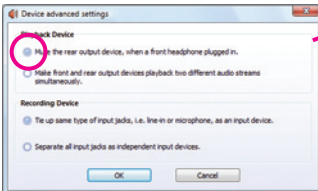

## 5-1-2 Configuring S/PDIF In/Out

### A. S/PDIF In

The S/PDIF In cable (optional) allows you to input digital audio signals to the computer for audio processing.

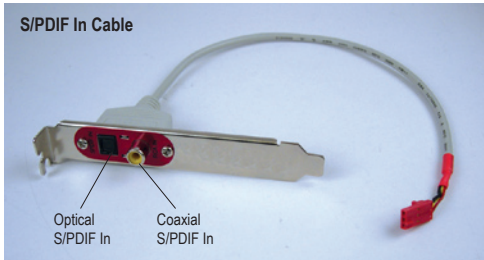

#### 1. Installing the S/PDIF In Cable:

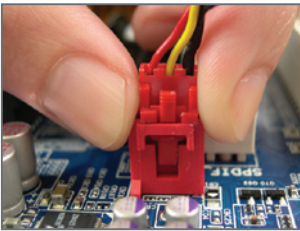

Step 1:  
First, attach the connector at the end of the cable to the SPDIF\_I header on your motherboard.

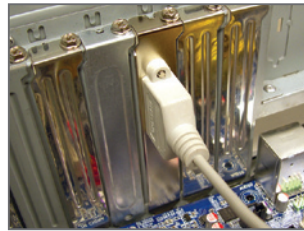

Step 2:  
Secure the metal bracket to the chassis back panel with a screw.

#### 2. Configuring S/PDIF In:

On the **Digital Input** screen, click the **Default Format** tab to select the default format. Click **OK** to complete.

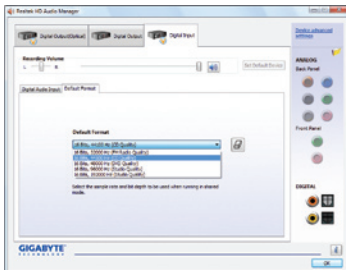

(Note) The actual locations of the S/PDIF In and S/PDIF Out connectors may differ by model.

## B. S/PDIF Out

The S/PDIF Out jack can transmit audio signals to an external decoder for decoding to get the best audio quality.

### 1. Connecting a S/PDIF Out Cable:

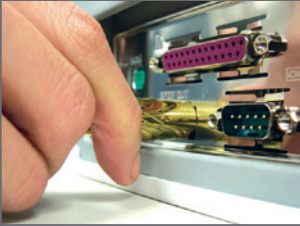

S/PDIF Optical Cable

Connect a S/PDIF optical cable to an external decoder for transmitting the S/PDIF digital audio signals.

### 2. Configuring S/PDIF Out:

On the **Digital Output(Optical)** screen <sup>(Note)</sup>, click the **Default Format** tab and then select the sample rate and bit depth. Click **OK** to complete.

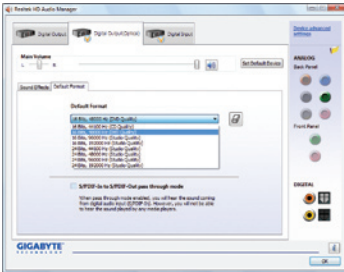

(Note) Enter the **Digital Output(Optical)** screen to configure further settings if you use the S/PDIF Out connector(s) on the back panel for digital audio output or enter the **Digital Output** screen if you use the internal S/PDIF Out connector (SPDIF\_O) for digital audio output.

### 5-1-3 Configuring Microphone Recording

#### Step 1:

After installing the audio driver, the **HD Audio Manager** icon  will appear in the notification area. Double-click the icon to access the **HD Audio Manager**.



#### Step 2:

Connect your microphone to the Mic in jack (pink) on the back panel or the Mic in jack (pink) on the front panel. Then configure the jack for microphone functionality.

Note: The microphone functions on the front panel and back panel cannot be used at the same time.

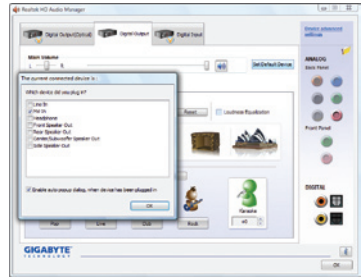

#### Step 3:

Go to the **Microphone** screen. Do not mute the recording volume, or you'll not be able to record the sound. To hear the sound being recorded during the recording process, do not mute the playback volume. It is recommended that you set the volumes at a middle level.

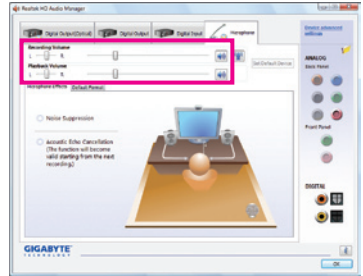

If you want to change the current sound input default device to microphone, right-click on **Microphone** and select **Set Default Device**.

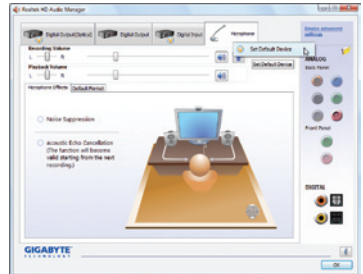

**Step 4:**

To raise the recording and playback volume for the microphone, click the **Microphone Boost** icon  on the right of the **Recording Volume** slider and set the Microphone Boost level.

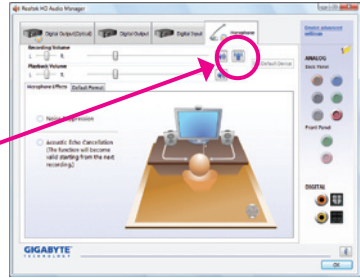

**Step 5:**

After completing the settings above, click **Start**, point to **All Programs**, point to **Accessories**, and then click **Sound Recorder** to begin the sound recording.

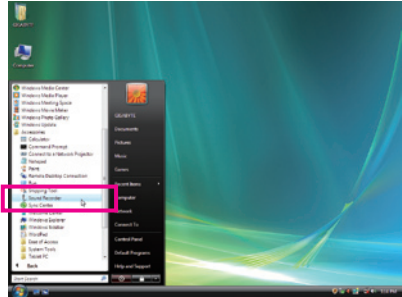

**\* Enabling Stereo Mix**

If the HD Audio Manager does not display the recording device you wish to use, refer to the steps below. The following steps explain how to enable Stereo Mix (which may be needed when you want to record sound from your computer).

**Step 1:**

Locate the **Volume** icon  in the notification area and right-click on this icon. Select **Recording Devices**.



**Step 2:**

On the **Recording** tab, right-click on an empty space and select **Show Disabled Devices**.

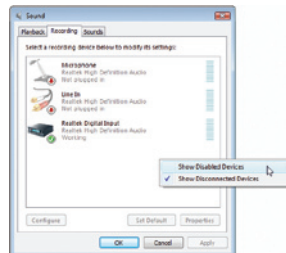

**Step 3:**

When the **Stereo Mix** item appears, right-click on this item and select **Enable**. Then set it as the default device.

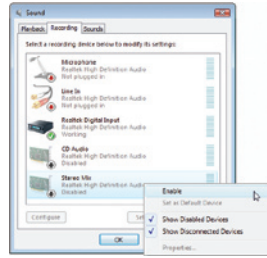

**Step 4:**

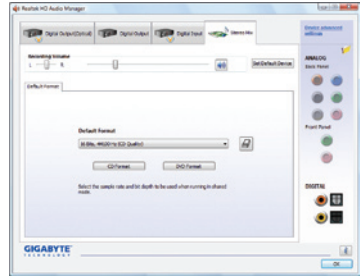

Now you can access the **HD Audio Manager** to configure **Stereo Mix** and use **Sound Recorder** to record the sound.

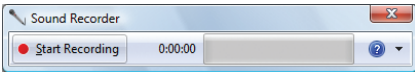

### 5-1-4 Using the Sound Recorder



#### A. Recording Sound

1. Make sure you have connected the sound input device (e.g. microphone) to the computer.
2. To record the audio, click the **Start Recording** button .
3. To stop recording audio, click the **Stop Recording** button .

Be sure to save the recorded audio file upon completion.

#### B. Playing the Recorded Sound

You can play your recording in a digital media player program that supports your audio file format.

## 5-2 Troubleshooting

### 5-2-1 Frequently Asked Questions

To read more FAQs for your motherboard, please go to the Support&Downloads\Motherboard\FAQ page on GIGABYTE's website.

Q: In the BIOS Setup program, why are some BIOS options missing?

A: Some advanced options are hidden in the BIOS Setup program. Press <Delete> to enter BIOS Setup during the POST. In the Main Menu, press <Ctrl>+<F1> to show the advanced options.

Q: Why is the light of my keyboard/optical mouse still on after the computer shuts down?

A: Some motherboards provide a small amount of standby power after the computer shuts down and that's why the light is still on.

Q: How do I clear the CMOS values?

A: For motherboards that have a CMOS\_SW button, press this button to clear the CMOS values (before doing this, please turn off the computer and unplug the power cord). For motherboards that have a clearing CMOS jumper, refer to the instructions on the CLR\_CMOS jumper in Chapter 1 to short the jumper to clear the CMOS values. If your board doesn't have this jumper, refer to the instructions on the motherboard battery in Chapter 1. You can temporarily remove the battery from the battery holder to stop supplying power to the CMOS, which will clear the CMOS values after about one minute.

Q: Why do I still get a weak sound even though I have turned my speaker to the maximum volume?

A: Make sure your speaker is equipped with an internal amplifier. If not, try a speaker with power/amplifier.

Q: Why cannot I install the onboard HD audio driver successfully? (For Windows XP only)

A: Step 1: First, make sure Service Pack 1 or Service Pack 2 has been installed (check in My Computer > Properties > General > System). If not, please update it from Microsoft's website. Then make sure the Microsoft UAA Bus Driver for High Definition Audio has been installed successfully (check in My Computer > Properties > Hardware > Device Manager > System Devices).

Step 2: Check if **Audio Device on High Definition Audio Bus** or **Unknown device** is present in **Device Manager** or **Sound, video, and game controllers**. If yes, please disable this device. (If not, skip this step.)

Step 3: Then go back to My Computer > Properties > Hardware > Device Manager > System devices and right-click on **Microsoft UAA Bus Driver for High Definition Audio** and select **Disable** and **Uninstall**.

Step 4: In **Device Manager**, right-click on the computer name and select **Scan for hardware changes**. When the **Add New Hardware Wizard** appears, click **Cancel**. Then install the onboard HD audio driver from the motherboard driver disk or download the audio driver from GIGABYTE's website to install.

For more details, go to the Support&Downloads\Motherboards\FAQ page on our website and search for "onboard HD audio driver."

Q: What do the beeps emitted during the POST mean?

A: The following Award BIOS beep code descriptions may help you identify possible computer problems.

(For reference only.)

1 short: System boots successfully

1 long, 3 short: Keyboard error

2 short: CMOS setting error

1 long, 9 short: BIOS ROM error

1 long, 1 short: Memory or motherboard error

Continuous long beeps: Graphics card not inserted properly

1 long, 2 short: Monitor or graphics card error

Continuous short beeps: Power error

## 5-2-2 Troubleshooting Procedure

If you encounter any troubles during system startup, follow the troubleshooting procedure below to solve the problem.

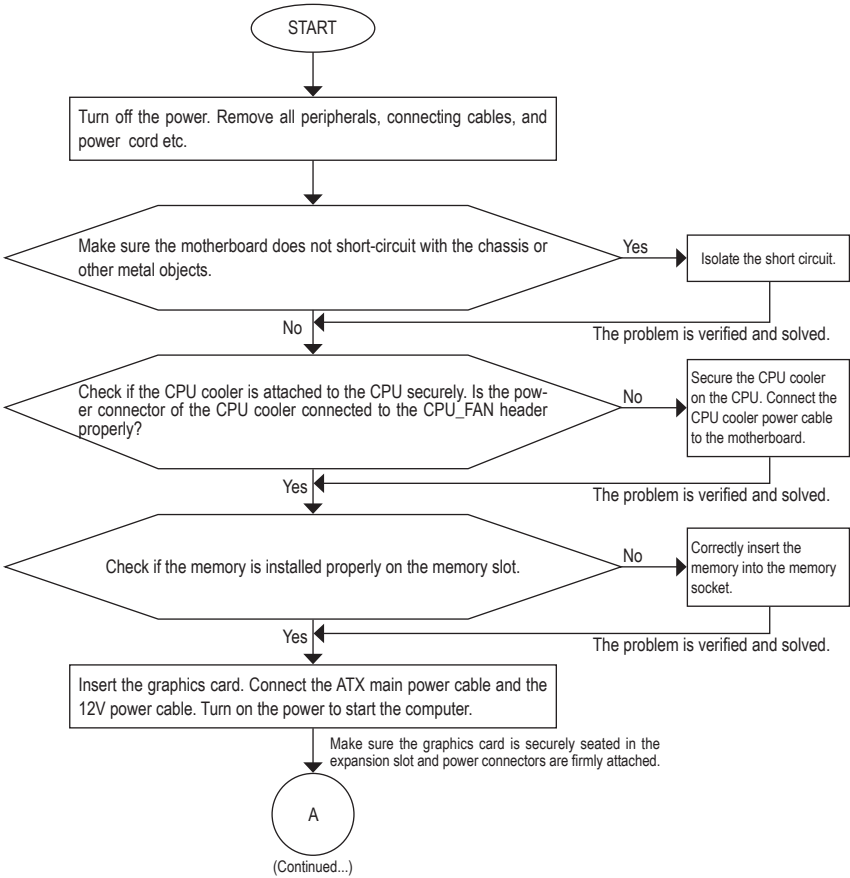

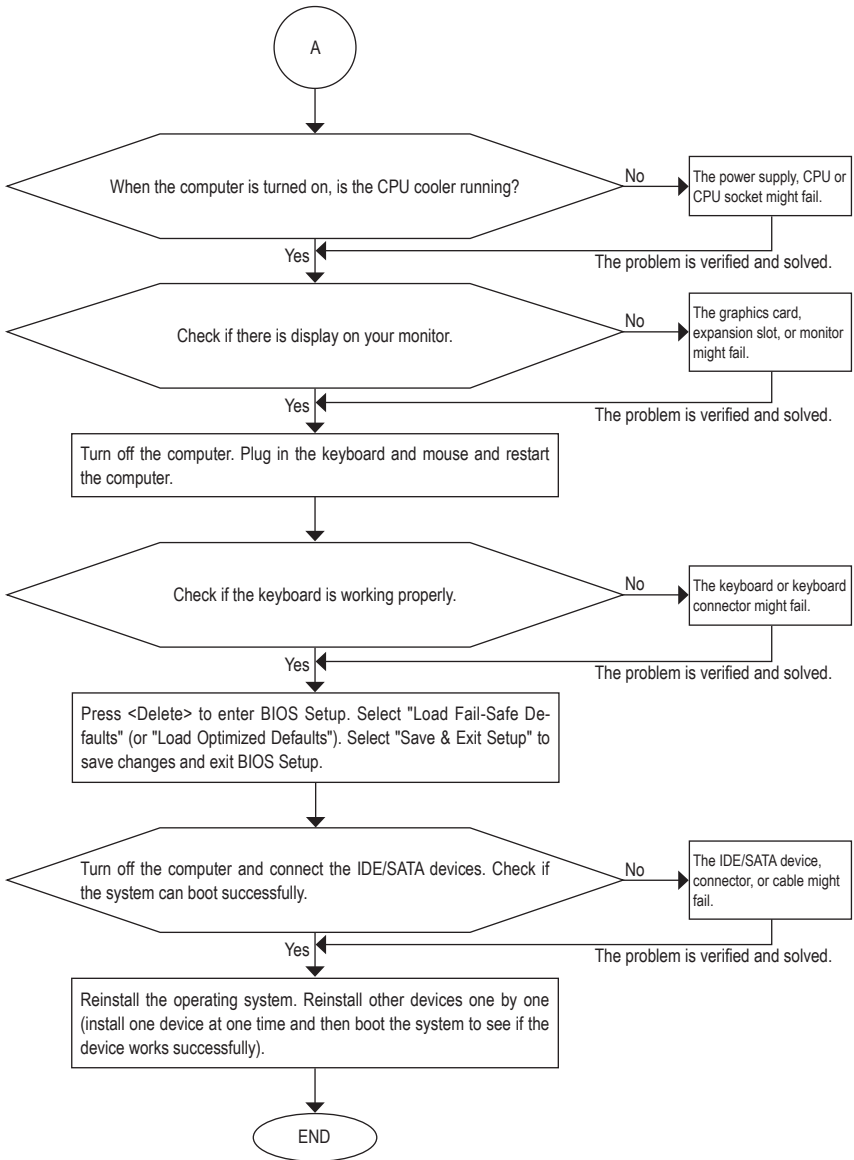

If the procedure above is unable to solve your problem, contact the place of purchase or local dealer for help. Or go to the **Support&Downloads\Technical Service Zone** page to submit your question. Our customer service staff will reply you as soon as possible.

## 5-3 Regulatory Statements

### Regulatory Notices

This document must not be copied without our written permission, and the contents there of must not be imparted to a third party nor be used for any unauthorized purpose. Contravention will be prosecuted. We believe that the information contained herein was accurate in all respects at the time of printing. GIGABYTE cannot, however, assume any responsibility for errors or omissions in this text. Also note that the information in this document is subject to change without notice and should not be construed as a commitment by GIGABYTE.

### Our Commitment to Preserving the Environment

In addition to high-efficiency performance, all GIGABYTE motherboards fulfill European Union regulations for RoHS (Restriction of Certain Hazardous Substances in Electrical and Electronic Equipment) and WEEE (Waste Electrical and Electronic Equipment) environmental directives, as well as most major worldwide safety requirements. To prevent releases of harmful substances into the environment and to maximize the use of our natural resources, GIGABYTE provides the following information on how you can responsibly recycle or reuse most of the materials in your "end of life" product.

### Restriction of Hazardous Substances (RoHS) Directive Statement

GIGABYTE products have not intended to add and safe from hazardous substances (Cd, Pb, Hg, Cr+6, PBDE and PBB). The parts and components have been carefully selected to meet RoHS requirement. Moreover, we at GIGABYTE are continuing our efforts to develop products that do not use internationally banned toxic chemicals.

### Waste Electrical & Electronic Equipment (WEEE) Directive Statement

GIGABYTE will fulfill the national laws as interpreted from the 2002/96/EC WEEE (Waste Electrical and Electronic Equipment) directive. The WEEE Directive specifies the treatment, collection, recycling and disposal of electric and electronic devices and their components. Under the Directive, used equipment must be marked, collected separately, and disposed of properly.

### WEEE Symbol Statement



The symbol shown below is on the product or on its packaging, which indicates that this product must not be disposed of with other waste. Instead, the device should be taken to the waste collection centers for activation of the treatment, collection, recycling and disposal procedure.

The separate collection and recycling of your waste equipment at the time of disposal will help to conserve natural resources and ensure that it is recycled in a manner that protects human health and the environment. For more information about where you can drop off your waste equipment for recycling, please contact your local government office, your household waste disposal service or where you purchased the product for details of environmentally safe recycling.

- ♦ When your electrical or electronic equipment is no longer useful to you, "take it back" to your local or regional waste collection administration for recycling.
- ♦ If you need further assistance in recycling, reusing in your "end of life" product, you may contact us at the Customer Care number listed in your product's user's manual and we will be glad to help you with your effort.

Finally, we suggest that you practice other environmentally friendly actions by understanding and using the energy-saving features of this product (where applicable), recycling the inner and outer packaging (including shipping containers) this product was delivered in, and by disposing of or recycling used batteries properly. With your help, we can reduce the amount of natural resources needed to produce electrical and electronic equipment, minimize the use of landfills for the disposal of "end of life" products, and generally improve our quality of life by ensuring that potentially hazardous substances are not released into the environment and are disposed of properly.

## China Restriction of Hazardous Substances Table

The following table is supplied in compliance with China's Restriction of Hazardous Substances (China RoHS) requirements:



关于符合中国《电子信息产品污染控制管理办法》的声明  
 Management Methods on Control of Pollution from Electronic Information Products  
 (China RoHS Declaration)

产品中有毒有害物质或元素的名称及含量  
 Hazardous Substances Table

部件名称 (Parts)	有毒有害物质或元素 (Hazardous Substances)					
	铅 (Pb)	汞 (Hg)	镉 (Cd)	六价铬 (Cr (VI))	多溴联苯 (PBB)	多溴二苯醚 (PBDE)
PCB板 PCB	○	○	○	○	○	○
结构件及风扇 Mechanical parts and Fan	×	○	○	○	○	○
芯片及其他主动零件 Chip and other Active components	×	○	○	○	○	○
连接器 Connectors	×	○	○	○	○	○
被动电子元器件 Passive Components	×	○	○	○	○	○
线材 Cables	○	○	○	○	○	○
焊接金属 Soldering metal	○	○	○	○	○	○
助焊剂, 散热膏, 标签及其他耗材 Flux, Solder Paste, Label and other Consumable Materials	○	○	○	○	○	○
○: 表示该有毒有害物质在该部件所有均质材料中的含量均在SJ/T11363-2006标准规定的限量要求以下。 Indicates that this hazardous substance contained in all homogenous materials of this part is below the limit requirement SJ/T 11363-2006						
×: 表示该有毒有害物质至少在该部件的某一均质材料中的含量超出SJ/T11363-2006标准规定的限量要求。 Indicates that this hazardous substance contained in at least one of the homogenous materials of this part is above the limit requirement in SJ/T 11363-2006						
对销售之日的所发售产品, 本表显示我公司供应链的电子信息产品可能包含这些物质。注意: 在所售产品中可能会也可能不会含有所有列出的部件。 This table shows where these substances may be found in the supply chain of our electronic information products, as of the date of the sale of the enclosed products. Note that some of the component types listed above may or may not be a part of the enclosed product.						















## Contact Us

---

- **GIGA-BYTE TECHNOLOGY CO., LTD.**

Address: No.6, Bau Chiang Road, Hsin-Tien,

Taipei 231, Taiwan

TEL: +886-2-8912-4000

FAX: +886-2-8912-4003

Tech. and Non-Tech. Support (Sales/Marketing) :

<http://ggts.gigabyte.com.tw>

WEB address (English): <http://www.gigabyte.com>

WEB address (Chinese): <http://www.gigabyte.tw>

---

- **G.B.T. INC. - U.S.A.**

TEL: +1-626-854-9338

FAX: +1-626-854-9339

Tech. Support:

<http://rma.gigabyte.us>

Web address: <http://www.gigabyte.us>

---

- **G.B.T. INC (USA) - Mexico**

Tel: +1-626-854-9338 x 215 (Soporte de habla hispano)

FAX: +1-626-854-9339

Correo: [soporte@gigabyte-usa.com](mailto:soporte@gigabyte-usa.com)

Tech. Support:

<http://rma.gigabyte.us>

Web address: <http://latam.giga-byte.com>

---

- **Giga-Byte SINGAPORE PTE. LTD. - Singapore**

WEB address : <http://www.gigabyte.sg>

---

- **Thailand**

WEB address : <http://th.giga-byte.com>

---

- **Vietnam**

WEB address : <http://www.gigabyte.vn>

---

---

- **NINGBO G.B.T. TECH. TRADING CO., LTD. - China**

WEB address : <http://www.gigabyte.cn>

**Shanghai**

TEL: +86-21-63410999

FAX: +86-21-63410100

**Beijing**

TEL: +86-10-62102838

FAX: +86-10-62102848

**Wuhan**

TEL: +86-27-87851061

FAX: +86-27-87851330

**GuangZhou**

TEL: +86-20-87540700

FAX: +86-20-87544306

**Chengdu**

TEL: +86-28-85236930

FAX: +86-28-85256822

**Xian**

TEL: +86-29-85531943

FAX: +86-29-85510930

**Shenyang**

TEL: +86-24-83992901

FAX: +86-24-83992909

---

- **GIGABYTE TECHNOLOGY (INDIA) LIMITED - India**

WEB address : <http://www.gigabyte.in>

---

- **Saudi Arabia**

WEB address : <http://www.gigabyte.com.sa>

---

- **Gigabyte Technology Pty. Ltd. - Australia**

WEB address : <http://www.gigabyte.com.au>

---

---

- **G.B.T. TECHNOLOGY TRADING GMBH - Germany**

WEB address : <http://www.gigabyte.de>

---

- **G.B.T. TECH. CO., LTD. - U.K.**

WEB address : <http://www.giga-byte.co.uk>

---

- **Giga-Byte Technology B.V. - The Netherlands**

WEB address : <http://www.giga-byte.nl>

---

- **GIGABYTE TECHNOLOGY FRANCE - France**

WEB address : <http://www.gigabyte.fr>

---

- **Sweden**

WEB address : <http://www.gigabyte.se>

---

- **Italy**

WEB address : <http://www.giga-byte.it>

---

- **Spain**

WEB address : <http://www.giga-byte.es>

---

- **Greece**

WEB address : <http://www.gigabyte.com.gr>

---

- **Czech Republic**

WEB address : <http://www.gigabyte.cz>

---

---

- **Hungary**

WEB address : <http://www.giga-byte.hu>

---

- **Turkey**

WEB address : <http://www.gigabyte.com.tr>

---

- **Russia**

WEB address : <http://www.gigabyte.ru>

---

- **Poland**

WEB address : <http://www.gigabyte.pl>

---

- **Ukraine**

WEB address : <http://www.gigabyte.ua>

---

- **Romania**

WEB address : <http://www.gigabyte.com.ro>

---

- **Serbia**

WEB address : <http://www.gigabyte.co.rs>

---

- **Kazakhstan**

WEB address : <http://www.gigabyte.kz>

---

You may go to the GIGABYTE website, select your language in the language list on the top right corner of the website.

- **GIGABYTE Global Service System**



To submit a technical or non-technical (Sales/Marketing) question, please link to:

<http://ggts.gigabyte.com.tw>

Then select your language to enter the system.