



HP Scanjet 7000n Series

User Guide

Copyright and License

© 2011 Copyright Hewlett-Packard Development Company, L.P.

Reproduction, adaptation, or translation without prior written permission is prohibited, except as allowed under the copyright laws.

The information contained herein is subject to change without notice.

The only warranties for HP products and services are set forth in the express warranty statements accompanying such products and services. Nothing herein should be construed as constituting an additional warranty. HP shall not be liable for technical or editorial errors or omissions contained herein.

Edition 2, 1/2011

Trademark Credits

Adobe®, Acrobat®, and PostScript® are trademarks of Adobe Systems Incorporated.

Java™ is a US trademark of Sun Microsystems, Inc.

Microsoft®, Windows®, Windows® XP, and Windows Vista® are U.S. registered trademarks of Microsoft Corporation.

UNIX® is a registered trademark of The Open Group.

ENERGY STAR and the ENERGY STAR mark are registered U.S. marks.

OCR Technology by I.R.I.S., copyright 1987-2009, All Rights Reserved.

iHQC™ compression technology by I.R.I.S., copyright 2007-2009, All Rights Reserved (Patent Pending).

PDF-iHQC™, XPS-iHQC™ technology by I.R.I.S. copyright 2007-2009.

Table of contents

1 Product basics	1
Conventions used in this guide	2
Product features	3
Product walkaround	5
Front view	5
Back view	6
Serial number and model number location	6
2 Control panel	7
Use the control panel	8
Control-panel layout	8
Home screen	10
Buttons on the touch screen	11
Control-panel help system	11
Navigate the Administration menu	12
Jetdirect menus	12
3 Supported utilities for Windows	17
HP Web Jetadmin	18
Embedded Web Server	18
HP Digital Sending Software (HP DSS)	18
4 Configure the product	19
Supported network protocols	20
Configure the product to use the network	22
View or change network settings	22
Set or change the administrator password	22
Manually configure IPv4 TCP/IP parameters from the control panel	23
Manually configure IPv6 TCP/IP parameters from the control panel	24
Disable network protocols (optional)	25
Link speed and duplex settings	25

Configure e-mail settings	26
Supported protocols	26
Configure e-mail options	26
Configure other digital sending settings	28
5 Load originals	30
Supported document sizes	31
General document loading tips	32
Document loading tips for mixed-size documents	34
Load documents	35
6 Scan and send documents	37
Sign In	38
Preview a scan	39
Use the Image Preview screen	39
Send a scanned document to one or more e-mails	41
Use the address book	41
Create a recipient list	41
Use the Personal or Shared Contacts address book	41
Add entries to the Personal or Shared Contacts address books	42
Delete entries from the Personal Contacts address book	42
Use the Send E-mail screen	42
Send documents	43
Send a document	43
Use the auto-complete function	43
Fax a scanned document	44
Use the Send Fax screen	44
Send a fax	45
Save to a network folder or USB storage device	46
Send or save a document using Quick Sets	47
Scan to a workflow destination	48
7 Manage and maintain the product	49
Use information pages	50
Embedded Web Server	51
Open the Embedded Web Server	51
Embedded Web Server options	51
Use HP Web Jetadmin software	53
Controlling digital-sending security	54
Network authentication	54

Secure e-mail	54
Restrict software access	54
Security features	55
Secure the Embedded Web Server	55
Manage temporary job files	55
Secure Storage Erase	56
Data affected	56
Secure File Erase	56
Secure Disk Erase	56
HP High-Performance Secure Hard Disks	57
Manage certificates	57
Load a certificate	57
Load a certificate revocation list (CRL)	57
Authentication and authorization	57
Test and calibrate the touch screen	59
Test the touch screen	59
Calibrate the touch screen	59
Install the hardware integration pocket	60
Clean the product	63
Clean the touch screen	63
Clean the product glass	63
Clean the paper path	64
Clean the rollers	64
Order maintenance and scanning supplies	68
Replace supplies and parts	69
Replace the rollers	69
Replace the keyboard	69
Replace the Jetdirect card	70
Replace the hard drive	72
Upgrade the firmware	75
Upgrade the product firmware	75
Upgrade the HP Jetdirect Inside firmware	75
8 Solve problems	77
Error codes	78
Basic troubleshooting tips	79
Restore factory settings	80
Interpret control-panel status lights	81
Control-panel message types	82
Control-panel messages	83
Installation problems	84

Initialization or hardware problems	85
Check the Ethernet connection	85
Check the power connection	85
Reset the product	86
The product has stopped working correctly	86
Operation problems	87
Product will not turn on	87
Lamp stays on	87
Scan does not start right away	87
Only one side of a two-sided page scans	88
Scanned pages are missing at the scan destination	88
Scanned pages are out of order at the scan destination	88
Optimize scanning and task speeds	88
The scan is completely black or completely white	88
Scanned images are not straight	88
Scan files are too large	88
Paper path problems	90
Paper jamming, skewing, misfeeds, or multiple-page feeds	90
Scanning fragile originals	90
Paper does not feed correctly	90
Originals are curling up in the output tray	91
The bottom of the scanned image is cut off	91
The scanned images have streaks or scratches	91
An item loaded in the document feeder jams repeatedly	91
Clear jams from the paper path	91
Solve e-mail problems	93
Validate the SMTP gateway address	93
Validate the LDAP gateway address	93
Solve network problems	94
Contact HP Support	95
Appendix A Supplies and accessories	96
Order parts, accessories, and supplies	97
Part numbers	98
Accessories	98
Cables and interfaces	98
Maintenance kits	98
Appendix B Service and support	99
Hewlett-Packard limited warranty statement	100
OpenSSL	101

Customer self-repair warranty service	103
Customer support	104
Appendix C Product specifications	105
Physical specifications	106
Power consumption	106
Environmental specifications	106
Certificate of Volatility	107
Volatile memory	107
Non-volatile memory	107
Hard-disk-drive memory	107
Appendix D Regulatory information	108
Regulatory model number	109
Environmental product stewardship program	110
Protecting the environment	110
Power consumption	110
Plastics	110
Material restrictions	110
Disposal of waste equipment by users in private households in the European Union	111
Chemical substances	111
For more information	111
Safety statements	111
Index	112

1 Product basics

- [Conventions used in this guide](#)
- [Product features](#)
- [Product walkaround](#)

Conventions used in this guide

Throughout this guide, several tips, notes, cautions, and warnings alert you about important information.

 **TIP:** Tips provide helpful hints or shortcuts.

 **NOTE:** Notes provide important information to explain a concept or to complete a task.

 **CAUTION:** Cautions indicate procedures that you should follow to avoid losing data or damaging the product.

 **WARNING!** Warnings alert you to specific procedures that you should follow to avoid personal injury, catastrophic loss of data, or extensive damage to the product.

Product features

Table 1-1 Features

Resolution	600 pixels per inch (ppi)
Memory	<ul style="list-style-type: none">• 512 MB of random-access memory (RAM).• Memory Enhancement technology (MEt) automatically compresses data to use RAM more efficiently.
User interface	<ul style="list-style-type: none">• HP Easy Select full color control panel• Embedded Web Server (EWS) to configure the product and gain access to support
Paper-handling	<ul style="list-style-type: none">• Document feeder: Holds up to 50 sheets of paper.• Two-sided scanning: The document feeder has an automatic duplexer for scanning two-sided documents.• Blank page suppression: Suppresses blank pages in scanned output (works best with white or light-colored pages).• Standard output tray: The output tray is located near the bottom of the product. This tray can hold up to 50 sheets of paper.• HP Precision Feed technology with multiphase pick process, advanced separation and intelligent picking technologies, mixed-stack handling, and ultrasonic double-feed detection.
Connectivity	<ul style="list-style-type: none">• Local area network (LAN) connector (RJ-45) for the embedded HP Jetdirect card• One enhanced input/output (EIO) slot, which is occupied by the Jetdirect card• USB 2.0 connection for FAT-formatted portable storage device <p>NOTE: USB-connected external hard drives are not supported.</p> <ul style="list-style-type: none">• Optional HP Digital Sending Software (DSS)• Hardware integration pocket
Environmental features	<ul style="list-style-type: none">• Sleep Delay setting saves energy• High content of recyclable components and materials• Instant-on technology• Energy Star® compliance

Table 1-1 Features (continued)

Security features	<ul style="list-style-type: none">• Secure disk erase• Secure storage erase• Secure file erase• Authentication<ul style="list-style-type: none">◦ User access code authentication◦ Windows (Kerberos and NTLM)◦ LDAP• Jetdirect card<ul style="list-style-type: none">◦ IPsec◦ Password protection◦ SSL◦ TLS◦ SNMPv3◦ 802.1x authentication◦ IPP over TLS• Secure communication between the product and network servers• IPsec security (hardware)• Support for HP High-Performance Secure Hard Disk
Scanning and sending	<ul style="list-style-type: none">• Modes for text, graphics, and mixed text and graphics formats• Embedded OCR• Job-interrupt feature• Control-panel animations (for example, jam recovery)• Scan and send to e-mail, fax, network folder, and USB device<ul style="list-style-type: none">◦ Address book for e-mail and fax◦ Send to digital fax (Internet and LAN fax)• Retrieve contacts from a network directory (LDAP)• Automatic duplex (two-sided) scanning

Product walkaround

Front view

⚠ CAUTION: If you need to move the product, always lift the product from the base. Do not lift using the keyboard.



1	Power button
2	Document feeder latch
3	Hardware integration pocket (HIP) panel
4	USB connector for portable storage device
5	Control panel

Back view

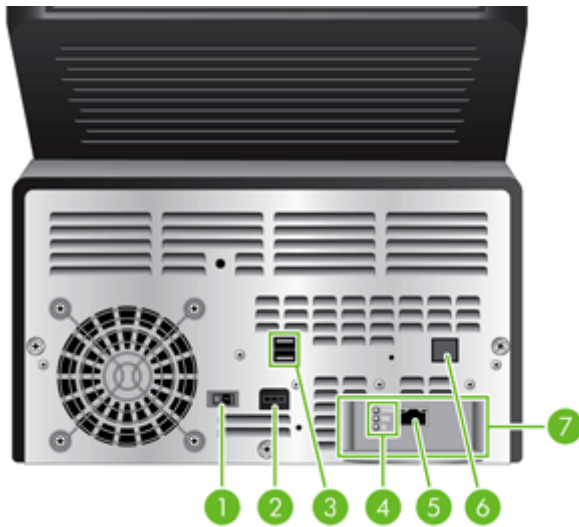

1	Power switch
2	Power connector
3	USB ports
4	Network link speed indicators
5	Ethernet port
6	Covered Ethernet port for service access
7	EIO slot containing a Jetdirect card

Serial number and model number location



Model name	Model number
HP Scanjet Enterprise 7000n	L2709A
	L2708A

2 Control panel

- [Use the control panel](#)
- [Navigate the Administration menu](#)

Use the control panel







The control panel has an SVGA touch screen that provides access to all product functions, virtual and physical keyboard, and a keypad with buttons for common tasks. Use the buttons and keyboard to control jobs and the product status. The LEDs indicate overall product status.



 **TIP:** If touch screen touches are yielding unexpected (or no) results, you may need to calibrate the touch screen. To verify that calibration is necessary, you should first test the touch screen. See [Test and calibrate the touch screen on page 59](#).

Control-panel layout

The control panel includes a touch screen graphical display, job-control buttons, a keyboard, and three light-emitting diode (LED) status lights.



1	Keyboard	Use the keyboard for entering text and numbers into fields on the touch screen.
2	Touch screen	Use the touch screen to access product functions.
3	 Sleep button	If the product is inactive for a long period of time, it automatically enters a sleep mode. To place the product into sleep mode or to reactivate the product, press the Sleep button.
4	 Stop button	Stops the active job and opens the Job Status screen.
5	 Start button	Starts digital sending (e-mail and fax, for example), or continues a job that has been interrupted.
6	 Attention LED	The Attention LED indicates that the product has a condition that requires intervention.
7	 Data LED	The Data LED indicates that the product is receiving data.
8	 Ready LED	The Ready LED indicates that the product is ready to begin processing any job.

9		Reset button	Resets the job settings to factory or user-defined default values.
10		Touch screen brightness-adjustment control	Use this control to increase or decrease the brightness of the touch screen display.

Home screen

The home screen provides access to the product features, and it indicates the current status of the product.



1	Features	Depending on how the product is configured, the features that appear in this area can include any of the following items: <ul style="list-style-type: none">• Fax• E-mail• Job Status• Save to Network Folder• Save to USB• Quick Sets• Workflow• Administration• Service
2	Product status line	The status line provides information about the overall product status. Various buttons appear in this area, depending on the current status.
3	Help button	Touch the Help button to open the embedded help system.
4	Scroll bar	Touch the up or down arrows on the scroll bar to see the complete list of available features.
5	Sign In/Sign Out	Touch this button to sign in or sign out of the product. After you sign out, the product restores all options to the default settings.
6	Network Address button	Touch the Network Address button to find information about the network connection.
7	Date and time	The current date and time appear here. You can select the format that the product uses to show the date and time, for example 12-hour format or 24-hour format.

Buttons on the touch screen

The touch screen provides information about the product status. Various buttons can appear in this area.



Home button. Touch this button to go to the Home screen from any other screen.



Start button. Touch this button to begin the action for the feature that you are using.

NOTE: The name of this button changes for each feature. For example, in the digital fax feature, the button is named [Send Fax](#).



Error button. This button appears whenever the product has an error that requires attention before it can continue. Touch the Error button to see a message that describes the error. The message also has instructions for solving the problem.



Warning button. This button appears when the product has a problem but can continue functioning. Touch the Warning button to see a message that describes the problem. The message also has instructions for solving the problem.





Help button. Touch this button to open the built-in online Help system.

Control-panel help system

The product has a built-in Help system that explains how to use each screen. To open the Help system, touch the Help button  in the upper-right corner of the screen.

For some screens, the Help opens to a global menu where you can search for specific topics. You can browse through the menu structure by touching the buttons in the menu.

For screens that contain settings for individual jobs, the Help opens to a topic that explains the options for that screen.

If the product alerts you of an error or warning, touch the error  or warning  button to open a message that describes the problem. The message also contains instructions to help solve the problem.

Navigate the Administration menu

From the Home screen, touch the [Administration](#) button to open the menu structure. You might need to scroll to the bottom of the Home screen to see this feature.

The [Administration](#) menu has several sub-menus that you can use for some setup tasks. (Use the Embedded Web Server to configure all settings.) Touch the name of a menu to expand the structure. A plus sign (+) next to a menu name means that it contains sub-menus. Continue opening the structure until you reach the option that you want to configure. To return to the previous level, touch the Back button .



NOTE: The Back button  is not available on all screens.

To exit the [Administration](#) menu, touch the Home button  in the upper-left corner of the screen.

The product has built-in Help that explains each of the features that are available through the menus. Help is available for many menus on the right-hand side of the touch screen.

The table in this section provides general information about each menu. For information about specific entries in each menu, see the built-in Help.

Table 2-1 Administration menus

Menu item	Description
Reports	Use this menu to view information pages and reports that are stored internally on the product.
General Settings	Use this menu to set options for setting the time and period of inactivity before the product enters sleep mode.
Scan/Digital Send Settings	Use this menu to set up e-mail, save-to-network-folder, save-to-USB-device, and digital-send-service options.
Fax Settings	Use this menu to set up fax-send options.
Display Settings	Use this menu to set up basic display and device behavior settings (keypress sound, display language, network address button display, sleep mode and interval, and more).
Network Settings	Use this menu to set up I/O timeout options and to access the Jetdirect menu.

Jetdirect menus

[Administration](#) > [Network Settings](#) > [Jetdirect Menu](#)

Table 2-2 Jetdirect menus

Menu item	Sub-menu item	Sub-menu item	Values and Description
Information	Print Protocols		Yes : Use print protocols.
			No (default): Do not use print protocols.
	Print Sec Report		Yes : Print the security report.
			No (default): Do not print the security report.
TCP/IP	Enable		Off : Disable the TCP/IP protocol.
			On (default): Enable the TCP/IP protocol.

Table 2-2 Jetdirect menus (continued)

Menu item	Sub-menu item	Sub-menu item	Values and Description
	Host Name		An alphanumeric string, up to 32 characters, used to identify the product. This name is listed on the HP Jetdirect configuration page. The default host name is NPIxxxxxx, where xxxxxx is the last six digits of the LAN hardware (MAC) address.
	IPv4 Settings	Config Method	<p>Specifies the method that TCP/IPv4 parameters will be configured on the HP Jetdirect server.</p> <p>Bootp: Use BOOTP (Bootstrap Protocol) for automatic configuration from a BOOTP server.</p> <p>DHCP: Use DHCP (Dynamic Host Configuration Protocol) for automatic configuration from a DHCPv4 server. If selected and a DHCP lease exists, DHCP Release and DHCP Renew menus are available to set DHCP lease options.</p> <p>Auto IP: Use automatic link-local IPv4 addressing. An address in the form 169.254.x.x is assigned automatically.</p> <p>Manual: Use the Manual Settings menu to configure TCP/IPv4 parameters.</p>
		Default IP	<p>Specify the IP address to default to when the Jetdirect server is unable to obtain an IP address from the network during a forced TCP/IP reconfiguration (for example, when manually configured to use BOOTP or DHCP).</p> <p>Auto IP: A link-local IP address 169.254.x.x is set.</p> <p>Legacy: The address 192.0.0.192 is set, consistent with older HP Jetdirect products.</p>
		DHCP Release	<p>This menu appears if the Config Method item was set to the DHCP value and a DHCP lease for the Jetdirect server exists.</p> <p>No (default): The current DHCP lease is saved.</p> <p>Yes: The current DHCP lease and the leased IP address are released.</p>
		DHCP Renew	<p>This menu appears if the Config Method item was set to the DHCP value and a DHCP lease for the Jetdirect server exists.</p> <p>No (default): The Jetdirect server does not request to renew the DHCP lease.</p> <p>Yes: The Jetdirect server requests to renew the current DHCP lease.</p>

Table 2-2 Jetdirect menus (continued)

Menu item	Sub-menu item	Sub-menu item	Values and Description
		Manual Settings	<p>(Available only if the Config Method item is set to the Manual value) Configure parameters directly from the control panel:</p> <p>IP Address: The unique IP address of the product (n.n.n.n), where n is a value from 0 to 255.</p> <p>Subnet Mask: The subnet mask for the product (m.m.m.m), where m is a value from 0 to 255.</p> <p>Syslog Server: The IP address of the syslog server used to receive and log syslog messages.</p> <p>Default Gateway: The IP address of the gateway or router used for communications with other networks.</p> <p>Idle Timeout: The time period, in seconds, after which an idle TCP data connection is closed (default is 270 seconds, 0 disables the timeout).</p>
		Primary DNS	Specify the IP address (n.n.n.n) of a Primary DNS Server.
		Secondary DNS	Specify the IP address (n.n.n.n) of a Secondary Domain Name System (DNS) Server.
	IPV6 Settings	Enable	<p>Use this item to enable or disable IPv6 operation on the server.</p> <p>Off: IPv6 is disabled.</p> <p>On (default): IPv6 is enabled.</p>
		Address	Type the server address, a 32 hexadecimal digit IPv6 node address that uses the colon hexadecimal syntax.
		DHCPV6 Policy	<p>Router Specified: The stateful auto-configuration method to be used by the Jetdirect server is determined by a router. The router specifies whether the Jetdirect server obtains its address, its configuration information, or both from a DHCPv6 server.</p> <p>Router Unavailable (default): If a router is not available, the Jetdirect server should attempt to obtain its stateful configuration from a DHCPv6 server.</p> <p>Always: Whether or not a router is available, the Jetdirect server always attempts to obtain its stateful configuration from a DHCPv6 server.</p>
		Primary DNS	Use this item to specify an IPv6 address for a primary DNS server that the Jetdirect server should use.
		Secondary DNS	Use this item to specify an IPv6 address for a secondary DNS server that the Jetdirect server should use.

Table 2-2 Jetdirect menus (continued)

Menu item	Sub-menu item	Sub-menu item	Values and Description
		Manual	<p>Use this item to manually set IPv6 addresses on the server.</p> <p>Enable: Select this item and choose the On setting to enable manual configuration, or the Off setting to disable manual configuration.</p> <p>Address: Use this item to type a 32 hexadecimal digit IPv6 node address that uses the colon hexadecimal syntax.</p>
	Proxy Server		<p>Specifies the proxy server to be used by embedded applications in the product. A proxy server is typically used by network clients for Internet access. It caches Web pages, and provides a degree of Internet security, for those clients.</p> <p>To specify a proxy server, enter its IPv4 address or fully-qualified domain name. The name can be up to 255 octets.</p> <p>For some networks, you may need to contact your Independent Service Provider (ISP) for the proxy server address.</p>
	Proxy Port		<p>Type the port number used by the proxy server for client support. The port number identifies the port reserved for proxy activity on your network, and can be a value from 0 to 65535.</p>
	Idle Timeout		<p>Idle Timeout: The time period, in seconds, after which an idle TCP data connection is closed (default is 270 seconds, 0 disables the timeout).</p>
IPX/SPX	Enable		Not applicable for HP Scanjet Enterprise 7000n
AppleTalk	Enable		Not applicable for HP Scanjet Enterprise 7000n
DLC/LLC	Enable		Not applicable for HP Scanjet Enterprise 7000n
Security	Secure Web		<p>For configuration management, specify whether the Embedded Web Server will accept communications using HTTPS (Secure HTTP) only, or both HTTP and HTTPS.</p> <p>HTTPS Required: For secure, encrypted communications, only HTTPS access is accepted. The Jetdirect server will appear as a secure site.</p> <p>HTTPS Optional (default): Access using either HTTP or HTTPS is permitted.</p>
	IPSec		<p>Specify the IPSec status on the Jetdirect server.</p> <p>Keep: IPSec or firewall status remains the same as currently configured.</p> <p>Disable: IPSec or firewall operation on the Jetdirect server is disabled.</p>

Table 2-2 Jetdirect menus (continued)

Menu item	Sub-menu item	Sub-menu item	Values and Description
		802.1X	<p>Reset 802.1X settings to factory defaults.</p> <p>No (default): Retain current 802.1X settings.</p> <p>Yes: Reset 802.1X settings to factory defaults.</p>
		Enable Wipe	<p>Most configuration settings are erased during a cold reset. However, you can indicate whether to also erase stored digital certificates.</p> <p>Yes: Erase all stored digital certificates during a cold reset.</p> <p>No (default): Do not erase stored digital certificates during a cold reset.</p>
	Reset Security		<p>Specify whether the current security settings on the Jetdirect server will be saved or reset to factory defaults.</p> <p>No (default): The current security settings are maintained.</p> <p>Yes: Security settings are reset to factory defaults.</p>
Link Speed			<p>The link speed and communication mode of the Jetdirect server must match the network. The available settings depend on the product and installed Jetdirect server. Select one of the following link configuration settings:</p> <p>CAUTION: If you change the link setting, network communications with the Jetdirect server and network product might be lost.</p> <p>Auto (default): The Jetdirect server uses auto-negotiation to configure itself with the highest link speed and communication mode allowed. If auto-negotiation fails, either the 100TX Half value or the 10T Half value is set depending on the detected link speed of the hub/switch port. (A 1000T half-duplex selection is not supported.)</p> <p>10T Half: 10 Mbps, half-duplex operation.</p> <p>10T Full: 10 Mbps, full-duplex operation.</p> <p>100TX Half: 100 Mbps, half-duplex operation.</p> <p>100TX Full: 100 Mbps, full-duplex operation.</p> <p>100TX Auto: Limits auto-negotiation to a maximum link speed of 100 Mbps.</p> <p>1000T Full: 1000 Mbps, full-duplex operation.</p>

3 Supported utilities for Windows

- [HP Web Jetadmin](#)
- [Embedded Web Server](#)
- [HP Digital Sending Software \(HP DSS\)](#)

HP Web Jetadmin

HP Web Jetadmin is a simple print and imaging peripheral management software tool that helps optimize product use, control color costs, secure products, and streamline supplies management by enabling remote configuration, proactive monitoring, security troubleshooting, and reporting of printing and imaging products.

To download a current version of HP Web Jetadmin and for the latest list of supported host systems, visit www.hp.com/go/webjetadmin.

When installed on a host server, a Windows client can gain access to HP Web Jetadmin by using a supported Web browser (such as Microsoft® Internet Explorer) by navigating to the HP Web Jetadmin host.

Embedded Web Server

The product is equipped with an Embedded Web Server, which provides access to information about product and network activities. This information appears in a Web browser, such as Microsoft Internet Explorer or Mozilla Firefox.

The Embedded Web Server resides on the product. It is not loaded on a network server.

The Embedded Web Server provides an interface to the product that anyone who has a network-connected computer and a standard Web browser can use. No special software is installed or configured, but you must have a supported Web browser on your computer. To gain access to the Embedded Web Server, type the IP address for the product in the address line of the browser. (To find the IP address, touch the [Network Address](#) button on the Home screen.)

HP Digital Sending Software (HP DSS)

You can install the optional HP Digital Sending Software. This software runs as a service on a network server and allows multiple products to send jobs through the server. It is not necessary to install any software or drivers on individual user's computers. For information about compatible versions of HP DSS and to purchase the software, see www.hp.com/go/dss.

4 Configure the product

You might need to configure certain network parameters on the product. You can configure these parameters from the Embedded Web Server or (for most networks) the HP Web Jetadmin software.

- [Supported network protocols](#)
- [Configure the product to use the network](#)
- [Configure e-mail settings](#)
- [Configure other digital sending settings](#)

Supported network protocols

The product supports the TCP/IP network protocol, the most widely used and accepted networking protocol. Many networking services utilize this protocol. The following tables list the supported networking services and protocols.

Table 4-1 Network device discovery

Service name	Description
SLP (Service Location Protocol)	Device-discovery protocol, used to help find and configure network devices. Used primarily by Microsoft-based programs.

Table 4-2 Messaging and management

Service name	Description
HTTP (Hyper Text Transfer Protocol)	Allows Web browsers to communicate with the Embedded Web Server.
EWS (Embedded Web Server)	Allows you to manage the product through a Web browser.
SNMP (Simple Network Management Protocol)	Used by network applications for product management. SNMP v1, SNMP v3, and standard MIB-II (Management Information Base) objects are supported.
LLMNR (Link Local Multicast Name Resolution)	Specifies if the product responds to LLMNR requests over IPv4 and IPv6.
TFTP Configuration	Allows you to use TFTP to download a configuration file containing additional configuration parameters, such as SNMP or non-default settings, for an HP Jetdirect card.

Table 4-3 IP addressing

Service name	Description
DHCP (Dynamic Host Configuration Protocol)	For automatic IPv4 and IPv6 address assignment. The DHCP server provides the product with an IP address. Generally, no user intervention is required for the product to obtain an IP address from a DHCP server.
BOOTP (Bootstrap Protocol)	For automatic IP address assignment. The BOOTP server provides the product with an IP address. Requires the administrator to input a product's MAC hardware address on the BOOTP server for the product to obtain an IP address from that server.
Auto IP	For automatic IP address assignment. If neither a DHCP server nor a BOOTP server is present, the product uses this service to generate a unique IP address.
Manual	For manual IP address assignment. Requires the administrator to manually assign a static IP address.

Table 4-4 Security features

Service name	Description
IPsec/Firewall	Provides network-layer security on IPv4 and IPv6 networks. A firewall provides simple control of IP traffic. IPsec provides additional protection through authentication and encryption protocols.
SNMP v3	Employs a user-based security model for SNMP v3, which provides user authentication and data privacy through encryption.
Access control list (ACL)	Specifies the individual host systems, or networks of host systems, that are allowed to access the server and the attached network product.
SSL/TLS	Allows you to transmit private documents via the Internet and guarantee privacy and data integrity between the client and server applications.
IPsec batch configuration	Provides network-layer security through the simple control of IP traffic to and from the product. This protocol provides the benefits of encryption and authentication and allows for multiple configurations.

Configure the product to use the network

View or change network settings

You can use the Embedded Web Server to view or change IP configuration settings.

1. Touch the **Network Address** button on the Home screen to locate the IP address.
 - If you are using IPv4, the IP address contains only digits. It has this format:
`xxx . xxx . xxx . xxx`
 - If you are using IPv6, the IP address is a hexadecimal combination of characters and digits. It has a format similar to this:
`xxxx : : xxxx : xxxx : xxxx : xxxx`
2. Type the IP address into the address line of a Web browser to open the Embedded Web Server.
3. Click the **Networking** tab to obtain network information. You can change settings as needed.

Set or change the administrator password

Use the Embedded Web Server to set an administrator password or change an existing password. When set, you must enter this password before you can access and change configuration settings.

1. Open the Embedded Web Server and click the **Networking** tab.
2. In the left-side pane, click the **Authorization** option.

 **NOTE:** If a password has previously been set, you are prompted to type the password. Type the password, and then click the **Apply** button.

3. Type the new password in the **Password** box and in the **Confirm Password** box.
4. At the bottom of the window, click the **Apply** button to save the password.

 **NOTE:** You can also set a local administrator password from the **General Security** option on the **Security** tab. When set, you must enter this password to change settings within the Embedded Web Server.

Manually configure IPv4 TCP/IP parameters from the control panel

In addition to using the Embedded Web Server, you can also use the control-panel menus to set an IPv4 address, subnet mask, and default gateway.

1. At the product control panel, touch the [Administration](#) button.
2. Touch the [Network Settings](#) menu to open it.
3. Touch the [Jetdirect Menu](#) option.
4. Touch the [TCP/IP](#) option.
5. Touch the [IPV4 Settings](#) option
6. Touch the [Config Method](#) option.
7. Touch the [Manual](#) option.
8. Touch the option you wish to manually set and follow the onscreen instructions to manually change the option setting.
9. Touch the [Save](#) button to save your changes.

Manually configure IPv6 TCP/IP parameters from the control panel

In addition to using the Embedded Web Server, you can also use the control-panel menus to set an IPv6 address.

1. At the product control panel, touch the [Administration](#) button.
2. Touch the [Network Settings](#) menu to open it.
3. Touch the [Jetdirect Menu](#) option.
4. Touch the [TCP/IP](#) option.
5. Touch the [IPV6 Settings](#) option.
6. Touch the [Address](#) option.
7. Touch the [Manual Settings](#) option.
8. Touch the [Enable](#) option.
9. Touch the [On](#) option, and then touch the [Save](#) button.
10. Touch the [Address](#) option, and then touch the data entry field.
11. Use the keyboard to enter the address, and then touch the [Save](#) button.

Disable network protocols (optional)

By factory default, all supported network protocols are enabled. Disabling unused protocols has the following benefits:

- Decreases product-generated network traffic
- Provides only pertinent information on the configuration page
- Allows the product control panel to display protocol-specific error and warning messages

Link speed and duplex settings

The link speed and communication mode of the product must match the network. For most situations, leave the product in automatic mode. Incorrect changes to the link speed and duplex settings might prevent the product from communicating with other network devices. If you need to make changes, use the product control panel.

 **NOTE:** Making changes to these settings causes the product to turn off and then on. Make changes only when the product is idle.

1. At the product control panel, touch the [Administration](#) button.
2. Touch the [Network Settings](#) menu to open it.
3. Touch the [Jetdirect Menu](#) option.
4. Touch the down arrow until the [Link Speed](#) option displays.
5. Touch the [Link Speed](#) option.
6. Touch one of the following options.

Setting	Description
Auto	The product automatically configures itself for the highest link speed and communication mode allowed on the network.
10T Half	10 megabytes per second (Mbps), half-duplex operation
10T Full	10 Mbps, full-duplex operation
100TX Half	100 Mbps, half-duplex operation
100TX Full	100 Mbps, full-duplex operation
100TX Auto	Limits auto-negotiation to a maximum link speed of 100 Mbps
1000T Full	1000 Mbps, full-duplex operation

7. Touch the [Save](#) button. The product turns off and then on.

Configure e-mail settings

The product offers color-scanning and digital-sending capabilities. By using the control panel, you can scan black-and-white or color documents and send them to an e-mail address as an e-mail attachment. To use digital sending, the product must be connected to a local area network (LAN).

Before you can send a document to e-mail, you must configure the product.

 **NOTE:** The instructions that follow are for configuring the product using the Embedded Web Server. You can also perform a limited set of configuration tasks using the control panel.

Supported protocols

The product supports Simple Mail Transfer Protocol (SMTP) and Lightweight Directory Access Protocol (LDAP).

SMTP

- SMTP is a set of rules that define the interaction between programs that send and receive e-mail. In order for the product to send documents to e-mail, it must be connected to a LAN that has access to an e-mail server that supports SMTP. The SMTP server must also have Internet access.
- If you are using a LAN connection, contact your system administrator to obtain the IP address or host name for your SMTP server. If you are connecting through a DSL or cable connection, contact the internet service provider to obtain the SMTP server IP address.

LDAP

- LDAP is used to gain access to a database of information. When the product uses LDAP, it searches a global list of e-mail addresses. As you begin to type the e-mail address, LDAP uses an auto-complete feature that supplies a list of e-mail addresses that match the characters you type. As you type additional characters, the list of matching e-mail addresses becomes smaller.
- The product supports LDAP, but a connection to an LDAP server is not required in order for the product to be able to send to e-mail.

 **NOTE:** If you need to change the LDAP settings, you must change them using the Embedded Web Server.

Configure e-mail options

1. Start the Embedded Web Server. In a supported Web browser on your computer, type the product IP address or host name in the address/URL field. To find the IP address or host name, touch the [Network Address](#) button on the Home screen.
2. Click the **Scan/Digital Send** tab.
3. In the left navigation pane, click the **E-mail Setup** entry.
4. Select **Enable Send to E-mail** and click **Add**, follow the SMTP wizard to complete the required fields and any additional fields you want, and then click the **Apply** button.



TIP: You must specify an outgoing SMTP server and complete the **From:** field. See the Embedded Web Server Help for more information.

5. To add addresses to the Address book, click the **Address Book** entry in the left navigation pane and then follow the onscreen instructions.

After you have configured the e-mail settings, send an e-mail to yourself by using the digital-send feature. If you receive the e-mail, you have successfully configured the digital-sending feature.

If you do not receive the e-mail, use these actions to resolve issues:

- Check the SMTP and address to make sure that you typed them correctly.
- View the configuration page. Verify that the SMTP gateway address is correct.
- Make sure that the network is operating correctly. Send an e-mail to yourself from a computer. If you receive the e-mail, the network is operating correctly. If you do not receive the e-mail, contact your network administrator or Internet service provider (ISP).

Configure other digital sending settings

Use the Embedded Web Server (EWS) to configure e-mail settings and additional features such as:

-
- E-mail
 - Digital fax
 - Save to network folder
 - Save to USB
 - Quick sets
 - Address books
 - Authentication for Windows, LDAP, and local access codes
-

When the product is connected to the network, the EWS is automatically available.

To start the EWS, open a web browser on a computer and type the IP address of the product. To find the IP address or host name, touch the [Network Address](#) button on the Home screen.

In addition to the features listed in this section, you can also set up workflows using third-party software or HP Digital Sending Software that is compatible with the product. For information about setting up these workflows and using them, see the documentation that came with these products.

Configure digital fax settings

1. Click the **Fax** tab.
2. On the left navigation menu, select the **Fax Send Setup** entry.
3. Select **Enable Fax Send** and then select either the **LAN Fax Service** or **Internet Fax Service** entry (depending on your network configuration).
4. Follow the onscreen instructions to complete the required fields, and then click the **Apply** button.
5. To add fax numbers to the [Speed Dial List](#), click the **Speed Dials** entry in the left navigation pane, click a speed dial code, click the **Edit** button, enter a speed dial name and fax number, click the **Add** button, verify that the displayed information is correct, and then click the **OK** button.

Save to Network Folder Setup

Before configuring network folders, set up shared folders following the instructions for your network operating system.

1. Click the **Scan/Digital Send** tab.
2. On the left navigation menu, click the **Save to Network Folder Setup** entry.
3. Select the **Enable Save to Network Folder** checkbox.
4. Set the default settings you want for all folders and then click the **Apply** button.
5. To specify network folders to which to save documents, click the **Add** button in the **Quick Sets** area and follow the onscreen instructions.

Configure USB storage device settings

1. Click the **Scan/Digital Send** tab.
2. On the left navigation menu, click the **Save to USB Setup** entry.

3. Select the **Enable Save to USB** checkbox.
4. Set the default settings you want.
5. Click the **Apply** button.

Configure quick sets

1. Click the **General** tab.
2. On the left navigation menu, click the **Quick Sets Setup** entry.
3. Click the **Add** button, and then follow the onscreen instructions in the Quick Set Wizard.
4. When you are done, click the **Apply** button.



TIP: You can also configure quick sets on other setup pages in the Embedded Web Server.

5 Load originals

- [Supported document sizes](#)
- [General document loading tips](#)
- [Document loading tips for mixed-size documents](#)
- [Load documents](#)













Supported document sizes

The maximum capacity of the document feeder is 50 sheets of 75 g/m² (20 lb) paper. When using heavier paper, the maximum capacity is decreased. The maximum capacity of the document feeder with card stock is 10 cards.

Paper Type	Width	Length	Weight (or Thickness)
Standard stock	52–216 mm (2.1–8.5 in)	74–864 mm (2.9–34 in)	50–120 g/m ² (13.3–32 lb)
Card stock	52–210 mm (2.1–8.3 in)	74–269 mm (2.9–10 in)	253–312 g/m ² (12–15 points)
Polyvinyl chloride or polyvinyl chloride acetate (for ID cards)	52 mm (2.1 in)	86 mm (3.4 in)	1.4 mm (0.056 in) or less

General document loading tips

- Scanning the following types of documents might result in paper jams or damage to the documents.

	Wrinkled or creased documents		Curled documents
	Torn documents		Documents with paper clips or staples
	Carbon paper		Coated paper
	Extremely thin, translucent paper		Paper with adhesive notes or flags attached
	Photos		Overhead transparencies
	Papers that are stuck together		Paper with wet substances such as glue or correction fluid

- When scanning multiple pages of the same width and length, set the page size to match the width and length of the paper that you are scanning.
- Smooth out any folds or curls in your documents before placing them into the feeder. A document with a curled or folded leading edge could cause a paper jam.
- For smaller documents (size A6 or smaller), extend the stop on the angled portion of the output tray to maintain stack order.
- When loading items that are smaller than 74 mm (2.9 in) one dimension (such as business cards), place the items with the long side parallel to the paper guides.
- To prevent skewed scans when scanning pages longer than 356 mm (14 in), scan them one at a time.
- To scan fragile documents (such as photos or documents on wrinkled or very lightweight paper), place the document in a clear, heavyweight document sleeve no wider than 216 mm (8.5 in) before loading it into the document feeder.

 **TIP:** If you do not have an appropriately-sized document sleeve, consider using a sleeve intended for use in a ring binder. Trim the ring-side edge so that the sleeve is no more than 216 mm (8.5 in) wide. When you scan, touch the [More Options](#) button and disable the [Misfeed Detection](#) feature.

- Verify that the hatch on the document feeder is latched securely. To properly close the hatch, press until you hear a click.
- Adjust the paper guides to the width of the documents. Make sure that the paper guides touch the edges of the original. If there is any clearance between the paper guides and the edges of the documents, the scanned image might be skewed.

- When placing a stack of documents into the feeder, gently set the stack in the document feeder. Do not drop the stack into the feeder and do not tap the top edge of the stack after placing the stack in the document feeder.
- Clean the scanning rollers if the rollers are visibly dirty or after scanning a document that has pencil writing on it.

Document loading tips for mixed-size documents

You can load the document feeder with groups of documents that have different widths or lengths. If your document contains different sized pages, you can scan it using the methods in this section.

- If your documents have the same width but different lengths (legal and letter size, for example), you can scan them as a single job. The scanned items will have the same length as the original items in the document.
 1. Touch the appropriate scan button and type the required information.
 2. Touch the [More Options](#) button and then touch the [Original Size](#) menu.
 3. Touch the [Mixed Letter/Legal](#) setting or the setting that matches the length of the longest item and then touch the [OK](#) button.
 4. Touch the Start button.
- If you want to prevent skewing and ensure that each scanned item has the same width and length as the original, use the [Job Build](#) feature. Each segment of the job build must have documents of the same width and length.
 1. Touch the appropriate scan button and type the required information.
 2. Touch the [More Options](#) button and then touch the [Job Build](#) menu.
 3. Touch the [Job Build On](#) setting and then touch the [OK](#) button.
 4. Insert the first segment into the document feeder and then touch the Start button. The scanner scans the segment and then prompts you to insert the next segment you want to scan.



NOTE: You can change the [Original Size](#) setting for each segment so that it matches the dimensions for that segment's documents.

Load documents

1. Pull up the document feeder extension and adjust the output tray. Ensure that the output tray does not extend beyond the surface on which the scanner sits.



2. Adjust the paper guides to the width of the documents. Take care not to overtighten the guides, which can restrict paper feeding.



When scanning small originals such as checks, it is especially important that the paper guides fit snugly against the edges of the original.

3. Fan the stack of document pages to ensure that the pages do not stick together. Fan the edge that will be pointing into the feeder in one direction, and then fan that same edge in the opposite direction.



4. Align the edges of the documents by tapping the bottom of the stack against the table top. Rotate the stack 90 degrees and repeat.

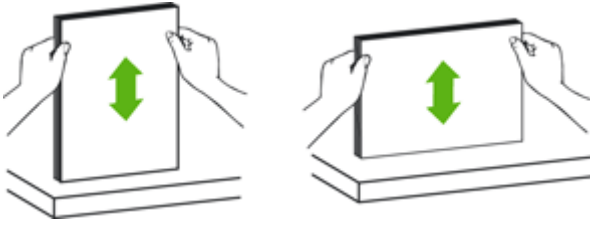

5. Gently set the stack in the document feeder. Load the pages face down with the top of the pages pointing into the feeder.

 **NOTE:** For best results, do not drop the stack into the feeder and do not tap the top edge of the stack after you have placed it in the document feeder.



6. Verify that the paper guides are aligned with the edges of the stack.

6 Scan and send documents

- [Sign In](#)
- [Preview a scan](#)
- [Send a scanned document to one or more e-mails](#)
- [Fax a scanned document](#)
- [Save to a network folder or USB storage device](#)
- [Send or save a document using Quick Sets](#)
- [Scan to a workflow destination](#)

Sign In

Depending on how your administrator has configured access privileges, you might need to sign in before using the product as well as when you access product features. The access your administrator has set for you might limit the features available to you.

1. Touch the **Sign In** button.
2. Complete the required fields, and then touch the **OK** button.

Preview a scan

Use the touch screen to navigate through the options on the Image Preview screen.



1	Home button	Touch this button to open the Home screen.
2	Start button	Touch this button to scan the document and send it to the specified destination.
3	Help button	Touch this button for control-panel help.
4	Cancel Job button	Touch this button to cancel your changes and return to previous screen.
5	Page control field	Type a number to view a page.
6	Zoom button	Touch this button to view the preview magnified.
7	View button	Touch this button to switch between single and multi-page views and to access more options.
8	Append Pages button	Touch this button to append a newly scanned document to the end of the document in the preview.
9	Move Pages button	Touch this button to move a selected page or pages.
10	Rotate Pages button	Touch this button to rotate the scan clockwise in increments of 90 degrees.
11	Delete Pages button	Touch this button to delete a selected page or pages.

Use the Image Preview screen

You can preview a document and adjust certain document job options before sending the scan. The Image Preview screen is available for all scan destinations, but not all document job options are available for all scan destinations.

1. From a scan screen, touch the [Preview](#) button.
2. To increase the magnification for viewing purposes only, touch the Zoom button. Touch it again to return to the original magnification. To view parts of the zoomed page that might be off the screen, place your finger on the image and drag.

3. To see a multi-page view of the scanned document and move, append, delete, or rotate pages, touch the View button.
4. When you are done making changes, touch the Start button to save your changes and send the scan or the [Cancel Job](#) button to cancel your changes and return to the previous screen.

Append pages

1. From the Image Preview screen, touch the View button.
2. Touch the Append Pages button.
3. In the [Append New Pages](#) dialog box, select one- or two-sided, and then touch the [Scan](#) button. The pages are appended to the end of the document.

Move pages

1. From the Image Preview screen, touch the View button.
2. Touch the pages you want to move. To deselect a page, touch it again. To select contiguous pages, touch the first and last pages of the group you want.
3. Touch the Move Pages button.
4. Touch the Insert icon where you want to move the pages.

Rotate pages

1. From the Image Preview screen, touch the View button.
2. Touch the pages you want to rotate. To deselect a page, touch it again. To select contiguous pages, touch the first and last pages of the group you want.
3. Touch the Rotate Pages button. The page rotates clockwise in 90-degree increments with each touch.

Delete pages

1. From the Image Preview screen, touch the View button.
2. Touch the pages you want to delete. To deselect a page, touch it again.
3. Touch the Delete Pages button.

Send a scanned document to one or more e-mails

The e-mail feature offers the following benefits:

- Sends documents to multiple e-mail addresses, saving time and delivery costs.
- Delivers files in black-and-white or in color. Files can be sent in different file formats that the recipient can manipulate.

In order to use the e-mail feature, the product needs to be connected to a valid SMTP local area network that includes Internet access.

Use the address book

You can send e-mail to a list of recipients using the address book feature. See your system administrator for information about configuring address lists.



NOTE: You can also use the Embedded Web Server (EWS) to create and manage the address book. The EWS address book can be used to add, edit, or delete single addresses or distribution lists.

Create a recipient list

1. From the Home screen, touch the [E-mail](#) button.
2. Touch the [To:](#) field and then type the recipients' e-mail addresses. Separate multiple entries with a semicolon or by pressing enter on the keyboard.



TIP: You can also use the address book to enter e-mail addresses. For more information, see the built-in Help.

3. The names in the recipient list are placed in the text line of the keyboard screen. To add a recipient that is not found in the address book, type the e-mail address.
4. Touch the [OK](#) button.
5. Finish typing information in the [cc:](#), [bcc:](#), [Subject:](#), and [Message:](#) fields on the [Send E-mail](#) screen, if necessary. To check the list of recipients, touch the down arrow in the [To:](#) text line.
6. Touch the Start button.

Use the Personal or Shared Contacts address book

Use the Personal or Shared Contacts address book to store frequently-used e-mail addresses and to insert them into the [From:](#), [To:](#), [cc:](#), or [bcc:](#) fields.

To open an address book, touch the Address Book button , and then select the appropriate contact entry.

Add entries to the Personal or Shared Contacts address books

1. Touch the add button **+**.
2. Touch the **Name** field, and type a name for the new entry.
The name is the alias for the entry.
3. Type the e-mail address for the new entry, complete any additional optional fields, and then touch the **OK** button.

Delete entries from the Personal Contacts address book

You can delete entries that you no longer use.

 **NOTE:** To change an entry, highlight the text you want to change, and then type the new text.

1. Touch the entry that you want to delete from the Personal Contacts address book.
2. Touch the remove button  in the lower right corner.
3. In the confirmation dialog box that appears, touch the **Delete** button to delete the entry or touch the **Cancel** button to return to the Address Book screen.

Use the Send E-mail screen

Use the touch screen to navigate through the options on the **E-mail** screen.

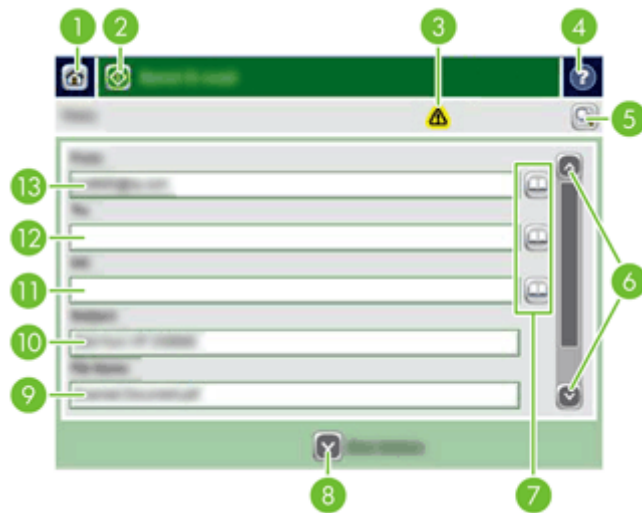

1	Home button	Touch this button to open the Home screen.
2	Send E-mail button	Touch this button to scan the document and send an e-mail file to the specified e-mail addresses.
3	Error/warning button	This button appears only when there is an error or warning in the status line area. Touch it to open a pop-up screen that will help you resolve the error or warning.
4	Help button	Touch this button for control-panel help.
5	Preview button	Touch this button to display a preview that you can modify before sending the scanned document.

6	Scroll bar	Use the Scroll bar to view and set up the cc: , bcc: , Message: , and File Name: fields. Touch any of those fields and add the necessary information.
7	Address book buttons	Touch these buttons to use the address book to populate the To: , cc: , or bcc: fields.
8	More Options button	Touch this button to change certain e-mail settings for the current scan job.
9	File Name: field	Touch this field and then type the name of the scanned document.
10	Subject: field	Touch this field and then type a subject title.
11	cc: field	Touch this field and then type the e-mail addresses of those secondary individuals whom you want to receive the scanned document.
12	To: field	Touch this field and then type the e-mail addresses of those primary individuals whom you want to receive the scanned document.
13	From: field	Touch this field and then type your e-mail address. If the system administrator has configured the product to do so, this field might automatically insert a default address.

Send documents

The product scans both black-and-white and color originals. You can use default settings or change the scanning preferences and file formats.

Send a document

1. Place the document face down in the document feeder.
2. From the Home screen, touch the **E-mail** button.
3. If prompted, type your user name and password.
4. Complete the **From:** and **To:** fields. Scroll down and complete the **cc:**, **bcc:**, and **Message:** fields if appropriate. Your user name or other default information might appear in the **From:** field. If so, you might not be able to change it.
5. (Optional) Touch the **More Options** button to change the settings for the document that you are sending (for example, the document's original size). If you are sending a two-sided document, you should select **Sides** and an option with a two-sided original. For information about other available features, see the built-in Help.
6. Touch the Start button to begin sending.
7. When you are finished, remove the original document from the output tray.

Use the auto-complete function

When you type characters into the **To:**, **cc:**, or **From:** fields on the **Send E-mail** screen, the auto-complete function is activated. As you type the required address or name, the product automatically searches the address book list and completes the address or name by using the first match. You can then select that name by pressing enter on the keyboard, or continue typing the name until auto-complete finds the correct entry. If you type a character that does not match any entry in the list, the auto-complete text is removed from the display to indicate that you are typing an address that is not in the address book.

Fax a scanned document

Use the Send Fax screen

Use the touch screen to navigate through the options on the [Send Fax](#) screen.

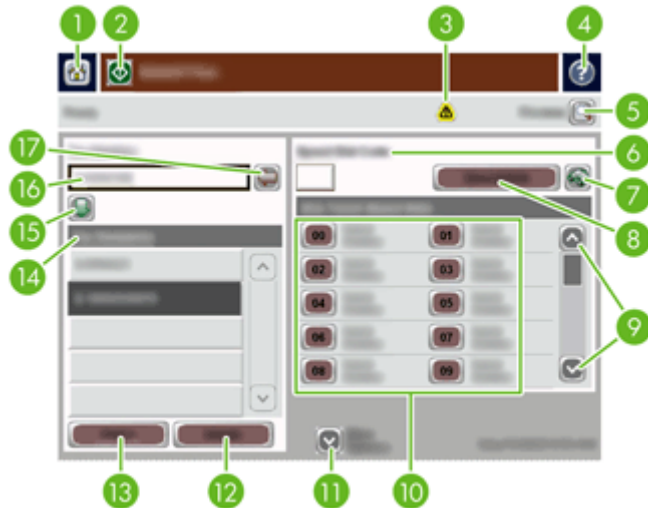

1	Home button	Touch this button to open the Home screen.
2	Send Fax button	Touch this button to scan the document and send a fax to the provided fax numbers.
3	Error/warning button	This button appears only when there is an error or warning in the status line area. Touch it to open a pop-up screen that will help you resolve the error or warning.
4	Help button	Touch this button for control-panel Help.
5	Preview button	Touch this button to display a preview that you can modify before faxing the scanned document.
6	Speed Dial Code field	Touch this button to type a speed dial code directly.
7	Search button	Touch this button to search for a speed dial code by name.
8	Speed Dials button	Touch this button to edit the speed dial.
9	Scroll bars	Use the scroll bar to view more entries.
10	One Touch Speed Dials list	Touch a button in this area to add the fax number to the Fax Recipients list.
11	More Options button	Touch this button to change certain fax settings for the current scan job.
12	Details button	Touch this button to display more information about the fax number highlighted in the Fax Recipients list.
13	Delete button	Touch this button to remove the highlighted fax number from the Fax Recipients list.
14	Fax Recipients list	Lists the numbers you have selected to receive the scanned document.
15	Add fax number button	Touch this button to add the fax number in the Fax Number : field to the Fax Recipients list.
16	Fax Number : field	Touch this field and then type a fax number.
17	Delete character button	Touch this button to backspace and delete numbers in the Fax Number : field.

Send a fax

1. Place the original document face down in the document feeder.
2. From the Home screen, touch the [Fax](#) button.
3. If prompted, type your user name and password.
4. Specify the fax numbers by using one or both of these methods:

Use the [Fax Number](#) field Type the fax number.

(Optional) Type additional fax numbers separated by semi-colons.

Use a speed dial From the [Send Fax](#) screen, touch the code in the [One Touch Speed Dials](#) list.

5. (Optional) Touch the [More Options](#) button to change the settings for the document that you are sending. For information about available features, see the built-in Help.
6. Touch the Start button to begin sending.

Save to a network folder or USB storage device

If the system administrator has made the feature available, the product can scan a file and save it to either a USB storage device or a network folder. Supported operating systems for folder destinations include Windows 2000, Windows XP, Windows Server 2003, and Windows Server 2008.

1. Place the document face down in the document feeder.
2. If you are saving to a USB storage device, insert it into the USB connector next to the control panel.
3. On the Home screen, touch either the [Save to Network Folder](#) or the [Save to USB](#) button.
4. In the folders list, touch the folder in which you want to save the document.
5. Select a quick set or touch the [File Name:](#) field, and then type the name of the file.
6. Touch the [More Options](#) button to change the settings for the document you are sending.
7. Touch the Start button.



NOTE: The additional options are the same as the e-mail options.

Send or save a document using Quick Sets

If the system administrator has made the feature available, the product can scan a file using preset settings for fax numbers, e-mail recipients, network folders, or USB storage devices.

Depending on how your administrator has configured [Quick Sets](#), you can also touch the [Quick Sets](#) button on the Home screen to display a list of available [Quick Sets](#).

1. Place the original document face down in the document feeder.
2. From the Home screen, touch a [Quick Sets](#) button. Those [Quick Sets](#) buttons that have a small Start icon on them start scanning when you touch them.
3. If prompted, type your user name and password.
4. If a screen for sending the scanned document to e-mail, fax, or a network folder displays, complete the fields, and then touch the Start button.

Scan to a workflow destination



NOTE: This product feature is provided by the optional Digital Sending Software.

If the system administrator has enabled the workflow functionality, you can scan a document and send it to a custom workflow destination. A workflow destination gives you the ability to send additional information, along with the scanned document, to a specified network or file transfer protocol (FTP) location. Prompts for specific information appear on the control-panel display. The system administrator can also designate a printer as a workflow destination, which allows you to scan a document and then send it directly to a network printer for printing.

1. Place the document face down in the document feeder.
2. From the Home screen, touch a workflow button.
3. Complete the fields. The fields vary based on how your administrator has configured the workflow.
4. Touch the Start button.

7 Manage and maintain the product

This section presents information about how to care for and maintain the product.

- [Use information pages](#)
- [Embedded Web Server](#)
- [Use HP Web Jetadmin software](#)
- [Controlling digital-sending security](#)
- [Security features](#)
- [Test and calibrate the touch screen](#)
- [Install the hardware integration pocket](#)
- [Clean the product](#)
- [Order maintenance and scanning supplies](#)
- [Replace supplies and parts](#)

Occasional cleaning of the product helps ensure high-quality scans. The amount of care necessary depends upon several factors, including the amount of use and the environment. You should perform routine cleaning as necessary.

 **CAUTION:** Before placing an item in the document feeder, make sure that the item does not contain wet glue, correction fluid, or other substances that can be transferred to the interior of the product.

Make sure there are no curls, wrinkles, staples, paper clips, or any other attached material. Sheets should not be stuck together.

Use information pages

From the Home screen, touch the [Administration](#) button and then touch the [Information](#) option to view pages that give details about the device and its current configuration and status.

- [Configuration/Status Pages](#)
 - [Administration Menu Map](#)
 - [Device Configuration Page](#)
 - [Embedded Jetdirect Page](#)
 - [Embedded Protocol Page](#)
 - [Usage Page](#)
- [Fax Reports](#)
 - [Speed Dial List](#)

Embedded Web Server

When the HP Scanjet Enterprise 7000n is connected to a network, you can use the Embedded Web Server to view status information, change settings, and manage the product from your computer.

To use the Embedded Web Server, you must have Microsoft Internet Explorer 5.01 or later or Netscape 6.2 or later for Windows, Mac OS, and Linux (Netscape only). Netscape Navigator 4.7 is required for HP-UX 10 and HP-UX 11.

The Embedded Web Server works when the product is connected to an IP-based network. You do not have to have Internet access to open and use the Embedded Web Server.

When the product is connected to the network, the Embedded Web Server is automatically available.

 **NOTE:** Some Embedded Web Server options are only available to the network administrator, and some settings might require a password.

You can use the Embedded Web Server without being connected to the Internet; however, some features will not be available.

- [Open the Embedded Web Server](#)
- [Embedded Web Server options](#)

Open the Embedded Web Server

1. In a supported Web browser on your computer, type the product IP address or host name in the address/URL field. To find the IP address or host name, touch the [Network Address](#) button on the Home screen.

 **NOTE:** After you open the URL, you can bookmark it so that you can return to it quickly in the future.

2. The Embedded Web Server has seven tabs that contain settings and information about the product: **Information**, **General**, **Scan/Digital Send**, **Fax**, **Troubleshooting**, **Security**, and **Networking**. Click the tab that you want to view.

Embedded Web Server options

The following table describes the types of information you can obtain or tasks you can perform using the Embedded Web Server tabs. The options that appear on each tab can change when you upgrade firmware, so refer to the Embedded Web Server Help for detailed information about tabs and their options.

 **NOTE:** Each tab also provides links to the **HP Instant Support** and **Product Support** websites.

Tab	Options
Information	The Information tab provides access to information about the product's operational status, configuration settings, event logs, and usage statistics.
General	The General tab provides access to the control panel Administration menu. Options on this tab also allow you to sign up to receive e-mail alerts and configuration and supplies usage information, record device information, set language and date and time options, and more. NOTE: The General tab can be password-protected. If this product is on a network, always consult with the system administrator before changing settings on this tab.

Tab	Options
Scan/Digital Send	<p>The Scan/Digital Send tab allows you to set up and configure e-mail, save-to-USB, save-to-network-folder, and digital-sending-software options, populate an address book, and connect to workflow services.</p> <p>NOTE: If the product is configured to use the optional HP Digital Sending Software, the options on these tabs are not available. Instead, all digital-sending configuration is performed by using the HP Digital Sending Software.</p>
Fax	<p>The Fax tab allows you to set up and configure fax sending and speed dial options.</p>
Troubleshooting	<p>The Troubleshooting tab allows you access device reports and logs, locate and install new firmware, and restore device settings to factory defaults.</p> <p>NOTE: Upgrading firmware requires that an administrator password be set in the General Security area of the Security tab.</p>
Security	<p>The Security tab allows you to configure general security, access control, and stored data protection options, as well as to manage certificates.</p>
Networking	<p>The Networking tab allows you to change network settings from your computer when both the product and your computer are connected to an IP-based network.</p> <p>NOTE: The Networking tab can be password-protected.</p>

Use HP Web Jetadmin software

HP Web Jetadmin is a Web-based software solution for remotely installing, monitoring, and troubleshooting network-connected peripherals. Management is proactive, allowing network administrators the ability to resolve issues before users are affected. Download this free, enhanced-management software at www.hp.com/go/webjetadmin.

Plug-ins can be installed into HP Web Jetadmin to provide support for specific product features. The HP Web Jetadmin software can automatically notify you when new plug-ins are available. On the **Product Update** page, follow the directions to automatically connect to the HP Web site and install the latest device plug-ins for your product.



NOTE: Browsers must be Java™-enabled.

Controlling digital-sending security

The product has been designed with security in mind. It includes a variety of features that work to protect the security of the digital-sending process.

Network authentication

The product's most basic security feature is its ability to require a network login before a user can use the digital-sending functions. This prevents unauthorized users from walking up to the product and sending documents. Additionally, the product supports several authentication methods that offer a high level of encryption and security.

Secure e-mail

A number of third-party software vendors offer services for secure e-mail delivery. The [Secondary e-mail](#) feature is designed to work with one of these third-party software programs for users that require an extra measure of data security.

Restrict software access

In order to keep the product secure, you must also restrict access to the software programs that can be used to configure the product.

You can also set a local administrator password using the **General Security** option on the **Security** tab in the Embedded Web Server (EWS) to prevent access to the device-settings tabs. After the password has been set, users can only see the EWS **Information** tab.

Security features

The following security features are available on this product.

- [Secure the Embedded Web Server](#)
- [Manage temporary job files](#)
- [Secure Storage Erase](#)
- [Secure File Erase](#)
- [Secure Disk Erase](#)
- [HP High-Performance Secure Hard Disks](#)
- [Manage certificates](#)
- [Authentication and authorization](#)

Secure the Embedded Web Server

Assign a password for access to the Embedded Web Server so that unauthorized users cannot change the product settings.

1. Open the Embedded Web Server.
2. Click the **Security** tab.
3. On the left side of the window, click the **General Security** link.
4. Type the password in the **New Password** box, and type it again in the **Verify Password** box.
5. Click the **Apply** button. Make note of the password and store it in a safe place.

Manage temporary job files

To specify how your product manages temporary job files that are created when scans are initiated, follow these steps.

1. In the Embedded Web Server, click the **Security** tab, and then click the **Protect Stored Data** link.
2. Under **Managing Temporary Job Files**, select a file erase mode.
 - **Non-Secure Fast Erase.** This is a simple file-table erase function. Access to the file is removed, but actual data is retained on the disk until it is overwritten by subsequent data-storage operations. This is the fastest mode. Non-Secure Fast Erase is the default erase mode.
 - **Secure Fast Erase.** Access to the file is removed, and the data is overwritten with a fixed identical character pattern. This is slower than Non-Secure Fast Erase, but all data is overwritten. Secure Fast Erase meets the U.S. Department of Defense 5220-22.M requirements for the clearing of disk media.
 - **Secure Sanitize Erase.** This level is similar to the Secure Fast Erase mode. In addition, data is repetitively overwritten by using an algorithm that prevents any residual data persistence. This mode will impact performance. Secure Sanitize Erase meets standards for clearing disk media defined in NIST Special Publication 800-88 Guidelines for Media

Sanitation and the U.S. Department of Defense Updated DSS Clearing and Sanitization Matrix.

3. Click **Apply**.

Secure Storage Erase

Use the **Secure Storage Erase** option in the Embedded Web Server to protect deleted data from unauthorized access on the product hard drive. The **Secure Storage Erase** option provides two secure erase types, both of which meet the U.S. NIST Special Publication 800–88 guidelines for media sanitization.

1. In the Embedded Web Server, click the **Security** tab, click the **Protect Stored Data** option, and then click the **Erase Options** button.
2. Select a storage erase option.
 - **Secure Fast Erase**. Access to the file is removed, and the data is overwritten one time with a fixed identical character pattern.
 - **Secure Sanitize Erase**. This level is similar to **Secure Fast Erase** but data is overwritten three times. This will impact performance.
3. Click the **Erase** button.

Data affected

Data affected (covered) by the **Secure Storage Erase** feature includes stored fax files, address books, and HP and third-party application data.

This feature will not impact data that is stored on flash-based product non-volatile RAM (NVRAM) that is used to store default settings, page counts, and similar data. This feature does not affect data that is stored on a system RAM disk (if one is used). This feature does not impact data that is stored on the flash-based system boot RAM.

Secure File Erase

Changing the **Secure File Erase** mode does not overwrite previous data on the disk, nor does it immediately perform a full-disk sanitization. Changing the **Secure File Erase** mode changes how the product cleans up temporary data for jobs after the erase mode has been changed.

Secure Disk Erase

Secure Disk Erase permanently erases all the data on the hard drive. If you have an encrypted hard drive, this function also unlocks the encrypted hard drive, thereby allowing the drive to be read by any device.

 **WARNING!** Only use this option at product end-of-life. Since **Secure Disk Erase** permanently erases all data, the device will not boot up.

You can access the **Secure Disk Erase** feature from the product's Administrative Tools option on the Boot menu. To access the Boot menu, press the Power button to turn off the product, press and hold the Escape key on the keyboard, and then press the Power button to turn on the product while continuing to hold the Escape key until the Boot menu displays.

HP High-Performance Secure Hard Disks

This product supports an encrypted hard disk that might be installed in the EIO slot, on the formatter board, or in both locations. The only encrypted hard disk that is supported is the disk that comes bundled with the product. Encrypted hard disks provide hardware-based encryption so you can securely store sensitive scan data without impacting product performance. Encrypted hard disks use the latest Advanced Encryption Standard (AES) and have versatile time-saving features and robust functionality.

Manage certificates

The product has a built-in self-signed certificate, which allows for encryption and a reasonable level of trust for network communications with entities such as the LDAP server (communication that can include user names and passwords). However, some networks require trusted certificates. In these cases, you might be required to install a certificate from the network certificate authority.

The certificate manager also allows you to load certificate revocation lists (CRL).

Load a certificate

1. From a Web browser, open the Embedded Web Server by typing the IP address of the product.
2. On the main Embedded Web Server page, click the **Security** tab, and then select the **Certificate Management** entry.

 **NOTE:** If the **Certificate Management** page is unavailable, update the product firmware.

3. Under **Install Certificate**, click **Browse...** to locate the certificate you want to load.

 **NOTE:** Find certificates at the location where a network administrator created them. If the certificate you select is password-protected, you will need to enter the certificate password.

4. Click **Import** to import the certificate. The certificate will appear in the certificates list after it is loaded.

Load a certificate revocation list (CRL)

1. From a Web browser, open the Embedded Web Server by typing the IP address of the product.
2. On the main EWS page, click the **Security** entry, and then select the **Certificate Management** entry.

 **NOTE:** If the Certificate Management page is unavailable, update the product firmware.

3. Under **Install Certificate**, click **Browse...** to locate the CRL to load.
4. Click **Import** to import the CRL. The CRL will appear in the certificate revocation list after it is loaded.

Authentication and authorization

You can secure access to various parts of the control panel menu by establishing passwords. These passwords can be created to be local to the product, or can be obtained from the network by configuring Windows or LDAP server information.

To configure these settings using the Embedded Web Server, follow these steps.

1. In the Embedded Web Server, click the **Security** tab, and then click the **Access Control** link.
2. Configure access control options.
 - **Enable and Configure Sign In Methods.** This section allows the administrator to configure the Windows or LDAP network settings. The product uses these settings to obtain user information from the server.
 - **Sign In and Permission Policies.** This section allows the administrator to manage product permissions. By default, the product will support Guest, Administrator, and User permission sets. The administrator can add permission sets, and can configure which sign-in method to use on control panel applications.
 - **Relationships Between Network Users or Groups and Device Permissions.** This section allows the administrator to select the default permission set for Windows and LDAP sign-in methods.
 - **Device User Accounts.** This section allows the administrator to establish user access codes.

Test and calibrate the touch screen

If touch screen touches are yielding unexpected (or no) results, you may need to calibrate the touch screen. To verify that calibration is necessary, you should first test the touch screen.

Test the touch screen

To test the touch screen, follow these steps:

1. At the product control panel, touch the [Service](#) button, touch the [Menu](#) button, touch the [Troubleshooting](#) button, and then touch the [Control Panel](#) button.
2. Touch the [Test Touchscreen](#) button, and then touch the [Start](#) button to enter service mode and start the test.
3. Touch each black square within the area where the touch screen may not be responding correctly to ensure the touch registers.
 - The black square turns white if the touch registers.
 - If a different square than the one touched turns white, or if the touch does not register (no black square turns white), you may need to calibrate the touch screen.
4. To end the touch screen test, press the [Stop](#) button on the control panel.
5. Touch the Back button  to exit service mode and return to the [Control Panel](#) menu.

Calibrate the touch screen

To calibrate the touch screen, follow these steps:

1. At the product control panel, touch the [Service](#) button, touch the [Menu](#) button, touch the [Troubleshooting](#) button, and then touch the [Control Panel](#) button.
2. Touch the [Calibrate Touchscreen](#) button to enter service mode.
3. Touch the [Start](#) button to begin touch screen calibration.

Targets will appear on the touch screen starting in the upper left corner and proceeding to the bottom left corner, bottom right corner, upper right corner, and center.
4. Touch the center of the first target and then release; the next target appears.
5. Touch-and-release each target as it appears.
6. After touching-and-releasing the final (center) target, press the [esc](#) key on the keyboard to exit the calibration screen.
7. Touch the Back button  to exit service mode and return to the [Control Panel](#) menu.

Install the hardware integration pocket

Use the included hardware integration pocket (packaged with the output tray) with a separately-purchaseable HP accessory such as a secure card reader to provide secure access to your product.

To install the hardware integration pocket, follow these steps.

1. Open the hatch.
2. Using a T-8 Torx screwdriver (not included), turn the hardware integration pocket panel retaining screw counterclockwise to loosen and remove the screw, rotate the panel up and toward you as shown, and then remove the panel.



3. Gently pull the hardware integration pocket connector up and out of its recessed location.

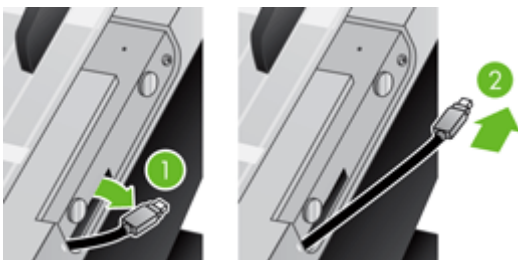

4. Using a credit card, gently pry up one edge of the hardware integration pocket insert, and then remove the insert.

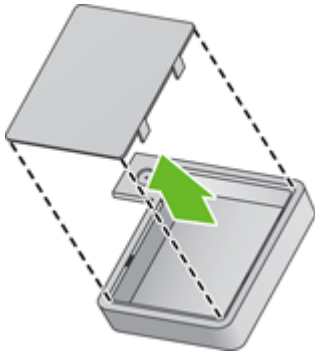

5. Carefully thread the hardware integration pocket connector through the opening in the left side of the pocket.



6. Install the hardware integration pocket on the product as shown by rotating the pocket into place, and then secure the pocket with the screw you removed in Step 2.

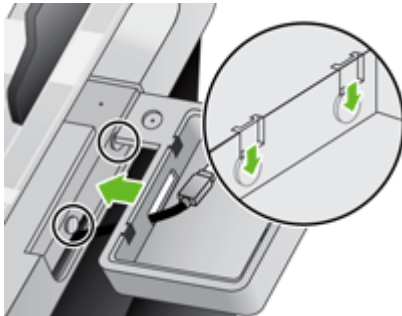

7. Follow the installation instructions that came with the HP accessory, ensuring that you place the accessory cable such that you can fit the accessory on top of the hardware integration pocket.

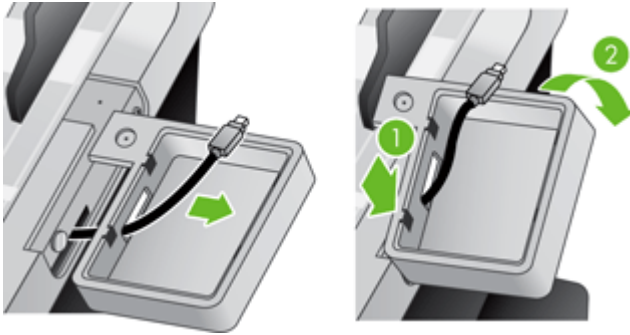

Clean the product

Cleaning product components helps keep your product in optimal working order.

- [Clean the touch screen](#)
- [Clean the product glass](#)
- [Clean the paper path](#)
- [Clean the rollers](#)

Clean the touch screen

Clean the touch screen whenever it is necessary to remove fingerprints or dust. Wipe the touch screen gently with a clean, water-dampened, lint-free cloth.

⚠ CAUTION: Use water only. Solvents or cleaners can damage the touch screen. Do not pour or spray water directly onto the touch screen.

Clean the product glass

Both strips of glass in the product should be cleaned periodically, or any time a scanned image has streaks. The two small strips of gray reflective material should be lightly dusted if debris is present.

💡 TIP: Before cleaning the product glass, press the Power button to turn off the product and allow 10 minutes for the glass to cool.

To clean the strips of glass, follow these steps:

1. Press the Power button to turn off the product.
2. Open the hatch.
3. Clean the glass using a soft, lint-free cloth that has been sprayed with a mild glass cleaner.

⚠ CAUTION: Use only glass cleaner to clean the glass. Avoid cleaners that contain abrasives, acetone, benzene, and carbon tetrachloride, all of which can damage the glass. Avoid isopropyl alcohol because it can leave streaks on the glass.

Do not spray the glass cleaner directly on the glass. If too much glass cleaner is applied, the cleaner could leak under the glass and damage the product.

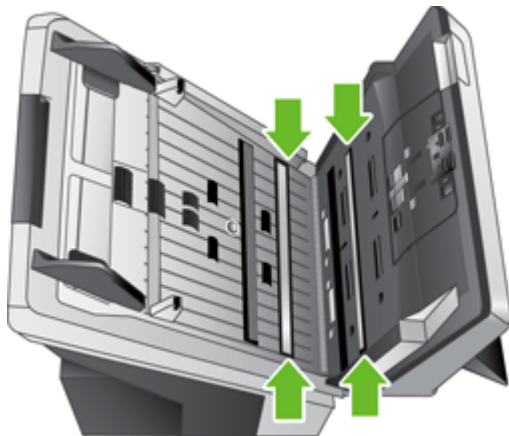

4. Dry the glass with a dry, soft, lint-free cloth.
5. With a light touch, dust the two small strips of gray reflective material with a dry, soft, lint-free cloth.
6. Close the hatch, and then press the Power button.

Clean the paper path

If scanned images have streaks or scratches, use the HP paper-path cleaning cloth to clean the paper path.

 **NOTE:** If you experience repeated document jams, make sure all rollers are present and that the roller cover is closed. If problems persist, clean the rollers.

To clean the paper path, follow these steps:

1. Open the sealed HP paper-path cleaning cloth container, starting at the notch. Take care not to tear the cleaning cloth.
2. Remove the cleaning cloth and unfold it.
3. Place the unfolded cloth into the document feeder.



4. Touch the [Service](#) button on the Home screen, touch the [Maintenance](#) button, touch the [Clean Paper Path](#) button, and then follow the onscreen instructions to clean the paper path.

 **NOTE:** Scroll down through the online maintenance procedure and touch the [Start Cleaning](#) button to feed the cleaning cloth through the paper path.

5. Place up to five pages of printed paper in the document feeder. Scan and view the results.
6. If streaks still appear, repeat steps 3 through 5. The cleaning cloth can be cycled through the product up to five times within 30 minutes. After that, the cloth will dry out.

If repeated cycling of the cleaning cloth does not remove the streaks from the scanned images, clean the rollers.

Clean the rollers

Proper maintenance will prolong the life of the rollers and improve their performance.

 **TIP:** HP recommends cleaning rollers every 10,000 pages, though you may want to clean the rollers more frequently if you scan pages that are dusty or have pencil lead or ink marks that could transfer to the rollers.

Clean the rollers under the following conditions:

- The maintenance utility indicates that cleaning is needed.
- If the multipick detector has signalled multiple failures.
- If you experience repeated document jams.

To clean the rollers, follow these steps:

1. Press the Power button to turn off the product.
2. Open the hatch.
3. Open the roller cover on the inside of the hatch and lift the roller up.

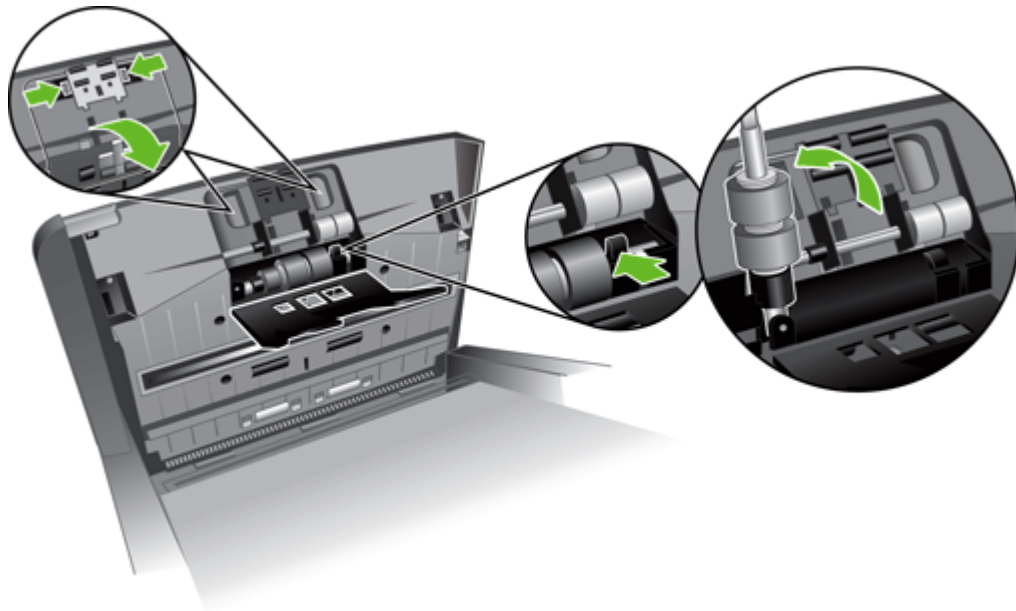

4. Remove any visible lint or dust from the roller and its housing using either compressed air or a clean lint-free cloth moistened with isopropyl alcohol.

5. Reinsert the roller into the housing.

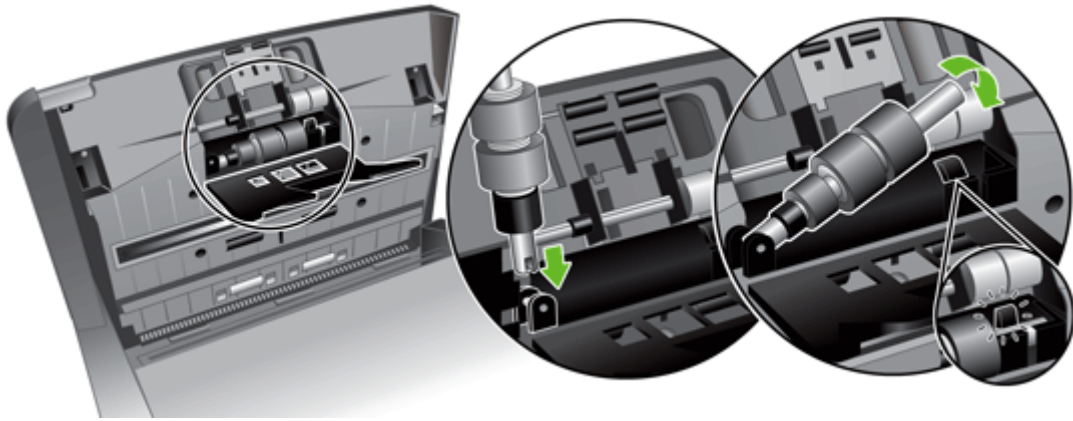

6. Open the door on the inside of the product, open the roller covers, and then remove the rollers.

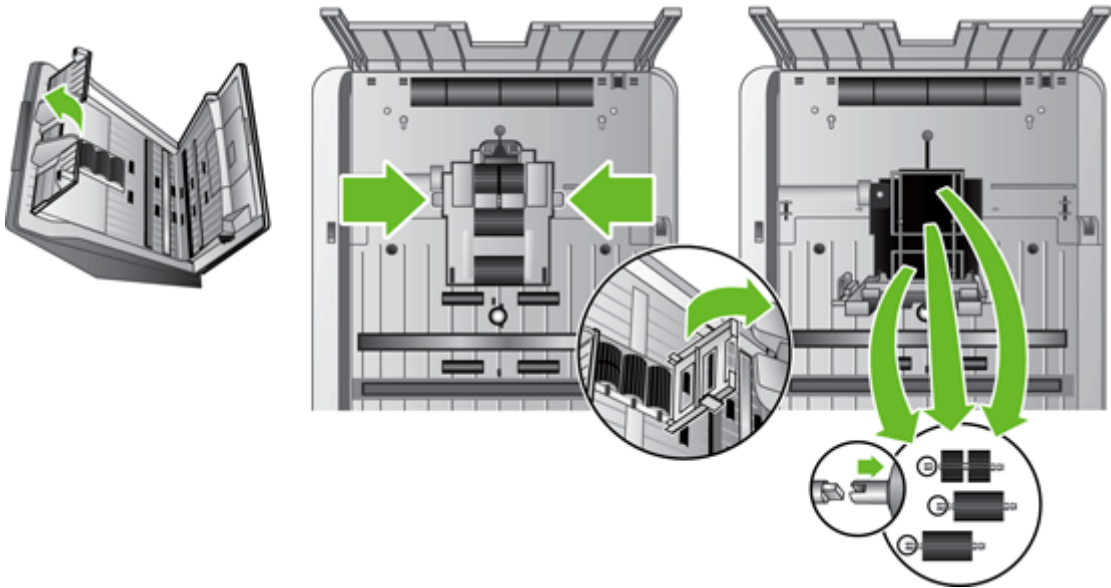

7. Remove any visible lint or dust from the rollers and their housing using either compressed air or a clean lint-free cloth moistened with isopropyl alcohol.
8. Reinsert the rollers into the housing. Rotate the rollers as you slide them to the left to match up the notches on the roller axle and axle holder. Close the roller cover door and then close the door on the inside of the product.

9. Clean the non-removable rollers using either compressed air or a clean lint-free cloth moistened with isopropyl alcohol.



10. Close the hatch.
11. Press the Power button to turn on the product.
12. Update the product maintenance history.
 - a. Touch the [Service](#) button on the Home screen, and then touch the [Maintenance](#) button.
 - b. Touch the [Clean Rollers](#) button.
 - c. Scroll down through the online maintenance procedure and touch the [Complete Maintenance Procedure](#) button.
 - d. Touch [OK](#) to record the maintenance activity and reset the counters to zero.

Order maintenance and scanning supplies

You can purchase maintenance parts for your product. HP recommends that you purchase rollers and cleaning cloths before the existing consumables reach their service life.

1. See the HP parts Web site at www.hp.com/buy/parts.
2. Select your language, and then click the arrow.

Replace supplies and parts

- [Replace the rollers](#)
- [Replace the keyboard](#)
- [Replace the Jetdirect card](#)
- [Replace the hard drive](#)
- [Upgrade the firmware](#)

Replace the rollers

Replace the rollers under the following conditions:

- When the [Service](#) menu indicates they are due for maintenance.
- If you experience repeated document jams and cleaning the rollers did not help.

The roller replacement kit contains rollers and installation instructions. To order the replacement kit, go to www.hp.com/support.



NOTE: The roller replacement kit is a consumable and is not covered under warranty or standard service agreements.

To replace the rollers, follow these steps:

1. Press the Power button to turn off the product.
2. Replace the rollers as described in the installation instructions that were included with the replacement kit.
3. Close the hatch, and then press the Power button to turn on the product.
4. Update the product maintenance history:
 - a. Touch the [Service](#) button on the Home screen, and then touch the [Maintenance](#) button.
 - b. Touch the [Replace Rollers](#) button.
 - c. Scroll down through the online maintenance procedure and touch the [Complete Maintenance Procedure](#) button.
 - d. Touch [OK](#) to record the maintenance activity and reset the counters to zero.



NOTE: HP recommends that you replace the rollers every 100,000 scans.

Replace the keyboard

You can order keyboards in several languages as accessories. Follow the instructions in the keyboard kit to replace the keyboard.

Replace the Jetdirect card

To replace the Jetdirect card, follow these steps.

1. Press the Power button to turn off the product (1), press the Power switch on the back of the product to the off position (2), disconnect power from the product (3), and then disconnect the Ethernet cable (4).

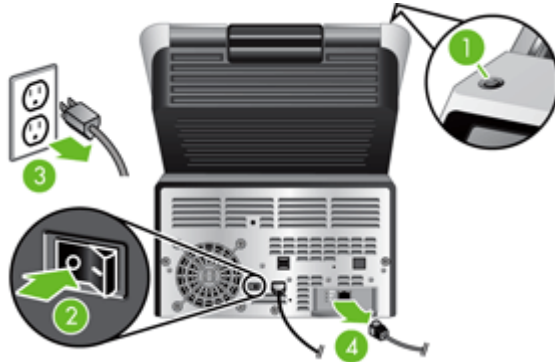

2. Loosen the two thumbscrews which secure the Jetdirect card cover plate to the back of the product, and then grasp the base of the cover plate and pull it toward you to remove the Jetdirect card.

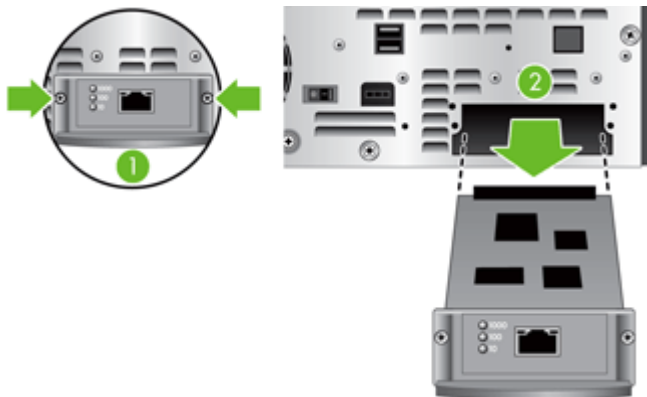

3. Remove the replacement Jetdirect card from its packaging and insert the card into the card slot.

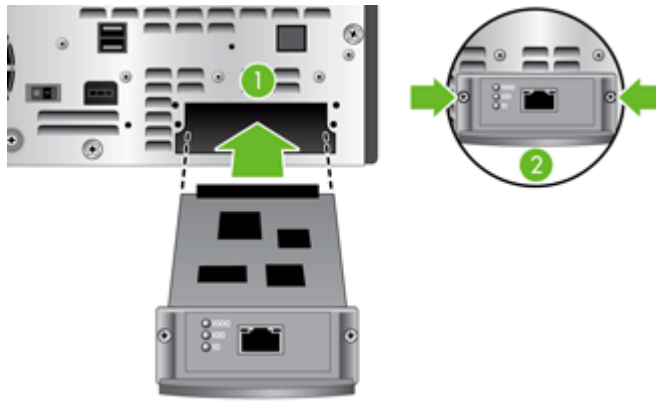

- a. Align the card with the guide rails in the slot.
 - b. Firmly press the card into the slot until the card is seated, and then tighten each thumbscrew a little at a time until both thumbscrews are secure.
4. Connect the network cable to the card.



5. Reconnect the power and Ethernet cables, press the Power switch on the back of the product to the on position, and then press the Power button to turn on the product.

Replace the hard drive

To replace the hard drive, follow these steps.

1. Press the Power button to turn off the product (1), press the Power switch on the back of the product to the off position (2), disconnect power from the product (3), and then disconnect the Ethernet cable (4).

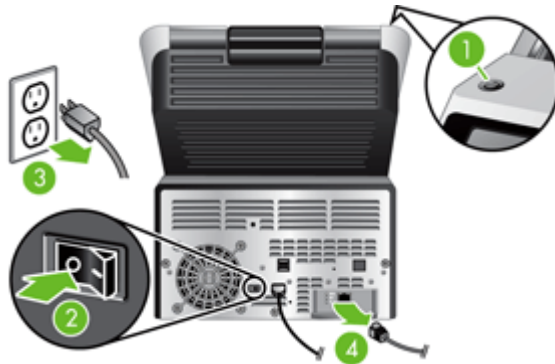

2. Loosen the three screws which secure the back panel drawer to the product, and then slide the back panel/drawer far enough out so you can see the hard drive and reach the hard drive cables.



3. Unfasten the cable ties which secure the cables to the hard drive.

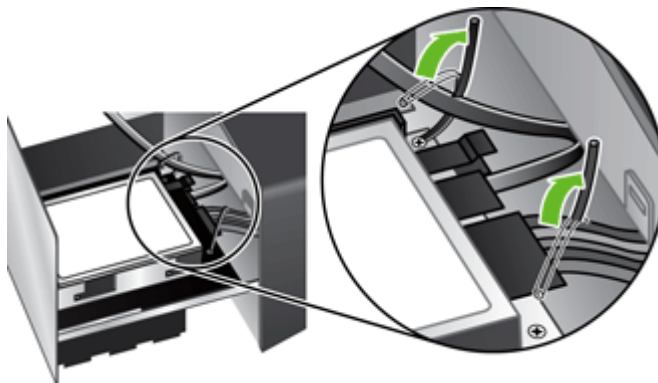

4. Press the connector tab on the flat cable (1) and disconnect the cable (2), and then disconnect the cable bundle (3).

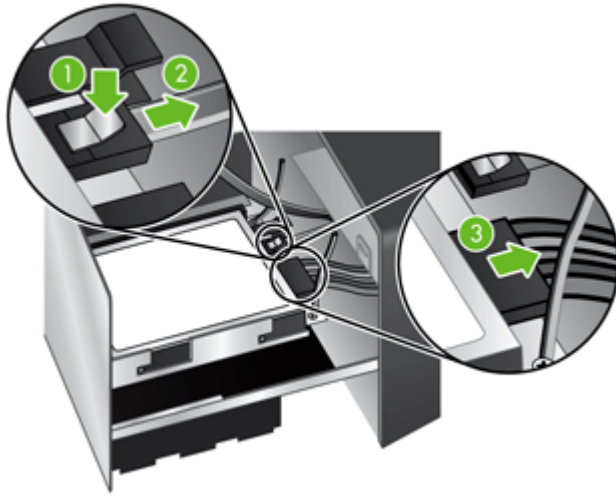

5. To remove the drive, gently lift the drive rail lever on the left leading edge of the drive (1), slide the drive forward (2), and then remove the drive.



6. Remove the black plastic rails from the drive you just removed, and then attach them to the new drive.

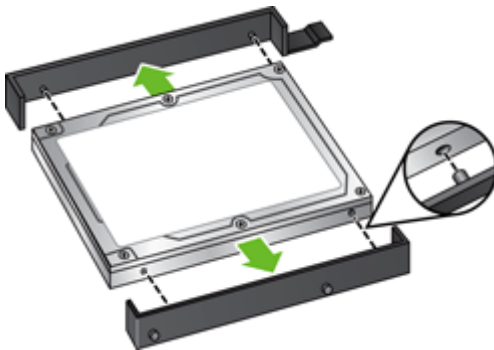

7. Slide the new drive into the drive housing until it snaps into place, ensuring that the pegs on the side of the drive rails fit into the slot on the drive housing.

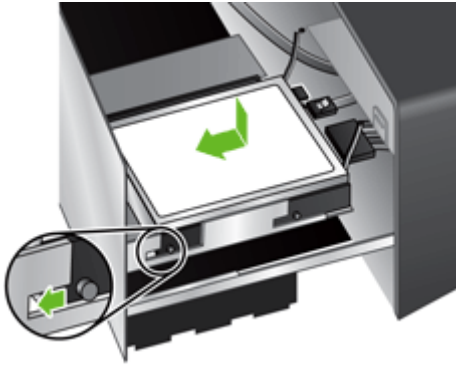

8. Attach the flat cable and the cable bundle to the new drive.

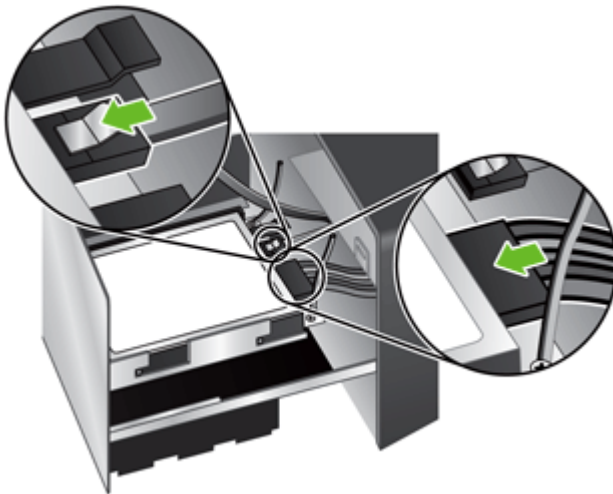

9. Secure the cables with the cable ties you previously unfastened.

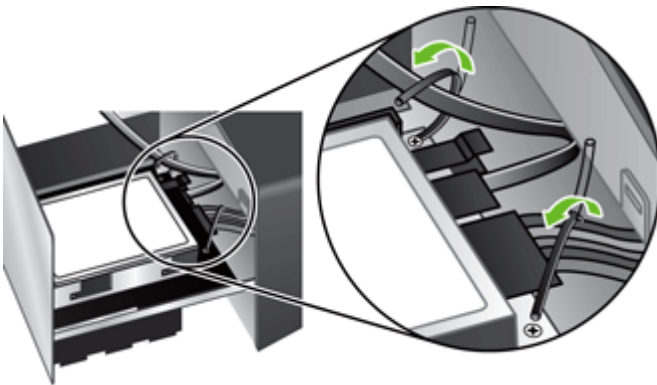

10. Slide the back panel drawer into place (taking care that no cables are pinched) and secure with the screws you previously loosened.
11. Reconnect the power and Ethernet cables, press the Power switch on the back of the product to the on position, and then press the Power button to turn on the product.

Upgrade the firmware

You can upgrade both the product firmware and the HP Jetdirect Inside firmware.

- [Upgrade the product firmware](#)
- [Upgrade the HP Jetdirect Inside firmware](#)

Upgrade the product firmware

 **NOTE:** You must have access to the product's local administrator password to complete this task.

1. From the Home screen, touch the [Service](#) button and note the installed firmware version.

 **NOTE:** Touch the [Firmware Upgrade](#) button, and then touch the [Details](#) button to view firmware version details.

2. See www.hp.com/support, search for your product, and then look for a link to downloads to see if there is a newer version of firmware available.
3. Copy the new firmware file to a USB storage device, and then plug the USB device into the USB connector beside the control panel.

 **CAUTION:** Make sure to leave the USB storage device plugged into the USB connector until all upgrades are installed, the product has rebooted, and the Home screen is displayed on the touch screen.

4. From the Home screen, touch the [Service](#) button, and then touch the [Firmware Upgrade](#) button.

 **NOTE:** If more than one upgrade option is available, install the hardware NVRAM upgrade first, and then install the firmware upgrade.

5. Touch the upgrade option you want to install, and then touch the [Update Now](#) button.

The upgrade process can take a few minutes.

6. When prompted, touch the [Yes](#) button to reboot the product.

Starting the product after a firmware upgrade may take up to 20 minutes.

7. If necessary, repeat the previous two steps to install a second upgrade.

 **NOTE:** You can also upgrade firmware using the Embedded Web Server.

Upgrade the HP Jetdirect Inside firmware

The HP Jetdirect Inside network interface in the device has firmware that can be upgraded separately from the digital-sender firmware. This procedure requires that you have HP Web Jetadmin Version 6.2 or greater installed. Complete the following steps to update the HP Jetdirect firmware with HP Web Jetadmin.

1. Open the Web Jetadmin program.
2. Open the **Device Management** folder in the drop-down list in the **Navigation** panel, and then navigate to the **Device Lists** folder.

3. Select the device that you want to update, click the **Firmware** tab in the status area at in the bottom portion of the **Device Management** screen, and then select **Jetdirect Firmware** to view the current version of Jetdirect firmware.
4. See www.hp.com/go/wja_firmware.
5. Scroll down to the list of Jetdirect model numbers and find the model number of the device you want to update.
6. Look at the current firmware version for the model, and see if it is later than the version on the device you want to update. If it is, right-click on the firmware link, following the instructions on the Web page to download the new firmware file. The file must be saved into <drive>:\PROGRAM FILES\HP WEB JETADMIN\DOC\PLUGINS\HPWJA\FIRMWARE\JETDIRECT on the computer that is running the HP Web Jetadmin software.
7. In Web Jetadmin, return to the main device list and select the device that you want to update, click the **Firmware** tab in the status area at in the bottom portion of the **Device Management** screen, and then select **Repository** to view the available versions of Jetdirect firmware.
8. Select the firmware you just downloaded, select **Upgrade Firmware**, and then select **Jetdirect firmware** from the **Select upgrade type** popup.
9. Click **Next** to update the Jetdirect Inside firmware.

8 Solve problems

This section contains solutions for common problems with the product.

- [Error codes](#)
- [Basic troubleshooting tips](#)
- [Restore factory settings](#)
- [Interpret control-panel status lights](#)
- [Control-panel message types](#)
- [Control-panel messages](#)
- [Installation problems](#)
- [Initialization or hardware problems](#)
- [Operation problems](#)
- [Paper path problems](#)
- [Solve e-mail problems](#)
- [Solve network problems](#)
- [Contact HP Support](#)

For additional troubleshooting, see the Help for the HP scanning program that you are using.

Error codes

Follow the displayed instructions and, if applicable, video to resolve an error.

Error Type	Description
ADF empty	No document was detected in the document feeder.
Automatic calibration failed	A hardware failure occurred when the product attempted to calibrate prior to scanning.
Communication failed	A communication failure occurred between the firmware and the product.
Fan failed	The product's fan failed.
Hardware error	A hardware error occurred.
Hatch open	The hatch on the document feeder is open or not securely latched.
Lamp failed	The product lamp failed.
Mispick	The product has detected a document feeder page mispick (for example, no pages fed through the product).
Multi-pick	The product has detected a multiple-page feed error.
Multi-pick sensor failed	The product's multi-pick paper sensor has failed.
Paper jam	The product has detected a document feeder paper jam.

Basic troubleshooting tips

Simple issues such as smudges on the scanner glass or loose cables can cause your product to produce fuzzy scans, operate in an unexpected manner, or fail to operate. Always check the following items when you encounter scanning problems.

- If scans are fuzzy, check to see if the glass strips inside the document feeder are dirty or smudged. If so, clean the glass strips.

Make sure that the original document is clear and crisp to ensure a clear scan.

- Make sure that the Ethernet and power supply cables are firmly seated in their respective connectors on the back of the product, and that the power supply power cable is plugged into a working electrical outlet or surge protector.
- Make sure that the product buttons are enabled.
- Press the Power button, touch the **Restart** option, and then touch the **OK** button.
- Make sure the product latch is closed.

If you continue to have problems, it is possible that your firmware is out of date or has become corrupted. See www.hp.com/support to locate firmware updates for your product.















Restore factory settings

Use the [Resets](#) menu to restore factory settings.

1. Touch the [Service](#) button, and then touch the [Resets](#) button.
2. Touch the buttons associated with the subsystems you wish to reset to factory defaults ([Address Book](#), [Digital Send](#), [E-mail](#), [Fax](#), [General](#), [Security](#)), and then touch the [Reset Settings Now](#) button.

Interpret control-panel status lights

The product has six LEDs on the control panel that indicate product status. The table below explains how to interpret these LEDs.

LED behavior	Description
All LEDs are off.	The product is turned off.
Sleep LED  is on.	The product is in sleep (power conservation) mode.
Sleep LED  is flashing.	The product is entering or exiting sleep mode.
Sleep LED  is off.	The product is not in sleep mode, nor is it transitioning sleep status (on or off).
Power LED  is on.	The product is powered on.
Power LED  is off.	The power supply is not providing power to the product.
Ready LED  is on.	The product is online and able to accept input.
Ready LED  is flashing.	The product is pausing a request or has stopped receiving input.
Ready LED  is off.	The product is paused and unable to accept input. This may be because the product was deliberately paused, or because the product is in an error state.
Data LED  is on.	The product has data buffered that it has finished processing and is waiting for more data to be transmitted, or the product is paused. When the Attention LED is flashing at the same time, there is an error and there is data waiting to be processed.
Data LED  is flashing.	The product is receiving or processing data.
Data LED  is off.	There is no data for the product to process.
Attention LED  is on.	The product has encountered a critical error, the nature of which is indicated on the display.
Attention LED  is flashing quickly.	The product has encountered an error which requires user intervention, such as a paper jam or an open door.
Attention LED  is off.	No error condition exists.



NOTE: Status and error conditions appear on the display.

Control-panel message types

Four types of control-panel messages can indicate the status of or problems with the product.

Message type	Description
Status messages	Status messages reflect the current state of the product. They inform you of normal product operation and require no interaction to clear them. They change as the state of the product changes. Whenever the product is ready, not busy, and has no pending warning messages, the status message Ready appears if the product is online.
Warning messages	Warning messages inform you of data and scan errors. These messages typically alternate with the Ready or status messages and remain until you touch the OK button. Some warning messages are clearable. If Clearable Warnings is set to Job on the product Device Behavior menu, the next job clears these messages.
Error messages	<p>Error messages communicate that some action must be performed, such as clearing a jam.</p> <p>Some error messages are auto-continuable. If Auto-Continue is set on the menus, the product will continue normal operation after an auto-continuable error message appears for 10 seconds.</p> <p>NOTE: Pressing any button during the 10-second auto-continuable error message overrides the auto-continue feature, and the button function takes precedence. For example, pressing the Stop button pauses the task and offers the option to cancel the job.</p>
Critical-error messages	Critical error messages inform you of an error that prevents you from using the device until the problem is addressed. Some of these messages can be cleared by turning the product off and then on. These messages are not affected by the Auto-Continue setting. If a critical error persists, service is required.

Control-panel messages

The product provides robust control panel messaging. When a message appears on the control panel, follow the on-screen instructions to resolve the issue. If the product displays an “Error” or “Attention” message, and no steps are shown to resolve the issue, turn the product off then on. Contact HP support if you continue to experience issues with the product.

To get additional information for warnings that appear in the status line, touch the Warning button.

For additional information on a variety of topics, touch the Help button in the upper-right corner of the Home screen.

Installation problems

Cable type	Action
Power supply cable	<p>The power supply is connected between the product and a power outlet.</p> <ul style="list-style-type: none">• Ensure that the power supply is securely connected to the product.• Ensure that the power cable is securely connected between the power supply and a live electrical outlet or surge protector.• If the power cable is connected to a surge protector, ensure that the surge protector is plugged into an outlet and turned on.• Press the Power button, touch the Restart option, and then touch the OK button.
Ethernet cable	<p>Ensure that the Ethernet cable is securely connected between the product and a network router, Ethernet jack, or Ethernet switch.</p> <p>For additional Ethernet troubleshooting information, see www.hp.com/support, select your country/region, and then use the search tool to find Ethernet or network troubleshooting topics.</p>

Initialization or hardware problems

- [Check the Ethernet connection](#)
- [Check the power connection](#)
- [Reset the product](#)
- [The product has stopped working correctly](#)

Check the Ethernet connection

1. Ensure that the Ethernet cable is firmly connected between the product and a router, Ethernet jack, or Ethernet switch.
2. If the Ethernet cable is connected to a network router or Ethernet switch, try connecting it to a different port on the router or switch.
3. Verify that the network link speed indicator shows that the network is connected at 10, 100, or 1000 Mbps. The LED corresponding to the link speed should be lit.
4. Press the Power button, touch the [Restart](#) option, and then touch the [OK](#) button.

Check the power connection

1. Ensure that the power cable is securely connected between the product and the power supply, that the power supply cable is securely connected between the power supply and a power outlet or surge protector, and that the product is turned on (the Power switch is in the on position, and the Power button is on).
2. Verify that the green LED on the power supply case is on.



If the problem persists after verifying the above items, follow these steps:

1. Press the Power button, touch the [Shutdown Now](#) option, touch the [OK](#) button, and then disconnect the power cable.
2. Wait 30 seconds.
3. Reconnect the power cable, and then press the Power button.

Reset the product

If you receive an error message indicating that initialization failed or the product could not be found when trying to use the product, you should reset the product.

To reset the product, follow these steps:

1. Close the Embedded Web Server and optional HP Digital Sending Software, if they are open.
2. Press the Power button.
3. When prompted, touch **Shutdown Now**, and then touch **OK** to turn off the product.
4. Wait 30 seconds, and then press the Power button to turn on the product.

The product has stopped working correctly

If the product stops scanning, follow these steps. After each step, start a scan to see if the product is working. If the problem persists, proceed with the next step.

1. A cable might be loose. Ensure that the Ethernet, power supply, and power cables are properly connected.
2. Ensure that the product is receiving power.
 - a. Check that the green LED on the power supply case is on.



- b. If the green LED is not on, ensure that power is available to the power outlet or surge protector that the power supply cable is plugged into, and that the power cable is securely connected to the power supply and the product.
 - c. If power is available to the power outlet or surge protector but the green LED is still not on, the power supply might be defective. See www.hp.com/support for assistance.
3. Press the Power button, touch the **Restart** option, and then touch the **OK** button.

Operation problems

- [Product will not turn on](#)
- [Lamp stays on](#)
- [Scan does not start right away](#)
- [Only one side of a two-sided page scans](#)
- [Scanned pages are missing at the scan destination](#)
- [Scanned pages are out of order at the scan destination](#)
- [Optimize scanning and task speeds](#)
- [The scan is completely black or completely white](#)
- [Scanned images are not straight](#)
- [Scan files are too large](#)

Product will not turn on

If the product will not turn on when you press the control-panel buttons, check the following:

- The product may be turned off. Be sure the Power switch is in the on position, and that the Power button LED is lit.
- The product may have been unplugged. Check to see that the power supply has not become disconnected from the product or unplugged from the power source.
- The power supply might not be working.
 - Check that the green LED on the power supply case is on.
 - If the green LED is not on, ensure that power is available to the power outlet or surge protector that the power supply is plugged into.
 - If power is available to the power outlet or surge protector but the green LED is still not on, the power supply might be defective. See www.hp.com/support for assistance.

Lamp stays on

The lamp should time out and turn off automatically after a period of inactivity (about 15 minutes).

If the lamp remains on after a long period of inactivity, press the Power button, touch the [Restart](#) option, and then touch the [OK](#) button.

Scan does not start right away

Make sure the hatch is closed, that the Power switch is in the on position, and that the product is turned on.

If the product has not been used for awhile, the lamp might need to go through a warm-up period before scanning can begin. If the lamp needs to warm up, it takes a moment after pressing a button for scanning to begin.

Only one side of a two-sided page scans

Make sure the scan option you select supports two-sided scanning.

Scanned pages are missing at the scan destination

When scanning, pages that stick together are scanned as one item. The hidden pages are not scanned.

Scanned pages are out of order at the scan destination

Verify that the page order of the original document is correct before inserting into the document feeder.

Make sure that there are no staples, paper clips, or any other attached material (such as adhesive notes) that may cause the pages to feed incorrectly.

Verify that pages are not stuck together.

Place the first page of a multiple page document toward the back of the document feeder.

Optimize scanning and task speeds

Several settings influence the total time for a scanning job. When you want to optimize scanning performance, consider the following information.

- Choose a quick set that matches the orientation of the originals in the document feeder.
- Use a compression setting appropriate for the original you are scanning.
- Scanning at a higher resolution than necessary increases scanning time and creates a larger file with no additional benefit. If you are scanning at a high resolution, set the resolution to a lower level to increase scanning speed.

The scan is completely black or completely white

The original might not be placed correctly in the document feeder. Make sure that the original you are trying to scan is placed face down.

Scanned images are not straight

Verify that the document feeder guides on the product are centered and set to an appropriate width for the original being scanned. Make sure the paper guides touch the edges of the original.

Scan files are too large

If the saved scan files are very large, try the following:

- Verify the scan resolution setting:
 - 200 dpi is sufficient for storing documents as images.
 - For most fonts, 300 dpi is sufficient for using optical character recognition (OCR) to create editable text.
 - For Asian fonts and small fonts, 400 dpi is the recommended resolution.

Scanning at a higher resolution than necessary creates a larger file with no additional benefit.

- Color scans create larger files than do black and white scans.
- If you are scanning a large number of pages at one time, consider scanning fewer pages at a time to create more, smaller files.

Paper path problems

- [Paper jamming, skewing, misfeeds, or multiple-page feeds](#)
- [Scanning fragile originals](#)
- [Paper does not feed correctly](#)
- [Originals are curling up in the output tray](#)
- [The bottom of the scanned image is cut off](#)
- [The scanned images have streaks or scratches](#)
- [An item loaded in the document feeder jams repeatedly](#)
- [Clear jams from the paper path](#)

Paper jamming, skewing, misfeeds, or multiple-page feeds

- Check that all rollers are in place and that the roller doors and hatch are closed.
- If the pages look skewed as they feed into the paper path, preview the scan to ensure that the images are not skewed.
- The pages might not be placed correctly. Straighten the pages and adjust the paper guides to center the stack.
- The paper guides must be touching the sides of the paper stack to work properly. Ensure that the paper stack is straight and the guides are against the paper stack.
- The document feeder or output tray might contain more than the maximum number of pages. Load fewer pages in the document feeder, and remove pages from the output tray.
- Clean the paper path to help reduce misfeeds. If misfeeds still occur, clean the rollers. If misfeeds still occur, replace the rollers.

 **NOTE:** For information on roller maintenance, touch the [Service](#) button on the Home screen, touch the [Maintenance](#) button, touch the [Clean Rollers](#) or [Replace Rollers](#) button, and then follow the onscreen instructions.

Scanning fragile originals

To safely scan fragile originals (photographs or documents on wrinkled or very lightweight paper) place originals in a clear, heavyweight document sleeve that is no more than 216 mm (8.5 in) wide before inserting into the document feeder.

 **TIP:** If you do not have an appropriately-sized document sleeve, consider using a sheet protector intended for use in a ring binder. Trim the ring-side edge so the sleeve is no more than 216 mm (8.5 in) wide.

Paper does not feed correctly

Reload the pages into the document feeder, ensuring that they make contact with the rollers.

The hatch might not be securely latched. Open the hatch and then close it by pressing firmly.

A problem with the hardware might exist. Follow this procedure to test the product:

1. Ensure that the power supply is securely connected between the product and a live electrical outlet or surge protector. Check that the green LED on the power supply case is on to verify that the power supply is functional.
2. If the power supply is connected to a surge protector, ensure that the surge protector is plugged into an outlet and turned on.
3. Press the Power button.
4. When prompted, touch **Shutdown Now**, and then touch **OK** to turn off the product.
5. Wait 30 seconds, and then press the Power button to turn on the product.
6. Try the scan again.

Originals are curling up in the output tray

Under dry conditions, lightweight originals such as those printed on carbonless copy paper may curl in the output tray. To minimize curl, flatten curled edges on the originals before placing them in the document feeder. If you cannot flatten curled edges, make sure the curled edges are facing down when you place the originals in the document feeder.

The bottom of the scanned image is cut off

By default, the product can scan media that is up to 864 mm (34 in) long. For longer pages, the end of the document is not included in the scanned image.

Make sure the job option you select reflects the page size of the document you are scanning.

The scanned images have streaks or scratches

After each step, try another scan to see if the streaks or scratches are still apparent. If so, then try the next step.

- Check that the originals are clean and unwrinkled.
- Use a cleaning cloth in the paper path.
- Clean the glass strips inside the document feeder.
- Clean the rollers.

An item loaded in the document feeder jams repeatedly

- The item might not meet the guidelines for acceptable originals.
- The item might have something on it, such as staples or self-adhesive notes on the original that must be removed.
- Make sure the paper guides touch the edges of the original.

Clear jams from the paper path

To clear a paper jam:

1. Remove originals from the document feeder.

2. Open the hatch.

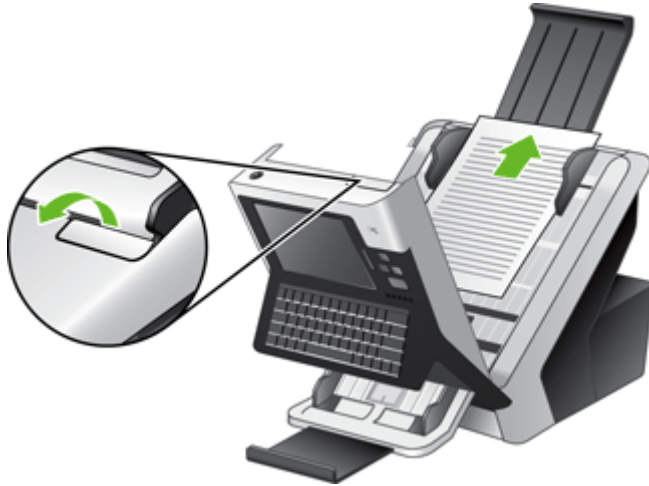

3. Remove the originals or any obstructions from the paper path.
4. Remove any debris (paper, staples, clips, etc.) that you see in the paper path.
5. Close the hatch until it snaps into place.



6. Reload the unscanned originals in the document feeder.
7. Resume scanning.

Solve e-mail problems

If you are unable to send e-mails by using the digital-send feature, you might need to reconfigure the SMTP gateway address or the LDAP gateway address. View a configuration page to find the current SMTP and LDAP gateway addresses. Use the following procedures to check if the SMTP and LDAP gateway addresses are valid.

Validate the SMTP gateway address



NOTE: This procedure is for Windows operating systems.

1. Open an MS-DOS command prompt: click **Start**, click **Run**, and then type `cmd`.
2. Type `telnet` followed by the SMTP gateway address and then the number **25**, which is the port over which the product is communicating. For example, type `telnet 123.123.123.123 25` where "123.123.123.123" represents the SMTP gateway address.
3. Press **Enter**. If the SMTP gateway address is *not* valid, the response contains the message `Could not open connection to the host on port, 25: Connect failed`.
4. If the SMTP gateway address is not valid, contact the network administrator.

Validate the LDAP gateway address



NOTE: This procedure is for Windows operating systems.

1. Open Windows Explorer. In the address bar, type `LDAP://` immediately followed by the LDAP gateway address. For example, type `LDAP://12.12.12.12` where "12.12.12.12" represents the LDAP gateway address.
2. Press **Enter**. If the LDAP gateway address is valid, the **Find People** dialog box opens.
3. If the LDAP gateway address is not valid, contact the network administrator.

Solve network problems

Check the following items to verify that the product is communicating with the network. Before beginning, view the information pages.

If you still cannot connect to the network after checking these items, see www.hp.com/support.

1. Are your power and power supply cables connected properly, and is the product turned on?
2. Are your network cables connected properly?

Make sure that the product is attached to the network using the appropriate port and cable. Check each cable connection to make sure it is secure and in the right place. If the problem continues, try a different cable or ports on the hub or transceiver.

3. Are the link speed and duplex settings set correctly?

Hewlett-Packard recommends leaving this setting in automatic mode (the default setting).

4. Can you "ping" the product using its IP address?

Use the command prompt to ping the product from your computer. For example:

```
ping 192.168.45.39
```

Ensure that the ping displays round-trip times.

If you are able to ping the product, verify that the IP address configuration for the product is correct on the computer. If it is correct, delete and then add the product again.

If the ping command failed, verify that the network hubs are on, and then verify that the network settings, the product, and the computer are all configured for the same network.

5. Have any software applications been added to the network?

Make sure they are compatible and that they are installed correctly.

6. Is your protocol enabled?

Use the Embedded Web Server to check the status of protocols.

7. Does the product appear in HP Web Jetadmin or other management application?

- Verify network settings on the Network configuration screen.
- Confirm the network settings for the product using the product control panel.

Contact HP Support

For support contact information, see the printed materials that came with the product, or see www.hp.com/support.

A Supplies and accessories

- [Order parts, accessories, and supplies](#)
- [Part numbers](#)

Order parts, accessories, and supplies

Several methods are available for ordering parts, supplies, and accessories.

Order genuine HP parts or accessories	www.hp.com/buy/parts
Order through service or support providers	Contact an HP-authorized service or support provider.
Order using HP software	Embedded Web Server on page 51

Part numbers

Ordering information and availability might change during the life of the product.

Accessories

Item	Description	Part number
HP Scanjet 7000n Keyboard	Keyboards available in French, French (Canadian), German, Russian, and Spanish	L2710A

Cables and interfaces

Item	Description	Part number
HP Jetdirect 630n IPv6 Gigabit Ethernet Print Server	Provides support for IPv4 and IPv6 protocol as well as support for Gigabit and Fast Ethernet networks	J7997G
HP Jetdirect 690n Wireless Card	Provides wireless connection support	J8007G

Maintenance kits

Item	Description	Part number
7000/5000 Roller Replacement Kit	Replacement kit for feed rollers in the document feeder	L2707A
10-pack ADF Cleaning Cloth Package	Paper-path sheets for cleaning the document feeder	C9943B

B Service and support

- [Hewlett-Packard limited warranty statement](#)
- [OpenSSL](#)
- [Customer self-repair warranty service](#)
- [Customer support](#)

Hewlett-Packard limited warranty statement

HP PRODUCT	DURATION OF LIMITED WARRANTY
HP Scanjet 7000n	One-year limited warranty

HP warrants to you, the end-user customer, that HP hardware and accessories will be free from defects in materials and workmanship after the date of purchase, for the period specified above. If HP receives notice of such defects during the warranty period, HP will, at its option, either repair or replace products which prove to be defective. Replacement products may be either new or equivalent in performance to new.

HP warrants to you that HP software will not fail to execute its programming instructions after the date of purchase, for the period specified above, due to defects in material and workmanship when properly installed and used. If HP receives notice of such defects during the warranty period, HP will replace software which does not execute its programming instructions due to such defects.

HP does not warrant that the operation of HP products will be uninterrupted or error free. If HP is unable, within a reasonable time, to repair or replace any product to a condition as warranted, you will be entitled to a refund of the purchase price upon prompt return of the product.

HP products may contain remanufactured parts equivalent to new in performance or may have been subject to incidental use.

Warranty does not apply to defects resulting from (a) improper or inadequate maintenance or calibration, (b) software, interfacing, parts or supplies not supplied by HP, (c) unauthorized modification or misuse, (d) operation outside of the published environmental specifications for the product, or (e) improper site preparation or maintenance.

TO THE EXTENT ALLOWED BY LOCAL LAW, THE ABOVE WARRANTIES ARE EXCLUSIVE AND NO OTHER WARRANTY OR CONDITION, WHETHER WRITTEN OR ORAL, IS EXPRESSED OR IMPLIED AND HP SPECIFICALLY DISCLAIMS ANY IMPLIED WARRANTIES OR CONDITIONS OF MERCHANTABILITY, SATISFACTORY QUALITY, AND FITNESS FOR A PARTICULAR PURPOSE. Some countries/regions, states or provinces do not allow limitations on the duration of an implied warranty, so the above limitation or exclusion might not apply to you. This warranty gives you specific legal rights and you might also have other rights that vary from country/region to country/region, state to state, or province to province.

HP's limited warranty is valid in any country/region or locality where HP has a support presence for this product and where HP has marketed this product. The level of warranty service you receive may vary according to local standards. HP will not alter form, fit or function of the product to make it operate in a country/region for which it was never intended to function for legal or regulatory reasons.

TO THE EXTENT ALLOWED BY LOCAL LAW, THE REMEDIES IN THIS WARRANTY STATEMENT ARE YOUR SOLE AND EXCLUSIVE REMEDIES. EXCEPT AS INDICATED ABOVE, IN NO EVENT WILL HP OR ITS SUPPLIERS BE LIABLE FOR LOSS OF DATA OR FOR DIRECT, SPECIAL, INCIDENTAL, CONSEQUENTIAL (INCLUDING LOST PROFIT OR DATA), OR OTHER DAMAGE, WHETHER BASED IN CONTRACT, TORT, OR OTHERWISE. Some countries/regions, states or provinces do not allow the exclusion or limitation of incidental or consequential damages, so the above limitation or exclusion may not apply to you.

THE WARRANTY TERMS CONTAINED IN THIS STATEMENT, EXCEPT TO THE EXTENT LAWFULLY PERMITTED, DO NOT EXCLUDE, RESTRICT OR MODIFY AND ARE IN ADDITION TO THE MANDATORY STATUTORY RIGHTS APPLICABLE TO THE SALE OF THIS PRODUCT TO YOU.

OpenSSL

Copyright (c) 1998-2001 The OpenSSL Project. All rights reserved.

Redistribution and use in source and binary forms, with or without modification, are permitted provided that the following conditions are met:

1. Redistributions of source code must retain the above copyright notice, this list of conditions and the following disclaimer.
2. Redistributions in binary form must reproduce the above copyright notice, this list of conditions and the following disclaimer in the documentation and/or other materials provided with the distribution.
3. All advertising materials mentioning features or use of this software must display the following acknowledgment: "This product includes software developed by the OpenSSL Project for use in the OpenSSL Toolkit. (<http://www.openssl.org/>)"
4. The names "OpenSSL Toolkit" and "OpenSSL Project" must not be used to endorse or promote products derived from this software without prior written permission. For written permission, please contact openssl-core@openssl.org.
5. Products derived from this software may not be called "OpenSSL" nor may "OpenSSL" appear in their names without prior written permission of the OpenSSL Project.
6. Redistributions of any form whatsoever must retain the following acknowledgment: "This product includes software developed by the OpenSSL Project for use in the OpenSSL Toolkit (<http://www.openssl.org/>)"

THIS SOFTWARE IS PROVIDED BY THE OpenSSL PROJECT ``AS IS" AND ANY EXPRESSED OR IMPLIED WARRANTIES, INCLUDING, BUT NOT LIMITED TO, THE IMPLIED WARRANTIES OF MERCHANTABILITY AND FITNESS FOR A PARTICULAR PURPOSE ARE DISCLAIMED. IN NO EVENT SHALL THE OpenSSL PROJECT OR ITS CONTRIBUTORS BE LIABLE FOR ANY DIRECT, INDIRECT, INCIDENTAL, SPECIAL, EXEMPLARY, OR CONSEQUENTIAL DAMAGES (INCLUDING, BUT NOT LIMITED TO, PROCUREMENT OF SUBSTITUTE GOODS OR SERVICES; LOSS OF USE, DATA, OR PROFITS; OR BUSINESS INTERRUPTION) HOWEVER CAUSED AND ON ANY THEORY OF LIABILITY, WHETHER IN CONTRACT, STRICT LIABILITY, OR TORT (INCLUDING NEGLIGENCE OR OTHERWISE) ARISING IN ANY WAY OUT OF THE USE OF THIS SOFTWARE, EVEN IF ADVISED OF THE POSSIBILITY OF SUCH DAMAGE.

This product includes cryptographic software written by Eric Young

(eay@cryptsoft.com). This product includes software written by Tim Hudson (tjh@cryptsoft.com).

```
/* crypto/mem.c */
```

```
/* Copyright (C) 1995-1998 Eric Young (eay@cryptsoft.com)
```

All rights reserved.

This package is an SSL implementation written by Eric Young (eay@cryptsoft.com). The implementation was written so as to conform with Netscapes SSL.

This library is free for commercial and non-commercial use as long as the following conditions are adhered to. The following conditions apply to all code found in this distribution, be it the RC4, RSA, lhash, DES, etc., code; not just the SSL code. The SSL documentation included with this distribution is covered by the same copyright terms except that the holder is Tim Hudson (tjh@cryptsoft.com).

Copyright remains Eric Young's, and as such any Copyright notices in the code are not to be removed. If this package is used in a product, Eric Young should be given attribution as the author of the parts of the library used. This can be in the form of a textual message at program startup or in documentation (online or textual) provided with the package.

Redistribution and use in source and binary forms, with or without modification, are permitted provided that the following conditions are met:

1. Redistributions of source code must retain the copyright notice, this list of conditions and the following disclaimer.
2. Redistributions in binary form must reproduce the above copyright notice, this list of conditions and the following disclaimer in the documentation and/or other materials provided with the distribution.
3. All advertising materials mentioning features or use of this software must display the following acknowledgement: "This product includes cryptographic software written by Eric Young (eay@cryptsoft.com)" The word 'cryptographic' can be left out if the routines from the library being used are not cryptographic related :-).
4. If you include any Windows specific code (or a derivative thereof) from the apps directory (application code) you must include an acknowledgement: "This product includes software written by Tim Hudson (tjh@cryptsoft.com)"

THIS SOFTWARE IS PROVIDED BY ERIC YOUNG ``AS IS" AND ANY EXPRESS OR IMPLIED WARRANTIES, INCLUDING, BUT NOT LIMITED TO, THE IMPLIED WARRANTIES OF MERCHANTABILITY AND FITNESS FOR A PARTICULAR PURPOSE ARE DISCLAIMED. IN NO EVENT SHALL THE AUTHOR OR CONTRIBUTORS BE LIABLE FOR ANY DIRECT, INDIRECT, INCIDENTAL, SPECIAL, EXEMPLARY, OR CONSEQUENTIAL DAMAGES (INCLUDING, BUT NOT LIMITED TO, PROCUREMENT OF SUBSTITUTE GOODS OR SERVICES; LOSS OF USE, DATA, OR PROFITS; OR BUSINESS INTERRUPTION) HOWEVER CAUSED AND ON ANY THEORY OF LIABILITY, WHETHER IN CONTRACT, STRICT LIABILITY, OR TORT (INCLUDING NEGLIGENCE OR OTHERWISE) ARISING IN ANY WAY OUT OF THE USE OF THIS SOFTWARE, EVEN IF ADVISED OF THE POSSIBILITY OF SUCH DAMAGE.

The license and distribution terms for any publically available version or derivative of this code cannot be changed. i.e. this code cannot simply be copied and put under another distribution license [including the GNU Public License.]

Customer self-repair warranty service

HP products are designed with many Customer Self Repair (CSR) parts to minimize repair time and allow for greater flexibility in performing defective parts replacement. If during the diagnosis period, HP identifies that the repair can be accomplished by the use of a CSR part, HP will ship that part directly to you for replacement. If you request HP to replace these parts, you will be charged for the travel and labor costs of this service.

Based on availability and where geography permits, CSR parts will be shipped for next business day delivery. Same-day or four-hour delivery may be offered at an additional charge where geography permits. If assistance is required, you can call the HP Technical Support Center and a technician will help you over the phone. HP specifies in the materials shipped with a replacement CSR part whether a defective part must be returned to HP. In cases where it is required to return the defective part to HP, you must ship the defective part back to HP within a defined period of time, normally five (5) business days. The defective part must be returned with the associated documentation in the provided shipping material. Failure to return the defective part may result in HP billing you for the replacement. With a customer self repair, HP will pay all shipping and part return costs and determine the courier/carrier to be used.

Customer support

Get telephone support, free during your warranty period, for your country/region

Country/region phone numbers are on the flyer that was in the box with your product or at www.hp.com/support.

Have the product name, serial number, date of purchase, and problem description ready.

Get 24-hour Internet support

www.hp.com/support

Download software utilities, drivers, and electronic information

www.hp.com/support

Order additional HP service or maintenance agreements

www.hp.com/go/carepack

C Product specifications

- [Physical specifications](#)
- [Power consumption](#)
- [Environmental specifications](#)
- [Certificate of Volatility](#)

Physical specifications

Table C-1 Product dimensions

Product	Height	Depth	Width	Weight
HP Scanjet Enterprise 7000n	343 mm (13.5 in)	411 mm (16.2 in)	321 mm (12.6 in)	16.2 kg (35.6 lb)
HP Scanjet Enterprise 7000n (with trays extended)	508 mm (20 in)	685 mm (26.97 in)	406 mm (15.98 in)	

Power consumption

For power consumption information, see the regulatory_supplement.pdf file in the product documentation.

Environmental specifications

Environmental condition	Recommended	Allowed
Temperature	15° to 27°C (59° to 80.6°F)	0° to 35°C (32° to 95°F)
Relative humidity	20% to 60% relative humidity (RH)	10% to 90% RH
Altitude	N/A	0 to 2500 m (0 to 8000 feet)

Certificate of Volatility

This statement explains the volatility of customer data stored in memory and outlines how to erase secure data from the device.

Volatile memory

The product utilizes volatile memory (512 MB) to store customer data during the scan process. When you turn off the product, this volatile memory is erased.

Non-volatile memory

The product utilizes non-volatile flash memory (2 MB) to store system control data and user preference settings. Non-volatile memory does not store any customer scan data. To clear non-volatile memory and restore it to factory defaults, use the Embedded Web Server.

 **TIP:** You can also clear non-volatile memory using the control panel (touch [Service](#), touch [Menu](#), and then touch [Resets](#)).

Hard-disk-drive memory

The product contains one disk drive (80 GB or larger) that may retain data after you turn off the product, including customer jobs and temporary data such as stored scan data or fax files. To securely erase the data, start the Embedded Web Server, click the **Security** tab, click the **Protect Stored Data** entry in the left pane, click the **Erase Options** button, and then select the **Secure Sanitize Erase** option. The **Secure Sanitize Erase** feature meets standards for clearing disk media defined in NIST Special Publication 800-88 Guidelines for Media Sanitation and the U.S. Department of Defense Updated DSS Clearing and Sanitization Matrix.

D Regulatory information

- [Regulatory model number](#)
- [Environmental product stewardship program](#)
- [Safety statements](#)

Regulatory model number

For regulatory identification purposes your product has been assigned a Regulatory Model Number. The Regulatory Model Number for your product is FCLSD-0807. This regulatory model number should not be confused with the marketing name (HP Scanjet Enterprise 7000n) or product number (L2708A, L2709A). Additional regulatory information about your scanner can be found on the regulatory_supplement.pdf file in the product documentation.

Environmental product stewardship program

Protecting the environment

Hewlett-Packard Company is committed to providing quality products in an environmentally sound manner. This product has been designed with several attributes to minimize impacts on our environment.

Power consumption

Hewlett-Packard printing and imaging equipment marked with the ENERGY STAR® logo is qualified to the U.S. Environmental Protection Agency's ENERGY STAR specifications for imaging equipment. The following mark will appear on ENERGY STAR qualified imaging products:



Additional ENERGY STAR qualified imaging product model information is listed at: www.hp.com/go/energystar

Plastics

Plastic parts over 25 grams are marked according to international standards that enhance the ability to identify plastics for recycling purposes at the end of the product's life.

Material restrictions

This HP product contains the following materials that might require special handling at end-of-life: Mercury in the fluorescent lamp in the scanner and in the display LCD.

Disposal of mercury can be regulated because of environmental considerations. For disposal or recycling information, please contact your local authorities or the Electronic Industries Alliance (EIA) (www.eiae.org).

This product's real-time clock battery or coin cell battery may contain perchlorate and may require special handling when recycled or disposed of in California. (See www.dtsc.ca.gov/hazardouswaste/perchlorate.) The batteries contained in or supplied by Hewlett-Packard for this product include the following:

HP Scanjet 7000n Series	
Type	Lithium manganese dioxide
Weight	2.9 g
Location	On motherboard
User-removable	No



廢電池請回收

For recycling information, you can go to www.hp.com/recycle, or contact your local authorities or the Electronics Industries Alliance: www.eiae.org.

Disposal of waste equipment by users in private households in the European Union



This symbol on the product or on its packaging indicates that this product must not be disposed of with your other household waste. Instead, it is your responsibility to dispose of your waste equipment by handing it over to a designated collection point for the recycling of waste electrical and electronic equipment. The separate collection and recycling of your waste equipment at the time of disposal will help to conserve natural resources and ensure that it is recycled in a manner that protects human health and the environment. For more information about where you can drop off your waste equipment for recycling, please contact your local city office, your household waste disposal service or the shop where you purchased the product.

Chemical substances

HP is committed to providing our customers with information about the chemical substances in our products as needed to comply with legal requirements such as REACH (Regulation EC No 1907/2006 of the European Parliament and the Council). A chemical information report for this product can be found at: www.hp.com/go/reach.

For more information

To obtain information about these environmental topics:

- Product environmental profile sheet for this and many related HP products
- HP's commitment to the environment
- HP's environmental management system
- HP's end-of-life product return and recycling program
- Material Safety Data Sheets

Visit www.hp.com/go/environment or www.hp.com/hpinfo/globalcitizenship/environment.

Safety statements

⚠ WARNING! This product contains motorized parts. Disconnect power to the product before removing the back cover. Replace and secure the back cover before reconnecting power to the product.

Index

- A**
- accessories
 - ordering 97
 - part numbers 98
- address books, e-mail
 - adding addresses 41
 - auto-complete function 43
 - importing 52
 - LDAP support 26
 - recipient lists 41
 - recipient lists, creating 41
- ADF
 - capacity 3
- Administration menu, control panel 12
- administrator password 22
- Attention light
 - locating 8
- authentication and authorization 57
- B**
- batteries included 110
- bins
 - locating 5
- black scans
 - troubleshoot 88
- blank page suppression 3
- browser requirements
 - Embedded Web Server 51
- buttons, control panel
 - locating 8
 - touch screen 11
- C**
- calibrate the touch screen 59
- capacity
 - ADF 3
- cautions 2
- Certificate of Volatility
 - hard-disk-drive memory 107
 - non-volatile memory 107
 - volatile memory 107
- certificate revocation list 57
- clean
 - about 63
 - paper path 64
 - product glass 63
 - rollers 64
 - touch screen 63
- cleaning cloth 64
- Cleaning cloth package
 - part number 98
- configure
 - digital fax 28
 - network folders 28
 - quick sets 29
 - USB storage device 28
- connectivity 3
- connectivity features 3
- control panel
 - Administration menu 12
 - buttons 8
 - clean touch screen 63
 - e-mail screen 42
 - fax screen 44
 - help 11
 - Home screen 10
 - layout 8
 - lights 8
 - locating 5
 - messages, types of 82
 - security 54
 - touch screen buttons 11
- conventions, document 2
- covers, locating 5
- CRL 57
- crooked images 88
- customer support
 - online 104
- cut-off images
 - troubleshoot 91
- D**
- Data light
 - locating 8
- default gateway, setting 23
- device discovery 20
- digital fax
 - configure 28
- digital sending
 - about 26, 41
 - address books 41
 - configure e-mail 26
 - control-panel settings 42, 44
 - Embedded Web Server
 - settings 51, 52
 - folders 46
 - LDAP support 26
 - recipient lists 41
 - sending documents 43
 - SMTP support 26
 - USB storage device 46
 - validating gateway addresses 93
 - workflow 48
- disabling
 - network protocols 25
- disposal, end-of-life 110
- document conventions 2
- documents
 - general loading tips 32
 - tips for mixed-size documents 34

E

- e-mail address books
 - deleting addresses 42
- electrical specifications 106
- Embedded Web Server
 - assigning a password 55
 - features 51
 - General tab 51
 - Information tab 51
 - Networking tab 52
 - options 51
 - Scan/Digital Send tab 52
 - Security tab 52
- end-of-life disposal 110
- environment, specifications 106
- environmental features 3
- Environmental Product Stewardship Program 110
- Error button, control panel touch screen 11
- error messages
 - control panel 83
 - types of 82
- Ethernet cards 3
- European Union, waste disposal 111
- EWS
 - features 51
 - General tab 51
 - Information tab 51
 - Networking tab 52
 - options 51
 - Scan/Digital Send tab 52
 - Security tab 52
- Explorer, versions supported
 - Embedded Web Server 51
- e-mail
 - about 26, 41
 - address books 41
 - auto-complete function 43
 - configure 26
 - control-panel settings 42
 - Embedded Web Server settings 52
 - LDAP support 26
 - problem solving 93
 - recipient lists 41
 - scan 26
 - security 54
 - sending documents 43

- SMTP support 26
- validating gateway addresses 93

F

- factory settings, restore 80
- fax, settings 44
- features 3
- feed roller
 - replace 69
- feeding problems 90
- firmware, upgrading
 - Jetdirect 75
 - product 75
- folders
 - sending to 46
- fragile items, scanning 90
- FTP, sending to 48

G

- gateway, setting default 23
- gateways
 - configure 26
 - validating addresses 93
- General tab, Embedded Web Server 51
- glass, clean 63
- graphical display, control panel 8

H

- hard disks 57
- hard drive, replace 72
- hardware integration pocket 60
- Help button, control panel touch screen 11
- help, control panel 11
- Home button, control panel touch screen 11
- Home screen, control panel 10
- HP Customer Care 104
- HP Digital Sending Software (HP DSS) 18
- HP Jetdirect firmware upgrades 75
- HP Jetdirect server
 - settings 12
- HP paper-path cleaning cloth 64
- HP Web Jetadmin 18, 53
- humidity requirements 106

I

- Image Preview
 - use 39
- information pages 50
- Information tab, Embedded Web Server 51
- install the hardware integration pocket 60
- installation
 - troubleshoot 84
- interface ports
 - included 3
- Internet Explorer, versions supported
 - Embedded Web Server 51
- IP address 23, 24
- IP addressing 20

J

- jams
 - troubleshoot 91
- Jetadmin, HP Web 18, 53
- Jetdirect card, replace 70
- Jetdirect Ethernet Print Server
 - part number 98
- Jetdirect firmware upgrades 75
- Jetdirect server
 - settings 12

K

- keyboard
 - part number 98
- keyboard overlay 69
- keys, control panel
 - locating 8
 - touch screen 11

L

- lamp
 - troubleshoot 87
- LAN-connector 3
- LDAP servers
 - connect to 26
 - Embedded Web Server settings 52
 - validating gateway addresses 93
- lights
 - control panel 8
- link speed settings 16

- loading documents
 - general tips 32
 - tips for mixed-size documents 34
- log in 38
- M**
- maintenance
 - clean paper path 64
 - clean rollers 64
- manage
 - EWS 51
- manage temporary job files 55
- managing network 22
- material restrictions 110
- media
 - jams 91
 - misfeeds 90
 - not feeding 90
 - troubleshoot 90
- memory 3
- Menu button 8
- menus, control panel
 - Administration 12
- mercury product 110
- messages
 - types of 82
- misfeeds
 - troubleshoot 90
- multiple-page feeds 90
- N**
- Netscape Navigator, versions supported
 - Embedded Web Server 51
- network
 - settings, changing 22
 - settings, viewing 22
- network folders
 - configure 28
 - scan to 46
- Networking tab, Embedded Web Server 52
- networks
 - configuring 19
 - connectivity features 3
 - default gateway 23
 - device discovery 20
 - disabling protocols 25
 - HP Web Jetadmin 53
 - IP address 20, 23, 24
 - link speed settings 16
 - protocols supported 20
 - SMTP servers 26
 - subnet mask 23
 - TCP/IP settings 12
 - validating gateway addresses 93
- notes 2
- O**
- on/off switch, locating 5
- online help, control panel 11
- online support 104
- operating environment
 - specifications 106
- order
 - roller replacement 69
 - supplies 68
- ordering
 - part numbers for 98
 - supplies and accessories 97
- output bin
 - locating 5
- P**
- pages missing, troubleshoot 88
- pages out of order 88
- paper
 - jams 91
 - misfeeds 90
 - not feeding 90
 - troubleshoot 90
- paper, ordering 97
- paper-handling 3
- paper-path
 - clean 64
 - feeding problems 90
- part number
 - Cleaning cloth package 98
 - Jetdirect Ethernet Print Server 98
 - keyboard 98
 - Roller replacement kit 98
 - Wireless card 98
- part numbers
 - accessories 98
 - images drums 98
- parts
 - order 69, 98
- password 22
- passwords 54
- physical specifications 105
- ports
 - included 3
- power
 - consumption 106
- Power Save mode 87
- power switch, locating 5
- preview scan 39
- problem-solving
 - Error button, control panel touch screen 11
 - e-mail 93
 - messages, types of 82
- product info 1
- protocols, network 20
- Q**
- quick sets
 - configure 29
- R**
- Ready light
 - locating 8
- recipient lists 41
- regulatory statements
 - environmental product stewardship program 110
- replace
 - parts 69
- replace keyboard 69
- replace rollers 69
- replace the hard drive 72
- replace the Jetdirect card 70
- Reset button 8
- reset scanner 86
- resolution 3
- restore factory settings 80
- Roller replacement kit
 - part number 98
- rollers
 - clean 64
 - replace 69
- S**
- Save to Folder 46
- Save to Network Folder Setup 28
- Save to USB 46
- scan
 - feeding problems 90

- files too large 88
 - fragile items 90
 - preview 39
 - to e-mail 41
 - to fax 45
 - to network folder 46
 - to USB 46
 - using quick sets 47
 - Scan/Digital Send tab, Embedded Web Server 52
 - scanner
 - reset 86
 - scanner lamp
 - troubleshoot 87
 - scanning
 - features 4
 - scanning to e-mail
 - about 26, 41
 - address books 41
 - configure 26
 - control-panel settings 42
 - Embedded Web Server settings 52
 - LDAP support 26
 - recipient lists 41
 - sending documents 43
 - settings 26
 - SMTP support 26
 - validating addresses 93
 - scanning to folder 46
 - scanning to workflow 48
 - Secure Disk Erase 56
 - Secure Storage Erase 56
 - security
 - authentication and authorization 57
 - certificates 57
 - Embedded Web Server settings 52
 - encrypted hard disk 57
 - EWS 55
 - load certificate revocation list 57
 - load certificates 57
 - manage certificates 57
 - manage temporary job files 55
 - Secure Disk Erase 56
 - Secure Storage Erase 56
 - software access 54
 - security features 3, 4
 - Security tab, Embedded Web Server 52
 - Send to Workflow 48
 - sending to e-mail
 - about 26, 41
 - address books 41
 - Embedded Web Server settings 52
 - LDAP support 26
 - recipient lists 41
 - sending documents 43
 - settings 42
 - SMTP support 26
 - validating gateway addresses 93
 - sending to fax 45
 - serial number
 - locate 6
 - settings, restore 80
 - sign in 38
 - skewed images 88
 - Sleep button 8
 - SMTP servers
 - connect to 26
 - validating gateway addresses 93
 - software
 - embedded Web server 18
 - HP Digital Sending Software (HP DSS) 18
 - HP Web Jetadmin 18
 - restricting access 54
 - uninstall and reinstall 86
 - solving
 - network problems 94
 - specifications
 - electrical 106
 - operating environment 106
 - physical 105
 - speed
 - troubleshoot 87
 - speed, troubleshoot 88
 - standard output bin
 - locating 5
 - Start button 8
 - Start button, control panel touch screen 11
 - status
 - Home screen, control panel 10
 - messages, types of 82
 - Stop button 8
 - streaks
 - troubleshoot 91
 - subnet mask 23
 - supplies
 - order 68
 - ordering 97
 - replace 69
 - support
 - online 104
 - system requirements
 - Embedded Web Server 51
- T**
- TCP/IP parameters, manual configuration 23, 24
 - TCP/IP settings 12
 - technical support
 - online 104
 - temperature requirements 106
 - test the touch screen 59
 - tips 2
 - touch screen
 - calibrate 59
 - clean 63
 - test 59
 - troubleshoot
 - basic tips 79
 - black scans 88
 - check power 85
 - crooked images 88
 - cut-off images 91
 - feeding problems 90
 - fragile items 90
 - installation 84
 - jams 91
 - lamp stays on 87
 - large scan files 88
 - misfeeds 90
 - page order 88
 - pages missing 88
 - paper not feeding 90
 - power 87
 - reset scanner 86
 - scanning fragile items 90
 - speed 87, 88

- stops working 86
- streaks 91
- two-sided scans 88
- uninstall and reinstall software 86
- warm-up time 87
- white scans 88
- troubleshooting
 - control panel messages 83
 - gateway addresses 93
 - network problems 94
- turn on product
 - troubleshoot 87
- two-sided scans
 - troubleshoot 88

U

- uninstall and reinstall software 86
- upgrading firmware
 - Jetdirect 75
 - product 75
- USB storage device
 - configure 28
- USB storage device, save to 46
- user interface 3

V

- validating gateway addresses 93

W

- warm-up time 87
- Warning button, control panel touch screen 11
- warnings 2
- warranty
 - customer self repair 103
 - product 100
- Web browser requirements
 - Embedded Web Server 51
- Web sites
 - customer support 104
 - HP Web Jetadmin,
 - downloading 53
 - order supplies 68
 - replacement parts 69
- white scans
 - troubleshoot 88
- Wireless card
 - part number 98
- workflow, send to 48