

KENWOOD

KTC-D600E

DIGITAL TV TUNER

INSTRUCTION MANUAL

Kenwood Corporation

DVB[®]
Digital Video
Broadcasting

© B64-4758-08/00 (E)

Contents

Safety precautions	3
Notes	3
Basic Operation	4
Function During TV Screen	
Menu Control Screen	
Settings	5
System Setting	
Automatic Search (Searching for currently available station)	
Manual Search (Manually Searching Station)	
My Favorite Channel List	
Restoring to Factory Default	
Updating the Software	
Parental Level Setup	
Language Setup	
Time Setup	
AV Setup	
Displaying EPG	13
Viewing the Program Guide	
Operation of Remote Control Unit	14
Preparing the Remote Control Unit	
Accessories	16
Installation	16
Connection	18
LZ-612IR Operation	19
LZ-612IR Setup1	
LZ-612IR Setup2	
LZ-612IR Connection	20
System Connection with LZ-612IR	
Specifications	20

Monitor units that can be connected to this unit

- **A group**
 - DDX8027
 - DDX9260BT
 - DDX6027
 - DNX9260BT
 - DNX7260BT
 - DDX8026BT
- **B group**
 - DDX520VBT
 - DNX5260BT
 - DNX5260
 - DDX5026
 - KVT-526DVD
 - DNX9240BT
 - DNX7240BT
 - DNX5240BT
 - DNX5240
 - KVT-524DVD
 - KVT-554DVD
 - KVT-54DVDR
 - DDX8024BT
 - DDX8054BT
 - DDX6054
 - DDX5024
 - DDX5054
 - DDX54R
 - DNX8220BT
 - DNX7220
 - DNX5220BT
 - DNX5220
 - KVT-522DVD
 - KVT-50DVDR
 - DDX8022BT
 - DDX5022
 - DDX52R
 - DNX7200
 - KVT-829DVD
 - KVT-729DVD
 - DDX8029
 - DDX7029
 - KOS-V500
 - KOS-V1000
 - LZ-612IR
- **C group**
 - DDX6029
 - KVT-827DVD
 - KVT-727DVD
 - KVT-627DVD
- **D group**
 - LZ-760R
- **E group**
 - Unit with RCA video input

MENU and EPG operation depends on the group.

- **A group**
 - Touch the item to select.
- **B group**
 - Use ▲, ▼, ◀, ▶ buttons to select the item.
- **C group**
 - Items can be selected using the remote controller

Safety precautions

⚠ WARNING

To prevent injury or fire, take the following precautions:

To prevent a short circuit, never put or leave any metallic objects (such as coins or metal tools) inside the unit.

Installation Procedure

- 1 To prevent short circuits, remove the key from the ignition and disconnect the ⊖ terminal of the battery.
- 2 Make the proper input and output wire connections for each unit.
- 3 Connect the wire on the wiring harness.
- 4 Connect the wiring harness connector to the unit.
- 5 Install the unit in your car.
- 6 Reconnect the ⊖ terminal of the battery.
- 7 Press the reset button.



- Mounting and wiring this product requires skills and experience. For safety's sake, leave the mounting and wiring work to professionals.
- Make sure to ground the unit to a negative 12V DC power supply.
- Do not install the unit in a spot exposed to direct sunlight or excessive heat or humidity. Also avoid places with too much dust or the possibility of water splashing.
- Do not use your own screws. Use only the screws provided. If you use the wrong screws, you could damage the unit.
- Make sure that all wire connections are securely made by inserting jacks until they lock completely.
- If your vehicle's ignition does not have an ACC position, or if the ignition wire is connected to a power source with constant voltage such as a battery wire, the power will not be linked with the ignition (i.e., it will not turn on and off along with the ignition). If you want to link the unit's power with the ignition, connect the ignition wire to a power source that can be turned on and off with the ignition key.
- Use a commercially available conversion connector if the connector does not fit in the vehicle connector.
- Insulate unconnected wires with vinyl tape or other similar material. To prevent a short circuit, do not remove the caps on the ends of the unconnected wires or the terminals.
- If the fuse blows, first make sure the wires aren't touching to cause a short circuit, then replace the old fuse with one with the same rating.
- After the unit is installed, check whether the brake lamps, blinkers, wipers, etc. on the car are working properly.

Notes

To select TV Type (PAL or NTSC)

The TV picture display can be divided roughly into two TV formats (PAL and NTSC). They are variable depending on countries and areas. This unit has a function for changing the video format according to the TV type. Please confirm to set the Type switch according to the type of your TV type.

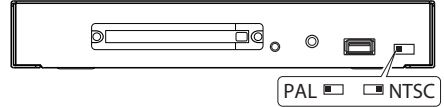

Change NTSC/PAL setting only when the device is turned off.

How to reset your unit

If the unit fails to operate properly, press the Reset button.

It is used for the purpose of software update.

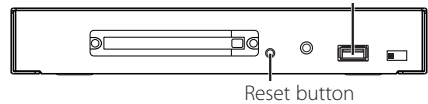

Basic Operation (When connected with DNX9260BT)

Various control screens appear in the Digital TV/ Video Source mode. (You can only operate Digital TV with the optional accessory Digital TV Tuner connected). Refer to the user manual for the connected monitor to see basic operations including how to convert to TV.

Function During TV Screen

Basic functions are available even when the TV screen is displayed.

1 Display the TV screen

2 Operation on the TV screen

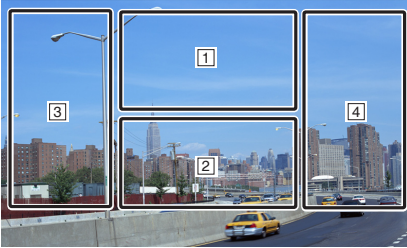

- 1 Displays Menu Control Screen.
- 2 Displays Easy Control Screen. *
- 3, 4 Selects a channel.



* [SCRN], [◀], [▶] buttons shown on Easy Control Screen cannot be used.

Menu Control Screen

Menu Control Screen appears by touching the area shown below.



[Menu] Shows Setting Menu Screen.
(Refer to page 5)

[EPG] Shows EPG (Electric Program Guide) Screen.
(Refer to page 13)

[◀], [▶], [▲], [▼] Moves highlight in Setting Menu.

[Enter] Executes selected Menu item.

[Return] Returns to the previous screen.

[Exit] Returns to Digital TV Screen.

[Direct] Direct TV control by touching the screen.

Settings

You can select following system setting items. Set the system by controlling the touch panel of the monitor. You can also operate the enclosed remote controller in the same way.

System Setting

- 1 Show Menu Control Screen by touching [Menu] button.
- 2 Touch [◀] or [▶] button to select main item.

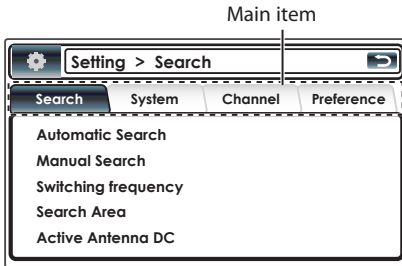

- 3 Touch [▲] or [▼] button to select sub item and then press [Enter] button.

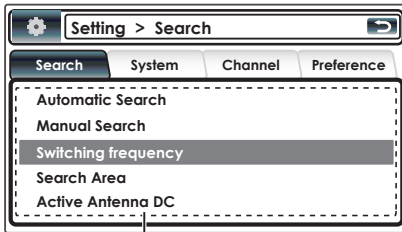

- 4 Touch [▲] or [▼] button to select the value to set and then press [Enter] button.

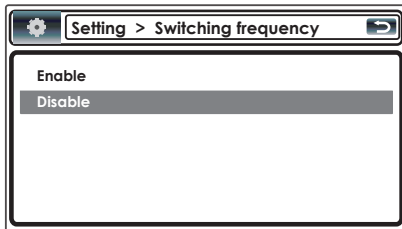

- 5 Touch [Return] button when you are finished.

Setting item	Selectable setting/item
"Search"	
"Automatic Search"	Search for currently available stations and save them in the Channel List. (page 6)
"Manual Search"	Search a station by specifying area or channel. (page 6)
"Switching frequency"	The function is for watching same broadcasting service between several areas. "Enable"/"Disable"
"Search Area"	The function is used to change a frequency table of each country. "Europe"/"Australia"/"Taiwan"
"Active Antenna DC"	Active antenna is used, set to "Enable" (supplied to DC 5V). "Enable"/"Disable"
"System"	
"System Status"	You can view the system information (Hardware, software and system version).
"Reset Default"	All setting values will be returned to the initial values. (page 8)
"Software Update"	Display the firmware version and update the firmware. For how to update the firmware, access our web site. (page 8) http://www.kenwood.com/cs/ce/
"Common Interface"	You can view the CA card information. Information will be displayed according to the CA card used.
"Channel"	
"Edit Channel"	You can additional and edit the favorite channels. (page 7)
"Preference"	
"Parental Control"	You can set to censorship level and change to password. (page 9)
"Language Setting"	You can set to language for menu, Audio and subtitle. (page 10) Menu Language/Audio Language/Subtitle Language: "English"/"German"/"Spanish"/"Italian"/"Dutch"/"Portugal"/"Finland"/"French"/"Russian"
"Time Setting"	You need set to GMT (Greenwich mean time) Offset and Daylight Saving. (page 11) GMT Offset: "-12:00" — "0" — "+12:00" Daylight Saving: "Enable"/"Disable"
"A/V Control"	You can set to Audio output and Screen Ratio. Audio Out: "Stereo"/"Left"/"Right" Screen Ratio: "4:3"/"16:9" This function provides 4:3 and 16:9 two ratio for user to select. If your display supports 4:3 screen format and selected channel provides 4:3 format program, select 4:3.

(Factory setting: Underlined)

Automatic Search (Searching for currently available station)

Search for currently available stations and save them in the Channel List.

- 1 Show Menu Control Screen by touching [Menu] button.
- 2 Touch [◀] or [▶] button to select "Search".
- 3 Touch [▲] or [▼] button to select "Automatic Search" and then press [Enter] button.

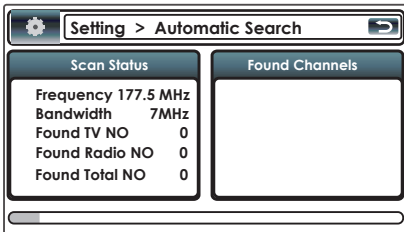
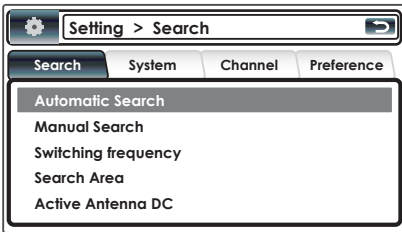

Channel search is performed and the available channel is saved in the channel list.

- 4 Touch [Return] button when you are finished.



- When you perform Automatic Search, the content of the current channel list is discarded and a new list is created. To search for available channels without discarding the content of the current channel list, perform channel search from the Digital TV Screen.

Manual Search (Manually Searching Station)

Search a station by specifying area or channel.

- 1 Show Menu Control Screen by touching [Menu] button.
- 2 Touch [◀] or [▶] button to select "Search".
- 3 Touch [▲] or [▼] button to select "Manual Search" and then press [Enter] button.

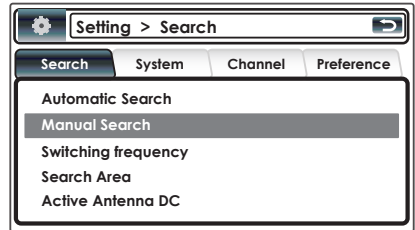

- 4 Touch [▲] or [▼] button to select frequency and then press [Enter] button.

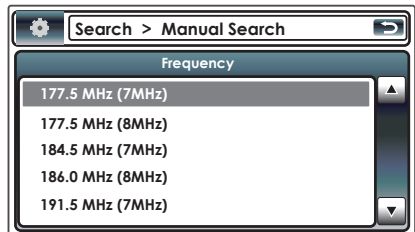

- 5 Touch [Return] button when you are finished.



- Manual search is for advanced users and offers the ability to search for specific channels. Regular users are recommended to use "Automatic Search".

Favorite Channel List

You can additional and erase for TV/RADIO favorite channel list.

- 1 Show Menu Control Screen by touching [Menu] button.
- 2 Touch [◀] or [▶] button to select "Channel".
- 3 Touch [▲] or [▼] button to select "Edit Channel" and then press [Enter] button.

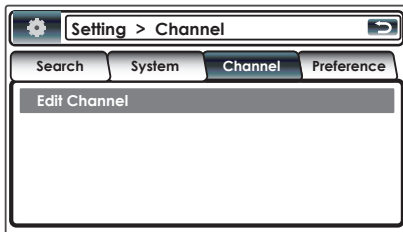

4 Using Direct Touch

Additional channel list

Touch [▲] or [▼] button to select additional channel and then press [▶] button.

Erasing channel list

Touch [▲] or [▼] button to select erasing channel and then press [🗑️] button.

Selecting TV/Radio channels

Touch [📺] button to select tv channel.

Touch [📻] button to select tv channel.

Selecting the channel from favorite list

Touch [◀] or [▶] button to select favorite list. (Favorite1~6)

Using remote controller

Additional channel list

Move the cursor over area A.

Push [▲] or [▼] button to select additional channel and then press [ENTER] button.

Erasing channel list

Move the cursor over area B.

Push [▲] or [▼] button to select erasing channel and then press [ENTER] button.

Selecting TV/Radio channels

Push [TV/RADIO] button to select TV / RADIO channel.

Selecting the channel from favorite list

Move the cursor to area B.

Push numeric (1-6) button to select favorite list. (Favorite1~6)

5 Using Direct Touch

Touch [⏪] button when you are finished.

Using remote controller

Push [Return] button when you are finished.

Restoring to Factory Default

Restore this unit's settings to factory default.

- 1 Show Menu Control Screen by touching [Menu] button.
- 2 Touch [◀] or [▶] button to select "System".
- 3 Touch [▲] or [▼] button to select "Reset Default" and then press [Enter] button.

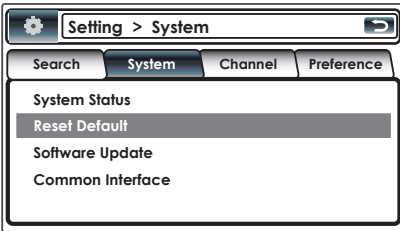

- 4 Touch [▲] or [▼] button to select "OK" and then press [Enter] button.

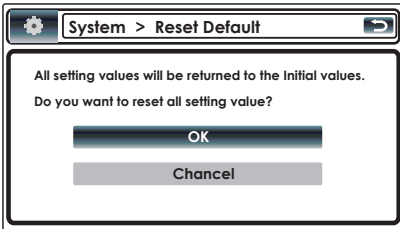

- 5 Touch [Return] button when you are finished.

Updating the Software

Download the new software from the USB Memory stick and update the software installed in this unit.

- 1 Show Menu Control Screen by touching [Menu] button.
- 2 Touch [◀] or [▶] button to select "System".
- 3 Touch [▲] or [▼] button to select "Software Update" and then press [Enter] button.

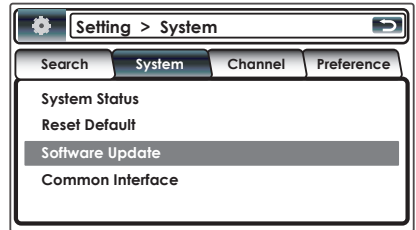

- 4 Touch [▲] or [▼] button to select "OK" and then press [Enter] button.

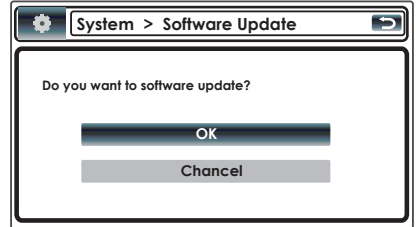

- 5 The device will be turned off and on automatically. Software update will start in a moment from the LOGO screen.

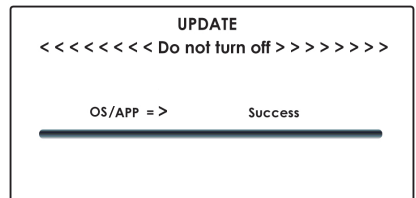

The device will be turned off automatically when the update is finished. Press the RESET button once, then the software update process is completed.



- Do not turn off the power while update is in progress.
- If the power is turned off accidentally during upgrading, turn on the power while keeping the USB stick in the slot. The Update menu will then be activated automatically.

6 Touch [Return] button when you are finished.



- This function is only available when the USB Memory stick supports this feature.
- When new software is loaded, this might have different functions than the software you are using now. This manual might not be accurate anymore for the new software version.

Parental Level Setup

Sets a parental level.

- 1 Show Menu Control Screen by touching [Menu] button.
- 2 Touch [◀] or [▶] button to select "Preference".
- 3 Touch [▲] or [▼] button to select "Parental Control" and then press [Enter] button.

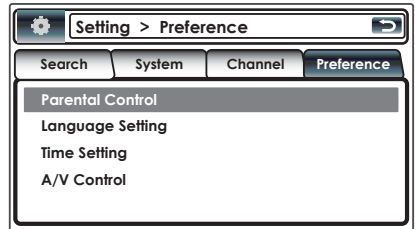

- 4 Press the number ([1] - [0]) button on the remote controller to enter password.

By default, "0000" is specified.

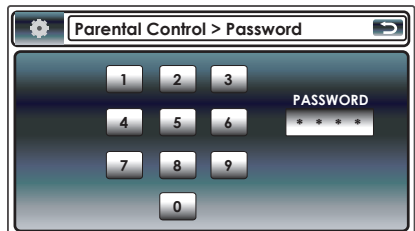

- 5 Touch [▲] or [▼] button to select "Setting Censorship" and then press [Enter] button.

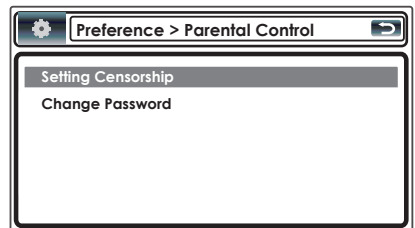

- 6 Touch [▲] or [▼] button to select Parental Level and then press [Enter] button.

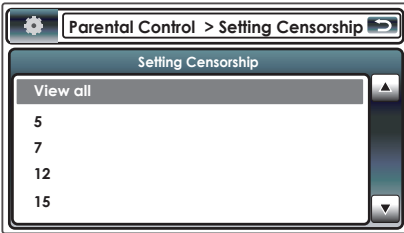

When you change the password ...

- 1 Touch [▲] or [▼] button to select "Change Password" and then press [Enter] button.

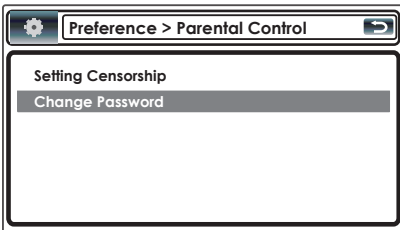

- 2 Press the number ([1] - [0]) button on the remote controller to enter new password.

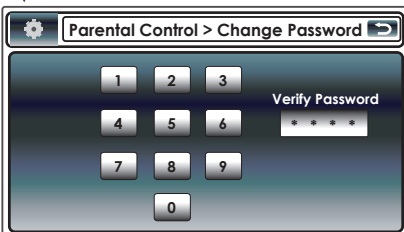
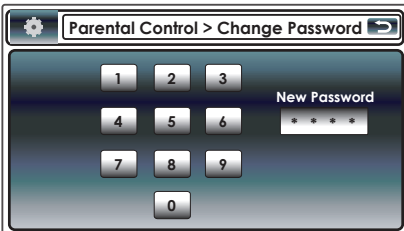

- 7 Touch [Return] button when you are finished.

Language Setup

Selects a language you use for the Menu, Audio and the Subtitle.

- 1 Show Menu Control Screen by touching [Menu] button.
- 2 Touch [◀] or [▶] button to select "Preference".
- 3 Touch [▲] or [▼] button to select "Language Setting" and then press [Enter] button.

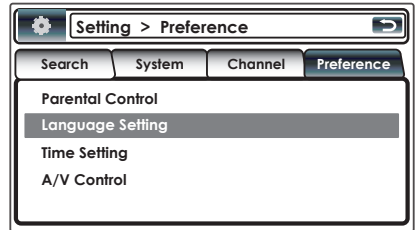

- 4 Touch [▲] or [▼] button to select sub item and then press [Enter] button.

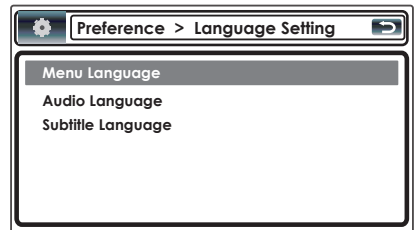

- 5 Touch [▲] or [▼] button to select Language and then press [Enter] button.

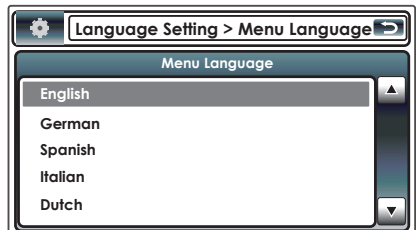

- 6 Touch [Return] button when you are finished.

Time Setup

Set the time zone of GMT (Greenwich mean time) and summer time as necessary.

- 1 Show Menu Control Screen by touching [Menu] button.
- 2 Touch [◀] or [▶] button to select "Preference".
- 3 Touch [▲] or [▼] button to select "Time Setting" and then press [Enter] button.

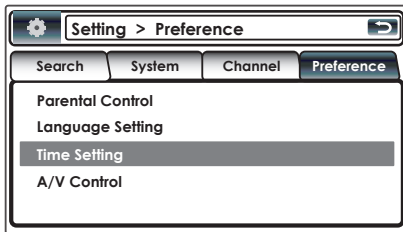

- 4 Touch [▲] or [▼] button to select "GMT Offset" and then press [Enter] button.

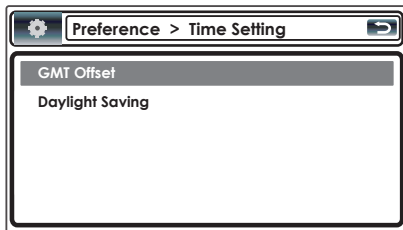

- 5 Touch [▲] or [▼] button to select GMT time and then press [Enter] button.

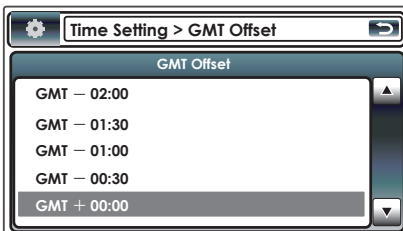

- 6 Touch [Return] button when you are finished.

AV Setup

Set the audio and video output mode.

- 1 Show Menu Control Screen by touching [Menu] button.
- 2 Touch [◀] or [▶] button to select "Preference".
- 3 Touch [▲] or [▼] button to select "A/V Control" and then press [Enter] button.

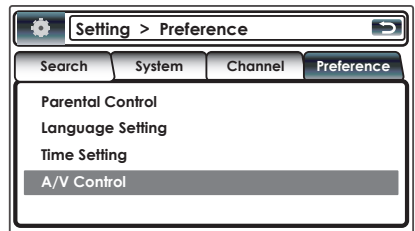

- 4 Touch [▲] or [▼] button to select "Audio Output" or "Screen Ratio" and then press [Enter] button.

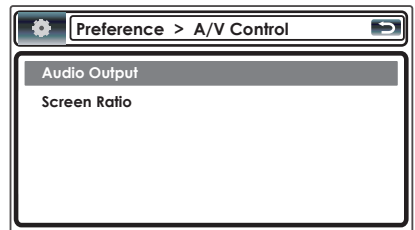

- 5 Touch [▲] or [▼] button to select Audio output and then press [Enter] button.

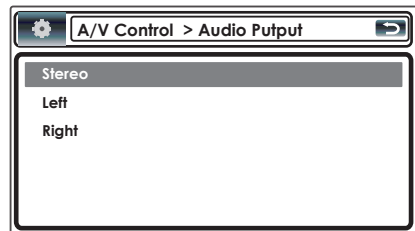

6 Touch [▲] or [▼] button to select Screen ratio and then press [Enter] button.

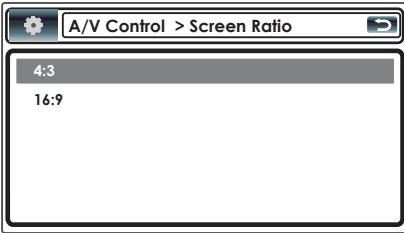

Time zone list

Continent	City	Time Difference	
Area	Hawaii	-10:00	
	Alaska	-9:00	
	Pacific Time	-8:00	
	Arizona	-7:00	
	Mountain Time	-7:00	
	Central Time	-6:00	
	Eastern time	-5:00	
	Indiana	-5:00	
	Atlantic Time	-4:00	
	Mid-Atlantic	-2:00	
	W.Central Africa	+1:00	
	City	Abu Dhabi	+4:00
		Adelaide	+9:30
		Amman	+2:00
		Amsterdam	+1:00
		Anchorage	-9:00
		Ankara	+2:00
		Athens	+2:00
		Atlanta	-5:00
Auckland		+12:00	
Baghdad		+3:00	
Baku		+4:00	
Bangkok		+7:00	
Beijing		+8:00	
Beirut		+2:00	
Berlin		+1:00	
Bogotá		-5:00	
Brasilia		-3:00	
Brussels		+1:00	
Bucharest		+2:00	
Budapest		+1:00	
Buenos Aires		-3:00	
Cairo		+2:00	
Cape Verde Is.		-1:00	
Caracas		-4:30	
Chicago		-6:00	
Copenhagen		+1:00	
Denver		-7:00	
Detroit		-5:00	
Dhaka		+6:00	
Ekaterinburg		+5:00	
Harare		+2:00	
Helsinki		+2:00	
Hong Kong		+8:00	
Islamabad	+5:00		
Istanbul	+2:00		
Jakarta	+7:00		
Jerusalem	+2:00		
Johannesburg	+2:00		
Kabul	+4:30		

Continent	City	Time Difference
	Kansas City	-6:00
	Kingston	-5:00
	Krasnoyarsk	+7:00
	Kuala Lumpur	+8:00
	Kuwait	+3:00
	Kyiv	+2:00
	Las Vegas	-8:00
	Lima	-5:00
	London	+0:00
	Los Angeles	-8:00
	Madrid	+1:00
	Magadan	+11:00
	Manila	+8:00
	Mexico City	-6:00
	Midway Is.	-11:00
	Minsk	+2:00
	Moscow	+3:00
	Nairobi	+3:00
	New Caledonia	+11:00
	New Delhi	+5:30
	New Orleans	-6:00
	New York	-5:00
	Newfoundland	-3:30
	Novosibirsk	+6:00
	Nuku'alofa	+13:00
	Oslo	+1:00
	Ottawa	-5:00
	Panama	-5:00
	Paris	+1:00
	Prague	+1:00
	Yangon	+6:30
	Rome	+1:00
	San Francisco	-8:00
	Santiago	-4:00
	Sarajevo	+1:00
	Seattle	-8:00
	Singapore	+8:00
	St. Petersburg	+3:00
	Stockholm	+1:00
	Sydney	+10:00
	Taipei	+8:00
	Tehran	+3:30
	Tokyo	+9:00
	Toronto	-5:00
	Tunis	+1:00
	Vancouver	-8:00
	Vienna	+1:00
	Warsaw	+1:00
	Zagreb	+1:00
	Zurich	+1:00

(GMT)

Displaying EPG

Receiving and displaying EPG (Electronic Program Guide) sent together with a program.

Viewing the Program Guide

You can check the programs on each channel in the EPG (Electronic Program Guide).

1 Show Menu Control Screen by touching [EPG] button.

2 Select the channel or time to display



On the EPG, you can change the displayed channel by touching [◀] or [▶] button.

(Press [◀] or [▶] button when using the remote controller.)

Time frame by touching [▲] or [▼] button.

(Press [▲] or [▼] button when using the remote controller.)

3 Select the channel or time to display

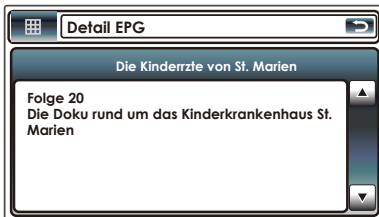

Press [ENTER] after highlighting the program to watch, then the detailed information will be displayed as shown above.

4 Touch [Return] button when you are finished.



- A "no data" message will be displayed if the selected channel does not provide EPG data.
- It can also be displayed from the Menu Control screen.

Operation of Remote Control Unit



PWR

To turn on and off this unit.

INFO

To show the carrier information of the currently selected station (toggle between pages in menu using ▲/▼/◀/▶).

EPG

Opens the Electronic Program Guide.

CH LIST

Opens the channels list.

CH ▲/▼

Changes channels (channel up, channel down).

MENU

Press once to enter Setting Menu.

The Setting Menu consists of 4 main-menus.

- Search
- System
- Channel
- Preference

▲/▼

Toggles between menu items (up/down).

◀/▶

Toggles between menu items (left/right).

ENTER

Verifies input.

RTN

- Return to the previous menu in menu screen or escape from menu.
- Return to normal TV mode from a menu. Repeated pressing will take you through all opened menus until normal TV mode is reached.
- Returns to the channel you were watching previously.

LANG

Switches Menu language.

SUBTITLE

Switches to Subtitle language.

AUDIO

Switches to Audio language.

TELETEXT

Switches to teletext.

VOL ▲/▼

To adjust volume. Volume mute only works in TV/
Radio mode.

MUTE

Mutes the sound. Volume mute only works in TV/
Radio mode.

0 - 9

- a. Selects a favorit list.
- b. Selects a sub-menu item.
- c. Selects a teletext.

SEEK

Searches the network for available channels.

Short - Manual Search

long - Automatic Search

TV/RADIO

TV/radio mode

Preparing the Remote Control Unit



Pull the battery sheet out from the remote control unit to the direction of the arrow.

Changing the battery of the remote control unit

Use a commercially available button battery (CR2025). Insert the battery with the + and - poles aligned properly, following the illustration inside the case.

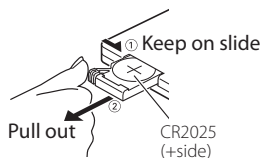

⚠ CAUTION

- Do not set the remote control in hot places such as on the dashboard.
- Lithium battery.
Danger of explosion if the battery is incorrectly replaced. Replace only with the same or equivalent type.
- The battery pack or batteries shall not be exposed to excessive heat such as sunshine, fire or the like.
- Keep battery out of reach of children and in original package until ready to use. Dispose of used batteries promptly. If swallowed contact physician immediately.

Accessories

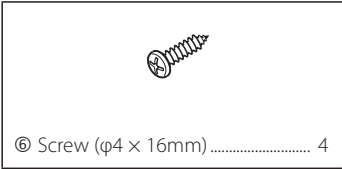
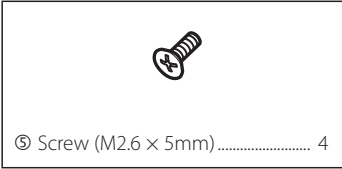
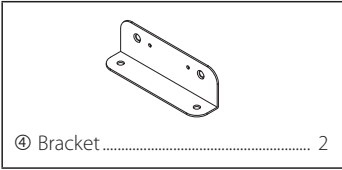
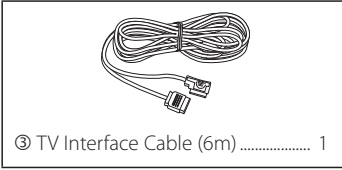
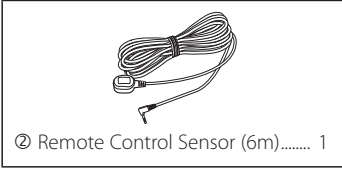
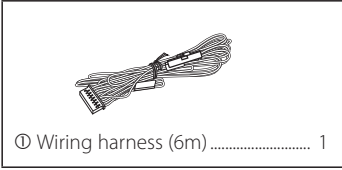

Installation

Installing the Main Unit

The Digital TV Tuner (main unit) can be installed by securing it to the pile carpet with Velcro or by screwing it on to a commercially available audio board.



- There are various terminals on the main unit. Leave some space to connect cables on the terminal side of the main unit.
- Do not place anything on top of the main unit. This can cause product failure.
- Do not install the main unit stacked with other units.
- Install the main unit at least 1.5m away from radio antenna.

Installing with Screw

1 Use a tapping screw to secure the bracket to the vehicle's audio board (commercial product).



- When drilling holes in the vehicle, be sure there is nothing on the other side.
Damage to cables or pipes can cause accident or malfunction.

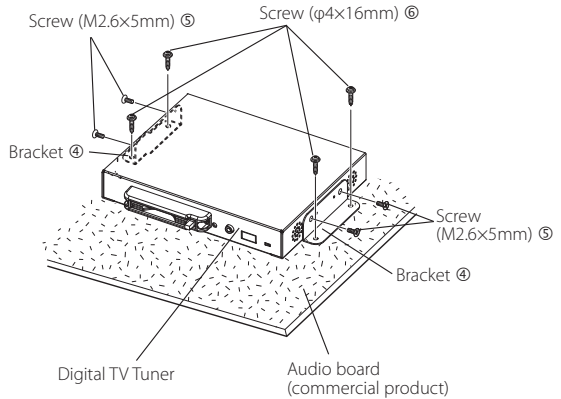

Installing the Remote Control Sensor

Paste the remote control sensor to the dashboard.

- 1 Remove the paper from double-stick tape and paste it on the back of the remote control sensor.
- 2 Wipe the dirt and oil off from the installation area and paste the remote control sensor ② to the dashboard.

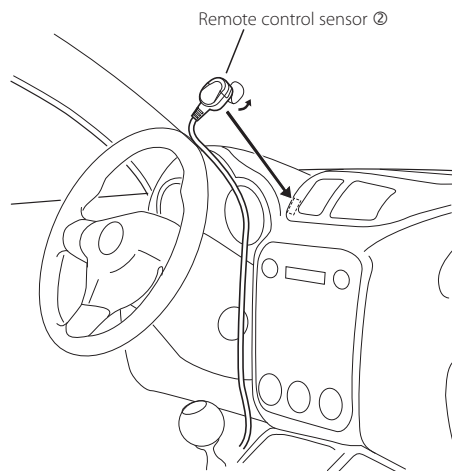

- Wipe oil and dirt off from the installation surface.
- Avoid area where there is direct sunlight or close to TV monitor because the remote control signals may be affected.

Inserting CA Card and CAM

Insert the CA card (Conditional Access card) and CAM (Conditional Access Module) into the card slot.

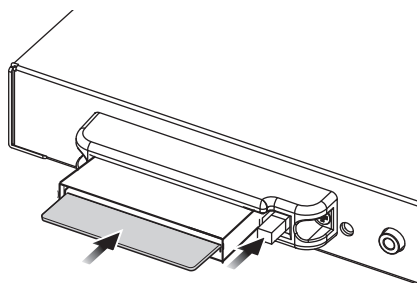

- CA card (Conditional Access card) and CAM (Conditional Access Module) is optional (sold separately).
- When CA card and CAM are inserted in this unit, CA card and CAM protrude from a unit. Take well care about an installation position.
- When you insert or draw out a CA card and CAM in the slot of this unit, be sure to ACC OFF.
- When you insert or draw out a CA card and CAM, keep it horizontally.
- Eject or insert the CA card or CA module before turning on the power.
- Do not leave this device inside the car. The temperature inside the car may rise rapidly, and CA card or other parts may be deformed or become unusable due to the heat inside the car. There is also the danger of theft.

Connection

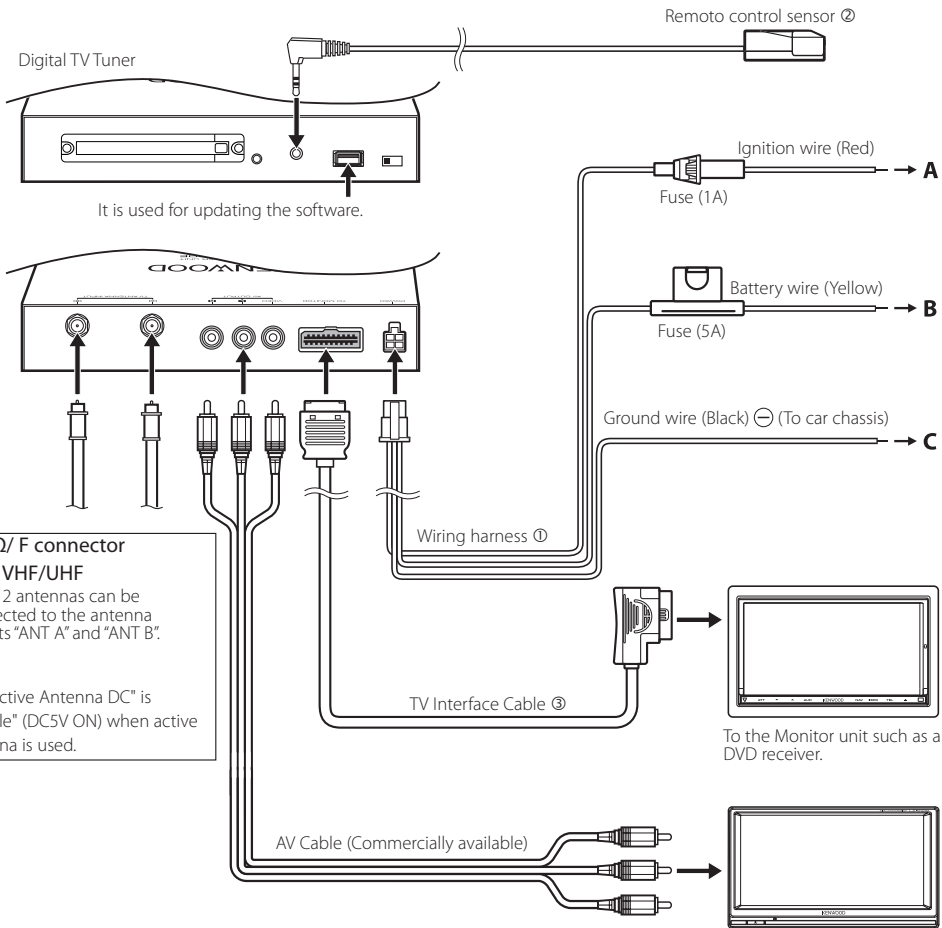

- 75Ω / F connector
- For VHF/UHF

Up to 2 antennas can be connected to the antenna sockets "ANT A" and "ANT B".

Set "Active Antenna DC" is "Enable" (DCSV ON) when active antenna is used.

VIDEO: Yellow
AUDIO (L): White
AUDIO (R): Red

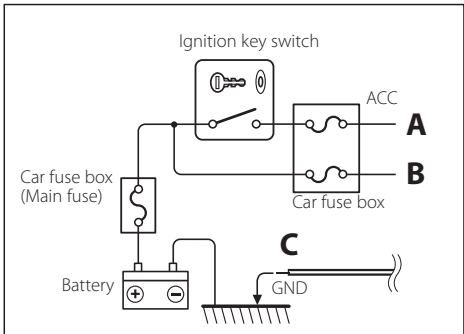

LZ-612IR Operation

LZ-612IR Setup1

- 1 Enter Select screen mode**
Touch the display window.

- 2 Select the function**
Touch the function button.



Display	Function
PAGE	Move to the DVB-T Tuner unit Setup Screen 2.
MENU	Move to Monitor Setting screen .
PWR	To turn on and off this unit.
AVIN	Change AV1 / AV2 input source.
MUTE	Mutes the sound. Volume mute only works in TV/Radio mode.
INFO	To show the carrier information of the currently selected station (toggle between pages in menu using ▲/▼/◀/▶).
VOL▲/VOL▼	To adjust volume. Volume mute only works in TV/ Radio mode.
CH▲/CH▼	Changes channels (channel up, channel down).
RTN	a. Return to the previous menu in menu screen or escape from menu. b. Return to normal TV mode from a menu. Repeated pressing will take you through all opened menus until normal TV mode is reached. c. Returns to the channel you were watching previously.
ENT	Verifies input.

- 3 Exit DVB-T Tuner unit Control mode**
Touch the screen except function button.



- The relevant OSD is displayed only when the DVB-T Control in <Other Setting> (page 7 In LZ-612IR Manual) is turned on.
- You can operate the Kenwood DVB-T Tuner unit connected to the Hideaway box when the DVB-T Control is turned on.

LZ-612IR Setup2

- 1 Enter Select screen mode**
Touch the display window.

- 2 Select the function**
Touch the function button.



Display	Function
PAGE	Move to the DVB-T Tuner unit Setup Screen 1.
EPG	Opens the Electronic Program Guide.
TV.M	Press once to enter TV Setting Menu.
CH.L	Opens the channels list.
TV/R	TV/radio mode.
SEEK	Searches the network for available channels. Short - Manual Search long - Automatic Search
▲/▼	Toggles between menu items (up/down).
◀/▶	Toggles between menu items (left/right).
RTN	a. Return to the previous menu in menu screen or escape from menu. b. Return to normal TV mode from a menu. Repeated pressing will take you through all opened menus until normal TV mode is reached. c. Returns to the channel you were watching previously.
ENT	Verifies input.

- 3 Exit DVB-T Tuner unit Control mode**
Touch the screen except function button.



- The relevant OSD is displayed only when the DVB-T Control in <Other Setting> (page 7 In LZ-612IR Manual) is turned on.
- You can operate the Kenwood DVB-T Tuner unit connected to the Hideaway box when the DVB-T Control is turned on.

LZ-612IR Connection

Specifications

System Connection with LZ-612IR

LZ-612IR Hiway Unit

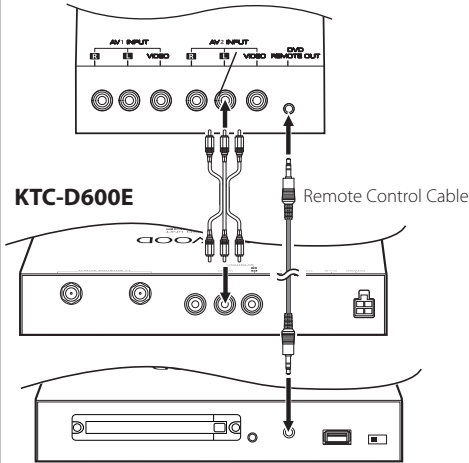

- Connect the audio/video output of KTC-D600E to "AV2 INPUT" of LZ-612IR.
- Use the remote control cable of LZ-612IR to connect the remote input terminal of KTC-D600E and "DVD Remote Out" terminal of LZ-612IR.

TV tuner

Input Frequency

VHF : 174 – 230 MHz
UHF : 470 – 862 MHz

Demodulation Type

: QPSK/ 64QAM/ 16QAM

Channel Bandwidth

: 7/ 8 MHz

FFT Size

: 2K and 8K

Guard Interval

: 1/4, 1/8, 1/16, 1/32

Puncture Rate

: 1/2, 2/3, 3/4, 5/6, 7/8

Antenna input

: 2-ch Diversity

Connector Type

: F Type × 2

General

Operating Voltage (10.5-16V)

: 14.4 V

Current Consumption

: 400 mA

Dimensions (W × D × H) (Main unit)

: 188 × 144 × 30 mm

Operational temperature range

: -10°C ~ +60 °C

Storage temperature range

: -30°C ~ +85 °C

Weight

: 0.9 kg

Specifications subject to change without notice.



Declaration of Conformity with regard to the EMC Directive 2004/108/EC

Manufacturer:

Kenwood Corporation
2967-3 Ishikawa-machi, Hachioji-shi, Tokyo, 192-8525
Japan

EU Representative's:

Kenwood Electronics Europe BV
Amsterdamseweg 37, 1422 AC UITHOORN, The
Netherlands

This Product is not installed by the manufacturer of a vehicle on the production line, nor by the professional importer of a vehicle into an EU Member State.

Information on Disposal of Old Electrical and Electronic Equipment and Batteries (applicable for EU countries that have adopted separate waste collection systems)



Products and batteries with the symbol (crossed-out wheeled bin) cannot be disposed as household waste. Old electrical and electronic equipment and batteries should be recycled at a facility capable of handling these items and their waste byproducts.



Pb

Contact your local authority for details in locating a recycle facility nearest to you. Proper recycling and waste disposal will help conserve resources whilst preventing detrimental effects on our health and the environment.

Notice: The sign "Pb" below the symbol for batteries indicates that this battery contains lead.

For Turkey

Bu ürün 26891 sayılı Resmi Gazete'de yayımlanan Elektrikli ve Elektronik Eşyalarda Bazı Zararlı Maddelerin Kullanımının Sınırlandırılmasına Dair Yönetmeliğe uygun olarak üretilmiştir.

This product complies with Directive, Number 26891 regarding "REGULATION ON THE RESTRICTION OF THE USE OF CERTAIN HAZARDOUS SUBSTANCES IN ELECTRICAL AND ELECTRONIC EQUIPMENT".



This symbol mark indicates that Kenwood manufactured this product so as to decrease harmful influence on the environment.

DVB is a registered trademark of the DVB Project.

KENWOOD