



LG

Life's Good

OWNER'S MANUAL

Color Video Camera

Please read this manual carefully before operating your set and retain it for future reference.

MODEL
LD120P
LD120N

P/NO : MFL62723786



CAUTION: TO REDUCE THE RISK OF ELECTRIC SHOCK
DO NOT REMOVE COVER (OR BACK)
NO USER-SERVICEABLE PARTS INSIDE
REFER SERVICING TO QUALIFIED SERVICE PERSONNEL.



This lightning flash with arrowhead symbol within an equilateral triangle is intended to alert the user to the presence of uninsulated dangerous voltage within the product's enclosure that may be of sufficient magnitude to constitute a risk of electric shock to persons.



The exclamation point within an equilateral triangle is intended to alert the user to the presence of important operating and maintenance (servicing) instructions in the literature accompanying the product.

FCC WARNING : This equipment may generate or use radio frequency energy. Changes or modifications to this equipment may cause harmful interference unless the modifications are expressly approved in the instruction manual. The user could lose the authority to operate this equipment if an unauthorized change or modification is made.

Regulatory Notices For U.S.A

This equipment has been tested and found to comply with the limits for a Class B digital device, pursuant to Part 15 of the FCC Rules. These limits are designed to provide reasonable protection against harmful interference when the equipment is operated in a commercial environment.

This equipment generates, uses, and can radiate radio frequency energy and, if not installed and used in accordance with the instruction manual, may cause harmful interference to radio communications.

Operation of this equipment in a residential area is likely to cause harmful interference in which case the user will be required to correct the interference at his own expense.

- A suitable conduit entries, knock-outs or glands shall be provided in the cable entries of this product in the end user.
- Caution: Danger of explosion if battery is incorrectly replaced. Replaced only with the same or equivalent type recommended by the manufacturer. Dispose of used batteries according to the manufacturer's instructions.
- Holes in metal, through which insulated wires pass, shall have smooth well rounded surfaces or shall be provided with brushings.

Warning: Do not install this equipment in a confined space such as a bookcase or similar unit.

Warning: Wiring methods shall be in accordance with the National Electric Code, ANSI/NFPA 70.

Warning: This is a class B product. In a domestic environment this product may cause radio interference in which case the user may be required to take adequate measures.

Warning: To reduce a risk of fire or electric shock, do not expose this product to rain or moisture.

Caution: This installation should be made by a qualified service person and should conform to all local codes.

Caution: To avoid electrical shock, do not open the cabinet. Refer servicing to qualified personnel only.

Caution: The apparatus should not be exposed to water (dripping or splashing) and no objects filled with liquids, such as vases, should be placed on the apparatus.

Important Safety Instructions

- 1. Read these instructions.** - All these safety and operating instructions should be read before the product is operated.
- 2. Keep these instructions.** - The safety, operating and use instructions should be retained for future reference.
- 3. Heed all warnings.** - All warnings on the product and in the operating instructions should be adhered to.
- 4. Follow all instructions.** - All operating and use instructions should be followed.
- 5. Do not use this apparatus near water.** - For example: near a bath tub, wash bowl, kitchen sink, laundry tub, in a wet basement; near a swimming pool; etc.
- 6. Clean only with dry cloth.** - Unplug this product from the wall outlet before cleaning. Do not use liquid cleaners.
- 7. Do not block any ventilation openings. Install in accordance with the manufacturer's instructions.** - Slots and openings in the cabinet are provided for ventilation, to ensure reliable operation of the product, and to protect it from over- heating. The openings should never be blocked by placing the product on a bed, sofa, rug or other similar surface. This product should not be placed in a built-in installation such as a bookcase or rack unless proper ventilation is provided and the manufacturer's instructions have been adhered to.
- 8. Do not install near any heat sources such as radiators, heat registers, stoves, or other apparatus (including amplifiers) that produce heat.**

Important Safety Instructions

- Do not defeat the safety purpose of the polarized or grounding-type plug. A polarized plug has two blades with one wider than the other. A grounding type plug has two blades and a third grounding prong. The wide blade or the third prong are provided for your safety. If the provided plug does not fit into your outlet, consult an electrician for replacement of the obsolete outlet.
- Protect the power cord from being walked on or pinched particularly at plugs, convenience receptacles, and the point where they exit from the apparatus.
- Only use attachments/accessories specified by the manufacturer.
- Use only the cart, stand, tripod, bracket, or table specified by the manufacturer, or sold with apparatus. When a cart is used, use caution when moving the cart/ apparatus combination to avoid injury from tip-over.
- Unplug this apparatus during lightning storms or when unused for long periods of time.
- Refer all servicing to qualified service personnel. Servicing is required when the apparatus has been damaged in any way, such as power-supply cord or plug is damaged, liquid has been spilled or objects have fallen into the apparatus, the apparatus has been exposed to rain or moisture, does not operate normally, or has been dropped.



Safety Precautions

Do not attempt to disassemble the camera

To prevent electric shock, do not remove screws or covers. There are no user serviceable parts inside. Ask a qualified service personnel for servicing.

Do not use strong solvents or detergents

Use a dry cloth to the camera when it is dirty. If it is hard to remove the dirt on the camera, use a mild detergent and wipe it gently.

Before operating, please check proper temperature, humidity and power source ratings.

Use the camera under conditions where temperature is between -10°C to $+50^{\circ}\text{C}$.

Do not expose the camera in such conditions as shown below.

Use in a room or area filled with cigarette smoke, dust or gas.

Avoid the camera with direct sunlight

Do not aim the camera at bright objects. Never face it with direct sunlight or other extremely bright objects. Otherwise blooming or smear may be caused.

Handle the camera with care

Do not abuse the camera. Avoid striking, shaking, etc. The camera could be damaged by improper handling or storage.

Do not expose the camera to rain or moisture

This product is designed for indoor use or location where it is protected from rain and moisture. When exposed to moisture, turn the power off immediately and ask a qualified service personnel for servicing. Moisture can damage the camera and also create the danger of electric shock.

What's in the box

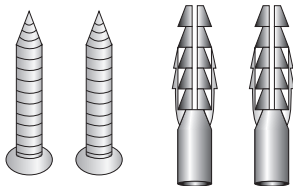
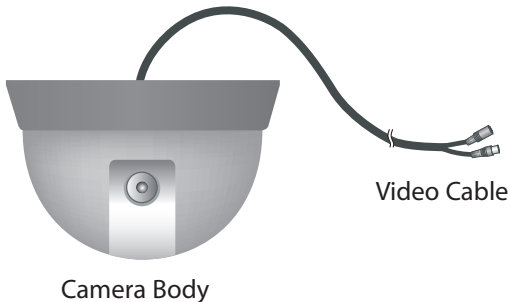

M3 Tapping Screws (2 EA)
(Pan Lock Screw)

Construction

Front View

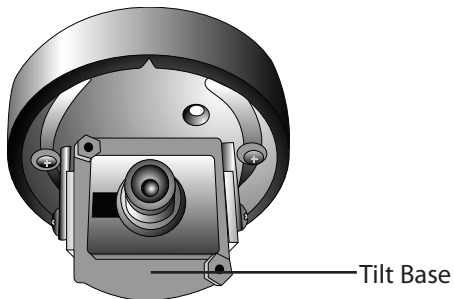

Side View

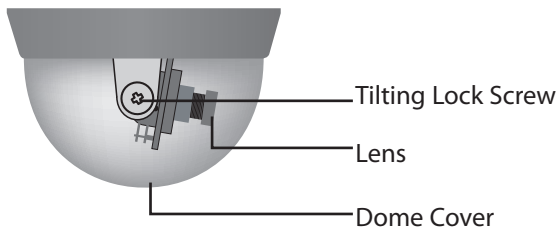

Installation

Camera Installation

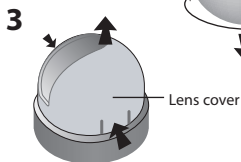
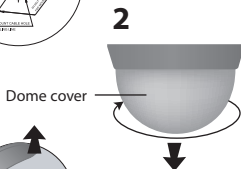
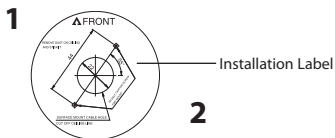

4~6

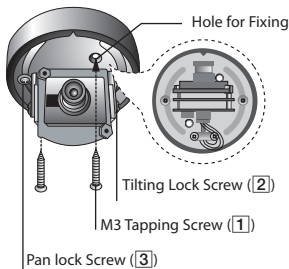

1. Use the installation label to check the place that you wish to install.
2. Turn the Dome Cover counterclockwise simultaneously.
3. Remove the Lens cover.
4. Aim the LG logo of the Dome Camera to face the place that you wish to watch.
5. Tighten the M3 Tapping Screws (1) to fix the Dome Camera on the ceiling.
6. Loosen the Tilting Lock Screw (2). Adjust the Tilt (Up/Down) then tighten Tilting Lock Screw. If you need to adjust the Pan, Loose the Pan Lock Screw (3). Adjust the Pan (Left/Right) then tight the Pan Lock Screw.
7. Install the Lens cover.
8. Install the Dome Cover to the main body by turning it clockwise.

Notes

- When you install the camera, handle with care. The camera could be damaged by improper handling or storage.
- If this camera is mounted on the other places except ceiling, you need an extra bracket for mounting. (not supplied)

Installation

Camera Connection

Connect the Power Adapter (12 V, 300 mA; optional) to the Power Input Jack of the camera as shown below.

Cautions for Safe Operation

This camera must be operated a DC 12 V Certified/listed, class 2 power supply.

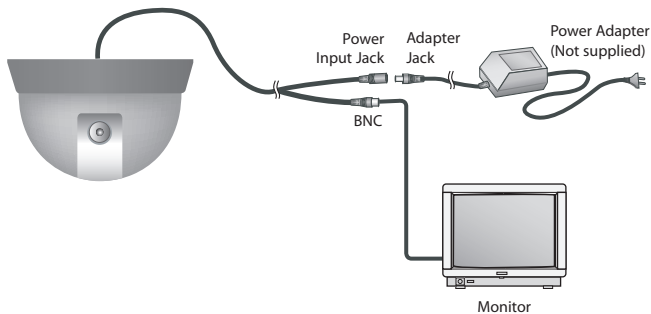

Setup

4-pin Dip Switch Setting

This camera has the 4-pin Dip Switch for setting.

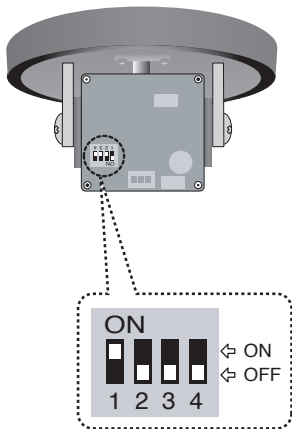

1. AGC (Auto Gain Control)

- ON : If the image is too dark, increase the AGC value to make the image bright.
- OFF : Not used.

2. BLC (Back Light Compensation)

- ON : Sets to this position when strong light comes in behind the target.
- OFF : Normal position.

3. HSBLC

- ON : Use for masking brightness of the specific area to view the subject more clearly.
- OFF : Not used.

4. WIDE BLC

- ON : Use WIDE BLC option to view the object clearly in strong backlight conditions.
- OFF : Not used.

Troubleshooting

Check the following guide for the possible cause of a problem before contacting service.

The picture is poor

Does the Dome Cover have lots of dust on the surface?

- Use a dry cloth to clean the camera when it is dirty. Smear may be caused to the screen of night than daytime.
- Adjust the Focus by moving the Focus Lens.

Contrast of the screen is not clear.

Check the condition of the monitor. A light source such as a spot light causes burn-in on the display screen. Adjust position or angle of the camera to eliminate strong background light.

Background screen appears white extremely.

You can set the background compensation to OFF.

Dimension

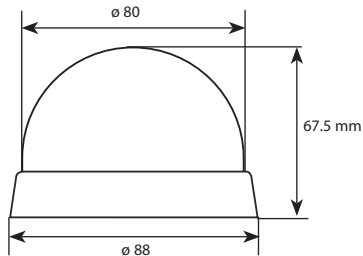

Specifications

Model	LD120N	LD120P
Signal System	NTSC	PAL
Total / Effective Pixels	410 000 Pixel / 380 000 Pixel	470 000 Pixel / 440 000 Pixel
Pick-Up Device	6 mm Super Had CCD II	
Lens	3.6 mm(C1) / 2.5 mm(A1)	
Day / Night	Auto	
Scanning System	2 : 1 Interlace	
Scanning Frequency	59.94 Hz(VD)	50 Hz(VD)
Resolution	More than 540 TV Lines	
S/N Ratio	More than 48 dB	
Minimum Illuminance	0.05 lx	
Video Output Signal	CVBS 1 Vp-p (75 Ω)	
Shutter Speed	AUTO (1/60 to 1/100 000 SEC)	AUTO (1/50 to 1/100 000 SEC)
Dip switch	AGC/BLC/HSBLC/WIDE BLC	
Power Source	DC 12 V	
Power Consumption	Less than 1.15 W	
Operating Temp.	-10 °C to 50 °C, 0 % RH to 80 % RH	
Storage Temp.	-20 °C to 60 °C, 0 % RH to 80 % RH	
Weight	170 g	
Dimensions	ø(80 + 88) x 67.5 mm	







