

Table of Contents

Introduction	4
Instrument Cluster	10
Warning and control lights	10
Gauges	15
Entertainment Systems	18
AM/FM stereo cassette with CD	18
AM/FM stereo with CD	27
Navigation system	41
Climate Controls	92
Electronic automatic temperature control	92
Lights	101
Headlamps	101
Turn signal control	106
Bulb replacement	107
Driver Controls	116
Windshield wiper/washer control	116
Power windows	121
Mirrors	124
Speed control	128
Message center	139
Locks and Security	157
Keys	157
Locks	157
Anti-theft system	157

Table of Contents

Seating and Safety Restraints	174
Seating	174
Safety restraints	186
Air bags	196
Child restraints	203
Driving	215
Starting	215
Brakes	218
Traction control/AdvanceTrac	221
Transmission operation	225
Vehicle loading	242
Trailer towing	244
Roadside Emergencies	251
Getting roadside assistance	251
Hazard flasher switch	252
Fuel pump shut-off switch	252
Fuses and relays	253
Changing tires	262
Jump starting	270
Wrecker towing	275
Customer Assistance	276
Reporting safety defects (U.S. only)	285
Cleaning	286

Table of Contents

Maintenance and Specifications	292
Hood	293
Engine compartment	294
Engine oil	295
Battery	299
Fuel information	305
Part numbers	320
Refill capacities	321
Lubricant specifications	323
Accessories	328
Index	331

All rights reserved. Reproduction by any means, electronic or mechanical including photocopying, recording or by any information storage and retrieval system or translation in whole or part is not permitted without written authorization from Ford Motor Company. Ford may change the contents without notice and without incurring obligation.

Copyright © 2003 Ford Motor Company

Introduction

CALIFORNIA Proposition 65 Warning



WARNING: Engine exhaust, some of its constituents, and certain vehicle components contain or emit chemicals known to the State of California to cause cancer and birth defects or other reproductive harm. In addition, certain fluids contained in vehicles and certain products of component wear contain or emit chemicals known to the State of California to cause cancer and birth defects or other reproductive harm.

CONGRATULATIONS

Congratulations on acquiring your new Lincoln. Please take the time to get well acquainted with your vehicle by reading this handbook. The more you know and understand about your vehicle the greater the safety and pleasure you will derive from driving it.

For more information on Ford Motor Company and its products visit the following website:

- In the United States: www.ford.com
- In Canada: www.ford.ca
- In Mexico: www.ford.com.mx
- In Australia: www.ford.com.au

Additional owner information is given in separate publications.

This Owner's Guide describes every option and model variant available and therefore some of the items covered may not apply to your particular vehicle. Furthermore, due to printing cycles it may describe options before they are generally available.

Remember to pass on the Owner's Guide when reselling the vehicle. It is an integral part of the vehicle.



Fuel pump shut-off switch In the event of an accident the safety switch will automatically cut off the fuel supply to the engine. The switch can also be activated through sudden vibration (e.g. collision when parking). To reset the switch, refer to the *Fuel pump shut-off switch* in the *Roadside emergencies* chapter.

SAFETY AND ENVIRONMENT PROTECTION

Warning symbols in this guide

How can you reduce the risk of personal injury and prevent possible damage to others, your vehicle and its equipment? In this guide, answers to such questions are contained in comments highlighted by the warning triangle symbol. These comments should be read and observed.

Warning symbols on your vehicle

When you see this symbol, it is imperative that you consult the relevant section of this guide before touching or attempting adjustment of any kind.



Protecting the environment

We must all play our part in protecting the environment. Correct vehicle usage and the authorized disposal of waste cleaning and lubrication materials are significant steps towards this aim. Information in this respect is highlighted in this guide with the tree symbol.



BREAKING-IN YOUR VEHICLE

Your vehicle does not need an extensive break-in. Try not to drive continuously at the same speed for the first 1,600 km (1,000 miles) of new vehicle operation. Vary your speed to allow parts to adjust themselves to other parts.

Drive your new vehicle at least 800 km (500 miles) before towing a trailer.

Do not add friction modifier compounds or special break-in oils during the first few thousand kilometers (miles) of operation, since these additives may prevent piston ring seating. See *Engine oil* in the *Maintenance and specifications* chapter for more information on oil usage.

Introduction

SPECIAL NOTICES

Emission warranty

The New Vehicle Limited Warranty includes Bumper-to-Bumper Coverage, Safety Restraint Coverage, Corrosion Coverage, and 7.3L Power Stroke Diesel Engine Coverage. In addition, your vehicle is eligible for Emissions Defect and Emissions Performance Warranties. For a detailed description of what is covered and what is not covered, refer to the *Warranty Guide* that is provided to you along with your Owner's Guide.

Data Recording

Computers in your vehicle are capable of recording detailed data potentially including but not limited to information such as:

- the use of restraint systems including seat belts by the driver and passengers,
- information about the performance of various systems and modules in the vehicle, and
- information related to engine, throttle, steering, brake or other system status.

Any of this information could potentially include information regarding how the driver operates the vehicle potentially including but not limited to information regarding vehicle speed, brake or accelerator application or steering input. This information may be stored during regular operation or in a crash or near crash event.

This stored information may be read out and used by:

- Ford Motor Company.
- service and repair facilities.
- law enforcement or government agencies.
- others who may assert a right or obtain your consent to know such information.

Special instructions

For your added safety, your vehicle is fitted with sophisticated electronic controls.



Please read the section *Supplemental Restraint System (SRS)* in the *Seating and safety restraints* chapter. Failure to follow the specific warnings and instructions could result in personal injury.

Introduction



Front seat mounted rear facing child or infant seats should **NEVER** be used in front of a passenger side air bag unless the air bag can be and is turned OFF.

Notice to owners of pickup trucks and utility type vehicles



Utility vehicles have a significantly higher rollover rate than other types of vehicles.

Before you drive your vehicle, please read this Owner's Guide carefully. Your vehicle is not a passenger car. As with other vehicles of this type, failure to operate this vehicle correctly may result in loss of vehicle control, vehicle rollover, personal injury or death.

Be sure to read *Driving off road* in the *Driving* chapter.

Using your vehicle with a snowplow



Do not use this vehicle for snowplowing.

Using your vehicle as an ambulance



Do not use this vehicle as an ambulance.

Your vehicle is not equipped with the Ford Ambulance Preparation Package.

Middle East/North Africa vehicle specific information

For your particular global region, your vehicle may be equipped with features and options that are different from the ones that are described in this Owner Guide; therefore, a supplement has been supplied that complements this book. By referring to the pages in the provided supplement, you can properly identify those features, recommendations and specifications that are unique to your vehicle. **Refer to this Owner Guide for all other required information and warnings.**

Introduction























These are some of the symbols you may see on your vehicle.

Vehicle Symbol Glossary

Safety Alert		See Owner's Guide	
Fasten Safety Belt		Air Bag-Front	
Air Bag-Side		Child Seat	
Child Seat Installation Warning		Child Seat Lower Anchor	
Child Seat Tether Anchor		Brake System	
Anti-Lock Brake System		Brake Fluid - Non-Petroleum Based	
Traction Control		AdvanceTrac [™]	
Master Lighting Switch		Hazard Warning Flasher	
Fog Lamps-Front		Fuse Compartment	
Fuel Pump Reset		Windshield Wash/Wipe	
Windshield Defrost/Demist		Rear Window Defrost/Demist	

Introduction

Vehicle Symbol Glossary

Power Windows Front/Rear		Power Window Lockout	
Child Safety Door Lock/Unlock		Interior Luggage Compartment Release Symbol	
Panic Alarm		Engine Oil	
Engine Coolant		Engine Coolant Temperature	
Do Not Open When Hot		Battery	
Avoid Smoking, Flames, or Sparks		Battery Acid	
Explosive Gas		Fan Warning	
Power Steering Fluid		Maintain Correct Fluid Level	
Emission System		Engine Air Filter	
Passenger Compartment Air Filter		Jack	
Check fuel cap		Low tire warning	

Instrument Cluster

WARNING LIGHTS AND CHIMES

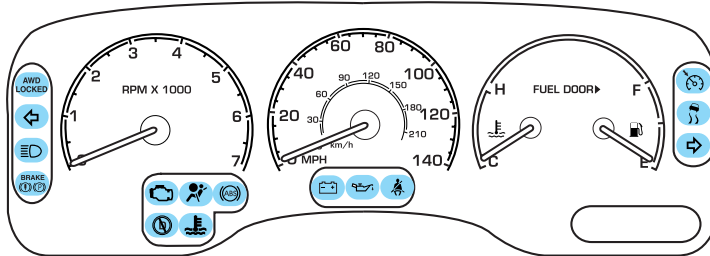

Warning lights and gauges can alert you to a vehicle condition that may become serious enough to cause expensive repairs. A warning light may illuminate when a problem exists with one of your vehicle's functions. Many lights will illuminate when you start your vehicle to make sure the bulb works. **If any light remains on after starting the vehicle, have the respective system inspected immediately.**

Service engine soon

The  light illuminates briefly to ensure the system is functional. If it comes on after the engine is started, one of the engine's emission control systems may be malfunctioning. The light may illuminate without a driveability concern being noted. The vehicle will usually be drivable and will not require towing.

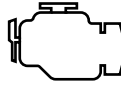

Light remains on:

Temporary malfunctions may cause your  light to illuminate. Examples are:

1. The vehicle has run out of fuel.
2. Poor fuel quality or water in the fuel.
3. The fuel cap may not have been properly installed and securely tightened.

These temporary malfunctions can be corrected by filling the fuel tank with high quality fuel of the recommended octane and/or properly installing and securely tightening the fuel cap. After three driving cycles without these or any other temporary malfunctions present, the  light should turn off. (A driving cycle consists of a cold engine startup followed by mixed city/highway driving.) No additional vehicle service is required.

Instrument Cluster

If the  light remains on, have your vehicle serviced at the first available opportunity.

Note: The  light will illuminate if vehicle refueling is conducted with the engine running.



Never refuel vehicle with the engine running.

Light is blinking:

Engine misfire is occurring which could damage your catalytic converter. You should drive in a moderate fashion (avoid heavy acceleration and deceleration) and have your vehicle serviced at the first available opportunity.



Under engine misfire conditions, excessive exhaust temperatures could damage the catalytic converter, the fuel system, interior floor coverings or other vehicle components, possibly causing a fire.

Brake system warning

To confirm the brake system warning light is functional, it will momentarily illuminate when the ignition is turned to the ON position (alternatively for some vehicles when the ignition is moved from the ON position to START position, the light will momentarily illuminate prior to reaching the START position). It also illuminates if the parking brake is engaged. If the brake system warning light does not illuminate as described, seek service immediately. Illumination after the parking brake is released indicates low brake fluid level or a brake system malfunction and the brake system should be serviced immediately by a qualified technician.

Refer to *Brakes* in the *Driving* chapter for more information.



Anti-lock brake system (ABS)

To confirm the anti-lock brake system (ABS) warning light is functional it will momentarily illuminate when the ignition is turned to the ON position (alternatively for some vehicles when the ignition is moved from the ON



Instrument Cluster

position to the START position, the light will momentarily illuminate just prior to reaching the START position). If the light remains on, continues to flash or fails to illuminate, have the ABS serviced immediately. If the ABS light remains on, it means the anti-lock brake system has malfunctioned and is disabled, however, the normal brake system will still function unless the brake warning light also remains illuminated and parking brake is off. Refer to *Brakes* in the *Driving* chapter for more information.

Safety belt

Illuminates to remind you to fasten your safety belts. For more information, refer to the *Seating and safety restraints* chapter.



Air bag readiness

Illuminates to confirm that the air bags (front or side) are operational. If the light fails to illuminate, continues to flash or remains on, have the system serviced immediately.



Charging system

Illuminates when the battery is not charging properly.



AdvanceTrac™ (if equipped)

Flashes when the AdvanceTrac™ system is active. If the light remains on, have the system serviced immediately.

For more information, refer to the *Driving* chapter.



Engine oil pressure

Illuminates when the oil pressure falls below the normal range. Check the oil level and add oil if needed. Refer to *Engine oil* in the *Maintenance and specifications* chapter.



Instrument Cluster

Speed control

Illuminates when the speed control is activated.

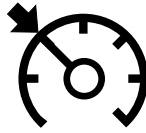

Engine coolant temperature

Illuminates when the engine coolant temperature is high. Stop the vehicle as soon as safely possible, switch off the engine and let it cool.



Never remove the coolant recovery cap while the engine is running or hot.

Refer to *Engine coolant* in the *Maintenance and specifications* chapter. If light stays on or continues to turn on after the vehicle warms up, have your vehicle serviced.

Turn signals

Illuminates when the turn signals or the hazard lights are turned on. If the lights stay on continuously or flash faster, check for a burned-out bulb.



High beams

Illuminates when the high beam headlamps are turned on.



O/D off

Illuminates when the overdrive function has been cancelled by using the Transmission Control Switch (TCS) on the side of the gear shift, refer to *Automatic transmission* in the *Driving* chapter. This lamp will flash if a transmission concern is detected. To prevent additional transmission damage have your vehicle serviced as soon as possible.



Instrument Cluster

AWD locked (if equipped)

Illuminates when all wheel drive (AWD) is locked. If the light continues to flash have the system serviced.

**AWD
LOCKED**

Safety belt warning chime

Sounds to remind you to fasten your safety belts.

BeltMinder™ chime

Sounds intermittently to remind you to fasten your safety belts.

Supplemental restraint system (SRS) warning chime

Sounds when a malfunction in the supplemental restraint system (front or side airbags) has been detected. Have the supplemental restraint system inspected immediately.

Headlamps on warning chime

Sounds when the headlamps or parking lamps are on, the key is removed from the ignition and the driver's door is opened.

Key-in-ignition warning chime

Sounds when the key is left in the ignition and the driver's door is opened.

Door ajar warning chime

Sounds when any door or liftgate is opened (or not fully closed).

Instrument Cluster

GAUGES

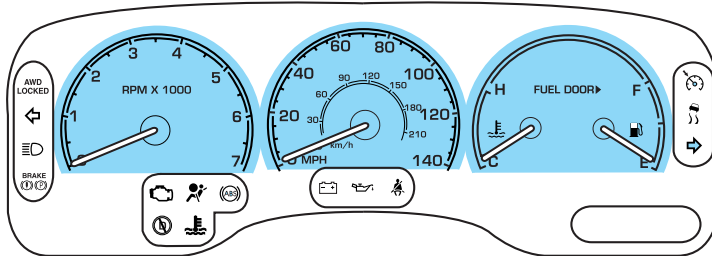

Engine coolant temperature gauge

Indicates the temperature of the engine coolant. At normal operating temperature, the needle remains within the normal area (the area between the “H” and “C”). If it enters the red section, the engine is overheating. Stop the vehicle as soon as safely possible, switch off the engine immediately and let the engine cool. Refer to *Engine coolant* in the *Maintenance and specifications* chapter.

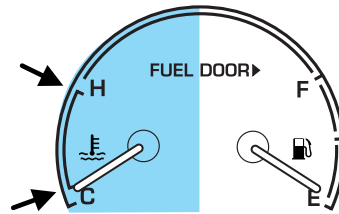

Never remove the coolant reservoir cap while the engine is running or hot. Steam and scalding liquid from a hot cooling system can burn you badly.

This gauge indicates the temperature of the engine coolant, not the coolant level. If the coolant is not at its proper level the gauge indication will not be accurate. If the gauge enters the red section, the oil pressure/engine coolant and *Check Engine/Service Engine Soon* indicators illuminate, refer to *What you should know about fail-safe cooling* in the *Maintenance and specifications* chapter.

Instrument Cluster

Fuel gauge

Displays approximately how much fuel is in the fuel tank. The fuel gauge may vary slightly when the vehicle is in motion or on a grade.

When refueling the vehicle from empty indication, the amount of fuel that can be added will be less than the advertised capacity due to the reserve fuel.

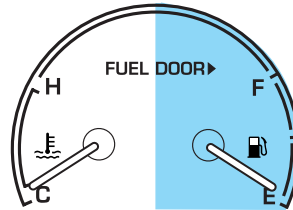

If the key is left in the ON position during fueling, a minimum of 22.2 L (six gallons) must be added to the fuel tank in order for the gauge to instantaneously update. If less than six gallons is added, the gauge will take between five to twenty minutes to update.

Speedometer

Indicates the current vehicle speed.

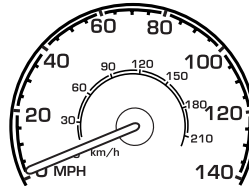

Odometer

Registers the total kilometers (miles) of the vehicle.

MESSAGE CENTER



Trip odometer

Registers the kilometers (miles) of individual journeys. Press and release the message center INFO button until 'Trip' appears in the display (this represents the trip mode). Press and hold the RESET button for three seconds to reset.

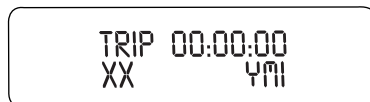

Instrument Cluster

Tachometer

Indicates the engine speed in revolutions per minute.

Driving with your tachometer pointer continuously at the top of the scale may damage the engine.

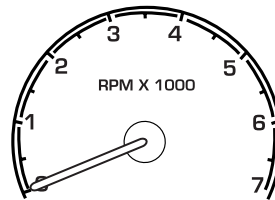

Entertainment Systems

PREMIUM AM/FM STEREO/CASSETTE/SINGLE CD

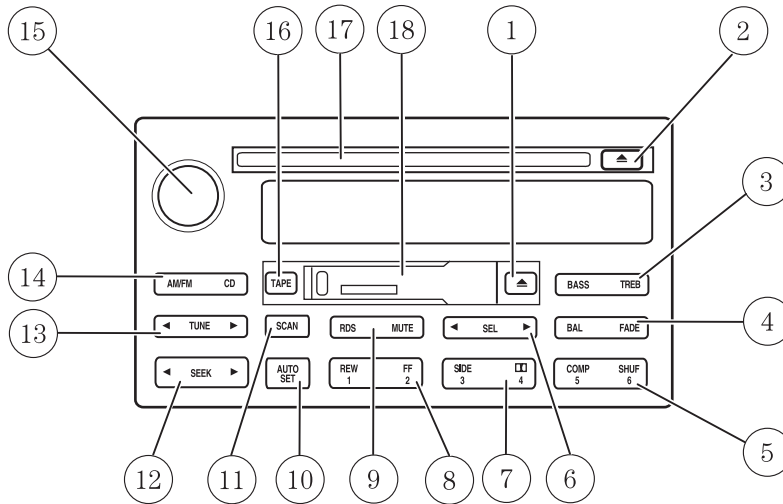

- | | |
|---------------------------------|--------------------------|
| 1. Tape eject control | 10. Autoset control |
| 2. CD eject control | 11. Scan control |
| 3. Bass/treble control | 12. Seek control |
| 4. Balance/fade control | 13. Tune control |
| 5. Compression/shuffle control | 14. AM/FM/CD control |
| 6. Select control | 15. Power/volume control |
| 7. Side direction/Dolby control | 16. Tape control |
| 8. Rewind/fast forward control | 17. CD door |
| 9. RDS/Mute control | 18. Cassette door |

Volume/power control

Press the control to turn the audio system on or off.

Turn control to raise or lower volume.

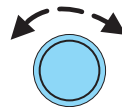

Entertainment Systems

If the volume is set above a certain level and the ignition is turned off, the volume will come back on at a “nominal” listening level when the ignition switch is turned back on.

Audio power can also be turned on by pressing the AM/FM select control or the TAPE/CD select control.

Speed sensitive volume

With this feature, radio volume automatically changes slightly with vehicle speed to compensate for road and wind noise.

The recommended level for speed sensitive volume is from level 1 through level 3. Level 0 turns the speed sensitive volume off and level 7 is the maximum setting.

With the radio on, press and hold the volume control for five seconds, until the display reads SPEED VOL, then press:

- ▲ to increase volume compensation
- ▼ to decrease or shut off the volume compensation

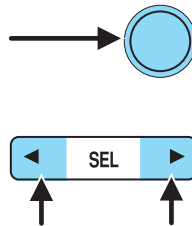

AM/FM select

The AM/FM select control works in radio, tape and CD modes.



AM/FM select in radio mode

This control allows you to select AM or FM frequency bands. Press the control to switch between AM, FM1 or FM2 memory preset stations.

AM/FM select in tape mode

Press this control to stop tape play and begin radio play.

Tune adjust

The tune control works in radio mode.

Entertainment Systems

Tune adjust in radio mode

- Press ◀ to move to the next frequency down the band (whether or not a listenable station is located there). Hold the control to move through the frequencies quickly.
- Press ▶ to move to the next frequency up the band (whether or not a listenable station is located there). Hold for quick movement.

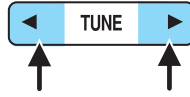

Seek function

The seek function control works in radio, tape or CD mode.

Seek function in radio mode

- Press ◀ to find the next listenable station down the frequency band.
- Press ▶ to find the next listenable station up the frequency band.



Seek function in tape mode

- Press ◀ to listen to the previous selection on the tape.
- Press ▶ to listen to the next selection on the tape.

Seek function in CD mode

- Press ◀ to seek to the previous track of the current disc.
- Press ▶ to seek forward to the next track of the current disc. After the last track has been completed, the first track of the current disc will automatically replay.



Scan function

The scan function works in radio, tape or CD mode.



Scan function in radio mode

Press the SCAN control to hear a brief sampling of all listenable stations on the frequency band. Press the control again to stop the scan mode.

Entertainment Systems

Scan function in tape mode

Press the SCAN control to hear a short sampling of all selections on the tape. (The tape scans in a forward direction. At the end of the tape's first side, direction automatically reverses to the opposite side of the tape.) To stop on a particular selection, press the control again.

Scan function in CD mode

Press the SCAN control to hear a short sampling of all selections on the CD. (The CD scans in a forward direction, wrapping back to the first track at the end of the CD.) To stop on a particular selection, press the control again.

Radio station memory preset

The radio is equipped with six station memory preset controls. These controls can be used to select up to six preset AM stations and twelve FM stations (six in FM1 and six in FM2).

Setting memory preset stations

1. Select the frequency band with the AM/FM select control.
2. Select a station. Refer to *Tune adjust* or *Seek function* for more information on selecting a station.
3. Press and hold a memory preset control until the sound returns, indicating the station is held in memory of the control you selected.



Autoset memory preset

Autoset allows you to set strong radio stations without losing your original manually set preset stations. This feature is helpful on trips when you travel between cities with different radio stations.

Starting autoset memory preset

1. Select a frequency using the AM/FM select controls.
2. Press the control.
3. When the first six strong stations are filled, the station stored in memory preset control 1 will start playing.



Entertainment Systems

If there are less than six strong stations available on the frequency band, the remaining memory preset controls will all store the last strong station available.

These stations are temporarily stored in the memory preset controls (until deactivated) and are accessed in the same manner as your original presets.

To deactivate autoselect and return to your audio system's manually set memory stations, press the AUTO control again.

Bass adjust

The bass adjust control allows you to increase or decrease the audio system's bass output.

Press the BASS control then press:

- ◀ to decrease the bass output and
- ▶ to increase the bass output.



Treble adjust

The treble adjust control allows you to increase or decrease the audio system's treble output.

Press the TREB control then press:

- ◀ to decrease the treble output and
- ▶ to increase the treble output.



Speaker balance adjust

Speaker sound distribution can be adjusted between the right and left speakers.



Entertainment Systems

Press the BAL control then press:

- ◀ to shift sound to the left and
- ▶ to shift sound to the right.

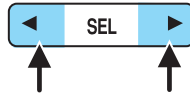

Speaker fade adjust

Speaker sound can be adjusted between the front and rear speakers.

Press the FADE control then press:

- ▶ to shift the sound to the front and
- ◀ to shift the sound to the rear.



Tape/CD select

- To begin tape play (with a tape loaded into the audio system) while in the radio or CD mode, press the TAPE control. Press the button during rewind or fast forward to stop the rewind or fast forward function.
- To begin CD play (if CD is loaded), press the CD control. The first track of the disc will begin playing. If returning from radio or tape mode, CD play will begin where it stopped last.



Rewind

The rewind control works in tape and CD modes.

- In tape mode, radio play will continue until rewind is stopped (with the TAPE control) or the beginning of the tape is reached.
- In CD mode, pressing the REW control rewinds the CD within the current track.



Entertainment Systems

Fast forward

The fast forward control works in tape and CD modes.

- In the tape mode, tape direction will automatically reverse when the end of the tape is reached.
- In CD mode, pressing the control fast forwards the CD within the current track.

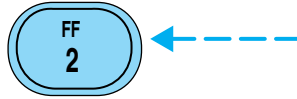

Tape direction select

Press to play the alternate side of the tape.



Eject function

Press the EJ control to stop and eject a tape.





Press the EJ control to stop and eject a CD.



Dolby® noise reduction

Dolby® noise reduction operates in tape mode. Dolby® noise reduction reduces the amount of hiss and static during tape playback.

Press the  control to activate (and deactivate) the Dolby® noise reduction.

Dolby® noise reduction is manufactured under license from Dolby® Laboratories Licensing Corporation. “Dolby®” and the double-D symbol  are registered trademarks of Dolby® Laboratories Licensing Corporation.



Entertainment Systems

Compression adjust

Compression adjust brings soft and loud CD passages together for a more consistent listening level.

Press the COMP control to activate and deactivate compression adjust.



Radio data system (RDS) feature

This feature allows your audio system to receive station identification or program type from RDS-equipped FM radio stations.

The Federal Communications Commission (FCC) and the Canadian Radio and Telecommunications Commission (CRTC) recommend that FM radio broadcasters use RDS technology to transmit information. FM radio stations are independently operated and individually elect to use RDS technology to transmit station ID and program type as desired.

Press the RDS control until RDS ON or RDS OFF appears in the display. Use the SEL control to enable (ON) or disable (OFF) the feature. With the RDS activated, press the RDS control to scroll through the following selections:



Traffic

- Press the RDS control until TRAFFIC is displayed.
- Use the SEL control to select ON or OFF. With the feature on, use the SEEK or SCAN control to find a radio station broadcasting a traffic report (if it is broadcasting RDS data).



This feature also allows you to control the volume of traffic announcements. With the display reading TRAFFIC ON, adjust the volume (using the volume control) to the desired level. The volume level will show at the bottom of the display. Interrupting traffic announcements will be at the selected volume level.

Traffic information is not available in most U.S. markets.

Entertainment Systems

Program type

- Press the RDS control until the FIND program type is displayed.



- Use the SEL control to select the program type. With the feature on, use the SEEK or SCAN control to find the desired program type from the following selections:



- Classic
- Country
- Info
- Jazz
- Oldies
- R & B
- Religious
- Rock
- Soft
- Top 40

Show

- With RDS activated, press the RDS control until SHOW is displayed.
- Use the SEL control to select TYPE (the display shows the program type), NAME (the display shows the call letters of the station) or FREQ.



Shuffle feature

The shuffle feature operates in CD mode and plays all tracks in random order.

Press the SHUFFLE control to start this feature. Random order play will continue until the SHUFFLE control is pressed again.



Mute mode

Press the MUTE control to mute the playing media. Press the MUTE control again to return to the playing media.



Entertainment Systems

Soft mute

When the vehicle is in reverse, and an obstacle is detected by Rear Park Assist, the radio volume is reduced to a level that allows the warning to be heard. After the obstacle warning is gone, the radio will return to the previously set volume level.

Setting the clock

Your vehicle is equipped with a separate instrument panel mounted clock. Please refer to *Clock* in the *Driver controls chapter* for instructions on setting the clock.

AUDIOPHILE AM/FM STEREO IN DASH SIX CD RADIO

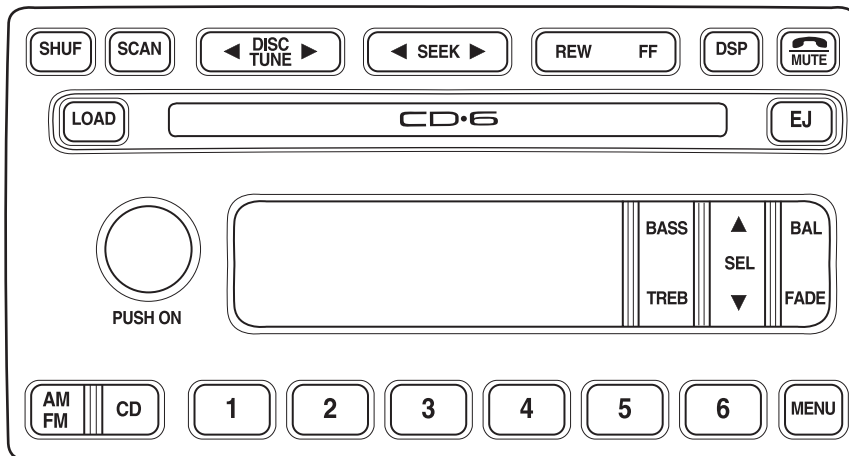

Volume/power control

Press the control to turn the audio system on or off. Turn the control to raise or lower volume.

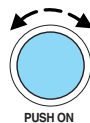

If the volume is set above a certain level and the ignition is turned off, the volume will come back on at a “nominal” listening level when the ignition switch is turned back on.

Entertainment Systems

Speed sensitive volume

With this feature, radio volume changes automatically and slightly with vehicle speed to compensate for road and wind noise.

The recommended level for speed sensitive volume is from level 1 through level 3. Level 0 turns the speed sensitive volume off and level 7 is the maximum setting.

To engage the speed sensitive volume feature, press and hold the volume control for five seconds (with the radio on), then press:



- ▲ to increase volume compensation.
- ▼ to decrease or shut off the volume compensation.

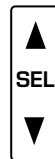

The selected level will appear in the display.

AM/FM select

The AM/FM select control works in radio and CD modes.



AM/FM select in radio mode

This control allows you to select AM or FM frequency bands. Press the control to switch between AM, FM1 or FM2 memory preset stations.

AM/FM select in CD mode

Press this control to stop CD play and begin radio play.

Tune/disc adjust

The tune control works in radio or CD mode.

Tune adjust in radio mode

- Press ◀ to move to the next frequency down the band (whether or not a listenable station is located there). Hold the control to move through the frequencies quickly.
- Press ▶ to move to the next frequency up the band (whether or not a listenable station is located there). Hold for quick movement.



Entertainment Systems

Disc adjust for CD mode

- Press ◀ to select the previous disc. (Play will begin on the first track of the disc unless shuffle mode is engaged.) Refer to *Shuffle feature* for more information. Hold the control to continue reversing through the discs.
- Press ▶ to select the next disc. Hold the control to fast-forward through the remaining discs.



Seek function

The seek function works in radio or CD mode.

Seek function in radio mode

- Press ◀ to find the next listenable station down the frequency band. SEEK DOWN will display.
- Press ▶ to find the next listenable station up the frequency band. SEEK UP will display.



Seek function in CD mode

- Press ◀ to seek to the previous track of the current disc. If the beginning of the disc is reached, the CD player seeks to the beginning of the last track on the current disc and begins playing.
- Press ▶ to seek forward to the next track of the current disc. After the last track has been completed, the first track of the current disc will automatically replay.



Scan function

The scan function works in radio or CD mode.



Scan function in radio mode

Press the SCAN control to hear a brief sampling of all listenable stations on the frequency band. Press the SCAN control again to stop the scan mode.

Entertainment Systems

Scan function in CD mode

Press the SCAN control to hear a short sampling of all selections on the CD. (The CD scans in a forward direction, wrapping back to the first track at the end of the CD.) To stop on a particular selection, press the control again.

Radio station memory preset

The radio is equipped with six station memory preset controls. These controls can be used to select up to six preset AM stations and twelve FM stations (six in FM1 and six in FM2).

Setting memory preset stations

1. Select the frequency band with the AM/FM select control. Press the AM/FM control to toggle between AM, FM1, or FM2.
2. Press the SEEK control to access the next listenable station up or down the frequency band. Press the TUNE control to go up or down the listening band in individual increments.
3. Select a station. Refer to *Seek function* for more information on selecting a station.
4. Press and hold a memory preset control. The playing media will mute momentarily. When the sound returns, the station is held in memory on the control you selected. The display will read **SAVED**.

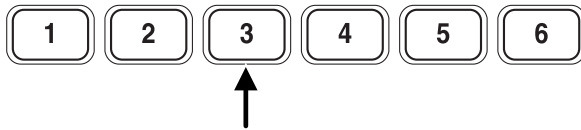

Autostore

Autostore allows you to set the strongest local radio stations without losing your original manually set preset stations. This feature is helpful on trips when you travel between cities with different radio stations.

Starting autostore

1. Press and momentarily hold the AM/FM control.
2. **AUTOSET** will flash in the display as the frequency band is scrolled through.
3. When the six strongest stations are filled, the station stored in memory preset control 1 will start playing.



Entertainment Systems

If there are fewer than six strong stations available on the frequency band, the remaining memory preset controls will all store the last strong station available.

To deactivate autoselect and return to your audio system's manually set memory stations, press the AM/FM control again.

CD select

CD mode may be entered by pressing the CD control. The first track of the disc will begin playing. After that, CD play will begin where it stopped last.

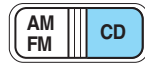

If an alternative CD is desired, press the corresponding preset control (1–6) of a loaded CD, or press the TUNE control to access the other loaded CDs.

NO CD will display if the CD control is activated when there is not a CD present in the audio system.

If the CD control is pressed followed by with a preset number and that particular slot is empty, NO CD will display and the system will begin to play the next available disc.

Display description

Six circles are always lit in the digital display. These signify the six CD slots in the audio system. When a disc is loaded into a particular slot (1–6), the number inside that specific circle lights. If the circle is empty, there is no CD in that particular slot.

Load

The load feature allows you to load single CDs into the player internal to the radio.



This six disc CD player is equipped with a CD door. Compact discs should only be inserted into the player after the CD door has been opened by the player. Do not attempt to force the door open. Compact discs should only be loaded by pressing the LOAD control.

Press the LOAD control. (You can choose which slot will be loaded by pressing the desired preset number. If you do not choose a slot, the system will choose the next available one.) Wait until the CD door opens. Load the CD into the player. LOADING CD# is displayed. When the CD

Entertainment Systems

has been loaded, the door will close and the CD will begin to play. For example, to load a CD into slot 2, press the LOAD control and then press preset 2.

Auto load

This feature allows you to autoloading up to 6 discs into the multi disc CD player internal to the radio.



Press and hold the LOAD control until AUTO LOAD# is displayed. The CD door will open. Load the desired discs, one at a time. The CD is loaded into position and the audio system will display CD#. Each time the CD door opens, AUTO LOAD# is displayed. The door will close and the player will move to the next slot after each disc has been loaded. The process is repeated until all 6 slots are full. The audio system plays the last CD loaded and the display is updated. If some slots are already full and autoloading is activated, the system will fill all empty slots.

Eject

Press the EJ control to stop and eject a CD. You can choose which CD will be ejected by pressing the



EJ control and the desired preset number (1–6). For example, to eject CD 2, press the EJ control and then press the preset 2 control. If you do not choose a specific CD, the player will eject the current CD.

If a CD is ejected and not removed from the door of the CD player, the player will automatically reload the CD. This feature may be used when the ignition is ON or OFF.

Auto eject

Press and momentarily hold the EJ control to engage auto eject. All CDs which are present in the player will



be ejected one at a time. If a CD is ejected and not removed from the door of the CD player, the player will automatically reload the CD. This feature may be used when the ignition is ON or OFF.

Rewind

The rewind control works in CD modes.



Press and hold the REW control until the desired selection is reached. If the beginning of the disc is reached, the CD will begin play at the first track. Release the control to disengage rewind mode.

Entertainment Systems

When in rewind mode, your audio system will automatically lower the volume level of the playing media.

Fast forward

The fast forward control works in CD modes.



Press and hold the FF control until the desired selection is reached. If the end of the disc is reached, the CD will return to the first track. Release the control to disengage fast forward mode.

When in fast forward mode, your audio system will automatically lower the volume level of the playing media.

Shuffle feature

Press the SHUF control until the desired shuffle mode is displayed. The audio system will then engage the desired shuffle mode.



When engaged, the shuffle feature has two different modes: SHUFFLE DISC and SHUFFLE TRK.

SHUFFLE DISC randomly plays tracks from all the discs presently in the audio system.

SHUFFLE TRK plays all the tracks on the current disc in random order.

Compression feature

The compression feature operates in CD mode and brings soft and loud CD passages together for a more consistent listening level.

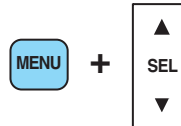

Press the MENU control until compression status is displayed. Press the SEL control to enable the compression feature when COMPRESS OFF is displayed. Press the SEL control again to disable the feature when COMPRESS ON is displayed.

Entertainment Systems

Bass adjust

The bass adjust control allows you to increase or decrease the audio system's bass output.

Press the BASS control. Use the SEL control to increase or decrease the amount of bass.

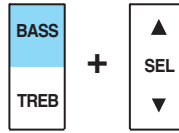

Treble adjust

The treble adjust control allows you to increase or decrease the audio system's treble output.

Press the TREB control. Use the SEL control to increase or decrease the amount of treble.



Speaker balance adjust

Speaker sound distribution can be adjusted between the right and left speakers.

Press the BAL control. Use the SEL control to adjust the sound between the left and right speakers.

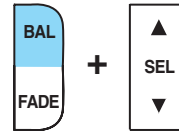

Speaker fade adjust

Speaker sound can be adjusted between the front and rear speakers.

Press the FADE control. Use the SEL control to adjust the sound between the front and rear speakers.

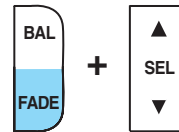

Menu mode

The MENU control allows you to access many different features within your audio system. There are three sets of menus available depending upon which mode or feature is activated.

While in FM mode, two menus are available. **If RDS is turned OFF**, you can access :

- RDS OFF — Refer to *Radio data system feature*.

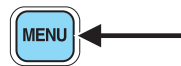

Entertainment Systems

If **RDS is turned ON**, you can access the following:

- TRAFFIC ON/OFF-Refer to *Traffic announcements*.
- FIND type-Refer to *Program type*.
- SHOW (NAME, TYPE, NONE)- Refer to *Radio data system feature*.
- RDS ON— Refer to *Radio data system feature*.

You can also access COMP ON/OFF.

TRAFFIC ON/OFF— Traffic announcements can be programmed as local or distant. Refer to *Traffic announcements*.

RDS ON/OFF— This feature allows your audio system to receive text information from RDS-equipped FM radio stations. Refer to *Radio Data System feature*.

FIND type — Allows you to select your desired FM program type and search for that selection.

SHOW — Allows you to select from NAME (displays the name of the radio station), TYPE (displays the RDS program type: rock, jazz, etc.), or NONE (deactivates the RDS display).

Traffic announcements

This feature allows you to hear traffic announcements. When in this mode, traffic announcements will interrupt radio and CD play.

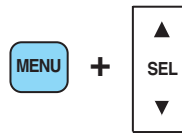

When in FM mode and RDS is activated, press the MENU until TRAFFIC OFF displays. Press the SEL control to engage the feature. The display will read TRAFFIC ON.

This feature also allows you to control the volume of traffic announcements. With the display reading TRAFFIC ON, adjust the volume using the volume control to the desired level. The volume level will show at the bottom of the display. Interrupting traffic announcements will be at the selected volume level.

To disengage the feature, press the MENU control until TRAFFIC ON displays. Press the SEL control. The display will read TRAFFIC OFF.

RDS traffic seek feature

When in traffic mode, you can use the SEEK feature to seek up or down the listenable traffic capable frequencies.

With the RDS activated, press MENU until TRAFFIC ON is displayed. Press and hold the SEEK control until the desired selection is reached. The feature disengages when the control is released.

Entertainment Systems

RDS traffic scan feature

When in traffic mode, you can use the SCAN feature to scan up the frequency band for listenable traffic capable frequencies.

With the RDS activated, press the MENU control until TRAFFIC ON is displayed. Press the SCAN control. SCAN TRAFFIC will display. The audio system will scan to all traffic capable frequencies. If no valid stations are found after one pass, the scan function is cancelled and NOT FOUND displays.

Traffic announcements are not available in most U.S. markets.

Radio data system (RDS) feature

This feature allows your audio system to receive text information from RDS-equipped FM radio stations.

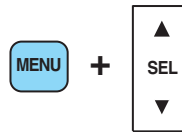

To activate RDS:

- When in FM mode, press the MENU control until RDS OFF displays.
- Press the SEL control to engage this feature (RDS ON).

RDS features:

Once the RDS feature is on, press the MENU control to scroll through the following selections:

Traffic announcements

This feature allows you to hear traffic announcements while in CD mode. These announcements are broadcast by traffic capable RDS stations.

When in this mode, traffic announcements will interrupt radio and CD play.

- Press the MENU control until TRAFFIC is displayed.
- Press the SEL control to engage the feature. The display will read TRAFFIC ON.

This feature also allows you to control the volume of traffic announcements. With the display reading TRAFFIC ON, adjust the volume using the volume control to the desired level. The volume level will show at the bottom of the display. Interrupting traffic announcements will be at the selected volume level.

To disengage the feature, press the MENU control until TRAFFIC ON displays. Press the SEL control. The display will read TRAFFIC OFF.

Traffic announcements are not available in most U.S. markets.

Entertainment Systems

Program type

This feature allows you to search for RDS stations selectively by their program type.

Press the MENU control until FIND program type is displayed.

Use the SEL control to select the program type. With the feature on, use the SEEK or SCAN control to find the desired program type from the following selections:

- Classic
- Country
- Info
- Jazz
- Oldies
- R & B
- Religious
- Rock
- Soft
- Top 40



Show

This feature allows you to select the type of RDS broadcast information the radio will regularly show in the display.

With RDS activated, press the MENU control until SHOW is displayed.

Use the SEL control to select TYPE (displays the RDS program type: rock, jazz, etc), NAME (displays the name of the radio station) or NONE (deactivates the RDS display).

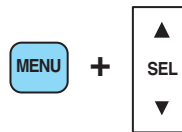

Mute mode

Press the control to mute the playing media. Press the control again to return to the playing media.



Soft mute

When the vehicle is in reverse, and an obstacle is detected by Rear Park Assist, the radio volume is reduced to a level that allows the warning to be heard. After the obstacle warning is gone, the radio will return to the previously set volume level.

Entertainment Systems

Setting the clock

Your vehicle is equipped with a separate instrument panel mounted clock. Please refer to *Clock* in the *Driver controls chapter* for instructions on setting the clock.

Digital signal processing (if equipped)

The digital signal processing (DSP) feature allows you to change the signal mode to suit your listening tastes.

Press the DSP control to access the DSP menu.

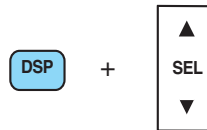

Use the SEL control to select the desired signal mode (the selected mode will appear in the display). The following can be selected:

- DSP OFF—disengages the feature
- STADIUM—outdoor stadium with a capacity of about 30 000
- CHURCH—church with a high vault
- HALL—rectangular concert hall capacity of about 2 000
- JAZZ CLUB—jazz club with clearly reflected sounds
- NEWS “voice-only” type of sound with a limited audio band



Press the DSP control again to access the occupancy modes. Use the SEL control to optimize the sound based upon the occupants in the vehicle.

The following occupancy modes can be selected:

- ALL SEATS
- DRIVER SEAT
- REAR SEATS

DSP ambiance feature (if equipped)

Your vehicle may be equipped with the ambiance feature. This feature gives the feeling of “being there” to your music, creating increased clarity as well as an open and spacious feel to the music.

Entertainment Systems

Press DSP to access the ambiance menu. Press SEL to engage/disengage.



Turn the volume control to increase/decrease the level of ambiance.

Press the DSP control again to access the occupancy modes. Use the SEL control to optimize the sound based upon the occupants in the vehicle.

The following occupancy modes can be selected:

- ALL SEATS
- DRIVER SEAT
- REAR SEATS

CLEANING COMPACT DISCS

Inspect all discs for contamination before playing. If necessary, clean discs only with an approved CD cleaner and wipe from the center out to the edge. Do not use circular motion.

RADIO FREQUENCIES

AM and FM frequencies are established by the Federal Communications Commission (FCC) and the Canadian Radio and Telecommunications Commission (CRTC). Those frequencies are:

AM - 530, 540–1700, 1710 kHz

FM- 87.7, 87.9–107.7, 107.9 MHz

RADIO RECEPTION FACTORS

There are three factors that can affect radio reception:

- Distance/strength: The further you travel from an FM station, the weaker the signal and the weaker the reception.
- Terrain: Hills, mountains, tall buildings, power lines, electric fences, traffic lights and thunderstorms can interfere with your reception.
- Station overload: When you pass a broadcast tower, a stronger signal may overtake a weaker one and play while the weak station frequency is displayed.

Entertainment Systems

CASSETTE/PLAYER CARE

Do:

- Use only cassettes that are 90 minutes long or less.
- Tighten very loose tapes by inserting a finger or pencil into the hole and turning the hub.
- Remove loose labels before inserting tapes.
- Allow tapes which have been subjected to extreme heat, humidity or cold to reach a moderate temperature before playing.
- Clean the cassette player head with a cassette cleaning cartridge after 10–12 hours of play to maintain good sound/operation.

Don't:

- Expose tapes to direct sunlight, extreme humidity, heat or cold.
- Leave tapes in the cassette player for a long time when not being played.

CD/CD PLAYER CARE

Do:

- Handle discs by their edges only. Never touch the playing surface.
- Inspect discs before playing. Clean only with an approved CD cleaner and wipe from the center out.

Don't:

- Expose discs to direct sunlight or heat sources for extended periods of time.
- Insert more than one disc into each slot of the CD changer magazine.
- Clean using a circular motion.

CD units are designed to play commercially pressed 12 cm (4.75 in) audio compact discs only. Due to technical incompatibility, certain recordable and re-recordable compact discs may not function correctly when used in Ford CD players. Irregular shaped CDs, CDs with a scratch protection film attached, and CDs with homemade paper (adhesive) labels should not be inserted into the CD player. The label may peel and cause the CD to become jammed. It is recommended that homemade CDs be identified with permanent felt tip marker rather than adhesive labels. Ball point pens may damage CDs. Please contact your dealer for further information.

40

Entertainment Systems

AUDIO SYSTEM WARRANTY AND SERVICE

Refer to the *Warranty Guide* for audio system warranty information. If service is necessary, see your dealer or qualified technician.

LINCOLN NAVIGATION SYSTEM (IF EQUIPPED)

Your vehicle may be equipped with a Lincoln Navigation System which allows you to listen to the radio, play CDs and also navigate the vehicle using a navigation DVD.

Your system has a large range of features, yet is easy to use. Guidance is shown on the display screen and is supplemented with voice prompts. The display screen provides full information for operating the system through use of menus, text screens and map displays. Screen selections are made by touching the desired selection on the screen.

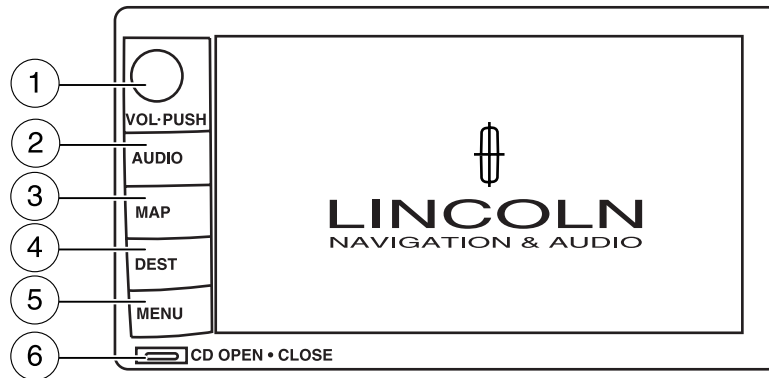

1. **VOL-PUSH:** Press to turn the system ON/OFF. Turn to adjust the audio volume level.
2. **AUDIO:** Press to enter audio mode and access radio, CD, CDDJ, DVD (if equipped) settings.
3. **MAP:** Press to enter map mode and view your current vehicle position on the map. Press and hold to obtain additional position information.
4. **DEST:** Press to enter Destination Entry mode. This allows you to enter a destination and route to it. With an active route, pressing DEST allows the user to request a Detour, display entire route, select route preferences, or change or cancel the destination.

Entertainment Systems

5. **MENU**: Press to access system settings such as display, brightness, clock mode, etc.
6. **CD OPEN CLOSE**: Press to open/close the display screen and access the CD player.

Cold temperature advisory

When operating the system below 32° Fahrenheit (0° Celsius), the display screen requires 20–30 minutes warm-up to achieve maximum brightness. Ensure that the system display setting is set to DAY mode until maximum brightness is achieved (refer to *Menu mode* section). Once maximum brightness is achieved, revert to AUTO mode display setting.

Initial map display

After pressing AGREE to the initial WARNING screen, you will move into the initial map screen which shows the current vehicle location. Pressing the globe icon will take you to the user settings — audible feedback, navigation units, language and clock.



Quick Start — How to get going

To play a radio station:

1. Ensure that the vehicle ignition is on.
2. Press AUDIO.

Entertainment Systems

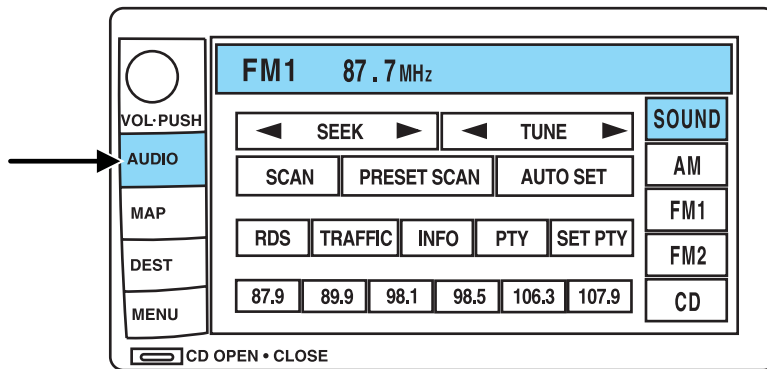

3. Select AM, FM1 or FM2.
4. Press TUNE to adjust manually up (▶) or down (◀) the frequency band.
5. Press SEEK to find the next strong station up (▶) or down (◀).

Note: If PTY (program type) is selected, the station selection will be limited. Refer to *Program Type (PTY)* for further information.

To play a previously loaded CD:

1. Ensure that the vehicle ignition is on.
2. Press AUDIO.
3. Press CD to select a CD which is already loaded. (NO CD will appear in the display if there are not CDs loaded into the system). Use the controls (1–6) to select the desired CD.
4. CD will begin to play.

To load CDs:

1. Press CD OPEN CLOSE at the bottom of the screen to load a CD. (The screen will open).
2. Press LOAD and select the desired slot. Or, press and hold LOAD to auto load all available slots. The slot indicator lights blink rate will increase when the system is ready to accept a disc. Push CD OPEN CLOSE to close the screen. Once closed, the CD will begin to play.
3. Use the touch controls to advance tracks, scan, pause, etc. The small red lights below the CD slot will blink faster when the system is ready to accept a disc.



Entertainment Systems

To use the Navigation system:

1. Ensure that the vehicle ignition is on, and the navigation DVD is loaded into the navigation DVD player. Refer to *Loading the map DVD* for navigation DVD locations.
2. Press DEST. The warning screen will appear. After reading, press AGREE. The screen will show a map with your current location. Press DEST again.

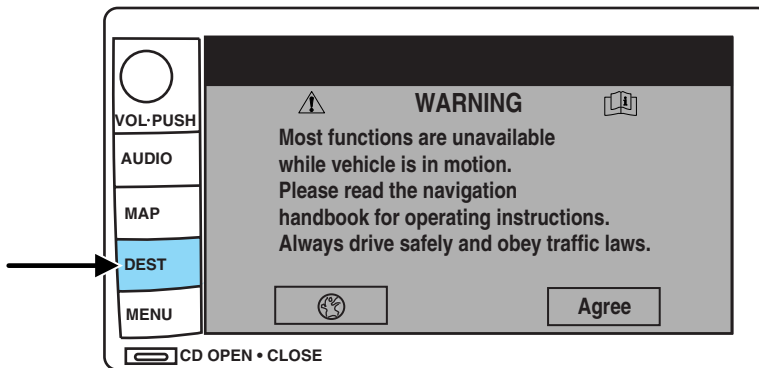

3. Select the desired type of destination entry; Address, Point of Interest; Previous Dest; Special Memory Point; Select from map; Memory Point and Freeway Ent/Exit. Enter the required information.
4. Press DEST at the bottom of the map screen.
5. Choose the desired route by pressing the NEXT button (if it appears). There can be up to three alternative routes.
6. Press START to begin the navigation guidance.

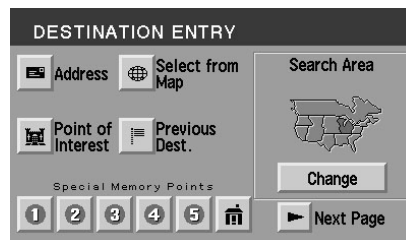

Entertainment Systems

To adjust the voice guidance volume:

Press On/Off to turn the voice guidance option on/off. Use the numeric keys (1–7) to determine the volume level of the guidance voice prompts.



Voice activated commands (if equipped)

Your Lincoln Navigation System (LNS) may be equipped with a voice activated feature which allows you to “speak” certain commands to the system. Speaking clearly will help to ensure that the system correctly responds to your commands.

At any time, you may say these commands:

- AM
- FM1
- FM2
- CD
- DVD (if equipped)

During normal radio operation, you may say:

- Seek up
- Seek down

During CD play with the in-dash 6 disc player:

- Track up
- Track down
- Disc up
- Disc down

While in navigation map mode, the following commands are available by voice activation:

- Zoom in
- Zoom out
- Minimum scale
- Maximum scale

While in navigation destination (DEST) mode, the following commands are available by voice activation:

- Home

Entertainment Systems

- Detour

While in navigation map mode, the following commands are available by voice activation:

- Gas station
- Gas
- Hospital
- Police station
- Restaurant
- Hotel

Audio mode

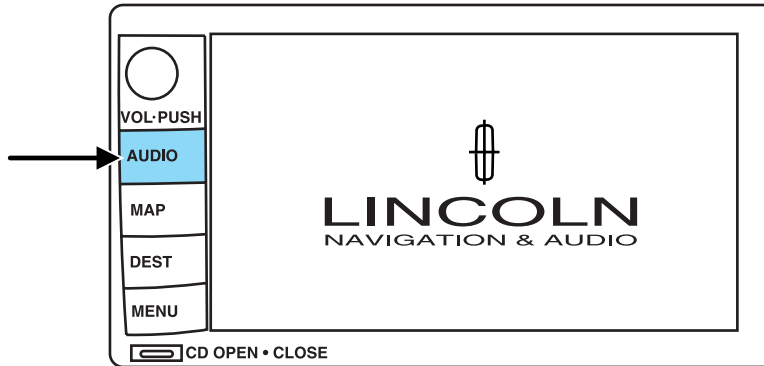

Your Lincoln Navigation Audio System has many features including a full range of audio functions. To access these functions, press AUDIO on the main bezel. This will take you into audio mode.

Volume/power control

Press knob to turn the audio system on/off. Turn to raise or lower volume. The levels will be displayed on the screen.

To activate the navigation mode, press MAP or DEST.

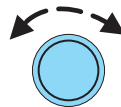

Entertainment Systems

To adjust the navigation voice output level, select the NAV MENU button via the map screen.

Speed compensated volume (SCV)

With this feature, radio volume changes automatically with vehicle speed to compensate for road and wind noise. To engage the SCV feature:

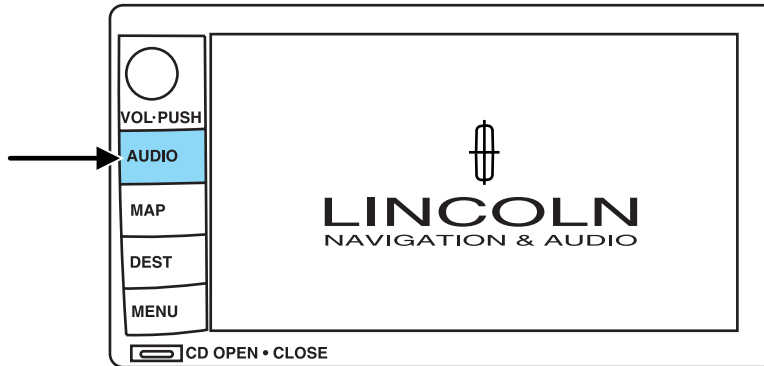

1. Press AUDIO.
2. Press SOUND.

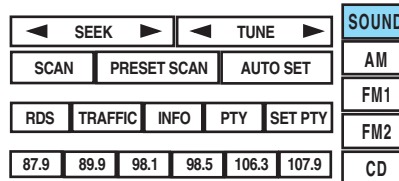

3. SCV is located in the middle of the screen. Press to turn on.
4. Select setting 1 to 7 or turn off.

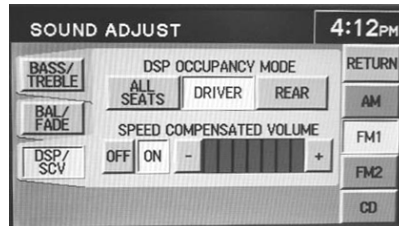

The recommended level for the speed compensated volume is from level 1 through level 3. When activated, level 1 is the minimum setting and level 7 is the maximum setting.

Entertainment Systems

The AM/FM control works in radio, CD and navigation modes.

AM/FM select in radio mode

Press AM/FM1/FM2 to switch between AM/FM1/FM2 memory preset stations.

AM/FM select in CD mode

Press to stop CD play and begin radio play.

AM/FM select in navigation mode

The radio will continue to play in the background of the navigation screens. To access, press AUDIO then AM/FM1/FM2.

Sound functions

To access settings for Bass, Treble, Balance, Fade, DSP (Digital Signal Programming), SCV (Speed Compensated Volume), and Occupancy modes:

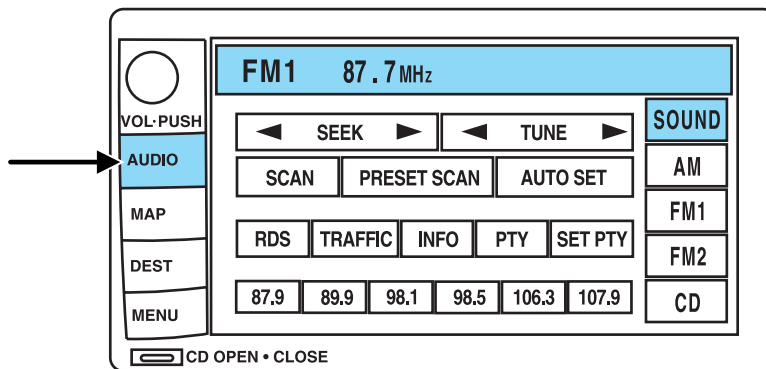

1. Press AUDIO.
2. Press SOUND.
3. Select from Bass/Treb; Bal/Fade; DSP/SCV.
4. Press +/- to increase/decrease the levels.

Entertainment Systems

Bass : Allows you to increase or decrease the audio system's bass output.

Treble : Allows you to raise or lower the audio system's treble output.

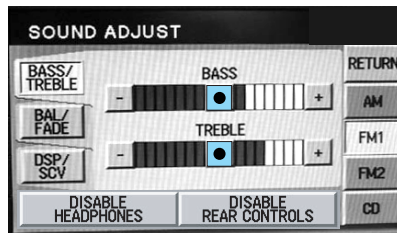

Fade : Allows you to adjust sound between the front and rear speakers.

Balance : Allows you to adjust the sound distribution between the right and left speakers.

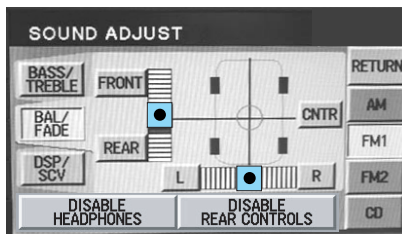

SCV (Speed Compensated Volume) Automatically compensates for road wind and noise. Refer to *Speed compensated volume* earlier in this chapter.

DSP Occupancy mode :Use to optimize the sound based upon the occupants in the vehicle. Select from ALL SEATS, REAR SEATS or DRIVER SEAT.

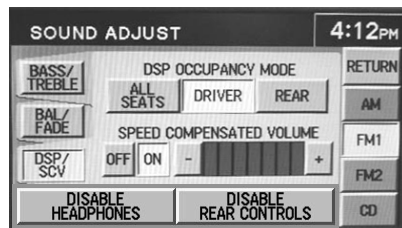

If your vehicle is equipped with rear seat controls, DISABLE HEADPHONES and DISABLE REAR CONTROLS will appear as options at the bottom of the screen. These controls allow you to turn off the headphones and the rear controls for the rear seat passengers. Press the appropriate button to turn the headphones or rear controls off. The button will highlight when the function is disabled. When the button is not highlighted, the function is on (headphones and rear seat controls are operating and able to be controlled by the rear seat passengers.)

Entertainment Systems

Setting memory preset stations

The radio is equipped with six station memory preset controls. These controls can be used to select up to six preset AM stations and twelve FM stations (six in FM1 and six in FM2).

1. Select the frequency band with the AM/FM1/FM2 touch controls.
2. Select a station.
3. Press and hold a memory preset until the sound returns. The frequency will appear in the preset.

Seek

- Press **▶ / ◀** to find the next listenable station up/down the frequency band.
- Press **▶ / ◀** to advance to the next/previous track on a CD.

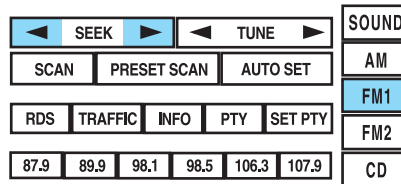

Tune adjust

Press TUNE to manually move down/up (**◀ / ▶**) the frequency band.

In CD mode, press TRACK to select the previous/next (**◀ / ▶**).

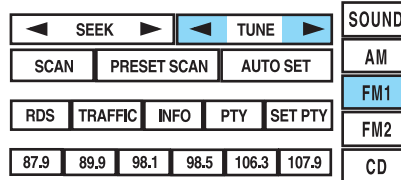

Autoset memory preset

Autoset allows you to set strong radio stations without losing your original manually set preset stations. This feature is helpful on trips when you travel between cities with different radio stations.

Entertainment Systems

Starting autoselect memory preset

1. Select a frequency band using AM/FM1/FM2.

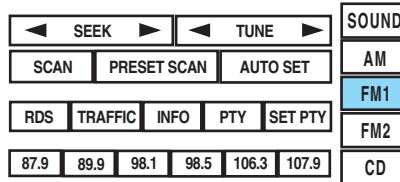

2. Press AUTO SET.

3. When the first six strong stations are filled, the station stored in memory preset control 1 will start playing.

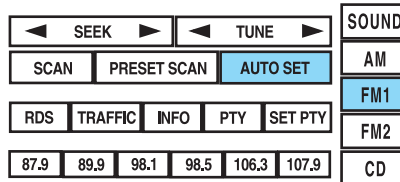

If there are less than six strong stations available on the frequency band, the remaining memory preset controls will all store the last strong station available.

To deactivate autoselect and return to your audio system's manually set memory stations, press the AUTO SET again.

Scan

Press SCAN for a brief sampling of all listenable stations and CD tracks. Press again to disable and remain on the current selection.

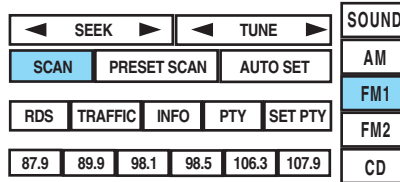

Preset scan

Press PRESET SCAN to scan the stations stored in the memory presets.

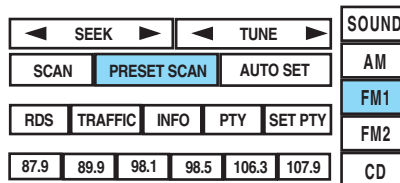

Entertainment Systems

Radio data system (RDS) feature

This feature allows your audio system to receive text information from RDS-equipped FM radio stations such as station call letters, program type, etc. When in FM mode, press RDS to activate/deactivate.

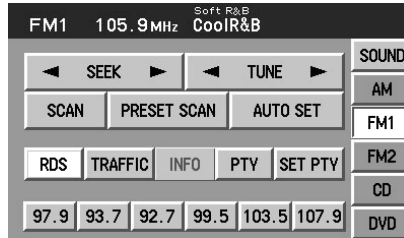

Traffic function

Select TRAFFIC for traffic information broadcast from certain stations which will automatically interrupt radio or CD playback at a preset volume level.

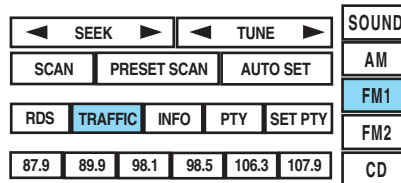

Traffic information not available in most U.S. markets.

Information feature

Press INFO to view the frequency, call letters and PTY category of the selected FM station.

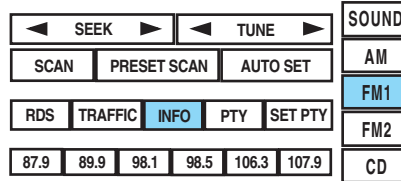

Program type (PTY)

This feature allows you to search for Radio Data System (RDS) stations selectively by their program type.

Entertainment Systems

Ensure that the RDS function is turned on. Press PTY to turn the feature on/off.

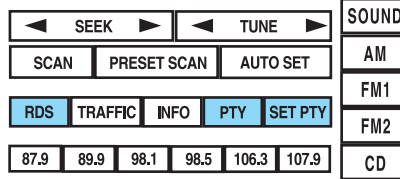

To set/change PTY:

Ensure that the RDS function is turned on.
Press SET PTY to select from the following program types:

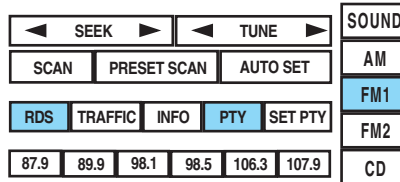

- All
- Classical
- Country
- Information
- Jazz
- Religious
- Rock
- Soft
- Top 40

Once PTY has been programmed, press SEEK (▶ / ◀) or SCAN to initiate a search up or down the frequency.

Preset scan and Autoset also initiate PTY searches. The search will stop when the desired program type has been reached. If no program type is found, a message will display.

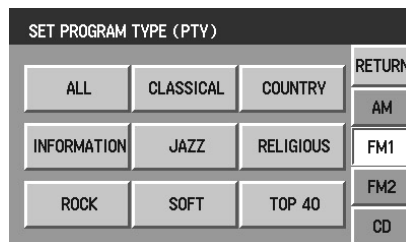

Entertainment Systems

CD mode

CD units are designed to play commercially pressed 12 cm (4.75 in) audio compact discs only. Due to technical incompatibility, certain recordable and re-recordable compact discs may not function correctly when used in Ford CD players. Irregular shaped CDs, CDs with a scratch protection film attached, and CDs with homemade paper (adhesive) labels should not be inserted into the CD player. The label may peel and cause the CD to become jammed. It is recommended that homemade CDs be identified with permanent felt tip marker rather than adhesive labels. Ball point pens may damage CDs. Please contact your dealer for further information.

Playing a previously loaded CD:

To begin CD play (if a CD is already loaded), press AUDIO hard button and then CD.

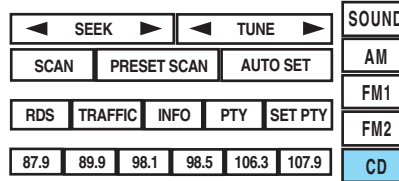

Press CD. CD play will begin where it stopped last.

Loading a CD:

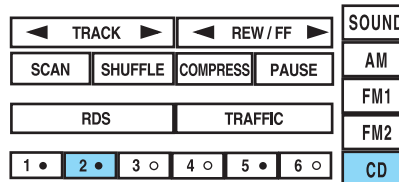

 CD OPEN • CLOSE

1. Press CD OPEN CLOSE on the bezel.

Entertainment Systems

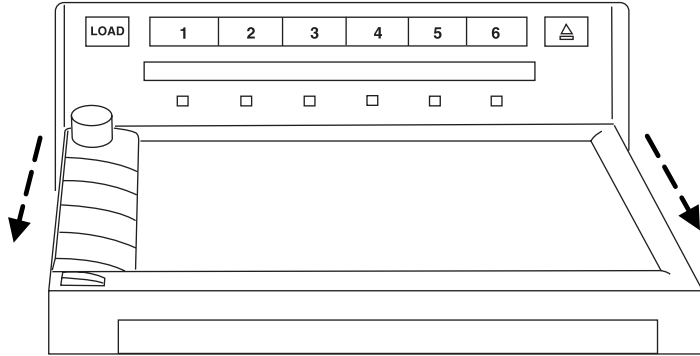

2. The navigation screen will fold down, allowing you access to the in-dash six CD system.
3. Press LOAD and the desired CD slot number. The indicator light will blink slowly at first, then quickly, signaling the system is ready.
4. Insert a disc.
5. **To load more than one disc**, press and hold LOAD. This will initiate autoload and will allow you to load all open CD slots. After an allotted time, the screen will close automatically or you may press CD OPEN CLOSE on the bezel again.
6. Once the screen closes, the system will start playing the last CD loaded.

Track

Press **▶ / ◀** to advance to the next/previous track.

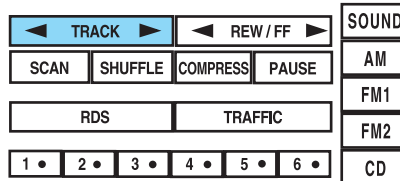

Entertainment Systems

Rewind/fast forward in CD mode

Press to reverse or advance (◀ / ▶) in the current CD track.

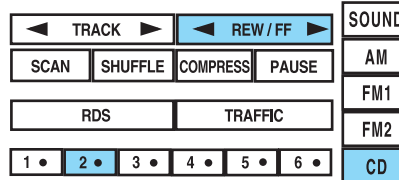

Scan feature in CD mode

Press SCAN to hear a brief sampling of all tracks on the current CD. Press again to disengage and remain with the current track.

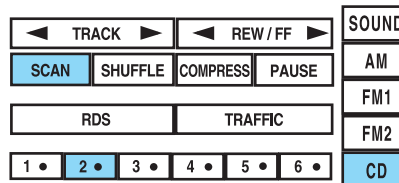

Shuffle feature in CD mode

When in CD (or CDDJ mode), press SHUFFLE to engage the shuffle feature. Press to select from shuffling between tracks (SHUFFLE TRACK) on the current CD or between all tracks on all CDs (SHUFFLE DISC). All tracks will be played in random order. Press again to disengage (SHUFFLE OFF).

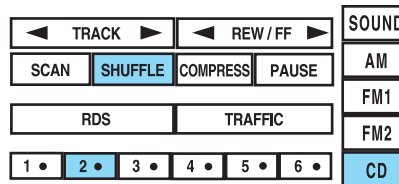

Compression feature

The compression feature works in CD mode and boosts more quiet music and lowers louder music to minimize the need for volume adjustments.

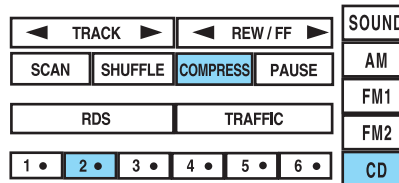

When in CD or CDDJ mode, press COMPRESS to engage or disengage the compression feature.

Entertainment Systems

Pause

In CD mode, press PAUSE to pause the current track. Press again to continue playing.

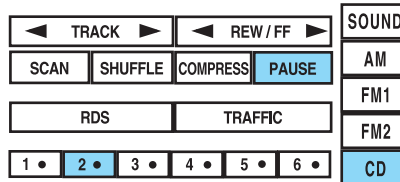

Map mode

Map display information

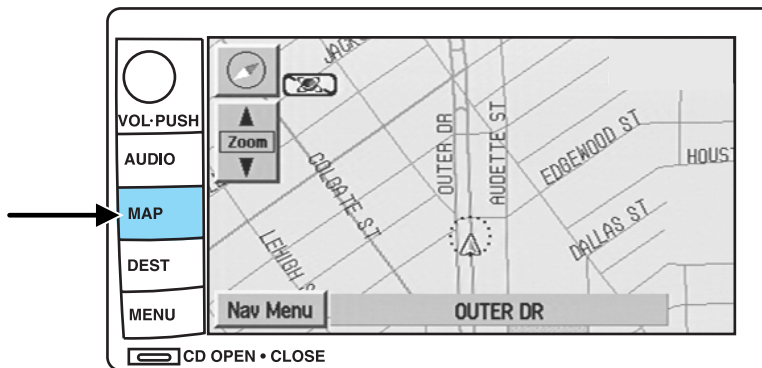

To access the map display, press MAP on the bezel.

Once pressed, the current map display will appear on the screen showing the current vehicle location.



Zoom control

When 'Zoom' is pressed, the scale indicator is shown on the screen. The scale markings are: 1/32, 1/16, 1/4, 1/8, 1/2, 1, 2, 4, 8, 16, 32, 64, 128 miles. The control can be used in a number of ways:

- touch and hold one of the arrow buttons for the map to be displayed again at each zoom level.

Entertainment Systems

- touch one of the arrow buttons repeatedly for the map to be displayed again at the final zoom level.
- touch one of the segments of the scale indicator for the map to be displayed at the selected zoom level.

Additional map function buttons

To initiate the display of additional map function buttons, tap the map anywhere on the screen. The following buttons will appear:

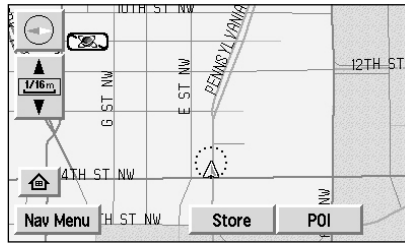

- **STORE** - stores current vehicle location as a memory point. Refer to *Memory Points* for further information.
- **POI** (Point of Interest)- brings up the Quick POI menu which allows the user to perform two functions:
Display POI icons on the map for one category.
Select local map area POIs as destinations or waypoints. The list of local area POIs can be sorted by distance, name, or icon. Refer to *Points of Interest* for further information.
- **NEXT** - Press for the system to step through a list of the POIs requested and display them on the map.
- **INFO** - Press to access the address and phone number of a selected POI.

If home has been previously programmed in the “Nav Menu”, the home icon (house) will appear on the screen and is able to be selected as a destination.

To delete POI icons from the map, touch the map again and press the POI off button.

Entertainment Systems

Screen symbols

Navigation symbol — Indicates the current vehicle position and points to the direction in which the vehicle is currently traveling.



Destination symbol — Indicates the current route destination.

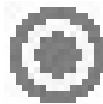

Next turn symbol — Shows the next maneuver that will need to be taken on the current route.



North up button — Indicates that the map is displayed with north to the top of the screen. Press to toggle between “North up” and “Heading up” map display states.



Heading up button — Indicates that the map is displayed with the vehicle heading to the top of the screen. The position of the pointer indicates the direction of north on the map. Press to toggle between “North up” and “Heading up” map display states.

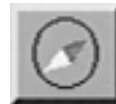

Avoid areas or points — The left-hand symbol indicates an area to be avoided in route calculations. The right-hand symbol indicates an avoid point.



If the avoid point is enlarged to an avoid area, it will appear on the screen as a shaded box.



Entertainment Systems

Way point symbol — Indicates the location of a way point (locations you wish to visit in route to your ultimate destination) on the map.



Home position symbol — Indicates the location on the map, currently stored as the home position.



Stored location symbol — Indicates the location of a memory point. This is the default symbol used when the point is stored. (If desired, an icon of your own choice can be selected from the 15 icons available.) Refer to *Choosing from the icon list*.



GPS symbol— Indicates that insufficient GPS satellite signals are being received for accurate map positioning. The symbol is not displayed under normal operation.



Speaker icon symbol— Press to turn voice guidance on/off.



Navigation menu

To access the Navigation Menu, press NAV MENU at the bottom of the map screen.



Once pressed, the Navigation Menu will display showing the following options:

- Route Options/Preferences
- Navigation Set Up
- Display Options
- Stored Locations
- On Route Scroll
- Voice Guidance/Volume



Entertainment Systems

Depending upon whether or not a route is active will determine if route options/route preferences is contained on the Navigation Menu.

Route options (destination entered)

Once in navigation mode and a route is currently active, press “Chng. route” to access the ROUTE OPTIONS screen. Choose from the following selections:

- **Detour:** Press to select a detour around the current route. Refer to *Detour options* later in this chapter for further information.
- **Route Preferences:** When creating a destination, select from: Minimize Time/Distance, Use Major Roads, Use Toll Roads, Use Ferries.
- **Display Whole Route:** Will enter MAP mode and display your entire chosen route.

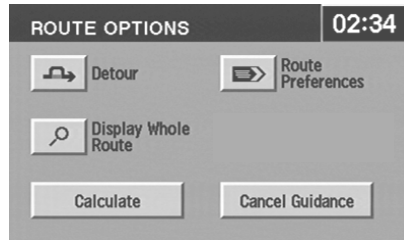

Note: Route preference appears on the Nav menu when no destination is entered.



While driving under route guidance, only follow an instruction when it is safe to do so as the system cannot be aware of changing conditions. Use voice guidance as much as possible, and only view the display when driving conditions permit.



Ensure that you follow highway code restrictions and do not take any risks. For example, if you are unable to make a U-turn, continue on your journey. The navigation system will recalculate your route to get you back to an appropriate road to your destination.

Entertainment Systems

Route preferences

After entering a destination, the Route options will appear on the screen showing what is currently selected. You may choose to activate/deactivate selections which the system will factor in when calculating your route. Those options are:

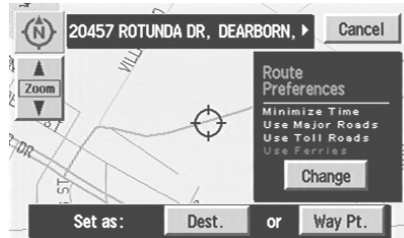

- Minimize Time/Distance
- Use Major Roads
- Use Toll Roads
- Use Ferries

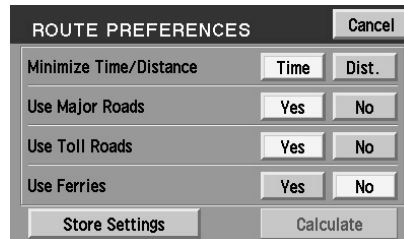

Navigation set up

The Navigation Set up screen will allow you to make adjustments to the navigation displays.

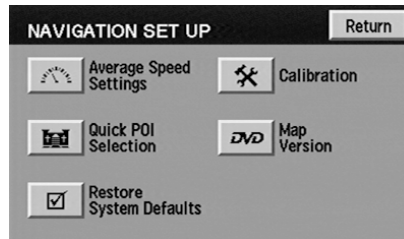

Entertainment Systems

Average speed settings

Allows you to set approximate speeds you drive. These speeds enable the navigation system to aid in calculating timing for routes.

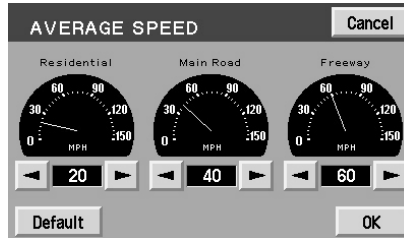

Quick POI (Point of Interest)

Allows you to change the Quick POI menu settings. Select the desired Quick POI (Gas, ATM, etc.) and then press 'List Categories' for further categories, or 'Map Area POIs' to show the desired POIs on your current map.

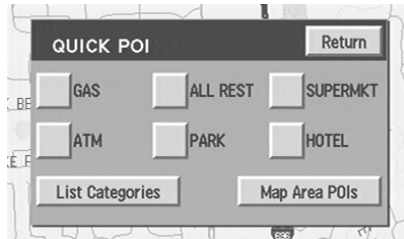

Restore system defaults

Resets all system user-selectable options to the default (automatic) values (i.e, guidance, voice, search area and route preferences).

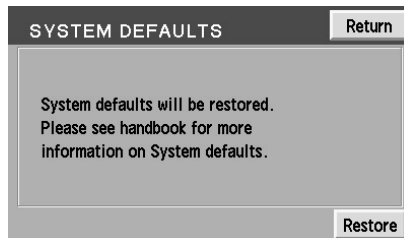

Entertainment Systems

Calibration

This feature is helpful if the car has been towed, or if you notice it is not registering at the correct vehicle location on the map.

Press "Position" to reposition the vehicle location. Press the screen to scroll the map to the desired location and press OK to confirm.

Press "Distance" to calibrate by distance and improve the navigation accuracy. It is recommended to activate this function after ever tire replacement. When the button is highlighted, calibration is in process and will turn off automatically when complete.

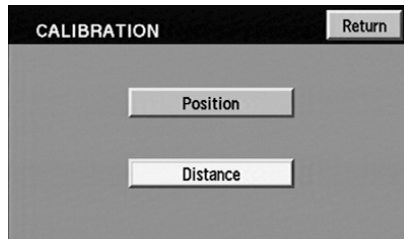

DVD map version

Displays the version of the inserted navigation DVD. Refer to *Ordering additional map DVDs* for further information.

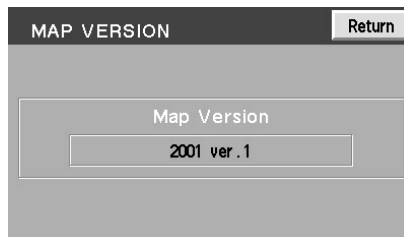

Display Options

The Display Options screen will allow you make adjustments to the navigation display screen. You can choose from:

- Map Mode (Dual or Full)
- Guidance Mode (Arrows or Turn list)
- Guidance Display (On or Off)

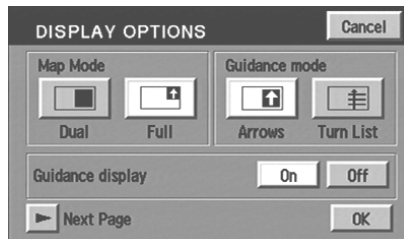

Entertainment Systems

- Time to destination (Show or Hide)

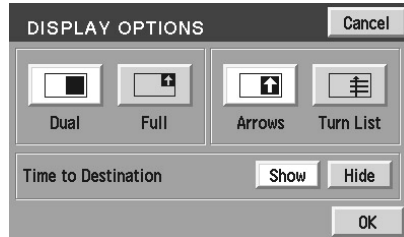

Stored locations

The Stored locations screen will allow you to choose from destinations that have been saved into the navigation system.

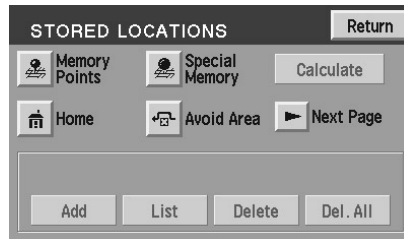

In this screen, you can select from Memory Points, Special Memory Points, Home, Avoid Area, Destination and Way Point, or Previous Destination. Please refer to the *Destination menu* section for a complete description of the functions.

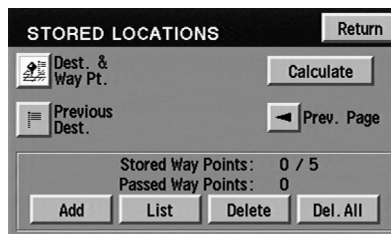

Entertainment Systems

On route scroll

The system automatically scrolls through the entire planned navigation route either forwards or backwards. To activate, press the arrow buttons at the bottom left of the map screen.

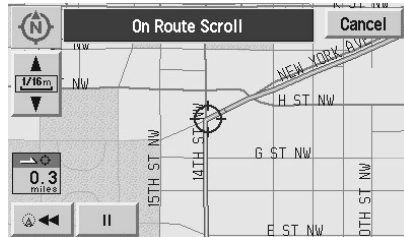

Voice guidance/volume

Allows you to turn the voice guidance option on/off and to determine the volume level of the guidance voice prompts.



Destination menu

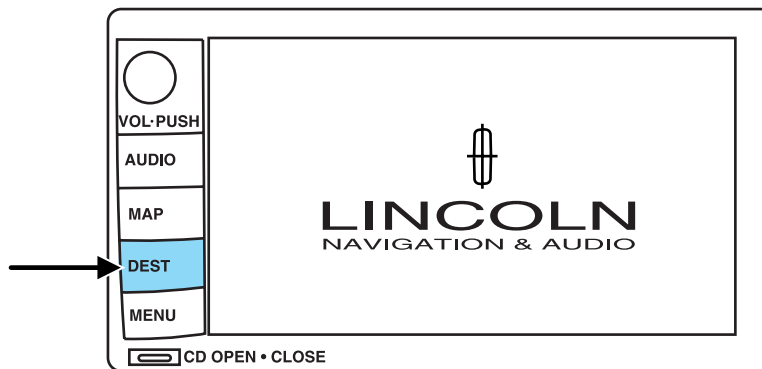

Press DEST on the main bezel to access the navigation mode.

Entertainment Systems

Initial map display

After pressing AGREE to the initial WARNING screen, you will move into the initial map screen which shows the current vehicle location. Pressing the globe icon will take you to the user settings — audible feedback, navigation units, language and clock.

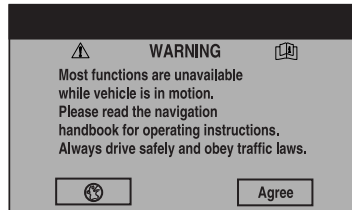

Note: There may be a slight time delay between the soft key and the hard key functions.

Route options

Once in navigation mode and a route is currently active, the ROUTE OPTIONS screen will appear and allow you to choose from the following selections:

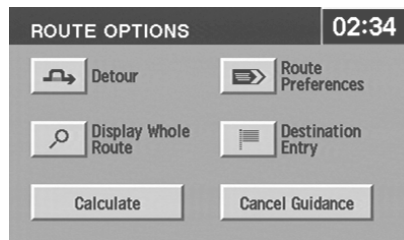

- **Detour** — Press to select a detour around the current route.
- **Route Preferences** — When creating a destination, select from: Minimize Time/Distance, Use Major Roads, Use Toll Roads, Use Ferries.
- **Display Whole Route:** Will enter MAP mode and display your entire chosen route.
- **Destination Entry:** Allows you to enter a new destination or select from entries in: Address book, Points of Interest, Previous Destinations, and Intersections.

 While driving under route guidance, only follow an instruction when it is safe to do so as the system cannot be aware of changing conditions. Use voice guidance as much as possible, and only view the display when driving conditions permit.

Entertainment Systems

 Ensure that you follow highway code restrictions and do not take any risks. For example, if you are unable to make a U-turn, continue on your journey. The navigation system will recalculate your route to get you back to an appropriate road to your destination.

Destination entry

Selecting a destination

Press DEST to set a destination. From this menu, you may select from the following options:

- **Address**— Use to select a destination based on a known street address or intersection.
- **Point of Interest**— Use to select a destination that is a point of interest location (i.e., airport, restaurant, hospital).
- **Select from map**—Use to select a place on the map.
- **Previous Destination** — Use to select a destination from among the last 20 entered destinations

Press  'Next Page' to access more selections:

- **Memory point** — Use to select from a memory point.
- **Freeway exit/entrance** — Use to select a certain freeway exit or entrance.
- **Special Memory Points** — Use to select a destination from previously stored entries.

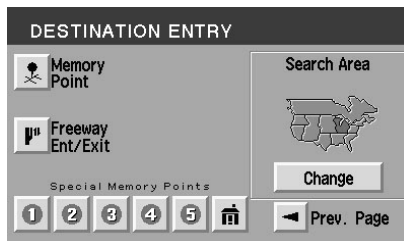
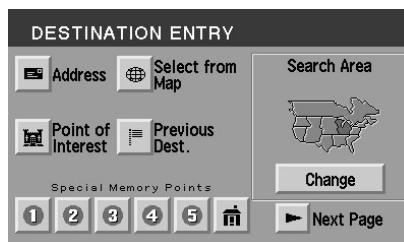

Entertainment Systems

Search area

Your navigation system uses a regional search area. This area is the area from which navigational directions will be used. To check your area or reset, press CHANGE under the search area listing. The map will open and allow you to select another regional area. Ensure that your search area is correct prior to setting your destination.



Points of interest (POI)

Select “Point of Interest” from the Destination Entry Menu. In this next menu, you will have the following options:

- **By Name**— Enter POI name on the keyboard. Touch “List” to display the list of matching points of interest. If there are too many matches being listed, try entering the town name first.
- **By Category** — Press “Category”. Scroll down the list to select the category, then sub-category desired. Once you have selected a category, your entry of the POI will be restricted to that category.

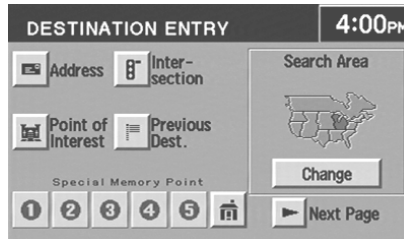

Previous destination

Press “Previous Destination” on the Destination Entry Menu.

- Select (touch) the desired item from the list of destinations previously reached. The item details will be listed.
- Confirm destination details.

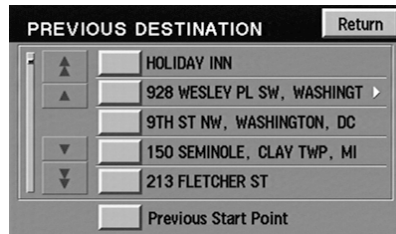

Entertainment Systems

Deleting previous destination

- Press “Delete”. The list of previous destinations is displayed showing “Delete Previous Destination” at the top of the screen.
- Select (touch) the entry to be deleted. The item details will be listed.
- Press YES to confirm the deletion.
- Press DELETE ALL to delete all previous destination.



Memory point

Your navigation system allows you to save special destinations you may wish to again visit. Select “Memory Point” from the Destination Entry Menu.

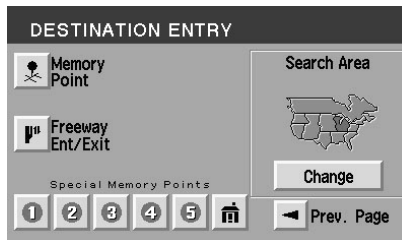

- Select the desired item from the list of stored memory points.
- Confirm destination details.

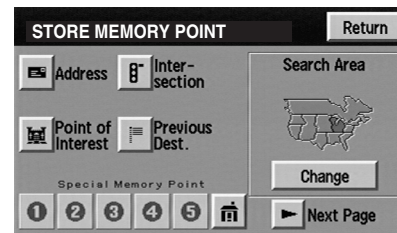

Note: The list can be sorted by date, name or icon by pressing the appropriate button.

Entertainment Systems

Adding a memory point

- Once in the Store Memory Point Menu, press ADD.
- Select (touch) the desired menu item.
- Enter/select any required details. The new point will be added to the stored list of memory points.

To give the new memory point a name:

- Select it from the list.
- Press NAME.
- Enter the desired name.

Accessing memory point lists

- Press LIST
- Select the desired entry to view its location details.

List

The screenshot shows the 'EDIT POINTS' screen with a 'Return' button in the top right corner. The screen contains four input fields:

Icon	
Name	213 FLETCHER ST
Position	213 FLETCHER ST, FRONT ROYAL, VA
Tel.	5551212

Sorting memory point lists

- Access the desired list.
- Press the button to sort the list as desired (i.e. date, name, or icon).

When sorted by distance, the points are ordered by distance from the current vehicle location. When sorting by icon, the icons are listed in the order they appear on the icon selection screen.

The screenshot shows the 'EDIT POINTS' screen with a 'Return' button in the top right corner. The screen displays a list of memory points with navigation arrows on the left and a 'Sort by' menu at the bottom.

▲		928 WESLEY PL SW, WASHIN >
▲		BOB'S MARKET & DELI
		WHITE HOUSE
▼		213 FLETCHER ST
▼		N CAPITOL ST NW, WASHING >

Sort by:

Entertainment Systems

Choosing from the icon list

After choosing ICON to edit, 15 normal and three audible icons will be displayed. Press the icon you wish to use.

The normal icons will be displayed on the map to indicate the map location identified with that icon. The audible icon will sound a distinctive chime when the vehicle is approaching the memory point associated with that icon.

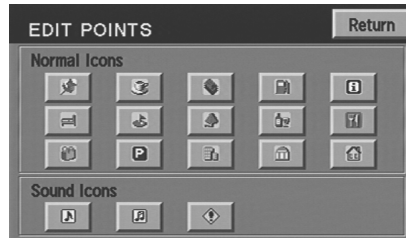

Deleting a memory point

- In the Memory Point Menu, press DELETE.
- Select the entry to be deleted.
- The system will ask you to confirm deletion. Press YES to confirm.

The screen will briefly show “Memory Point Deleted”.

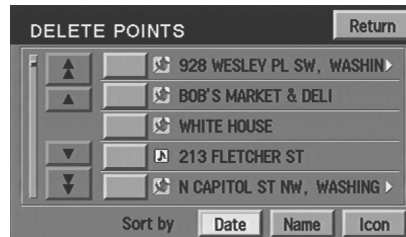

Deleting all memory points

- In the Memory Point Menu, press DELETE ALL.

Del. All

- The system will ask you to confirm deletion. Press YES to confirm.

The screen will briefly show “All Memory Points Deleted”.

Entertainment Systems

Home

To set home for the first time:

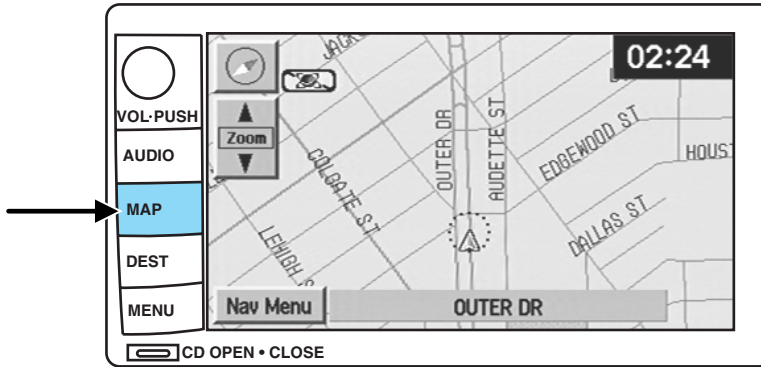

- Press MAP.
- Press “Nav. Menu”.
- Press “Stored Locations.”
- Press “Home”.
- Press “Add”. Set home by selecting the correct address, POI, Previous destination, or selecting from the map.

Nav Menu

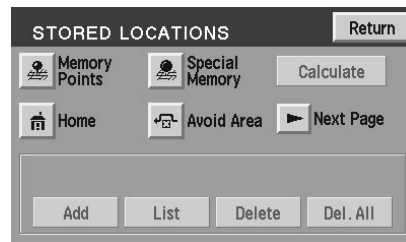

To view home, press the home icon (house) on the Destination Entry screen.

Once home is set, you may select home as a destination.

Entertainment Systems

Adding a home location

- Select the desired menu item you wish to set as Home (Address, Memory Point, Point of Interest, Previous Destination).
- Enter the required details.

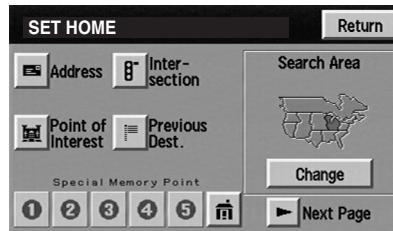

- Press OK to set the home position.



To view the set home position:

From the stored locations menu with home selected, press LIST to view the location of the stored home position.

Deleting a home location

- Once in the stored locations menu with home selected, press DELETE.
- The system will ask you to confirm.
- Press YES to confirm.



Entertainment Systems

Freeway Entrance/Exit

Select “Freeway Entrance/Exit” from the second page of the Destination Entry menu. Follow these steps:

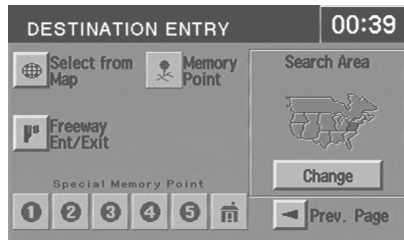

1. **Enter freeway name**— Enter the freeway name using the keyboard. Press “List” to select a freeway from those displayed.

To enter numbers in the freeway name, press “Sym”.



2. **Select entrance/exit**— Press “Entrance” if you wish to join the freeway at this junction. Press “Exit” if you wish to leave the freeway at this junction.

3. **Select Junction**— The screen will display a list of junctions on the freeway. They can be listed either by distance, (from the current vehicle location), by pressing the “Dist” button or alphabetically by pressing the “A-Z” button. Select the desired entrance or exit.

The destination details are displayed for confirmation.

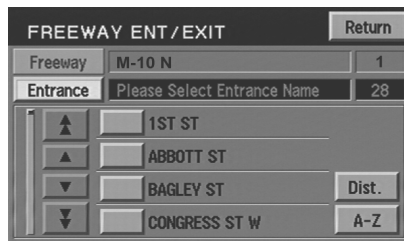

Entertainment Systems

Special memory points

There are five possible memory points that you can set.

To set a memory point:

- Press MAP.
- Press “Nav Menu”.
- Press “Stored locations”.
- Press “Special Memory Point”.
- Select “Add” and input destination.
- Press OK to confirm.

To delete a memory point:

- Press “Delete”. The list will display.
- Select the special memory point to delete.
- Press “Del. all” to delete all entered special memory points.
- Press “Yes” to confirm.

Once all five special memory points are entered, the “Add” control will read as “Full”. You must delete points before more can be added.

Destination and way points

The Store Dest. & Way Point menu is used after a destination or way point has been entered for the first time using the Destination Entry menu. You can store and delete destinations and way points (locations you wish to visit in route to your ultimate destination). You can also select the order in which you visit them.

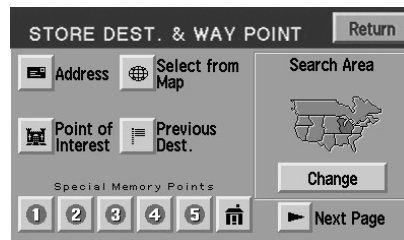

Entertainment Systems

Adding (storing) a destination or way point

- Once a destination is entered, press ADD to store the location. The Store Dest. & Way Point menu is displayed.
- Select whether you want to store an Address, Point of Interest or Previous Destination.
- Enter the necessary details for the selection.
- If a destination was entered, it will be stored as the current location. If a way point was entered, it will be added to the list of way points.

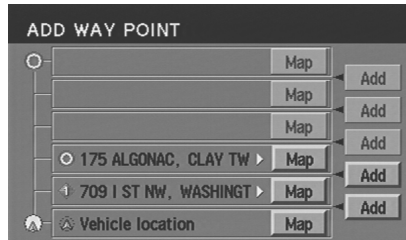

Listing destinations and way points

Press LIST to display the stored way points and destination (if entered).

The first way point to be visited is at the bottom of the list and the destination is at the top.

You may view the map location of any entry. On the map, location details for the entry are displayed at the top of the screen.

To adjust the position of the way point (or destination), scroll the map as required.

Press OK.

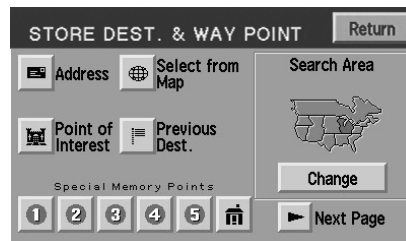

Entertainment Systems

Editing and changing order of way points and destination

Press “Chg. Order” to change the order in which the way points are visited. The points are listed chronologically from bottom up, the destination being on the top.

Press the MAP button to edit the way point location on the map display.

Press OK to confirm.



Deleting way points and destination

After pressing DELETE, the list of way points and the destination (if entered) is displayed, showing the 'Delete Dest. &Way Pt.' menu.

Select the entry to be deleted. Press YES to confirm.

Press DELETE ALL to delete all way points. Press YES to confirm.



Selecting route criteria

Once you have selected a destination, you may change the routing criteria by pressing “Change” in the route preferences screen. Refer to *Route preferences* for further information.

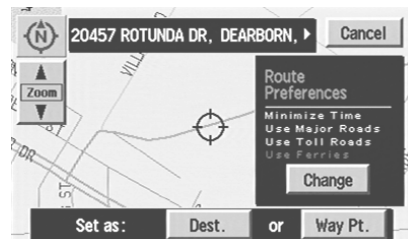

Entertainment Systems

Route calculation

Once the route criteria is selected, the navigation system automatically calculates the selected destination. The route appears on the display screen and a voice prompt provides instructions.

The system may calculate up to four routes for the desired destination. Press "Next" to scroll through the various planned routes. Press "Start" to confirm the route selection and begin route guidance.

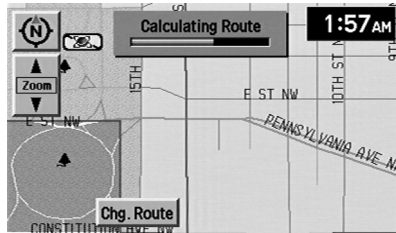

Detour options

You may engage the detour option when on the map display by going to the "Nav menu" and selecting "Route Options".



Press DETOUR to activate. Use the soft controls to select and enter the number of miles you want to deviate off of the current road.

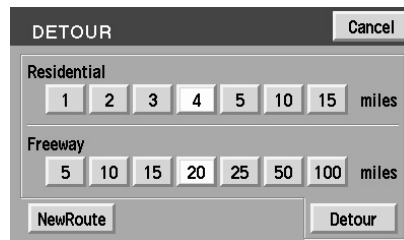

Press NEW ROUTE if you would like the system to plan a different route.

Press DETOUR to confirm the selection.

Entertainment Systems

Route interruptions

In the course of your destination, you may decide to temporarily leave your planned route for gas, food, etc. If you turn off the ignition, the option to continue the route guidance will be displayed when the ignition is turned on again. The route can be accessed once again after you press “Agree” on the warning screen.

Route alterations or cancellations

To cancel or change your current route from the map, press DEST or select “Nav Menu” and “Route Options”. You may then select from Detour, Display whole route, change route preferences or cancel guidance.

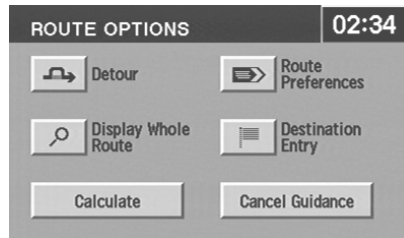

Avoiding an area while under guidance

For one reason or another, you may choose to avoid a certain area while in route to your destination. To select the area to avoid:

- From the MAP screen, press Nav Menu.
- Select Route Options, then Display Whole Route
- Press Turn List
- Press Avoid next to the street to be avoided
- Choose OK to confirm
- Press Reroute to activate

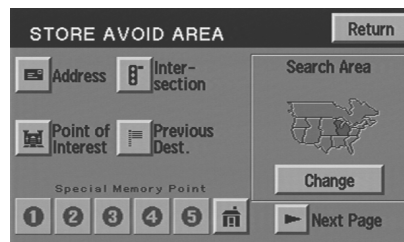

The new area is added to the list of stored avoid areas.

Note: In some circumstances, it may not be possible to avoid all selected areas.

Entertainment Systems

Listing areas to avoid

You can list all areas noted as “avoid”.

- Press “Nav Menu”.
- Press “Stored locations”.
- Press “Avoid area”.
- Press LIST to view all previously stored selections.
- Select the desired one. The map screen will be displayed, showing the location and address of the selected area.

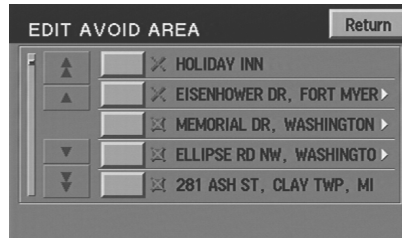

Press Enlarge or Reduce to adjust the size of the visible area. Scroll the map as required.

Deleting areas to avoid

To delete a selection from the “Avoid area” list:

- From the stored locations menu, select “Avoid area”.
- Press DELETE
- Select the desired area to be deleted.
- Press DEL. ALL to delete all stored areas.
- Press YES to confirm.

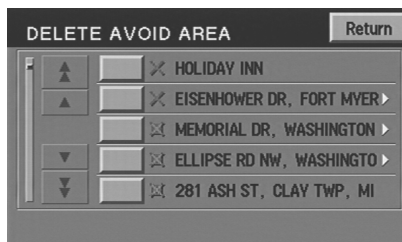

Entertainment Systems

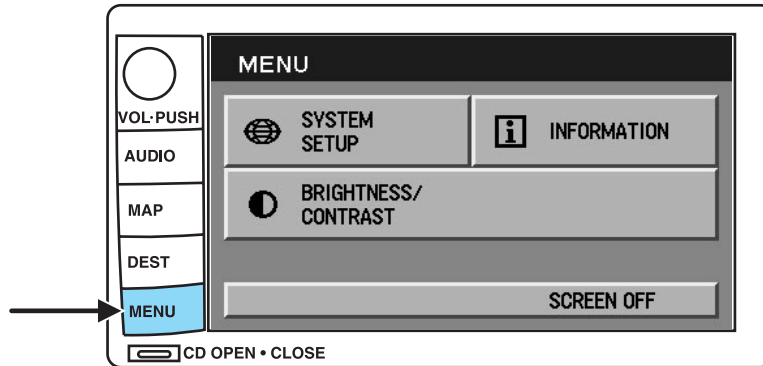

To access menu mode, press the MENU hard control.

Menu mode allows you to access:

- System Set-up
- Information — Gives you the Lincoln Customer Assistance Center information.

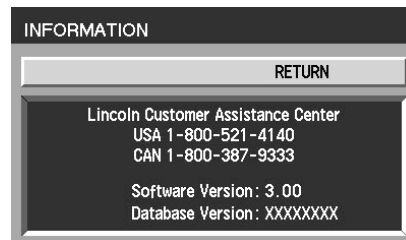

- Brightness/Contrast — Allows you to adjust the brightness and contrast on the screen.

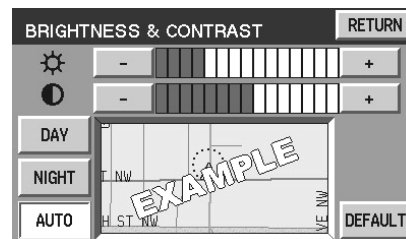

Entertainment Systems

- Screen off — Allows you to turn off the navigation screen.

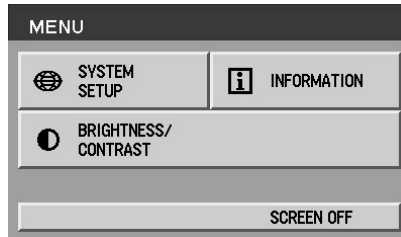

System setup

The system set up menu contains the following user settings:

- Audible Feedback — Press to activate audible voice navigation commands. Press again to deactivate.
- Navigation Units — Press to toggle between Metric/English units.

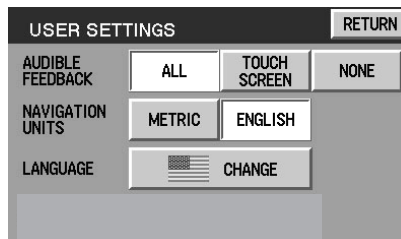

- Language — Press to toggle between English, French, or Spanish.



Entertainment Systems

Setting the clock

Once in Menu mode, press CLOCK to set the hours/minutes.

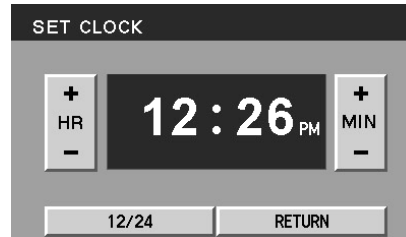

DVD interaction (if equipped)

Your vehicle may be equipped with a DVD player. Your Lincoln Navigation System (LNS) will interact with your DVD player, providing you access and messages to the status of the system.

- Press AUDIO.
- Press DVD to access the DVD screen.

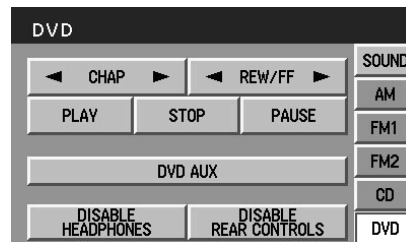

You may select from different chapters, rewind or fast forward within the current chapter, stop, play or pause the DVD. You may also select DVD AUX mode (which would allow you to plug in and play games), to enable/disable headphones, or to enable/disable rear seat controls. For further information, refer to *Rear seat audio controls (if equipped)* and *Family entertainment DVD system (if equipped)* earlier in this chapter.

Voice activated commands (if equipped)

Your Lincoln Navigation System (LNS) may be equipped with a voice activated feature which allows you to “speak” certain commands to the system. Speaking clearly will help to ensure that the system correctly responds to your commands.

Entertainment Systems

At any time, you may say these commands:

- AM
- FM1
- FM2
- CD
- DVD (if equipped)

During normal radio operation, you may say:

- Seek up
- Seek down

During CD play with the in-dash 6 disc player:

- Track up
- Track down
- Disc up
- Disc down

While in navigation map mode, the following commands are available by voice activation:

- Zoom in
- Zoom out
- Minimum scale
- Maximum scale

While in navigation destination (DEST) mode, the following commands are available by voice activation:

- Home
- Detour

While in navigation map mode, the following commands are available by voice activation:

- Gas station
- Gas
- Hospital
- Police station
- Restaurant
- Hotel

Entertainment Systems

Wireless headphones

Your system is equipped with 2 sets of wireless headphones. (Two AAA batteries are needed to operate the headphones.) Batteries are included.



To install the batteries, lightly press down on the top of the left earpiece and slide the cover off.

When replacing the batteries, use two new batteries (alkaline recommended) and install them with the correct (+) and (-) orientation.

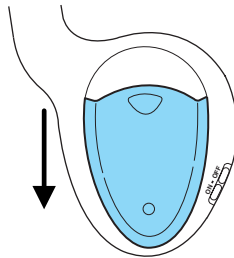

Wireless headphone operation

To operate the headphones:

- Press the ON/OFF button on the left-hand earpiece. The LED light on the right-hand earpiece will illuminate. Press again to turn off.
- Adjust the headphones to comfortably fit your head.
- Adjust the volume control to a comfortable listening level.

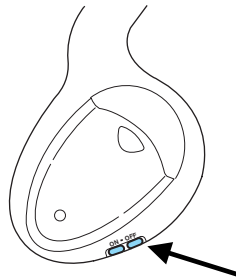

Note: The volume level of the wireless headphones can only be controlled by the thumbwheel. Neither the remote control nor the rear seat controls will affect the volume output of the wireless headphones.

Entertainment Systems

When not using the headphones, shut them off to preserve battery power. The headphones will automatically turn off after five minutes if they have not received an infrared audio signal from the overhead pod.

Ensure that the line of sight between the headphone and infrared transmitter (mounted on the DVD housing) is not obstructed.

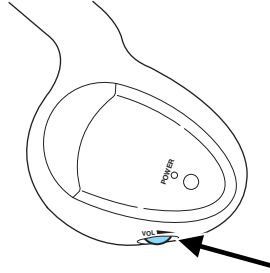

General information

Safety information

Please read and follow all stated safety precautions. Failure to do so may increase your risk of collision and personal injury. Ford Motor Company shall not be liable for any damages of any type arising from failure to follow these guidelines.

Do not attempt to service, repair or modify the system. See your Ford or Lincoln Mercury dealer.



The driver must not attempt to operate any detailed operation of the navigation system while the vehicle is in motion. Give full attention to driving and to the road. Pull off the road and park in a safe place before performing detailed operations.



If the system is used for an extended period of time with the vehicle stationary, ensure that the engine is running to avoid draining the battery.

Do not apply pressure to the display screen.

The navigation system is not a substitute for your personal judgement.

Route suggestions should not supersede local traffic regulations or safe driving practices.

Do not follow route suggestions if they direct you to perform an unsafe or illegal maneuver, would place you in an unsafe situation, or would route you into an area that you consider unsafe.

Drivers should not rely on screen displays while their vehicle is in motion. Let the voice guide you. If viewing is necessary, pull off the road to a safe location.

Entertainment Systems

Do not use the navigation system to locate emergency services.

For road safety reasons, the driver should program the system only when the vehicle is stationary. Certain functions will therefore not operate while the vehicle is in motion.

The map database DVD does not reflect road detours, closures or construction, road characteristics such as rough road surface, slope or grade, weight or height restrictions, traffic congestion, weather or similar conditions.

To use the system as effectively and safely as possible, obtain up-to-date map database DVD whenever they become available.

Set the volume level so that you can hear directions clearly.

Do not disassemble or modify the system as this may lead to damage and void your warranty. If a problem occurs, stop using the system immediately and contact your Ford or Lincoln Dealer.

Federal Communication Commission (FCC) Compliance

Changes or modifications not approved by Ford Lincoln Mercury could void user's authority to operate the equipment. This equipment has been tested and found to comply with the limits for a Class B digital device, pursuant to Part 15 of the FCC Rules. These limits are designed to provide reasonable protection against harmful interference in a residential installation. This equipment generates, uses and can radiate radio frequency energy and, if not installed and used in accordance with the instructions, may cause harmful interference to radio communications.

However, there is no guarantee that interference will not occur in a particular installation. If this equipment does cause harmful interference to radio or television reception, which can be determined by turning the equipment off and on, the user is encouraged to consult the dealer or an experienced radio/TV technician for help.



The database reflects reality as existing before you received the database and it comprises data and information from government and other sources, which may contain errors and omissions.

Accordingly, the database may contain inaccurate or incomplete information due to the passage of time, changing circumstances, and due to the nature of the sources used. The database does not include or reflect information on neighborhood safety, law enforcement, emergency assistance, construction work, road or land closures, vehicle or speed restrictions, road slope or grade, bridge height, weight or other limits, road or traffic conditions, special events, traffic congestion, or travel time.

Entertainment Systems

Radio reception factors

There are certain factors that may effect your radio reception.

- **Distance/strength.** The further an FM signal travels, the weaker it is. The listenable range of the average FM station is approximately 40 km (24 miles). This range can be affected by “signal modulation.” Signal modulation is a process radio stations use to increase their strength/volume relative to other stations.
- **Terrain.** Hills, mountains and tall buildings between your vehicle’s antenna and the radio station signal can cause FM reception problems. Static can be caused on AM stations by power lines, electric fences, traffic lights and thunderstorms. Moving away from an interfering structure (out of its “shadow”) returns your reception to normal.
- **Station overload.** Weak signals are sometimes captured by stronger signals when you pass a broadcast tower. A stronger signal may temporarily overtake a weaker signal and play while the weak station frequency is displayed.

Principles of GPS (global positioning system) operation

Your system directs you based on information derived from global positioning satellites, road maps stored on the DVD, sensors in your vehicle and the desired destination. The system compiles all necessary information to guide you to your selected destination. Space satellites determine the vehicle’s current location and transmit position and time signals to your car.

If the vehicle has been parked for a long period of time, the navigation function may be temporarily unresponsive. The navigation system will operate reliably again once GPS reception is available for a few minutes.

Limited GPS reception

System performance may be adversely affected if GPS reception is interrupted or interference occurs over a distance of several miles. The following are possible causes for GPS reception being interrupted. If the vehicle is:

- in multi-story parking garages
- in tunnels and under bridges
- inside or in between buildings
- by forests or tree-lined avenues
- in heavy rain showers and thunderstorms
- in valleys and in mountainous regions
- roads under cliffs

Entertainment Systems

Ensure that you do not have any metal objects on the rear parcel shelf and that if your windows are tinted, they use non-metal tinting instead of metal oxide tinting. Both of these factors can also interrupt GPS reception.

Cleaning the display

Do not spray cleaning fluid directly onto the unit. Instead, spray onto a soft cloth and gently wipe the unit. Only recommended products should be used.

Do not clean any part of the system with benzene, paint thinner or any other solvent.

Do not spill liquids of any kind onto the unit.

Loading the map DVD

- Your navigation DVD unit is either located:
 - in the front lower center stack area by the passenger's feet (access door),
 - in the trunk,
 - or in the jack compartment.
- Ensure that the vehicle ignition is ON.
- If a DVD is already loaded in the Navigation unit, push the eject button.
- Load the DVD with the printed side up. Do not allow moisture or foreign objects to enter the slot.

The navigation system utilizes a database stored in a special format on a DVD. It is recommended always to use the latest update of this map DVD.

- The navigation system will only work with DVDs specifically intended for your navigation system.
- Always store the map DVDs in their protective cases when not in use.

Ordering additional map DVDs

If you wish to order a replacement or additional map, please call 1-888-NAV-MAPS (1-888-628-6277) or to log onto www.navtech.com.

Entertainment Systems

Latest map DVDs

The map content is constantly changing due to new roads, traffic restrictions, etc. . Therefore, it is not always possible to exactly match the DVD map with the current roadways. For best results, always use the latest version of the map DVD. Map information is regularly updated, but all areas are not necessarily covered to the same level of detail. Some areas, in particular private roads, may not be included on the database. To help with accuracy, always use the latest DVD version for navigation.

Customer service

If you need help operating your navigation/audio system, want to report a map database error or want to obtain a map DVD, please call 1 (888) 628-6277 (NAV-MAPS) or log onto www.navtech.com.

Climate Controls

DUAL AUTOMATIC TEMPERATURE CONTROL (DATC) SYSTEM

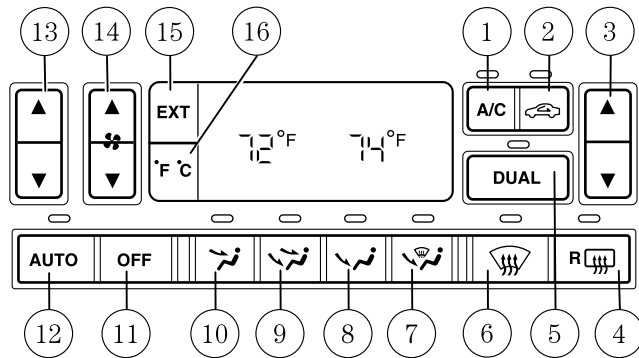

- | | |
|----------------------------------|------------------------------------|
| 1. A/C control | 9. Panel & floor control |
| 2. Recirculated air control | 10. Panel control |
| 3. Passenger temperature control | 11. OFF control |
| 4. Rear defrost control | 12. AUTO control |
| 5. DUAL control | 13. Driver temperature control |
| 6. Defrost control | 14. Fan speed control |
| 7. Floor & Defrost control | 15. Exterior temperature display |
| 8. Floor control | 16. Temperature conversion control |

The DATC system will maintain a selected temperature setting and automatically control the fan speed and airflow location.

The dual temperature zone feature allows the driver and front passenger to set their own independent temperature set points for individual comfort. The system uses common controls for air distribution and fan speed for both driver and passenger.

Climate Controls

Automatic operation

Press AUTO and select the desired temperature. The system will either heat or cool the vehicle to achieve the selected temperature. The system will automatically determine fan speed, airflow location and whether outside or recirculated air is required.

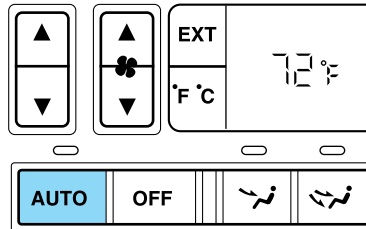

When in automatic operation and weather conditions require heat, the air will be sent to the floor ducts.

However, until the engine is warmed, the fan speed will operate at a low speed and airflow will be directed to the windshield defroster ducts. Upon engine warm up, the system will automatically direct airflow to the floor ducts and operate at the required fan speed to achieve the selected temperature.

If unusual conditions exist (i.e. window fogging, etc.), the manual overrides allow you to select airflow locations and fan speed. To return to automatic operation after an airflow selection, press AUTO.

Single/dual temperature zone

Press DUAL to enable or disable the dual zone temperature feature. When DUAL is pressed, the display window indicates the current temperature setting for the driver and the last temperature setting for the passenger. In addition to the DUAL control, the passenger may manually enable the dual zone temperature feature by pressing the passenger temperature control.

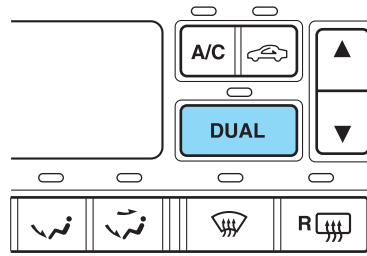

The DUAL indicator will be lit when the dual zone temperature feature is selected.

Driver/passenger temperature selection

To control the temperature, select the desired temperature by pressing the driver/passenger temperature controls.

Climate Controls

Temperature conversion

Press the Fahrenheit/Celsius (°F/°C) control to switch between Fahrenheit and Celsius.

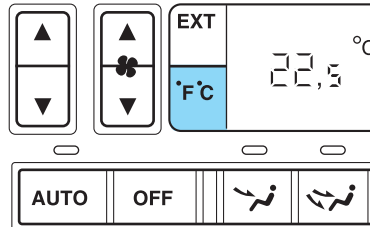

Displaying outside temperature

Press Ext to display the outside temperature. The outside temperature will be displayed until Ext has been pressed again.

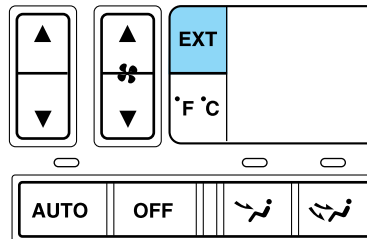

If the interior temperature or fan speed are adjusted or a manual override is selected while the outside temperature is being displayed, the new temperature, fan speed or override control will appear in the display window for four seconds, the outside temperature will then return to the display window.

The outside temperature reading is most accurate when the vehicle is moving. Higher temperature readings may be displayed when the vehicle is not moving. Due to locations, the outside temperature readings from the vehicle may not agree with those obtained from the radio station broadcasts.

Climate Controls

Fan speed ()

When in automatic operation, fan speed operates as necessary to achieve the selected temperature. If desired, the fan speed can be adjusted manually through the use of the fan speed control.

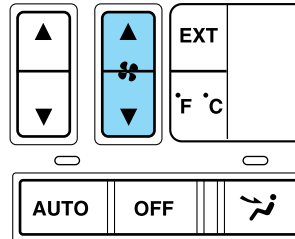

• A/C control

 (air conditioning) — Used to manually enable or disable air conditioning in all modes except Defrost. The A/C will only function if the outside temperature is above approximately 2°C (35°F). In Defrost, the A/C will operate automatically if the outside temperature is above approximately 2°C (35°F). However, the A/C indicator will not be lit in Defrost mode.

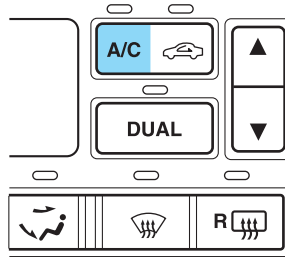

In automatic operation, the air conditioning operates as necessary to achieve the selected temperature and the A/C indicator will be lit if the outside temperature is above approximately 2°C (35°F). You may override the automatic A/C operation at any time. To manually control the A/C operation and cancel automatic A/C operation, press the A/C control. When the air conditioning is manually controlled in automatic operation, the AUTO indicator will remain lit. To return to automatic air conditioning operation, press AUTO.

Since the air conditioner removes moisture from the air, it is considered normal operation if clear water drips on the ground under the air conditioner drain.

Climate Controls

• Recirculated air

 (recirculated air) — Used to manually enable or disable the operation of recirculated air in all modes except Defrost. When the air conditioning is operating, recirculated air helps to reduce the amount of time required to cool the inside of the vehicle. Recirculated air will reduce undesirable odors from entering the vehicle.

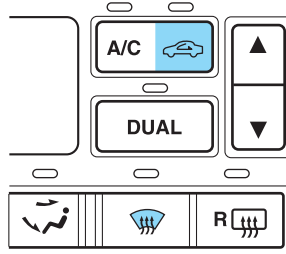

Recirculated air cannot be selected in Defrost, as interior fogging may occur. In Floor and Floor and Defrost modes, the recirculated air control can be enabled. However, to reduce the risk of fogging, the recirculated air button will be disabled in approximately 4 minutes.

In automatic operation, the recirculated air operates automatically as necessary to achieve the selected temperature. If desired, recirculated air can be controlled manually through the use of the recirculated air control. When recirculated air is controlled while in automatic operation, the AUTO indicator will remain lit and the system will remain in automatic operation. To return to automatic recirculated air, press AUTO.

Under cold or damp conditions, do not leave the climate control system in recirculated air for extended periods of time as this may cause interior fogging of the windows.

Manual override controls

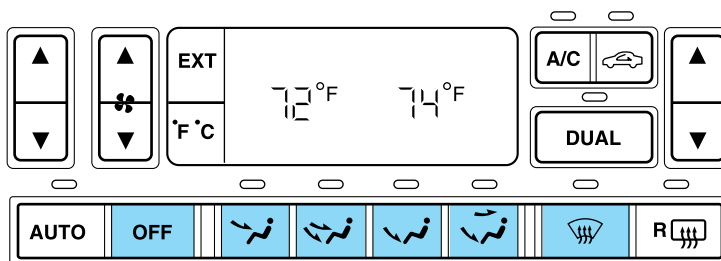

The manual override controls allow you to determine where airflow is directed. To return to full automatic control, press AUTO.

Climate Controls

- Off-Outside air is shut out and the fan will not operate. This mode will reduce undesirable odors from entering the vehicle but may increase the possibility of interior window fogging.
- Panel - Distributes outside or recirculated air through the instrument panel registers. The A/C compressor will only function if the outside temperature is above approximately 2°C (35°F). The system will allow some airflow through the floor ducts.
- Panel and Floor -Distributes outside or recirculated air through the instrument panel registers and floor ducts. The A/C compressor will only function if the outside temperature is above approximately 2°C (35°F). The air distributed through the floor ducts will be slightly warmer than that sent to the instrument panel registers.
- Floor -Distributes outside or recirculated air through the floor ducts. The A/C compressor will only function if the outside temperature is above approximately 2°C (35°F).
- Floor & Defrost -Distributes outside or recirculated air through the floor ducts, windshield defroster ducts and the side window demisters. The A/C compressor will operate automatically if the outside temperature is above approximately 2°C (35°F). The air distributed through the floor ducts will be slightly warmer than that sent to the windshield defroster ducts and the side window demisters.
- Defrost-Distributes outside air through the windshield defroster ducts and the side window demisters. The A/C compressor will operate automatically if the outside temperature is above approximately 2°C (35°F). This mode will clear ice and fog from the windshield.

Operating tips

- To reduce fogging in humid weather, place the climate control system in Defrost mode and Rear Defrost before driving.
- To reduce humidity buildup inside the vehicle in warm weather conditions, don't drive with the climate control system in the Off mode.
- To reduce humidity buildup inside the vehicle in cold weather conditions, don't drive with the climate control system in recirculation mode or Off mode.
- Remove any snow, ice or leaves from the exterior base of the windshield.
- To increase the efficiency of the A/C, drive with the windows slightly open for 2–3 minutes after start up or until the vehicle has been "aired out."

Climate Controls

- Do not place objects under the front seat or over the defroster ducts. They may reduce visibility, fall into the ducts, or degrade the performance of your climate control system.



Do not place objects on top of the instrument panel, as these objects may become projectiles in a collision or sudden stop.

AUXILIARY CLIMATE CONTROLS

The auxiliary climate control feature provides increased capacity to quickly heat or cool the vehicle. The auxiliary climate controls are located in the overhead console of the first row seating and in the floor console of the second row seating.

The auxiliary climate controls are independent of the main climate control system. If the main climate control system is in the Off position, the auxiliary climate controls will still operate. However, if the main climate control system is ON, the auxiliary air will not be cooled unless the air conditioning is functioning on the main climate control system.

The auxiliary unit can be controlled either by the front seat passengers using the front auxiliary control or by the rear seat passengers using the rear auxiliary control, but not both.

To control the auxiliary unit using the rear control, the front control must be in the REAR position.

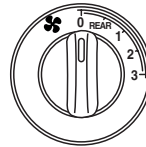

Controls the fan speed in the rear of the vehicle.

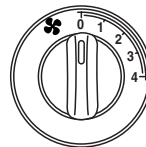

Controls the temperature of the airflow in the rear of the vehicle.

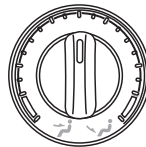

Climate Controls

Controls the direction of the airflow in the rear of the vehicle. When Floor is selected, airflow will be directed through the floor registers. When Panel is selected, airflow is directed through the overhead registers.



Press the mode selector once to select air distribution through the overhead vents. The  icon will illuminate on the temperature selector.



Press the mode selector again to select air distribution through the floor vents. The  icon will illuminate on the temperature selector. Only the auxiliary control head (front or rear) that is active will have the indicator lights functioning.

FLOOR CONSOLE CLIMATE CONTROLS

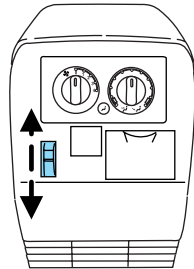

The floor console climate control system allows the rear passengers to manually enable or disable airflow through the floor console. However, air temperature and fan speed are controlled by the main climate control system and by the auxiliary climate control system.

Climate Controls

AIRFLOW CONTROL

Controls whether airflow will or will not be distributed through the floor console.

To select airflow from the registers of the floor console, slide the airflow control to the top.

To select no airflow from the registers of the floor console, slide the airflow control to the bottom.



REAR WINDOW DEFROSTER

Used to manually enable or disable rear window defrost in all modes.

After approximately 10 minutes of rear defrost operation, the climate control system will automatically disable the rear defrost operation. If desired, the rear defrost can be manually disabled through the use of the rear defrost button. When operating, the rear defrost indicator will be lit.



HEADLAMP CONTROL ☀

Rotate the headlamp control clockwise to the first position to turn on the parking lamps. Rotate clockwise to the second position to also turn on the headlamps.

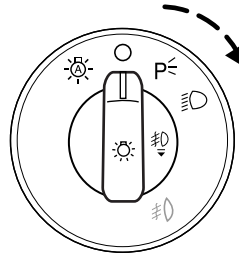

Foglamp control #D

The headlamp control also operates the foglamps. The foglamps can be turned on only when the headlamp control is in the ☀, ☀ or P< position and the high beams are not turned on.

Pull headlamp control towards you to turn foglamps on. The foglamp indicator light #D will illuminate if the ignition is in the Run and Key On position.

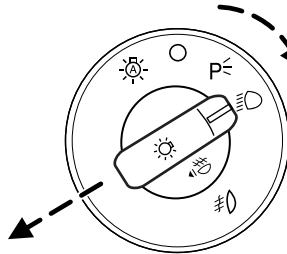

Autolamp control ☀

The autolamp system provides light sensitive automatic on-off control of the exterior lights normally controlled by the headlamp control.

The autolamp system also keeps the lights on for approximately 20 seconds after the ignition switch is turned to the OFF position.

- To turn autolamps on, rotate the control counterclockwise.
- To turn autolamps off, rotate the control clockwise to the OFF position.

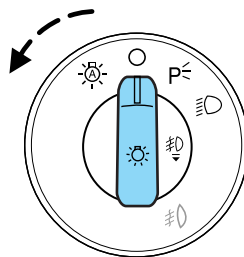

Lights

Autolamp exit time delay, manual sequence

This option allows you to change the length of the autolamp exit delay.

To program the auto lamp exit time delay:

1. Start with the ignition in OFF and the autolamps selected.
2. Deselect the auto lamps.
3. Put the ignition on RUN.
4. Put the ignition in OFF.
5. Select the autolamps.
 - **NOTE:** Steps 2 through 5 must be performed within a 10 second period.
 - At this point, the headlamps and park lamps will turn on.
6. Deselect the auto lamps after the desired auto lamp delay time (maximum of 3 minutes).
 - At this point, the headlamps and park lamps will turn off.

The default for autolamp exit delay time is 20 seconds. Following a vehicle battery disconnect/reconnect auto lamp delay exit time will be retained.

Autolamp exit time delay, message center sequence

This option allows you to change the length of time of the autolamp exit delay using the message center. You will have the ability to change the autolamp exit delay time of the autolamp ON time when the instrument cluster (IC) message center is enabled (ignition in run or accessory position).

There are 8 distinct and separate set points or values for auto lamp delay exit time in seconds. The following are predefined set points or auto lamp exit delay time values: 0, 10, 20, 30, 60, 90, 120, 180, seconds (i.e. 0 to 3 minutes).

The following steps are used to program the autolamp exit time delay using the message center:

1. The message center will display the last autolamp exit delay time in seconds.
2. You can respond to this message by 1 of 4 methods:
 - **No Response** - The message center then times out after 4 seconds and displays it's normal text information.
 - **Press the info button** - The message center then displays its normal text information.

Lights

- **Press the setup button** - The message center then displays the next menu selection in its list. (6)
 - **Press the reset button** - The message center then proceeds to the next sequence/step (3) below.
 - The message center sends/issues the “Autolamp Delay Command” to the body security module (BSM).
 - The body security module responds within 100 milliseconds with next auto lamp exit delay time.
3. Next sequence/step number is one (1) steps 1,2,3,4 & 5 are repeated until exit via step 2.
4. The message center displays the next menu selection.

Daytime running lamps (DRL) (if equipped)

To activate DRL:

- the ignition must be in the ON position and
- the headlamp control is in the OFF or Parking lamps position
- the parking brake must be disengaged.

 Always remember to turn on your headlamps at dusk or during inclement weather. The Daytime Running Light (DRL) System does not activate your tail lamps and generally may not provide adequate lighting during these conditions. Failure to activate your headlamps under these conditions may result in a collision.

High beams

Push the lever toward the instrument panel to activate. Pull the lever towards you to deactivate.

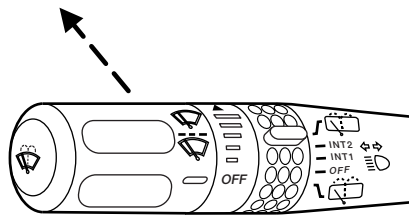

Lights

Flash to pass

Pull toward you slightly to activate and release to deactivate.

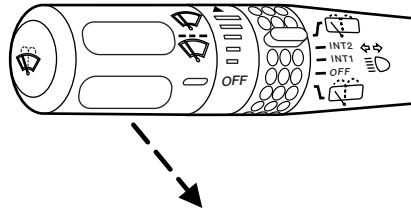

PANEL DIMMER CONTROL

Use to adjust the brightness of the instrument panel and all applicable switches in the vehicle during headlamp and parklamp operation.

Move the control to the full upright position, past detent, to turn on the interior lamps.

Move the control to the full down position, past detent, to prevent the interior lights from illuminating when the doors are opened. When the control is in the full down position, it acts as a dome defeat/override.

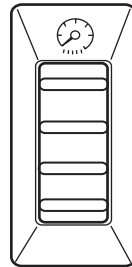

VERTICAL AIM ADJUSTMENT

Your vehicle is fitted with either **VOR** (conventional halogen) or **VOL** (High Intensity Discharge - HID) headlamps. The adjustment procedure depends on the type of headlamps that are equipped on your vehicle. **VOR** or **VOL** is marked on the bottom of the headlamp in the center of the lamp. Please check the lens markings prior to adjusting the vehicle aim.

1. Park the vehicle on a level surface approximately 7.6 meters (25 feet) from a vertical wall or screen directly in front of it.

- (1) Eight feet
- (2) **VOR** – Measurement of the center height of lamp to ground
VOL – Subtract 50 mm's (2 inches) from the measurement of the center height of the lamp to ground
- (3) Twenty-five feet
- (4) Horizontal reference line

Lights

2. **VOR:** Measure the height from the center of your headlamp to the ground and mark a 2.4 meter (8 foot) horizontal reference line on the vertical wall or screen at this height (a piece of masking tape works well). The center of the lamp is marked by a 3.0 mm circle on the headlamp lens.

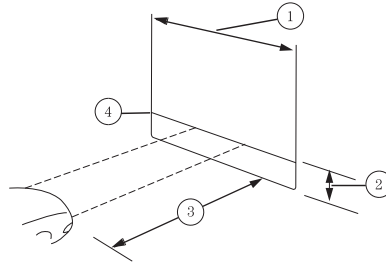

VOL: Measure the height from the center of your headlamp to the ground, subtract 50 mm's, (2.1 inches), and mark a 2.4 meter (8 foot) horizontal reference line on the vertical wall or screen at this height (a piece of masking tape works well). The center of the lamp is marked by a 3.0 mm circle on the headlamp lens.

3. Turn on the low beam headlamps to illuminate the wall or screen and open the hood.

4. On the wall or screen you will observe a light pattern with a distinct horizontal edge of high intensity with a slight angle towards the right. If this is not at the horizontal reference line, the beam will need to be adjusted.

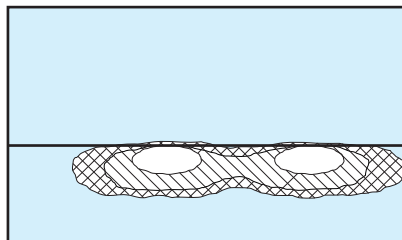

5. Locate the vertical adjuster hole in the upper radiator sight shield. The hole is located on the top of the headlamp. Insert a standard #2 Phillips screwdriver into the hole until it engages the vertical adjuster gear. Turn the screwdriver either counterclockwise (to adjust down) or clockwise to (to adjust up) aligning the upper edge of the light pattern up to the horizontal line.

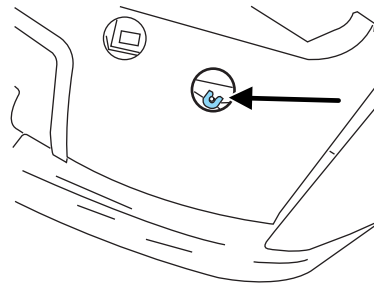

6. HORIZONTAL AIM IS NOT REQUIRED FOR THIS VEHICLE AND IS NON-ADJUSTABLE.

7. Close the hood and turn off the lamps.

Lights

TURN SIGNAL CONTROL ⇐⇒

- Push down to activate the left turn signal.
- Push up to activate the right turn signal.
- Turn signal will shut off headlamps, in DRL equipped vehicles, in daytime driving.

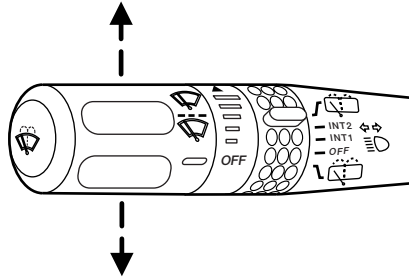

INTERIOR LAMPS

Front row map lights (if equipped)

To turn on the map lights, press the edge of the light.

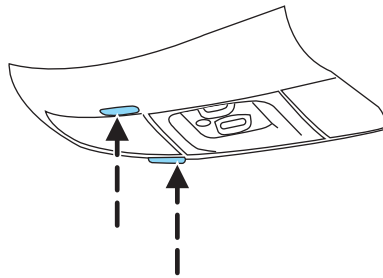

Second row dome lamps

The dome lamp lights when:

- any door is opened.
- the instrument panel dimmer switch is rotated up until the courtesy lamps come on.
- any of the remote entry controls are pressed and the ignition is OFF.

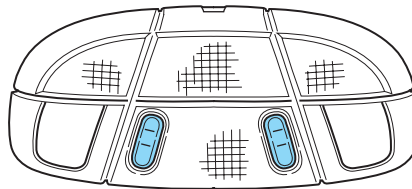

The reading portion, the two outer lights, can only be toggled on and off at the lamp.

Lights

Third row courtesies/reading/cargo lamps

The dome portion of the lamp, the center light, can be turned on when the headlamp control is rotated fully up or when an door is opened.

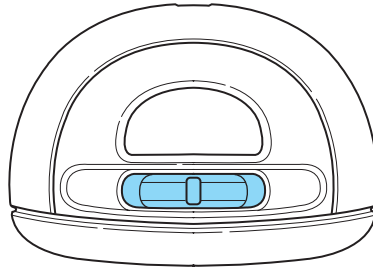

With the ignition key in the ACC or ON position, the rear dome lamp can be turned ON or OFF by sliding the control.

BULBS

Replacing exterior bulbs

Check the operation of all the bulbs frequently.

Using the right bulbs

Replacement bulbs are specified in the chart below. Headlamp bulbs must be marked with an authorized "D.O.T." for North America to assure lamp performance, light brightness and pattern and safe visibility. The correct bulbs will not damage the lamp assembly or void the lamp assembly warranty and will provide quality bulb burn time.

Function	Number of bulbs	Trade number
Park/turn lamps (front)	2	3157 AK (amber)
TH headlamps, low beam	2	H11
HID headlamps, low beam*	2	D2R
Headlamps, high beam	2	9005 (HB3)
Front sidemarker	2	WY5W
Rear stop/turn/tail lamps	4	3057K
Back-up lamps	2	3156K

Lights

Function	Number of bulbs	Trade number
Fog lamp	2	9140
Liftgate lamp	4	916
High-mount stop lamp	32 LEDES	2C54-13A613**
Rear license plate lamp	2	168
Mirror turn signal lamp	2	906
Approach lamp	2	912
Cargo lamp	1	211-2
Interior overhead lamp	1	912 (906)
Map lamps	2	168 (T10)
Front footwell light	2	194
All replacement bulbs are clear in color except where noted.		
To replace all instrument panel lights see your dealer.		
*For vehicles with HID lamps see your dealer.		
**The entire LED display must be replaced.		

Replacing the interior bulbs

Check the operation of all bulbs frequently.

Map lamps

To change the map lamp bulbs:

1. Use a small screwdriver to remove the map lamp lens.
2. To remove the old bulb, twist $\frac{1}{4}$ turn and pull it out.
3. Twist in a new bulb.
4. Align and press the map lamp lens back on and test the lamp operation.

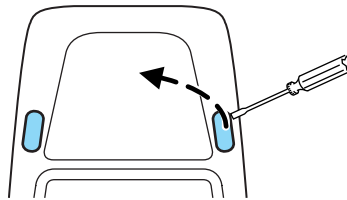

Lights

Replacing headlamp bulbs

To remove the headlamps from the vehicle to change the HIGH BEAM bulb:

1. Make sure the headlamp switch is in the OFF position, then open the hood.
2. Remove the plastic radiator cover over the headlamps by grasping the rear edge of the cover and pulling up and toward you. This will disengage the four snap-on attachment of the cover. Set the cover aside.
3. Pry back the top corner of the radiator cover to gain access to the inner retaining pins. At the back of the headlamp, pry up and remove the two retainer pins to release the headlamp assembly from the vehicle and pull headlamp forward.
4. Disconnect the electrical connector by pulling downward.
5. Rotate the high beam bulb counterclockwise until the tabs on the bulb line up with the ring, and the bulb can be removed by pulling rearward.

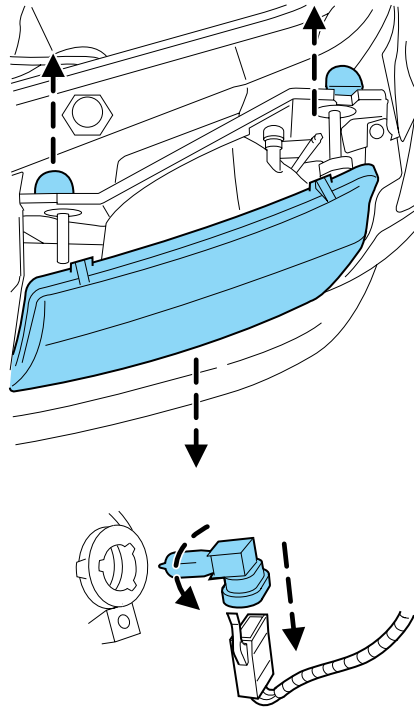

To install the new bulb:



Handle a halogen headlamp bulb carefully and keep out of children's reach. Grasp the bulb only by its plastic base and do not touch the glass. The oil from your hand could cause the bulb to break the next time the headlamps are operated.

Lights

1. Push the bulb straight in, carefully aligning the plastic tabs in the base of the bulb with the openings in the plastic ring.

2. Rotate the bulb clockwise until it stops.

3. Reconnect the electrical connector to the bulb.

4. Install the headlamp on the vehicle by aligning the four plastic projections into the four holes, pushing rearward to seat the lamp assembly.

5. Insert the two retainers, making sure that the retainers go over both plastic projections on each side of the lamp, pushing the retainers down until they seat.

6. Replace the plastic radiator cover by inserting the edge of the cover into the tongue and groove of the mating cover, and then rotating the cover downward. Press firmly on the cover over each headlamp and in the center of the cover to re-engage the snap in fasteners.

7. Turn the headlamps on and make sure they work properly. If the headlamp was correctly aligned before you changed the bulb, you should not need to align it again.

If a low beam headlamp bulb fails, take your vehicle to your dealer or a qualified service technician to have it replaced.

Replacing HID headlamp bulbs (if equipped)

The low beam headlamps on your vehicle use a “high intensity discharge” source. These lamps operate at a high voltage. The bulb is NOT replaceable. When the bulb is burned out, the bulb assembly must be replaced by your dealer or a qualified technician.

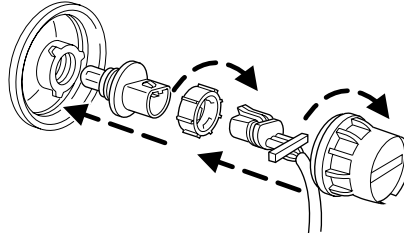

Lights

Replacing front parking lamp/turn signal/sidemarkers bulbs

To remove the headlamps from the vehicle and to change the front turn signal lamp bulbs:

1. Make sure the headlamp switch is in the OFF position, then open the hood.
2. Remove the plastic radiator cover over the headlamps by grasping the rear edge of the cover and pulling up and toward you. This will disengage the four snap-on attachments on the cover. Set the cover aside.
3. Pry back the top corner of the radiator cover to gain access to the inner retaining pins. At the back of the headlamp, pry up and remove the two retainer pins to release the headlamp assembly from the vehicle and pull headlamp forward.
4. Rotate the bulb socket counterclockwise and remove from lamp assembly.
5. Carefully pull the bulb straight out of socket and push in the new bulb.
6. Install bulb socket in lamp assembly by turning clockwise.

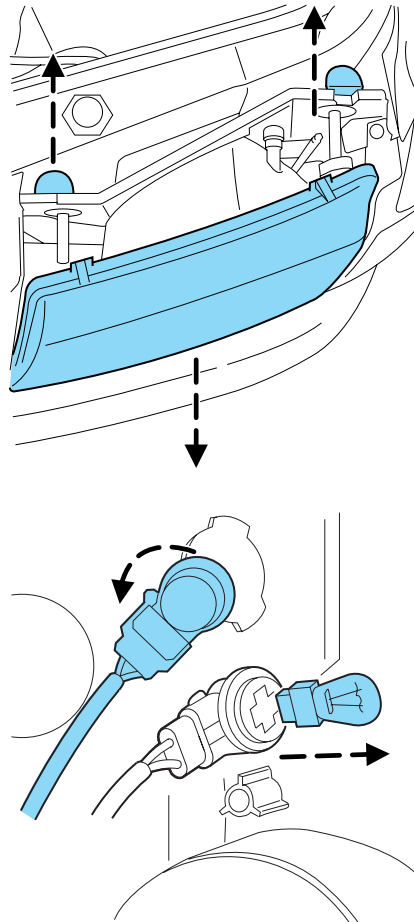

To replace the park/sidemarkers bulb:

1. Rotate the bulb socket counterclockwise and remove from the lamp assembly.

Lights

2. Carefully pull the bulb straight out of the socket and push in the new bulb.
3. Install the bulb socket in the lamp assembly by turning it counterclockwise.

To re-install the headlamp on the vehicle:

1. Install the headlamp on the vehicle by aligning the four plastic projections into the four holes, pushing rearward to seat the lamp assembly.
2. Insert the two retainers, making sure that the retainers go over both plastic projections on each side of the lamp, pushing the retainers down until they seat.
3. Replace the plastic radiator cover by inserting the edge of the cover into the tongue and groove of the mating cover, and then rotating the cover downward. Press firmly on the cover over each headlamp and in the center of the cover to re-engage the snap-in fasteners.
4. Turn the headlamps on and make sure they work properly.

Replacing tail/brake/turn/sidemarkers/backup lamp bulbs

The tail/brake/turn/sidemarkers/backup bulbs are located in the tail lamp assembly, one just below the other. Follow the same steps to replace each bulb:

1. Make sure the headlamp switch is in the OFF position and then open the liftgate to expose the lamp assemblies.
2. Remove the two screws from the lamp assembly.
3. Pull the lamp assembly towards the rear and side of the vehicle at an angle, carefully removing it from the vehicle.
4. Rotate the bulb socket counterclockwise and remove from lamp assembly.
5. Pull the bulb straight out of the socket and push in the new bulb.
6. To complete installation, follow the removal procedure in reverse order.

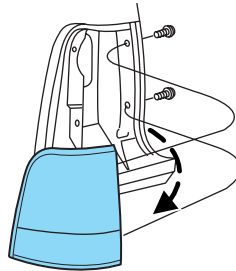

Lights

Replacing liftgate tail lamp bulb

1. Make sure the headlamp switch is in the OFF position and then open the liftgate to expose the fasteners.
2. Remove the two acorn nuts from the lamp assembly.
3. Pull the lamp off by pulling rearward on the lamp.
4. Rotate the bulb socket counterclockwise and carefully remove the lamp assembly.
5. Pull the bulb straight out of the socket and push in the new bulb.
6. To complete installation, follow the removal procedure in reverse order.

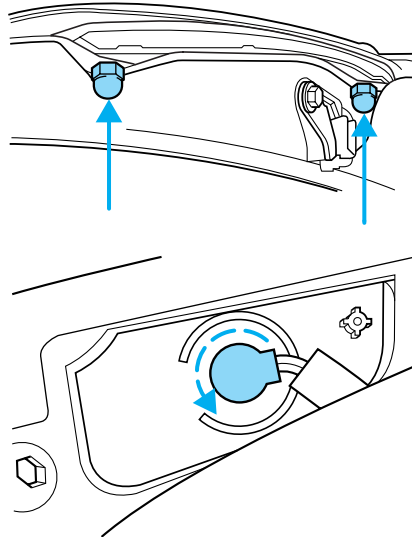

Replacing foglamp bulbs

1. Make sure the headlamp switch is in the OFF position and then reach under the front of the front bumper and remove the bulb socket from the foglamp by turning counterclockwise.
2. Disconnect the electrical connector from the foglamp bulb.
3. Connect the electrical connector to the new foglamp bulb.
4. Install the bulb socket in the foglamp by turning clockwise.

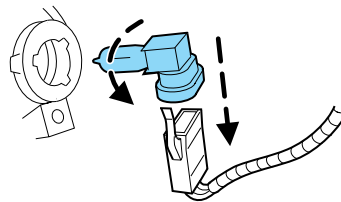

Lights

Replacing license plate lamp bulbs

1. Make sure the headlamp switch is in the OFF position, then remove the screw and pry the license plate lamp lens down.
2. Pull down the lens assembly and rotate the lens counterclockwise.
3. Grasp the bulb and carefully pull the bulb from the socket and push in the new bulb.
4. Align the socket and bulb with the lens assembly and rotate until seated.
5. Re-insert the bulb and lens assembly into the opening and install the screw.

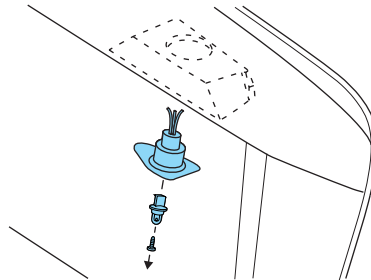

Replacing center high-mount stop lamp (CHMSL) bulbs

1. Make sure the headlamp switch is in the OFF position and open the liftgate.
2. Remove the upper portion of the liftgate trim by grasping the lift gate trim around the upper portion and pull it towards the glass. **Note:** The liftgate trim is attached at 8 locations with snap-in attachments.
3. Disconnect the electrical connector to the CHMSL by depressing the tab and pull to separate the electrical connectors.
4. Use a 9mm torx hex socket/wrench to unscrew the two CHMSL bolts that attach the CHMSL to the liftgate.
5. Grasp the CHMSL and pull it down to disengage the center snap-in attachment.
6. Replace the lamp by following the above procedures in reverse order.

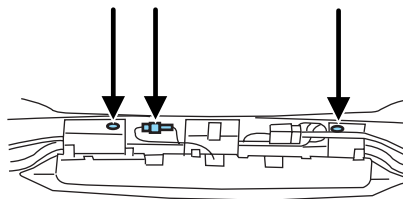
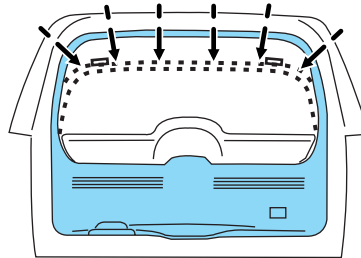

Approach lamp/mirror turn signal bulb removal

To change the bulbs:

1. Make sure the headlamp switch is in the OFF position.
2. Remove the approach lamp/turn signal lens from the mirror housing using a standard flat screwdriver to pry the lamp assembly out.
3. Pull the lens out to remove it from the mirror assembly
4. Disconnect the bulb assembly from the lens.
5. Remove and replace the bulb.
6. Reverse the order to reassemble lamp and lens.

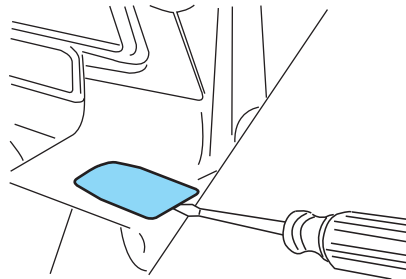
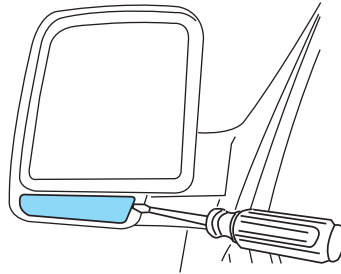

Driver Controls

WINDSHIELD WIPER/WASHER CONTROLS

Rotate the windshield wiper control to the desired interval, low or high speed position.

The bars of varying length are for intermittent wipers. When in this position rotate the control upward for fast intervals and downward for slow intervals.

Push (tap) the end of the stalk briefly for a single swipe (no wash). Push and hold for three swipes with wash. Push and hold for a longer wash (up to ten seconds).

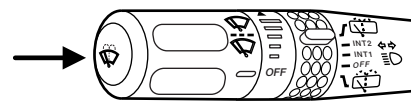
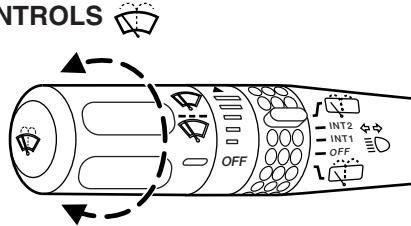

Rear window wiper/washer controls

For rear wiper operation, rotate the rear window wiper and washer control to the desired position. Select:

INT 2 — Normal speed operation of rear wiper.

INT 1 — Intermittent operation of rear wiper.

OFF — Rear wiper and washer off.

For rear wash cycle, rotate (and hold as desired) the rear wiper/washer control to either  position.

From either position, the control will automatically return to the INT 2 or OFF position.

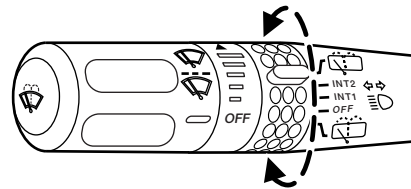

Windshield wiper blades

Check the wiper blades for wear at least twice a year or when they seem less effective. Substances such as tree sap and some hot wax treatments used by commercial car washes reduce the effectiveness of wiper blades.

Checking the wiper blades

If the wiper blades do not wipe properly, clean both the windshield and wiper blades using undiluted windshield wiper solution or a mild detergent. Rinse thoroughly with clean water. To avoid damaging the blades, do not use fuel, kerosene, paint thinner or other solvents.

Driver Controls

Changing the wiper blades

It is recommended that wiper blades are renewed before winter.

To replace the wiper blades:

1. Fold back the wiper arm and position the wiper blade at right angles to the wiper arm.
2. To remove, press the retaining clip (A) to disengage the wiper blade, then pull the blade down toward the windshield to remove it from the arm.

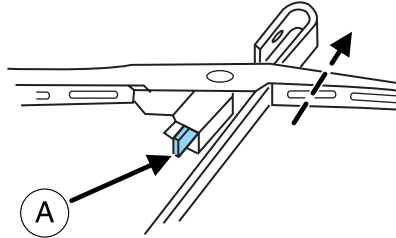

3. Install the new wiper blade on the arm and press it into place until a click is heard.

Rear window wiper blade

Refer to *Windshield wiper blades* in this section and follow the same procedure given for checking and changing the wiper blades.

TILT STEERING

Push the lever down to unlock the steering column. While the lever is in the down position, tilt the steering column to the desired position.

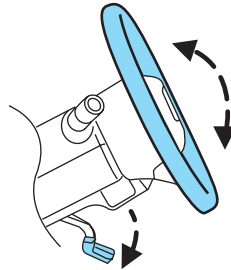

Driver Controls

While holding the steering wheel, find the nearest gear mesh point and pull the lever up to its original position to lock the steering column.

 Never adjust the steering column when the vehicle is moving.

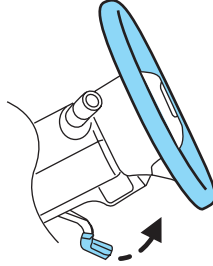

ILLUMINATED VISOR MIRROR

Lift the mirror cover to turn on the visor mirror lamps.

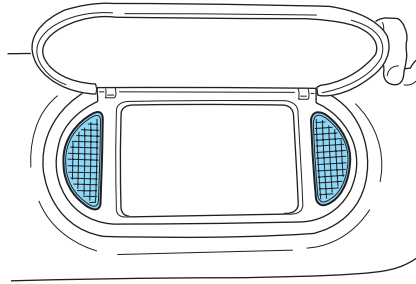

OVERHEAD CONSOLE

The appearance of your vehicle's overhead console will vary according to your option package.

Storage compartment

Push up on the bar to open the storage compartment. Release your hand and the door will fully open.

The storage compartment may be used to secure sunglasses or a similar object.

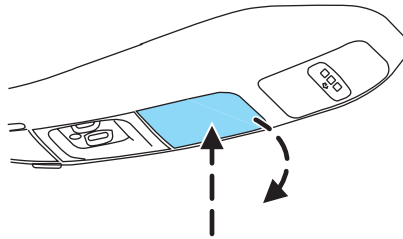

Driver Controls

Moon roof (if equipped)

You can move the glass panel of the moon roof back to open or tilt up to ventilate the vehicle.

To open the moon roof:

The moon roof is equipped with an automatic, one-touch, express opening feature. Press and momentarily hold the rear portion of the control. To stop motion at any time during the one-touch opening, press the control a second time.

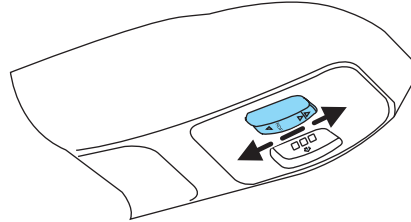

To close the moon roof:

Press and hold the front portion of the control until the glass panel stops moving. Once fully closed, the rear of the glass panel will appear higher than the front edge.

To vent:

To tilt the moon roof into the vent position (when the glass panel is closed), press and hold the front portion of the control. To close the moon roof from the vent position, press and hold the rear portion of the control until the glass panel stops moving.

If the battery is disconnected, discharged, or a new battery is installed, the moon roof needs to be opened to the vent position to reset the moon roof positions.

The moon roof has a sliding shade that can be opened or closed when the glass panel is shut. To close the shade, pull it toward the front of the vehicle.



Do not let children play with the moon roof. They may seriously hurt themselves.

Driver Controls

CLOCK

Press the right control to increase the time displayed.

Press the left control to decrease the time displayed.

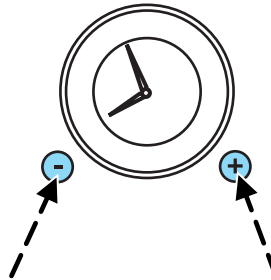

AUXILIARY POWER POINT (IF EQUIPPED)^{12V}

Power outlets are designed for accessory plugs only. Do not hang any type of accessory or accessory bracket from the plug. Improper use of the power outlet can cause damage not covered by your warranty.

The auxiliary power point is located inside the center console.

Do not plug optional electrical accessories into the cigarette lighter. Use the power point.



An auxiliary power point is located on the lower rear side of the center console. The power point is accessible from the rear seats.

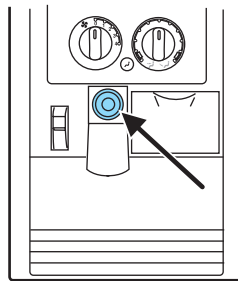

Driver Controls

Another auxiliary power point is located on the right rear quarter panel. The power point is accessible from the liftgate.

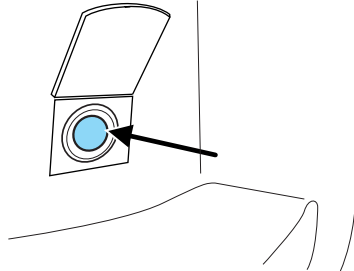

The maximum current draw of any single power point should not exceed its fuse rating, otherwise this will result in a blown fuse.

Do not use the cigarette/cigar lighter element in any power point.

Keep power point caps closed when not in use.

POWER WINDOWS



When closing the power windows, you should verify they are free of obstructions and ensure that children and/or pets are not in the proximity of the window openings.

The power window switches located on the center console are called push-pull switches.

- A. Drivers side
- B. Window lock
- C. Front passenger side
- D. Left and right rear passenger

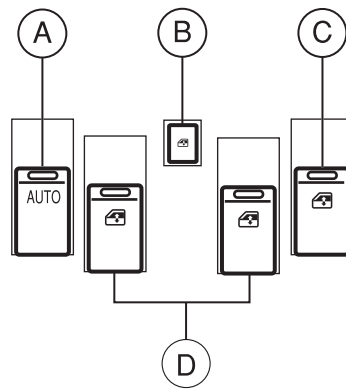

Driver Controls

The following views are the driver's side switches:

Normal operation

- Push down (to the first detent) and hold the top portion of the switch to open.

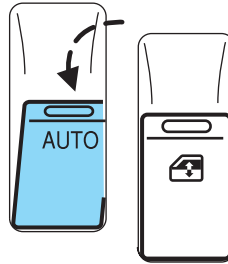

- Pull up (to the first detent) and hold the top portion of the switch to close.

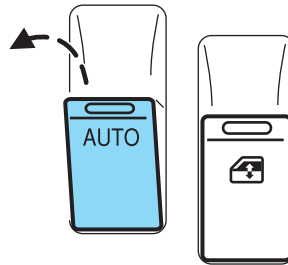

The following view is the power window switch on the rear door trim panels.

- Press and hold the top or bottom of the rear rocker switches to open or close.

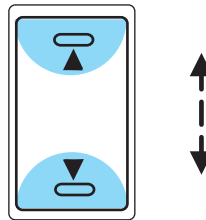

Driver Controls

One touch up or down

This feature is present on the driver's window only.

To operate ONE TOUCH DOWN:

- Press the switch completely down to the second detent and release quickly. The driver's window will open fully. Momentarily press the switch to any position to stop the window operation.

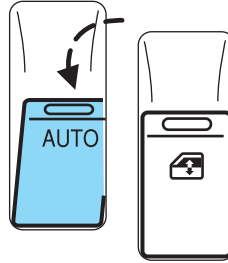

If the switch is pressed and held to the normal close or ONE TOUCH UP position during a ONE TOUCH DOWN event, the window will stop. If, after 1/2 second the switch is still held, the window will perform a normal close or ONE TOUCH UP.

To operate ONE TOUCH UP:

- Pull the switch completely up to the second detent and release quickly. The driver's window will close fully. Momentarily press the switch to any position to stop the one touch up.

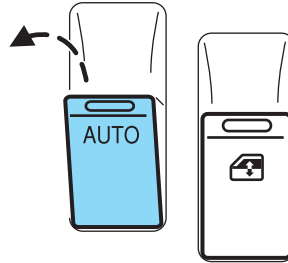

If the switch is pressed and held to the normal open or ONE TOUCH DOWN position during a ONE TOUCH UP event, the window will stop. If, after 1/2 second the switch is still held, the window will perform a normal open or ONE TOUCH DOWN.

Bounce-Back

When an obstacle has been detected in the window opening as the window is moving upward, the window will automatically reverse direction and move down. This is known as “bounce-back”. If the ignition is turned OFF (without accessory delay being active) during bounce-back, the window will move down until the bounce back position is reached.

Security Override

If during a bounce-back condition, the switch is released to the neutral position, then held in the one touch up position within two seconds after the window reaches the bounce-back position, **the window will travel**

Driver Controls

up with no bounce-back protection. If the switch is released before the window reaches fully closed or the ignition is turned OFF (without accessory delay being active), the window will stop. Security override can be used if there is ice on the window or seals, causing a restriction.

Window lock

The window lock feature allows only the driver to operate the rear power windows.

To lock out the rear window controls push the control down. To restore the rear window controls, push the control down. The control will spring back up to the neutral position.

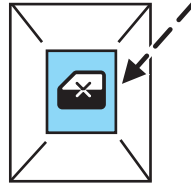

Accessory delay

With accessory delay, the radio, windows, and moonroof operate for up to ten minutes after the ignition switch is turned from the ON to the OFF position or until any door is opened.

MIRRORS

Automatic dimming rear view mirror (if equipped)

Your vehicle is equipped with an inside rear view mirror with an auto-dimming function. The electronic day/night mirror will change from the normal state to the non-glare state when bright lights (glare) reach the inside rear view mirror. When the inside rear view mirror detects bright light from behind the vehicle, the inside rear view mirror will automatically adjust (darken) to minimize glare.

Do not block the sensor on the backside of the inside rear view mirror since this may impair proper system performance.

Driver Controls

Press the control to turn the mirror OFF or AUTO.

The mirror will automatically return to the normal state whenever the vehicle is placed in R (Reverse) (when the mirror is on) to ensure a clear view when backing up.

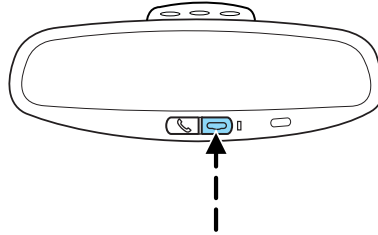

Power side view mirrors

The ignition must be in the ACC or ON position to adjust the power side view mirrors.

To adjust your mirrors:

1. Rotate the control clockwise to adjust the right mirror and rotate the control counterclockwise to adjust the left mirror.

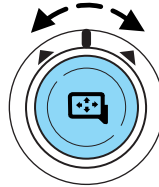

2. Move the control in the direction you wish to tilt the mirror.

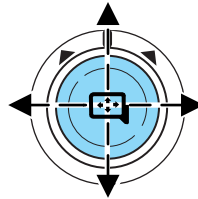

3. Return to the center position to lock mirrors in place.

Driver Controls

Heated outside mirrors

Both mirrors are heated automatically to remove ice, mist and fog when the rear window defrost is activated.

Do not remove ice from the mirrors with a scraper or attempt to readjust the mirror glass if it is frozen in place. These actions could cause damage to the glass and mirrors.

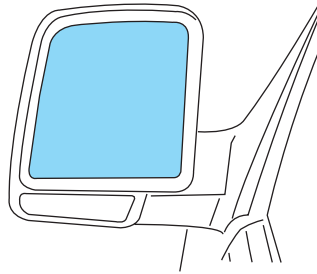

Signal mirrors

When the turn signal is activated, the lower portion of the mirror housing will blink.

This provides an additional warning to other drivers that your vehicle is about to turn.

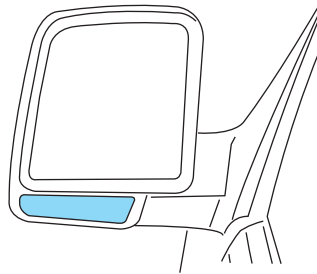

Fold-away mirrors

Pull the side mirrors in carefully when driving through a narrow space, like an automatic car wash.

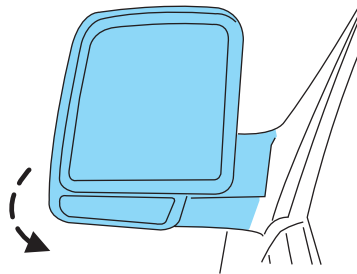

Driver Controls

Reverse tilt down mirrors

The side mirrors tilt down when the vehicle is put in R (Reverse).

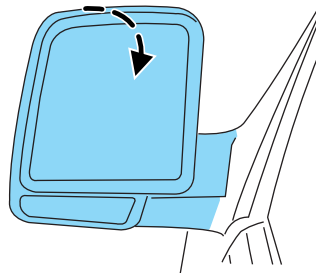

The reverse mirror feature can be turned ON and OFF through the *Message Center* in this chapter or by using the following key sequence. This procedure must be performed within 20 seconds.

1. Insert the ignition key in to the ignition switch.
2. Turn the key from the OFF position to the RUN/ON position then back to OFF three times within 20 seconds.
3. Momentarily activate either the Driver's or Passenger's outside mirror in any direction.
4. Remove the key from the ignition switch to exit programming.

POWER ADJUSTABLE FOOT PEDALS

The accelerator and brake pedal should only be adjusted when the vehicle is stopped and the gearshift lever is in the P (Park) position.

Press and hold the rocker control to adjust accelerator and brake pedal.

- Press the top of the control to adjust the pedals toward you.
- Press the bottom of the control to adjust the pedals away from you.



The adjustment allows for approximately 76 mm (3 inches) of maximum travel.



Never adjust the accelerator and brake pedal with feet on the pedals while the vehicle is moving.

Driver Controls

SPEED CONTROL

To turn speed control on

- Press ON.

Vehicle speed cannot be controlled until the vehicle is traveling at or above 48 km/h (30 mph).

Do not shift the gearshift lever into N (Neutral) with the speed control on.



Do not use the speed control in heavy traffic or on roads that are winding, slippery, or unpaved.

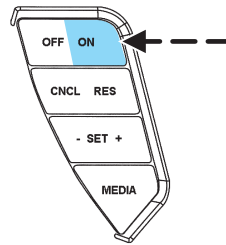

To turn speed control off

- Press OFF or
- Turn off the vehicle ignition.

Once speed control is switched off, the previously programmed set speed will be erased.

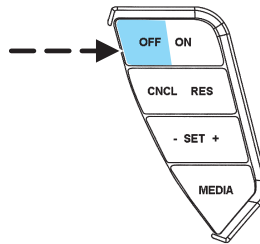

Driver Controls

To set a speed

- Press SET+. For speed control to operate, the speed control must be ON and the vehicle speed must be greater than 48 km/h (30 mph).

If you drive up or down a steep hill, your vehicle speed may vary momentarily slower or faster than the set speed. This is normal.

Speed control cannot reduce the vehicle speed if it increases above the set speed going downhill. If your vehicle speed is faster than the set speed while driving downhill, you may want to shift to the next lower gear or apply the brakes to reduce your vehicle speed.

If your vehicle slows down more than 16 km/h (10 mph) below your set speed on an uphill, your speed control will disengage. This is normal. Pressing RES will re-engage it.

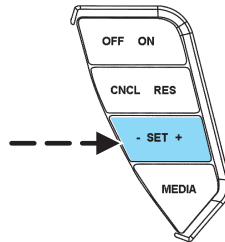

Do not use the speed control in heavy traffic or on roads that are winding, slippery, or unpaved.

To set a higher set speed

- Press and hold SET +. Release the control when the desired vehicle speed is reached or
- Press and release SET + to operate the Tap-Up function. Each press will increase the set speed by 1.6 km/h (1 mph) or
- Accelerate with your accelerator pedal. When the desired vehicle speed is reached, press and release SET +.

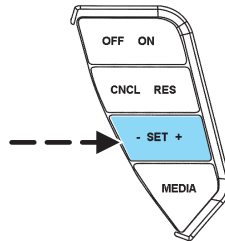

You can accelerate with the accelerator pedal at any time during speed control usage. Releasing the accelerator pedal will return your vehicle to the previously programmed set speed.

Driver Controls

To set a lower set speed

- Press and hold SET -. Release the control when the desired speed is reached or
- Press and release SET - to operate the Tap-Down function. Each press will decrease the set speed by 1.6 km/h (1 mph) or

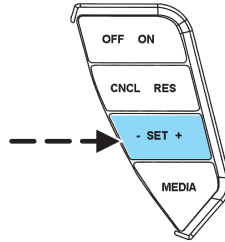

- Press CNCL or depress the brake pedal. When the desired vehicle speed is reached, press SET + / SET -.

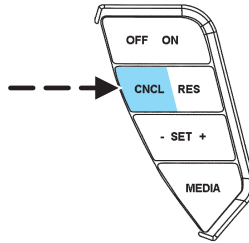

Driver Controls

To disengage speed control

- Press CNCL, or

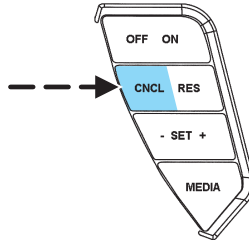

- depress the brake pedal.

Disengaging the speed control will not erase the previously programmed set speed.

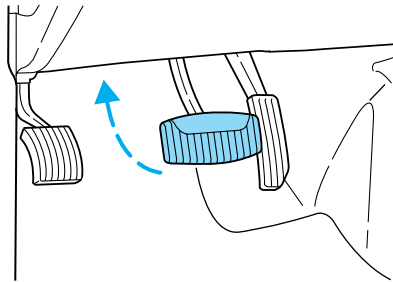

Pressing OFF will erase the previously programmed set speed.

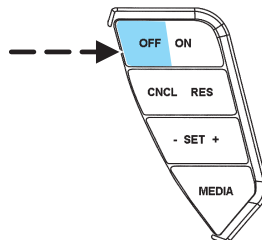

Driver Controls

To return to a previously set speed

- Press RES. For RES to operate, the vehicle speed must be faster than 48 km/h (30 mph).

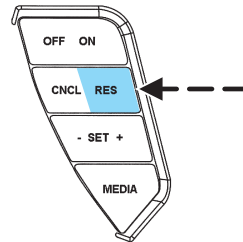

Indicator light

This light comes on when the vehicle speed control is engaged and actively controlling vehicle speed.

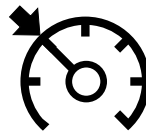

STEERING WHEEL CONTROLS

These controls allow you to operate some radio and climate control features.

Audio control features

Press MEDIA to select:

- AM, FM1, FM2,
- TAPE, or
- CD (if equipped).

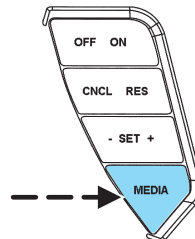

Driver Controls

In AM, FM1, or FM2 mode:

- Press MEM to select preset stations within the selected radio band.

In Tape mode:

- Press MEM to select the next selection on the tape.

In CD mode:

- Press MEM to select the next selection on the CD.

In any mode:

- Press VOL + or - to adjust volume.

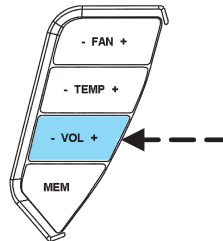
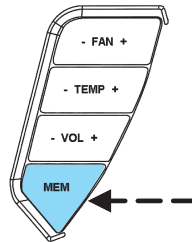

Climate control features

Press TEMP + or - to adjust temperature.

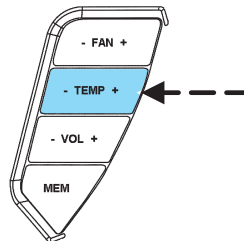

Driver Controls

Press FAN + or - to adjust fan speed.

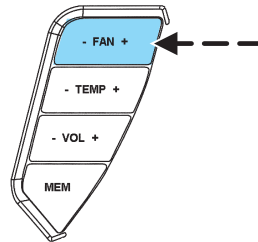

Navigation steering wheel controls (if equipped)

These controls allow you to operate some audio and navigation control features when the vehicle is equipped with the navigation feature.

Audio control features

Press  to select:

- AM, FM1, FM2, or
- CD.

In AM, FM1, or FM2 mode:

- Press NEXT to select preset stations within the selected radio band.

In CD mode:

- Press NEXT to select the next selection on the CD.

In any mode:

- Press VOL + or - to adjust volume.

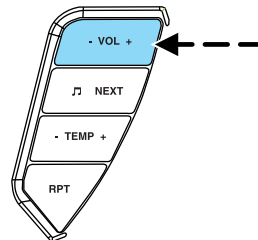
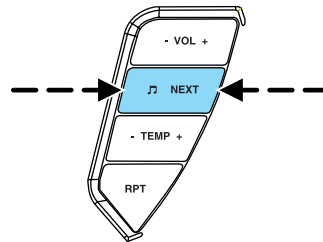

Driver Controls

Navigation control features

Press and hold VOICE until the voice icon appears to use the navigation voice guidance.

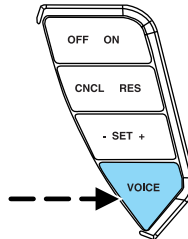

Press RPT (REPEAT) control to hear previous command repeated from the navigation system.

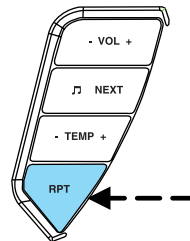

Climate control features

Press TEMP + or - to adjust temperature.

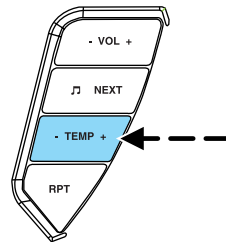

HOMELINK® WIRELESS CONTROL SYSTEM

The HomeLink® Wireless Control System, located on the overhead console, provides a convenient way to replace up to three hand-held transmitters with a single built-in device. This feature will learn the radio frequency codes of most current transmitters to operate garage doors, entry gate operators, security systems, entry door locks, and home or office lighting.

Driver Controls



When programming your HomeLink® Wireless Control System to a garage door or gate, be sure that people and objects are out of the way to prevent potential harm or damage.

Do not use the HomeLink® Wireless Control System with any garage door opener that lacks safety stop and reverse features as required by U.S. federal safety standards (this includes any garage door opener model manufactured before April 1, 1982). A garage door which cannot detect an object, signaling the door to stop and reverse, does not meet current U.S. federal safety standards. For more information, contact HomeLink® at: **www.homelink.com** or **1-800-355-3515**.

Retain the original transmitter for use in other vehicles as well as for future programming procedures (i.e. new HomeLink® equipped vehicle purchase). It is also suggested that upon the sale of the vehicle, the programmed HomeLink® buttons be erased for security purposes, refer to *Programming* in this section.

Programming

Do not program HomeLink® with the vehicle parked in the garage.

Note: Some vehicles may require the ignition switch to be turned to the second (or “ACC”) position for programming and/or operation of the HomeLink®. It is also recommended that a new battery be placed in the hand-held transmitter of the device being programmed to HomeLink® for quicker training and accurate transmission of the radio-frequency signal.

1. Press and hold the two outside buttons releasing only when the red light begins to flash after 20 seconds. **Do not** repeat step one to program additional hand-held transmitters to the remaining two HomeLink® buttons. This will erase previously programmed hand-held transmitter signals into HomeLink®.

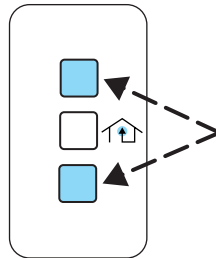

2. Position the end of your hand-held transmitter 2–8 cm (1–3 inches) away from the HomeLink® button you wish to program (located on your overhead console) while keeping the red light in view.

Driver Controls

3. Simultaneously press and hold both the HomeLink® and hand-held transmitter button. **Do not release the buttons until step 4 has been completed.**

Some entry gates and garage door openers may require you to replace step 3 with procedures noted in the “Gate Operator and Canadian Programming” section for Canadian residents.

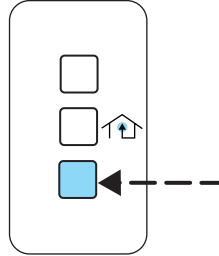

4. The red light will flash slowly and then rapidly. Release both buttons when the red light flashes rapidly. (The rapid flashing light indicates acceptance of the hand-held transmitters’ radio frequency signals.)

5. Press and hold the just-trained HomeLink® button and observe the red light. If the light is a constant red, programming is complete and your device should activate when the HomeLink® button is pressed and released. **Note:** To program the remaining two HomeLink® buttons, begin with step 2 in the “Programming” section — **do not** repeat step 1.

Note: If the red light blinks rapidly for two seconds and then turns to a continuous red, proceed with steps 6 through 8 to complete programming of a rolling code equipped device.

6. At the garage door opener receiver (motor-head unit) in the garage, locate the “learn” or “smart” button (usually near where the hanging antenna wire is attached to the unit).

7. Press and release the “learn” or “smart” button. (The name and color of the button may vary by manufacturer.)

Note: There are 30 seconds in which to initiate step eight.

8. Return to the vehicle and firmly press, hold for two seconds and release the HomeLink® button. Repeat the press/hold/release sequence again, and, depending on the brand of the garage door opener (or other rolling code equipped device), repeat this sequence a third time to complete the programming.

HomeLink® should now activate your rolling code equipped device. To program additional HomeLink® buttons begin with step 2 in the “Programming” section. For questions or comments, please contact HomeLink at **www.homelink.com** or **1-800-355-3515**.

Driver Controls

Operating the HomeLink® Wireless Control System

To operate, simply press and release the appropriate HomeLink® button. Activation will now occur for the trained product (garage door, gate operator, security system, entry door lock, or home or office lighting etc.). For convenience, the hand-held transmitter of the device may also be used at any time. In the event that there are still programming difficulties, contact HomeLink® at www.homelink.com or **1-800-355-3515**.

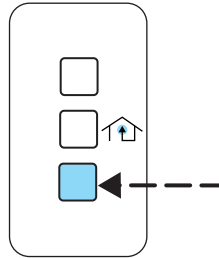

Erasing HomeLink® buttons

To erase the three programmed buttons (individual buttons cannot be erased):

- Press and hold the two outer HomeLink® buttons until the red indicator light begins to flash-after 20 seconds. Release both buttons. Do not hold for longer than 30 seconds.

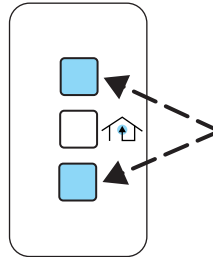

HomeLink® is now in the train (or learning) mode and can be programmed at any time beginning with step 2 in the “Programming” section.

Reprogramming a single HomeLink® button

To program a device to HomeLink® using a HomeLink® button previously trained, follow these steps:

1. Press and hold the desired HomeLink® button. **Do NOT** release the button.
2. The red indicator light will begin to flash after 20 seconds. Without releasing the HomeLink® button, follow step 2 in the “Programming” section.

For questions or comments, contact HomeLink® at www.homelink.com or **1-800-355-3515**.

Driver Controls

Gate Operator & Canadian Programming

During programming, your hand-held transmitter may automatically stop transmitting — not allowing enough time for HomeLink® to accept the signal from the hand-held transmitter.

After completing steps 1 and 2 outlined in the “Programming” section, replace step 3 with the following:

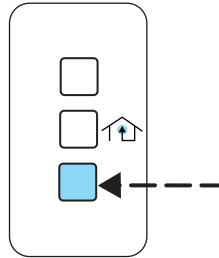

Note: If programming a garage door opener or gate operator, it is advised to unplug the device during the “cycling” process to prevent overheating.

- Continue to press and hold the HomeLink® button (note step 3 in the “Programming” section) while you press and release — **every two seconds** (“cycle”) your hand-held transmitter until the frequency signal has been accepted by the HomeLink®. The red indicator light will flash slowly and then rapidly after HomeLink® accepts the radio frequency signal.
- Proceed with step 4 in the “Programming” section.

MESSAGE CENTER

With the ignition in the ON position, the message center, located on your instrument cluster, displays important vehicle information

through a constant monitor of vehicle systems. You may select

display features on the message center for a display of status preceded by a brief indicator chime. The system will also notify you of potential vehicle problems with a display of system warnings followed by a long indicator chime.

MESSAGE CENTER



Driver Controls

Selectable features

Reset

Press this control to select and reset functions shown in the INFO menu and SETUP menu.

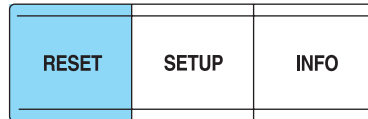

Info menu

This control displays the following control displays:

- Odometer/Compass
- Trip odometer/Odometer/Compass
- Distance to Empty
- Average Fuel Economy
- Trip Elapsed Drive Time

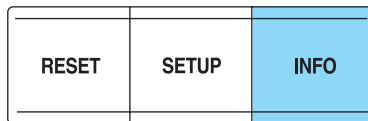

Odometer/Trip odometer

Refer to *Gauges* in the *Instrument Cluster* chapter.

Compass display

The compass reading may be affected when you drive near large buildings, bridges, power lines and powerful broadcast antenna. Magnetic or metallic objects placed in, on or near the vehicle may also affect compass accuracy.

Usually, when something affects the compass readings, the compass will correct itself after a few days of operating your vehicle in normal conditions. If the compass still appears to be inaccurate, a manual calibration may be necessary. Refer to *Compass zone/calibration adjustment*.

Most geographic areas (zones) have a magnetic north compass point that varies slightly from the northerly direction on maps. This variation is four degrees between adjacent zones and will become noticeable as the vehicle crosses multiple zones. A correct zone setting will eliminate this error. Refer to *Compass zone/calibration adjustment*.

Compass zone/calibration adjustment

Perform this adjustment in an open area free from steel structures and high voltage lines.

Driver Controls

For optimum calibration, turn off all electrical accessories (heater/air conditioning, wipers, etc.) and make sure all vehicle doors are shut.

1. Turn ignition to the ON position.
2. Start the engine.
3. Determine your magnetic zone by referring to the zone map.
4. From Info menu, select the Compass/Odometer function. (Do not select Trip, DTE, or AFE. The top of the message center must be blank).

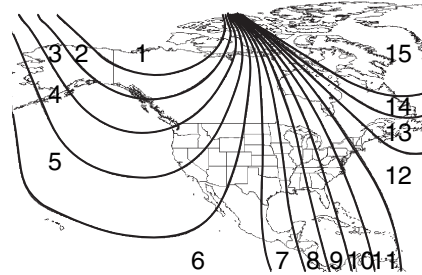

5. Press and hold the RESET and SETUP control until the message center display changes to show the current zone setting.

RESET FOR ZONE
INFO TO EXIT

6. Release the RESET AND SETUP control, then slowly press RESET down again.

SETUP ZONE XX
RESET IF DONE

7. Press the SETUP control repeatedly until the correct zone setting for your geographic location is displayed on the message center. To exit the zone setting mode press and release the RESET control.

8. Press the RESET control to start the compass calibration function.

RESET FOR CAL
INFO TO EXIT

9. Slowly drive the vehicle in a circle (less than 5 km/h [3 mph]) until the CIRCLE SLOWLY TO CALIBRATE indicator changes to CALIBRATION COMPLETED. This will take up to three circles to complete calibration.

CIRCLE SLOWLY
TO CALIBRATE

10. The compass is now calibrated.

Driver Controls

Average fuel economy (AFE)

Select this function from the INFO menu to display your average fuel economy in liters/100 km or miles/gallon.



XXX.X MPG

If you calculate your average fuel economy by dividing liters of fuel used by 100 kilometers traveled (miles traveled by gallons used), your figure may be different than displayed for the following reasons:

- Your vehicle was not perfectly level during fill-up
- Differences in the automatic shut-off points on the fuel pumps at service stations
- Variations in top-off procedure from one fill-up to another
- Rounding of the displayed values to the nearest 0.1 liter (gallon)

1. Drive the vehicle at least 8 km (5 miles) with the speed control system engaged to display a stabilized average.

2. Record the highway fuel economy for future reference.

It is important to press the RESET control after setting the speed control to get accurate highway fuel economy readings.

Trip elapsed drive time

Select this function from the INFO menu to display a timer.

To operate the Trip Elapsed Drive Time perform the following:

1. Press and release RESET in order to start the timer.
2. Press and release RESET to pause the timer.
3. Press and hold RESET for 2 seconds in order to reset the timer.



TIME 00:00:00
XX YMI

Distance to empty (DTE)

Selecting this function from the INFO menu this function estimates approximately how far you can drive with the fuel remaining in your tank under normal driving conditions.

Remember to turn the ignition OFF when refueling to allow this feature to correctly detect the added fuel.



XXX MILES TO E

Driver Controls

The DTE function will display LOW FUEL LEVEL and sound a tone for one second when you have approximately 80 km (50 miles) to empty. If you RESET this warning message, this display and tone will return within 10 minutes.

DTE is calculated using a running average fuel economy, which is based on your recent driving history of 800 km (500miles). This value is not the same as the average fuel economy display. The running average fuel economy is reinitialized to a factory default value if the battery is disconnected.

Setup menu

Press this control for the following displays:

- System Check
- Units (English/Metric)
- Autolock
- Easy Entry/Exit
- Reverse Mirrors
- Autolamp Delay
- Oil change
- Language
- Rear Park Assist (while in reverse)
- AWD Locked (if equipped)

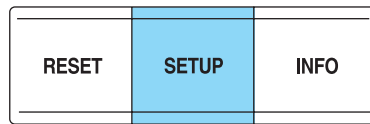

System check

Selecting this function from the SETUP menu causes the message center to cycle through each of the systems being monitored. For each of the monitored systems, the message center will indicate either an OK message or a warning message for three seconds.

Pressing the RESET control cycles the message center through each of the systems being monitored.

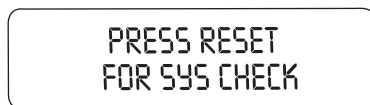

Driver Controls

The sequence of the system check report and how it appears in the message center is as follows:

1. FUEL LEVEL
2. WASHER FLUID LEVEL
3. OIL LIFE IN XX%
4. PARK ASSIST
5. ENGINE TEMP
6. OIL PRESSURE
7. TIRE PRESSURE SYSTEM (if equipped)
8. BRAKE FLUID LEVEL
9. CHARGING SYSTEM

Units (English/Metric)

1. Select this function from the SETUP menu for the current units to be displayed.
2. Press the RESET control to change from English to Metric.



UNITS
< ENG > METRIC

Autolocks

1. Select this function from the SETUP control for the current display mode.
2. Press the RESET control to turn the autolocks ON or OFF.



AUTO LOCKS
< ON > OFF

Easy entry/exit

1. Select this function from the SETUP control for the current display mode.
2. Press the RESET control to turn the easy entry/exit ON or OFF.



EASY EXIT SEAT
< ON > OFF

Driver Controls

Reverse mirrors

1. Select this function from the SETUP control for the current display mode.
2. Press the RESET control to turn the reverse mirrors ON or OFF.

REVERSE MIRROR
ON <OFF>

Autolamp delay

1. Select this function from the SETUP control for the current display mode.
2. Press the RESET control to turn the autolamp delay ON or OFF.

AUTOLAMP
DELAY = XXX SEC

AUTOLAMP DELAY
ON <OFF>

Oil Change

1. Select this function from the SETUP control for the current display mode.
2. Press the RESET control to reset oil change.

PRESS RESET
AT OIL CHANGE

Rear park assist

This feature sounds a warning tone to warn the driver of obstacles near the rear bumper, and functions only when R (Reverse) gear is selected.

1. Put the vehicle in R (reverse) to display REAR PARK ASSIST.
2. Press the RESET control to turn the rear park assist ON or OFF.

PARK ASSIST
< ON > OFF

Language

1. Select this function from the SETUP menu for the current language to be displayed.

ENGLISH
RESET FOR NEW

Driver Controls

2. Pressing the RESET control cycles the message center through each of the language choices.

FOR ENGLISH
HOLD RESET

3. Press and hold the RESET control to set the language choice.

SET TO
ENGLISH

AWD locked (vehicles equipped with AdvanceTrac™ only)

Select this function from the SETUP menu to display the AWD locked function.

1. Press the SETUP control for the current display mode.

AWD <AUTO>
LOCKED

2. Press the RESET control within 4 seconds to turn the AWD system to the LOCKED mode.

AWD AUTO
<LOCKED>

System warnings

System warnings alert you to possible problems or malfunctions in your vehicle's operating systems.

In the event of a multiple warning situation, the message center will cycle the display to show all warnings by displaying each one for 4 seconds.

The message center will display the last selected feature if there are no more warning messages. This allows you to use the full functionality of the message center after you acknowledge the warning by pressing the RESET control and clearing the warning message.

Warning messages that have been reset are divided into three categories:

- They will reappear on the display every minute from the reset.
- They will reappear on the display ten minutes from the reset.
- They will not reappear until an ignition OFF-ON cycle has been completed.

Driver Controls

This acts as a reminder that these warning conditions still exist within the vehicle.

Warning display	Status
Check park assist	Warning displays when R (reverse) gear is selected.
AdvTrac ON (if equipped)	Displays for 4 seconds
AdvTrac OFF (if equipped)	
Change Oil Soon	
Temporary AWD locked (vehicles equipped with AdvanceTrac [™] only)	
AWD lock OFF AWD auto ON (vehicles equipped with AdvanceTrac [™] only)	Warning returns every minute Warning returns after cycling through the system sequence
Warning-tire very low (if equipped)	
Tire pressure system fault (if equipped)	
Check tire pressure (if equipped)	
Check spare tire pressure (if equipped)	
Tire pressure sensor fault (if equipped)	
Door ajar Liftgate ajar	
Low fuel level	
Check charging system	
Low brake fluid level	
Low oil pressure	
Transmission overheated	
Check transmission	
Check engine temperature	
Reduced engine power	
Stop engine safely	
AWD disabled locked (vehicles equipped with AdvanceTrac [™] only)	

Driver Controls

Warning display	Status
Low washer fluid level	Warning returns after the ignition key is turned from OFF to ON.
Check AdvTrac (if equipped)	
Check AWD (vehicles equipped with AdvanceTrac [™] only)	
AWD Disabled (vehicles equipped with AdvanceTrac [™] only)	
Check fuel cap	
Oil change required	

CHECK PARK ASSIST. Displayed when the transmission is in R (Reverse) and the park assist does not operate properly. See your dealer as soon as possible.

ADVTRAC ON (if equipped). Displayed when the AdvanceTrac is ON.

ADVTRAC OFF (if equipped). Displayed when the AdvanceTrac is OFF.

TEMPORARY AWD LOCKED (vehicles equipped with AdvanceTrac[™] only). Displayed when the AWD system is updating its status of being locked.

AWD LOCK OFF and AWD AUTO ON (vehicles equipped with AdvanceTrac[™] only). Displayed when the AWD is system is completely cooled down from being overheated.

DOOR AJAR LIFTGATE AJAR. Displayed when a door or liftgate is not completely closed.

CHECK ENGINE TEMPERATURE. Displayed when the engine coolant is overheating. Stop the vehicle as soon as safely possible, turn off the engine and let it cool. Check the coolant and coolant level. Refer to *Engine coolant* in the *Maintenance and specifications* chapter. If the warning stays on or continues to come on, contact your dealer as soon as safely possible.

REDUCED ENGINE POWER. Displayed when the engine is overheating. Stop the vehicle as soon as safely possible, turn off the engine. If the warning stays on or continues to come on, contact your dealer as soon as safely possible.

STOP ENGINE SAFELY. Displayed when the engine is overheating. Stop the vehicle as soon as safely possible, turn off the engine. If the warning stays on or continues to come on, contact your dealer as soon as safely possible.

Driver Controls

AWD DISABLED LOCKED (vehicles equipped with AdvanceTrac[™] only). Displayed when the AWD system begins to overheat placing itself in the autolock mode. If the warning stays on or continues to come on, contact your dealer as soon as safely possible.

WARNING-TIRE VERY LOW (if equipped). Displayed when one or more tires have very low pressure. When this warning message is displayed, a warning chime will sound reminding you to stop the vehicle as soon as safely possible and check your tires for proper pressure, leaks and damage. Refer to *Servicing your tires* in the *Maintenance and specifications* chapter.

TIRE PRESSURE SYSTEM FAULT (if equipped). Displayed when a tire pressure monitoring system is malfunctioning. If the warning stays on or continues to come on, have the system checked by your dealer.

CHECK TIRE PRESSURE (if equipped). Displayed when any of the tire pressures are high or low. Refer to *Checking the tire pressure* in the *Maintenance and specifications* chapter.

CHECK SPARE TIRE PRESSURE (if equipped). Displayed when the spare tire pressure is high or low. Refer to *Checking the tire pressure* in the *Maintenance and specifications* chapter.

TIRE PRESSURE SENSOR FAULT (if equipped). Displayed when a tire pressure sensor is malfunctioning. If the warning stays on or continues to come on, have the system checked by your dealer.

LOW FUEL LEVEL. Displayed as an early reminder of a low fuel condition.

CHECK CHARGING SYSTEM. Displayed when the electrical system is not maintaining proper voltage. If you are operating electrical accessories when the engine is idling at a low speed, turn off as many of the electrical loads as soon as possible. If the warning stays on or comes on when the engine is operating at normal speeds, have the electrical system checked as soon as possible.

LOW BRAKE FLUID LEVEL. Indicates the brake fluid level is low and the brake system should be inspected immediately. Refer to *Checking and adding brake fluid* in the *Maintenance and specifications* chapter.

LOW OIL PRESSURE. Displayed when the engine oil pressure is low. If this warning message is displayed, check the level of the engine oil. Refer to *Engine oil* in the *Maintenance and specifications* chapter for information about adding engine oil.

TRANSMISSION OVERHEATED. Indicates the transmission is overheating. This warning may appear when towing heavy loads, city

Driver Controls

driving, when driving in a low gear at a high speed for an extended period of time or due to a loss of transmission fluid. Stop the vehicle as soon as safely possible, place the shift lever into P (Park) or N (Neutral) and raise the engine RPM. If this does not cool the transmission turn off the engine and let it cool. If the warning stays on or continues to come on, contact your dealer for transmission service as soon as possible. Continued operation in this condition may cause internal transmission damage.

CHECK TRANSMISSION. Indicates the transmission is not operating properly. If this warning stays on, contact your dealer as soon as possible to prevent additional transmission damage. Refer to the instrument cluster warning lamps in the *Instrument cluster* chapter.

LOW WASHER FLUID LEVEL. Indicates the washer fluid reservoir is less than one quarter full. Check the washer fluid level. Refer to *Windshield washer fluid* in the *Maintenance and specifications* chapter.

CHECK ADVTRAC (if equipped). Displayed when the AdvanceTrac[™] system is not operating properly. If this message is displayed on the message center the AdvanceTrac[™] system will be partially operable. If this warning stays on while the engine is running, contact your dealer as soon as possible. For further information, refer to *AdvanceTrac[™] stability enhancement system* in the *Driving* chapter.

AWD DISABLED (vehicles equipped with AdvanceTrac[™] only). Displayed for 4 seconds then SEE OWNER'S MANUAL will display indicating that the AWD system is not operating properly. For further information, refer to *Disabling AWD* in the *Driving* chapter. See your dealer as soon as possible

CHECK AWD (vehicles equipped with AdvanceTrac[™] only). Displayed when the AWD system is not operating properly. If the warning stays on or continues to come on, contact your dealer immediately.

CHECK FUEL CAP. Displayed when the fuel filler cap is not properly installed. Check the fuel filler cap for proper installation. Refer to *Fuel filler cap* in the *Maintenance and specifications* chapter.

CHANGE OIL SOON/OIL CHANGE REQUIRED. Displayed when the engine oil life remaining is 5 percent or less. When oil life left is between 5% and 0%, the CHANGE OIL SOON message will be displayed. When oil life left reaches 0%, the OIL CHANGE REQUIRED message will be displayed.

An oil change is required whenever indicated by the message center and according to the recommended maintenance schedule. USE ONLY RECOMMENDED ENGINE OILS.

Driver Controls

To reset the oil monitoring system to 100% after each oil change [approximately 8,000 km (5,000 miles) or 180 days] perform the following:

1. Select this function from the SETUP control for current display mode.

PRESS RESET
AT OIL CHANGE

2. Press and release the RESET control to display "HOLD RESET TO CONFIRM".

HOLD RESET
TO CONFIRM

3. Press and hold the RESET control to display OIL LIFE SET TO 100%. Your oil life is now reset.

OIL LIFE SET
TO 100%

To reset the oil monitoring system to your personalized oil life %:

1. From step 3 above.

OIL LIFE SET
TO 100%

2. Release the RESET control momentarily, then press RESET and SETUP controls at the same time to activate a service mode which will display OIL LIFE XX% RESET TO ALTER.

OIL LIFE XX%
RESET TO ALTER

3. Press RESET until you find your personalized OIL LIFE XX%.

4. With your personalized OIL LIFE XX% displayed, press SETUP to continue the system check.

TIRE PRESSURE SYSTEM OFF (if equipped). Displayed when the tire pressure monitoring system is turned off. Only your dealer can turn the system on or off. It is recommended that the tire pressure monitoring system is always turned ON.

Driver Controls

DATA ERR. These messages indicate improper operation of the vehicle network communication between electronic modules.

- Fuel computer
- Oil life
- Charging system
- Door sensor
- Washer fluid
- Brake fluid
- Compass
- Outside temperature
- Engine sensor

Contact your dealer as soon as possible if these messages occur on a regular basis.

OVERDRIVE CONTROL

Activating overdrive

D (Overdrive) is the normal drive position for the best fuel economy.

The overdrive function allows automatic upshifts and downshifts through all available gears.

Transmission control switch

The transmission control switch is located on the gearshift lever. Pressing the switch engages or disengages the overdrive function, and illuminates the O/D Off lamp when overdrive is cancelled, refer to the *Automatic Transmission* in the *Driving* chapter.

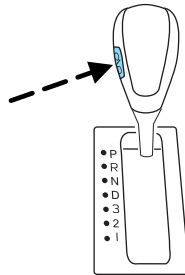

CELL PHONE USE

The use of Mobile Communications Equipment has become increasingly important in the conduct of business and personal affairs. However, drivers must not compromise their own or others' safety when using

Driver Controls

such equipment. Mobile Communications can enhance personal safety and security when appropriately used, particularly in emergency situations. Safety must be paramount when using mobile communications equipment to avoid negating these benefits.

Mobile Communication Equipment includes, but is not limited to cellular phones, pagers, portable email devices, in vehicle communications systems, telematics devices and portable two-way radios.



A driver's first responsibility is the safe operation of the vehicle. The most important thing you can do to prevent a crash is to avoid distractions and pay attention to the road. Wait until it is safe to operate Mobile Communications Equipment.

CENTER CONSOLE

Your vehicle may be equipped with a variety of console features. These include:

- Utility compartment with power point
- Cupholders
- Cigarette lighter



Use only soft cups in the cupholder. Hard objects can injure you in a collision.

REAR CENTER CONSOLE FEATURES (IF EQUIPPED)

The rear center console incorporates the following features:

- Utility compartment
- Cupholders
- Removable tray
- Flip forward armrest to provide a flat load floor

Driver Controls

POSITIVE RETENTION FLOOR MAT

Position the driver floor mat so that the eyelet is over the pointed end of the retention post and rotate forward to lock in. Make sure that the mat does not interfere with the operation of the accelerator or the brake pedal. To remove the floor mat, reverse the installation procedure.

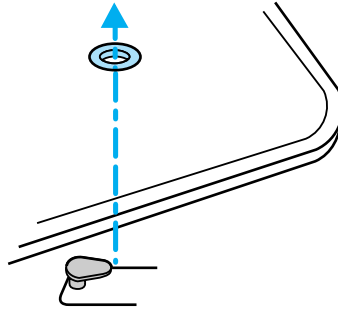

REAR LIFTGATE

The liftgate area is only intended for cargo, not passengers. You can open and close the liftgate from outside the vehicle. It cannot be opened from inside the cargo area.

- To open the liftgate window, press the control on the remote entry key fob or, with the liftgate unlocked, push the **right** control button under the license plate lamp shield.
- To open the liftgate, unlock the liftgate (with the power door locks, the remote entry or the keyless entry pad) and push the **center** control button under the license plate lamp shield while pulling the liftgate. If the vehicle has battery failure, the liftgate can be opened with a key.

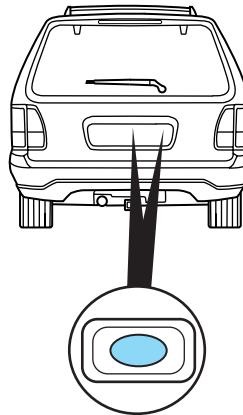

To lock the liftgate and the liftgate window, use the power door locks or press the door lock switch on the left side of the cargo area.

The liftgate door and window should be closed before driving. If not, possible damage may occur to your vehicle.

Driver Controls

 Always close liftgate window before opening liftgate. Liftgate glass and liftgate should never be open at the same time. Failure to observe this warning may result in personal injury or damage to your vehicle.

 Make sure the liftgate door and/or window are closed to prevent exhaust fumes from being drawn into the vehicle. This will also prevent passengers and cargo from falling out.

LUGGAGE RACK

Your vehicle is equipped with a roof rack. The maximum recommended load is 48kg (120 lbs), evenly distributed. If it is not possible to distribute the load, position it as far rearward as possible. Use the tie down loops (on the thumbwheels) to secure the load.

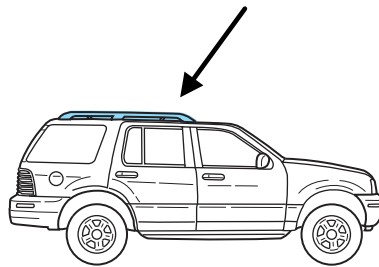

To adjust cross-bar position:

1. Loosen the thumbwheel at both ends of the cross-bar (both cross-bars are adjustable).
2. Slide the cross-bar to the desired location.
3. Tighten the thumbwheel at both ends of the cross-bar.

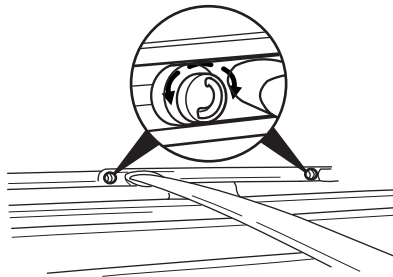

Driver Controls



Vehicles with a higher center of gravity such as utility and four-wheel drive vehicles handle differently than vehicles with a lower center of gravity. Utility and four-wheel drive vehicles are not designed for cornering at speeds as high as passenger cars any more than low-slung sport cars are designed to perform satisfactorily under off-road conditions. Avoid sharp turns, excessive speed and abrupt maneuvers in these vehicles. Failure to drive cautiously could result in an increase risk of loss of vehicle control, vehicle rollover, personal injury and death.

CARGO MANAGEMENT SYSTEM

The cargo management system consists of storage compartments located in the floor of the rear cargo area.

1. To open, lift the release handle and the lid.
2. To close, lower the lid, lift the release handle and press down on the lid.

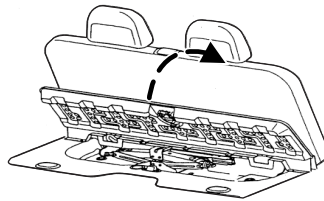

Locks and Security

KEYS

The key operates all locks on your vehicle. In case of loss, replacement keys are available from your dealer.

You should always carry a second key with you in a safe place in case you require it in an emergency.

Refer to *SecuriLock™ Passive Anti-Theft System* for more information.

POWER DOOR LOCKS

If the door does not unlock when the control is pressed, see *Power door lock disable feature* in the *Remote entry section* in this chapter.

Press control to unlock all doors.

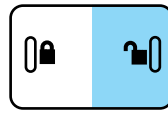

Press control to lock all doors.



Childproof door locks

When these locks are set, the rear doors cannot be opened from the inside. The rear doors can be opened from the outside when the doors are unlocked.

The childproof locks are located on rear edge of each rear door and must be set separately for each door. Setting the lock for one door will not automatically set the lock for both doors.

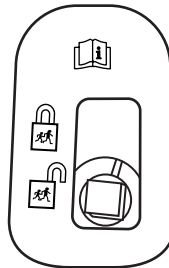

Move lock control up to engage the childproof lock. Move control down to disengage childproof locks.

REMOTE ENTRY SYSTEM

This device complies with part 15 of the FCC rules and with RS-210 of Industry Canada. Operation is subject to the following two conditions:

(1) This device may not cause harmful interference, and (2) This device must accept any interference received, including interference that may cause undesired operation.

Locks and Security

Changes or modifications not expressly approved by the party responsible for compliance could void the user's authority to operate the equipment.

The remote entry system allows you to lock or unlock all vehicle doors and liftgate and open the liftgate window without a key.

The remote entry lock/unlock feature operates in any ignition position. The liftgate glass features operate as long as the vehicle is in P (Park). The panic feature operates with the key in the OFF or ACC position.

If there is any potential remote keyless entry problem with your vehicle, ensure **ALL** remote entry transmitters are brought to the dealership, to aid in troubleshooting.

Unlocking the doors/liftgate

Press this control to unlock the driver's door. The interior lamps will illuminate with the ignition OFF.

Press the control a second time within three seconds to unlock all doors and liftgate.

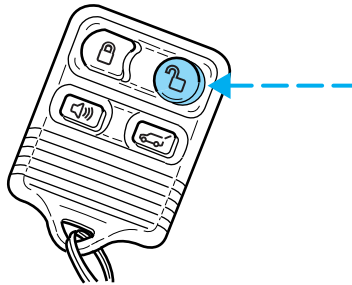

Locking the doors/liftgate

Press this control to lock all doors and liftgate. The park/turn signal lamps will flash once.

To confirm all doors are closed and locked, press the control a second time within three seconds; the park/turn signal lamps will flash once and the horn will chirp.

If any of the doors or liftgate are ajar, the horn will make two quick chirps, reminding you to properly close all doors.

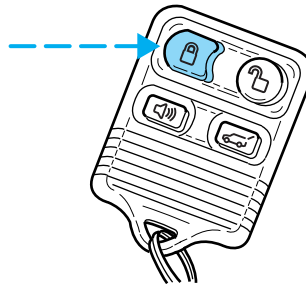

Locks and Security

Opening the liftgate window

Press the control to unlatch the liftgate window.

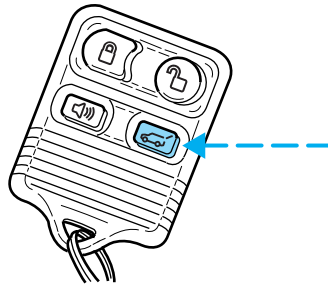

Sounding a panic alarm

Press this control to activate the alarm.

The personal panic alarm will cycle the horn and parking lamps on/off.

To deactivate the alarm, press the control again or turn the ignition to ON.

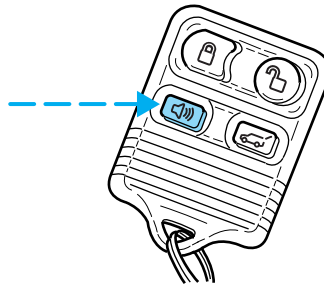

Memory seat feature

The remote entry system can also control the memory seat feature.

Press the control once to unlock the driver's door. Pressing the control will automatically move the seat to the desired memory position (when associated to memory 1 and 2 positions).

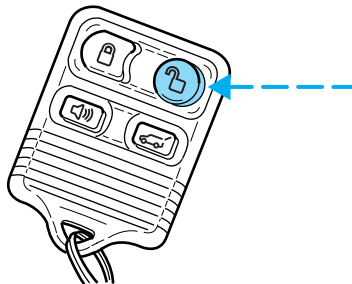

Up to four remote entry transmitters can be associated to the two memory positions.

Locks and Security

Associating the transmitter with the memory seat feature

To activate this feature:

1. Select the desired memory position by pressing the memory 1 or 2 button on the memory SET control, located on the instrument panel to the left of the steering wheel.
2. Press the memory SET button.
3. Press any button on the remote transmitter.
4. Press memory select 1 (for Driver 1) or memory select 2 (for driver 2). This associates the memory seat position with either driver 1's or 2's position.
5. Repeat this procedure for another remote transmitter if desired.

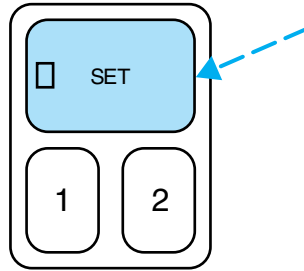

Deactivating the memory seat feature

To deactivate this feature:

1. Press the SET button on the driver's door panel.
2. Within 5 five seconds, press any button on the remote transmitter which you would like to deactivate and then press the SET button on the instrument panel.
3. Repeat this procedure for another remote transmitter if desired.

Replacing the battery

The remote transmitter is powered by one coin type three-volt lithium battery CR2032 or equivalent. Typical operating range will allow you to be up to 10 meters (33 feet) away from your vehicle. A decrease in operating range can be caused by the following factors:

- Weather conditions
- Nearby radio towers
- Structures around the vehicle
- Other vehicles parked next to the vehicle

Locks and Security

To replace the battery:

1. Twist a thin coin between the two halves of the transmitter near the key ring. **DO NOT TAKE THE FRONT PART OF THE TRANSMITTER APART.**

2. Place the positive (+) side of new battery in the same orientation. Refer to the diagram inside the transmitter unit.

3. Snap the two halves back together.

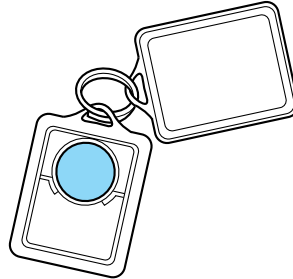

Replacement of the battery will **not** cause the remote transmitter to become deprogrammed from your vehicle. The remote transmitter should operate normally after battery replacement.

Replacing lost transmitters

If a remote transmitter has been lost and you would like to remove it from the vehicle's memory, or you would like to purchase additional remote transmitters and have them programmed to your vehicle:

- Take **all** your vehicle's transmitters to your dealer for programming, or
- Perform the programming procedure yourself.



Locks and Security

Programming remote transmitters

It is necessary to have **all** (maximum of four — original and/or new) of your remote transmitters available prior to beginning this procedure.

To program the transmitters yourself:

1. Ensure the vehicle is electronically unlocked.
2. Put the key in the ignition.
3. Turn the key from the 1 (LOCK) position to 3 (ON).
4. Cycle, eight times, rapidly (within 10 seconds) between the 1 (LOCK) position and 3 (ON). **Note:** The eighth turn must end in the 3 (ON) position.
5. The doors will lock, then unlock, to confirm that the programming mode has been activated.
6. Within 20 seconds press any button on the remote entry transmitter.
Note: If more than 20 seconds have passed you will need to start the procedure over again.
7. The doors will lock, then unlock, to confirm that this remote entry transmitter has been programmed.
8. Repeat the previous steps to program each additional remote entry transmitter.
9. Turn the ignition to the 1 (LOCK) position after you have finished programming all of the remote entry transmitters.
10. The doors will lock, then unlock, to confirm that the programming has been completed.

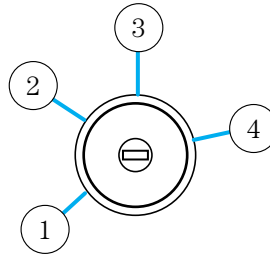

Power door lock disable feature

This feature will help protect your vehicle from unauthorized entry.

The UNLOCK function on the power door control will not operate with the ignition OFF and twenty seconds after the doors are closed and electronically locked by the remote entry transmitter, key pad, or power door control (if pressed while the door was open).

The UNLOCK function will operate again after you unlock the vehicle using the remote entry transmitter or key pad, turn the ignition to ON, or open the door from inside of the vehicle.

Locks and Security

Illuminated entry

The interior lamps illuminate when the remote entry system is used to unlock the door(s).

The system automatically turns off after 25 seconds or when the ignition is turned to the ON or ACC position. The dome lamp control (if equipped) must **not** be set to the OFF position for the illuminated entry system to operate.

The inside lights will not turn off if:

- they have been turned on with the dimmer control, or
- any door is open.

The battery saver will shut off the interior lamps 10 minutes after the ignition has been turned to the OFF position.

Smart unlocking feature

The smart unlocking feature prevents you from locking yourself out of the vehicle by unlocking the doors if the key is in the ignition and the driver's door is open/ajar when the vehicle doors were locked using the power lock/unlock control.

The smart unlocking feature operates independent of the position of the ignition.

Autolocking feature

The autolocking feature locks all vehicle doors when the following conditions are met:

- All doors, including the liftgate, are closed.
- The brake is pressed while the ignition is in the RUN position.
- The transmission is in either a forward or reverse gear.
- The vehicle has a speed of 8 km/h (5 mph) or greater.

This feature relocks all doors if any door is opened, the brake is pressed after all doors are closed again and the vehicle has a speed of 8 km/h (5 mph) or greater.

Locks and Security

Deactivating/activating the autolock feature

The autolock feature may be deactivated/activated by selecting the autolock function (accessed by pressing the SETUP control). Press the RESET control to turn the autolock function ON or OFF. Refer to *Message center* in the *Driver controls* chapter for additional information.

The autolock feature may also be deactivated/activated using the keyless entry keypad. For additional information, refer to *Keyless entry system* in this chapter.

Power door unlock disabled

The UNLOCK  feature on your power door locks will not work from inside the vehicle when:

- the ignition has been turned to the OFF position, and
- 20 seconds elapse after all vehicle doors are closed and locked using the remote entry transmitter, the keypad or the power door unlock control (while the accompanying door is open).

The UNLOCK  feature will work again after:

- a door has become ajar,
- the ignition is turned to the ON position, or
- using the UNLOCK  control on your remote entry transmitter, or
- using the keyless entry keypad to unlock the vehicle.

This feature can be activated and deactivated by an authorized Ford dealer.

KEYLESS ENTRY SYSTEM

With the keyless entry keypad, you can:

- lock or unlock the vehicle doors without using the key.

Your vehicle has a factory set 5 digit code that operates the keyless entry system. You can also program your own 5 digit personal entry code. The factory-set code is located:

- on the owner's wallet card in the glove compartment
- or at your dealer.

When pressing the controls on the keyless entry keypad, press the middle of the controls to ensure a good activation.

This system will disable the interior power door lock controls (if activated). For information about this feature, refer to *Interior power door lock disable feature* in the *Remote entry* section of this chapter.

Locks and Security

Programming your own personal entry code

To program your own code:

1. Enter factory set code (keypad will illuminate when pressed).
2. Press 1/2 control within five seconds of step 1.
3. Enter your personal 5 digit code. Enter each digit within five seconds of previous one.
4. After the code is entered, the locks will cycle, confirming that the new code has been set.

Do not set a code that includes five of the same number or presents them in sequential order. Thieves can easily figure out these types of codes.

Your personal code does not replace the permanent code that the dealership gave you. You can use either code to unlock your vehicle. If a second personal code is entered, the module will erase the first personal code in favor of the new code.

If you wish to erase your personal code, use the following instructions:

1. Enter factory set code.
2. Press 1/2 control and release.

The system will now only respond to the factory set code.

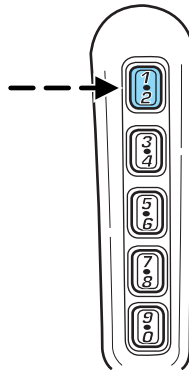
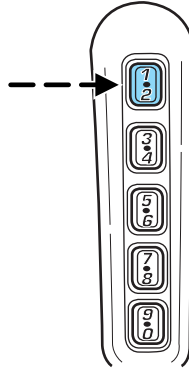

Locks and Security

Anti-scan feature

The anti-scan feature prevents repeated attempts at arriving at a valid key code.

The keyless entry pad is disabled for 1 minute after 7 unsuccessful attempts at entering a valid key code. The keypad will flash during this 1 minute mode. However, the 7/8 and 9/0 controls will still lock the vehicle.

Anti-scan will be turned off after one minute of keypad inactivity.



Unlocking the doors with the keyless entry system

To unlock the driver door, enter either the factory set code or the personal code (each digit must be pressed within five seconds of the prior digit). The interior lamps will also illuminate.

To unlock all doors, enter the factory set code or personal code (driver door unlocks) and press the 3/4 control within five seconds.

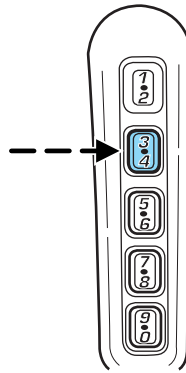

Locks and Security

Locking the doors with the keyless entry system

It is not necessary to enter the factory or personal code prior to locking all doors. To lock the doors:

- with the driver's door closed, press the 7/8 control and the 9/0 control at the same time.

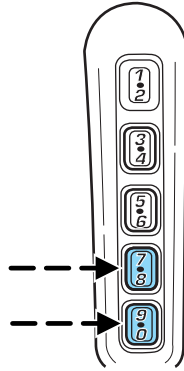

Activating/deactivating autolock with the keyless entry system

Before following the activation or deactivation procedures, make sure that the anti-theft system (if equipped) is not armed, ignition is off, and all vehicle doors and liftgate window are closed.

1. Enter 5 digit entry code
2. Press and hold 7/8 control
3. Press and release 3/4 control while holding 7/8 control
4. Release 7/8 control

The horn will chirp once if autolock was deactivated or twice (one short and one long chirp) if autolock was activated.

To re-activate autolock, repeat steps 1–4.

SECURILOCK™ PASSIVE ANTI-THEFT SYSTEM

SecuriLock™ passive anti-theft system is an engine immobilization system. This system is designed to prevent the engine from being started unless a **coded key programmed to your vehicle** is used.

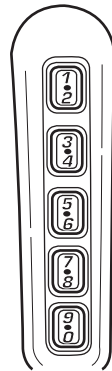

Locks and Security

The SecuriLock[™] passive anti-theft system is not compatible with non-Ford aftermarket remote start systems. Use of these systems may result in vehicle starting problems and a loss of security protection.

THEFT INDICATOR

The theft indicator is the flashing red indicator located on the dash panel.

- When the ignition is in the OFF position, the indicator will flash once every 2 seconds to indicate the SecuriLock[™] system is functioning as a theft deterrent.
- When the ignition is in the ON position, the indicator will glow for 3 seconds to indicate normal system functionality.

If a problem occurs with the SecuriLock[™] system, the indicator will flash rapidly or glow steadily when the ignition is in the ON position. If this occurs, the vehicle should be taken to an authorized dealer for service.

Automatic arming

The vehicle is armed immediately after switching the ignition to the 1 (OFF) position. The **THEFT** indicator will flash every two seconds.

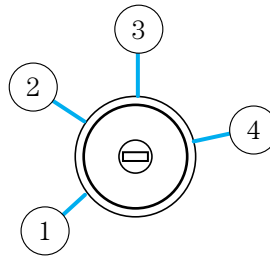

Automatic disarming

Switching the ignition to the 3 (ON) position with a **coded key** disarms the vehicle. The **THEFT** indicator will illuminate for three seconds and then go out. If the **THEFT** indicator stays on for an extended period of time or flashes rapidly, have the system serviced by your dealership or a qualified technician.

Key information

Your vehicle is supplied with **two coded keys**. Only a **coded key** will start your vehicle. Spare coded keys can be purchased from your dealership. Your dealership can program your key or you can “do it yourself.” Refer to *Programming spare keys*.

Locks and Security

The following items may prevent the vehicle from starting:

- Large metallic objects
- Electronic devices on the key chain that can be used to purchase gasoline or similar items
- A second key on the same key ring as the **coded key**

If any of these items are present, you need to keep these objects from touching the **coded key** while starting the engine. These objects and devices cannot damage the **coded key**, but can cause a momentary “no start” condition if they are too close to the key during engine start. If a problem occurs, turn ignition OFF and restart the engine with all other objects on the key ring held away from the ignition key. Check to make sure the **coded key** is an approved Lincoln **coded key**.

If your keys are lost or stolen you will need to do the following:

- Use your spare key to start the vehicle, or
- Have your vehicle towed to a dealership or a locksmith. The key codes will need to be erased from your vehicle and new key codes will need to be re-coded.

Replacing coded keys can be very costly and you may want to store an extra programmed key away from the vehicle in a safe place to prevent an unforeseen inconvenience.

The correct **coded key** must be used for your vehicle. The use of the wrong type of **coded key** may lead to a “no start” condition.

If an unprogrammed key is used in the ignition it will cause a “no start” condition.

Programming spare keys

A maximum of eight keys can be coded to your vehicle. Only SecuriLock[™] keys can be used. To program a **coded key** yourself, you will need two previously programmed **coded keys** (keys that already operate your vehicle’s engine) and the new unprogrammed key(s) readily accessible for timely implementation of each step in the procedure.

If two previously programmed coded keys are not available, you must bring your vehicle to your dealership to have the spare coded key(s) programmed.

Please read and understand the entire procedure before you begin.

Locks and Security

1. Insert the first previously programmed **coded key** into the ignition and turn the ignition from 1 (OFF) to 3 (ON) (maintain ignition in 3 (ON) for at least one second, but no more than ten seconds).

2. Turn ignition to 1 (OFF) and remove the first **coded key** from the ignition.

3. Within ten seconds of removing the first **coded key**, insert the second previously programmed **coded key** into the ignition and turn the ignition from 1 (OFF) to 3 (ON) (maintain ignition in 3 (ON) for at least one second but no more than ten seconds).

4. Turn the ignition to 1 (OFF) and remove the second **coded key** from the ignition.

5. Within 20 seconds of removing the second **coded key**, insert the new unprogrammed key (new key/valet key) into the ignition and turn the ignition from 1 (OFF) to 3 (ON) (maintain ignition in 3 (ON) for at least one second, but no more than ten seconds). This step will program your new key to a coded key.

6. To program additional new unprogrammed key(s), repeat this procedure from step 1.

If successful, the new coded key(s) will start the vehicle's engine and the theft indicator will illuminate for three seconds and then go out.

If not successful, the new coded key(s) will not start the vehicle's engine and the theft indicator will flash on and off and you may repeat steps 1 through 5. If failure repeats, bring your vehicle to your dealership to have the new spare key(s) programmed.

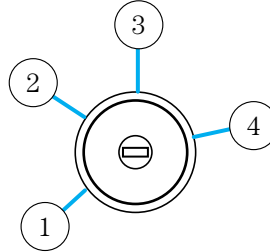

PERIMETER ALARM SYSTEM

The perimeter anti-theft system will help prevent your vehicle from unauthorized entry.

If there is any potential perimeter anti-theft problem with your vehicle, ensure **ALL remote entry transmitters** are brought to the dealership, to aid in troubleshooting.

Arming the system

When armed, this system will help protect your vehicle from unauthorized entry. When unauthorized entry occurs, the system will flash the headlamps and/or parking lamps, and will chirp the horn.

Locks and Security

The system is ready to arm whenever the key is removed from the ignition. Any of the following actions will prearm the alarm system:

- Open any door, liftgate or liftgate window and press the power door lock control to lock the doors.
- Press the remote entry lock control (doors opened or closed).

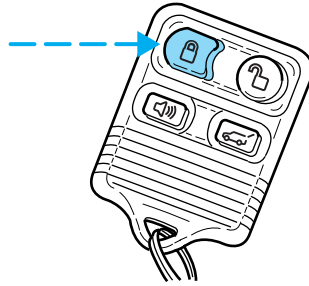

When you press the lock control twice within three seconds on your remote entry transmitter, the horn will chirp once to let you know that all doors/hood/liftgate and liftgate window are closed. If any of these are not closed, the horn will chirp twice to warn you that a door/hood/liftgate or liftgate window is still open.

- Press 7/8 and 9/0 controls on the keyless entry pad at the same time to lock the doors (driver's door must be closed).

There is a 20 second countdown when any of the above actions occur before the vehicle becomes ARMED.

Each door/hood/liftgate or liftgate window is armed individually, and if any are open, they must be closed for the system to enter the 20 second countdown.

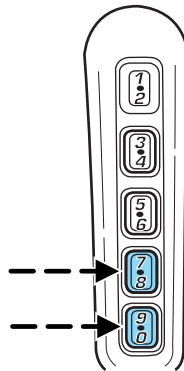

The parking lamps will flash once when all doors/hood/liftgate and liftgate window are closed indicating the vehicle is locked and entering the 20 second countdown.

Locks and Security

Disarming the system

You can disarm the system by any of the following actions:

- Unlock the doors by using your remote entry transmitter.

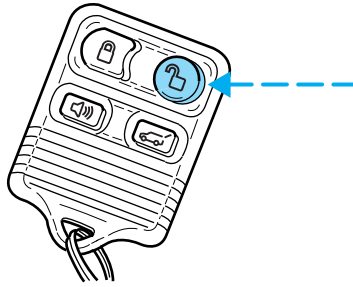

- Unlock the doors by using your keyless entry pad.

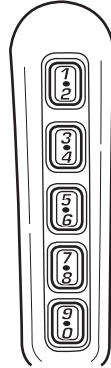

- Unlock the driver's door with a key. Turn the key full travel (toward the front of the vehicle) to make sure the alarm disarms.
- Turn ignition to ON.

Locks and Security

- Press the PANIC control on the remote entry transmitter. This will only shut off the horn and parking lamps when the alarm is sounding. The alarm system will still be armed.

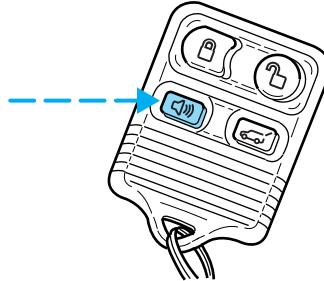

- Press the liftgate window control on the remote entry transmitter. The liftgate and liftgate window are no longer armed, but the doors and hood are still armed. To disarm the doors and hood, press the liftgate power door lock control.

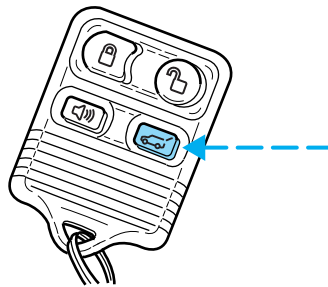

Pressing the power door UNLOCK trim switch within the 20 second prearmed mode will return the vehicle to a disarmed state.

Triggering the anti-theft system

The armed system will be triggered if:

- Any door, liftgate, liftgate window or hood is opened without using the door key, keypad or the remote entry transmitter.

Seating and Safety Restraints

SEATING

Adjustable head restraints

Your vehicle's seats may be equipped with head restraints which are vertically adjustable. The purpose of these head restraints is to help limit head motion in the event of a rear collision. To properly adjust your head restraints, lift the head restraint so that it is located directly behind your head or as close to that position as possible. Refer to the following illustrations to raise and lower the head restraints.

The head restraints can be moved up and down.

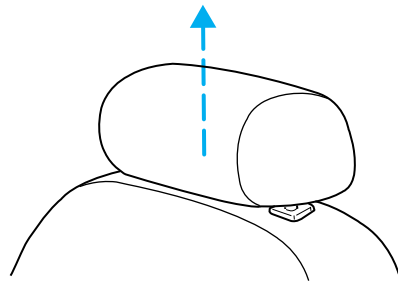

If the head restraint is fully lowered, push the release button to raise it.

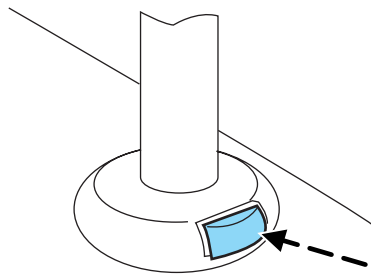

Push release button located on the side of the metal bar to lower head restraint.

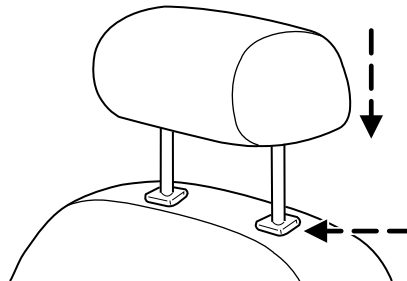

Seating and Safety Restraints

Using the power lumbar support

The power lumbar control is located on the door panel.

Press one side of the control to adjust firmness.

Press the other side of the control to adjust softness.

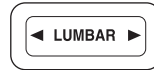

Using the manual recline function



Never adjust the driver's seat or seatback when the vehicle is moving.



Do not pile cargo higher than the seatbacks to avoid injuring people in a collision or sudden stop.



The driver and passenger seat must be in the upright position and the lap belt must be snug and low across the hips while the vehicle is moving.



Reclining the seatback can cause an occupant to slide under the seat's safety belt, resulting in severe personal injuries in the event of a collision.

To adjust the front seatback using the manual recliner:

- Lift and hold the handle located on the side of the seat.
- Lean against the seatback to adjust it to your desired position. You can recline the seat back or bring it forward.
- Release the handle when the desired position has been reached.

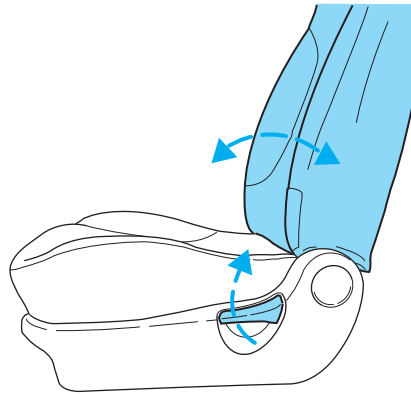

Seating and Safety Restraints

Adjusting the power front seats – door mounted controls

The controls for the power seats are located on the inside of each front door.



Never adjust the driver's seat or seatback when the vehicle is moving.



Do not pile cargo higher than the seatbacks to avoid injuring people in a collision or sudden stop.



Always drive and ride with your seatback upright and the lap belt snug and low across the hips.



Reclining the seatback can cause an occupant to slide under the seat's safety belt, resulting in severe personal injuries in the event of a collision.

Press to move the seat forward or backward.

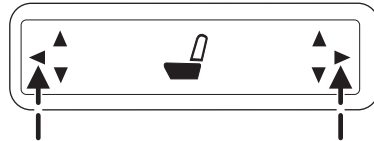

Press to move the front portion of the seat cushion up or down.

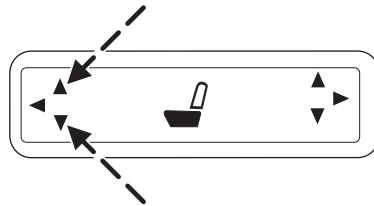

Seating and Safety Restraints

Press to move the rear portion of the seat cushion up or down.

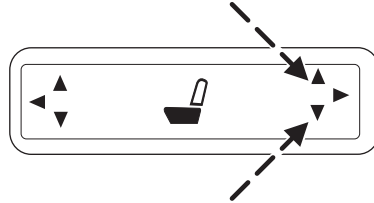

Memory seats/rearview mirrors/adjustable pedals

This system allows automatic positioning of the driver seat, outside rearview mirrors, and adjustable pedals to two programmable positions.

The memory seat control is located on the instrument panel to the left of the steering wheel.

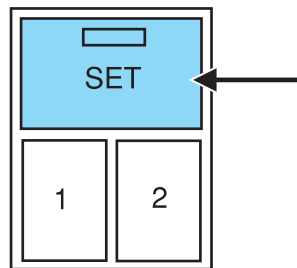

- To program position one, move the driver seat to the desired position using the seat controls. Press the SET control. The SET control indicator light will briefly illuminate (5 seconds). While the light is illuminated, press control 1.
- To program position two, repeat the previous procedure using control 2.

A position can only be recalled when the transmission gearshift is in Park or Neutral. A memory seat position may be programmed at any time.

The memory seat positions can also be recalled when you press your remote entry transmitter UNLOCK control.

To program the memory seat to remote entry transmitter, refer to *Remote entry system* in the *Locks and security chapter*.

Easy access/easy out feature

This feature automatically moves the driver's seat backward when:

- the transmission is in N (Neutral) or P (Park)
- the key is removed from the ignition cylinder

The seat will move 5 cm (2 inches) forward (to the original position) when:

- the transmission is in N (Neutral) or P (Park)
- the key is placed in the ignition cylinder

Seating and Safety Restraints

Deactivating/activating the easy entry/exit feature

The easy entry/exit feature may also be turned on and off using the following key sequence. This procedure must be performed within 20 seconds.

1. Remove the key from the ignition (if currently inserted).
2. Insert the ignition key into the ignition switch.
3. Turn the ignition key to the run position.
4. Place the ignition key to the off position.
5. Turn the ignition key to the run position.
6. Place the ignition key to the off position.
7. Turn the ignition key to the run position.
8. Place the ignition key to the off position.
9. Momentarily activate the horizontal seat switch in either the forward or rearward direction.
10. Remove the ignition key from the ignition switch.

CLIMATE CONTROL SEATS (if equipped)

The climate seat controls are located on the inside of the front doors.

To operate the climate control seats the engine must be running.

- Push the icon on the button to activate cooled seats. A blue light illuminates on the button. Push the icon again to disengage.

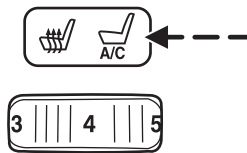

- Push the icon on the button to activate heated seats. A red light illuminates on the button. Push the icon again to disengage.

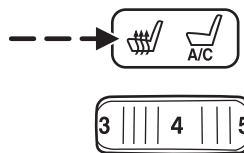

Seating and Safety Restraints

In heat mode:

- Rotate the thumbwheel to select the desired heat level from 1 (MIN) to 5 (MAX).



In cool mode:

- Rotate the thumbwheel to select the desired cooling level from 1 (MIN) to 5 (MAX). When setting **1** is selected, the seat(s) will provide vent cooling only (same temperature as cabin air).

Allow five minutes for the temperature level to stabilize.

Climate controlled seats air filter replacement (if equipped)

The climate controlled seat system includes an air filter that has to be replaced periodically. Refer to the *Scheduled Maintenance Guide* for more information.

- There is a filter located under both front seats.

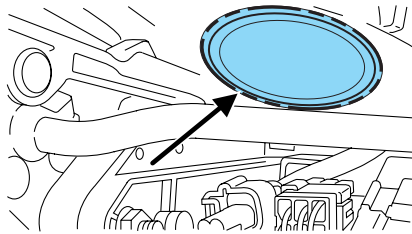

- It can be accessed from the second row seat. Move the front seat all the way forward and up to ease access.

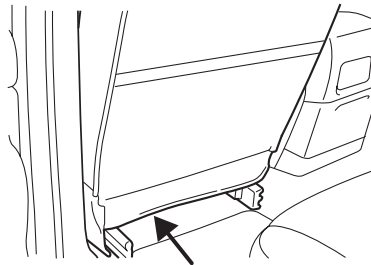

Seating and Safety Restraints

To remove climate controlled seat air filter:

- Remove key from ignition.
- Push on the outside rigid edge of the air filter at the center and rotate toward the front of the vehicle once tabs are released.

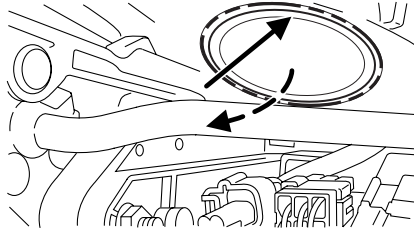

- Remove filter.

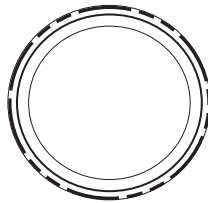

To install climate controlled seat air filter:

- First, position the filter in its housing making sure that the far forward end is all the way up in the housing. Then push in on the center of the outside edge of the filter and rotate up into the housing until it clips into position.

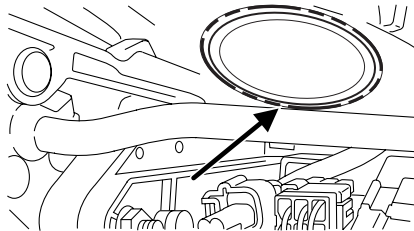

REAR SEATS

Adjustable head restraints (40/20/40 not bucket)

Your vehicle's rear seats are equipped with head restraints which are vertically adjustable. The purpose of these head restraints is to help limit head motion in the event of a rear collision. To properly adjust your head restraints, lift the head restraint so that it is located directly behind your head or as close to that position as possible.

Seating and Safety Restraints

The head restraints can be raised by lifting. If the head restraint is fully lowered, press the release button to raise it. To raise or lower the head restraint, press the release button located on the side of the metal bar.

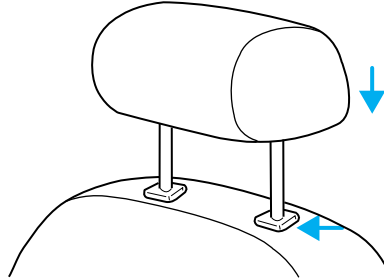

If the head restraint becomes detached, replace the notched bar into the holes while holding the release button.

Folding down the 40/20/40 or bucket rear seats

Ensure that the headrest is in the down position and no objects such as books, purses or briefcases are on the floor in front of the second row seats before folding them down.

Move front passenger seat forward so that the second row seat headrest clears the front seat.

For assistance, refer to the label located on the plastic side shield.

1. Locate handle on the side of the seat cushion by the door.
2. Pull the handle down and the seatback will fall toward the front of the vehicle.
3. Press down on the top outboard area of the seatback until a click is heard.

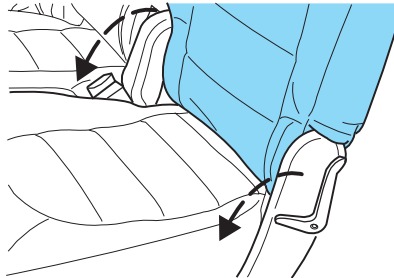

Seating and Safety Restraints

To return the seat to the upright position:

1. Pull the handle down to release the lock position and lift the seatback toward the rear of the vehicle.
2. Rotate the seatback until you hear a click, locking it in the upright position.

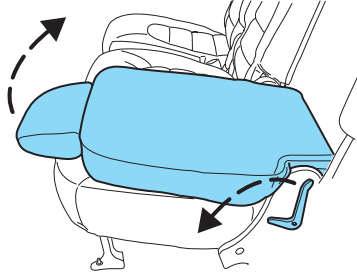

Adjusting the second row recline

The second row seat reclines for additional comfort. To adjust the second row recline pull the handle forward and push the seat back rearward.



Reclining the seatback can cause an occupant to slide under the seat's safety belt, resulting in severe personal injuries in the event of a collision.

Adjusting the 2nd row seat for E-Z Entry

The E-Z Entry seat allows for easier entry and exit to and from the 3rd row seat.

To enter the 3rd row seat:

1. Fold down the 2nd row seat.
2. Pull the handle all the way down until the seat releases from the floor and folds away.

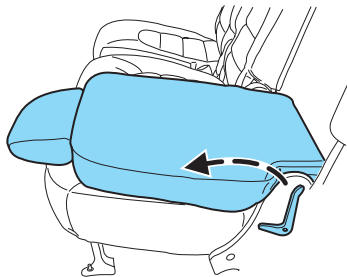

Seating and Safety Restraints

3. To return the seat to a seating position, flip the seat into the upright position.

4. Make sure the seat is latched to the floor.

If the seat is not firmly latched to the floor, the seat back will not lock in the upright position. To adjust, you must unlatch the seat from the floor and retry.

To exit the 3rd row seat, pull the red access control lever up releasing the seat from the floor and rotate the seat up towards the front seat.

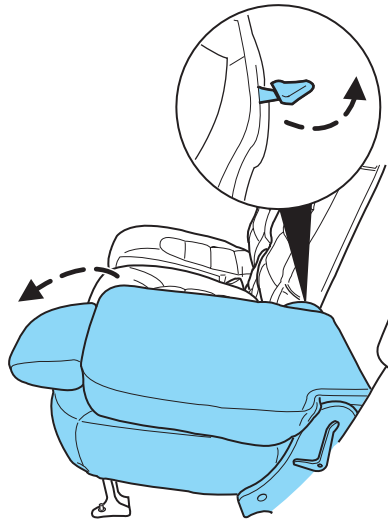
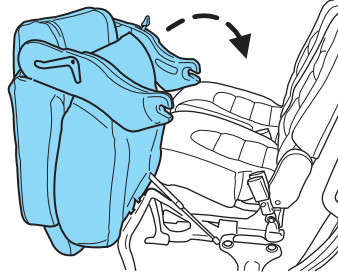

Always latch the vehicle seat to the floor, whether the seat is occupied or empty. If not latched, the seat may cause injury during a sudden stop.

Seating and Safety Restraints

Folding the middle 2nd row seat (If equipped)

1. Locate the lever on the top of the seatback.
2. Pull the lever up and push the seatback toward the front of the vehicle.
3. Press down on the top outboard area of the seatback until a click is heard.

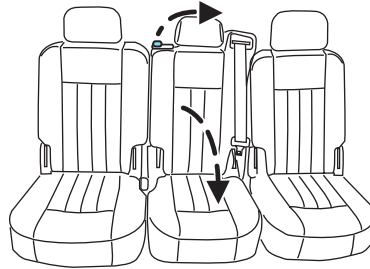

To return the seatback to the upright position:

1. Pull the lever and lift the seatback toward the rear of the vehicle.
2. Rotate the seatback until you hear a click, locking it in the upright position.

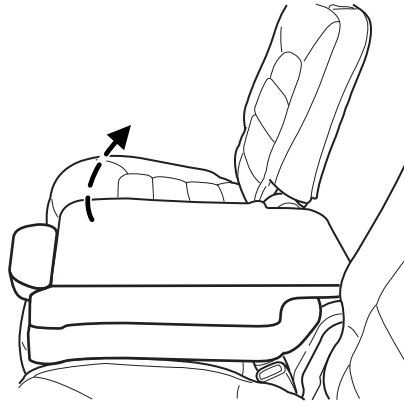

3rd row stow feature

The 3rd row seat has a tip/stow feature to increase cargo space without removing the seat from the vehicle.

Lower the head restraints before putting the seat in the stowed position.

Seating and Safety Restraints

To put seat in stowed position:

1. Pull the seat release lever located on top of the seatback while pushing the seatback down onto the seat cushion.
2. The seatback will latch into place.

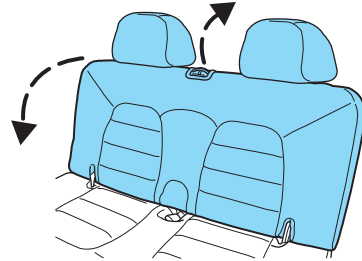

3. Push the closeout panel forward over the space between the seats.

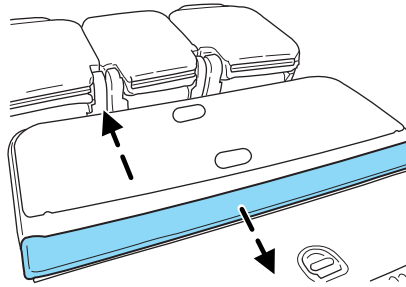

To put seat in upright position:

1. Pull back the slider panel on the seatback to release the closeout panel.

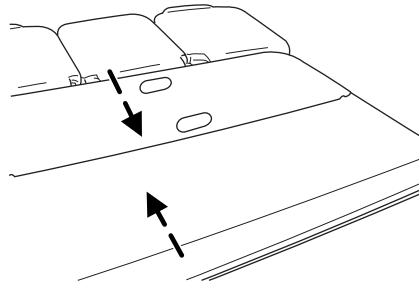

Seating and Safety Restraints

2. Pull the seat release lever located on top of the seatback while lifting the seatback into the upright position.
3. The seatback will latch into place.

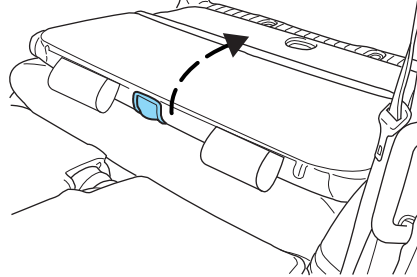

The third row seat is equipped with combination lap and shoulder belts in both seating positions. For information on the proper operation of the safety restraints, refer to *Safety Restraints* in this chapter.

SAFETY RESTRAINTS

Safety restraints precautions



Always drive and ride with your seatback upright and the lap belt snug and low across the hips.



To reduce the risk of injury, make sure children sit where they can be properly restrained.



Never let a passenger hold a child on his or her lap while the vehicle is moving. The passenger cannot protect the child from injury in a collision.



All occupants of the vehicle, including the driver, should always properly wear their safety belts, even when an air bag (SRS) is provided.



It is extremely dangerous to ride in a cargo area, inside or outside of a vehicle. In a collision, people riding in these areas are more likely to be seriously injured or killed. Do not allow people to ride in any area of your vehicle that is not equipped with seats and safety belts. Be sure everyone in your vehicle is in a seat and using a safety belt properly.

Seating and Safety Restraints



In a rollover crash, an unbelted person is significantly more likely to die than a person wearing a safety belt.



Each seating position in your vehicle has a specific safety belt assembly which is made up of one buckle and one tongue that are designed to be used as a pair. 1) Use the shoulder belt on the outside shoulder only. Never wear the shoulder belt under the arm. 2) Never swing the safety belt around your neck over the inside shoulder. 3) Never use a single belt for more than one person.



Always transport children 12 years old and under in the back seat and always properly use appropriate child restraints.



Safety belts and seats can become hot in a vehicle that has been closed up in sunny weather; they could burn a small child. Check seat covers and buckles before you place a child anywhere near them.

Combination lap and shoulder belts

1. Insert the belt tongue into the proper buckle (the buckle closest to the direction the tongue is coming from) until you hear a snap and feel it latch. Make sure the tongue is securely fastened in the buckle.

- Front and rear seats

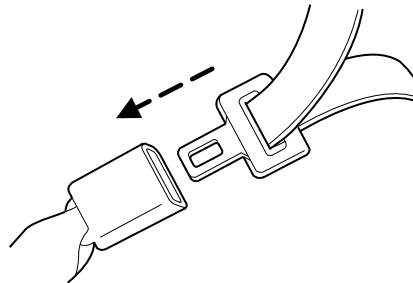

2. To unfasten, push the release button and remove the tongue from the buckle.

Seating and Safety Restraints

- Front and rear seats

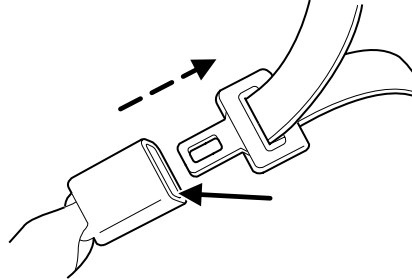

All safety restraints in the vehicle are combination lap and shoulder belts. All of the passenger combination lap and shoulder belts have two types of locking modes described below:

Vehicle sensitive mode

This is the normal retractor mode, which allows free shoulder belt length adjustment to your movements and locking in response to vehicle movement. For example, if the driver brakes suddenly or turns a corner sharply, or the vehicle receives an impact of approximately 8 km/h (5 mph) or more, the combination safety belts will lock to help reduce forward movement of the driver and passengers.

Automatic locking mode

In this mode, the shoulder belt is pre-locked. The belt will still retract to remove any slack in the shoulder belt.

The automatic locking mode is not available on the driver safety belt.

When to use the automatic locking mode

- **Anytime** a child safety seat (except a booster) is installed in the vehicle. Children 12 years old and under should be properly restrained in the rear seat whenever possible. Refer to *Safety restraints for children* or *Safety seats for children* later in this chapter.

Seating and Safety Restraints

How to use the automatic locking mode

1. Buckle the combination lap and shoulder belt.

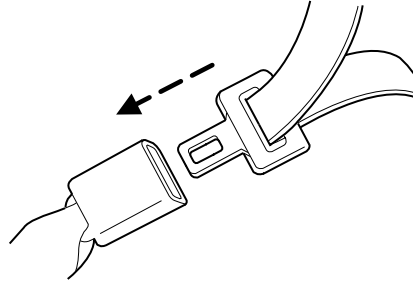

2. Grasp the shoulder portion and pull downward until the entire belt is pulled out.

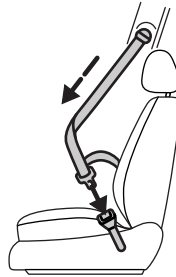

3. Allow the belt to retract. As the belt retracts, you will hear a clicking sound. This indicates the safety belt is now in the automatic locking mode.

How to disengage the automatic locking mode

Unbuckle the combination lap and shoulder belt and allow it to retract completely to disengage the automatic locking mode and activate the vehicle sensitive (emergency) locking mode.



After any vehicle collision, the combination lap and shoulder belt system at all passenger seating positions must be checked by a qualified technician to verify that the “automatic locking retractor” feature for child seats is still functioning properly, in addition to other checks for proper seat belt system function.

Seating and Safety Restraints



BELT AND RETRACTOR ASSEMBLY MUST BE REPLACED if the safety belt assembly “automatic locking retractor” feature or any other safety belt function is not operating properly. In addition, all safety belts should be checked for proper function. Failure to replace the belt and retractor assembly could increase the risk of injury in collisions.

Safety belt pretensioner

Your vehicle is equipped with safety belt pretensioners at the driver and right front passenger seating positions.

The safety belt pretensioner removes some slack from the safety belt system at the start of a crash. The safety belt pretensioner uses the same crash sensor system as the front airbags and Safety Canopy[™] system. When the safety belt pretensioner deploys, the lap and shoulder belt are tightened.

When the Safety Canopy[™] system and/or the front airbags are activated, the safety belt pretensioners for the driver and right front passenger seating positions will be activated when the respective seatbelt is properly buckled.



The driver and the right front passenger seat belt system (including retractors, buckles and height adjusters) must be replaced if the vehicle is involved in a collision that results in deployment of front air bags or Safety Canopy[™] and safety belt pretensioners.

Refer to the *Safety belt maintenance* section in this chapter.

Seating and Safety Restraints

Front and second row safety belt height adjustment

Your vehicle has safety belt height adjustments for the driver, right front passenger and second row outboard passengers. Adjust the height of the shoulder belt so the belt rests across the middle of your shoulder.

To lower the shoulder belt height, push the button and slide the height adjuster down. To raise the height of the shoulder belt, push the button and slide the height adjuster

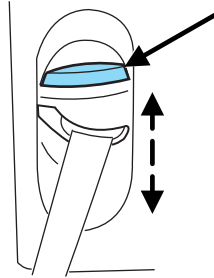

up. Pull down on the height adjuster to make sure it is locked in place.



Position the safety belt height adjusters so that the belt rests across the middle of your shoulder. Failure to adjust the safety belt properly could reduce the effectiveness of the seat belt and increase the risk of injury in a collision.

Safety belt warning light and indicator chime

The safety belt warning light illuminates in the instrument cluster and a chime sounds to remind the occupants to fasten their safety belts.

Conditions of operation

If...	Then...
The driver safety belt is not buckled before the ignition switch is turned to the ON position...	The safety belt warning light illuminates 1-2 minutes and the warning chime sounds 4-8 seconds.
The driver safety belt is buckled while the indicator light is illuminated and the warning chime is sounding...	The safety belt warning light and warning chime turn off.
The driver safety belt is buckled before the ignition switch is turned to the ON position...	The safety belt warning light and indicator chime remain off.

Seating and Safety Restraints

BeltMinder

The BeltMinder feature is a supplemental warning to the safety belt warning function. This feature provides additional reminders to the driver that the driver's safety belt is unbuckled by intermittently sounding a chime and illuminating the safety belt warning lamp in the instrument cluster.

If...	Then...
The driver's safety belt is not buckled before the vehicle has reached at least 5 km/h (3 mph) and approximately 5 seconds has elapsed after the safety belt warning light has turned off.	The BeltMinder feature is activated - the safety belt warning light illuminates and the warning chime sounds for 6 seconds every 30 seconds, repeating for approximately 5 minutes or until safety belt is buckled.
The driver's safety belt is buckled while the safety belt indicator light is illuminated and the safety belt warning chime is sounding...	The BeltMinder feature will not activate.
The driver's safety belt is buckled before the ignition switch is turned to the ON position...	The BeltMinder feature will not activate.

The following are reasons most often given for not wearing safety belts: (All statistics based on U.S. data)

Reasons given...	Consider...
"Crashes are rare events"	36700 crashes occur every day. The more we drive, the more we are exposed to "rare" events, even for good drivers. <i>1 in 4 of us will be seriously injured in a crash during our lifetime.</i>
"I'm not going far"	3 of 4 fatal crashes occur within 25 miles of home.

Seating and Safety Restraints

Reasons given...	Consider...
“Belts are uncomfortable”	We design our safety belts to enhance comfort. If you are uncomfortable - try different positions for the safety belt upper anchorage and seatback which should be as upright as possible; this can improve comfort.
“I was in a hurry”	Prime time for an accident. BeltMinder reminds us to take a few seconds to buckle up.
“Safety belts don’t work”	Safety belts , when used properly, reduce risk of death to front seat occupants by 45% in cars , and by 60% in light trucks .
“Traffic is light”	Nearly 1 of 2 deaths occur in single-vehicle crashes , many when no other vehicles are around.
“Belts wrinkle my clothes”	Possibly, but a serious crash can do much more than wrinkle your clothes, particularly if you are unbelted.
“The people I’m with don’t wear belts”	Set the example, teen deaths occur 4 times more often in vehicles with TWO or MORE people. Children and younger brothers/sisters imitate behavior they see.
“I have an air bag”	Air bags offer greater protection when used with safety belts. Frontal airbags are not designed to inflate in rear and side crashes or rollovers.
“I’d rather be thrown clear”	Not a good idea. People who are ejected are 40 times more likely to DIE . Safety belts help prevent ejection, WE CAN’T “PICK OUR CRASH”.

Seating and Safety Restraints



Do not sit on top of a buckled safety belt to avoid the Belt Minder chime. Sitting on the safety belt will increase the risk of injury in an accident. To disable (one-time) or deactivate the Belt Minder feature please follow the directions stated below.

One time disable

Any time the safety belt is buckled and then unbuckled during an ignition ON cycle, the BeltMinder will be disabled for that ignition cycle only.

Deactivating/activating the BeltMinder feature

Read steps 1 - 9 thoroughly before proceeding with the deactivation/activation programming procedure.

The BeltMinder feature can be deactivated/activated by performing the following procedure:

Before following the procedure, make sure that:

- The parking brake is set
- The gearshift is in P (Park) (automatic transmission)
- The ignition switch is in the OFF position
- All vehicle doors are closed
- The driver's safety belt is unbuckled
- The parklamps/headlamps are in OFF position (If vehicle is equipped with Autolamps, this will not affect the procedure.)



To reduce the risk of injury, do not deactivate/activate the Belt Minder feature while driving the vehicle.

1. Turn the ignition switch to the RUN (or ON) position. (DO NOT START THE ENGINE)
2. Wait until the safety belt warning light turns off. (Approximately 1–2 minutes)
 - Steps 3–5 must be completed within 60 seconds or the procedure will have to be repeated.
3. Buckle then unbuckle the safety belt three times, ending with the safety belt unbuckled. This can be done before or during BeltMinder warning activation.
4. Turn on the parklamps/headlamps, turn off the parklamps/headlamps.

194

Seating and Safety Restraints

5. Buckle then unbuckle the safety belt three times, ending with the safety belt unbuckled.
 - After step 5 the safety belt warning light will be turned on for three seconds.
6. Within seven seconds of the safety belt warning light turning off, buckle then unbuckle the safety belt.
 - This will disable BeltMinder if it is currently enabled, or enable BeltMinder if it is currently disabled.
7. Confirmation of disabling BeltMinder is provided by flashing the safety belt warning light four times per second for three seconds.
8. Confirmation of enabling BeltMinder is provided by flashing the safety belt warning light four times per second for three seconds, followed by three seconds with the safety belt warning light off, then followed by flashing the safety belt warning light four times per second for three seconds again.
9. After receiving confirmation, the deactivation/activation procedure is complete.

Safety belt extension assembly

If the safety belt is too short when fully extended, there is a 20 cm (8 inch) safety belt extension assembly that can be added (part number 611C22). This assembly can be obtained from your dealer at no cost.

Use only extensions manufactured by the same supplier as the safety belt. Manufacturer identification is located at the end of the webbing on the label. Also, use the safety belt extension only if the safety belt is too short for you when fully extended.



Do not use extensions to change the fit of the shoulder belt across the torso.

Safety belt maintenance

Inspect the safety belt systems periodically to make sure they work properly and are not damaged. Inspect the safety belts to make sure there are no nicks, tears or cuts. Replace if necessary. All safety belt assemblies, including retractors, buckles, front seat belt buckle assemblies, buckle support assemblies (slide bar-if equipped), shoulder belt height adjusters (if equipped), shoulder belt guide on seatback (if equipped), child safety seat LATCH and tether anchors, and attaching hardware, should be inspected after a collision. Ford Motor Company

Seating and Safety Restraints

recommends that all safety belt assemblies used in vehicles involved in a collision be replaced. However, if the collision was minor and a qualified technician finds that the belts do not show damage and continue to operate properly, they do not need to be replaced. Safety belt assemblies not in use during a collision should also be inspected and replaced if either damage or improper operation is noted.



Failure to inspect and if necessary replace the safety belt assembly under the above conditions could result in severe personal injuries in the event of a collision.

Refer to *Interior* in the *Cleaning* chapter.

AIR BAG SUPPLEMENTAL RESTRAINT SYSTEM (SRS)

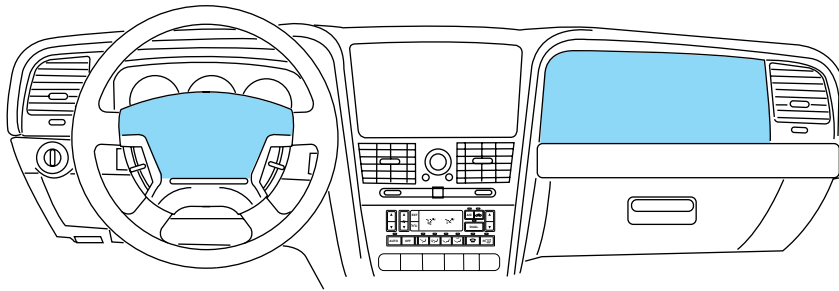

Important SRS precautions

The SRS is designed to work with the safety belt to help protect the driver and right front passenger from certain upper body injuries. Air bags DO NOT inflate slowly; there is a risk of injury from a deploying air bag.

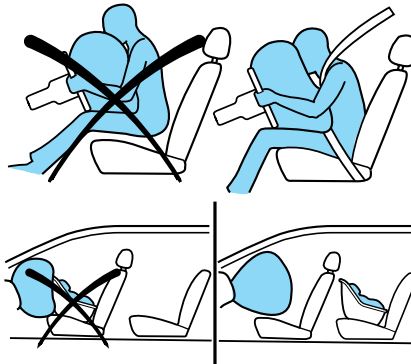

Seating and Safety Restraints



All occupants of the vehicle, including the driver, should always properly wear their safety belts, even when an air bag (SRS) is provided.



Always transport children 12 years old and under in the back seat and always properly use appropriate child restraints.



The National Highway Traffic Safety Administration (NHTSA) recommends a minimum distance of at least 25 cm (10 inches) between an occupant's chest and the driver air bag module.



Never place your arm over the air bag module as a deploying air bag can result in serious arm fractures or other injuries.

To properly position yourself away from the air bag:

- Move your seat to the rear as far as you can while still reaching the pedals comfortably.
- Recline the seat slightly one or two degrees from the upright position.



Do not put anything on or over the air bag module. Placing objects on or over the air bag inflation area may cause those objects to be propelled by the air bag into your face and torso causing serious injury.



Do not attempt to service, repair, or modify the air bag supplemental restraint systems or its fuses. See your Ford or Lincoln Mercury dealer.



Modifying or adding equipment to the front end of the vehicle (including frame, bumper, front end body structure and tow hooks) may affect the performance of the air bag system, increasing the risk of injury. Do not modify the front end of the vehicle.



Additional equipment may affect the performance of the air bag sensors increasing the risk of injury. Please refer to the Body Builders Layout Book for instructions about the appropriate installation of additional equipment.

Seating and Safety Restraints

Children and air bags

Children must always be properly restrained. Accident statistics suggest that children are safer when properly restrained in the rear seating positions than in the front seating position. Failure to follow these instructions may increase the risk of injury in a collision.

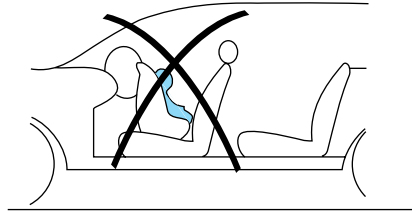

Air bags can kill or injure a child in a child seat.

NEVER place a rear-facing child seat in front of an active air bag. If you must use a forward-facing child seat in the front seat, move the seat all the way back.

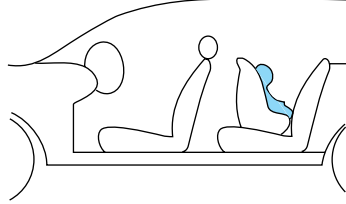

How does the air bag supplemental restraint system work?

The air bag SRS is designed to activate when the vehicle sustains longitudinal deceleration sufficient to cause the sensors to close an electrical circuit that initiates air bag inflation.

The fact that the air bags did not inflate in a collision does not mean that something is wrong with the system. Rather, it means the forces were not of the type sufficient to cause activation. The driver and passenger airbags are designed to inflate in frontal and near-frontal collisions, not rollover, side-impact, or rear-impacts unless the collision causes sufficient longitudinal deceleration.

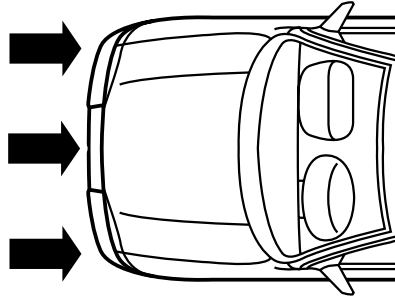

Seating and Safety Restraints

The air bags inflate and deflate rapidly upon activation. After air bag deployment, it is normal to notice a smoke-like, powdery residue or smell the burnt propellant. This may consist of cornstarch, talcum powder (to lubricate the bag) or sodium compounds (e.g., baking soda) that result from the combustion process that inflates the air bag. Small amounts of sodium hydroxide may be present which may irritate the skin and eyes, but none of the residue is toxic.



While the system is designed to help reduce serious injuries, contact with a deploying air bag may also cause abrasions, swelling or temporary hearing loss. Because air bags must inflate rapidly and with considerable force, there is the risk of death or serious injuries such as fractures, facial and eye injuries or internal injuries, particularly to occupants who are not properly restrained or are otherwise out of position at the time of air bag deployment. Thus, it is extremely important that occupants be properly restrained as far away from the air bag module as possible while maintaining vehicle control.



Several air bag system components get hot after inflation. Do not touch them after inflation.



If the air bag has deployed, **the air bag will not function again and must be replaced immediately.** If the air bag is not replaced, the unrepaired area will increase the risk of injury in a collision.

The SRS consists of:

- driver and passenger air bag modules (which include the inflators and air bags),
- one or more impact and safing sensors and diagnostic monitor (RCM),
- a readiness light and tone
- the electrical wiring which connects the components.

Seating and Safety Restraints

The RCM (restraints control module) monitors its own internal circuits and the supplemental air bag electrical system warning (including the impact sensors, the system wiring, the air bag system readiness light, the air bag back up power and the air bag ignitors).

Safety Canopy™ system



Do not place objects or mount equipment on or near the headliner at the siderail that may come into contact with a deploying Safety Canopy™. Failure to follow these instructions may increase the risk of personal injury in the event of a collision.

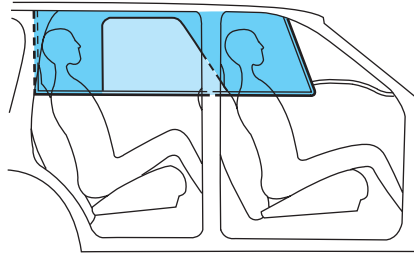

Do not lean your head on the door. The Safety Canopy™ could injure you as it deploys from the headliner.



Do not attempt to service, repair, or modify the Safety Canopy™ system, its fuses, the A, B, or C pillar trim, or the headliner on a vehicle containing a Safety Canopy™. See your Ford or Lincoln Mercury dealer.



All occupants of the vehicle including the driver should always wear their safety belts even when an air bag SRS and Safety Canopy™ system is provided.



To reduce risk of injury, do not obstruct or place objects in the deployment path of the inflatable Safety Canopy™.

Seating and Safety Restraints

How does the Safety Canopy™ system work?

The design and development of the Safety Canopy™ system included recommended testing procedures that were developed by a group of automotive safety experts known as the Side Airbag Technical Working Group. These recommended testing procedures help reduce the risk of injuries related to the deployment of side airbags (including the Safety Canopy™).

The Safety Canopy™ system consists of the following:

- An inflatable nylon curtain with a gas generator concealed behind the headliner and above the doors (one on each side of the vehicle).
- A headliner that will flex to open above the side doors to allow Safety Canopy™ deployment.
- The same warning light, electronic control and diagnostic unit as used for the front airbags.
- Two side crash sensors mounted at the base of the B-pillar (one on each side).
- Two side crash sensors located at the c-pillar behind the rear doors (one on each side).
- Roll over sensor in the restraints control module (RCM).

The Safety Canopy™ system, in combination with seat belts, can help reduce the risk of severe injuries in the event of a significant side impact collision or rollover event.

Children 12 years old and under should always be properly restrained in the second or third row seats (if equipped). The Safety Canopy™ will not interfere with children restrained using a properly installed child or booster seat because it is designed to inflate downward from the headliner above the doors along the side window openings.

The Safety Canopy™ system is designed to activate when the vehicle sustains lateral deceleration sufficient to cause the side crash sensor to close an electrical circuit that initiates Safety Canopy™ inflation or when a certain likelihood of a rollover event is detected by the rollover sensor.

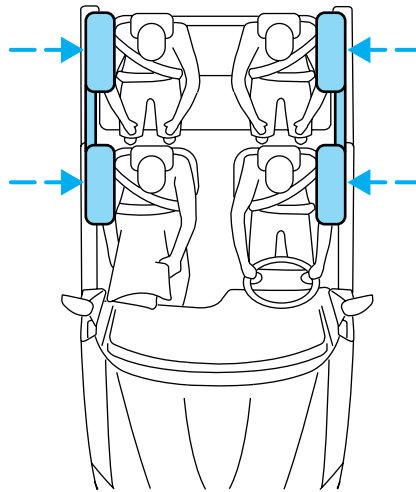



Seating and Safety Restraints

The Safety Canopy™ is mounted to the roof side-rail sheet metal, behind the headliner, above the first and second row seats. In certain lateral collisions or rollover events, the Safety Canopy™ system will be activated, regardless of which seats are occupied. The Safety Canopy™ is designed to inflate between the side window area and occupants to further enhance protection provided in side impact collisions and rollover events.

The fact that the Safety Canopy™ system did not activate in a collision does not mean that something is wrong with the system. Rather, it means the forces were not of the type sufficient to cause activation. The Safety Canopy™ is designed to inflate in certain side impact collisions or rollover events, not in rear impact, frontal or near-frontal collisions, unless the collision causes sufficient lateral deceleration or rollover likelihood.

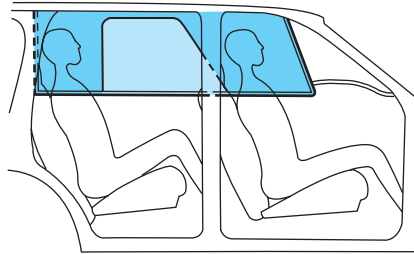
 Several Safety Canopy™ system components get hot after inflation. Do not touch them after inflation.



 If the Safety Canopy™ system has deployed, **the Safety Canopy™ will not function again. The Safety Canopy™ system (including the A, B and C pillar trim) must be inspected and serviced by a qualified technician in accordance with the vehicle service manual.** If the Safety Canopy™ is not replaced, the unrepaired area will increase the risk of injury in a collision.

Determining if the system is operational

The SRS uses a readiness light in the instrument cluster or a tone to indicate the condition of the system. Refer to the *Air bag readiness* section in the *Instrument Cluster* chapter. Routine maintenance of the air bag is not required.

Seating and Safety Restraints

Any difficulty with the system is indicated by one or more of the following:

- The readiness light (same light as for front air bag system) will either flash or stay lit.
- The readiness light will not illuminate immediately after ignition is turned on.
- A series of five beeps will be heard. The tone pattern will repeat periodically until the problem and light are repaired.

If any of these things happen, even intermittently, have the SRS serviced at your dealership or by a qualified technician immediately. Unless serviced, the system may not function properly in the event of a collision or rollover event.

Disposal of air bags and air bag equipped vehicles (including pretensioners)

See your local dealership or qualified technician. Air bags **MUST BE** disposed of by qualified personnel.

SAFETY RESTRAINTS FOR CHILDREN

See the following sections for directions on how to properly use safety restraints for children. Also see *Air bag supplemental restraint system (SRS)* in this chapter for special instructions about using air bags.

Important child restraint precautions

You are required by law to use safety restraints for children in the U.S. and Canada. If small children (generally children who are four years old or younger and who weigh 18 kg [40 lbs] or less) ride in your vehicle, you must put them in safety seats made especially for children. Check your local and state or provincial laws for specific requirements regarding the safety of children in your vehicle. When possible, always place children under age 12 in the rear seat of your vehicle. Accident statistics suggest that children are safer when properly restrained in the rear seating positions than in the front seating position.



Never let a passenger hold a child on his or her lap while the vehicle is moving. The passenger cannot protect the child from injury in a collision.

Always follow the instructions and warnings that come with any infant or child restraint you might use.

Seating and Safety Restraints

Children and safety belts

If the child is the proper size, restrain the child in a safety seat. Children who are too large for child safety seats (as specified by your child safety seat manufacturer) should always wear safety belts.

Follow all the important safety restraint and air bag precautions that apply to adult passengers in your vehicle.

If the shoulder belt portion of a combination lap and shoulder belt can be positioned so it does not cross or rest in front of the child's face or neck, the child should wear the lap and shoulder belt. Moving the child closer to the center of the vehicle may help provide a good shoulder belt fit.



Do not leave children, unreliable adults, or pets unattended in your vehicle.

Child booster seats

Children outgrow a typical convertible or toddler seat when they weigh 40 pounds and are around 4 years of age. Although the lap/shoulder belt will provide some protection, these children are still too small for lap/shoulder belts to fit properly, which could increase the risk of serious injury.

To improve the fit of both the lap and shoulder belt on children who have outgrown child safety seats, Ford Motor Company recommends use of a belt-positioning booster.

Booster seats position a child so that safety belts fit better. They lift the child up so that the lap belt rests low across the hips and the knees bend comfortably. Booster seats also make the shoulder belt fit better and more comfortably for growing children.

When children should use booster seats

Children need to use booster seats from the time they outgrow the toddler seat until they are big enough for the vehicle seat and lap/shoulder belt to fit properly. Generally this is when they weigh about 80 lbs (about 8 to 12 years old).

Seating and Safety Restraints

Booster seats should be used until you can answer YES to ALL of these questions:

- Can the child sit all the way back against the vehicle seat back with knees bent comfortably at the edge of the seat without slouching?

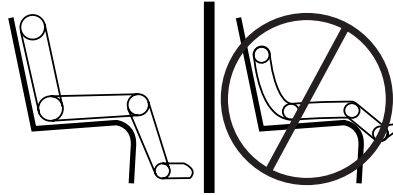

- Does the lap belt rest low across the hips?
- Is the shoulder belt centered on the shoulder and chest?
- Can the child stay seated like this for the whole trip?

Types of booster seats

There are two types of belt-positioning booster seats:

- Those that are backless.

If your backless booster seat has a removable shield, remove the shield and use the lap/shoulder belt. If a seating position has a low seat back and no head restraint, a backless booster seat may place your child's head (top of ear level) above the top of the seat. In this case, move the backless booster to another seating position with a higher seat back and lap/shoulder belts.



- Those with a high back.

If, with a backless booster seat, you cannot find a seating position that adequately supports your child's head, a high back booster seat would be a better choice.



Both can be used in any vehicle in a seating position equipped with lap/shoulder belts if your child is over 40 lbs.

Seating and Safety Restraints

The shoulder belt should cross the chest, resting snugly on the center of the shoulder. The lap belt should rest low and snug across the hips, never up high across the stomach.

If the booster seat slides on the vehicle seat, placing a rubberized mesh sold as shelf or carpet liner under the booster seat may improve this condition.

The importance of shoulder belts

Using a booster without a shoulder belt increases the risk of a child's head hitting a hard surface in a collision. For this reason, you should never use a booster seat with a lap belt only. It is best to use a booster seat with lap/shoulder belts in the back seat- the safest place for children to ride.



Follow all instructions provided by the manufacturer of the booster seat.



Never put the shoulder belt under a child's arm or behind the back because it eliminates the protection for the upper part of the body and may increase the risk of injury or death in a collision.



Never use pillows, books, or towels to boost a child. They can slide around and increase the likelihood of injury or death in a collision.

SAFETY SEATS FOR CHILDREN



Child and infant or child safety seats

Use a safety seat that is recommended for the size and weight of the child. Carefully follow all of the manufacturer's instructions with the safety seat you put in your vehicle. If you do not install and use the safety seat properly, the child may be injured in a sudden stop or collision.

Seating and Safety Restraints

When installing a child safety seat:

- Review and follow the information presented in the *Air bag supplemental restraint system (SRS)* section in this chapter.
- Use the correct safety belt buckle for that seating position (the buckle closest to the direction the tongue is coming from).
- Insert the belt tongue into the proper buckle until you hear a snap and feel it latch. Make sure the tongue is securely fastened in the buckle.
- Keep the buckle release button pointing up and away from the safety seat, with the tongue between the child seat and the release button, to prevent accidental unbuckling.
- Place seat back in upright position.
- Put the safety belt in the automatic locking mode. Refer to *Automatic locking mode* (passenger side front and all rear seating positions) (if equipped) section in this chapter.

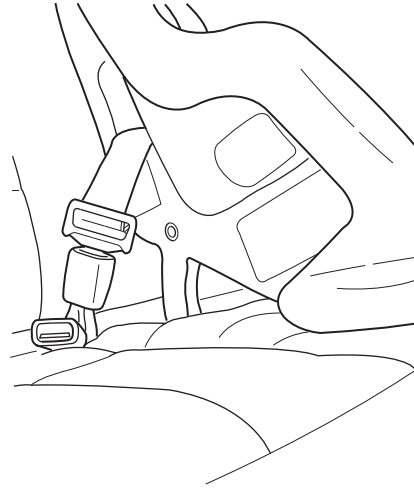

Ford recommends the use of a child safety seat having a top tether strap. Install the child safety seat in a seating position with a tether anchor. For more information on top tether straps, refer to *Attaching child safety seats with tether straps*. in this chapter.



Carefully follow all of the manufacturer's instructions included with the safety seat you put in your vehicle. If you do not install and use the safety seat properly, the child may be injured in a sudden stop or collision.



Rear-facing child seats or infant carriers should never be placed in the front seats.

Seating and Safety Restraints

Installing child safety seats with combination lap and shoulder belts

 Air bags can kill or injure a child in a child seat. **NEVER** place a rear-facing child seat in front of an active air bag. If you must use a forward-facing child seat in the front seat, move the seat all the way back.

 Children 12 and under should be properly restrained in the rear seat whenever possible.

1. Position the child safety seat in a seat with a combination lap and shoulder belt.

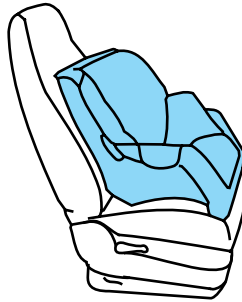

2. Pull down on the shoulder belt and then grasp the shoulder belt and lap belt together.

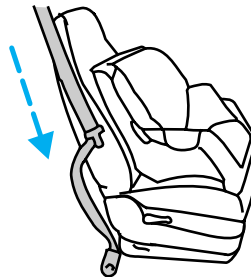

Seating and Safety Restraints

3. While holding the shoulder and lap belt portions together, route the tongue through the child seat according to the child seat manufacturer's instructions. Be sure the belt webbing is not twisted.

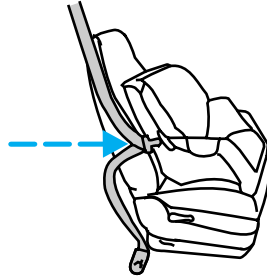

4. Insert the belt tongue into the proper buckle (the buckle closest to the direction the tongue is coming from) for that seating position until you hear a snap and feel the latch engage. Make sure the tongue is latched securely by pulling on it.

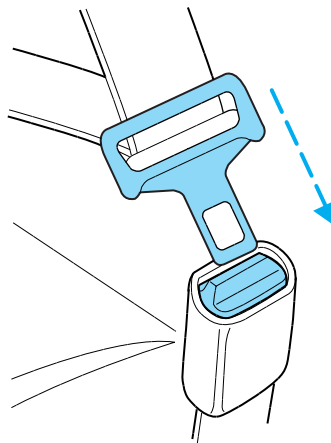

5. To put the retractor in the automatic locking mode, grasp the shoulder portion of the belt and pull downward until all of the belt is pulled out and a click is heard.

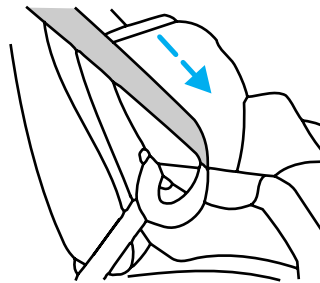

6. Allow the belt to retract. The belt will click as it retracts to indicate it is in the automatic locking mode.

Seating and Safety Restraints

7. Pull the lap belt portion across the child seat toward the buckle and pull up on the shoulder belt while pushing down with your knee on the child seat.

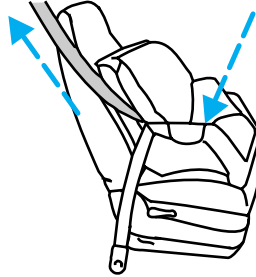

8. Allow the safety belt to retract to remove any slack in the belt.

9. Before placing the child in the seat, forcibly move the seat forward and back to make sure the seat is securely held in place. To check this, grab the seat at the belt path and attempt to move it side to side and forward. There should be no more than one inch of movement for proper installation.

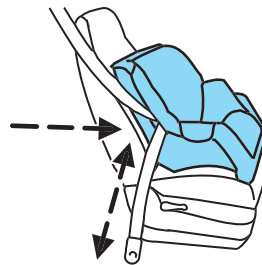

10. Try to pull the belt out of the retractor to make sure the retractor is in the automatic locking mode (you should not be able to pull more belt out). If the retractor is not locked, unbuckle the belt and repeat steps two through nine.

Check to make sure the child seat is properly secured before each use.

Attaching child safety seats with tether straps

Most new forward-facing child safety seats include a tether strap which goes over the back of the seat and hooks to an anchoring point. Tether straps are available as an accessory for many older safety seats. Contact the manufacturer of your child seat for information about ordering a tether strap.

The rear seats of your vehicle are equipped with built-in tether strap anchors located behind the seats as shown below.

The tether strap anchors in your vehicle are in the following positions (shown from top view):

210

Seating and Safety Restraints

- 40/20/40 second row seats

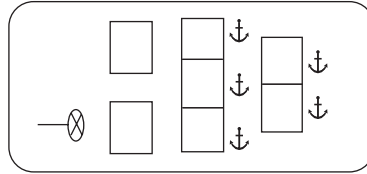

- second row bucket seats

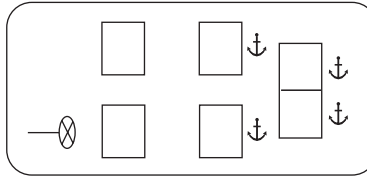

Attach the tether strap only to the appropriate tether anchor as shown. The tether strap may not work properly if attached somewhere other than the correct tether anchor.

1. Position the child safety seat on the rear seat cushion.
2. Route the tether strap under the head restraint and between the head restraint posts.
3. Locate the correct anchor for the selected rear seating position.

- Behind 2nd row seat

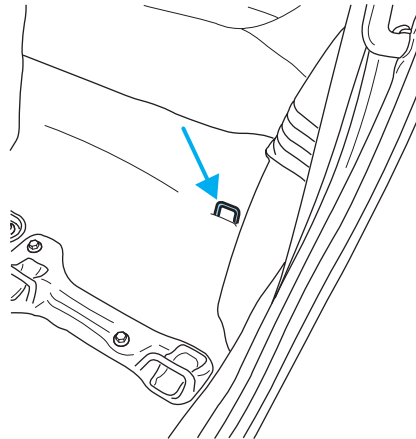

Seating and Safety Restraints

- At the rear of the cargo area

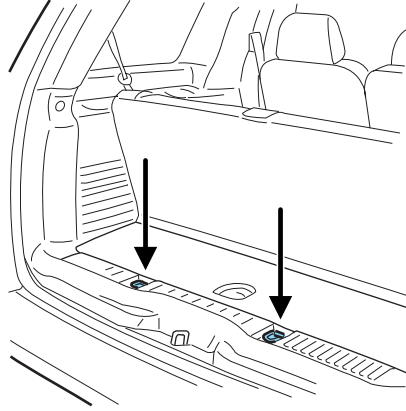

4. Clip the tether strap to the anchor.

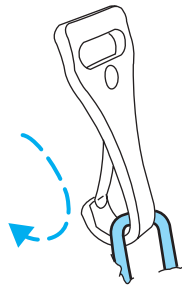

If the tether strap is clipped incorrectly, the child safety seat may not be retained properly in the event of a collision.

5. Refer to the *Installing child safety seats in combination lap and shoulder belt seating positions* section of this chapter for further instructions to secure the child safety seat.

6. Tighten the child safety seat tether strap according to the manufacturer's instructions.



If the safety seat is not anchored properly, the risk of a child being injured in a collision greatly increases.

Seating and Safety Restraints

Attaching safety seats with LATCH (Lower Anchors and Tethers for Children) attachments for child seat anchors

Some child safety seats have two rigid or webbing mounted attachments that connect to two anchors at certain seating positions in your vehicle. This type of child seat eliminates the need to use seat belts to attach the child seat. For forward-facing child seats, the tether strap must also be attached to the proper tether anchor. See *Attaching safety seats with tether straps* in this chapter.

Your vehicle has LATCH anchors for child seat installation at the seating positions marked with the child seat symbol:

- Second row bucket seats

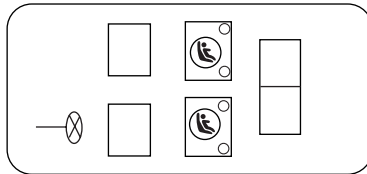

- 40/20/40 second row seats

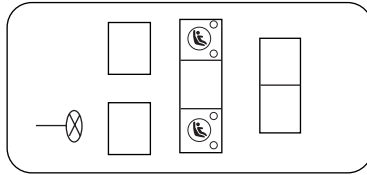

Never attach two LATCH child safety seats to the same anchor. In a crash, one anchor may not be strong enough to hold two child safety seat attachments and may break, causing serious injury or death.

Seating and Safety Restraints

The lower anchors for child seat installation are located at the rear section of the second row seat between the cushion and seat back. The LATCH anchors are below the locator symbols on the seat back.

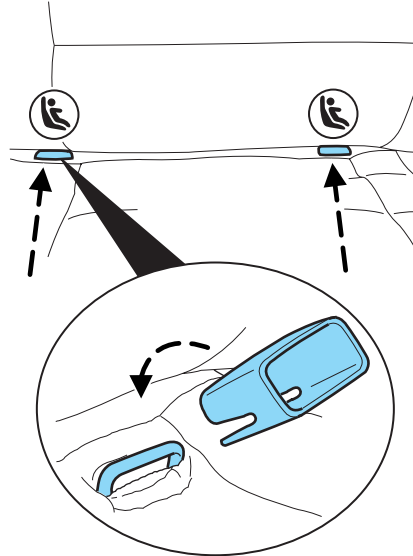

Follow the child seat manufacturer's instructions to properly install a child seat with LATCH attachments. Two plastic LATCH guides may be obtained at no charge from any Ford or Lincoln Mercury dealer. They snap onto the latch lower anchor in the vehicle to help attach a child seat with rigid latch attachments. It will hold the seat foam away and expose the anchor making attachment of the child seat easier.



Attach LATCH lower attachments of the child seat only to the anchors shown.

If you install a child seat with rigid LATCH attachments, do not tighten the tether strap enough to lift the child seat off the vehicle seat cushion when the child is seated in it. Keep the tether strap just snug without lifting the front of the child seat. Keeping the child seat just touching the vehicle seat gives the best protection in a severe crash.

Each time you use the safety seat, check that the seat is properly attached to the lower anchors and tether anchor. Try to tilt the child seat from side to side. Also try to tug the seat forward. Check to see if the anchors hold the seat in place.



If the safety seat is not anchored properly, the risk of a child being injured in a crash greatly increases.

STARTING

Positions of the ignition

1. OFF/LOCK, shuts off the engine and all accessories/locks the steering wheel, gearshift lever and allows key removal.

2. ACC, allows the electrical accessories such as the radio to operate while the engine is not running. This position also unlocks the steering wheel.

3. ON, all electrical circuits operational. Warning lights illuminated. Key position when driving.

4. START, cranks the engine. Release the key as soon as the engine starts.

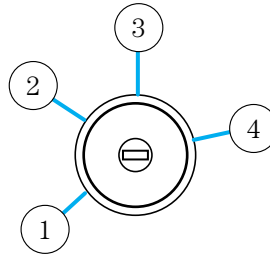

Preparing to start your vehicle

Engine starting is controlled by the powertrain control system. This system meets all Canadian Interference-Causing Equipment standard requirements regulating the impulse electrical field strength of radio noise.

When starting a fuel-injected engine, avoid pressing the accelerator before or during starting. Only use the accelerator when you have difficulty starting the engine. For more information on starting the vehicle, refer to *Starting the engine* in this chapter.



Extended idling at high engine speeds can produce very high temperatures in the engine and exhaust system, creating the risk of fire or other damage.



Do not park, idle, or drive your vehicle in dry grass or other dry ground cover. The emission system heats up the engine compartment and exhaust system, which can start a fire.



Do not start your vehicle in a closed garage or in other enclosed areas. Exhaust fumes can be toxic. Always open the garage door before you start the engine. See *Guarding against exhaust fumes* in this chapter for more instructions.

Driving



If you smell exhaust fumes inside your vehicle, have your dealer inspect your vehicle immediately. Do not drive if you smell exhaust fumes.

Important safety precautions

A computer system controls the engine's idle revolutions per minute (RPM). When the engine starts, the idle RPM runs higher than normal in order to warm the engine. If the engine idle speed does not slow down automatically, have the vehicle checked.

Before starting the vehicle:

1. Make sure all vehicle occupants have buckled their safety belts. For more information on safety belts and their proper usage, refer to the *Seating and safety restraints* chapter.
2. Make sure vehicle accessories are off.
 - Make sure the parking brake is set.

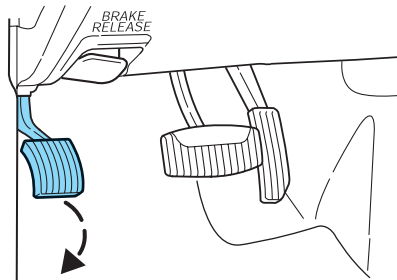

- Make sure the gearshift lever is in P (Park).

P RND321

Driving

3. Turn the key to 3 (ON) without turning the key to 4 (START).

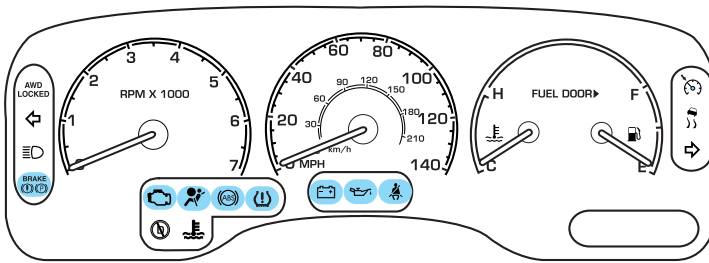
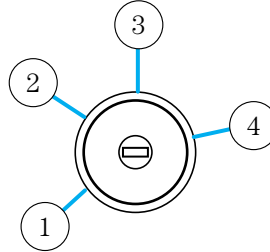

Make sure the corresponding lights illuminate or illuminate briefly. If a light fails to illuminate, have the vehicle serviced.

- If the driver's safety belt is fastened, the  light may not illuminate.

Starting the engine

Note: Whenever you start your vehicle, release the key as soon as the engine starts. Excessive cranking could damage the starter.

1. Turn the key to 4 (START) without pressing the accelerator pedal and release as soon as the engine starts. The key will return to 3 (ON).

2. If the temperature is above -12°C (10°F) and the engine does not start within five seconds on the first try, turn the key to OFF, wait 10 seconds and try again.

3. If the temperature is below -12°C (10°F) and the engine does not start in 15 seconds on the first try, turn the key OFF and wait 10 seconds and

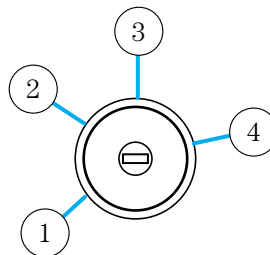

Driving

try again. If the engine does not start in two attempts, press the accelerator pedal all the way to floor and hold. Turn the key to START position.

4. When the engine starts, release the key, then release the accelerator pedal gradually as the engine speeds up.
5. After idling for a few seconds, apply the brake, shift into gear and drive.

Using the engine block heater (if equipped)

An engine block heater warms the engine coolant which aids in starting and heater/defroster performance. Use of an engine block heater is strongly recommended if you live in a region where temperatures reach -23° C (-10° F) or below. For best results, plug the heater in at least three hours before starting the vehicle. The heater can be plugged in the night before starting the vehicle.



To reduce the risk of electrical shock, do not use your heater with ungrounded electrical systems or two-pronged (cheater) adapters.

Guarding against exhaust fumes

Carbon monoxide is present in exhaust fumes. Take precautions to avoid its dangerous effects.



If you smell exhaust fumes inside your vehicle, have your dealer inspect your vehicle immediately. Do not drive if you smell exhaust fumes.

Important ventilating information

If the engine is idling while the vehicle is stopped for a long period of time, open the windows at least 2.5 cm (one inch) or adjust the heating or air conditioning to bring in fresh air.

BRAKES

Your service brakes are self-adjusting. Refer to the scheduled maintenance guide for scheduled maintenance.

Occasional brake noise is normal and often does not indicate a performance concern with the vehicle's brake system. In normal operation, automotive brake systems may emit occasional or intermittent

Driving

squeal or groan noises when the brakes are applied. Such noises are usually heard during the first few brake applications in the morning; however, they may be heard at any time while braking and can be aggravated by environmental conditions such as cold, heat, moisture, road dust, salt or mud. If a “metal-to-metal,” “continuous grinding” or “continuous squeal” sound is present while braking, the brake linings may be worn-out and should be inspected by a qualified service technician.



If you are driving down a long or steep hill, shift to a lower gear. Do not apply your brakes continuously, as they may overheat and become less effective.

Anti-lock brake system (ABS)

On ABS-equipped vehicles, a noise from the hydraulic pump motor and pulsation in the pedal may be observed during ABS braking events. Pedal pulsation coupled with noise while braking under panic conditions or on loose gravel, bumps, wet or snowy roads is normal and indicates proper functioning of the vehicle's anti-lock brake system. The ABS performs a self-check after you start the engine and begin to drive away. A brief mechanical noise may be heard during this test. This is normal. If a malfunction is found, the ABS warning light will come on. If the vehicle has continuous vibration or shudder in the steering wheel while braking, the vehicle should be inspected by a qualified service technician.

The ABS operates by detecting the onset of wheel lockup during brake applications and compensates for this tendency. The wheels are prevented from locking even when the brakes are firmly applied.

Using ABS

- In an emergency or when maximum efficiency from the four-wheel ABS is required, apply continuous force on the brake. The four wheel ABS will be activated immediately, thus allowing you to retain steering control of your vehicle and, providing there is sufficient space, will enable you to avoid obstacles and bring the vehicle to a controlled stop.
- The anti-lock system does not always reduce stopping distance. Always leave enough room between your vehicle and the vehicle in front of you to stop.
- We recommend that you familiarize yourself with this braking technique. However, avoid taking any unnecessary risks.

Driving

Brake Assist (if equipped)

The Brake Assist system provides full braking force during panic braking situations. It detects a rapid application of the brake pedal and maximizes the amount of brake booster assist, helping the driver to achieve maximum braking pressure. Once a panic brake application is detected, the system will remain activated as long as the brake pedal is depressed. The system is deactivated by releasing the brake pedal.

When the system activates, the brake pedal will travel with very little effort; this is normal.

ABS warning lamp (ABS)

The (ABS) warning lamp in the instrument cluster momentarily illuminates when the ignition is turned to the ON position. If the light does not illuminate momentarily at start up, remains on or continues to flash, the ABS needs to be serviced.

With the ABS light on, the anti-lock brake system is disabled and normal braking is still effective unless the brake warning light also remains illuminated with parking brake released. (If your brake warning lamp illuminates, have your vehicle serviced immediately.)



Parking brake (P)

Apply the parking brake whenever the vehicle is parked. To set the parking brake, press the parking brake pedal down until the pedal stops.

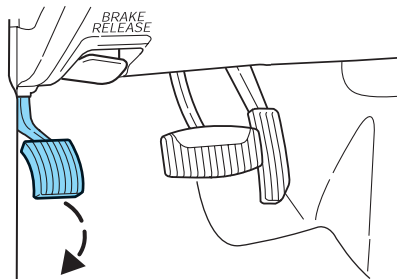

The BRAKE warning lamp in the instrument cluster illuminates and remains illuminated (when the ignition is turned ON) until the parking brake is released.



Driving



Always set the parking brake fully and make sure that the gearshift is securely latched in P (Park).

The parking brake is not recommended to stop a moving vehicle. However, if the normal brakes fail, the parking brake can be used to stop your vehicle in an emergency. Since the parking brake applies only the rear brakes, the vehicle's stopping distance will increase greatly and the handling of your vehicle will be adversely affected.

Pull the release lever to release the brake. Driving with the parking brake on will cause the brakes to wear out quickly and reduce fuel economy.

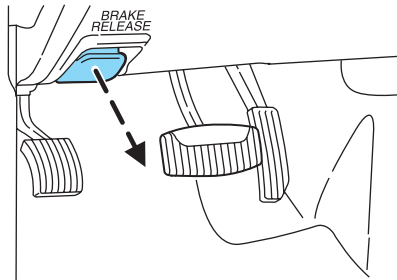

ADVANCETRAC™ STABILITY ENHANCEMENT SYSTEM (IF EQUIPPED)

The AdvanceTrac™ system provides a stability enhancement feature as well as a traction enhancement feature. It helps your vehicle maintain traction, when driving on slippery and/or hilly road surfaces, by detecting and controlling wheel spin. Excessive wheel spin is controlled by momentarily reducing engine power and rapidly applying the anti-lock brakes. The system is a driver aid which makes your vehicle easier to handle primarily on snow and ice-covered roads.

If your vehicle should become stuck in deep snow or mud, try switching the AdvanceTrac™ system off by pressing the AdvanceTrac™ button.

This will allow your tires to “dig” for traction. Pressing the control once will disable the AdvanceTrac™ stability enhancement and the engine power reduction portion of the traction enhancement feature; the brake portion of the traction enhancement feature will still function normally. Pressing and holding the control for more than five seconds will disable the AdvanceTrac™ stability enhancement and traction enhancement feature. If the AdvanceTrac™ system is activated excessively for an extended period of time, the brake portion of the system will shut down to allow the brakes to cool down.

Driving

A limited AdvanceTrac™ function using only engine power reduction will still help control the wheels from over-spinning. When the brakes have cooled down, the system will again function normally. Anti-lock braking is not affected by this condition and will function normally during the cool-down period.

AdvanceTrac™ enhances your vehicle's stability during maneuvers that require all available tire traction, like in wet/snowy/icy road conditions and/or when performing emergency maneuvers. In an emergency lane-change, the driver will experience better overall vehicle traction, and have better control of the vehicle.

The AdvanceTrac™ system helps the driver maintain steering control if the vehicle begins to slide excessively left or right or spin out.

AdvanceTrac™ will attempt to correct the sliding motion by applying brake force at individual tires and, if necessary, by reducing engine power.

Driving conditions which may activate AdvanceTrac™ include:

- Taking a turn too fast
- Maneuvering quickly to avoid an accident, pedestrian or obstacle
- Hitting a patch of ice
- Changing lanes on a snow-rutted road
- Entering a snow-free road from a snow-covered side street, or vice versa
- Entering a paved road from a gravel road, or vice versa
- Hitting a curb while turning
- Driving on slick surfaces
- Cornering while towing a heavily loaded trailer (refer to *Trailer Towing* in this chapter)

The AdvanceTrac™ system automatically turns on when the engine is started. However, the system does not function when the vehicle is traveling in R (Reverse), ABS and the traction enhancement feature will continue to function.

The AdvanceTrac™ button allows the driver to control the availability of the AdvanceTrac™ system.

AdvanceTrac™ system status is indicated by a warning indicator

light with a “sliding car” icon in the instrument cluster that will flash



Driving

when the system is active and an indicator light in the control button that will illuminate when the system is turned off. In vehicles with a message center, the message “ADVANCETRAC OFF” will be displayed.

If a failure is detected in the AdvanceTrac[™] system, the warning indicator light in the instrument cluster will stay on. If the warning indicator light in the instrument cluster remains on while the engine is running, have the system serviced immediately.

Some drivers may notice a slight movement of the brake pedal when the AdvanceTrac[™] performs a system self-check. During AdvanceTrac[™] operation you may experience the following:

- A rumble or grinding noise
- A slight deceleration of the vehicle
- The AdvanceTrac[™] indicator light will flash
- If your foot is on the brake pedal, you will feel a vibration in the pedal.
- If the driving condition is severe and your foot is not on the brake, the brake pedal will move to apply higher brake forces. You may also hear a whoosh of air from under the instrument panel during this severe condition.

All these conditions are normal during AdvanceTrac[™] operation.

Do not alter or modify your vehicle’s suspension or steering; the resulting changes to the vehicle’s handling can adversely affect the AdvanceTrac[™] system. Also, do not install a stereo loudspeaker near the rear console or either rear seat. The speaker vibrations can adversely affect the AdvanceTrac[™] sensors located in this area.



Aggressive driving in any road conditions can cause you to lose control of your vehicle increasing the risk of severe personal injury or property damage. The occurrence of a Traction Control[™] event is an indication that at least some of the tires have exceeded their ability to grip the road; this may lead to an increased risk of loss of vehicle control, vehicle rollover, personal injury and death. If you experience a severe road event, SLOW DOWN.

Driving

STEERING

Your vehicle is equipped with power steering. Power steering uses energy from the engine to decrease the driver's effort in steering the vehicle.

To prevent damage to the power steering pump:

- Never hold the steering wheel to the extreme right or the extreme left for more than a few seconds when the engine is running.
- Do not operate the vehicle with the power steering pump fluid level below the MIN mark on the reservoir.

If the power steering system breaks down (or if the engine is turned off), you can steer the vehicle manually, but it takes more effort.

If the steering wanders or pulls, check for:

- Underinflated tire(s) on any wheel(s)
- Uneven vehicle loading
- High crown in center of road
- High crosswinds
- Wheels out of alignment
- Loose or worn suspension components

PREPARING TO DRIVE YOUR VEHICLE



Utility vehicles have a significantly higher rollover rate than other types of vehicles.



In a rollover crash, an unbelted person is significantly more likely to die than a person wearing a seat belt.

Your vehicle has special design and equipment features to make it capable of performing in a wide variety of circumstances. These special design features, such as larger tires and increased ground clearance, give the vehicle a higher center of gravity than a passenger car.



Vehicles with a higher center of gravity such as utility and four-wheel drive vehicles handle differently than vehicles with a lower center of gravity. Utility and four-wheel drive vehicles are **not** designed for cornering at speeds as high as passenger cars any more than low-slung sports cars are designed to perform satisfactorily under off-road conditions. Avoid sharp turns, excessive speed and abrupt maneuvers in these vehicles. Failure to drive cautiously could result in an increased risk of loss of vehicle control, vehicle rollover, personal injury and death.

Driving

 Loaded vehicles, with a higher center of gravity, may handle differently than unloaded vehicles. Extra precautions, such as slower speeds and increased stopping distance, should be taken when driving a heavily loaded vehicle.

Your vehicle has the capability to haul more cargo and people than most passenger cars. Depending upon the type and placement of the load, hauling people and cargo may raise the center of gravity of the vehicle.

Use extra caution while becoming familiar with your vehicle. Know the capabilities and limitations of both you as a driver and your vehicle.

AUTOMATIC TRANSMISSION OPERATION

Brake-shift interlock

This vehicle is equipped with a brake-shift interlock feature that prevents the gearshift lever from being moved from P (Park) when the ignition is in the ON position unless brake pedal is depressed.

If you cannot move the gearshift lever out of P (Park) with ignition in the ON position and the brake pedal depressed:

1. Apply the parking brake, turn the ignition to LOCK, then remove the key.
2. Locate the access panel on the driver side of the floor console. Using a screwdriver (or equivalent), pry the access panel off the floor console.

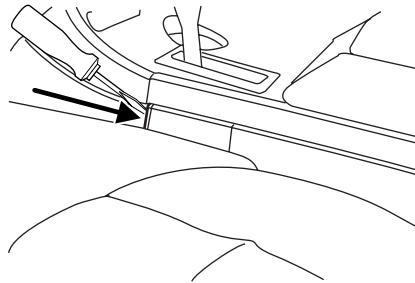

Driving

3. Using the screwdriver (or equivalent), push the white plastic override mechanism (located behind the bracket) toward the roof of the vehicle as shown in the illustration.

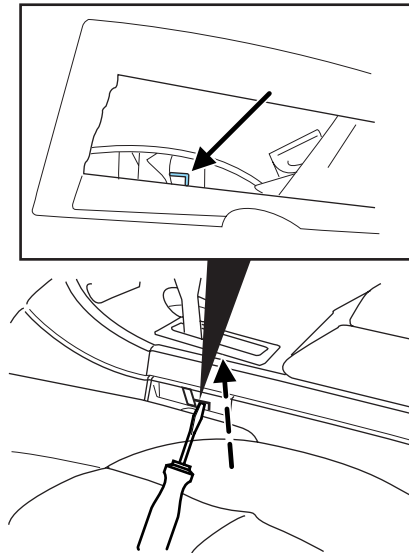

4. Move the gearshift lever back to N (Neutral) (two places from P [Park]).

5. Start the vehicle and release the parking brake.

If it is necessary to use the above procedure to move the gearshift lever, it is possible that a fuse has blown or the vehicle's brakelamps are not operating properly. Refer to *Fuses and relays* in the *Roadside emergencies* chapter.



Do not drive your vehicle until you verify that the brakelamps are working.



Always set the parking brake fully and make sure the gearshift is latched in P (Park). Turn the ignition to the LOCK position and remove the key whenever you leave your vehicle.



If the parking brake is fully released, but the brake warning lamp remains illuminated, the brakes may not be working properly. See your dealer or a qualified service technician.

Driving with a 5-speed automatic transmission

Your transmission is equipped with an adaptive learning strategy found in the vehicle computer. This feature is designed to increase durability, and provide consistent shift feel over the life of the vehicle. A new vehicle or transmission may have firm and/or soft shifts. This operation is considered normal and will not affect function or durability of the transmission. Over time, the adaptive learning process will fully update transmission operation. Additionally, whenever the battery is disconnected or a new battery is installed, the strategy must relearn.

Understanding gearshift positions

 Hold the brake pedal down while you move the gearshift lever from P (Park) to another position. If you do not hold the brake pedal down, your vehicle may move unexpectedly and injure someone.

P (Park)

This position locks the transmission and prevents the rear wheels from turning.

To put your vehicle in gear:

- Start the engine
- Depress the brake pedal
- Move the gearshift lever into the desired gear



To put your vehicle in P (Park):

- Come to a complete stop
- Move the gearshift lever and securely latch it in P (Park)

 Always set the parking brake fully and make sure the gearshift is latched in P (Park). Turn the ignition to the LOCK position and remove the key whenever you leave your vehicle.

Driving

R (Reverse)

With the gearshift lever in R (Reverse), the vehicle will move backward. Always come to a complete stop before shifting into and out of R (Reverse).

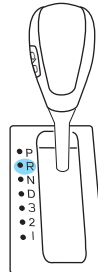

N (Neutral)

With the gearshift lever in N (Neutral), the vehicle can be started and is free to roll. Hold the brake pedal down while in this position.



D (Overdrive)

The normal driving position for the best fuel economy. Transmission operates in gears one through five.

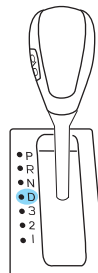

D (Overdrive) can be deactivated by pressing the transmission control switch on the side of the gearshift lever.

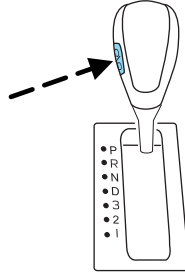

This will illuminate the O/D OFF lamp and activate Drive.



Drive (not shown)

Drive is activated when the transmission control switch is pressed.

- This position allows for all forward gears except overdrive.
- O/D OFF lamp is illuminated.
- Provides engine braking.
- Use when driving conditions cause excessive shifting from O/D to other gears. Examples: city traffic, hilly terrain, heavy loads, trailer towing and when engine braking is required.
- To return to O/D (overdrive mode), press the transmission control switch. The O/D OFF lamp will not be illuminated.
- O/D (Overdrive) is automatically returned each time the key is turned off.

3 (Third)

Transmission only operates in third gear only. Use for improved traction on slippery roads. Selecting 3 (Third) provides engine braking.

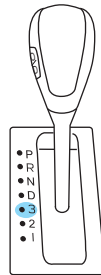

Driving

2 (Second)

Use 2 (Second) to start-up on slippery roads or to provide additional engine braking on downgrades.

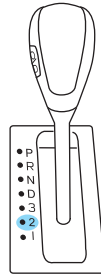

1 (First)

- Provides maximum engine braking.
- Allows upshifts by moving gearshift lever.
- Will not downshift into 1 (First) at high speeds; allows for 1 (First) when vehicle reaches slower speeds.

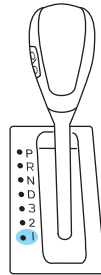

Forced downshifts

- Allowed in D (Overdrive) or Drive.
- Depress the accelerator to the floor.
- Allows transmission to select an appropriate gear.

REAR PARK ASSIST

The Rear Park Assist sounds a tone to warn the driver of obstacles near the rear bumper when the R (Reverse) is selected and the vehicle is moving at speeds less than 5 km/h (3 mph). The system is not effective at speeds above 5 km/h (3 mph) and may not detect certain angular or moving objects.



To help avoid personal injury, please read and understand the limitations of the Rear Park Assist system as contained in this section. The Rear Park Assist is only an aid for some (generally large and fixed) objects when moving in reverse on a flat surface at “parking speeds”. Inclement weather may also affect the function of the system; this may include reduced performance or a false activation.

Driving



To help avoid personal injury, always use caution when in reverse and when using the system.



This system is not designed to prevent contact with small or moving objects. The system is designed to provide a warning to assist the driver in detecting large stationary objects to avoid damaging the vehicle. The system may not detect smaller objects, particularly those close to the ground.

The system detects obstacles up to 2 meters (6 ft.) from the rear bumper with a decreased coverage area at the outer corners of the bumper, (refer to the figures for approximate zone coverage areas). As you move closer to the obstacle, the rate of the tone increases. When the obstacle is less than 25.0 cm (10 in.) away, the tone will sound continuously. If the system detects a stationary or receding object further than 25.0 cm (10 in.) from the side of the vehicle, the tone will sound for only three seconds. Once the system detects an object approaching, the tone will sound again. If the Rear Park Assist detects an object and the radio is on, the radio volume will decrease while the tone sounds. When the tone stops sounding, or if the vehicle is shifted out of R (Reverse), the radio will go back to the previously set volume level.

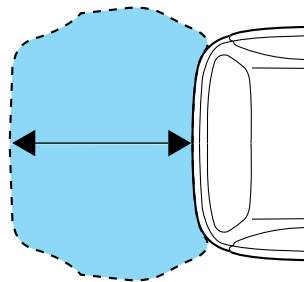
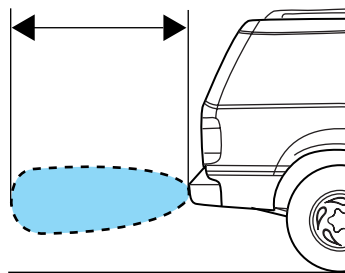

The system automatically turns on when the gear selector is placed in R (Reverse) and the ignition is ON. A control in the message center allows the driver to disable the system only when the ignition is ON, and the gear selector is in R (Reverse). Refer to *Message center* in the *Driver Controls* chapter for more information.

Keep the Rear Park Assist sensors (located on the rear bumper/fascia) free from snow, ice and large accumulations of

Driving

dirt (do not clean the sensors with sharp objects). If the sensors are covered, it will affect the accuracy of the system.

If your vehicle sustains damage to the rear bumper/fascia, leaving it misaligned or bent, the sensing zone may be altered causing inaccurate measurement of obstacles or false alarms.

ALL WHEEL DRIVE (AWD) SYSTEM (IF EQUIPPED)

Your vehicle may be equipped with an All Wheel Drive (AWD) transfer case. With the AWD option, power is supplied to all four wheels automatically with no need to shift between two-wheel drive and four-wheel drive. If your vehicle is equipped with the AdvanceTrac[™] stability enhancement feature, you can change AWD modes, if desired, by selecting AWD options through the message center.

For the lubricant specification and refill capacity of the AWD transfer case refer to *Maintenance and specifications* chapter.



If your vehicle is equipped with AWD, a spare tire of a different size than the road tires should never be used. Such a tire could make the vehicle difficult to control as well as result in damage to driveline components.



Utility and four-wheel drive vehicles are **not** designed for cornering at speeds as high as passenger cars any more than low-slung sports cars are designed to perform satisfactorily under off-road conditions. Avoid sharp turns or abrupt maneuvers in these vehicles.

The following sections, *Normal operation*, *Autolock operation* and *Disabling AWD*, apply only to vehicles which allow the driver to change AWD modes through the message center.

Normal operation (vehicles equipped with AdvanceTrac[™] only)

During normal operation:

- the AWD system is in AWD AUTO mode (AWD LOCKED will illuminate in the message center for four seconds when you first start your vehicle). The AWD LOCKED indicator in the instrument cluster will also come on.
- AWD AUTO mode can be overridden by pressing SETUP in the message center. When you first press SETUP, AWD <AUTO> will be displayed, then if you press RESET within four seconds of pressing

Driving

SETUP, AWD <LOCKED> will be displayed. AWD <LOCKED> provides power to all four wheels constantly which allows you to operate your vehicle in severe winter or off-road conditions such as deep snow, ice or shallow sand. It is not recommended that you use AWD <LOCKED> on dry pavement.

- AWD <LOCKED> can be cancelled by pressing RESET in the message center. (The AWD LOCKED display in the message center will then turn off and the display will return to AWD <AUTO> for four seconds when the shift is complete.)

Autolock operation (vehicles equipped with AdvanceTrac™ only)

If the AWD system begins to overheat, the system will place itself in the Autolock mode:

- the AWD LOCKED indicator light will illuminate in the instrument cluster and AWD DISABLED <LOCKED> will be displayed in the message center.
- AWD LOCKED will be displayed in the message center for four seconds and a warning chime will sound. This condition may clear without any action being taken by the driver.
- the AWD LOCKED indicator light in the instrument cluster will turn off when the AWD system cools down.
- When the system is sufficiently cooled down, AWD AUTO RESTORED will appear in the message center for four seconds and a warning chime will sound.

Disabling AWD (vehicles equipped with AdvanceTrac™ only)

When a problem is detected in the AWD system:

- the AWD LOCKED indicator light in the instrument cluster will flash eight times every two minutes in the message center.
- The message center will then display AWD DISABLED for four seconds, then SEE OWNER'S MANUAL. A warning chime will also sound. The warning displays and chime will continue until RESET is pressed (which will clear the message from the display).
- AWD LOCKED can still be engaged by pressing SETUP (the message center will display AWD <DISABLED> LOCKED), then pressing RESET. The AWD LOCKED indicator light will illuminate in the instrument cluster and the message center will display AWD DISABLED <LOCKED>.

Driving

- To disable AWD, press RESET. The system will go back to AWD AUTO mode momentarily, then the AWD LOCKED indicator light will flash in the instrument cluster eight times every two minutes. The display will then show AWD <DISABLED> LOCKED for four seconds and then turn off.
- If a serious problem occurs with the AWD system, the AWD LOCKED indicator light in the instrument cluster will flash 10 times every two minutes. The message center will also display CHECK AWD and a warning chime will sound. You can press SETUP to check the status of the AWD system (which will display AWD <DISABLED> LOCKED), but the AWD system will be disabled until the system is serviced.

Driving off-road with truck and utility vehicles

AWD vehicles are specially equipped for driving on sand, snow, mud and rough terrain and have operating characteristics that are somewhat different from conventional vehicles, both on and off the road.

When driving at slow speeds off-road under high outside temperatures, use 1 (First) gear when possible. 1 (First) gear operation will maximize the engine and transmission cooling capability.

Under severe operating conditions, the A/C may cycle on and off to protect overheating of the engine.

How your vehicle differs from other vehicles

Truck and utility vehicles can differ from some other vehicles. Your vehicle may be higher to allow it to travel over rough terrain without getting hung up or damaging underbody components.

The differences that make your vehicle so versatile also make it handle differently than an ordinary passenger car.

Maintain steering wheel control at all times, especially in rough terrain. Since sudden changes in terrain can result in abrupt steering wheel motion, make sure you grip the steering wheel from the outside. Do not grip the spokes.

Drive cautiously to avoid vehicle damage from concealed objects such as rocks and stumps.

You should either know the terrain or examine maps of the area before driving. Map out your route before driving in the area. To maintain steering and braking control of your vehicle, you must have all four wheels on the ground and they must be rolling, not sliding or spinning.

Basic operating principles

- Drive slower in strong crosswinds which can affect the normal steering characteristics of your vehicle.
- Be extremely careful when driving on pavement made slippery by loose sand, water, gravel, snow or ice.

If your vehicle goes off the edge of the pavement

- If your vehicle goes off the edge of the pavement, slow down, but avoid severe brake application, ease the vehicle back onto the pavement only after reducing your speed. Do not turn the steering wheel too sharply while returning to the road surface.
- It may be safer to stay on the apron or shoulder of the road and slow down gradually before returning to the pavement. You may lose control if you do not slow down or if you turn the steering wheel too sharply or abruptly.
- It often may be less risky to strike small objects, such as highway reflectors, with minor damage to your vehicle rather than attempt a sudden return to the pavement which could cause the vehicle to slide sideways out of control or rollover. Remember, your safety and the safety of others should be your primary concern.



Vehicles with a higher center of gravity such as utility and four-wheel drive vehicles handle differently than vehicles with a lower center of gravity. Utility and four-wheel drive vehicles are **not** designed for cornering at speeds as high as passenger cars any more than low-slung sports cars are designed to perform satisfactorily under off-road conditions. Avoid sharp turns, excessive speed and abrupt maneuvers in these vehicles. Failure to drive cautiously could result in an increased risk of loss of vehicle control, vehicle rollover, personal injury and death.

If your vehicle gets stuck

If your vehicle gets stuck in mud or snow it may be rocked out by shifting between forward and reverse gears, stopping between shifts, in a steady pattern. Press lightly on the accelerator in each gear.

Do not rock the vehicle if the engine is not at normal operating temperature or damage to the transmission may occur.

Do not rock the vehicle for more than a few minutes or damage to the transmission and tires may occur or the engine may overheat.

Driving

 Always set the parking brake fully and make sure the gearshift is latched in P (Park). Turn the ignition to the LOCK position and remove the key whenever you leave your vehicle.

 If the parking brake is fully released, but the brake warning lamp remains illuminated, the brakes may not be working properly. See your dealer or a qualified service technician.

 Do not spin the wheels at over 56 km/h (35 mph). The tires may fail and injure a passenger or bystander.

Emergency maneuvers

- In an unavoidable emergency situation where a sudden sharp turn must be made, remember to avoid “over-driving” your vehicle (i.e., turn the steering wheel only as rapidly and as far as required to avoid the emergency). Excessive steering will result in less vehicle control, not more. Additionally, smooth variations of the accelerator and/or brake pedal pressure should be utilized if changes in vehicle speed are called for. Avoid abrupt steering, acceleration or braking which could result in an increased risk of loss of vehicle control, vehicle rollover and/or personal injury. Use all available road surface to return the vehicle to a safe direction of travel.
- In the event of an emergency stop, avoid skidding the tires and do not attempt any sharp steering wheel movements.

 Vehicles with a higher center of gravity such as utility and four-wheel drive vehicles handle differently than vehicles with a lower center of gravity. Utility and four-wheel drive vehicles are **not** designed for cornering at speeds as high as passenger cars any more than low-slung sports cars are designed to perform satisfactorily under off-road conditions. Avoid sharp turns, excessive speed and abrupt maneuvers in these vehicles. Failure to drive cautiously could result in an increased risk of loss of vehicle control, vehicle rollover, personal injury and death.

- If the vehicle goes from one type of surface to another (i.e., from concrete to gravel) there will be a change in the way the vehicle responds to a maneuver (steering, acceleration or braking). Again, avoid these abrupt inputs.

AWD Systems (if equipped)

AWD uses all four wheels to power the vehicle. This increases traction, enabling you to drive over terrain and road conditions that a conventional two-wheel drive vehicle cannot.

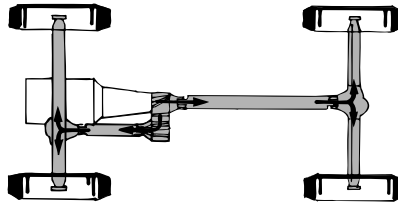

Sand

When driving over sand, try to keep all four wheels on the most solid area of the trail. Avoid reducing the tire pressures but shift to a lower gear and drive steadily through the terrain. Apply the accelerator slowly and avoid spinning the wheels.

If you must reduce the tire pressure for whatever reason in sand, make sure you re-inflate the tires as soon as possible.

Avoid excessive speed because vehicle momentum can work against you and cause the vehicle to become stuck to the point that assistance may be required from another vehicle. Remember, you may be able to back out the way you came if you proceed with caution.

Mud and water

If you must drive through high water, drive slowly. Traction or brake capability may be limited.

When driving through water, determine the depth; avoid water higher than the bottom of the hubs (if possible) and proceed slowly. If the ignition system gets wet, the vehicle may stall.

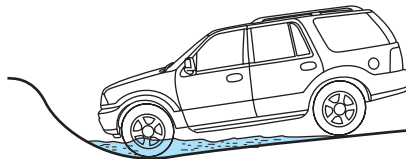

Once through water, always try the brakes. Wet brakes do not stop the vehicle as effectively as dry brakes. Drying can be improved by moving your vehicle slowly while applying light pressure on the brake pedal.

Be cautious of sudden changes in vehicle speed or direction when you are driving in mud. Even AWD vehicles can lose traction in slick mud. As when you are driving over sand, apply the accelerator slowly and avoid spinning your wheels. If the vehicle does slide, steer in the direction of the slide until you regain control of the vehicle.

Driving

If the transmission, transfer case or front axle are submerged in water, their fluids should be checked and changed, if necessary.

Driving through deep water may damage the transmission.

If the front or rear axle is submerged in water, the axle lubricant should be replaced.

After driving through mud, clean off residue stuck to rotating driveshafts and tires. Excess mud stuck on tires and rotating driveshafts causes an imbalance that could damage drive components.

“Tread Lightly” is an educational program designed to increase public awareness of land-use regulations and responsibilities in our nation's wilderness areas. Ford Motor



Company joins the U.S. Forest Service and the Bureau of Land Management in encouraging you to help preserve our national forest and other public and private lands by “treading lightly.”

Driving on hilly or sloping terrain

Although natural obstacles may make it necessary to travel diagonally up or down a hill or steep incline, you should always try to drive straight up or straight down. **Avoid driving crosswise or turning on steep slopes or hills.** A danger lies in losing traction, slipping sideways and possibly rolling over. Whenever driving on a hill, determine beforehand the route you will use. Do not drive over the crest of a hill without seeing what conditions are on the other side. Do not drive in reverse over a hill without the aid of an observer.

When climbing a steep slope or hill, start in a lower gear rather than downshifting to a lower gear from a higher gear once the ascent has started. This reduces strain on the engine and the possibility of stalling.

If you do stall out, Do not try to turnaround because you might roll over. It is better to back down to a safe location.

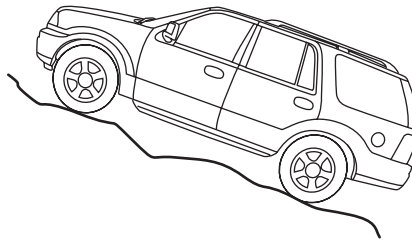

Apply just enough power to the wheels to climb the hill. Too much power will cause the tires to slip, spin or lose traction, resulting in loss of vehicle control.

Descend a hill in the same gear you would use to climb up the hill to avoid excessive brake application and brake overheating. Do not descend in neutral; instead, disengage overdrive or manually shift to a lower gear. When descending a steep hill, avoid sudden hard braking as you could lose control. When you brake hard, the front wheels can't turn and if they aren't turning, you won't be able to steer. The front wheels have to be turning in order to steer the vehicle.

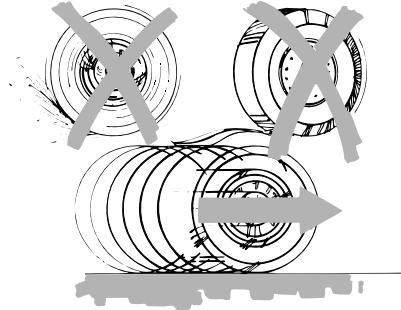

If your vehicle has anti-lock brakes, apply the brakes steadily. Do not “pump” the brakes.

Driving on snow and ice

AWD vehicles have advantages over 2WD vehicles in snow and ice but can skid like any other vehicle.

Should you start to slide while driving on snowy or icy roads, turn the steering wheel in the direction of the slide until you regain control.

Avoid sudden applications of power and quick changes of direction on snow and ice. Apply the accelerator slowly and steadily when starting from a full stop.

Avoid sudden braking as well. Although an AWD vehicle may accelerate better than a two-wheel drive vehicle in snow and ice, it won't stop any faster, because as in other vehicles, braking occurs at all four wheels. Do not become overconfident as to road conditions.

Make sure you allow sufficient distance between you and other vehicles for stopping. Drive slower than usual and consider using one of the lower gears. In emergency stopping situations, apply the brake steadily. Since your vehicle is equipped with a four wheel anti-lock brake system (ABS), do not “pump” the brakes. Refer to the *Brakes* section of this chapter for additional information on the operation of the anti-lock brake system.

Never drive with chains on the front tires of AWD vehicles without also putting them on the rear tires. This could cause the rear to slide and swing around during braking.

Driving

Tires, Replacement Requirements



Do not use a size and type of tire and wheel other than that originally provided by Ford Motor Company because it can affect the safety and performance of your vehicle, which could result in an increased risk of loss of vehicle control, vehicle rollover, and/or serious personal injury or death.

AWD vehicles are equipped with tires designed to provide for safe ride and handling capability.

Do not use a size and type of tire and wheel other than that originally provided by Ford Motor Company because it can affect the safety and performance of your vehicle, which could lead to loss of vehicle control or rollover and serious injury. Make sure all tires and wheels on the vehicle are of the same size, type, tread design, brand and load-carrying capacity. If you have questions regarding tire replacement, see an authorized Ford or Lincoln Mercury dealer.

If you nevertheless decide to equip your AWD for off-road use with tires larger than what Ford Motor Company recommends, you should not use these tires for highway driving.

If you use any tire/wheel combination not recommended by Ford Motor Company, it may adversely affect vehicle handling and could cause steering, suspension, axle or transfer case failure as well as the increased risk of loss of vehicle control.

Do not use “aftermarket lift kits” or other suspension modifications, whether or not they are used with larger tires and wheels.

These “aftermarket lift kits” could adversely affect the vehicle’s handling characteristics, which could lead to loss of vehicle control or rollover and serious injury.

Tires can be damaged during off-road use. For your safety, tires that are damaged should not be used for highway driving because they are more likely to blow out or fail.

You should carefully observe the recommended tire inflation pressure found on the safety compliance certification label attached to the left front door lock facing or door latch post pillar. Failure to follow tire pressure recommendations can adversely affect the way your vehicle handles. Do not exceed the Ford Motor Company recommended pressure even if it is less than the maximum pressure allowed for the tire.

Driving

Each day before you drive, check your tires. If one looks lower than the others, use a tire gauge to check pressure of all tires, and adjust if required. Check tire pressure with a tire gauge every few weeks (including spare). Safe operation requires tires that are neither underinflated nor a vehicle which is overloaded.

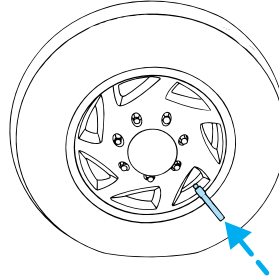

Periodically inspect the tire treads and remove stones, nails, glass or other objects that may be wedged in the tread grooves. Check for holes or cuts that may permit air leakage from the tire and make necessary repairs.

Inspect the tire side walls for cuts, bruises and other damage. If internal damage to the tire is suspected, have the tire demounted and inspected in case it needs to be repaired or replaced.

Maintenance and Modifications

The suspension and steering systems on your vehicle have been designed and tested to provide predictable performance whether loaded or empty and durable load carrying capability. For this reason, Ford Motor Company strongly recommends that you do not make modifications such as adding or removing parts (such as lift kits or stabilizer bars) or by using replacement parts not equivalent to the original factory equipment.

Any modifications to a vehicle that raise the center of gravity can make it more likely the vehicle will rollover as a result of a loss of control. Ford Motor Company recommends that caution be used with any vehicle equipped with a high load or device (such as ladder racks or pickup box cover).

Failure to maintain your vehicle properly may void the warranty, increase your repair cost, reduce vehicle performance and operational capabilities and adversely affect driver and passenger safety. Frequent inspection of vehicle chassis components is recommended if the vehicle is subjected to heavy off-road usage.

DRIVING THROUGH WATER

Do not drive quickly through standing water, especially if the depth is unknown. Traction or brake capability may be limited and if the ignition system gets wet, your engine may stall. Water may also enter your engine's air intake and severely damage your engine.

Driving

If driving through deep or standing water is unavoidable, proceed very slowly. Never drive through water that is higher than the bottom of the hubs (for trucks) or the bottom of the wheel rims (for cars).

Once through the water, always try the brakes. Wet brakes do not stop the vehicle as effectively as dry brakes. Drying can be improved by moving your vehicle slowly while applying light pressure on the brake pedal.

Driving through deep water where the transmission vent tube is submerged may allow water into the transmission and cause internal transmission damage. Have the fluid checked and, if water is found, replace the fluid.

VEHICLE LOADING

Before loading a vehicle, familiarize yourself with the following terms:

- **Base Curb Weight:** Weight of the vehicle including any standard equipment, fluids, lubricants, etc. It does not include occupants or aftermarket equipment.
- **Payload:** Combined maximum allowable weight of cargo, occupants and optional equipment. The payload equals the gross vehicle weight rating minus the weight of your vehicle.
- **GVW (Gross Vehicle Weight):** Base curb weight plus payload weight. The GVW is not a limit or a specification.
- **GVWR (Gross Vehicle Weight Rating):** Maximum permissible total weight of the base vehicle, occupants, optional equipment and cargo. The GVWR is specific to each vehicle and is listed on the Safety Certification Label on the driver's door pillar.
- **GAWR (Gross Axle Weight Rating):** Carrying capacity for each axle system. The GAWR is specific to each vehicle and is listed on the Safety Certification Label on the driver's door pillar.
- **GCW (Gross Combined Weight):** The combined weight of the towing vehicle (including occupants and cargo) and the loaded trailer.
- **GCWR (Gross Combined Weight Rating):** Maximum permissible combined weight of towing vehicle (including occupants and cargo) and the loaded trailer.
- **Maximum Trailer Weight Rating:** Maximum weight of a trailer the vehicle is permitted to tow. The maximum trailer weight rating is determined by subtracting the vehicle curb weight for each engine/transmission combination, any required option weight for trailer towing and the weight of the driver from the GCWR for the towing vehicle.

Driving

- **Maximum Trailer Weight:** Maximum weight of a trailer the loaded vehicle (including occupants and cargo) is permitted to tow. It is determined by subtracting the weight of the loaded trailer towing vehicle from the GCWR for the towing vehicle.
- **Trailer Weight Range:** Specified weight range that the trailer must fall within that ranges from zero to the maximum trailer weight rating.

Remember to figure in the tongue load of your loaded trailer when figuring the total weight.



Do not exceed the GVWR or the GAWR specified on the certification label.

Do not use replacement tires with lower load carrying capacities than the originals because they may lower the vehicle's GVWR and GAWR limitations. Replacement tires with a higher limit than the originals do not increase the GVWR and GAWR limitations.

The Safety Certification Label, found on the driver's door pillar, lists several important vehicle weight rating limitations. Before adding any additional equipment, refer to these limitations. If you are adding weight to the front of your vehicle, (potentially including weight added to the cab), the weight added should not exceed the front gross axle weight rating (FGAWR). Additional frontal weight may be added to the front axle reserve capacity provided you limit your payload in other ways (i.e. restrict the number of occupants or amount of cargo carried).

Always ensure that the weight of occupants, cargo and equipment being carried is within the weight limitations that have been established for your vehicle including both gross vehicle weight and front and rear gross axle weight rating limits. Under no circumstance should these limitations be exceeded.



Exceeding any vehicle weight rating limitation could result in serious damage to the vehicle loss of vehicle control, vehicle rollover, and/or personal injury.

Special loading instructions for owners of pickup trucks and utility-type vehicles



For important information regarding safe operation of this type of vehicle, see the *Preparing to drive your vehicle* section in this chapter.

Driving



Loaded vehicles, with a higher center of gravity, may handle differently than unloaded vehicles. Extra precautions, such as slower speeds and increased stopping distance, should be taken when driving a heavily loaded vehicle.

Your vehicle has the capability to haul more cargo and people than most passenger cars. Depending upon the type and placement of the load, hauling cargo and people may raise the center of gravity of the vehicle.

Calculating the load your vehicle can carry/tow

1. Use the appropriate maximum gross combined weight rating (GCWR) chart (in the *Trailer Towing* section) to find the maximum GCWR for your type engine and rear axle ratio.
2. Weigh your vehicle as you customarily operate the vehicle without cargo. To obtain correct weights, try taking your vehicle to a shipping company or an inspection station for trucks.
3. Subtract your loaded vehicle weight from the maximum GCWR on the following charts. This is the maximum trailer weight your vehicle can tow and must fall below the maximum shown under maximum trailer weight on the chart.

TRAILER TOWING

Trailer towing with your vehicle may require the use of a trailer tow option package.

Trailer towing puts additional loads on your vehicle's engine, transmission, axle, brakes, tires, and suspension. For your safety and to maximize vehicle performance, be sure to use the proper equipment while towing.

When towing maximum loads under high outside temperatures and on steep grades, the A/C system may cycle on and off to protect the engine from overheating. This may result in a temporary increase of interior temperatures.

Follow these guidelines to ensure safe towing procedure:

- Stay within your vehicle's load limits.
- Thoroughly prepare your vehicle for towing. Refer to *Preparing to tow* in this chapter.
- Use extra caution when driving while trailer towing. Refer to *Driving while you tow* in this chapter.

Driving

- Service your vehicle more frequently if you tow a trailer. Refer to the severe duty schedule in the scheduled maintenance guide.
- Do not tow a trailer until your vehicle has been driven at least 800 km (500 miles).
- Refer to the instructions included with towing accessories for the proper installation and adjustment specifications.

Do not exceed the maximum loads listed on the Safety Compliance Certification label. For load specification terms found on the label, refer to *Vehicle loading* in this chapter. Remember to figure in the tongue load of your loaded vehicle when figuring the total weight.

4x2			
GCWR (Gross Combined Weight Rating)/Trailer Weight			
Engine	Rear axle ratio	Maximum GCWR-kg (lbs.)	Trailer weight range-kg (lbs.) (0-Maximum)
4.6L	3.55	5580 (12300)	0-3311 (0-7300)
Maximum frontal area of trailer is 3.72 square meters (40 square feet).			
Notes: For high altitude operation, reduce GCW by 2% per 300 meters (1000 ft) elevation. For definitions of terms used in this table and instructions on how to calculate your vehicle load, refer to <i>Vehicle loading</i> in this chapter. Maximum trailer weights shown. The combined weight of the completed towing vehicle and the loaded trailer must not exceed the GCWR.			
In ambient temperatures greater than 38°C (100°F), it is recommended that the maximum GCW be reduced to 5262 kg (11600 lbs). At these temperatures, vehicle speed should be kept below 97 km/h (60 mph) during highway operation. Extended operation above 4000 rpm should be avoided.			
Towing a trailer over 1588 kg (3500 lbs.) requires a weight distributing hitch.			

Driving

AWD w/automatic transmission			
GCWR (Gross Combined Weight Rating)/Trailer Weight			
Engine	Rear axle ratio	Maximum GCWR-kg (lbs.)	Trailer weight range-kg (lbs.) (0-Maximum)
4.6L	3.73	5580 (12300)	0-3220 (0-7100)
Maximum frontal area of trailer is 3.72 square meters (40 square feet).			
<p>Notes: For high altitude operation, reduce GCW by 2% per 300 meters (1000 ft) elevation. For definitions of terms used in this table and instructions on how to calculate your vehicle load, refer to <i>Vehicle loading</i> in this chapter. Maximum trailer weights shown. The combined weight of the completed towing vehicle and the loaded trailer must not exceed the GCWR.</p>			
<p>In ambient temperatures greater than 38°C (100°F), it is recommended that the maximum GCW be reduced to 5262 kg (11600 lbs). At these temperatures, vehicle speed should be kept below 97 km/h (60 mph) during highway operation. Extended operation above 4000 rpm should be avoided.</p>			
<p>Towing a trailer over 1588 kg (3500 lbs.) requires a weight distributing hitch.</p>			



Do not exceed the GVWR or the GAWR specified on the certification label.



Towing trailers beyond the maximum recommended gross trailer weight exceeds the limit of the vehicle and could result in engine damage, transmission damage, structural damage, loss of vehicle control, vehicle rollover and personal injury.

Trailer hitch cover

Your vehicle is equipped with a removable trailer hitch trim cover. To remove the trim cover:

1. Loosen the two push pins in the bottom of the cover by turning them counterclockwise with a flathead screwdriver or similar object.

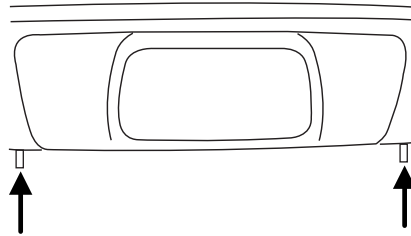

2. To reinstall the cover, insert the three plastic tabs into their slots (as shown in the illustration) and push the cover up into the bumper trim.

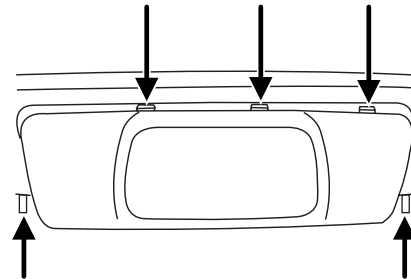

3. Hold the cover against the bumper trim and reinstall the two screws.

Preparing to tow

Use the proper equipment for towing a trailer and make sure it is properly attached to your vehicle. See your dealer or a reliable trailer dealer if you require assistance.

Hitches

Do not use hitches that clamp onto the vehicle bumper. Use a load carrying hitch. You must distribute the load in your trailer so that 10–15% of the total weight of the trailer is on the tongue.

Safety chains

Always connect the trailer's safety chains to the frame or hook retainers of the vehicle hitch. To connect the trailer's safety chains, cross the chains under the trailer tongue and allow slack for turning corners.

If you use a rental trailer, follow the instructions that the rental agency gives to you.

Do not attach safety chains to the bumper.

Driving

Trailer brakes

Electric brakes and manual, automatic or surge-type trailer brakes are safe if installed properly and adjusted to the manufacturer's specifications. The trailer brakes must meet local and Federal regulations.



Do not connect a trailer's hydraulic brake system directly to your vehicle's brake system. Your vehicle may not have enough braking power and your chances of having a collision greatly increase.

The braking system of the tow vehicle is rated for operation at the GVWR not GCWR.

Trailer lamps

Trailer lamps are required on most towed vehicles. Make sure your trailer lamps conform to local and Federal regulations. See your dealer or trailer rental agency for proper instructions and equipment for hooking up trailer lamps.



Never connect any trailer lighting to the vehicle's taillamp circuits, because it may damage the electrical system resulting in fire. Contact your local Ford dealership for assistance in proper trailer tow wiring installation. Additional electrical equipment may be required.

Driving while you tow

When towing a trailer:

- Turn off the speed control. The speed control may shut off automatically when you are towing on long, steep grades.
- Consult your local motor vehicle speed regulations for towing a trailer.
- To eliminate excessive shifting, use a lower gear. This will also assist in transmission cooling. (For additional information, refer to the *Driving with a 5-speed automatic transmission* section in this chapter.
- Under extreme conditions with large frontal trailers, high outside temperatures and highway speeds, the coolant gauge may indicate higher than normal coolant temperatures. If this occurs, reduce speed until the coolant temperature returns to the normal range. Refer to *Engine coolant temperature gauge* in the *Instrument cluster* chapter.
- Anticipate stops and brake gradually.
- Do not exceed the GCWR rating or transmission damage may occur.

248

Servicing after towing

If you tow a trailer for long distances, your vehicle will require more frequent service intervals. Refer to your scheduled maintenance guide for more information.

Trailer towing tips

- Practice turning, stopping and backing up before starting on a trip to get the feel of the vehicle trailer combination. When turning, make wider turns so the trailer wheels will clear curbs and other obstacles.
- Allow more distance for stopping with a trailer attached.
- If you are driving down a long or steep hill, shift to a lower gear. Do not apply the brakes continuously, as they may overheat and become less effective.
- The trailer tongue weight should be 10–15% of the loaded trailer weight.
- After you have traveled 80 km (50 miles), thoroughly check your hitch, electrical connections and trailer wheel lug nuts.
- To aid in engine/transmission cooling and A/C efficiency during hot weather while stopped in traffic, place the gearshift lever in P (Park).
- Vehicles with trailers should not be parked on a grade. If you must park on a grade, place wheel chocks under the trailer's wheels.

Launching or retrieving a boat

Disconnect the wiring to the trailer before backing the trailer into the water. Reconnect the wiring to the trailer after the trailer is removed from the water.

When backing down a ramp during boat launching or retrieval:

- do not allow the static water level to rise above the bottom edge of the rear bumper.
- do not allow waves to break higher than 15 cm (6 inches) above the bottom edge of the rear bumper.

Exceeding these limits may allow water to enter vehicle components:

- causing internal damage to the components.
- affecting driveability, emissions and reliability.

Replace the rear axle lubricant any time the axle has been submerged in water. Rear axle lubricant quantities are not to be checked or changed unless a leak is suspected or repair required.

Driving

RECREATIONAL TOWING (ALL WHEELS ON THE GROUND)

Follow these guidelines for your specific powertrain combination to tow your vehicle with all four wheels on the ground (such as behind a recreational vehicle).

These guidelines are designed to ensure that your transmission is not damaged due to insufficient lubrication.

Rear Wheel Drive (RWD) 4x2 vehicles:

This applies to all 4x2 trucks/sport utilities with rear wheel drive capability.

- Place the transmission in N (Neutral).
- Maximum speed is 56 km/h (35 mph).
- Maximum distance is 80 km (50 miles).

If a distance of 80 km (50 miles) or a speed of 56 km/h (35 mph) must be exceeded, you must disconnect the driveshaft. Ford recommends the driveshaft be removed/installed only by a qualified technician. See your local dealer for driveshaft removal/installation.

Improper removal/installation of the driveshaft can cause transmission fluid loss, damage to the driveshaft and internal transmission components.

AWD vehicles:

Vehicles equipped with AWD cannot be towed with all wheels on the ground as vehicle damage may occur.

Roadside Emergencies

GETTING ROADSIDE ASSISTANCE

To fully assist you should you have a vehicle concern, Ford Motor Company offers a complimentary roadside assistance program. This program is separate from the New Vehicle Limited Warranty. The service is available:

- 24-hours, seven days a week
- for the New Vehicle Limited Warranty period of three years or 60,000 km (36,000 miles), whichever occurs first on Ford and Mercury vehicles, and four years or 80,000 km (50,000 miles) on Lincoln vehicles.

Roadside assistance will cover:

- changing a flat tire
- jump-starts
- lock-out assistance
- limited fuel delivery
- towing of your disabled vehicle to the nearest Ford Motor Company dealership, or your selling dealer if within 56.3 km (35 miles) of the nearest Ford Motor Company dealership (one tow per disablement). Even non-warranty related tows, like accidents or getting stuck in the mud or snow, are covered (some exclusions apply, such as impound towing or repossession).

Canadian customers refer to your Owner Information Guide for information on:

- coverage period
- exact fuel amounts
- towing of your disabled vehicle
- emergency travel expense reimbursement
- travel planning benefits

USING ROADSIDE ASSISTANCE

Complete the roadside assistance identification card and place it in your wallet for quick reference. In the United States, this card is found in the Owner Guide portfolio in the glove compartment in Ford vehicles and is mailed to you if you own a Mercury or Lincoln. In Canada, the card is found in the Owner Information Guide in the glove compartment.

U.S. Ford or Mercury vehicle customers who require roadside assistance, call 1-800-241-3673; Lincoln vehicle customers call 1-800-521-4140.

Roadside Emergencies

Canadian customers who require roadside assistance, call 1-800-665-2006.

If you need to arrange roadside assistance for yourself, Ford Motor Company will reimburse a reasonable amount. To obtain reimbursement information, U.S. Ford or Mercury vehicles customers call 1-800-241-3673; Lincoln vehicle customers call 1-800-521-4140.

Canadian customers who need to obtain reimbursement information, call 1-800-665-2006.

ROADSIDE COVERAGE BEYOND BASIC WARRANTY

In the United States, you may purchase additional roadside assistance coverage beyond this period through the Ford Auto Club by contacting your Ford or Lincoln Mercury dealer.

Similarly in Canada, for uninterrupted Roadside Assistance coverage, you may purchase extended coverage prior to your Basic Warranty's Roadside Assistance expiring. For more information and enrollment, contact 1-877-294-2582 or visit our website at www.ford.ca.

HAZARD FLASHER

Use only in an emergency to warn traffic of vehicle breakdown, approaching danger, etc. The hazard flashers can be operated when the ignition is off.

- The hazard lights control is located on top of the steering column.
- Depress hazard lights control to activate all hazard flashers simultaneously.
- Depress control again to turn the flashers off.

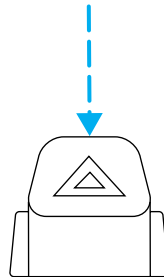

FUEL PUMP SHUT-OFF SWITCH FUEL RESET

The fuel pump shut-off switch is a device intended to stop the electric fuel pump when your vehicle has been involved in a substantial jolt.

After a collision, if the engine cranks but does not start, the fuel pump shut-off switch may have been activated.

252

Roadside Emergencies

The fuel pump shut-off switch is located in the passenger's foot well, by the kick panel.

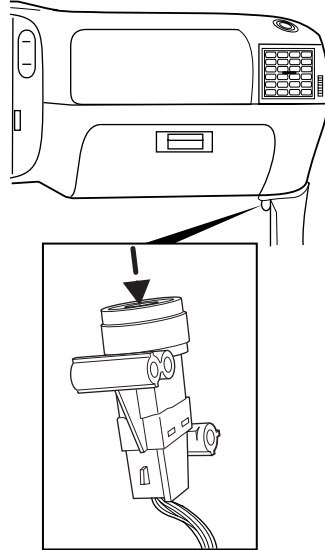

Use the following procedure to reset the fuel pump shut-off switch.

1. Turn the ignition to the OFF position.
2. Check the fuel system for leaks.
3. If no fuel leak is apparent, reset the fuel pump shut-off switch by pushing in on the reset button.
4. Turn the ignition to the ON position. Pause for a few seconds and return the key to the OFF position.
5. Make a further check for leaks in the fuel system.

FUSES AND RELAYS

Fuses

If electrical components in the vehicle are not working, a fuse may have blown. Blown fuses are identified by a broken wire within the fuse. Check the appropriate fuses before replacing any electrical components.

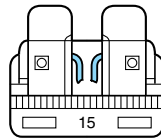

Roadside Emergencies

Note: Always replace a fuse with one that has the specified amperage rating. Using a fuse with a higher amperage rating can cause severe wire damage and could start a fire.

Standard fuse amperage rating and color

COLOR					
Fuse rating	Mini fuses	Standard fuses	Maxi fuses	Cartridge maxi fuses	Fuse link cartridge
2A	Grey	Grey	—	—	—
3A	Violet	Violet	—	—	—
4A	Pink	Pink	—	—	—
5A	Tan	Tan	—	—	—
7.5A	Brown	Brown	—	—	—
10A	Red	Red	—	—	—
15A	Blue	Blue	—	—	—
20A	Yellow	Yellow	Yellow	Blue	Blue
25A	Natural	Natural	—	—	—
30A	Green	Green	Green	Pink	Pink
40A	—	—	Orange	Green	Green
50A	—	—	Red	Red	Red
60A	—	—	Blue	—	Yellow
70A	—	—	Tan	—	Brown
80A	—	—	Natural	—	Black

Passenger compartment fuse panel

The fuse panel is located below the instrument panel on the driver's side.

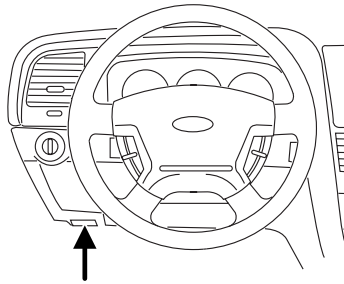

Roadside Emergencies

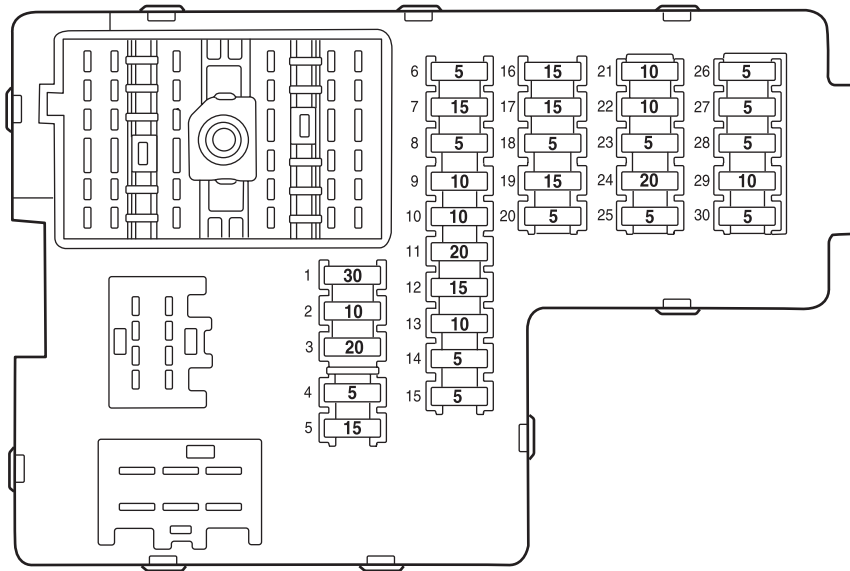

The fuses are coded as follows:

Fuse/Relay Location	Fuse Amp Rating	Passenger Compartment Fuse Panel Description
1	30A	Moonroof, Driver seat switch
2	10A	VAPS module, Memory seat module, Body security module, TPMS
3	20A	Radio, Navigation
4	5A	Front wiper module
5	15A	Flasher relay (turn/hazards)
6	5A	Power antenna, Radio, Moonroof motor, Driver window motor, Navigation
7	15A	Heated mirrors, DEATC module
8	5A	Daytime Running Lamps (DRL) module
9	10A	Back-up lamps (DTRS)

Roadside Emergencies

Fuse/Relay Location	Fuse Amp Rating	Passenger Compartment Fuse Panel Description
10	10A	Heated backlight relay coil, Climate seat modules, Auxiliary A/C temperature blend/mode actuator, A/C clutch relay contact
11	20A	Not used (spare)
12	15A	Restraints module
13	10A	Brake shift interlock
14	5A	Cornering lamps
15	5A	Instrument cluster, Rear wiper module, TPMS
16	15A	Cigar lighter, OBD II, Liftgate release relay coil and contacts
17	15A	Delayed accessory relay coil, Battery saver relay coil and contacts
18	5A	Not used (spare)
19	15A	Washer pump
20	5A	Shifter, Clock, Power mirror switch, DVD
21	10A	Brake pressure switch (ABS), IVD switch, Flasher relay
22	10A	ABS module
23	5A	Sunload/Autolamp sensor (SecuriLock [™] transceiver LED)
24	20A	Subwoofer, Navigation
25	5A	Puddle lamp relay coil, Trailer tow battery charge relay coil
26	5A	SecuriLock [™] transceiver
27	5A	Rear park assist, VAPS module
28	5A	Radio, Navigation
29	10A	DTRS, Feed to Fuse 28
30	5A	Instrument cluster, Compass module, Auxiliary A/C relay coil

Roadside Emergencies

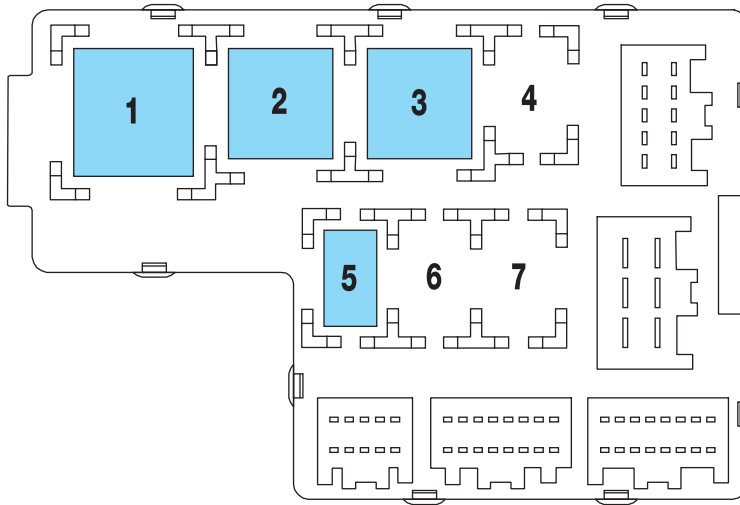

The relays are located on the reverse side of the passenger compartment fuse panel. To access the relays, you must remove the fuse panel.

Fuse/Relay Location	Description
Relay 1	Flasher relay
Relay 2	Heated backlight relay
Relay 3	Delayed accessory relay
Relay 4	Open
Relay 5	Battery saver relay
Relay 6	Open
Relay 7	Open

Power distribution box

The power distribution box is located in the engine compartment. The power distribution box contains high-current fuses that protect your vehicle's main electrical systems from overloads.



Always disconnect the battery before servicing high current fuses.

Roadside Emergencies

Always replace the cover to the power distribution box before reconnecting the battery or refilling fluid reservoirs

If the battery has been disconnected and reconnected, refer to the *Battery* section of the *Maintenance and specifications* chapter.

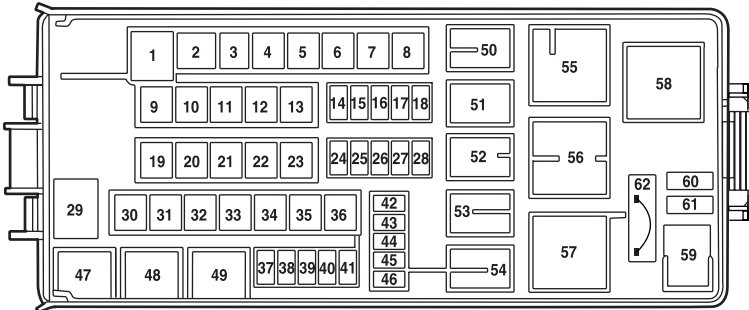

The high-current fuses are coded as follows:

Fuse/Relay Location	Fuse Amp Rating	Power Distribution Box Description
1	60A**	PJB
2	30A**	Door locks (BSM)
3	—	Not used
4	40A**	Heated backlight/mirrors
5	40A**	Anti-lock Brake System (ABS) module (pump)
6	60A**	Delayed accessory
7	20A**	DRL module
8	20A**	Electric cooling fan
9	20A**	Headlamp switch
10	30A**	ABS module (valves)
11	40A**	PTEC relay contacts
12	50A**	Ignition/Starter relay
13	40A**	Trailer tow relays
14	15A*	Brake lamp feed

Roadside Emergencies

Fuse/Relay Location	Fuse Amp Rating	Power Distribution Box Description
15	10A*	Keep alive power (PTEC/cluster/DEATC)
16	20A*	Power point #3
17	20A*	Rear wiper module
18	20A*	4x4 module
19	30A**	Driver window motor
20	30A**	Electric trailer brakes
21	30A**	Memory seat module
22	20A**	Main exterior lamps (low beam headlamps, high beam headlamps, fog lamps)
23	30A**	Ignition switch
24	20A*	Horn relay
25	20A*	Power point #1
26	20A*	Fuel pump relay contacts
27	20A*	Trailer tow lamps
28	20A*	Power point #2
29	60A**	PJB
30	30A**	Front wiper module
31	30A**	Climate-controlled seats modules
32	30A**	Passenger seat switch
33	30A**	Auxiliary blower motor
34	20A**	Right HID relay
35	20A**	Left HID relay
36	40A**	Blower motor
37	15A*	A/C clutch relay, TXV, Transmission, Speed control
38	15A*	HEGO, VMV, Canister vent, IMCC-LSRC, Heated PCV, EGR module
39	15A*	Injectors

Roadside Emergencies

Fuse/Relay Location	Fuse Amp Rating	Power Distribution Box Description
40	15A*	PTEC, Mass Air Flow (MAF) sensor, Fuel pump relay
41	25A*	Coil on plug, PTEC relay
42	10A*	Right low beam (halogen)
43	10A*	Left low beam (halogen)
44	15A*	Fog lamp relay
45	2A*	Brake Pressure Switch
46	20A*	High beam
47	—	Horn relay
48	—	Fuel pump relay
49	—	High beam relay
50	—	Fog lamp relay
51	—	Not used
52	—	A/C clutch relay
53	—	Trailer tow right turn relay
54	—	Trailer tow left turn relay
55	—	Blower motor relay
56	—	Starter motor relay
57	—	PTEC relay
58	—	Ignition relay
59	—	Driver brake applied relay
60	—	PCM diode
61	—	A/C clutch diode
62	30A***	Power windows

* Mini Fuses ** Maxi Cartridge Fuses *** Circuit breaker

Roadside Emergencies

Auxiliary relay box

The relay box is located on the front right fender well underneath the speed control module.

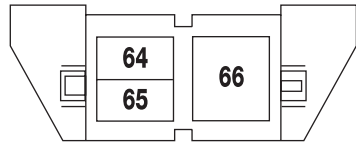
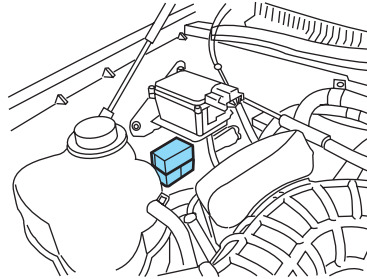

The relays are coded as follows:

Fuse/Relay Location	Description
Relay 64	Right HID relay
Relay 65	Left HID relay
Relay 66	EDF relay

Rear relay box

The relay box is located on the rear passenger side quarter trim panel. See your dealer or a certified technician for service of this relay box.

Roadside Emergencies

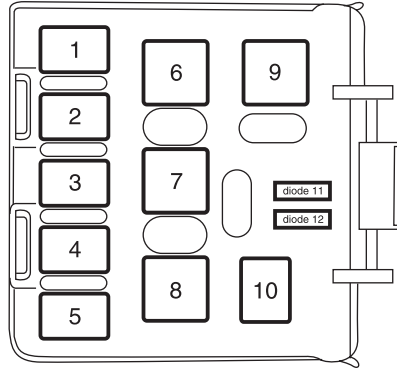

The relays are coded as follows:

Fuse/Relay Location	Description
Relay 1	Liftgate release solenoid
Relay 2	Open
Relay 3	Open
Relay 4	Trailer tow back-up lamps
Relay 5	Open
Relay 6	Open
Relay 7	Trailer tow battery charge
Relay 8	Trailer tow park lamps
Relay 9	Open
Relay 10	Puddle lamps
Diode 11	Open
Diode 12	Open

CHANGING THE TIRES

If you get a flat tire while driving:

- do not brake heavily.
- gradually decrease the vehicle's speed.
- hold the steering wheel firmly.
- slowly move to a safe place on the side of the road.

Roadside Emergencies

 The use of tire sealants is not recommended and may compromise the integrity of your tires. The use of tire sealants may also affect your tire pressure monitoring system (if equipped).

 If your vehicle is equipped with a tire pressure monitoring system, refer to *Tire Pressure Monitoring System (if equipped)* in the *Maintenance and specifications* section for important information. If the tire pressure monitor sensor becomes damaged, it will no longer function.

Spare tire information

The spare tire can be used as a spare or a regular tire and is identical to the other tires on your vehicle.

 If your vehicle is equipped with AWD, a spare tire of a different size than the road tires should not be used. Such a tire could make the vehicle difficult to control as well as result in damage to driveline components.

Stopping and securing the vehicle

1. If you get a flat tire while driving, do not apply the brake heavily; instead, gradually decrease your speed. Hold the steering wheel firmly and slowly move to a safe place on the side of the road.
2. Park on a level surface, activate the hazard flashers and set the parking brake.
3. Place gearshift lever in P (Park) and turn engine OFF.

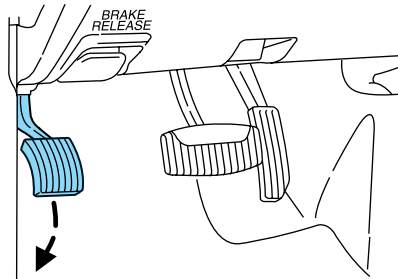

 When one of the rear wheels is off the ground, the transmission alone will not prevent the vehicle from moving or slipping off the jack, even if the transmission is in P (Park).

Roadside Emergencies

Note: Passengers should not remain in the vehicle when the vehicle is being jacked.

4. Block the wheel that is diagonally opposite of the flat tire using the wheel chock provided with your vehicle.

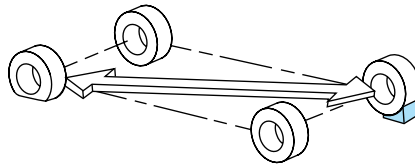

Location of the spare tire and tools

The spare tire and tools for your vehicle are stowed in the following locations:

Tool	Location
Spare tire	Under the vehicle, just in front of the rear bumper. The spare tire winch drive nut is located at the rear center of the cargo area under a lid.
Jack, lug nut wrench, jack handle, wheel chock	Behind the rear seat under the carpeted floor lid in the cargo floor. The tools are located in a bag attached to the jack.

Removing the jack and tools

1. Open liftgate and remove the carpeted floor lid and jack cover.
2. Turn jack screw eyelet counterclockwise and remove the jack from the bracket.

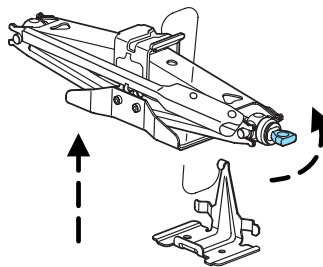

Roadside Emergencies

3. Remove the tools from the provided bag.

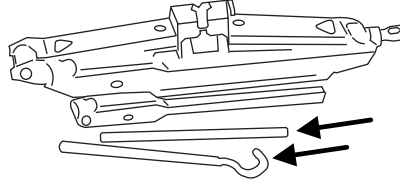

Rotate the wrench socket out from the handle.

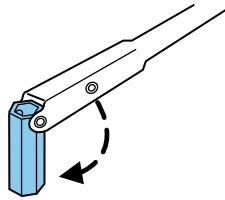

Removing the spare tire

Do not use an impact wrench on the winch drive nut. This will damage the spare tire winch.

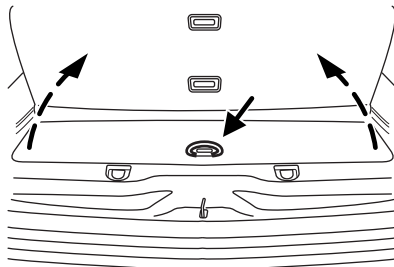

1. Open the cover from the carpeting on cargo floor to expose the winch drive nut.

Roadside Emergencies

2. Insert the lug wrench on the winch drive nut.

The wrench will stop moving and forward resistance to turning will be felt when properly engaged.

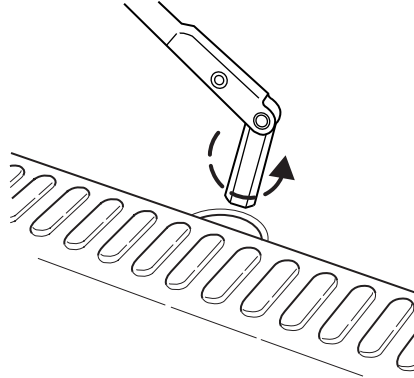

3. Turn the wrench counterclockwise until the tire is lowered to the ground and the cable has slack. When turning the wrench, make sure that it does not scuff the kick plate.

4. Slide the tire rearward, lift one side and remove the retainer from the spare tire.

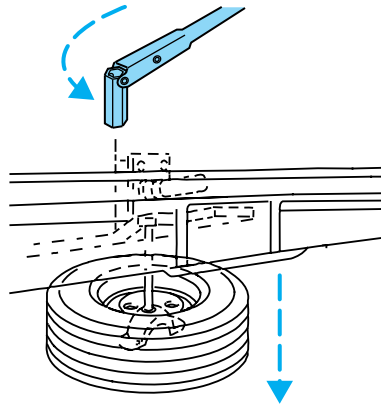

Changing the spare tire



To prevent the vehicle from moving when you change a tire, be sure the parking brake is set, then block the wheel that is diagonally opposite (other end of the vehicle) to the tire being changed.



If the vehicle slips off the jack, you or someone else could be seriously injured.

Roadside Emergencies

1. Use the tip of the lug wrench to remove the beauty cap by twisting the tip under the cap. The carpeted floor lid can be used as a kneeling pad.

2. Loosen each wheel lug nut by half a turn, but do not remove them until the wheel is raised off the ground.

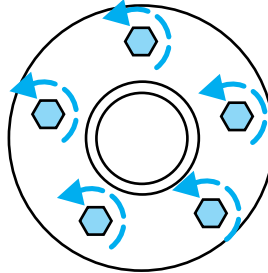

3. Assemble the jack handle extension on the lug nut wrench by sliding the square end of the jack handle through the plastic grommet on the lug nut wrench and into the square hole on the other side.

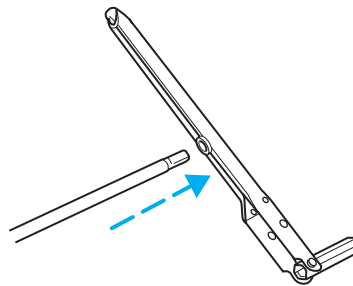

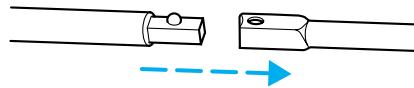

If equipped with a two-piece extension, assemble the two-piece extension by sliding the two halves together.

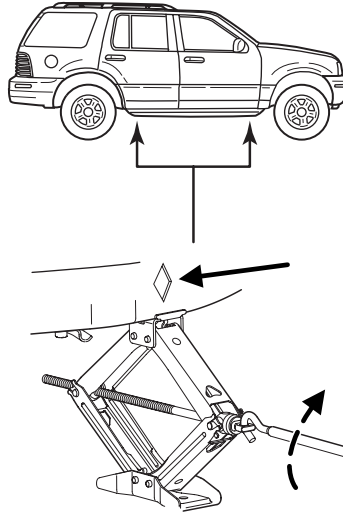

Roadside Emergencies

4. Position the jack according to the illustrated guides and turn the jack handle clockwise until the tire is a maximum of 25 mm (1 inch) off the ground.



 To lessen the risk of personal injury, do not put any part of your body under the vehicle while changing a tire. Do not start the engine when your vehicle is on the jack. The jack is only meant for changing the tire.

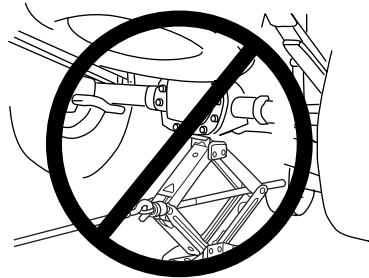

- **Never use the front or rear differential as a jacking point.**

5. Remove the lug nuts with the lug wrench.
6. Replace the flat tire with the spare tire, making sure the valve stem is facing outward. Reinstall the lug nuts, cone side in, until the wheel is snug against the hub. Do not fully tighten the lug nuts until the wheel has been lowered.
7. Lower the wheel by turning the jack handle counterclockwise.

268

Roadside Emergencies

8. Remove the jack and fully tighten the lug nuts in the order shown.

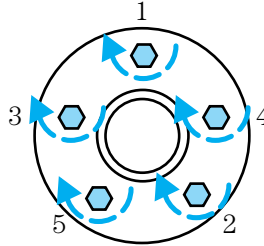

Stowing the flat/spare tire

1. Lay the tire on the ground with the valve stem facing up, toward the vehicle.

2. Slide the wheel partially under the vehicle and install the retainer through the wheel center. Pull on the cable to align the components at the end of the cable.

3. Turn the lug wrench clockwise until the tire is raised to its stowed position underneath the vehicle. The effort to turn the jack handle increases significantly and the spare tire carrier ratchets or slips when the tire is raised to the maximum tightness. Tighten to the best of your ability, to the point where the ratchet/slip occurs, if possible. The spare tire carrier will not allow you to overtighten. If the spare tire carrier ratchets or slips with little effort, take the vehicle to your dealer for assistance at your earliest convenience.

4. Check that the tire lies flat against the frame and is properly tightened. Try to push or pull, then turn the tire to be sure it will not move. Loosen and retighten, if necessary. Failure to properly stow the spare tire may result in failure of the winch cable and loss of the tire.

5. If your vehicle is equipped with a spare tire lock and key, be sure to install the spare tire lock into the bumper drive tube with the spare tire lock key and jack handle.

6. Repeat this tightness check procedure when servicing the spare tire pressure (every six months, per scheduled maintenance guide), or at any time that the spare tire is disturbed through service of other components.

Re-stowing the jack and tools

1. Unblock the wheels.

2. Replace beauty cap, stow the jack and tools in their respective locations, making sure they are fully secured so they do not rattle when you drive.

Roadside Emergencies

JUMP STARTING YOUR VEHICLE



The gases around the battery can explode if exposed to flames, sparks, or lit cigarettes. An explosion could result in injury or vehicle damage.



Batteries contain sulfuric acid which can burn skin, eyes and clothing, if contacted.

Do not attempt to push-start your vehicle. Automatic transmissions do not have push-start capability; also, the catalytic converter may become damaged.

Preparing your vehicle

When the battery is disconnected or a new battery is installed, the transmission must relearn its shift strategy. As a result, the transmission may have firm and/or soft shifts. This operation is considered normal and will not affect function or durability of the transmission. Over time, the adaptive learning process will fully update transmission operation.

1. **Use only a 12-volt supply to start your vehicle.**
2. Do not disconnect the battery of the disabled vehicle as this could damage the vehicle's electrical system.
3. Park the booster vehicle close to the hood of the disabled vehicle making sure the two vehicles **do not** touch. Set the parking brake on both vehicles and stay clear of the engine cooling fan and other moving parts.
4. Check all battery terminals and remove any excessive corrosion before you attach the battery cables. Ensure that vent caps are tight and level.
5. Turn the heater fan on in both vehicles to protect any electrical surges. Turn all other accessories off.

Roadside Emergencies

Connecting the jumper cables

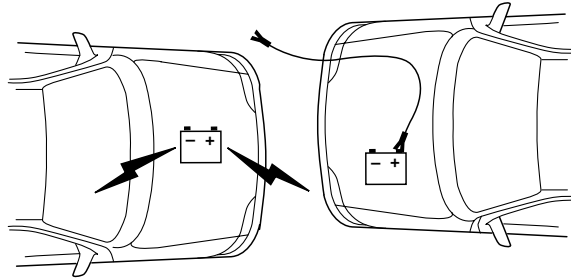

1. Connect the positive (+) jumper cable to the positive (+) terminal of the discharged battery.

Note: In the illustrations, *lightning bolts* are used to designate the assisting (boosting) battery.

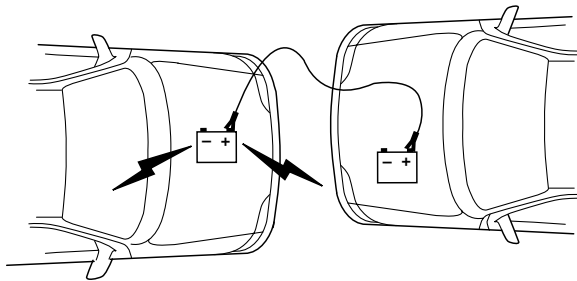

2. Connect the other end of the positive (+) cable to the positive (+) terminal of the assisting battery.

Roadside Emergencies

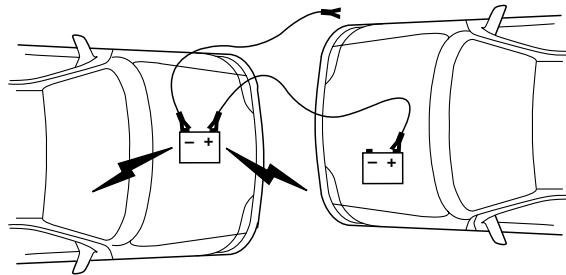

3. Connect the negative (-) cable to the negative (-) terminal of the assisting battery.

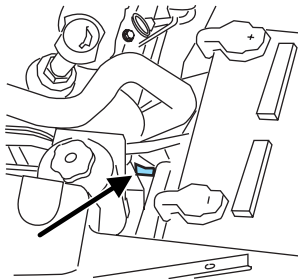

4. Make the final connection of the negative (-) cable to the exposed ground metal surface accessible on the side of the power steering pump reservoir bracket, facing the battery. **Do not** use fuel lines, engine rocker covers or the intake manifold as *grounding* points.



Do not connect the end of the second cable to the negative (-) terminal of the battery to be jumped. A spark may cause an explosion of the gases that surround the battery.

5. Ensure that the cables are clear of fan blades, belts, moving parts of both engines, or any fuel delivery system parts.

Jump starting

1. Start the engine of the booster vehicle and run the engine at moderately increased speed.
2. Start the engine of the disabled vehicle.
3. Once the disabled vehicle has been started, run both engines for an additional three minutes before disconnecting the jumper cables.

Roadside Emergencies

Removing the jumper cables

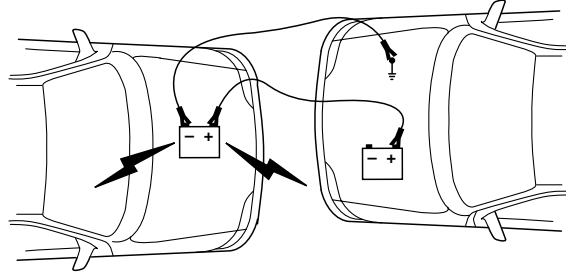

Remove the jumper cables in the reverse order that they were connected.

1. Remove the jumper cable from the *ground* metal surface.

Note: In the illustrations, *lightning bolts* are used to designate the assisting (boosting) battery.

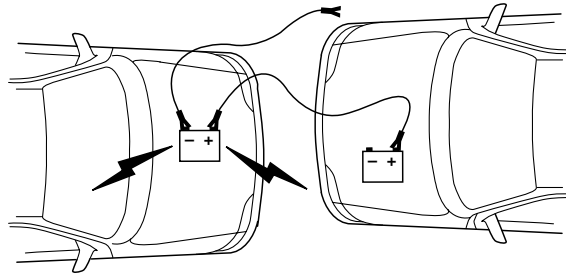

2. Remove the jumper cable on the negative (-) connection of the booster vehicle's battery.

Roadside Emergencies

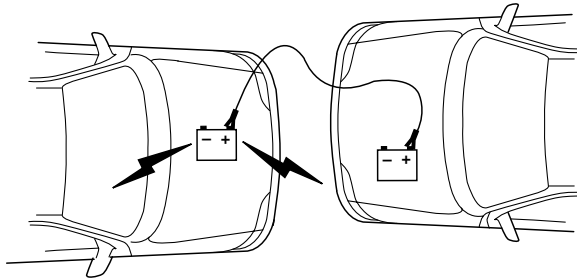

3. Remove the jumper cable from the positive (+) terminal of the booster vehicle's battery.

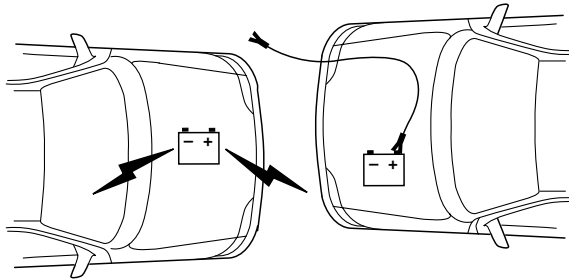

4. Remove the jumper cable from the positive (+) terminal of the disabled vehicle's battery.

After the disabled vehicle has been started and the jumper cables removed, allow it to idle for several minutes so the engine computer can *relearn* its idle conditions.

Roadside Emergencies

WRECKER TOWING

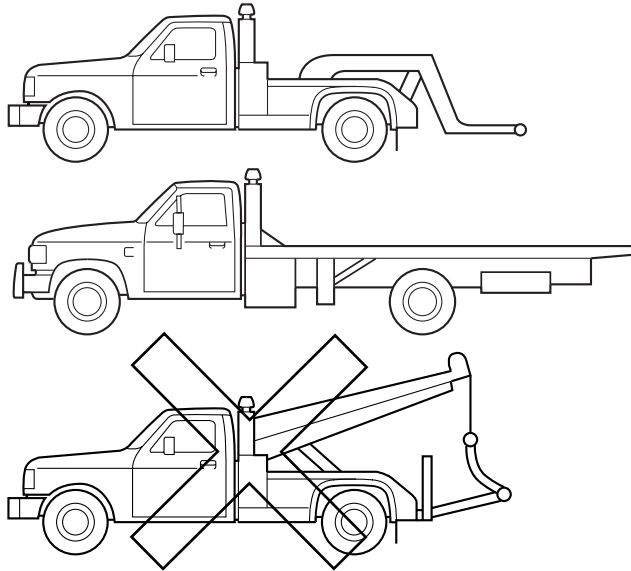

If you need to have your vehicle towed, contact a professional towing service or, if you are a member of a roadside assistance program, your roadside assistance service provider.

It is recommended that your vehicle be towed with a wheel lift or flatbed equipment. Do not tow with a slingbelt. Ford Motor Company has not approved a slingbelt towing procedure.

On 4x2 vehicles, it is acceptable to tow the vehicle with a wheel lift without dollies or flatbed equipment.

On AWD vehicles, it is recommended that your vehicle be towed with a wheel lift and dollies or flatbed equipment with all the wheels off the ground.

Ford Motor Company has developed a procedure to hook-up your vehicle that minimizes the risk of damage during towing when using wheel lift equipment with the front wheels off the ground.

If the vehicle is towed by other means or incorrectly, vehicle damage may occur.

Ford Motor Company produces a towing manual for all authorized tow truck operators. Have your tow truck operator refer to this manual for proper hook-up and towing procedures for your vehicle.

Customer Assistance

GETTING THE SERVICES YOU NEED

At home

Ford Motor Company and Ford of Canada have authorized dealerships to service your vehicle. It is preferred that you return to the authorized dealer where your vehicle was purchased when warranty repairs are needed. However, you may also take your vehicle to another Ford Motor Company or Ford of Canada dealership authorized for warranty repairs. Certain warranty repairs require special training though, so not all dealers are authorized to perform all warranty repairs. That means that depending on the warranty repair needed, the vehicle may need to be taken to another dealer. If a particular dealership cannot assist you, then contact the Customer Relationship Center.

If you have questions or concerns, or are unsatisfied with the service you are receiving, follow these steps:

1. Contact your Sales Representative or Service Advisor at your selling/servicing dealership.
2. If your inquiry or concern remains unresolved, contact the Sales Manager or Service Manager at the dealership.
3. If the inquiry or concern cannot be resolved at the dealership level, please contact the Ford Customer Relationship Center.

Away from home

If you own a Ford or Mercury vehicle and are away from home when your vehicle needs service, or if you need more help than the dealership could provide, after following the steps described above, contact the Ford Customer Relationship Center to find an authorized dealership to help you.

In the United States:

Ford Motor Company
Customer Relationship Center
16800 Executive Plaza Drive
P.O. Box 6248
Dearborn, Michigan 48121
1-800-392-3673 (FORD)
(TDD for the hearing impaired: 1-800-232-5952)
www.ford.com

Customer Assistance

In Canada:
Customer Relationship Centre
Ford Motor Company of Canada, Limited
P.O. Box 2000
Oakville, Ontario L6J 5E4
1-800-565-3673 (FORD)
www.ford.ca

If you own a Lincoln vehicle and are away from home when your vehicle needs service, or if you need more help than the dealership could provide, after following the steps described above, contact the Ford Customer Relationship Center to find an authorized dealership to help you.

In the United States:
Ford Motor Company
Customer Relationship Center
16800 Executive Plaza Drive
P.O. Box 6248
Dearborn, Michigan 48121
1-800-521-4140
(TDD for the hearing impaired: 1-800-232-5952)
www.ford.com

In Canada:
Customer Relationship Centre
Ford Motor Company of Canada, Limited
P.O. Box 2000
Oakville, Ontario L6J 5E4
1-800-565-3673 (FORD)
www.ford.ca

In order to help you service your Ford or Lincoln Mercury vehicle, please have the following information available when contacting a Customer Relationship Center:

- Your telephone number (home and business)
- The name of the dealer and the city where the dealership is located
- The year and make of your vehicle
- The date of vehicle purchase
- The current odometer reading
- The vehicle identification number (VIN)

If you still have a complaint involving a warranty dispute, you may wish to contact the Dispute Settlement Board (U.S.).

Customer Assistance

In some states (in the U.S.) you must directly notify Ford in writing before pursuing remedies under your state's warranty laws. Ford is also allowed a final repair attempt in some states.

In the United States, a warranty dispute must be submitted to the Dispute Settlement Board before taking action under the Magnuson-Moss Warranty Act, or to the extent allowed by state law, before pursuing replacement or repurchase remedies provided by certain state laws. This dispute handling procedure is not required prior to enforcing state created rights or other rights which are independent of the Magnuson-Moss Warranty Act or state replacement or repurchase laws.

FORD EXTENDED SERVICE PLAN

You can get more protection for your new car or light truck by purchasing Ford Extended Service Plan (Ford ESP) coverage. Ford ESP is an optional service contract which is backed by Ford Motor Company or Ford Motor Service Company (in the U.S.) and Ford of Canada (in Canada). It provides the following:

- Benefits during the warranty period depending on the plan you purchase (such as: reimbursement for rentals; coverage for certain maintenance and wear items).
- Protection against covered repair costs after your Bumper-to-Bumper Warranty expires.

You may purchase Ford ESP from any participating Ford and Lincoln Mercury and Ford of Canada dealer. There are several plans available in various time, distance and deductible combinations which can be tailored to fit your own driving needs. Ford ESP also offers reimbursement benefits for towing and rental coverage.

When you buy Ford ESP, you receive Peace-of-Mind protection throughout the United States and Canada, provided by a network of more than 5,000 participating Ford or Lincoln Mercury and Ford of Canada dealers.

If you did not take advantage of the Ford Extended Service Plan at the time of purchasing your vehicle, you may still be eligible. Since this information is subject to change, please ask your dealer for complete details about Ford Extended Service Plan coverage options, or visit the Ford ESP website at www.ford-esp.com.

Customer Assistance

THE DISPUTE SETTLEMENT BOARD (U.S. ONLY)

The Dispute Settlement Board is:

- an independent, third-party arbitration program for warranty disputes.
- available free to owners and lessees of qualifying Ford Motor Company vehicles.

The Dispute Settlement Board may not be available in all states. Ford Motor Company reserves the right to change eligibility limitations, modify procedures and/or to discontinue this service without notice and without incurring obligations per applicable state law.

What kinds of cases does the Board review?

Unresolved warranty repair concerns or vehicle performance concerns as on Ford and Lincoln Mercury cars and Ford and Lincoln Mercury light trucks which are within the terms of any applicable written new vehicle warranty are eligible for review, except those involving:

- a non-Ford product
- a non-Ford dealership
- sales disputes between customer and dealer except those associated with warranty repairs or concerns with the vehicle's performance as designed
- a request for reimbursement of consequential expenses unless a service or product concern is being reviewed
- items not covered by the New Vehicle Limited Warranty (including maintenance and wear items)
- alleged personal injury/property damage claims
- cases currently in litigation
- vehicles not used primarily for family, personal or household purposes (except in states where the Dispute Settlement Board is required to review commercial vehicles)
- vehicles with non-U.S. warranties

Concerns are ineligible for review if the New Vehicle Limited Warranty has expired at receipt of your application and, in certain states eligibility is dependent upon the customer's possession of the vehicle.

Eligibility may differ according to state law. For example, see the unique brochures for California, West Virginia, Georgia and Wisconsin purchasers/lessees.

Customer Assistance

Board membership

The Board consists of:

- Three consumer representatives
- A Ford or Lincoln Mercury dealership representative

Consumer candidates for Board membership are recruited and trained by an independent consulting firm. The dealership Board member is chosen from Ford and Lincoln Mercury dealership management, recognized for their business leadership qualities.

What the Board needs

To have your case reviewed you must complete the application in the DSB brochure and mail it to the address provided on the application form. Some states will require you to use certified mail, with return receipt requested.

Your application is reviewed and, if it is determined to be eligible, you will receive an acknowledgment indicating:

- The file number assigned to your application.
- The toll-free phone number of the DSB's independent administrator.

Your dealership and a Ford Motor Company representative will then be asked to submit statements.

To properly review your case, the Board needs the following information:

- Legible copies of all documents and maintenance or repair orders relevant to the case.
- The year, make, model, and Vehicle Identification Number (VIN) listed on your vehicle ownership license.
- The date of repair(s) and mileage at the time of occurrence(s).
- The current mileage.
- The name of the dealer(s) who sold or serviced the vehicle.
- A brief description of your unresolved concern.
- A brief summary of the action taken by the dealer(s) and Ford Motor Company.
- The names (if known) of all the people you contacted at the dealership(s).
- A description of the action you expect to resolve your concern.

You will receive a letter of explanation if your application does not qualify for Board review.

280

Customer Assistance

Oral presentations

If you would like to make an oral presentation, indicate YES to question 6 on the application. While it is your right to make an oral presentation before the Board, this is not a requirement and the Board will decide the case whether or not an oral presentation is made. An oral presentation may be requested by the Board as well.

Making a decision

Board members review all available information related to each complaint, including oral presentations, and arrive at a fair and impartial decision. Board review may be terminated at any time by either party.

Every effort is made to decide the case within 40 days of the date that all requested information is received by the Board. Since the Board generally meets once a month, it may take longer for the Board to consider some cases.

After a case is reviewed, the Board mails you a decision letter and a form on which to accept or reject the Board's decision. The decisions of the Board are binding on Ford (and, in some cases, on the dealer) but not on consumers who are free to pursue other remedies available to them under state or federal law.

To request a DSB Brochure/Application

For a brochure/application, speak to your dealer or write/call to the Board at the following address/phone number:

Dispute Settlement Board
P.O. Box 5120
Southfield, MI 48086-5120
1-800-428-3718

You may also contact the North American Customer Relationship Center at 1-800-392-3673 (Ford), TDD for the hearing impaired: 1-800-232-5952 or by writing to the Center at the following address:

Ford Motor Company
Customer Relationship Center
16800 Executive Plaza Drive
P.O. Box 6248
Dearborn, Michigan 48121

Customer Assistance

UTILIZING THE MEDIATION/ARBITRATION PROGRAM (CANADA ONLY)

In those cases where you continue to feel that the efforts by Ford and the dealer to resolve a factory-related vehicle service concern have been unsatisfactory, Ford of Canada participates in an impartial third party mediation/arbitration program administered by the Canadian Motor Vehicle Arbitration Plan (CAMVAP).

The CAMVAP program is a straight-forward and relatively speedy alternative to resolve a disagreement when all other efforts to produce a settlement have failed. This procedure is without cost to you and is designed to eliminate the need for lengthy and expensive legal proceedings.

In the CAMVAP program, impartial third-party arbitrators conduct hearings at mutually convenient times and places in an informal environment. These impartial arbitrators review the positions of the parties, make decisions and, when appropriate, render awards to resolve disputes. CAMVAP decisions are fast, fair, and final; the arbitrator's award is binding both to you and Ford of Canada.

CAMVAP services are available in all territories and provinces. For more information, without charge or obligation, call your CAMVAP Provincial Administrator directly at 1-800-207-0685.

GETTING ASSISTANCE OUTSIDE THE U.S. AND CANADA

Before exporting your vehicle to a foreign country, contact the appropriate foreign embassy or consulate. These officials can inform you of local vehicle registration regulations and where to find unleaded fuel.

If you cannot find unleaded fuel or can only get fuel with an anti-knock index lower than is recommended for your vehicle, contact a district or owner relations/customer relationship office.

The use of leaded fuel in your vehicle without proper conversion may damage the effectiveness of your emission control system and may cause engine knocking or serious engine damage. Ford Motor Company/Ford of Canada is not responsible for any damage caused by use of improper fuel.

In the United States, using leaded fuel may also result in difficulty importing your vehicle back into the U.S.

Customer Assistance

If your vehicle must be serviced while you are traveling or living in Central or South America, the Caribbean, or the Middle East, contact the nearest Ford dealership. If the dealership cannot help you, write or call:

FORD MOTOR COMPANY
WORLDWIDE DIRECT MARKET OPERATIONS
1555 Fairlane Drive
Fairlane Business Park #3
Allen Park, Michigan 48101
U.S.A.
Telephone: (313) 594-4857
FAX: (313) 390-0804

If you are in another foreign country, contact the nearest Ford dealership. If the dealership employees cannot help you, they can direct you to the nearest Ford affiliate office.

If you buy your vehicle in North America and then relocate outside of the U.S. or Canada, register your vehicle identification number (VIN) and new address with Ford Motor Company Worldwide Direct Market Operations.

ORDERING ADDITIONAL OWNER'S LITERATURE

To order the publications in this portfolio, contact Helm, Incorporated at:

HELM, INCORPORATED
P.O. Box 07150
Detroit, Michigan 48207

Or call:

For a free publication catalog, order toll free: 1-800-782-4356

Monday-Friday 8:00 a.m. - 6:00 p.m. EST

Helm, Incorporated can also be reached by their website:
www.helminc.com.

(Items in this catalog may be purchased by credit card, check or money order.)

Obtaining a French owner's guide

French Owner's Guides can be obtained from your dealer or by writing to Ford Motor Company of Canada, Limited, Service Publications, P.O. Box 1580, Station B, Mississauga, Ontario L4Y 4G3.

Customer Assistance

IN CALIFORNIA (U.S. ONLY)

California Civil Code Section 1793.2(d) requires that, if a manufacturer or its representative is unable to repair a motor vehicle to conform to the vehicle's applicable express warranty after a reasonable number of attempts, the manufacturer shall be required to either replace the vehicle with one substantially identical or repurchase the vehicle and reimburse the buyer in an amount equal to the actual price paid or payable by the consumer (less a reasonable allowance for consumer use). The consumer has the right to choose whether to receive a refund or replacement vehicle.

California Civil Code Section 1793.22(b) presumes that the manufacturer has had a reasonable number of attempts to conform the vehicle to its applicable express warranties if, within the first 18 months of ownership of a new vehicle or the first 29,000 km (18,000 miles), whichever occurs first:

1. Two or more repair attempts are made on the same nonconformity likely to cause death or serious bodily injury OR
2. Four or more repair attempts are made on the same nonconformity (a defect or condition that substantially impairs the use, value or safety of the vehicle) OR
3. The vehicle is out of service for repair of nonconformities for a total of more than 30 calendar days (not necessarily all at one time)

In the case of 1 or 2 above, the consumer must also notify the manufacturer of the need for the repair of the nonconformity at the following address:

Ford Motor Company
16800 Executive Plaza Drive
Mail Drop 3NE-B
Dearborn, MI 48126

Customer Assistance

REPORTING SAFETY DEFECTS (U.S. ONLY)

If you believe that your vehicle has a defect which could cause a crash or could cause injury or death, you should immediately inform the National Highway Traffic Safety Administration (NHTSA) in addition to notifying Ford Motor Company.

Ford Motor Company

If NHTSA receives similar complaints, it may open an investigation, and if it finds that a safety defect exists in a group of vehicles, it may order a recall and remedy campaign. However, NHTSA cannot become involved in individual problems between you, your dealer, or Ford Motor Company.

To contact NHTSA, you may either call the Auto Safety Hotline toll-free at 1-800-424-9393 (or 366-0123 in the Washington D.C. area) or write to:

NHTSA
U.S. Department of Transportation
Washington, D.C. 20590

You can also obtain other information about motor vehicle safety from the Hotline.

Cleaning

WASHING THE EXTERIOR

Wash your vehicle regularly with cool or lukewarm water and a neutral Ph shampoo, such as Motorcraft Detail Wash (ZC-3-A), which is available from your dealer.

- Never use strong household detergents or soap, such as dish washing or laundry liquid. These products can discolor and spot painted surfaces.
- Never wash a vehicle that is “hot to the touch” or during exposure to strong, direct sunlight.
- Always use a clean sponge or carwash mitt with plenty of water for best results.
- Dry the vehicle with a chamois or soft terry cloth towel in order to eliminate water spotting.
- It is especially important to wash the vehicle regularly during the winter months, as dirt and road salt are difficult to remove and cause damage to the vehicle.
- Immediately remove items such as gasoline, diesel fuel, bird droppings and insect deposits because they can cause damage to the vehicle’s paintwork and trim over time.
- Remove any exterior accessories, such as antennas, before entering a car wash.
- **Suntan lotions and insect repellents can damage any painted surface; if these substances come in contact with your vehicle, wash off as soon as possible.**
- **If your vehicle is equipped with running boards, do not use rubber, plastic and vinyl protectant products on the running board surface, as the area may become slippery.**

WAXING

Applying a polymer paint sealant to your vehicle every six months will assist in reducing minor scratches and paint damage.

- Wash the vehicle first.
- Do not use waxes that contain abrasives.
- Do not allow paint sealant to come in contact with any non-body (low-gloss black) colored trim, such as grained door handles, roof racks, bumpers, side moldings, mirror housings or the windshield cowl area. The paint sealant will “gray” or stain the parts over time.

286

PAINT CHIPS

Your dealer has touch-up paint and sprays to match your vehicle's color. Take your color code (printed on a sticker in the driver's door jam) to your dealer to ensure you get the correct color.

- Remove particles such as bird droppings, tree sap, insect deposits, tar spots, road salt and industrial fallout before repairing paint chips.
- Always read the instructions before using the products.

ALUMINUM WHEELS AND WHEEL COVERS

Aluminum wheels and wheel covers are coated with a clearcoat paint finish. In order to maintain their shine:

- Clean weekly with Motorcraft Wheel and Tire Cleaner (ZC-37-A), which is available from your dealer. Heavy dirt and brake dust accumulation may require agitation with a sponge. Rinse thoroughly with a strong stream of water.
- Never apply any cleaning chemical to hot or warm wheel rims or covers.
- Some automatic car washes may cause damage to the finish on your wheel rims or covers. Chemical-strength cleaners, or cleaning chemicals, in combination with brush agitation to remove brake dust and dirt, could wear away the clearcoat finish over time.
- Do not use hydrofluoric acid-based or high caustic-based wheel cleaners, steel wool, fuels or strong household detergent.
- To remove tar and grease, use Ford Extra Strength Tar and Road Oil Removal (B7A-19520-AA), available from your dealer.

ENGINE

Engines are more efficient when they are clean because grease and dirt buildup keep the engine warmer than normal. When washing:

- Take care when using a power washer to clean the engine. The high-pressure fluid could penetrate the sealed parts and cause damage.
- Do not spray a hot engine with cold water to avoid cracking the engine block or other engine components.
- Spray Motorcraft Engine Shampoo and Degreaser (ZC-20) on all parts that require cleaning and pressure rinse clean.

Cleaning

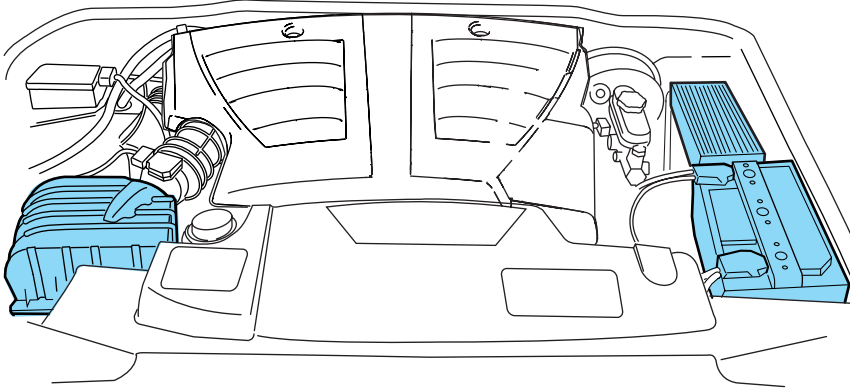

- Cover the highlighted areas to prevent water damage when cleaning the engine.
- Never wash or rinse the engine while it is running; water in the running engine may cause internal damage.

PLASTIC (NON-PAINTED) EXTERIOR PARTS

Use only approved products to clean plastic parts. These products are available from your dealer.

- For routine cleaning, use Motorcraft Detail Wash (ZC-3-A).
- If tar or grease spots are present, use Ford Extra Strength Tar and Road Oil Removal (B7A-19520-AA).

WINDOWS AND WIPER BLADES

The windshield, rear window and wiper blades should be cleaned regularly. If the wiper does not wipe properly, substances on the windshield, rear window or the wiper blades may be the cause. These may include hot wax treatments used by commercial car washes, tree sap, or other organic contamination. To clean these items, please follow these tips:

- The windshield or rear window may be cleaned with a non-abrasive cleaner such as Motorcraft Ultra Clear Spray Glass Cleaner (ZC-23), available from your dealer.
- Do not use abrasives, as they may cause scratches.
- Do not use fuel, kerosene, or paint thinner to clean any parts.

Cleaning

- Wiper blades can be cleaned with isopropyl (rubbing) alcohol or windshield washer solution. Be sure to replace wiper blades when they appear worn or do not function properly.

INSTRUMENT PANEL AND CLUSTER LENS

Clean the instrument panel with a damp cloth, then dry with a dry cloth.

- Avoid cleaners or polish that increase the gloss of the upper portion of the instrument panel. The dull finish in this area helps protect the driver from undesirable windshield reflection.



Do not use chemical solvents or strong detergents when cleaning the steering wheel or instrument panel to avoid contamination of the air bag system.

- Be certain to wash or wipe your hands clean if you have been in contact with certain products such as insect repellent and suntan lotion in order to avoid possible damage to the interior painted surfaces.

INTERIOR

For fabric, carpets, cloth seats, safety belts and seats equipped with side air bags:

- Remove dust and loose dirt with a vacuum cleaner.
- Remove light stains and soil with Ford Extra Strength Upholstery Cleaner (E8AZ-19523-AA).
- If grease or tar is present on the material, spot-clean the area first with Motorcraft Spot and Stain Remover (ZC-14).
- Never saturate the seat covers with cleaning solution.
- Do not use household cleaning products or glass cleaners, which can stain and discolor the fabric and affect the flame retardant abilities of the seat materials.



Do not use cleaning solvents, bleach or dye on the vehicle's safety belts, as these actions may weaken the belt webbing.



Do not use chemical solvents or strong detergents when cleaning the seat-mounted side air bag. Such products could contaminate the side air bag system and affect performance of the side air bag in a collision.

Cleaning

CLEANING THE CLIMATE CONTROLLED SEATS (IF EQUIPPED)

Remove dust and loose dirt with a whisk broom or a vacuum cleaner. Remove fresh spots immediately. Clean the seat with a damp cloth, using a mild soap and water solution, if necessary.

LEATHER SEATS

Your leather seating surfaces have a clear, protective coating over the leather.

- To clean, use a soft cloth with Motorcraft Deluxe Leather and Vinyl Cleaner (ZC-11-A). Dry the area with a soft cloth.
- To help maintain its resiliency and color, use the Motorcraft Deluxe Leather Care Kit (ZC-11-D), available from your authorized dealer.
- Do not use household cleaning products, alcohol solutions, solvents or cleaners intended for rubber, vinyl and plastics, or oil/petroleum-based leather conditioners. These products may cause premature wearing of the clear, protective coating.

INTERIOR TRIM

- Clean the interior trim areas with a damp cloth, then dry by wiping with a dry, soft, clean cloth.
- Do not use household or glass cleaners as these may damage the finish.

UNDERBODY

Flush the complete underside of your vehicle frequently. Keep body and door drain holes free from packed dirt.

FORD, LINCOLN AND MERCURY CAR CARE PRODUCTS

Your Ford, Lincoln or Mercury dealer has many quality products available to clean your vehicle and protect its finishes. These quality products have been specifically engineered to fulfill your automotive needs; they are custom designed to complement the style and appearance of your vehicle. Each product is made from high quality materials that meet or exceed rigid specifications. For best results, use the following products or products of equivalent quality:

Motorcraft Custom Clearcoat Polish (ZC-8-A)

Ford Custom Vinyl Protectant* (not available in Canada)
(F2AZ—19530-A)

Motorcraft Vinyl Cleaner (Canada only) (CXC-93)

290

Cleaning

Motorcraft Vinyl Conditioner (Canada only) (CXC-94)
Motorcraft Deluxe Leather and Vinyl Cleaner (not available in Canada)
(ZC-11-A)
Ford Extra Strength Tar and Road Oil Remover* (not available in
Canada) (B7A-19520-AA)
Ford Extra Strength Upholstery Cleaner (not available in Canada)
(E8AZ-19523-AA)
Motorcraft Custom Bright Metal Cleaner (ZC-15)
Motorcraft Wheel and Tire Cleaner (ZC-37-A)
Motorcraft Dash and Vinyl Cleaner (ZC-38-A)
Motorcraft Car Care Kit (ZC-26)
Ford Premium Car Wash Concentrate (F2SZ-19523-WC)
Motorcraft Carlite Glass Cleaner (Canada only) (CXC-100)
Motorcraft Spot and Stain Remover (ZC-14)
Motorcraft Detail Wash (ZC-3-A)
Motorcraft Tire Detailer (ZC-28)
Motorcraft Triple Clean (ZC-13)
Motorcraft Ultra-Clear Spray Glass Cleaner (not available in Canada)
(ZC-23)
Motorcraft Engine Shampoo and Degreaser (ZC-20)
* May be sold with the Motorcraft name

Maintenance and Specifications

SERVICE RECOMMENDATIONS

To help you service your vehicle:

- We highlight do-it-yourself items in the engine compartment for easy location.
- We provide a scheduled maintenance guide which makes tracking routine service easy.

If your vehicle requires professional service, your dealership can provide the necessary parts and service. Check your *Warranty Guide/Owner Information Guide* to find out which parts and services are covered.

Use only recommended fuels, lubricants, fluids and service parts conforming to specifications. Motorcraft parts are designed and built to provide the best performance in your vehicle.

PRECAUTIONS WHEN SERVICING YOUR VEHICLE

- Do not work on a hot engine.
- Make sure that nothing gets caught in moving parts.
- Do not work on a vehicle with the engine running in an enclosed space, unless you are sure you have enough ventilation.
- Keep all open flames and other lit material away from the battery and all fuel related parts.

Working with the engine off

1. Set the parking brake and shift to P (Park).
2. Turn off the engine and remove the key.
3. Block the wheels.

Working with the engine on

1. Set the parking brake and shift to P (Park).
2. Block the wheels.

Note: Do not start your engine with the air cleaner removed and do not remove it while the engine is running.

Maintenance and Specifications

OPENING THE HOOD

1. Inside the vehicle, pull the hood release handle.
2. Go to the front of the vehicle and release the latch located in the grille.
3. Lift the hood.

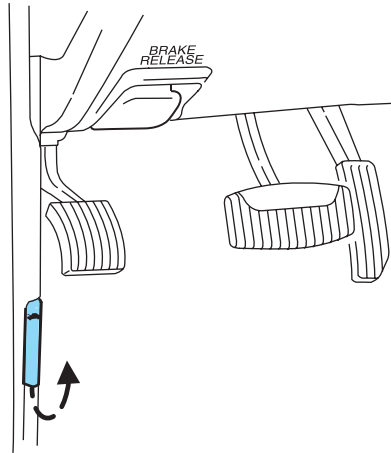

Maintenance and Specifications

IDENTIFYING COMPONENTS IN THE ENGINE COMPARTMENT

4.6L V8 engines

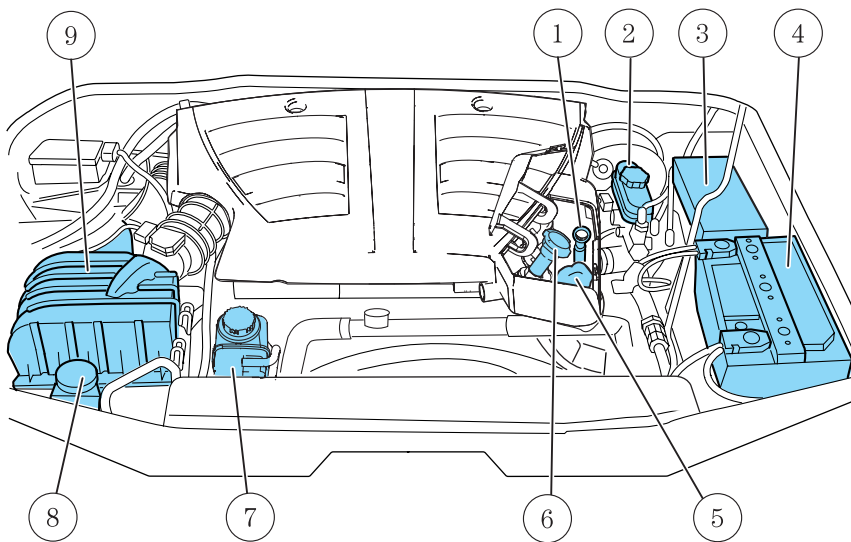

1. Engine oil dipstick
2. Brake fluid reservoir
3. Power distribution box
4. Battery
5. Power steering fluid reservoir
6. Engine oil filler cap
7. Engine coolant reservoir
8. Windshield washer fluid reservoir
9. Air filter assembly

Maintenance and Specifications

WINDSHIELD WASHER FLUID

Add fluid to fill the reservoir if the level is low. In very cold weather, do not fill the reservoir completely.

Only use a washer fluid that meets Ford specification WSB-M8B16-A2. Refer to *Lubricant specifications* in this chapter.

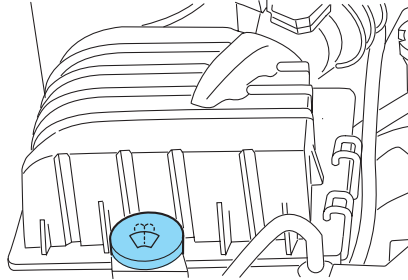

State or local regulations on volatile organic compounds may restrict the use of methanol, a common windshield washer antifreeze additive. Washer fluids containing non-methanol antifreeze agents should be used only if they provide cold weather protection without damaging the vehicle's paint finish, wiper blades or washer system.



If you operate your vehicle in temperatures below 4.5° C (40° F), use washer fluid with antifreeze protection. Failure to use washer fluid with antifreeze protection in cold weather could result in impaired windshield vision and increase the risk of injury or accident.

Note: Do not put washer fluid in the engine coolant reservoir. Washer fluid placed in the cooling system may harm engine and cooling system components.

Checking and adding washer fluid for the liftgate

Washer fluid for the liftgate is supplied by the same reservoir as the windshield.

ENGINE OIL

Checking the engine oil

Refer to the scheduled maintenance guide for the appropriate intervals for checking the engine oil.

1. Make sure the vehicle is on level ground.
2. Turn the engine off and wait a few minutes for the oil to drain into the oil pan.
3. Set the parking brake and ensure the gearshift is securely latched in P (Park).

Maintenance and Specifications

4. Open the hood. Protect yourself from engine heat.
5. Locate and carefully remove the engine oil level indicator (dipstick).

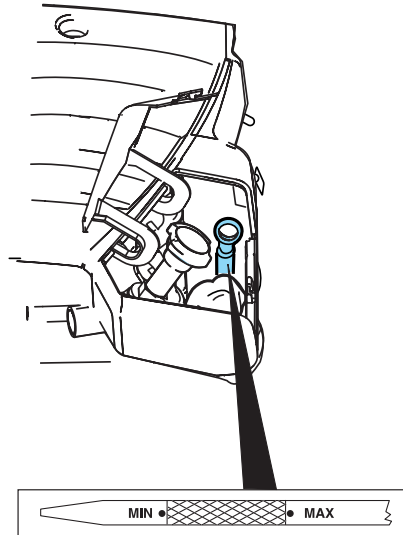

6. Wipe the indicator clean. Insert the indicator fully, then remove it again.
- If the oil level is **between the MIN and MAX marks**, the oil level is acceptable. **DO NOT ADD OIL.**

Maintenance and Specifications

- If the oil level is below the MIN mark, add enough oil to raise the level within the MIN-MAX range.

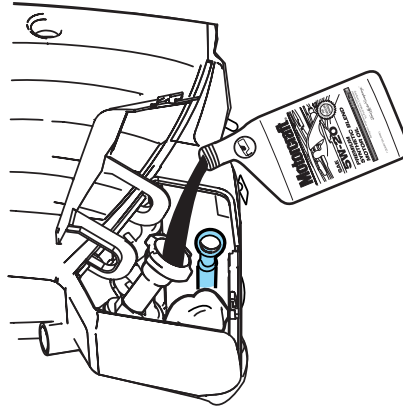

- Oil levels above the MAX mark may cause engine damage. Some oil must be removed from the engine by a service technician.
7. Put the indicator back in and ensure it is fully seated.

Adding engine oil

1. Check the engine oil. For instructions, refer to *Checking the engine oil* in this chapter.
2. If the engine oil level is not within the normal range, add only certified engine oil of the recommended viscosity. Remove the engine oil filler cap and use a funnel to pour the engine oil into the opening.
3. Recheck the engine oil level. Make sure the oil level is not above the MAX mark on the engine oil level indicator (dipstick).
4. Install the indicator and ensure it is fully seated.
5. Fully install the engine oil filler cap by turning the filler cap clockwise 1/4 of a turn until three clicks are heard or until the cap is fully seated.

To avoid possible oil loss, DO NOT operate the vehicle with the engine oil level indicator and/or the engine oil filler cap removed.

Maintenance and Specifications

Engine oil and filter recommendations

Look for this certification trademark.

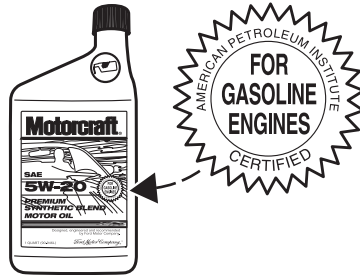

Use SAE 5W-20 engine oil.

Only use oils “Certified For Gasoline Engines” by the American Petroleum Institute (API). To protect your engine’s warranty use Motorcraft SAE 5W-20 or an equivalent 5W-20 oil meeting Ford specification WSS-M2C153-H. **SAE 5W-20 oil provides optimum fuel economy and durability performance meeting all requirements for your vehicle’s engine.**

Do not use supplemental engine oil additives, cleaners or other engine treatments. They are unnecessary and could lead to engine damage that is not covered by Ford warranty.

Change your engine oil according to the appropriate schedule listed in the scheduled maintenance guide.

Ford production and aftermarket (Motorcraft) oil filters are designed for added engine protection and long life. If a replacement oil filter is used that does not meet Ford material and design specifications, start-up engine noises or knock may be experienced.

It is recommended you use the appropriate Motorcraft oil filter (or another brand meeting Ford specifications) for your engine application.

Maintenance and Specifications

BATTERY

Your vehicle is equipped with a Motorcraft maintenance-free battery which normally does not require additional water during its life of service.

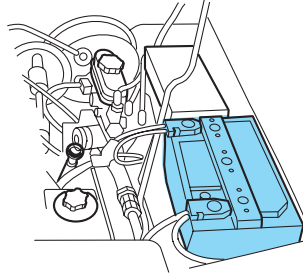

However, for severe usage or in high temperature climates, check the battery electrolyte level. Refer to the scheduled maintenance guide for the service interval schedules.

Keep the electrolyte level in each cell up to the “level indicator”. Do not overfill the battery cells.

If the electrolyte level in the battery is low, you can add plain tap water to the battery, as long as you do not use hard water (water with a high mineral or alkali content). If possible, however, try to only fill the battery cells with distilled water. If the battery needs water often, have the charging system checked.

If your battery has a cover/shield, make sure it is reinstalled after the battery has been cleaned or replaced.

For longer, trouble-free operation, keep the top of the battery clean and dry. Also, make certain the battery cables are always tightly fastened to the battery terminals.

If you see any corrosion on the battery or terminals, remove the cables from the terminals and clean with a wire brush. You can neutralize the acid with a solution of baking soda and water.

 Batteries normally produce explosive gases which can cause personal injury. Therefore, do not allow flames, sparks or lighted substances to come near the battery. When working near the battery, always shield your face and protect your eyes. Always provide proper ventilation.

Maintenance and Specifications



When lifting a plastic-cased battery, excessive pressure on the end walls could cause acid to flow through the vent caps, resulting in personal injury and/or damage to the vehicle or battery. Lift the battery with a battery carrier or with your hands on opposite corners.



Keep batteries out of reach of children. Batteries contain sulfuric acid. Avoid contact with skin, eyes or clothing. Shield your eyes when working near the battery to protect against possible splashing of acid solution. In case of acid contact with skin or eyes, flush immediately with water for a minimum of 15 minutes and get prompt medical attention. If acid is swallowed, call a physician immediately.



Battery posts, terminals and related accessories contain lead and lead compounds. **Wash hands after handling.**

Because your vehicle's engine is electronically controlled by a computer, some control conditions are maintained by power from the battery. When the battery is disconnected or a new battery is installed, the engine must relearn its idle and fuel trim strategy for optimum driveability and performance. To begin this process:

1. With the vehicle at a complete stop, set the parking brake.
 2. Put the gearshift lever in P (Park), turn off all accessories and start the engine.
 3. Run the engine until it reaches normal operating temperature.
 4. Allow the engine to idle for at least one minute.
 5. Turn the A/C on and allow the engine to idle for at least one minute.
 6. Drive the vehicle to complete the relearning process.
- The vehicle may need to be driven to relearn the idle and fuel trim strategy.
 - **If you do not allow the engine to relearn its idle trim, the idle quality of your vehicle may be adversely affected until the idle trim is eventually relearned.**

When the battery is disconnected or a new battery installed, the transmission must relearn its adaptive strategy. As a result of this, the transmission may shift firmly. This operation is considered normal and will not affect function or durability of the transmission. Over time the adaptive learning process will fully update transmission operation to its optimum shift feel.

300

Maintenance and Specifications

If the battery has been disconnected or a new battery has been installed, the clock and the preset radio stations must be reset once the battery is reconnected.

- Always dispose of automotive batteries in a responsible manner. Follow your local authorized standards for disposal. Call your local authorized recycling center to find out more about recycling automotive batteries.

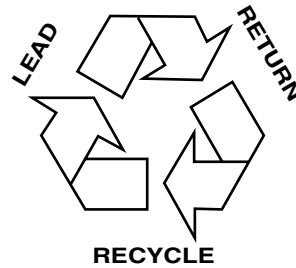

ENGINE COOLANT

Checking engine coolant

The concentration and level of engine coolant should be checked at the mileage intervals listed in the scheduled maintenance guide. The coolant concentration should be maintained at 50/50 coolant and distilled water, which equates to a freeze point of -36°C (-34°F). Coolant concentration testing is possible with a hydrometer or antifreeze tester (such as the Rotunda Battery and Antifreeze Tester, 014-R1060). The level of coolant should be maintained at the “cold full” or “cold fill range” level in the coolant reservoir. If the level falls below, refer to instructions in the *Adding engine coolant* section.

Your vehicle was factory-filled with a 50/50 engine coolant and water concentration. If the concentration of coolant falls below 40% or above 60%, the engine parts could become damaged or not work properly. **A 50–50 mixture of coolant and water provides the following:**

- **Freeze protection down to -36°C (-34°F).**
- **Boiling protection up to 129°C (265°F).**
- **Protection against rust and other forms of corrosion.**
- **Enables calibrated gauges to work properly.**

Maintenance and Specifications

When the engine is cold, check the level of the engine coolant in the reservoir.

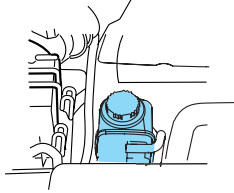

- The engine coolant should be at the “cold fill level” or within the “cold fill range” as listed on the engine coolant reservoir (depending upon application).
- Refer to the Scheduled Maintenance Guide for service interval schedules.
- Be sure to read and understand *Precautions when servicing your vehicle* in this chapter.

If the engine coolant has not been checked at the recommended interval, the engine coolant reservoir may become low or empty. If the reservoir is low or empty, refer to *Adding engine coolant* in this chapter.

Note: Automotive fluids are not interchangeable; do not use engine coolant, antifreeze or windshield washer fluid outside of its specified function and vehicle location.

The cooling system in your vehicle is originally equipped with either:

- Green-colored Motorcraft Premium Engine Coolant, VC-4-A (U.S.) or CXC-10 (Canada) meeting Ford specification ESE-M97B44-A or,
- Yellow-colored Motorcraft Premium Gold Engine Coolant, VC-7-A (VC-7-B in Oregon), meeting Ford Specification WSS-M97B51-A1.

If you are unsure which type of coolant your vehicle requires, check your coolant reservoir or contact your local dealer.

Note: Use of Motorcraft Cooling System Stop Leak Pellets, VC-6, darkens the color of Motorcraft Premium Gold Engine Coolant from yellow to golden tan.

- **Do not add/mix an orange-colored, extended life coolant such as Motorcraft Speciality Orange Engine Coolant, VC-2 (US) or CXC-209 (Canada), meeting Ford specification WSS-M97B44-D with the factory-filled coolant.** Mixing Motorcraft Speciality Orange Engine Coolant or any orange-colored extended life product with your factory filled coolant can result in degraded corrosion protection.

Maintenance and Specifications

- A large amount of water without engine coolant may be added, in case of emergency, to reach a vehicle service location. In this instance, the cooling system must be drained and refilled with a 50/50 mixture of engine coolant and distilled water as soon as possible. Water alone (without engine coolant) can cause engine damage from corrosion, overheating or freezing.
- **Do not use** alcohol, methanol, brine, extra inhibitors or additives in the coolant system. These can cause engine damage.
- Do not mix with recycled coolant unless from a Ford-approved recycling process (see *Use of Recycled engine coolant* section).

Adding engine coolant

Only a qualified technician should add engine coolant to your vehicle. If the coolant level is LOW or if there are any coolant system problems, contact your local Lincoln dealer.



Do not put engine coolant in the windshield washer fluid container. If sprayed on the windshield, engine coolant could make it difficult to see through the windshield.



Do not add engine coolant when the engine is hot. Steam and scalding liquids released from a hot cooling system can burn you badly. Also, you can be burned if you spill coolant on hot engine parts.

Recycled engine coolant

Ford Motor Company does NOT recommend the use of recycled engine coolant in vehicles originally equipped with Motorcraft Premium Gold Engine Coolant since a Ford-approved recycling process is not yet available.



Used engine coolant should be disposed of in an appropriate manner. Follow your community's regulations and standards for recycling and disposing of automotive fluids.

Coolant refill capacity

To find out how much fluid your vehicle's cooling system can hold, refer to *Refill capacities* in this chapter.

Maintenance and Specifications

Severe climates

If you drive in extremely cold (less than -36°C [-34°F]) or extremely hot climates, it may be necessary to adjust the coolant concentration levels.

- **Extreme cold:** increase the coolant concentration above 50%. **NEVER increase the coolant concentration above 60%.**
- **Extreme hot:** it is acceptable to decrease the coolant concentration below 50%. **NEVER decrease the coolant concentration below 40%.**

The coolant concentration in severe climates must always be between 40% and 60%. Coolant concentrations not within the 40%-60% range may cause engine damage.



Refer to the chart on the coolant container to ensure the coolant concentration in your vehicle will provide adequate protection at the temperatures in which you drive.

What you should know about fail-safe cooling

If the engine coolant supply is depleted, this feature allows the vehicle to be driven temporarily before incremental component damage is incurred. The “fail-safe” distance depends on ambient temperatures, vehicle load and terrain.

How fail-safe cooling works

If the engine begins to overheat:

- The engine coolant temperature gauge will move to the red (hot) area.
- The  and the  symbol will illuminate.
- The “Service Engine Soon” indicator light will illuminate.

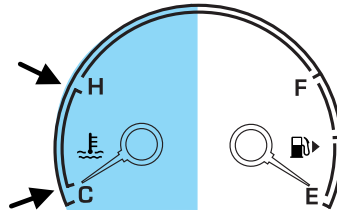

If the engine reaches a preset over-temperature condition, the engine will automatically switch to alternating cylinder operation. Each disabled cylinder acts as an air pump and cools the engine.

When this occurs the vehicle will still operate. However:

- The engine power will be limited.
- The air conditioning system will be disabled.

Maintenance and Specifications

Continued operation will increase the engine temperature:

- The engine will completely shut down.
- Steering and braking effort will increase.

Once the engine temperature cools, the engine can be re-started. Take your vehicle to a service facility as soon as possible to minimize engine damage.

When fail-safe mode is activated

You have limited engine power when in the fail-safe mode, so drive the vehicle with caution. The vehicle will not be able to maintain high speed operation and the engine will run rough. Remember that the engine is capable of completely shutting down automatically to prevent engine damage, therefore:

1. Pull off the road as soon as safely possible and turn off the engine.
2. Arrange for the vehicle to be taken to a service facility.
3. If this is not possible, wait a short period for the engine to cool.
4. Check the coolant level and replenish if low.



Never remove the coolant reservoir cap while the engine is running or hot.

5. Restart the engine and take your vehicle to a service facility.

Driving the vehicle without repairing the engine problem increases the chance of engine damage. Take your vehicle to a service facility as soon as possible.

WHAT YOU SHOULD KNOW ABOUT AUTOMOTIVE FUELS

Important safety precautions





Do not overfill the fuel tank. The pressure in an overfilled tank may cause leakage and lead to fuel spray and fire.



The fuel system may be under pressure. If the fuel filler cap is venting vapor or if you hear a hissing sound, wait until it stops before completely removing the fuel filler cap. Otherwise, fuel may spray out and injure you or others.

Maintenance and Specifications

 If you do not use the proper fuel filler cap, excessive pressure or vacuum in the fuel tank may damage the fuel system or cause the fuel cap to disengage in a collision, which may result in possible personal injury.

 Automotive fuels can cause serious injury or death if misused or mishandled.

 Gasoline may contain benzene, which is a cancer-causing agent.

Observe the following guidelines when handling automotive fuel:

- Extinguish all smoking materials and any open flames before fueling your vehicle.
- Always turn off the vehicle before fueling.
- Automotive fuels can be harmful or fatal if swallowed. Fuel such as gasoline is highly toxic and if swallowed can cause death or permanent injury. If fuel is swallowed, call a physician immediately, even if no symptoms are immediately apparent. The toxic effects of fuel may not be visible for hours.
- Avoid inhaling fuel vapors. Inhaling too much fuel vapor of any kind can lead to eye and respiratory tract irritation. In severe cases, excessive or prolonged breathing of fuel vapor can cause serious illness and permanent injury.
- Avoid getting fuel liquid in your eyes. If fuel is splashed in the eyes, remove contact lenses (if worn), flush with water for 15 minutes and seek medical attention. Failure to seek proper medical attention could lead to permanent injury.
- Fuels can also be harmful if absorbed through the skin. If fuel is splashed on the skin and/or clothing, promptly remove contaminated clothing and wash skin thoroughly with soap and water. Repeated or prolonged skin contact with fuel liquid or vapor causes skin irritation.
- Be particularly careful if you are taking “Antabuse” or other forms of disulfiram for the treatment of alcoholism. Breathing gasoline vapors, or skin contact could cause an adverse reaction. In sensitive individuals, serious personal injury or sickness may result. If fuel is



Maintenance and Specifications

splashed on the skin, promptly wash skin thoroughly with soap and water. Consult a physician immediately if you experience an adverse reaction.

 When refueling always shut the engine off and never allow sparks or open flames near the filler neck. Never smoke while refueling. Fuel vapor is extremely hazardous under certain conditions. Care should be taken to avoid inhaling excess fumes.

 The flow of fuel through a fuel pump nozzle can produce static electricity, which can cause a fire if fuel is pumped into an ungrounded fuel container.

Use the following guidelines to avoid static build-up when filling an ungrounded fuel container:

- Place approved fuel container on the ground.
- DO NOT fill a fuel container while it is in the vehicle (including the cargo area).
- Keep the fuel pump nozzle in contact with the fuel container while filling.
- DO NOT use a device that would hold the fuel pump handle in the fill position.

Fuel Filler Cap

Your fuel tank filler cap has an indexed design with a 1/8 turn on/off feature.

When fueling your vehicle:

1. Turn the engine off.
2. Carefully turn the filler cap counterclockwise 1/8 of a turn until it stops.
3. Pull to remove the cap from the fuel filler pipe.
4. To install the cap, align the tabs on the cap with the notches on the filler pipe.
5. Turn the filler cap clockwise 1/8 of a turn until it stops.

“CHECK/TIGHTEN FUEL CAP” will display in the message center when the fuel filler cap is not properly installed. Proper fuel filler cap installation is checked automatically as the vehicle is driven, but not until

Maintenance and Specifications

after some fuel is used (fuel gauge drops below full). Once the fuel filler cap is properly secured, "CHECK/TIGHTEN FUEL CAP" will turn off after a short period of driving.

If you must replace the fuel filler cap, replace it with a fuel filler cap that is designed for your vehicle. The customer warranty may be void for any damage to the fuel tank or fuel system if the correct genuine Ford or Motorcraft fuel filler cap is not used.



The fuel system may be under pressure. If the fuel filler cap is venting vapor or if you hear a hissing sound, wait until it stops before completely removing the fuel filler cap. Otherwise, fuel may spray out and injure you or others.



If you do not use the proper fuel filler cap, excessive pressure or vacuum in the fuel tank may damage the fuel system or cause the fuel cap to disengage in a collision, which may result in possible personal injury.

Choosing the right fuel

Use only UNLEADED FUEL. The use of leaded fuel is prohibited by law and could damage your vehicle.

Do not use fuel containing methanol. It can damage critical fuel system components.

Your vehicle was not designed to use fuel or fuel additives with metallic compounds, including manganese-based compounds containing MMT.

Repairs to correct the effects of using a fuel for which your vehicle was not designed may not be covered by your warranty.

Octane recommendations

Your vehicle is designed to use "Premium" unleaded gasoline with an (R+M)/2 octane rating of 91 or higher for optimum performance.

The use of gasolines with lower octane ratings may degrade performance. The use of gasolines labeled as "Premium" in high altitude areas that are sold with octane ratings of less than 91 is not recommended.

Do not be concerned if your engine sometimes knocks lightly. However, if it knocks heavily under most driving conditions while you are using fuel

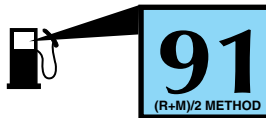

Maintenance and Specifications

with the recommended octane rating, see your dealer or a qualified service technician to prevent any engine damage.

Fuel quality

If you are experiencing starting, rough idle or hesitation driveability problems during a cold start, try a different brand of gasoline. If the problems persist, see your dealer or a qualified service technician.

It should not be necessary to add any aftermarket products to your fuel tank if you continue to use high quality fuel of the recommended octane rating. Aftermarket products could cause damage to the fuel system. Repairs to correct the effects of using an aftermarket product in your fuel may not be covered by your warranty.

Many of the world's automakers issued the World-wide Fuel Charter that recommends gasoline specifications to provide improved performance and emission control system protection for your vehicle. Gasolines that meet the World-wide Fuel Charter should be used when available. Ask your fuel supplier about gasolines that meet the World-wide Fuel Charter.

Cleaner air

Ford endorses the use of reformulated "cleaner-burning" gasolines to improve air quality.

Running out of fuel

Avoid running out of fuel because this situation may have an adverse affect on powertrain components.

If you have run out of fuel:

- You may need to cycle the ignition from OFF to ON several times after refueling, to allow the fuel system to pump the fuel from the tank to the engine.
- Your "Service Engine Soon" indicator may come on. For more information on the "Service Engine Soon" indicator, refer to the *Instrument cluster* chapter.

Fuel Filter

For fuel filter replacement, see your dealer or a qualified service technician. Refer to the scheduled maintenance guide for the appropriate intervals for changing the fuel filter.

Replace the fuel filter with an authorized Motorcraft part. The customer warranty may be void for any damage to the fuel system if an authorized Motorcraft fuel filter is not used.

Maintenance and Specifications

ESSENTIALS OF GOOD FUEL ECONOMY

Measuring techniques

Your best source of information about actual fuel economy is you, the driver. You must gather information as accurately and consistently as possible. Fuel expense, frequency of fill-ups or fuel gauge readings are NOT accurate as a measure of fuel economy. We do not recommend taking fuel economy measurements during the first 1,600 km (1,000 miles) of driving (engine break-in period). You will get a more accurate measurement after 3,000 km–5,000 km (2,000 miles–3,000 miles).

Filling the tank

The advertised fuel capacity of the fuel tank on your vehicle is equal to the rated refill capacity of the fuel tank as listed in the *Refill capacities* section of this chapter.

The advertised capacity is the amount of the indicated capacity and the empty reserve combined. Indicated capacity is the difference in the amount of fuel in a full tank and a tank when the fuel gauge indicates empty. Empty reserve is the small amount of fuel remaining in the fuel tank after the fuel gauge indicates empty.

The amount of usable fuel in the empty reserve varies and should not be relied upon to increase driving range. When refueling your vehicle after the fuel gauge indicates empty, you might not be able to refuel the full amount of the advertised capacity of the fuel tank due to the empty reserve still present in the tank.

For consistent results when filling the fuel tank:

- Turn the engine/ignition switch to the off position prior to refueling, an error in the reading will result if the engine is left running.
- Use the same filling rate setting (low — medium — high) each time the tank is filled.
- Allow no more than 2 automatic click-offs when filling.
- Always use fuel with the recommended octane rating.
- Use a known quality gasoline, preferably a national brand.
- Use the same side of the same pump and have the vehicle facing the same direction each time you fill up.
- Have the vehicle loading and distribution the same every time.

Your results will be most accurate if your filling method is consistent.

Maintenance and Specifications

Calculating fuel economy

1. Fill the fuel tank completely and record the initial odometer reading (in kilometers or miles).
2. Each time you fill the tank, record the amount of fuel added (in liters or gallons).
3. After at least three to five tank fill-ups, fill the fuel tank and record the current odometer reading.
4. Subtract your initial odometer reading from the current odometer reading.
5. Follow one of the simple calculations in order to determine fuel economy:

Calculation 1: **Multiply liters used by 100, then divide by total kilometers traveled.**

Calculation 2: **Divide total miles traveled by total gallons used.**

Keep a record for at least one month and record the type of driving (city or highway). This will provide an accurate estimate of the vehicle's fuel economy under current driving conditions. Additionally, keeping records during summer and winter will show how temperature impacts fuel economy. In general, lower temperatures give lower fuel economy.

Driving style — good driving and fuel economy habits

Give consideration to the lists that follow and you may be able to change a number of variables and improve your fuel economy.

Habits

- Smooth, moderate operation can yield up to 10% savings in fuel.
- Steady speeds without stopping will usually give the best fuel economy.
- Idling for long periods of time (greater than one minute) may waste fuel.
- Anticipate stopping; slowing down may eliminate the need to stop.
- Sudden or hard accelerations may reduce fuel economy.
- Slow down gradually.
- Driving at reasonable speeds (traveling at 88 km/h [55 mph] uses 15% less fuel than traveling at 105 km/h [65 mph]).
- Revving the engine before turning it off may reduce fuel economy.
- Using the air conditioner or defroster may reduce fuel economy.

Maintenance and Specifications

- You may want to turn off the speed control in hilly terrain if unnecessary shifting between gears occurs. Unnecessary shifting of this type could result in reduced fuel economy.
- Warming up a vehicle on cold mornings is not required and may reduce fuel economy.
- Resting your foot on the brake pedal while driving may reduce fuel economy.
- Combine errands and minimize stop-and-go driving.

Maintenance

- Keep tires properly inflated and use only recommended size.
- Operating a vehicle with the wheels out of alignment will reduce fuel economy.
- Use recommended engine oil. Refer to *Lubricant specifications* in this chapter.
- Perform all regularly scheduled maintenance items. Follow the recommended maintenance schedule and owner maintenance checks found in your vehicle scheduled maintenance guide.

Conditions

- Heavily loading a vehicle or towing a trailer may reduce fuel economy at any speed.
- Carrying unnecessary weight may reduce fuel economy (approximately 0.4 km/L [1 mpg] is lost for every 180 kg [400 lb] of weight carried).
- Adding certain accessories to your vehicle (for example bug deflectors, rollbars/light bars, running boards, ski/luggage racks) may reduce fuel economy.
- Using fuel blended with alcohol may lower fuel economy.
- Fuel economy may decrease with lower temperatures during the first 12–16 km (8–10 miles) of driving.
- Driving on flat terrain offers improved fuel economy as compared to driving on hilly terrain.
- Transmissions give their best fuel economy when operated in the top cruise gear and with steady pressure on the gas pedal.
- Close windows for high speed driving.

Maintenance and Specifications

EPA window sticker

Every new vehicle should have the EPA window sticker. Contact your dealer if the window sticker is not supplied with your vehicle. The EPA window sticker should be your guide for the fuel economy comparisons with other vehicles.

It is important to note the box in the lower left corner of the window sticker. These numbers represent the Range of L/100 km (MPG) expected on the vehicle under optimum conditions. Your fuel economy may vary depending upon the method of operation and conditions.

EMISSION CONTROL SYSTEM

Your vehicle is equipped with various emission control components and a catalytic converter which will enable your vehicle to comply with applicable exhaust emission standards. To make sure that the catalytic converter and other emission control components continue to work properly:

- Use only the specified fuel listed.
- Avoid running out of fuel.
- Do not turn off the ignition while your vehicle is moving, especially at high speeds.
- Have the items listed in your scheduled maintenance guide performed according to the specified schedule.

The scheduled maintenance items listed in the scheduled maintenance guide are essential to the life and performance of your vehicle and to its emissions system.

If other than Ford, Motorcraft or Ford-authorized parts are used for maintenance replacements or for service of components affecting emission control, such non-Ford parts should be equivalent to genuine Ford Motor Company parts in performance and durability.



Do not park, idle, or drive your vehicle in dry grass or other dry ground cover. The emission system heats up the engine compartment and exhaust system, which can start a fire.

Illumination of the “Check Engine” light, charging system warning light or the temperature warning light, fluid leaks, strange odors, smoke or loss of engine power, could indicate that the emission control system is not working properly.

Maintenance and Specifications



Exhaust leaks may result in entry of harmful and potentially lethal fumes into the passenger compartment.

Do not make any unauthorized changes to your vehicle or engine. By law, vehicle owners and anyone who manufactures, repairs, services, sells, leases, trades vehicles, or supervises a fleet of vehicles are not permitted to intentionally remove an emission control device or prevent it from working. Information about your vehicle's emission system is on the Vehicle Emission Control Information Decal located on or near the engine. This decal identifies engine displacement and gives some tune up specifications.

Please consult your *Warranty Guide* for complete emission warranty information.

Readiness for Inspection/Maintenance (I/M) testing

In some localities, it may be a legal requirement to pass an I/M test of the on-board diagnostics system. If your "Check Engine/Service Engine Soon" light is on, refer to the description in the *Warning lights and chimes* section of the *Instrument cluster* chapter. Your vehicle may not pass the I/M test with the "Check Engine/Service Engine Soon" light on.

If the vehicle's powertrain system or its battery has just been serviced, the on-board diagnostics system is reset to a "not ready for I/M test" condition. To ready the on-board diagnostics system for I/M testing, a minimum of 30 minutes of city and highway driving is necessary as described below:

- First, at least 10 minutes of driving on an expressway or highway.
- Next, at least 20 minutes driving in stop-and-go, city-type traffic with at least four idle periods.

Allow the vehicle to sit for at least eight hours without starting the engine. Then, start the engine and complete the above driving cycle. The engine must warm up to its normal operating temperature. Once started, do not turn off the engine until the above driving cycle is complete.

CHECKING AND ADDING POWER STEERING FLUID

Check the power steering fluid. Refer to the scheduled maintenance guide for the service interval schedules. If adding fluid is necessary, use only Ford Premium Power Steering Fluid or MERCON® ATF.

Maintenance and Specifications

1. Start the engine and let it run until it reaches normal operating temperature (the engine coolant temperature gauge indicator will be near the center of the normal area between H and C).
2. While the engine idles, turn the steering wheel left and right several times.
3. Turn the engine off.



4. Check the fluid level in the reservoir. It should be between the MIN and MAX lines. Do not add fluid if the level is in this range.
5. If the fluid is low, add fluid in small amounts, continuously checking the level until it reaches the range between the MIN and MAX lines. Be sure to put the cap back on the reservoir.

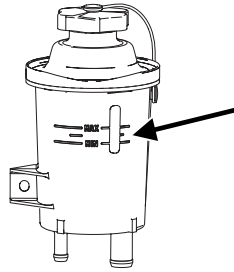

BRAKE FLUID RESERVOIR

The fluid level will drop slowly as the brakes wear, and will rise when the brake components are replaced. Fluid levels below the “MAX” line that do not trigger the brake system warning lamp are within the normal operating range, there is no need to add fluid. If the fluid levels are outside of the normal operating range, the performance of your brake system could be compromised, seek service from your dealer immediately.

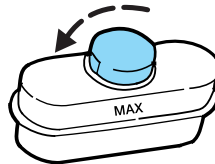

Maintenance and Specifications

TRANSMISSION FLUID

Checking automatic transmission fluid

The automatic transmission does not have a transmission fluid dipstick. Refer to your scheduled maintenance guide for scheduled intervals for fluid checks and changes. Your transmission does not consume fluid. However, the fluid level should be checked if the transmission is not working properly, (i.e., if the transmission slips or shifts slowly) or if you notice some sign of fluid leakage.

Transmission fluid should be checked and, if required, fluid should be added by a qualified technician.

Do not use supplemental transmission fluid additives, treatments or cleaning agents. The use of these materials may affect transmission operation and result in damage to internal transmission components.

INFORMATION ABOUT UNIFORM TIRE QUALITY GRADING

New vehicles are fitted with tires that have a rating on them called Tire Quality Grades. The Quality grades can be found where applicable on the tire sidewall between tread shoulder and maximum section width. For example:

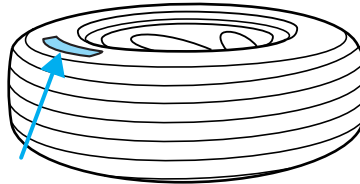

- **Treadwear 200 Traction AA Temperature A**

These Tire Quality Grades are determined by standards that the United States Department of Transportation has set.

Tire Quality Grades apply to new pneumatic tires for use on passenger cars. They do not apply to deep tread, winter-type snow tires, space-saver or temporary use spare tires, tires with nominal rim diameters of 10 to 12 inches or limited production tires as defined in Title 49 Code of Federal Regulations Part 575.104(c)(2).

U.S. Department of Transportation-Tire quality grades: The U.S. Department of Transportation requires Ford to give you the following information about tire grades exactly as the government has written it.

Treadwear

The treadwear grade is a comparative rating based on the wear rate of the tire when tested under controlled conditions on a specified

Maintenance and Specifications

government test course. For example, a tire graded 150 would wear one and one-half (1 1/2) times as well on the government course as a tire graded 100. The relative performance of tires depends upon the actual conditions of their use, however, and may depart significantly from the norm due to variations in driving habits, service practices, and differences in road characteristics and climate.

Traction AA A B C

The traction grades, from highest to lowest are AA, A, B, and C. The grades represent the tire's ability to stop on wet pavement as measured under controlled conditions on specified government test surfaces of asphalt and concrete. A tire marked C may have poor traction performance.



The traction grade assigned to this tire is based on straight-ahead braking traction tests, and does not include acceleration, cornering, hydroplaning or peak traction characteristics.

Temperature A B C

The temperature grades are A (the highest), B and C, representing the tire's resistance to the generation of heat and its ability to dissipate heat when tested under controlled conditions on a specified indoor laboratory test wheel. Sustained high temperature can cause the material of the tire to degenerate and reduce tire life, and excessive temperature can lead to sudden tire failure. The grade C corresponds to a level of performance which all passenger car tires must meet under the Federal Motor Vehicle Safety Standard No. 109. Grades B and A represent higher levels of performance on the laboratory test wheel than the minimum required by law.



The temperature grade for this tire is established for a tire that is properly inflated and not overloaded. Excessive speed, underinflation, or excessive loading, either separately or in combination, can cause heat buildup and possible tire failure.

SERVICING YOUR TIRES

Checking the tire pressure

- Use an accurate tire pressure gauge.
- Check the tire pressure when tires are **cold**, after the vehicle has been parked for at least 3 hours or has been driven less than 5 km (3 miles). As you drive, the temperature in the tire warms up, increasing the tire pressure.

Maintenance and Specifications

- Adjust tire pressure to recommended specifications found on the Certification Label. Tire pressure information can also be found on the Tire Information label located on the inside of the fuel filler door.
- Check tires for proper air pressure monthly. Check spare tire for proper air pressure every six months.

Check that the externally mounted spare tire is tight. Refer to *Stowing the flat/spare tire* of the tire changing section in the *Roadside Emergencies* chapter



Improperly inflated tires can affect vehicle handling and can fail suddenly, possibly resulting in loss of vehicle control, vehicle rollover and/or personal injury.

Tire rotation

Because your vehicle's tires perform different jobs, they often wear differently. To make sure your tires wear evenly and last longer, rotate them as indicated in the scheduled maintenance guide. If you notice that the tires wear unevenly, have them checked.

- Four tire rotation

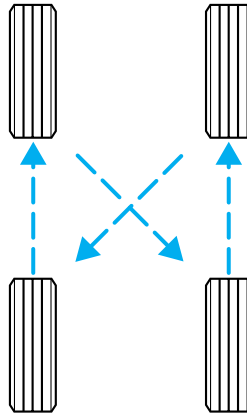



Maintenance and Specifications

Replacing the tires

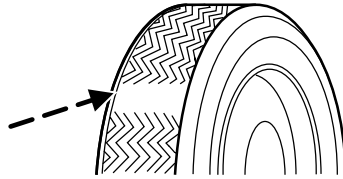
Replace the tires when the wear band is visible through the tire treads. Due to exposure to the elements and exhaust you should replace the spare tire when you replace the other tires.



 When replacing full size tires, never mix radial bias-belted, or bias-type tires. Use only the tire sizes that are listed on the Certification Label. Make sure that all tires are the same size, speed rating, and load-carrying capacity. Use only the tire combinations recommended on the label. If you do not follow these precautions, your vehicle handling may be affected which can lead to loss of vehicle control, vehicle rollover and/or personal injury.

 Make sure that all replacement tires are of the same size, type, speed rating, load-carrying capacity and tread design (e.g., “All Terrain”, “Touring”, etc.), as originally offered by Ford.

 Do not replace your tires with “high performance” tires or larger size tires.

 Failure to follow these precautions may adversely affect the handling of the vehicle, and increase the risk of loss of vehicle control, vehicle rollover and/or personal injury.

Tires that are larger or smaller than your vehicle’s original tires may also affect the accuracy of your speedometer.

SNOW TIRES AND CHAINS

 Snow tires must be the same size and grade as the tires you currently have on your vehicle.

The tires on your vehicle have all weather treads to provide traction in rain and snow. However, in some climates, you may need to use snow tires and chains.

Maintenance and Specifications

Follow these guidelines when using snow tires and chains:

- Use only cable type chains or chains offered by Ford as an accessory or equivalent. Other conventional link type chains may contact and cause damage to the vehicle's wheel house and/or body.
- Do not install chains on the front wheels. Chains on the front wheels may interfere with suspension components.
- Install chains securely, verifying that the chains do not touch any wiring, brake lines or fuel lines.
- Drive cautiously. If you hear the chains rub or bang against your vehicle, stop and re-tighten the chains. If this does not work, remove the chains to prevent damage to your vehicle.
- If possible, avoid fully loading your vehicle.
- Remove the tire chains when they are no longer needed. Do not use tire chains on dry roads.
- The suspension insulation and bumpers will help prevent vehicle damage. Do not remove these components from your vehicle when using snow tires and chains.
- Do not exceed 48 km/h (30 mph) with tire chains on your vehicle.

MOTORCRAFT PART NUMBERS

Component	4.6L DOHC V8 engine
Engine air filter element	FA-1695
Fuel filter	FG-1068
Battery	BXT-65-650
Oil filter	FL-820-S
PCV valve	EV-261
Spark plugs*	AWSF-32EM

* Refer to Vehicle Emissions Control Information (VECI) decal for spark plug gap information.

Maintenance and Specifications

REFILL CAPACITIES

Fluid	Ford Part Name	Application	Capacity
Brake fluid	Motorcraft High Performance DOT 3 Motor Vehicle Brake Fluid	All	Fill to max line on reservoir
Engine oil (including filter change) ⁵	Motorcraft SAE 5W-20 Premium Synthetic Blend Motor Oil (US) Motorcraft SAE 5W-20 Super Premium Motor Oil (Canada)	4.6L	5.7L (6.0 quarts)
Fuel tank	N/A	All	85.2L (22.5 gallons)
Power steering fluid	Motorcraft MERCON® ATF	All	Fill between the MIN and MAX lines on reservoir
Transmission fluid ¹	Motorcraft MERCON®V ATF	Automatic transmissions only.	10.4L (11.4 quarts) ²
Transfer case	Motorcraft MERCON® ATF	AWD	1.25L (1.3 quarts)
		4WD	1.4L (1.5 quarts)
Engine coolant ³	Motorcraft Premium Gold Engine Coolant (yellow-colored)	4.6L	19.0L (20.1 quarts)

Maintenance and Specifications

Fluid	Ford Part Name	Application	Capacity
Front axle lubricant	Motorcraft SAE 80W-90 Premium Rear Axle Lubricant	4x4/AWD vehicles	1.3L (1.4 quarts)
Rear axle lubricant ⁴	Motorcraft SAE 75W-140 High Performance Synthetic Rear Axle Lubricant	Conventional Axle	1.7L (3.5 pints)
Windshield washer fluid	Motorcraft Ultra-Clear Windshield Washer Concentrate	All	4.0L (4.2 quarts)

¹Ensure the correct automatic transmission fluid is used. MERCON® and MERCON® V are not interchangeable. DO NOT mix MERCON® and MERCON® V. Refer to your scheduled maintenance guide to determine the correct service interval.

²Indicates only approximate dry-fill capacity. Some applications may vary based on cooler size and if equipped with an in-tank cooler. The amount of transmission fluid and fluid level should be checked by a qualified technician.

³Add the coolant type originally equipped in your vehicle.

⁴All rear axles are filled with Motorcraft SAE 75W-140 High Performance Synthetic Rear Axle Lubricant, part number XY—75W140—QL or equivalent meeting Ford Specification WSL-M2C192-A.

⁵Use of synthetic or synthetic blend motor oil is not mandatory. Engine oil need only meet the requirements of Ford specification WSS-M2C153-H and the API Certification mark.

Maintenance and Specifications

LUBRICANT SPECIFICATIONS

Item	Ford Part Name or equivalent	Ford Part Number	Ford Specification
Body hinges, latches, door striker plates and rotors, seat tracks, fuel filler door hinge and spring, hood latch, auxiliary latch, seat tracks	Multi-Purpose Grease or Multi-Purpose Grease Spray	XG-4 or F5AZ-19G209-AA	ESR-M1C159-A
Brake fluid	Motorcraft High Performance DOT 3 Motor Vehicle Brake Fluid	PM-1	ESA-M6C25-A, DOT 3
Driveshaft, slip spline, universal joints	Motorcraft Premium Long Life Grease	XG-1-C or XG-1-K	ESA-M1C75-B
Engine coolant	Motorcraft Premium Gold Engine Coolant (yellow-colored)	VC-7-A	WSS-M97B51-A1
Engine oil	Motorcraft SAE 5W20 Premium Synthetic Blend Motor Oil (US) Motorcraft SAE 5W-20 Super Premium Motor Oil (Canada)	XO-5W20-QSP (US) CXO-5W20-LSP12 (Canada)	WSS-M2C153-H with API Certification Mark

Maintenance and Specifications

Item	Ford Part Name or equivalent	Ford Part Number	Ford Specification
Automatic transmission ¹	Motorcraft MERCON®V ATF	XT-5-QM	MERCON®V
Power steering fluid	Motorcraft MERCON® Multi-Purpose ATF	XT-2-QDX	MERCON®
Rear axles	75W-140 High performance synthetic rear axle lubricant	XY-75W140-QL	WSL-M2C192-A
Front axle (AWD)	Motorcraft SAE 80W-90 Premium Rear Axle Lubricant	XY-80W90-QL	WSP-M2C197-A
Transfer case (AWD)	Motorcraft MERCON® Multi-Purpose ATF	XT-2-QDX	MERCON®
Transfer case Front Output Slip Shaft	Motorcraft Premium Long-Life Grease	XG-1-C or XG-1-K	ESA-M1C75-B
Windshield washer fluid	Motorcraft Ultra-clear Windshield Washer Concentrate	ZC—18-A	ESR-M17P5-A

¹Ensure the correct automatic transmission fluid is used. MERCON® and MERCON® V are not interchangeable. DO NOT mix MERCON® and MERCON® V. Refer to your scheduled maintenance guide to determine the correct service interval.

Maintenance and Specifications

ENGINE DATA

VEHICLE DIMENSIONS

Vehicle dimensions	mm (in)
(1) Overall length	4909 (193.3)
(2) Vehicle width (body)	1877 (73.9)
(3) Vehicle width (including mirrors)	2132 (83.9)
(4) Maximum height*	1813.5 (71.4)
(5) Wheelbase	2889 (113.7)
(6) Track width, front	1547 (60.9)
(6) Track width, rear	1554 (61.2)

* P245 tire with roof rack

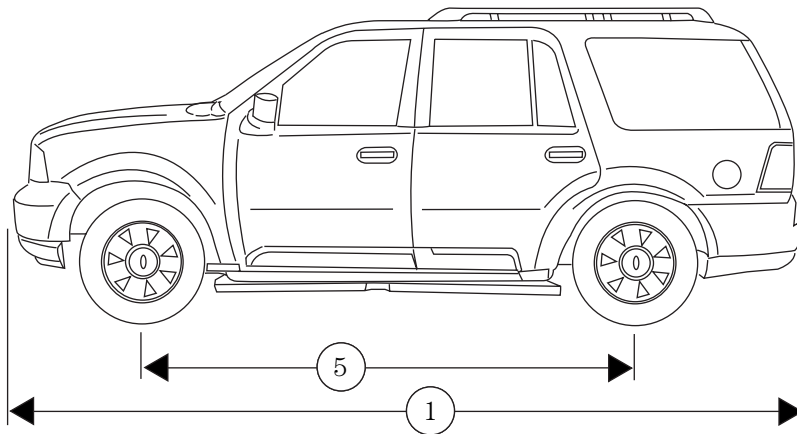

Maintenance and Specifications

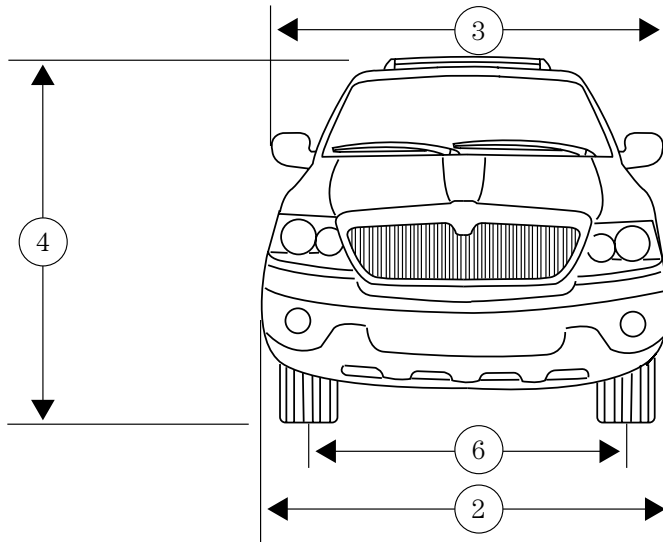

IDENTIFYING YOUR VEHICLE

Certification label

The National Highway Traffic Safety Administration Regulations require that a Certification label be affixed to a vehicle and prescribe where the Certification label may be located. The Certification label is located on the front door latch pillar on the driver's side.

MFD. BY FORD MOTOR CO. IN U.S.A.	
DATE: XXXX	GVWR: XXXX LB/ XXXX KG
FGAWR: XXXXX/XXXXXX	RGAWR: XXXXX/XXXXXX
THIS VEHICLE CONFORMS TO ALL APPLICABLE FEDERAL MOTOR VEHICLE SAFETY STANDARDS IN EFFECT ON THE DATE OF MANUFACTURE SHOWN ABOVE.	
VIN: XXXXXXXXXXXXXXXX	TYPE: XXXXXXXXXXXXXXXX
	
MAXIMUM LOAD=OCCUPANTS + LUGGAGE=XXXKG/XXXLB	
OCCUPANTS: X TOTAL X FR X 2ND X RR	OCCUPANTS LUGGAGE
	XX XXXKG/XXXLB
TIRE: XXXX/XXXX XXX	X XXXKG/XXXLB
PRESSURE (FR) XXX kPa/ XX PSI COLD	
PRESSURE (RR) XXX kPa/ XX PSI COLD	
TRAILER TOWING - SEE OWNER GUIDE	
EXT PNT: XXXXX XXXXX	RC: XX DSO: XXXX F0000
BAR INT TR TP/PS R	AXLE TR SPR T0000
X XX XXX X	XX X XXXX
UTC VFOHT-15294A10-GA	

Maintenance and Specifications

Vehicle identification number (VIN)

The vehicle identification number is attached to a metal tag and is located on the driver side instrument panel. (Please note that in the graphic XXXX is representative of your vehicle identification number.)

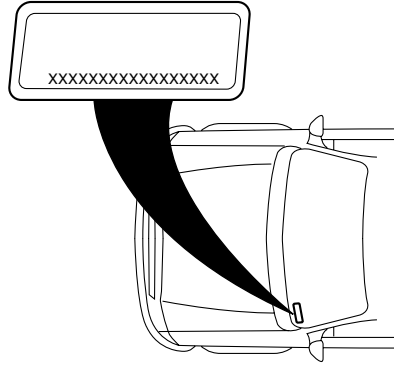

Engine number

The engine number (the last eight numbers of the vehicle identification number) is stamped on the engine block and transmission.

Accessories

FORD ACCESSORIES FOR YOUR VEHICLE

A wide selection of genuine Ford accessories are available for your vehicle through your local authorized Ford, Lincoln, Mercury or Ford of Canada dealer. These quality accessories have been specifically engineered to fulfill your automotive needs; they are custom designed to complement the style and aerodynamic appearance of your vehicle. In addition, each accessory is made from high quality materials and meets or exceeds Ford's rigorous engineering and safety specifications. Ford Motor Company will repair or replace any properly dealer-installed Ford accessory found to be defective in factory-supplied materials or workmanship during the warranty period, as well as any component damaged by the defective accessory. The accessory will be warranted for whichever provides you the greatest benefit:

- 12 months or 20,000 km (12,000 miles) (whichever occurs first), or
- the remainder of your new vehicle limited warranty.

This means that genuine Ford accessories purchased along with your new vehicle and installed by the dealer are covered for the full length of your New Vehicle's Limited Warranty — 3 years or 60,000 km (36,000 miles) (whichever occurs first). Contact your dealer for details and a copy of the warranty.

Not all accessories are available for all models.

Following is a list of several Ford Genuine Accessory products. Not all accessories are available for all models. To find out what accessories are available for your vehicle, please contact your dealer or visit our online store at: www.lincolnaccessories.com.

Vehicle Security

Styled wheel locks

Vehicle security systems

Underbody security lighting

Comfort and convenience

Cargo net

Cargo organizer(s)

Cargo shade

Cargo tray

Center console

Engine block heater

328

Accessories

Home link
Keyless entry
Navigation system
Rear park assist
Remote start system
Seat back organizer
Tire step
Video entertainment system (DVD)

Travel equipment

Ash cup
Automatic headlamp system with DRL
Canoe carrier
Daytime running lights (DRL)
First aid kit
Highway safety kit
Interior mirror, electrochromatic with compass (with and without temperature display)
Kayak carrier
Luggage basket
Luggage box carrier (large & small)
Moon roof deflector
Raised cross-bars (for luggage rack rails)
Removable roof rack
Running boards
Ski/snowboard carrier
Soft luggage cover
Trailer hitch (Class II)
Trailer hitch bars and balls
Trailer hitch receiver cover
Trailer hitch wiring adaptor

Protection and appearance equipment

All weather floor mats
Air bag anti-theft locks

Accessories

Cargo liners, interior
Carpet floor mats
Door edge guards
Flat splash guards
Fog lamps
Front end covers (full and sport)
Front hood deflectors
Locking gas cap
Molded splash guards
Secure start — emergency battery start
Side window air deflectors
Universal floor mats

For maximum vehicle performance, keep the following information in mind when adding accessories or equipment to your vehicle:

- When adding accessories, equipment, passengers and luggage to your vehicle, do not exceed the total weight capacity of the vehicle or of the front or rear axle (GVWR or GAWR as indicated on the Safety compliance certification label). Consult your dealer for specific weight information.
- The Federal Communications Commission (FCC) and Canadian Radio Telecommunications Commission (CRTC) regulate the use of mobile communications systems - such as two-way radios, telephones and theft alarms - that are equipped with radio transmitters. Any such equipment installed in your vehicle should comply with FCC or CRTC regulations and should be installed only by a qualified service technician.
- Mobile communications systems may harm the operation of your vehicle, particularly if they are not properly designed for automotive use or are not properly installed. When operated, such systems may cause the engine to stumble or stall or cause the transmission to be damaged or operate improperly. In addition, such systems may be damaged or their performance may be affected by operating your vehicle. (Citizens band [CB] transceivers, garage door openers and other transmitters with outputs of five watts or less will not ordinarily affect your vehicle's operation.)
- Ford cannot assume responsibility for any adverse effects or damage that may result from the use of such equipment.

330

Index

A

ABS (see Brakes)219
Accessory delay124
Air bag supplemental restraint system196, 200
 and child safety seats198
 description196, 200
 disposal203
 driver air bag198, 201
 indicator light12, 202
 operation198, 201
 passenger air bag198, 201
 side air bag200
Air cleaner filter320
Air conditioning92
 auxiliary heater and air conditioner98
All Wheel Drive (AWD), driving off road232
Ambulance packages7
Antifreeze (see Engine coolant)301
Anti-lock brake system (see Brakes)219–220
Anti-theft system170
 arming the system170
 disarming a triggered system172
Audio system (see Radio) ...18, 27
Automatic transmission
 driving an automatic overdrive227
 fluid, adding316
 fluid, checking316
 fluid, refill capacities321
 fluid, specification325
Auxiliary power point120

Axle

lubricant specifications ..323, 325
refill capacities321

B

Battery299
 acid, treating emergencies299
 charging system warning light12
 jumping a disabled battery270
 maintenance-free299
 replacement, specifications ...320
 servicing299
BeltMinder192
Brakes218
 anti-lock219–220
 anti-lock brake system (ABS) warning light11, 220
 brake warning light11
 fluid, checking and adding ...315
 fluid, refill capacities321
 fluid, specifications323, 325
 lubricant specifications ..323, 325
 parking220
 shift interlock225
Bulbs107

C

Calculating load244
Capacities for refilling fluids321
Cargo cover156
CD-single premium18
Cell phone use152
Certification Label326
Changing a tire262
Child safety restraints204
 child safety belts204

Index

- Child safety seats206
 - attaching with tether straps ..210
 - in front seat208
 - in rear seat208
 - Cleaning your vehicle
 - engine compartment287
 - instrument panel289
 - interior289–290
 - interior trim290
 - plastic parts288
 - washing286
 - waxing286
 - wheels287
 - wiper blades288
 - Clock27, 38, 120
 - Compass, electronic
 - set zone adjustment140
 - Console153
 - overhead118
 - rear153
 - Controls
 - power seat176
 - steering column132
 - Coolant
 - checking and adding301
 - coolant temperature light13
 - refill capacities303, 321
 - specifications323, 325
 - Cruise control
 - (see Speed control)128
 - Customer Assistance251
 - Ford accessories for your vehicle290
 - Ford Extended Service Plan278
 - Getting assistance outside the U.S. and Canada282
 - Getting roadside assistance ...251
 - Getting the service you need276
 - Ordering additional owner's literature283
 - The Dispute Settlement Board279
 - Utilizing the Mediation/Arbitration Program282
- ### D
- Daytime running lamps
 - (see Lamps)103
 - Defrost
 - rear window100
 - Dipstick
 - automatic transmission fluid316
 - engine oil295
 - Doors
 - door ajar warning14
 - lubricant specifications323
 - Driving under special conditions235, 238
 - sand237
 - snow and ice239
 - through water237, 241
 - Dual automatic temperature control (DATC)92
- ### E
- Electronic message center139
 - Emergencies, roadside
 - jump-starting270
 - Emission control system313
 - Engine325
 - check engine/service engine soon light10
 - cleaning287
 - coolant301

Index

- fail-safe coolant304
- idle speed control299
- lubrication
 - specifications323, 325
 - refill capacities321
 - service points294
 - starting after a collision252
- Engine block heater218
- Engine oil295
 - change oil soon warning,
message center295
 - checking and adding295
 - dipstick295
 - filter, specifications298, 320
 - recommendations298
 - refill capacities321
 - specifications323, 325
- Exhaust fumes218
- F**
- Fail safe cooling304
- Floor mats154
- Fluid capacities321
- Foglamps101
- Four-Wheel Drive vehicles
 - driving off road234
 - indicator light14
 - preparing to drive your
vehicle224
- Fuel305
 - calculating fuel
economy142, 310
 - cap307
 - capacity321
 - choosing the right fuel308
 - comparisons with EPA fuel
economy estimates313
 - detergent in fuel309
 - filling your vehicle with
fuel305, 307, 310
 - filter, specifications309, 320
 - fuel pump shut-off switch252
 - gauge16
 - improving fuel economy310
 - octane rating308, 325
 - quality309
 - running out of fuel309
 - safety information relating to
automotive fuels305
- Fuses253–254
- G**
- Garage door opener135
- Gas cap (see Fuel cap)307
- Gas mileage
(see Fuel economy)310
- Gauges15
 - engine coolant temperature
gauge15
 - fuel gauge16
 - odometer16
 - speedometer16
 - tachometer17
 - trip odometer16
- GAWR (Gross Axle Weight
Rating)242
 - calculating244
 - definition242
 - driving with a heavy load242
 - location242
- GVWR (Gross Vehicle Weight
Rating)242
 - calculating242, 244
 - definition242
 - driving with a heavy load242
 - location242
- H**
- Hazard flashers252

Index

- Head restraints174
- Headlamps101
- aiming104
 - autolamp system101
 - bulb specifications107
 - daytime running lights103
 - flash to pass104
 - high beam13, 103
 - replacing bulbs109
 - turning on and off101
 - warning chime14
- Heating
- heating and air conditioning system92
- HomeLink universal transceiver (see Garage door opener)135–136, 138
- I**
- Ignition215, 325
- Infant seats (see Safety seats)206
- Inspection/maintenance (I/M) testing314
- Instrument panel
- cleaning289
 - cluster10
 - lighting up panel and interior104
- J**
- Jack262, 264
- positioning262, 266
 - storage262, 264
- Jump-starting your vehicle270
- K**
- Keyless entry system
- locking and unlocking doors ..166
 - programming entry code165
- Keys167–169
- key in ignition chime14
 - positions of the ignition215
- L**
- Lamps
- autolamp system101
 - bulb replacement specifications chart107
 - cargo lamps104
 - daytime running light103
 - fog lamps101
 - headlamps101
 - headlamps, flash to pass104
 - instrument panel, dimming ...104
 - interior lamps106, 108
 - replacing bulbs107, 109, 111–114
- Lane change indicator (see Turn signal)106
- Liftgate154, 159
- Lights, warning and indicator10
- AdvanceTrac12
 - air bag12
 - anti-lock brakes (ABS)11, 220
 - brake11
 - charging system12
 - cruise indicator13
 - high beam13
 - low coolant13
 - oil pressure12
 - overdrive off13
 - safety belt12
 - service engine soon10
 - speed control132

Index

- turn signal indicator13
- Load limits242
 - GAWR242
 - GVWR242
 - trailer towing242
- Loading instructions243
- Locks
 - childproof157
 - doors157
- Lubricant specifications ...323, 325
- Lumbar support, seats175
- M**
- Manual transmission
 - fluid capacities321
 - lubricant specifications325
- Message center139–140
 - english/metric button144
 - system check button143
 - warning messages146
- Mirrors118, 124
 - automatic dimming rearview mirror124
 - fold away126
 - heated126
 - programmable memory159
 - side view mirrors (power)125, 127
- Moon roof119
- Motorcraft parts309, 320
- N**
- Navigation system41
 - cd functions54
 - destination mode66
 - map mode57
 - quick start42
- radio functions46
- O**
- Octane rating308
- Odometer16
- Oil (see Engine oil)295
- Overdrive152
- P**
- Panic alarm feature, remote entry system159
- Parking brake220
- Parts (see Motorcraft parts) ...320
- Pedals (see Power adjustable foot pedals)127
- Power adjustable foot pedals ...127
- Power distribution box (see Fuses)257
- Power door locks157
- Power mirrors125
- Power point120
- Power steering224
 - fluid, checking and adding ...314
 - fluid, refill capacity321
 - fluid, specifications323, 325
- Power Windows121
- Preparing to drive your vehicle224
- R**
- Radio18, 27
- Rear Park Assist230
- Rear window defroster100
- Relays253, 261

Index

- Remote entry system157, 159
 - illuminated entry163
 - locking/unlocking doors157–158, 162
 - opening the trunk159
 - panic alarm159
 - replacement/additional transmitters161
 - replacing the batteries160
- Roadside assistance251
- Roof rack155
- S**
- Safety Belt Maintenance195
- Safety belts (see Safety restraints)14, 186–189, 191
- Safety Canopy201
- Safety defects, reporting285
- Safety restraints186–191
 - belt minder192
 - extension assembly195
 - for adults187–189
 - for children203–204
 - safety belt maintenance195
 - warning light and chime12, 14, 191
- Safety seats for children206
- Seat belts (see Safety restraints)186
- Seats174
 - child safety seats206
 - climate control178
 - easy access/easyout feature ..177
 - memory seat159, 177
- SecuriLock passive anti-theft system167–169
- Servicing your vehicle292
- Snowplowing7
- Spark plugs, specifications320, 325
- Special notice
 - ambulance conversions7
 - utility-type vehicles7
- Specification chart, lubricants323, 325
- Speed control128
- Speedometer16
- Starting your vehicle215–217
 - jump starting270
- Steering wheel controls128, 132
- T**
- Tachometer17
- Tires262, 316–317
 - changing262, 266
 - checking the pressure317
 - replacing266, 319
 - rotating318
 - snow tires and chains319
 - spare tire263–265
 - tire grades317
 - treadwear316
- Towing244
 - recreational towing250
 - trailer towing244
 - wrecker275
- Traction control221
 - active light12
- Transmission225
 - fluid, checking and adding (automatic)316
 - fluid, refill capacities321
 - lubricant specifications ..323, 325

Index

- Trip odometer16
Trunk159
Turn signal13, 106
- V**
- Vehicle dimensions325
Vehicle Identification Number
(VIN)327
Vehicle loading242
Ventilating your vehicle218
- W**
- Warning chimes14
Warning lights (see Lights)10
Washer fluid295
Water, Driving through241
Windows
 power121
 rear wiper/washer116
Windshield washer fluid and
wipers
 checking and adding fluid295
 checking and cleaning116–117
 liftgate reservoir295
 operation116
 replacing wiper blades117
Wrecker towing275

