

## Table of Contents

<b>Introduction</b>	<b>4</b>
<b>Instrument Cluster</b>	<b>10</b>
Warning and control lights	10
Gauges	14
<b>Entertainment Systems</b>	<b>16</b>
AM/FM stereo with CD	16
AM/FM stereo cassette with CD	20
Navigation system	24
<b>Climate Controls</b>	<b>72</b>
Electronic automatic temperature control	72
<b>Lights</b>	<b>80</b>
Headlamps	80
Turn signal control	84
Bulb replacement	84
<b>Driver Controls</b>	<b>90</b>
Windshield wiper/washer control	90
Steering wheel adjustment	92
Power windows	94
Mirrors	96
Speed control	99
Message center	110
<b>Locks and Security</b>	<b>124</b>
Keys	124
Locks	124
Anti-theft system	128

## Table of Contents

<b>Seating and Safety Restraints</b>	<b>139</b>
Seating	139
Safety restraints	146
Air bags	161
Child restraints	173
<b>Driving</b>	<b>185</b>
Starting	185
Brakes	188
Traction control/AdvanceTrac	190
Transmission operation	194
Trailer towing	202
<b>Roadside Emergencies</b>	<b>204</b>
Getting roadside assistance	204
Hazard flasher switch	205
Fuel pump shut-off switch	206
Fuses and relays	206
Changing tires	215
Jump starting	220
Wrecker towing	226
<b>Customer Assistance</b>	<b>227</b>
Reporting safety defects (U.S. only)	236
<b>Cleaning</b>	<b>237</b>

## Table of Contents

<b>Maintenance and Specifications</b>	<b>244</b>
Engine compartment	246
Engine oil	248
Battery	251
Fuel information	259
Air filter(s)	269
Part numbers	275
Refill capacities	276
Lubricant specifications	278
<b>Accessories</b>	<b>283</b>
<b>Index</b>	<b>286</b>

All rights reserved. Reproduction by any means, electronic or mechanical including photocopying, recording or by any information storage and retrieval system or translation in whole or part is not permitted without written authorization from Ford Motor Company. Ford may change the contents without notice and without incurring obligation.

Copyright © 2003 Ford Motor Company

## Introduction

### CALIFORNIA Proposition 65 Warning



**WARNING:** Engine exhaust, some of its constituents, and certain vehicle components contain or emit chemicals known to the State of California to cause cancer and birth defects or other reproductive harm. In addition, certain fluids contained in vehicles and certain products of component wear contain or emit chemicals known to the State of California to cause cancer and birth defects or other reproductive harm.

### CONGRATULATIONS

Congratulations on acquiring your new Lincoln. Please take the time to get well acquainted with your vehicle by reading this handbook. The more you know and understand about your vehicle the greater the safety and pleasure you will derive from driving it.

For more information on Ford Motor Company and its products visit the following website:

- In the United States: [www.ford.com](http://www.ford.com)
- In Canada: [www.ford.ca](http://www.ford.ca)
- In Mexico: [www.ford.com.mx](http://www.ford.com.mx)
- In Australia: [www.ford.com.au](http://www.ford.com.au)

Additional owner information is given in separate publications.

This Owner's Guide describes every option and model variant available and therefore some of the items covered may not apply to your particular vehicle. Furthermore, due to printing cycles it may describe options before they are generally available.

Remember to pass on the Owner's Guide when reselling the vehicle. It is an integral part of the vehicle.



**Fuel pump shut-off switch** In the event of an accident the safety switch will automatically cut off the fuel supply to the engine. The switch can also be activated through sudden vibration (e.g. collision when parking). To reset the switch, refer to the *Fuel pump shut-off switch* in the *Roadside emergencies* chapter.

### SAFETY AND ENVIRONMENT PROTECTION

#### **Warning symbols in this guide**

How can you reduce the risk of personal injury and prevent possible damage to others, your vehicle and its equipment? In this guide, answers to such questions are contained in comments highlighted by the warning triangle symbol. These comments should be read and observed.

#### **Warning symbols on your vehicle**

When you see this symbol, it is imperative that you consult the relevant section of this guide before touching or attempting adjustment of any kind.



#### **Protecting the environment**

We must all play our part in protecting the environment. Correct vehicle usage and the authorized disposal of waste cleaning and lubrication materials are significant steps towards this aim. Information in this respect is highlighted in this guide with the tree symbol.



#### **BREAKING-IN YOUR VEHICLE**

Your vehicle does not need an extensive break-in. Try not to drive continuously at the same speed for the first 1,600 km (1,000 miles) of new vehicle operation. Vary your speed to allow parts to adjust themselves to other parts.

Drive your new vehicle at least 800 km (500 miles) before towing a trailer.

Do not add friction modifier compounds or special break-in oils during the first few thousand kilometers (miles) of operation, since these additives may prevent piston ring seating. See *Engine oil* in the *Maintenance and specifications* chapter for more information on oil usage.

## Introduction

### SPECIAL NOTICES

#### Emission warranty

The New Vehicle Limited Warranty includes Bumper-to-Bumper Coverage, Safety Restraint Coverage, Corrosion Coverage, and 7.3L Power Stroke Diesel Engine Coverage. In addition, your vehicle is eligible for Emissions Defect and Emissions Performance Warranties. For a detailed description of what is covered and what is not covered, refer to the *Warranty Guide* that is provided to you along with your Owner's Guide.

#### Special instructions

For your added safety, your vehicle is fitted with sophisticated electronic controls.



Please read the section *Supplemental Restraint System (SRS)* in the *Seating and safety restraints* chapter. Failure to follow the specific warnings and instructions could result in personal injury.



Front seat mounted rear facing child or infant seats should **NEVER** be used in front of a passenger side air bag unless the air bag can be and is turned OFF.

#### Data Recording

Computers in your vehicle are capable of recording detailed data potentially including but not limited to information such as:

- the use of restraint systems including seat belts by the driver and passengers,
- information about the performance of various systems and modules in the vehicle, and
- information related to engine, throttle, steering, brake or other system status.

Any of this information could potentially include information regarding how the driver operates the vehicle potentially including but not limited to information regarding vehicle speed, brake or accelerator application or steering input. This information may be stored during regular operation or in a crash or near crash event.

## Introduction

This stored information may be read out and used by:

- Ford Motor Company.
- service and repair facilities.
- law enforcement or government agencies.
- others who may assert a right or obtain your consent to know such information.

### **MIDDLE EAST/NORTH AFRICA VEHICLE SPECIFIC INFORMATION**

For your particular global region, your vehicle may be equipped with features and options that are different from the ones that are described in this Owner Guide; therefore, a supplement has been supplied that complements this book. By referring to the pages in the provided supplement, you can properly identify those features, recommendations and specifications that are unique to your vehicle. **Refer to this Owner Guide for all other required information and warnings.**















## Introduction

These are some of the symbols you may see on your vehicle.

### Vehicle Symbol Glossary

Safety Alert		See Owner's Guide	
Fasten Safety Belt		Air Bag-Front	
Air Bag-Side		Child Seat	
Child Seat Installation Warning		Child Seat Lower Anchor	
Child Seat Tether Anchor		Brake System	
Anti-Lock Brake System		Brake Fluid - Non-Petroleum Based	
Traction Control		AdvanceTrac™	
Master Lighting Switch		Hazard Warning Flasher	
Fog Lamps-Front		Fuse Compartment	
Fuel Pump Reset		Windshield Wash/Wipe	
Windshield Defrost/Demist		Rear Window Defrost/Demist	

Vehicle Symbol Glossary

Power Windows Front/Rear		Power Window Lockout	
Child Safety Door Lock/Unlock		Interior Luggage Compartment Release Symbol	
Panic Alarm		Engine Oil	
Engine Coolant		Engine Coolant Temperature	
Do Not Open When Hot		Battery	
Avoid Smoking, Flames, or Sparks		Battery Acid	
Explosive Gas		Fan Warning	
Power Steering Fluid		Maintain Correct Fluid Level	
Emission System		Engine Air Filter	
Passenger Compartment Air Filter		Jack	
Check fuel cap		Low tire warning	

## Instrument Cluster

### WARNING LIGHTS AND CHIMES

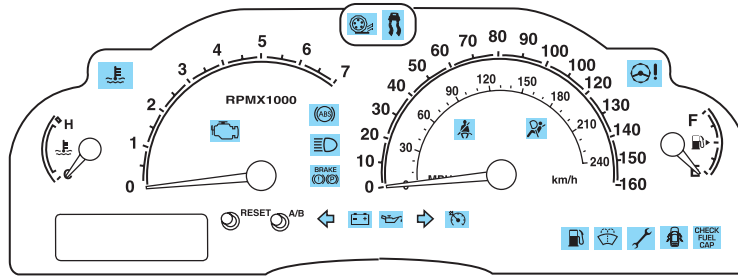

Warning lights and gauges can alert you to a vehicle condition that may become serious enough to cause expensive repairs. A warning light may illuminate when a problem exists with one of your vehicle's functions. Many lights will illuminate when you start your vehicle to make sure the bulb works. If any light remains on after starting the vehicle, have the respective system inspected immediately.

**Check engine:** The *Check Engine* indicator light illuminates when the ignition is first turned to the ON position to check the bulb. Solid illumination after the engine is started indicates the On Board Diagnostics System (OBD-II) has detected a malfunction. Refer to *On board diagnostics (OBD-II)* in the *Maintenance and Specifications* chapter. If the light is blinking, engine misfire is occurring which could damage your catalytic converter. Drive in a moderate fashion (avoid heavy acceleration and deceleration) and have your vehicle serviced immediately.

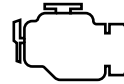

Under engine misfire conditions, excessive exhaust temperatures could damage the catalytic converter, the fuel system, interior floor coverings or other vehicle components, possibly causing a fire.

#### **Check fuel cap (if equipped):**

Illuminates when the fuel cap may not be properly installed. Continued driving with this light on may cause the Check engine warning light to come on. Refer to *Fuel filler cap* in the *Maintenance and Specifications* chapter.

**CHECK  
FUEL  
CAP**

## Instrument Cluster

**Brake system warning light:** To confirm the brake system warning light is functional, it will momentarily illuminate when the ignition is turned to the ON position when the engine is not running, or in a position between ON and START, or by applying the parking brake when the ignition is turned to the ON position. If the brake system warning light does not illuminate at this time, seek service immediately from your dealership. Illumination after releasing the parking brake indicates low brake fluid level and the brake system should be inspected immediately by your servicing dealership.



 Driving a vehicle with the brake system warning light on is dangerous. A significant decrease in braking performance may occur. It will take you longer to stop the vehicle. Have the vehicle checked by your dealer immediately.

**Anti-lock brake system:** If the ABS light stays illuminated or continues to flash, a malfunction has been detected, have the system serviced immediately. Normal braking is still functional unless the brake warning light also is illuminated.



**Air bag readiness:** If this light fails to illuminate when ignition is turned to ON, continues to flash or remains on, have the system serviced immediately. A chime will also sound when a malfunction in the supplemental restraint system has been detected.



**Safety belt:** Reminds you to fasten your safety belt. A chime will also sound to remind you to fasten your safety belt.



**Charging system:** Illuminates when the battery is not charging properly.



## Instrument Cluster

**Engine oil pressure:** Illuminates when the oil pressure falls below the normal range, refer to *Engine oil* in the *Maintenance and specifications* chapter.



**Engine coolant temperature:** Illuminates when the engine coolant temperature is high. Stop the vehicle as soon as possible, switch off the engine and let cool. Refer to *Engine coolant* in the *Maintenance and specifications* chapter.



Never remove the coolant recovery cap while the engine is running or hot.

**Transmission PRNDL indicator:**

Displays the gearshift positions. If an “E” character is displayed or flashing, this indicates a transmission malfunction and may cause damage to your transmission. Contact your dealer immediately.



**AdvanceTrac™ (if equipped):**

Illuminates when the AdvanceTrac™ system is active. If the light remains on, have the system serviced immediately, refer to the *Driving* chapter for more information.



**Traction Control™ active:**

Illuminates when the Traction Control™ is active. If the light remains on, have the system serviced immediately, refer to the *Driving* chapter for more information.



**Steering column lock**

**(if equipped):** Illuminates when the steering column is locked. If the light stays on the vehicle will not start, make sure the key is the correct key, refer to *Securilock™* in the *Locks and Security* chapter.



## Instrument Cluster

**Low fuel (if equipped):**

Illuminates when the fuel level in the fuel tank is at, or near empty (refer to *Fuel gauge* in this chapter).



**Speed control:** Illuminates when the speed control is activated. Turns off when the speed control system is deactivated.

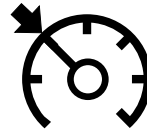

**Low washer fluid (if equipped):**

Illuminates when the windshield washer fluid is low.



**Bulb warning (if equipped):**

Illuminates when one of the exterior front turn lamps or rear brake/turn/tail lamps bulb has burned out. Depress the RESET control to return to the Trip odometer display.

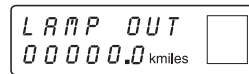

**Door ajar (if equipped):**

Illuminates when the ignition is in the ON position and any door is open.



**Turn signal:** Illuminates when the left or right turn signal or the hazard lights are turned on. If the indicators stay on or flash faster, check for a burned out bulb.



**High beams:** Illuminates when the high beam headlamps are turned on.



**Electronic throttle control**

**(if equipped):** Illuminates when the engine has defaulted to a 'limp-home' operation. Report the fault to a dealer at the earliest opportunity.



## Instrument Cluster

**Key-in-ignition warning chime:** Sounds when the key is left in the ignition in the OFF/LOCK or ACC position and the driver's door is opened.

**Headlamps on warning chime:** Sounds when the headlamps or parking lamps are on, the ignition is off (and the key is not in the ignition) and the driver's door is opened.

### GAUGES

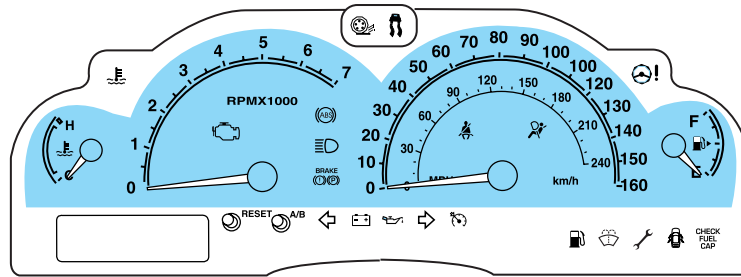

**Speedometer:** Indicates the current vehicle speed.

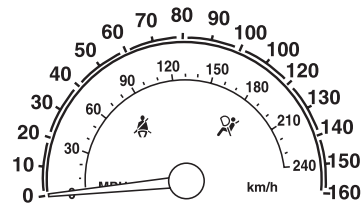

**Engine coolant temperature gauge:** Indicates engine coolant temperature. At normal operating temperature, the needle will be in the normal range (between "H" and "C"). **If it enters the red section, the engine is overheating. Stop the vehicle as soon as safely possible, switch off the engine and let the engine cool.**



Never remove the coolant reservoir cap while the engine is running or hot.

## Instrument Cluster

**Odometer:** Registers the total kilometers (miles) of the vehicle.

- Standard instrument cluster



- Optional instrument cluster



**Trip odometer:** Registers the kilometers (miles) of individual journeys. To reset, depress the RESET control. To switch the display from Trip A to the Trip B, depress the A/B control.

- Standard instrument cluster

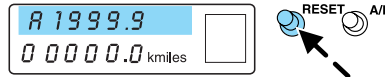

- Optional instrument cluster

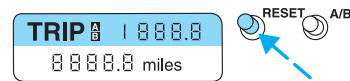

**Tachometer:** Indicates the engine speed in revolutions per minute. Driving with your tachometer pointer continuously at the top of the scale may damage the engine.

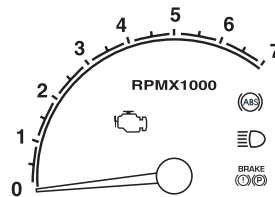

**Fuel gauge:** Indicates approximately how much fuel is left in the fuel tank (when the ignition is in the ON position). The fuel gauge may vary slightly when the vehicle is in motion or on a grade.



Refer to *Filling the tank* in the *Maintenance and Specifications* chapter for more information..

### NOTICE TO OWNERS OF NATURAL GAS FUELED VEHICLES

Before you drive your vehicle, be sure to read the *Dedicated Natural Gas Vehicle* supplement. This book contains important operation and maintenance information.

## Entertainment Systems

### AUDIOPHILE AM/FM STEREO IN-DASH SIX CD RADIO

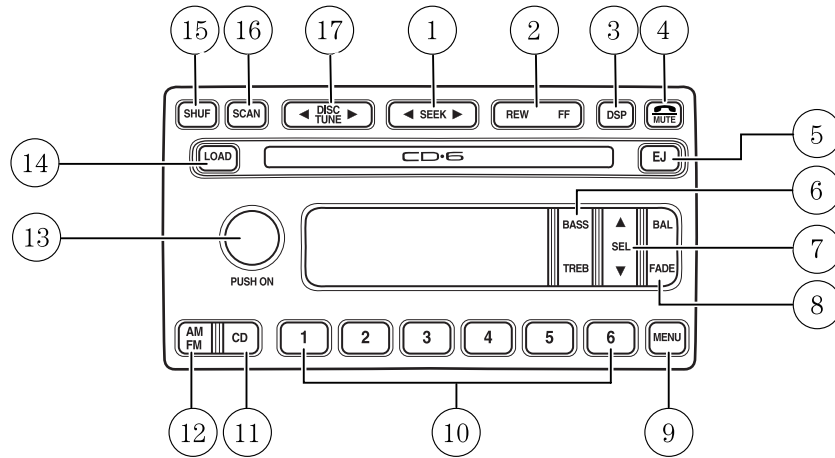

1. **Seek:** Press and release  
SEEK ◀ / ▶ for previous/next  
strong station, selection or track.



2. **Rewind:** In CD mode, press until  
desired selection is reached.



**Fast forward:** In CD mode, press until desired selection is reached.

#### 3. DSP (Digital Signal

**Processing)** (if equipped): Press to  
enter DSP mode – allows you to  
engage/disengage DSP status, and  
choose signal modes of JAZZ CLUB, HALL, NEWS, CHURCH, STADIUM.

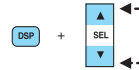

**Ambiance** (if equipped): This feature gives the feeling of “being there”  
to your music, creating increased clarity as well as an open and spacious  
feel to the music. Press DSP to access the ambiance menu. Press SEL to  
engage/disengage. Turn the volume control to increase/decrease the level  
of ambiance.

Press DSP again to change the occupancy mode to optimize sound for  
ALL SEATS, DRIVER SEAT or REAR SEATS.

## Entertainment Systems

4. **Mute:** Press to MUTE playing media; press again return to playing media



5. **Eject:** Press to eject a CD. Press and hold to eject all loaded discs.



6. **Bass:** Press BASS; then press SEL ▼ / ▲ to decrease/increase the bass output.



**Treble:** Press TREB; then press SEL ▼ / ▲ to decrease/increase the treble output.



7. **Select:** Use with Bass, Treble, Balance and Fade controls to adjust levels and set the clock.



8. **Balance:** Press BAL; then press SEL ▼ / ▲ to shift sound to the left/right speakers.

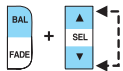

**Fade:** Press FADE; then press SEL ▼ / ▲ to shift sound to the rear/front speakers.



9. **Menu:** Press MENU and SEL to access clock mode, RDS on/off, Traffic announcement mode and Program type mode.



The Federal Communications Commission (FCC) and the Canadian Radio and Telecommunications Commission (CRTC) recommend that FM radio broadcasters use RDS technology to transmit information. FM radio stations are independently operated and individually elect to use RDS technology to transmit station ID and program type as desired.

**Traffic:** Allows you to hear traffic broadcasts. With the feature ON, press SEEK or SCAN to find a station broadcasting a traffic report (if it is broadcasting RDS data). *Traffic information is not available in most U.S. markets.*

**FIND Program type:** Allows you to search RDS-equipped stations for a certain category of music format: Classic, Country, Info, Jazz, Oldies, R&B, Religious, Rock, Soft, Top 40.

## Entertainment Systems

**Show TYPE:** Displays the station's call letters and format.

**Compression:** Brings soft and loud CD passages together for a more consistent listening level. Press MENU until compression status is displayed. Press the SEL control to enable the compression feature when COMP OFF is displayed. Press the SEL control again to disable the feature when COMP ON is displayed.

**Setting the clock:** Press MENU until SELECT HOUR or SELECT MINUTE is displayed. Use SEL to manually increase (▲) or decrease (▼) the hours/minutes. Press MENU again to disengage clock mode.

10. **Memory presets:** To set a station: Select frequency band AM/FM; tune to a station, press and hold a preset button until sound returns.



11. **CD:** Press to select CD mode.



**CD units are designed to play commercially pressed 12 cm (4.75 in) audio compact discs only. Due to technical incompatibility, certain recordable and re-recordable compact discs may not function correctly when used in Ford CD players. Irregular shaped CDs, CDs with a scratch protection film attached, and CDs with homemade paper (adhesive) labels should not be inserted into the CD player. The label may peel and cause the CD to become jammed. It is recommended that homemade CDs be identified with permanent felt tip marker rather than adhesive labels. Ball point pens may damage CDs. Please contact your dealer for further information.**

12. **AM/FM:** Press to select AM/FM frequency band.



**Autostore:** Allows you to set the strongest local radio stations without losing your original manually set preset stations for AM/FM1/FM2. Press and momentarily hold AM/FM. AUTOSTORE will flash on the display. When the six strongest stations are filled, the station stored in preset 1 will begin playing. If there are less than six strong stations, the system will store the last one in the remaining presets. Press again to disengage.

## Entertainment Systems

13. **Power/volume:** Press to turn ON/OFF; turn to increase or decrease volume levels.

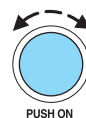

**Speed sensitive volume:** Radio volume changes automatically and slightly with vehicle speed to compensate for road and wind noise. Recommended level is 1–3. Level 0 turns the feature off and level 7 is the maximum setting. Press and hold the volume control for five seconds. Then press SEL to increase (▲) or decrease (▼) the volume setting. The level will appear in the display.

14. **Load:** Press to load a CD. Press and hold to load up to six discs.



15. **Shuffle:** Press to play tracks in random order.



16. **Scan:** Press SCAN to hear a brief sampling of radio stations, or CD tracks. Press again to stop.



17. **Disc/Tune:** Press ◀ or ▶ to manually tune down/up the radio frequency band, or to listen to the previous/next track on the CD.



## Entertainment Systems

### PREMIUM AM/FM STEREO/CASSETTE/SINGLE CD

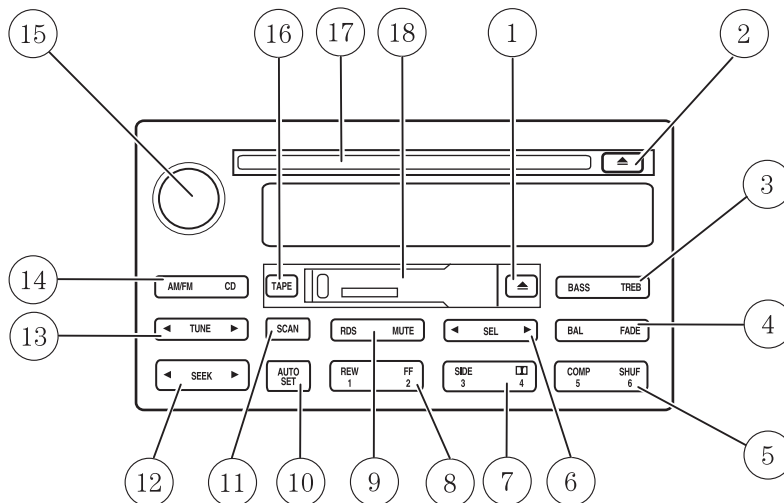

1. **Eject:** Press to eject a tape.



2. **Eject:** Press to eject a CD.



3. **Bass:** Allows you to increase or decrease the audio system's bass output. Press BASS then press SEL to decrease ◀ or increase ▶ the bass levels.



**Treble:** Allows you to increase or decrease the audio system's treble output. Press TREB then press SEL to decrease ◀ or increase ▶ the treble levels.



4. **Balance:** Allows you to shift speaker sound between the right and left speakers. Press BAL then press SEL to shift sound to the left ◀ or right ▶.



## Entertainment Systems

**Fade:** Allows you to shift speaker sound between the front and rear speakers. Press FADE then press SEL to shift the sound to the rear ◀ or the front ▶.



5. **COMP (Compression):** In CD mode, press to bring soft and loud passages together for a more consistent listening level.



**SHUF (Shuffle):** Press to play CD tracks in random order.



6. **Select:** Use to adjust bass, treble, balance and fade levels.



7. **Side 1-2:** Press to change sides on the tape.



**Dolby:**  **Dolby® noise reduction:** Reduces tape noise and hiss; press to activate/deactivate.



8. **REW (Rewind):** Works in tape and CD modes.



In tape mode, radio play continues until rewind is stopped (with the TAPE control) or the beginning of the tape is reached.

In CD mode, REW control reverses the CD within the current track.

**FF (fast forward):** Works in tape and CD modes.



In the tape mode, tape direction automatically reverses when the end of the tape is reached.

In CD mode, FF advances the CD within the current track.

9. **Mute:** Press to mute the playing media.



**RDS:** (Radio Data System): Allows you to access FM stations which are RDS- equipped. Press RDS then SEL to select from:

## Entertainment Systems

**Traffic** — Allows you to receive traffic announcements and control their volume level. **Traffic information is not available in most U.S. markets.**

**Program Type** — Allows you to set your audio system to select from RDS-equipped stations for categories such as: Classic, Country, Info., Jazz, Oldies, R&B, Religious, Rock, Soft, Top 40.

**Show** — Allows you to view the frequency and program type of the chosen radio station.

The Federal Communications Commission (FCC) and the Canadian Radio and Telecommunications Commission (CRTC) recommend that FM radio broadcasters use RDS technology to transmit information. FM radio stations are independently operated and individually elect to use RDS technology to transmit station ID and program type as desired.

**Setting the clock:** Press RDS until SELECT HOUR or SELECT MINS is displayed. Press SEL to increase (▲) or decrease (▼).

10. **Autoset:** Press to set first six strong stations into AM, FM1 or FM2 memory buttons; press again to return to normal stations.



11. **Scan:** Works in radio, tape and CD modes. Press SCAN for a brief sampling of radio stations, tape selections or CD tracks.



12. **Seek:** Works in radio, tape and CD modes. Press to access the previous ◀ or next ▶ listenable radio station, tape selection or CD track.



13. **Tune:** Works in radio mode. Press to manually advance up or down the frequency band.



14. **AM/FM/CD:** Press AM/FM to select a radio frequency. Press while in tape or CD mode to return to radio mode. Press CD to enter CD mode and to play a CD already in the system.



## Entertainment Systems

**CD units are designed to play commercially pressed 12 cm (4.75 in) audio compact discs only. Due to technical incompatibility, certain recordable and re-recordable compact discs may not function correctly when used in Ford CD players. Irregular shaped CDs, CDs with a scratch protection film attached, and CDs with homemade paper (adhesive) labels should not be inserted into the CD player. The label may peel and cause the CD to become jammed. It is recommended that homemade CDs be identified with permanent felt tip marker rather than adhesive labels. Ball point pens may damage CDs. Please contact your dealer for further information.**

15. **Power/volume:** Press to turn the system on/off. Turn to raise/lower the volume.

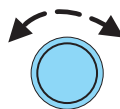

**Speed sensitive volume:** (if equipped) Radio volume changes automatically and slightly with vehicle speed to compensate for road and wind noise. Press and hold the volume control for five seconds. Then press SEL to increase (▲) or decrease (▼) the volume setting. The level will appear in the display.

16. **TAPE:** Press to play reverse side of the tape.



17. **CD door:** Insert the disc with the playing side down and printed side up.

18. **Tape door:** Insert the tape facing the right.

### RADIO FREQUENCIES

AM and FM frequencies are established by the Federal Communications Commission (FCC) and the Canadian Radio and Telecommunications Commission (CRTC). Those frequencies are:

AM - 530, 540–1700, 1710 kHz

FM- 87.7, 87.9–107.7, 107.9 MHz

### RADIO RECEPTION FACTORS

There are three factors that can effect radio reception:

- Distance/strength: The further you travel from an FM station, the weaker the signal and the weaker the reception.

## Entertainment Systems

- Terrain: Hills, mountains, tall buildings, power lines, electric fences, traffic lights and thunderstorms can interfere with your reception.
- Station overload: When you pass a broadcast tower, a stronger signal may overtake a weaker one and play while the weak station frequency is displayed.

### CD/CD PLAYER CARE

Do:

- Handle discs by their edges only. Never touch the playing surface.
- Inspect discs before playing. Clean only with an approved CD cleaner and wipe from the center out.

Don't:

- Expose discs to direct sunlight or heat sources for extended periods of time.
- Insert more than one disc into each slot of the CD changer magazine.
- Clean using a circular motion.

**CD units are designed to play commercially pressed 12 cm (4.75 in) audio compact discs only. Due to technical incompatibility, certain recordable and re-recordable compact discs may not function correctly when used in Ford CD players. Irregular shaped CDs, CDs with a scratch protection film attached, and CDs with homemade paper (adhesive) labels should not be inserted into the CD player. The label may peel and cause the CD to become jammed. It is recommended that homemade CDs be identified with permanent felt tip marker rather than adhesive labels. Ball point pens may damage CDs. Please contact your dealer for further information.**

### AUDIO SYSTEM WARRANTY AND SERVICE

Refer to the *Warranty Guide* for audio system warranty information. If service is necessary, see your dealer or qualified technician.

### LINCOLN NAVIGATION SYSTEM (IF EQUIPPED)

Your vehicle may be equipped with a Lincoln Navigation System which allows you to listen to the radio, play CDs and also navigate the vehicle using a navigation DVD.

## Entertainment Systems

### **THX audio system**

Your Lincoln LS is equipped with the THX® certified premium audio system. This system creates optimal acoustic quality for all seating positions and road conditions.



The system offers an advanced speaker system, amplifier, subwoofer and equalizer.

Your system has a large range of features, yet is easy to use. Guidance is shown on the display screen and is supplemented with voice prompts. The display screen provides full information for operating the system through use of menus, text screens and map displays. Screen selections are made by touching the desired selection on the screen.

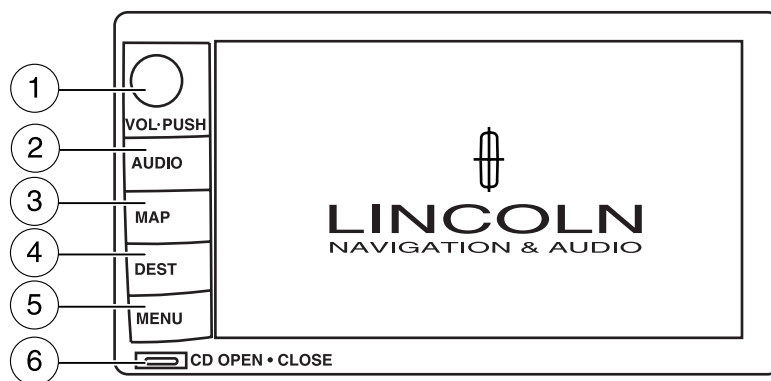

1. **VOL-PUSH:** Press to turn the system ON/OFF. Turn to adjust the audio volume level.
2. **AUDIO:** Press to enter audio mode and access radio, CD, CDDJ, DVD (if equipped) settings.
3. **MAP:** Press to enter map mode and view your current vehicle position on the map. Press and hold to obtain additional position information.
4. **DEST:** Press to enter Destination Entry mode. This allows you to enter a destination and route to it. With an active route, pressing DEST allows the user to request a Detour, display entire route, select route preferences, or change or cancel the destination.
5. **MENU:** Press to access system settings such as display, brightness, clock mode, etc.

## Entertainment Systems

6. **CD OPEN CLOSE:** Press to open/close the display screen and access the CD player.

### **Cold temperature advisory**

When operating the system below 32° Fahrenheit (0° Celsius), the display screen requires 20–30 minutes warm-up to achieve maximum brightness. Ensure that the system display setting is set to DAY mode until maximum brightness is achieved (refer to *Menu mode* section). Once maximum brightness is achieved, revert to AUTO mode display setting.

### **Initial map display**

After pressing AGREE to the initial WARNING screen, you will move into the initial map screen which shows the current vehicle location. Pressing the globe icon will take you to the user settings — audible feedback, navigation units, language and clock.



### **Quick Start — How to get going**

#### **To play a radio station:**

1. Ensure that the vehicle ignition is on.
2. Press AUDIO.

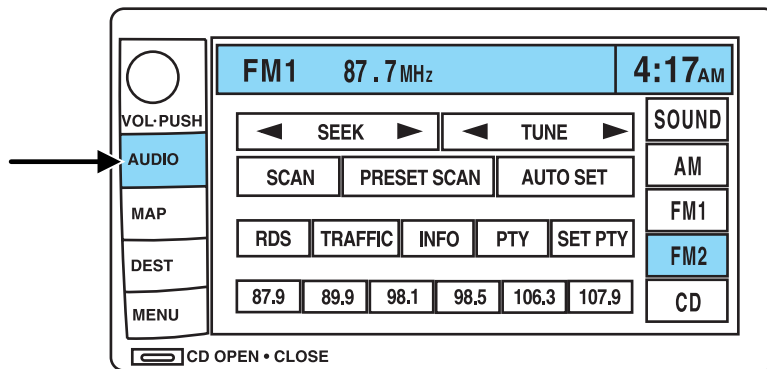

## Entertainment Systems

3. Select AM, FM1 or FM2.
4. Press TUNE to adjust manually up (▶) or down (◀) the frequency band.
5. Press SEEK to find the next strong station up (▶) or down (◀).

**Note:** If PTY (program type) is selected, the station selection will be limited. Refer to *Program Type (PTY)* for further information.

### To play a previously loaded CD:

1. Ensure that the vehicle ignition is on.
2. Press AUDIO.
3. Press CD to select a CD which is already loaded. (NO CD will appear in the display if there are not CDs loaded into the system). Use the controls (1–6) to select the desired CD.
4. CD will begin to play.

### To load CDs:

1. Press CD OPEN CLOSE at the bottom of the screen to load a CD. (The screen will open).  

2. Press LOAD and select the desired slot. Or, press and hold LOAD to auto load all available slots. The slot indicator lights blink rate will increase when the system is ready to accept a disc. Push CD OPEN CLOSE to close the screen. Once closed, the CD will begin to play.
3. Use the touch controls to advance tracks, scan, pause, etc. The small red lights below the CD slot will blink faster when the system is ready to accept a disc.

### To use the Navigation system:

1. Ensure that the vehicle ignition is on, and the navigation DVD is loaded into the navigation DVD player. Refer to *Loading the map DVD* for navigation DVD locations.
2. Press DEST. The warning screen will appear. After reading, press AGREE. The screen will show a map with your current location. Press DEST again.

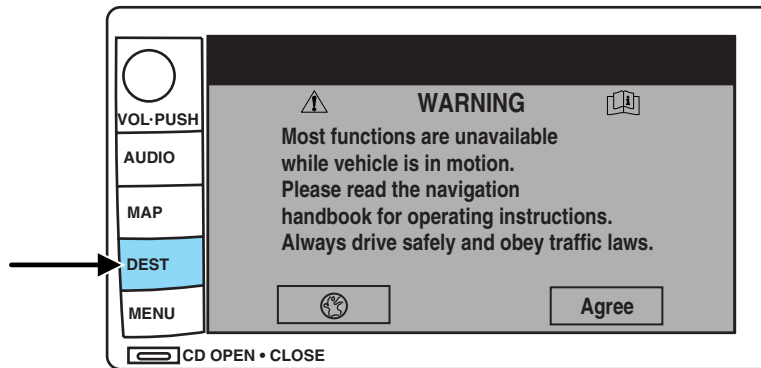
## Entertainment Systems



3. Select the desired type of destination entry; Address, Point of Interest; Previous Dest; Special Memory Point; Select from map; Memory Point and Freeway Ent/Exit. Enter the required information.

4. Press DEST at the bottom of the map screen.

5. Choose the desired route by pressing the NEXT button (if it appears). There can be up to three alternative routes.

6. Press START to begin the navigation guidance.

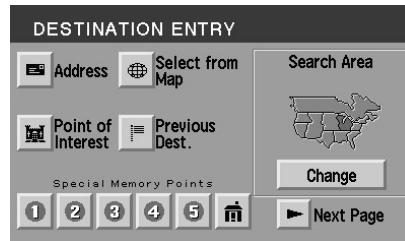

### To adjust the voice guidance volume:

Press On/Off to turn the voice guidance option on/off. Use the numeric keys (1–7) to determine the volume level of the guidance voice prompts.



### Voice activated commands (if equipped)

Your Lincoln Navigation System (LNS) may be equipped with a voice activated feature which allows you to “speak” certain commands to the system. Speaking clearly will help to ensure that the system correctly responds to your commands.

## Entertainment Systems

At any time, you may say these commands:

- AM
- FM1
- FM2
- CD
- DVD (if equipped)

During normal radio operation, you may say:

- Seek up
- Seek down

During CD play with the in-dash 6 disc player:

- Track up
- Track down
- Disc up
- Disc down

While in navigation map mode, the following commands are available by voice activation:

- Zoom in
- Zoom out
- Minimum scale
- Maximum scale

While in navigation destination (DEST) mode, the following commands are available by voice activation:

- Home
- Detour

While in navigation map mode, the following commands are available by voice activation:

- Gas station
- Gas
- Hospital
- Police station
- Restaurant
- Hotel

## Entertainment Systems

### Audio mode

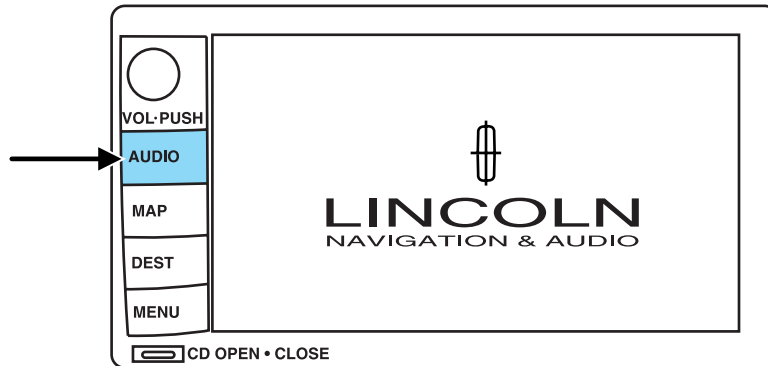

Your Lincoln Navigation Audio System has many features including a full range of audio functions. To access these functions, press AUDIO on the main bezel. This will take you into audio mode.

#### ***Volume/power control***

Press knob to turn the audio system on/off. Turn to raise or lower volume. The levels will be displayed on the screen.

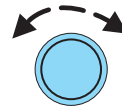

To activate the navigation mode, press MAP or DEST.

To adjust the navigation voice output level, select the NAV MENU button via the map screen.

## Entertainment Systems

### **Speed compensated volume (SCV)**

With this feature, radio volume changes automatically with vehicle speed to compensate for road and wind noise. To engage the SCV feature:



1. Press AUDIO.
2. Press SOUND.

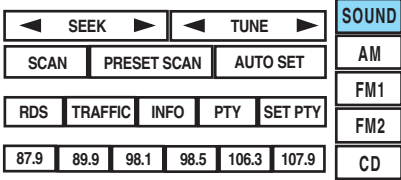

3. SCV is located in the middle of the screen. Press to turn on.
4. Select setting 1 to 7 or turn off.

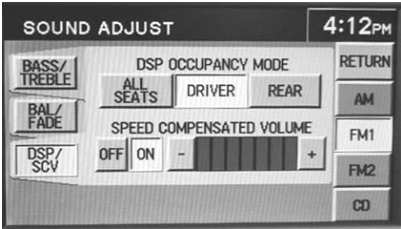

The recommended level for speed sensitive volume is from level 1 through level 3. Level 1 is the minimum setting and level 7 is the maximum setting. The AM/FM control works in radio, CD and navigation modes.

## Entertainment Systems

### AM/FM select in radio mode

Press AM/FM1/FM2 to switch between AM/FM1/FM2 memory preset stations.

### AM/FM select in CD mode

Press to stop CD play and begin radio play.

### AM/FM select in navigation mode

The radio will continue to play in the background of the navigation screens. To access, press AUDIO then AM/FM1/FM2.

### Seek

- Press **▶ / ◀** to find the next listenable station up/down the frequency band.
- Press **▶ / ◀** to advance to the next/previous track on a CD.

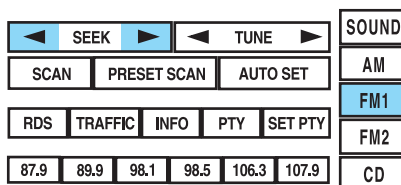

### Tune adjust

Press TUNE to manually move down/up (**◀ / ▶**) the frequency band.

In CD mode, press TRACK to select the previous/next (**◀ / ▶**).

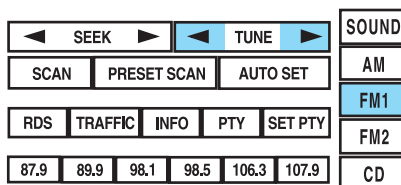

### Scan

Press SCAN for a brief sampling of all listenable stations and CD tracks. Press again to disable and remain on the current selection.

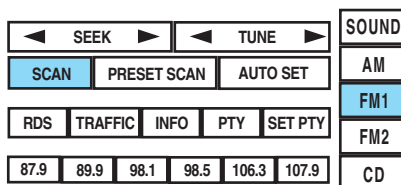

# Entertainment Systems

### **Preset scan**

Press PRESET SCAN to scan the stations stored in the memory presets.

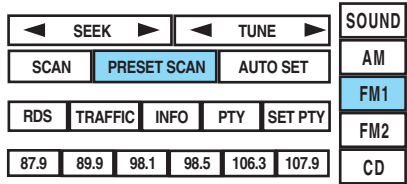

### **Autoset memory preset**

Autoset allows you to set strong radio stations without losing your original manually set preset stations. This feature is helpful on trips when you travel between cities with different radio stations.

#### **Starting autoset memory preset**

1. Select a frequency band using AM/FM1/FM2.

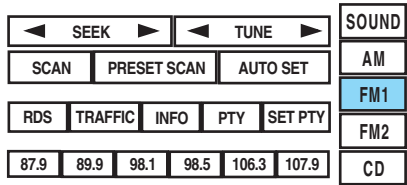

2. Press AUTO SET.

3. When the first six strong stations are filled, the station stored in memory preset control 1 will start playing.

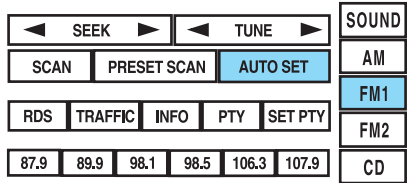

If there are less than six strong stations available on the frequency band, the remaining memory preset controls will all store the last strong station available.

To deactivate autoset and return to your audio system's manually set memory stations, press the AUTO SET again.

## Entertainment Systems

### Radio data system (RDS) feature

This feature allows your audio system to receive text information from RDS-equipped FM radio stations such as station call letters, program type, etc. When in FM mode, press RDS to activate/deactivate.

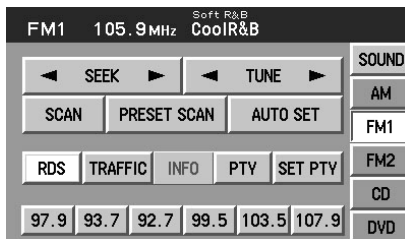

### Traffic function

Select TRAFFIC for traffic information broadcast from certain stations which will automatically interrupt radio or CD playback at a preset volume level.

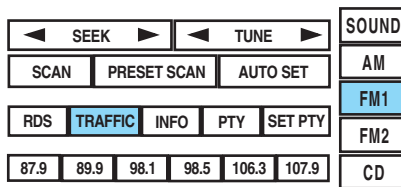

**Traffic information not available in most U.S. markets.**

### Information feature

Press INFO to view the frequency, call letters and PTY category of the selected FM station.

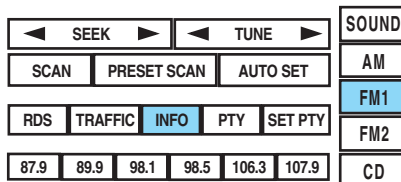

### Program type (PTY)

This feature allows you to search for Radio Data System (RDS) stations selectively by their program type.

## Entertainment Systems

Ensure that the RDS function is turned on. Press PTY to turn the feature on/off.

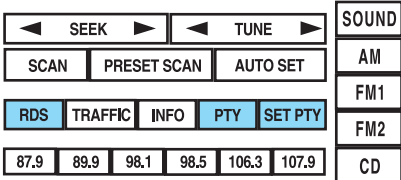

**To set/change PTY:**

Ensure that the RDS function is turned on.  
Press SET PTY to select from the following program types:

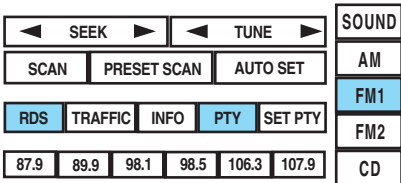

- All
- Classical
- Country
- Information
- Jazz
- Religious
- Rock
- Soft
- Top 40

Once PTY has been programmed, press SEEK (▶ / ◀) or SCAN to initiate a search up or down the frequency.

Preset scan and Autoset also initiate PTY searches. The search will stop when the desired program type has been reached. If no program type is found, a message will display.

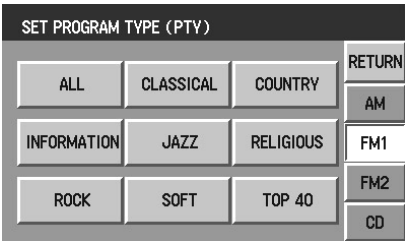

## Entertainment Systems

### Sound functions

To access settings for Bass, Treble, Balance, Fade, DSP (Digital Signal Programming), SCV (Speed Compensated Volume), and Occupancy modes:

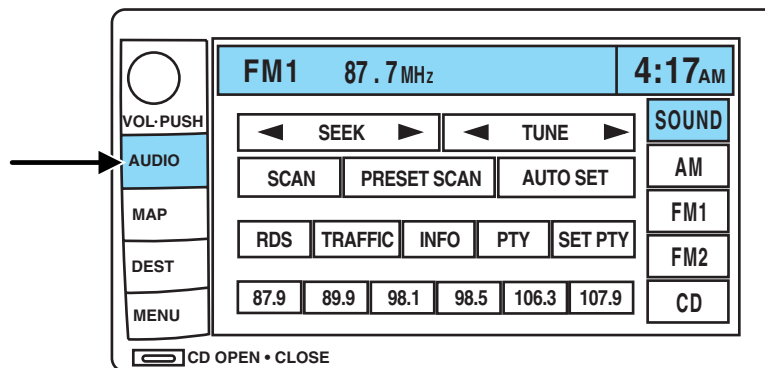

1. Press AUDIO.
2. Press SOUND.
3. Select from Bass/Treb; Bal/Fade; DSP/SCV.
4. Press +/- to increase/decrease the levels.

**Bass** : Allows you to increase or decrease the audio system's bass output.

**Treble** : Allows you to raise or lower the audio system's treble output.

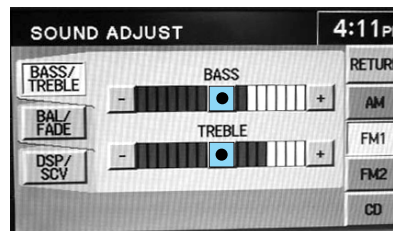

## Entertainment Systems

**Fade** : Allows you to adjust the amount of sound emitted from the front and rear speakers.

**Balance** : Allows you to adjust the sound distribution between the right and left speakers.

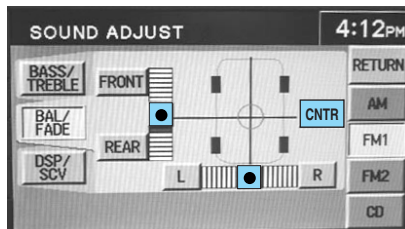

**SCV** (Speed Compensated Volume): Automatically compensates for road wind and noise. Refer to *Speed compensated volume* earlier in this chapter.

**DSP Occupancy mode** :Use to optimize the sound based upon the occupants in the vehicle. Select from ALL SEATS, REAR SEATS or DRIVER SEAT.

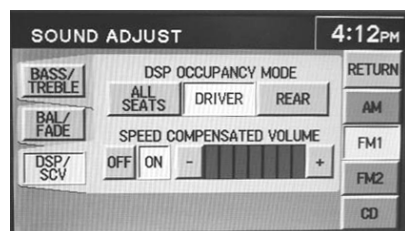

### Setting memory preset stations

The radio is equipped with six station memory preset controls. These controls can be used to select up to six preset AM stations and twelve FM stations (six in FM1 and six in FM2).

1. Select the frequency band with the AM/FM1/FM2 touch controls.
2. Select a station.
3. Press and hold a memory preset until the sound returns. The frequency will appear in the preset.

### CD mode

**CD units are designed to play commercially pressed 12 cm (4.75 in) audio compact discs only. Due to technical incompatibility, certain recordable and re-recordable compact discs may not function correctly when used in Ford CD players. Irregular shaped CDs, CDs with a scratch protection film attached, and CDs with homemade paper (adhesive) labels should not be inserted into the CD player. The label may peel and cause the CD to become jammed. It is recommended that homemade CDs be identified with permanent felt tip marker rather than adhesive labels. Ball point pens may damage CDs. Please contact your dealer for further information.**

## Entertainment Systems

### Playing a previously loaded CD:

To begin CD play (if a CD is already loaded), press AUDIO hard button and then CD.

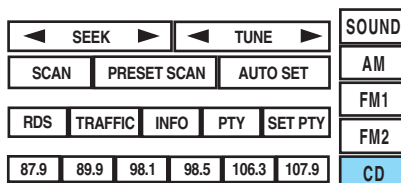

Press CD. CD play will begin where it stopped last.

### Loading a CD:

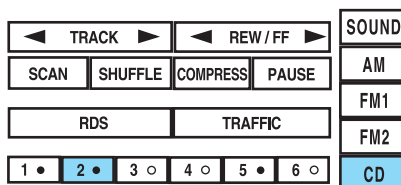

1. Press CD OPEN CLOSE on the bezel.

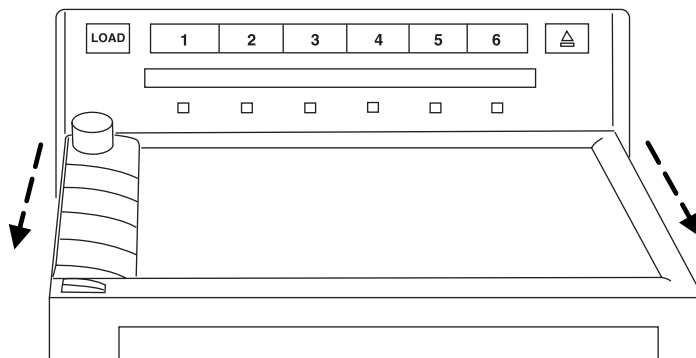

2. The navigation screen will fold down, allowing you access to the in-dash six CD system.

3. Press LOAD and the desired CD slot number. The indicator light will blink slowly at first, then quickly, signaling the system is ready.

4. Insert a disc.

5. **To load more than one disc**, press and hold LOAD. This will initiate autoload and will allow you to load all open CD slots.

## Entertainment Systems

After an allotted time, the screen will close automatically or you may press CD OPEN CLOSE on the bezel again.

6. Once the screen closes, the system will start playing the last CD loaded.

### **Track**

Press **▶ / ◀** to advance to the next/previous track.

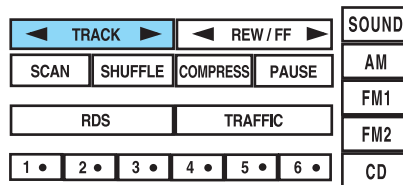

### **Rewind/fast forward in CD mode**

Press to reverse or advance (◀ / ▶) in the current CD track.

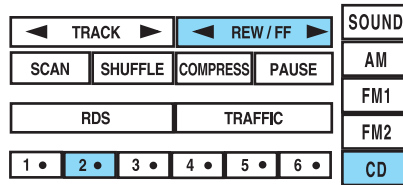

### **Scan feature in CD mode**

Press SCAN to hear a brief sampling of all tracks on the current CD. Press again to disengage and remain with the current track.

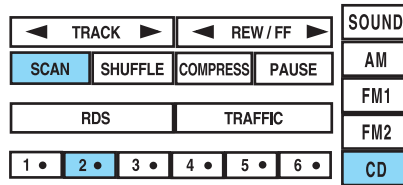

## Entertainment Systems

### **Shuffle feature in CD mode**

When in CD (or CDDJ mode), press SHUFFLE to engage the shuffle feature. Press to select from shuffling between tracks (SHUFFLE TRACK) on the current CD or between all tracks on all CDs (SHUFFLE DISC). All tracks will be played in random order. Press again to disengage (SHUFFLE OFF).

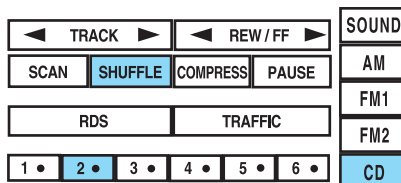

### **Compression feature**

The compression feature works in CD mode and boosts more quiet music and lowers louder music to minimize the need for volume adjustments.

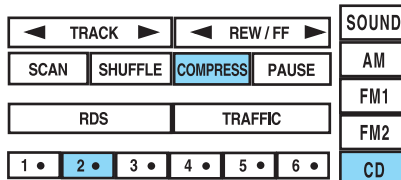

When in CD or CDDJ mode, press COMPRESS to engage or disengage the compression feature.

### **Pause**

In CD mode, press PAUSE to pause the current track. Press again to continue playing.

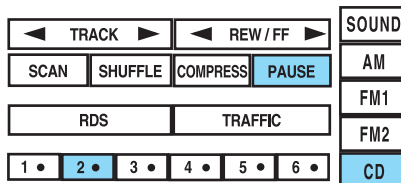

## Entertainment Systems

### Map mode

#### Map display information

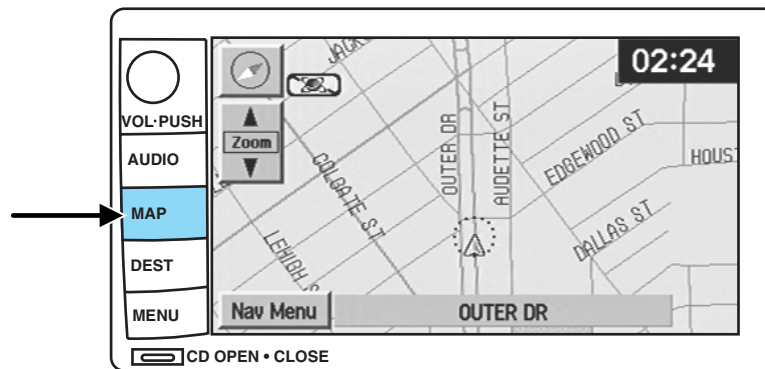

To access the map display, press MAP on the bezel.

Once pressed, the current map display will appear on the screen showing the current vehicle location.



#### Zoom control

When 'Zoom' is pressed, the scale indicator is shown on the screen. The scale markings are: 1/32, 1/16, 1/4, 1/2, 1/8, 1, 2, 4, 8, 16, 32, 64, 128 miles. The control can be used in a number of ways:

- touch and hold one of the arrow buttons for the map to be displayed again at each zoom level.
- touch one of the arrow buttons repeatedly for the map to be displayed again at the final zoom level.
- touch one of the segments of the scale indicator for the map to be displayed at the selected zoom level.

## Entertainment Systems

### **Additional map function buttons**

To initiate the display of additional map function buttons, tap the map anywhere on the screen. The following buttons will appear:

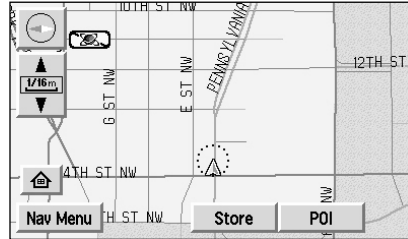

- **STORE** - stores current vehicle location as a memory point. Refer to *Memory Points* for further information.
- **POI** (Point of Interest)- brings up the Quick POI menu which allows the user to perform two functions:  
Display POI icons on the map for one category.  
Select local map area POIs as destinations or waypoints. The list of local area POIs can be sorted by distance, name, or icon. Refer to *Points of Interest* for further information.
- **NEXT** - Press for the system to step through a list of the POIs requested and display them on the map.
- **INFO** - Press to access the address and phone number of a selected POI.

If home has been previously programmed in the “Nav Menu”, the home icon (house) will appear on the screen and is able to be selected as a destination.

To delete POI icons from the map, touch the map again and press the POI off button.

# Entertainment Systems

## Route preferences

After entering a destination, the Route options will appear on the screen showing what is currently selected. You may choose to activate/deactivate selections which the system will factor in when calculating your route. Those options are:

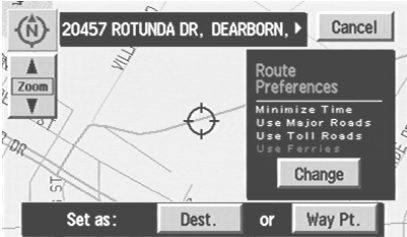

- Minimize Time/Distance
- Use Major Roads
- Use Toll Roads
- Use Ferries



## Screen symbols

**Navigation symbol** — Indicates the current vehicle position and points to the direction in which the vehicle is currently traveling.



**Destination symbol** — Indicates the current route destination.

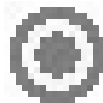

**Next turn symbol** — Shows the next maneuver that will need to be taken on the current route.



## Entertainment Systems

**North up button** — Indicates that the map is displayed with north to the top of the screen. Press to toggle between “North up” and “Heading up” map display states.



**Heading up button** — Indicates that the map is displayed with the vehicle heading to the top of the screen. The position of the pointer indicates the direction of north on the map. Press to toggle between “North up” and “Heading up” map display states.



**Avoid areas or points** — The left-hand symbol indicates an area to be avoided in route calculations. The right-hand symbol indicates an avoid point.



If the avoid point is enlarged to an avoid area, it will appear on the screen as a shaded box.



**Way point symbol** — Indicates the location of a way point (locations you wish to visit in route to your ultimate destination) on the map.



**Home position symbol** — Indicates the location on the map, currently stored as the home position.



**Stored location symbol** — Indicates the location of a memory point. This is the default symbol used when the point is stored. (If desired, an icon of your own choice can be selected from the 15 icons available.) Refer to *Choosing from the icon list*.



# Entertainment Systems

**GPS symbol**— Indicates that insufficient GPS satellite signals are being received for accurate map positioning. The symbol is not displayed under normal operation.



**Speaker icon symbol**— Press to turn voice guidance on/off.



**Navigation menu**

To access the Navigation Menu, press NAV MENU at the bottom of the map screen.



Once pressed, the Navigation Menu will display showing the following options:

- Route Options/Preferences
- Navigation Set Up
- Display Options
- Stored Locations
- On Route Scroll
- Voice Guidance/Volume

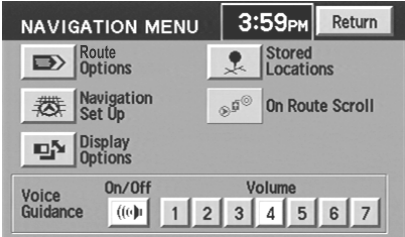

Depending upon whether or not a route is active will determine if route options/route preferences is contained on the Navigation Menu.

**Route options (destination entered)**

Once in navigation mode and a route is currently active, press “Chng. route” to access the ROUTE OPTIONS screen. Choose from the following selections:

- **Detour:** Press to select a detour around the current route. Refer to *Detour options* later in this chapter for further information.
- **Route Preferences:** When creating a destination, select from: Minimize Time/Distance, Use Major Roads, Use Toll Roads, Use Ferries.

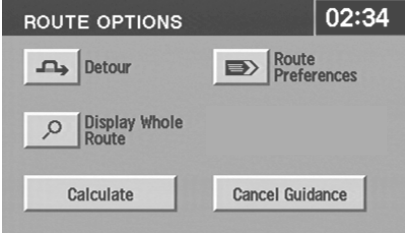

## Entertainment Systems

- **Display Whole Route:** Will enter MAP mode and display your entire chosen route.

**Note:** Route preference appears on the Nav menu when no destination is entered.

 While driving under route guidance, only follow an instruction when it is safe to do so as the system cannot be aware of changing conditions. Use voice guidance as much as possible, and only view the display when driving conditions permit.

 Ensure that you follow highway code restrictions and do not take any risks. For example, if you are unable to make a U-turn, continue on your journey. The navigation system will recalculate your route to get you back to an appropriate road to your destination.

### Navigation set up

The Navigation Set up screen will allow you to make adjustments to the navigation displays.

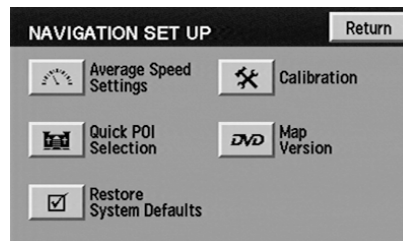

### Average speed settings

Allows you to set approximate speeds you drive. These speeds enable the navigation system to aid in calculating timing for routes.

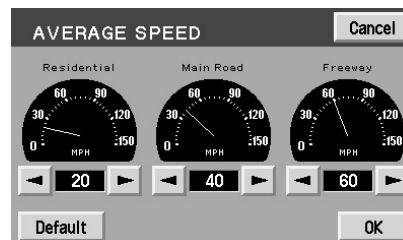

## Entertainment Systems

### **Quick POI (Point of Interest)**

Allows you to change the Quick POI menu settings. Select the desired Quick POI (Gas, ATM, etc.) and then press 'List Categories' for further categories, or 'Map Area POIs' to show the desired POIs on your current map.

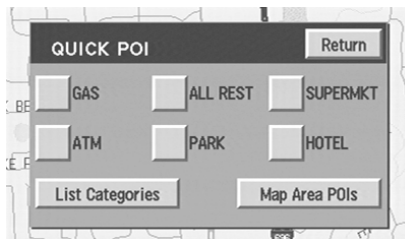

### **Restore system defaults**

Resets all system user-selectable options to the default (automatic) values (i.e, guidance, voice, search area and route preferences).

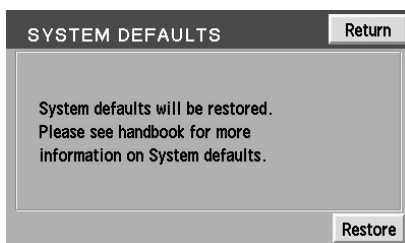

### **Calibration**

This feature is helpful if the car has been towed, or if you notice it is not registering at the correct vehicle location on the map.

Press "Position" to reposition the vehicle location. Press the screen to scroll the map to the desired location and press OK to confirm.

Press "Distance" to calibrate by distance and improve the navigation accuracy. It is recommended to

activate this function after ever tire replacement. When the button is highlighted, calibration is in process and will turn off automatically when complete.

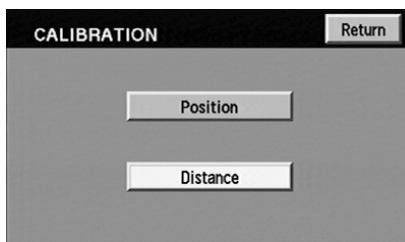

## Entertainment Systems

### **DVD map version**

Displays the version of the inserted navigation DVD. Refer to *Ordering additional map DVDs* for further information.

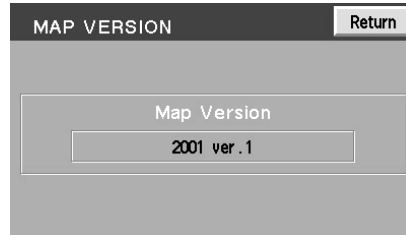

### **Display Options**

The Display Options screen will allow you make adjustments to the navigation display screen. You can choose from:

- Map Mode (Dual or Full)
- Guidance Mode (Arrows or Turn list)
- Guidance Display (On or Off)
- Time to destination (Show or Hide)

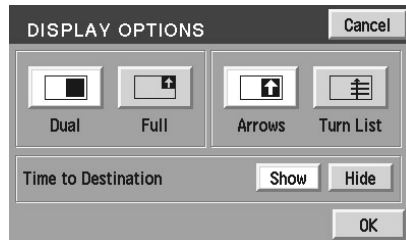
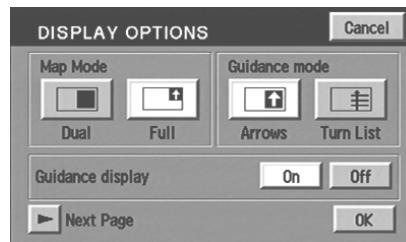

# Entertainment Systems

## **Stored locations**

The Stored locations screen will allow you to choose from destinations that have been saved into the navigation system.

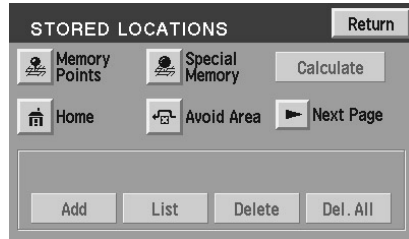

In this screen, you can select from Memory Points, Special Memory Points, Home, Avoid Area, Destination and Way Point, or Previous Destination. Please refer to the *Destination menu* section for a complete description of the functions.

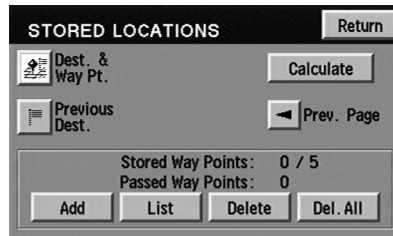

## **On route scroll**

The system automatically scrolls through the entire planned navigation route either forwards or backwards. To activate, press the arrow buttons at the bottom left of the map screen.

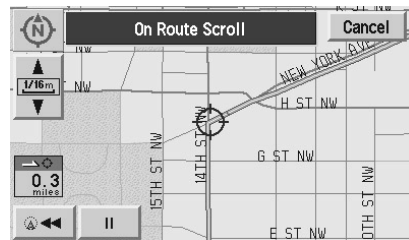

## **Voice guidance/volume**

Allows you to turn the voice guidance option on/off and to determine the volume level of the guidance voice prompts.



## Entertainment Systems

### Destination menu

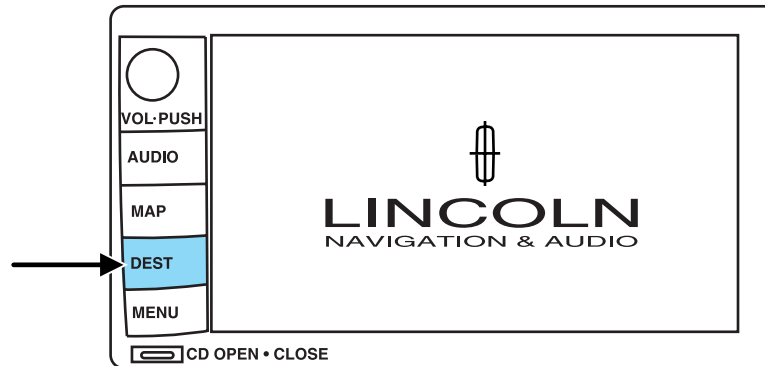

Press DEST on the main bezel to access the navigation mode.

### **Initial map display**

After pressing AGREE to the initial WARNING screen, you will move into the initial map screen which shows the current vehicle location. Pressing the globe icon will take you to the user settings — audible feedback, navigation units, language and clock.

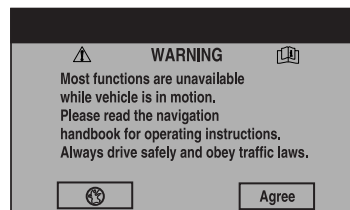

**Note:** There may be a slight time delay between the soft key and the hard key functions.

## Entertainment Systems

### Destination entry

#### Selecting a destination

Press DEST to set a destination. From this menu, you may select from the following options:

- **Address**— Use to select a destination based on a known street address or intersection.
- **Point of Interest**— Use to select a destination that is a point of interest location (i.e., airport, restaurant, hospital).
- **Select from map**—Use to select a place on the map.
- **Previous Destination** — Use to select a destination from among the last 20 entered destinations

Press ► 'Next Page' to access more selections:

- **Memory point** — Use to select from a memory point.
- **Freeway exit/entrance** — Use to select a certain freeway exit or entrance.
- **Special Memory Points** — Use to select a destination from previously stored entries.

#### Search area

Your navigation system uses a regional search area. This area is the area from which navigational directions will be used. To check your area or reset, press CHANGE under the search area listing. The map will open and allow you to select another regional area. Ensure that your search area is correct prior to setting your destination.

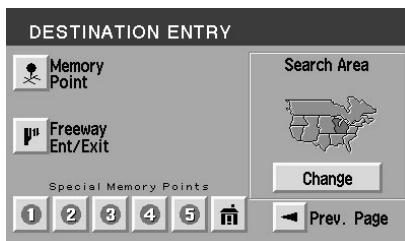
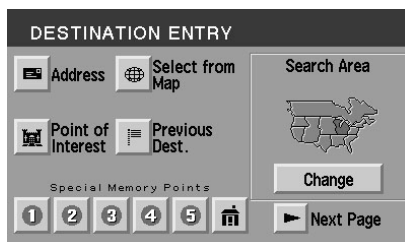

## Entertainment Systems

### Points of interest (POI)

Select “Point of Interest” from the Destination Entry Menu. In this next menu, you will have the following options:

- **By Name**— Enter POI name on the keyboard. Touch “List” to display the list of matching points of interest. If there are too many matches being listed, try entering the town name first.
- **By Category** — Press “Category”. Scroll down the list to select the category, then sub-category desired. Once you have selected a category, your entry of the POI will be restricted to that category.

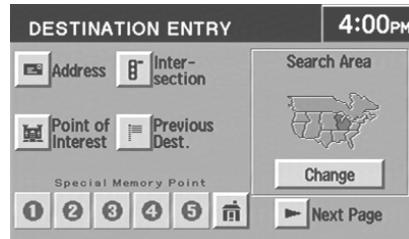

### Previous destination

Press “Previous Destination” on the Destination Entry Menu.

- Select (touch) the desired item from the list of destinations previously reached. The item details will be listed.
- Confirm destination details.



### Deleting previous destination

- Press “Delete”. The list of previous destinations is displayed showing “Delete Previous Destination” at the top of the screen.
- Select (touch) the entry to be deleted. The item details will be listed.
- Press YES to confirm the deletion.
- Press DELETE ALL to delete all previous destination.



## Entertainment Systems

### **Memory point**

Your navigation system allows you to save special destinations you may wish to again visit. Select “Memory Point” from the Destination Entry Menu.

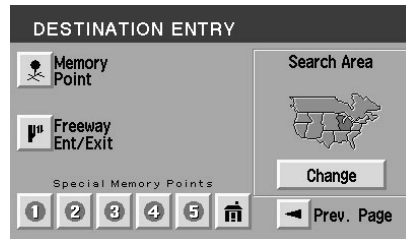

- Select the desired item from the list of stored memory points.
- Confirm destination details.

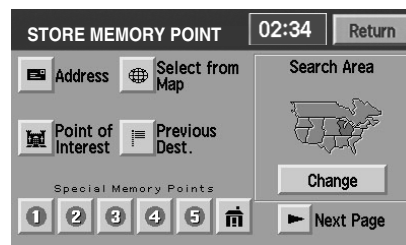

**Note:** The list can be sorted by date, name or icon by pressing the appropriate button.

### **Adding a memory point**

- Once in the Store Memory Point Menu, press ADD.
- Select (touch) the desired menu item.
- Enter/select any required details. The new point will be added to the stored list of memory points.

To give the new memory point a name:

- Select it from the list.
- Press NAME.
- Enter the desired name.

## Entertainment Systems

### Accessing memory point lists

- Press LIST
- Select the desired entry to view its location details.



### Sorting memory point lists

- Access the desired list.
- Press the button to sort the list as desired (i.e. date, name, or icon).

When sorted by distance, the points are ordered by distance from the current vehicle location. When sorting by icon, the icons are listed in the order they appear on the icon selection screen.

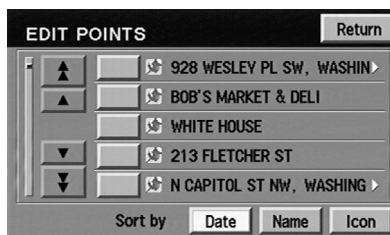

### Choosing from the icon list

After choosing ICON to edit, 15 normal and three audible icons will be displayed. Press the icon you wish to use.

The normal icons will be displayed on the map to indicate the map location identified with that icon. The audible icon will sound a distinctive chime when the vehicle is approaching the memory point associated with that icon.

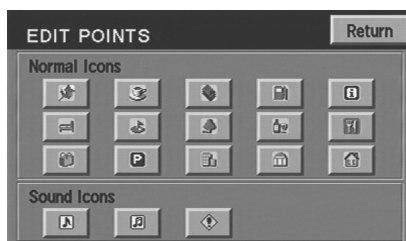

# Entertainment Systems

**Deleting a memory point**

- In the Memory Point Menu, press DELETE.
- Select the entry to be deleted.
- The system will ask you to confirm deletion. Press YES to confirm.

The screen will briefly show “Memory Point Deleted”.

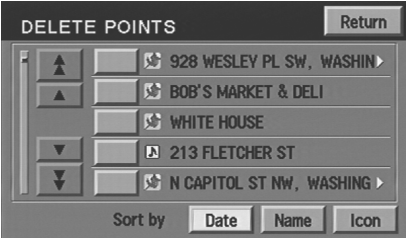

**Deleting all memory points**

- In the Memory Point Menu, press DELETE ALL.



- The system will ask you to confirm deletion. Press YES to confirm.
- The screen will briefly show “All Memory Points Deleted”.

**Home**

To set home for the first time:

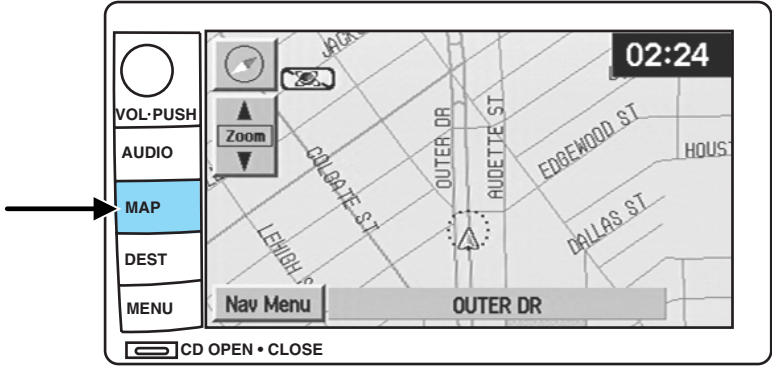

- Press MAP.
- Press “Nav. Menu”.
- Press “Stored Locations.”



## Entertainment Systems

- Press “Home”.
- Press “Add”. Set home by selecting the correct address, POI, Previous destination, or selecting from the map.

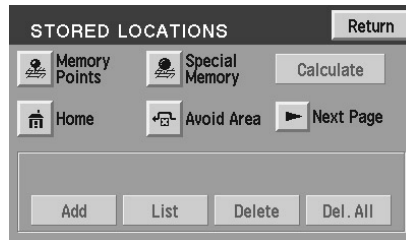

To view home, press the home icon (house) on the Destination Entry screen.

Once home is set, you may select home as a destination.

### **Adding a home location**

- Select the desired menu item you wish to set as Home (Address, Memory Point, Point of Interest, Previous Destination).
- Enter the required details.

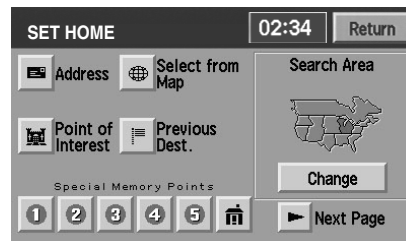

- Press OK to set the home position.

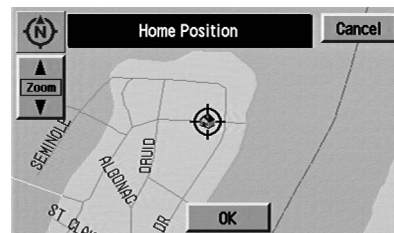

### **To view the set home position:**

From the stored locations menu with home selected, press LIST to view the location of the stored home position.

## Entertainment Systems

### ***Deleting a home location***

- Once in the stored locations menu with home selected, press DELETE.
- The system will ask you to confirm.
- Press YES to confirm.



### ***Freeway Entrance/Exit***

Select "Freeway Entrance/Exit" from the second page of the Destination Entry menu. Follow these steps:

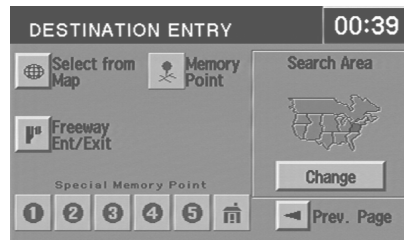

1. **Enter freeway name**— Enter the freeway name using the keyboard. Press "List" to select a freeway from those displayed.

To enter numbers in the freeway name, press "Sym".



## Entertainment Systems

2. **Select entrance/exit**— Press “Entrance” if you wish to join the freeway at this junction. Press “Exit” if you wish to leave the freeway at this junction.

3. **Select Junction**— The screen will display a list of junctions on the freeway. They can be listed either by distance, (from the current vehicle location), by pressing the “Dist” button or alphabetically by pressing the “A-Z” button. Select the desired entrance or exit.

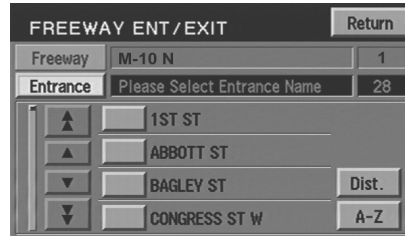

The destination details are displayed for confirmation.

### **Special memory points**

There are five possible memory points that you can set.

#### **To set a memory point:**

- Press MAP.
- Press “Nav Menu”.
- Press “Stored locations”.
- Press “Special Memory Point”.
- Select “Add” and input destination.
- Press OK to confirm.

#### **To delete a memory point:**

- Press “Delete”. The list will display.
- Select the special memory point to delete.
- Press “Del. all” to delete all entered special memory points.
- Press “Yes” to confirm.

Once all five special memory points are entered, the “Add” control will read as “Full”. You must delete points before more can be added.



## Entertainment Systems

### ***Destination and way points***

The Store Dest. & Way Point menu is used after a destination or way point has been entered for the first time using the Destination Entry menu. You can store and delete destinations and way points (locations you wish to visit in route to your ultimate destination). You can also select the order in which you visit them.

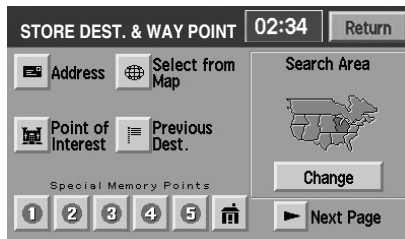

### ***Adding (storing) a destination or way point***

- Once a destination is entered, press ADD to store the location. The Store Dest. & Way Point menu is displayed.
- Select whether you want to store an Address, Point of Interest or Previous Destination.
- Enter the necessary details for the selection.
- If a destination was entered, it will be stored as the current location. If a way point was entered, it will be added to the list of way points.

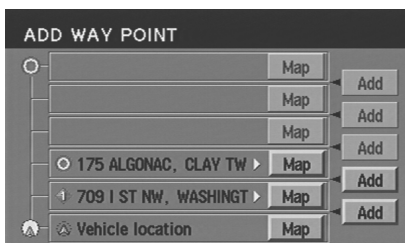

### ***Listing destinations and way points***

Press LIST to display the stored way points and destination (if entered).

The first way point to be visited is at the bottom of the list and the destination is at the top.

You may view the map location of any entry. On the map, location details for the entry are displayed at the top of the screen.

To adjust the position of the way point (or destination), scroll the map as required.

Press OK.

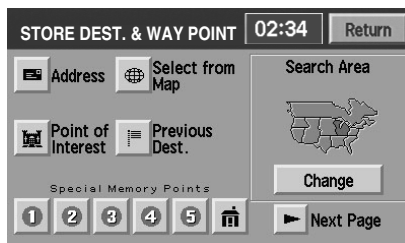

## Entertainment Systems

### **Editing and changing order of way points and destination**

Press “Chg. Order” to change the order in which the way points are visited. The points are listed chronologically from bottom up, the destination being on the top.

Press the MAP button to edit the way point location on the map display.

Press OK to confirm.



### **Deleting way points and destination**

After pressing DELETE, the list of way points and the destination (if entered) is displayed, showing the 'Delete Dest. &Way Pt.' menu.

Select the entry to be deleted. Press YES to confirm.

Press DELETE ALL to delete all way points. Press YES to confirm.



### **Selecting route criteria**

Once you have selected a destination, you may change the routing criteria by pressing “Change” in the route preferences screen. Refer to *Route preferences* for further information.

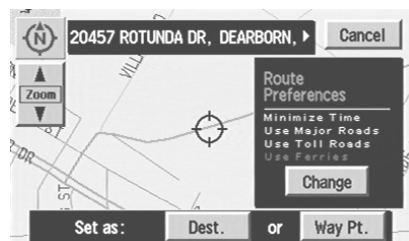

# Entertainment Systems

## **Route calculation**

Once the route criteria is selected, the navigation system automatically calculates the selected destination. The route appears on the display screen and a voice prompt provides instructions.

The system may calculate up to four routes for the desired destination. Press “Next” to scroll through the various planned routes. Press “Start” to confirm the route selection and begin route guidance.

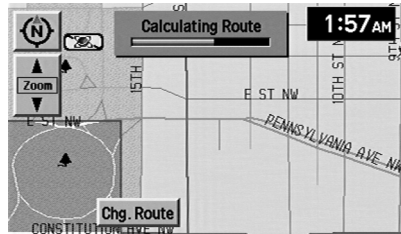

## **Detour options**

You may engage the detour option when on the map display by going to the “Nav menu” and selecting “Route Options”.

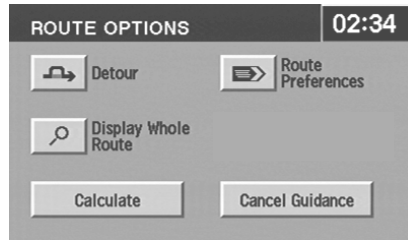

Press DETOUR to activate. Use the soft controls to select and enter the number of miles you want to deviate off of the current road.

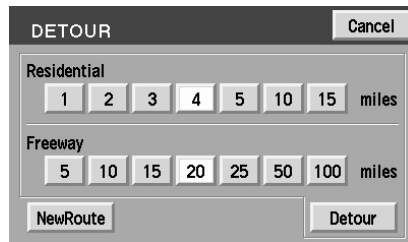

Press NEW ROUTE if you would like the system to plan a different route.

Press DETOUR to confirm the selection.

## Entertainment Systems

### ***Route interruptions***

In the course of your destination, you may decide to temporarily leave your planned route for gas, food, etc. If you turn off the ignition, the option to continue the route guidance will be displayed when the ignition is turned on again. The route can be accessed once again after you press “Agree” on the warning screen.

### ***Route alterations or cancellations***

To cancel or change your current route from the map, press DEST or select “Nav Menu” and “Route Options”. You may then select from Detour, Display whole route, change route preferences or cancel guidance.

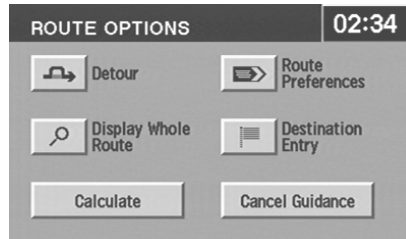

### ***Avoiding an area while under guidance***

For one reason or another, you may choose to avoid a certain area while in route to your destination. To select the area to avoid:

- From the MAP screen, press Nav Menu.
- Select Route Options, then Display Whole Route
- Press Turn List
- Press Avoid next to the street to be avoided
- Choose OK to confirm
- Press Reroute to activate

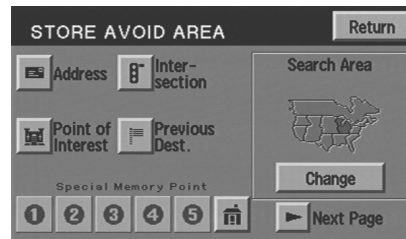

The new area is added to the list of stored avoid areas.

**Note:** In some circumstances, it may not be possible to avoid all selected areas.

## Entertainment Systems

### ***Listing areas to avoid***

You can list all areas noted as “avoid”.

- Press “Nav Menu”.
- Press “Stored locations”.
- Press “Avoid area”.
- Press LIST to view all previously stored selections.
- Select the desired one. The map screen will be displayed, showing the location and address of the selected area.

Press Enlarge or Reduce to adjust the size of the visible area. Scroll the map as required.

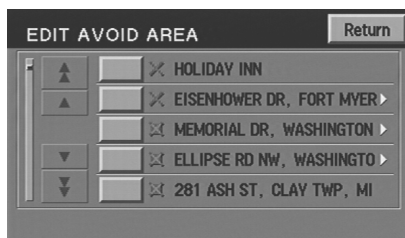

### ***Deleting areas to avoid***

To delete a selection from the “Avoid area” list:

- From the stored locations menu, select “Avoid area”.
- Press DELETE
- Select the desired area to be deleted.
- Press DEL. ALL to delete all stored areas.
- Press YES to confirm.

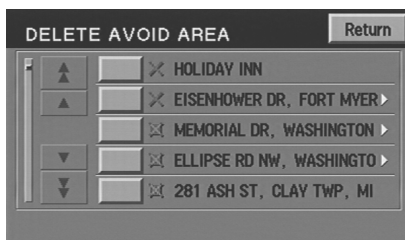

## Entertainment Systems

### Menu mode

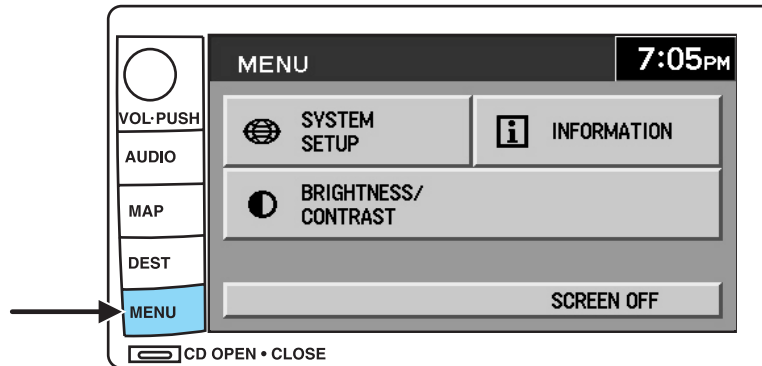

To access menu mode, press the MENU hard control.

Menu mode allows you to access:

- System Set-up
- Information — Gives you the Lincoln Customer Assistance Center information.

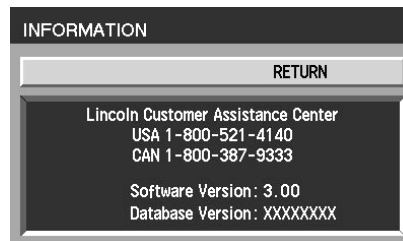

- Brightness/Contrast — Allows you to adjust the brightness and contrast on the screen.

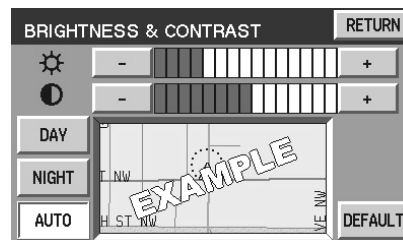

# Entertainment Systems

- Screen off — Allows you to turn off the navigation screen.

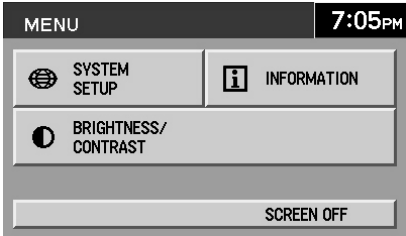

## System setup

The system set up menu contains the following user settings:

- Audible Feedback — Press to activate audible voice navigation commands. Press again to deactivate.
- Navigation Units — Press to toggle between Metric/English units.

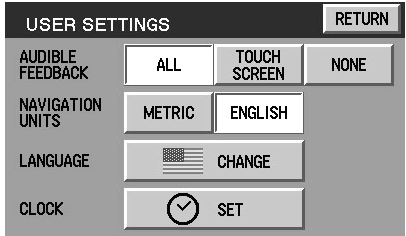

- Language — Press to toggle between English, French, or Spanish.
- Clock (if equipped)

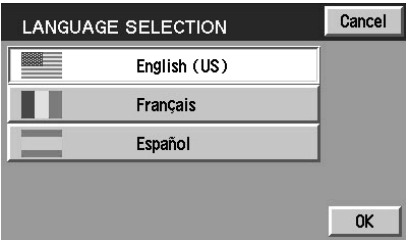

## Entertainment Systems

### ***Setting the clock***

Once in Menu mode, press CLOCK to set the hours/minutes.

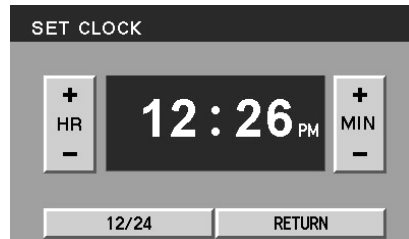

### **Voice activated commands (if equipped)**

Your Lincoln Navigation System (LNS) may be equipped with a voice activated feature which allows you to “speak” certain commands to the system. Speaking clearly will help to ensure that the system correctly responds to your commands.

At any time, you may say these commands:

- AM
- FM1
- FM2
- CD
- DVD (if equipped)

During normal radio operation, you may say:

- Seek up
- Seek down

During CD play with the in-dash 6 disc player:

- Track up
- Track down
- Disc up
- Disc down

While in navigation map mode, the following commands are available by voice activation:

- Zoom in
- Zoom out

## Entertainment Systems

- Minimum scale
- Maximum scale

While in navigation destination (DEST) mode, the following commands are available by voice activation:

- Home
- Detour

While in navigation map mode, the following commands are available by voice activation:

- Gas station
- Gas
- Hospital
- Police station
- Restaurant
- Hotel

### General information

#### ***Safety information***

**Please read and follow all stated safety precautions. Failure to do so may increase your risk of collision and personal injury. Ford Motor Company shall not be liable for any damages of any type arising from failure to follow these guidelines.**

Do not attempt to service, repair or modify the system. See your Ford or Lincoln Mercury dealer.



The driver must not attempt to operate any detailed operation of the navigation system while the vehicle is in motion. Give full attention to driving and to the road. Pull off the road and park in a safe place before performing detailed operations.



If the system is used for an extended period of time with the vehicle stationary, ensure that the engine is running to avoid draining the battery.

Do not apply pressure to the display screen.

The navigation system is not a substitute for your personal judgement.

Route suggestions should not supersede local traffic regulations or safe driving practices.

## Entertainment Systems

Do not follow route suggestions if they direct you to perform an unsafe or illegal maneuver, would place you in an unsafe situation, or would route you into an area that you consider unsafe.

Drivers should not rely on screen displays while their vehicle is in motion. Let the voice guide you. If viewing is necessary, pull off the road to a safe location.

Do not use the navigation system to locate emergency services.

For road safety reasons, the driver should program the system only when the vehicle is stationary. Certain functions will therefore not operate while the vehicle is in motion.

The map database DVD does not reflect road detours, closures or construction, road characteristics such as rough road surface, slope or grade, weight or height restrictions, traffic congestion, weather or similar conditions.

To use the system as effectively and safely as possible, obtain up-to-date map database DVD whenever they become available.

Set the volume level so that you can hear directions clearly.

Do not disassemble or modify the system as this may lead to damage and void your warranty. If a problem occurs, stop using the system immediately and contact your Ford or Lincoln Dealer.

### ***Federal Communication Commission (FCC) Compliance***

Changes or modifications not approved by Ford Lincoln Mercury could void user's authority to operate the equipment. This equipment has been tested and found to comply with the limits for a Class B digital device, pursuant to Part 15 of the FCC Rules. These limits are designed to provide reasonable protection against harmful interference in a residential installation. This equipment generates, uses and can radiate radio frequency energy and, if not installed and used in accordance with the instructions, may cause harmful interference to radio communications.

However, there is no guarantee that interference will not occur in a particular installation. If this equipment does cause harmful interference to radio or television reception, which can be determined by turning the equipment off and on, the user is encouraged to consult the dealer or an experienced radio/TV technician for help.

## Entertainment Systems



The database reflects reality as existing before you received the database and it comprises data and information from government and other sources, which may contain errors and omissions. Accordingly, the database may contain inaccurate or incomplete information due to the passage of time, changing circumstances, and due to the nature of the sources used. The database does not include or reflect information on neighborhood safety, law enforcement, emergency assistance, construction work, road or land closures, vehicle or speed restrictions, road slope or grade, bridge height, weight or other limits, road or traffic conditions, special events, traffic congestion, or travel time.

### **Radio reception factors**

There are certain factors that may effect your radio reception.

- **Distance/strength.** The further an FM signal travels, the weaker it is. The listenable range of the average FM station is approximately 40 km (24 miles). This range can be affected by “signal modulation.” Signal modulation is a process radio stations use to increase their strength/volume relative to other stations.
- **Terrain.** Hills, mountains and tall buildings between your vehicle’s antenna and the radio station signal can cause FM reception problems. Static can be caused on AM stations by power lines, electric fences, traffic lights and thunderstorms. Moving away from an interfering structure (out of its “shadow”) returns your reception to normal.
- **Station overload.** Weak signals are sometimes captured by stronger signals when you pass a broadcast tower. A stronger signal may temporarily overtake a weaker signal and play while the weak station frequency is displayed.

### **Principles of GPS (global positioning system) operation**

Your system directs you based on information derived from global positioning satellites, road maps stored on the DVD, sensors in your vehicle and the desired destination. The system compiles all necessary information to guide you to your selected destination. Space satellites determine the vehicle’s current location and transmit position and time signals to your car.

If the vehicle has been parked for a long period of time, the navigation function may be temporarily unresponsive. The navigation system will operate reliably again once GPS reception is available for a few minutes.

## Entertainment Systems

### ***Limited GPS reception***

System performance may be adversely affected if GPS reception is interrupted or interference occurs over a distance of several miles. The following are possible causes for GPS reception being interrupted. If the vehicle is:

- in multi-story parking garages
- in tunnels and under bridges
- inside or in between buildings
- by forests or tree-lined avenues
- in heavy rain showers and thunderstorms
- in valleys and in mountainous regions
- roads under cliffs

Ensure that you do not have any metal objects on the rear parcel shelf and that if your windows are tinted, they use non-metal tinting instead of metal oxide tinting. Both of these factors can also interrupt GPS reception.

### ***Cleaning the display***

Do not spray cleaning fluid directly onto the unit. Instead, spray onto a soft cloth and gently wipe the unit. Only recommended products should be used.

Do not clean any part of the system with benzene, paint thinner or any other solvent.

Do not spill liquids of any kind onto the unit.

### ***Loading the map DVD***

- Your navigation DVD unit is either located:
  - in the front lower center stack area by the passenger's feet (access door),
  - in the trunk,
  - or in the jack compartment.
- Ensure that the vehicle ignition is ON.
- If a DVD is already loaded in the Navigation unit, push the eject button.
- Load the DVD with the printed side up. Do not allow moisture or foreign objects to enter the slot.

The navigation system utilizes a database stored in a special format on a DVD. It is recommended always to use the latest update of this map DVD.

## Entertainment Systems

- The navigation system will only work with DVDs specifically intended for your navigation system.
- Always store the map DVDs in their protective cases when not in use.

### **Ordering additional map DVDs**

If you wish to order a replacement or additional map, please call 1-888-NAV-MAPS (1-888-628-6277) or to log onto [www.navtech.com](http://www.navtech.com).

### **Latest map DVDs**

The map content is constantly changing due to new roads, traffic restrictions, etc. . Therefore, it is not always possible to exactly match the DVD map with the current roadways. For best results, always use the latest version of the map DVD. Map information is regularly updated, but all areas are not necessarily covered to the same level of detail. Some areas, in particular private roads, may not be included on the database. To help with accuracy, always use the latest DVD version for navigation.

### **Customer service**

If you need help operating your navigation/audio system, want to report a map database error or want to obtain a map DVD, please call 1 (888) 628-6277 (NAV-MAPS) or log onto [www.navtech.com](http://www.navtech.com).

## Climate Controls

### DUAL ELECTRONIC AUTOMATIC TEMPERATURE CONTROL (DEATC) SYSTEM

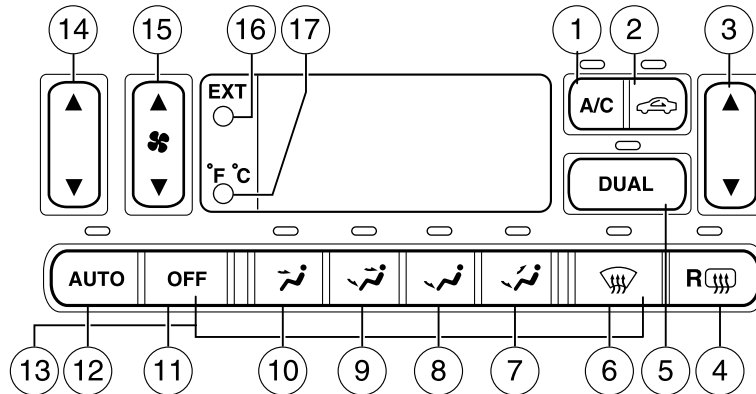

1. **A/C control:** Press to turn on and manually control the air conditioning. Press again to disengage. Press AUTO for the system to automatically control the temperature.



2. **Recirculation control:** Press to engage/disengage. Used to manually enable or disable recirculated air operation. When activated, recirculates air in the cabin thereby reducing the amount of time to cool down the interior of the vehicle. May also help reduce undesired odors from reaching the interior of the vehicle. Will work in all modes except defrost. Recirculation turns off automatically when floor, floor/defrost or defrost mode is selected. To reduce humidity inside the vehicle, turn recirculation off.



3. **Passenger side temperature control:** Press to engage the dual zone feature of the DEATC system. Allows the passenger to choose and control a different temperature than the driver, if desired.



4. **Rear defrost:** Press to defrost the rear window. Refer to *Rear Window Defrost* for more information.





## Climate Controls

5. **DUAL** zone selector: Press to toggle the system between single zone and dual zone control.



6.  (Defrost): Distributes outside air through the windshield defroster ducts and the demister outlets. Can be used to clear ice or fog from the windshield. The system will automatically provide outside air to reduce window fogging.

7.  : Distributes air through the windshield defroster ducts, demister outlets, and the front and rear seat floor ducts. The system will automatically provide outside air to reduce window fogging.

8.  : Distributes air through the floor and rear seat floor ducts. The system will automatically provide outside air to reduce window fogging.

9.  : Distributes air through the instrument panel, center console registers, and the front and rear seat floor ducts.

10.  : Distributes air through the instrument panel and center console registers.

11. **OFF**: Outside air is shut out and the fan will not operate.



12. **Auto**: To engage automatic temperature control, press AUTO and select the desired temperature using the temperature control. The system will automatically determine fan speed, airflow location, A/C on or off, and outside or recirculated air, to heat or cool the vehicle to reach the desired temperature.



13. **Manual override controls**: Allows you to manually select where airflow is directed. To return to full automatic control, press AUTO.



14. **Driver's side temperature control**: Controls the temperature on the driver side of the vehicle in dual zone and controls the temperature of the entire vehicle in single zone.



## Climate Controls

15. **Fan Speed:** Press to manually increase/decrease fan speed. In manual mode, the display will show  with a bar graph to indicate fan speed. Fan speed can be manually adjusted in AUTO mode. To allow the system to automatically control fan speed, press AUTO.



16. **EXT control:** Press to display the outside air temperature. Press again to return to interior temperature. Exterior readings are most accurate when the vehicle is moving.



17. **Temperature conversion:** Press to toggle between Fahrenheit and Celsius temperature on the DEATC display only. The set point temperatures in Celsius will be displayed in half-degree increments.







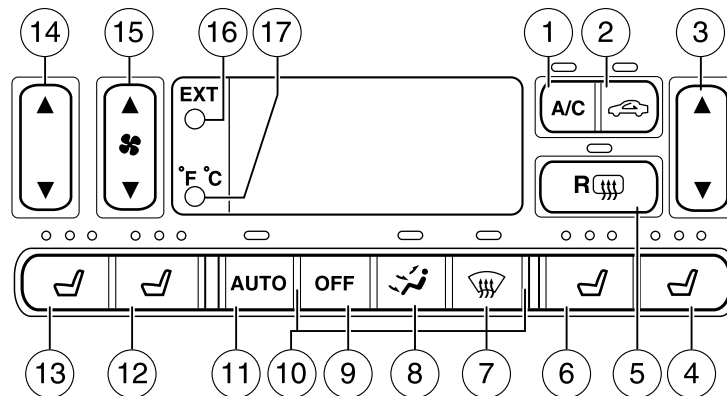

**Heated wiper rest:** Heats the windshield wiper blades in order to reduce the chance of ice buildup and to aid in defrosting. This feature operates automatically when the outside temperature is near or below freezing.

### DUAL ELECTRONIC AUTOMATIC TEMPERATURE CONTROL (DEATC) SYSTEM WITH HEATED AND COOLED SEATS (IF EQUIPPED)



## Climate Controls

1. **A/C control:** Press to turn on and manually control the air conditioning. Press again to disengage. Press AUTO for the system to automatically control the temperature. 
  2. **Recirculation control:** Press to engage/disengage. Used to manually enable or disable recirculated air operation. When activated, recirculates air in the cabin thereby reducing the amount of time to cool down the interior of the vehicle. May also help reduce undesired odors from reaching the interior of the vehicle. Will work in all modes except defrost. Recirculation turns off automatically when floor, floor/defrost or defrost mode is selected. To reduce humidity inside the vehicle, turn recirculation off. 
  3. **Passenger side temperature control:** Press to engage the dual zone feature of the DEATC system. Allows the passenger to choose and control a different temperature than the driver, if desired. 
  4. **Passenger heated seat:** Press to turn on the passenger side heated seat. Press once for full heat (three lights above passenger heated seat control will be illuminated). Press a second time to select medium heat (two lights). Press a third time to select low heat (one light). Press a fourth time to disengage the feature (all lights will be off).
  5.  (Rear defrost): Press to defrost the rear window. Refer to *Rear Window Defrost* for more information.
  6. **Passenger cooled seat:** Press to turn on the passenger side cooled seat. Press once for full cool (three lights above passenger cooled seat control will be illuminated). Press a second time to select medium cool (two lights). Press a third time to select low cool (one light). Press a fourth time to disengage the feature (all lights will be off).
- Automatic heated/cooled passenger seat:** To engage, press the passenger side heat and cool seat controls simultaneously. The center light above the passenger side heated and cooled controls will illuminate and the display will show . This allows the seat to automatically heat or cool based on the climate control temperature selected. Press either control to disengage.
7.  (Defrost): Distributes outside air through the windshield defroster ducts and the demister outlets. Can be used to clear ice or fog from the windshield. The system will automatically provide outside air to reduce window fogging.

## Climate Controls

8.  **Airflow direction control:** Press to toggle through the air distribution modes listed below. The selected mode will illuminate in the display.

 —Distributes air through the windshield defroster ducts, demister outlets and the front and rear seat floor ducts. The system will automatically provide outside air to reduce window fogging.

 : Distributes air through the floor and rear seat floor ducts. The system will automatically provide outside air to reduce window fogging.

 : Distributes air through the instrument panel, center console registers, and the front and rear seat floor ducts.

 : Distributes air through the instrument panel and center console registers.

9. **Off:** Outside air is shut out and the fan will not operate.

OFF

10. **Manual override controls:** Allows you to manually select where airflow is directed. To return to full automatic control, press AUTO.

11. **Auto:** Press to engage automatic temperature control. Use the temperature control to select the desired temperature setting. The system will automatically determine fan speed, airflow location, A/C on or off, and outside or recirculated air to heat or cool the vehicle, allowing it to reach the desired temperature. Press and hold AUTO for about two seconds to toggle between single zone and dual zone temperature control.

AUTO

12. **Driver heated seat:** Press to turn on the driver side heated seat. Press once for full heat (three lights above driver heated seat control will be illuminated). Press a second time to select medium heat (two lights). Press a third time to select low heat (one light). Press a fourth time to disengage the feature (all lights will be off).

13. **Driver cooled seat:** Press to turn on the driver side cooled seat. Press once for full cool (three lights above driver cooled seat control will be illuminated). Press a second time to select medium cool (two lights). Press a third time to select low cool (one light). Press a fourth time to disengage the feature (all lights will be off).

**Automatic heated/cooled driver seat:** To engage, press the driver side heat and cool seat controls simultaneously. The center light above the driver side heated and cooled controls will illuminate and the display will

## Climate Controls

show . This allows the seats to automatically heat or cool based on the climate control temperature selected. Press either control to disengage.

### 14. Driver's side temperature

**control:** Controls the temperature on the driver side of the vehicle in dual zone and controls the temperature of the entire vehicle in single zone.



15. **Fan Speed:** Press to manually increase/decrease fan speed. In manual mode, the display will show  with a bar graph to

indicate fan speed. Fan speed can be manually adjusted in AUTO mode. To allow the system to automatically control fan speed, press AUTO.



16. **EXT control:** Press to display the outside air temperature. Press again to return to interior

temperature. Exterior readings are most accurate when the vehicle is moving.



### 17. Temperature conversion:

Press to toggle between Fahrenheit and Celsius temperature on the DEATC display only. The set point temperatures in Celsius will be displayed in half-degree increments.



**Heated wiper rest:** Heats the windshield wiper blades in order to reduce the chance of ice buildup and to aid in defrosting. This feature operates automatically when the outside temperature is near or below freezing.

## OPERATING TIPS

- To reduce fog build up on the windshield during humid weather, place the air flow selector in the  position.
- To reduce humidity build up inside the vehicle:  
Do not drive with the air flow selector in the OFF position.  
Do not drive with recirculation engaged.
- In order to allow the vehicle to “breathe” using the outside air inlet vents, do not leave the air flow selector in the OFF position when the vehicle is parked.
- Do not put objects under the front seats that will interfere with the airflow.

## Climate Controls

- Remove any snow, ice or leaves from the air intake area at the base of the windshield.
- With the ignition in the OFF position after operating the vehicle, some vehicle sounds related to the climate control system may be heard.
- Approximately two minutes after key off, the air distribution doors may adjust their positions as part of the normal operating process.
- Demisters, located at the far left and right sides of the dash, usually blow out a small amount of airflow in order to reduce side window fogging.
- Outboard panel registers, located at the left and right sides of the dash, blowout a small amount of airflow when in Floor, Floor/Defrost, and Defrost modes. This also reduces side window fogging.
- Do not place items over the climate temperature sensor grid. This may cause improper operation of the system.

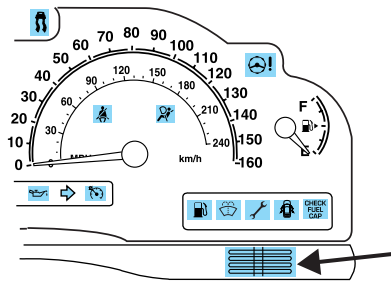

To aid in side window defogging/demisting in cold weather:

1. Select 
2. Ensure that recirculation is disengaged.
3. Set the temperature control to full heat.
4. Set the highest fan speed
5. Direct the outer instrument panel vents towards the side windows.

To increase airflow to the outer instrument panel vents, close the vents located in the middle of the instrument panel.



Do not place objects on top of the instrument panel as these objects may become projectiles in a collision or sudden stop.

## Climate Controls

### REAR WINDOW DEFROSTER

Press the rear window defroster control to clear the rear window and sideview mirrors of thin ice or fog. The light above the control will illuminate to indicate that the rear defrost is operating.

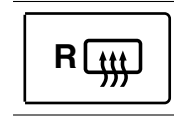

The ignition must be in the RUN position and the engine running in order to operate the rear window defroster.

The rear window defroster turns off automatically after a predetermined amount of time, if a low battery condition is detected, or if the ignition is turned to the OFF position. To manually turn off the rear window defroster at any time, press the control again.

### CABIN AIR FILTER

Your vehicle is equipped with a particulate air filtration system. The system is designed to reduce the concentration of airborne particles such as dust, spores and pollen in the air being supplied to the interior of the vehicle. The particulate filtration system gives the following benefits to customers:

- Improves the customer's driving comfort by reducing particle concentration
- Improves the interior compartment cleanliness
- Protects the climate control components from particle deposits

The filter is located just in front of the windshield under the cowl grille on the passenger side of the vehicle.

For more information, or to replace the filter, see your Ford, Lincoln or Mercury Dealer.

## Lights

### HEADLAMP CONTROL ☀

- Turns the lamps off.
- ☀ Turns on the parking lamps, instrument panel lamps, license plate lamps and tail lamps.
- ☀ Turns the headlamps on.

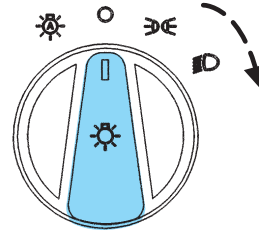

### Autolamp control ☀

The autolamp system provides light sensitive automatic on-off control of the exterior lights normally controlled by the headlamp control.

- To turn autolamps on, rotate the control counterclockwise to the auto position.
- To turn autolamps off, rotate the control clockwise to the off position (○).

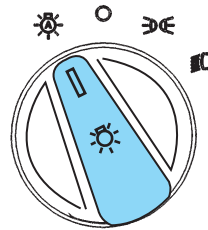

The autolamp system also keeps the lights on for a period of time after the ignition switch is turned to OFF. The period of time that the lights remain on is set at the factory but the time may be adjusted using the sequence below.

#### *Exit delay programming sequence*

1. Start with the ignition in the RUN position and autolamps selected on the headlight switch.
2. Turn the ignition to the OFF position. (This will start a 10 second timer during which steps 3 through 6 must be completed.)
3. Turn the autolamps OFF.
4. Turn the ignition to the RUN position.
5. Turn the ignition to the OFF position.
6. Turn the autolamps on (The park lamps and low beams will turn on.)
7. Turn the autolamps off after the desired delay time is reached. (The maximum programmable delay is 3 minutes. The lights that turned on in step 6 will turn off.)

## Lights

### *Autolamps with wipers*

When the windshield wipers are on with the headlamps, the autolamp system will provide automatic on/off control of the exterior lights based on the status of the wipers.

- When the wipers are turned on, the exterior lights will turn on after a short delay.
- When the wipers are turned off, the exterior lights will turn off after a short delay.

Note: The moisture sensitive wipers feature may affect the length of the autolamp time delay.

### **Foglamp control**

The foglamps can be turned on when the headlamp control is pulled toward you and is in any of the following positions:

- Parking lamps
- Low beams
- Autolamps

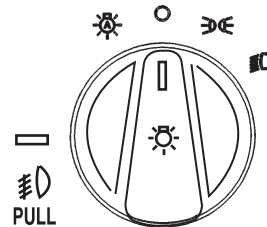

### **Daytime running lamps (DRL) (if equipped)**

Turns the highbeam headlamps on with a reduced output.

To activate with automatic transmission:

- the ignition must be in the RUN position;
- the headlamp control is in the OFF position, Parking lamps position, or Autolamp position when the autolamp function has not turned on the headlamps (daytime); and
- the transmission is out of Park.

 Always remember to turn on your headlamps at dusk or during inclement weather. The Daytime Running Light (DRL) System does not activate your tail lamps and generally may not provide adequate lighting during these conditions. Failure to activate your headlamps under these conditions may result in a collision.

## Lights

### High beams

Pull toward you until control stops to activate. Repeat to deactivate.

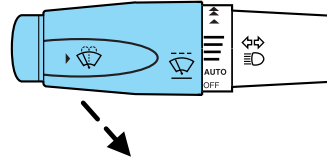

### Flash to pass

Pull toward you slightly to activate and release to deactivate.

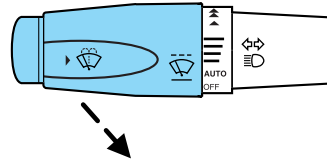

### PANEL DIMMER CONTROL

Use to adjust the brightness of the instrument panel during parklamp, headlamp and autolamp operation.

- Rotate up to brighten.
- Rotate down to dim.
- Rotate fully up to turn on the interior lights.

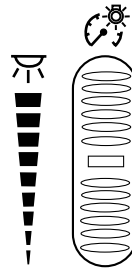

Note: The panel dimmer control is not active when the autolamp system has determined that it is daytime.

### HEADLAMP VERTICAL AIM ADJUSTMENT

Your vehicle is equipped with VOL (Visual Optical Left) headlamps.

1. Park the vehicle on a level surface approximately 7.6 meters (25 feet) from a vertical wall or screen directly in front of it.

## Lights

- (1) Eight feet
- (2) VOL - subtract 50 mm (2.1 in) from the measurement of the center of the low beam lamp to the ground.
- (3) Twenty five feet
- (4) Horizontal reference line

2. Measure the height from the center of your headlamp to the ground and mark a 2.4 meter (8 foot) horizontal reference line on the vertical wall or screen 50 mm (2.1 in) below this height (a piece of masking tape works well). The center of the lamp is marked by a 3.0 mm circle on the headlamp lens (use the low beam center mark).

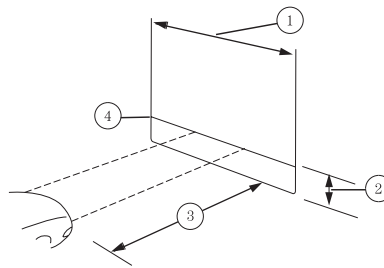

- (1) Eight feet
- (2) VOL - subtract 50 mm (2.1 in) from the measurement of the center of the low beam lamp to the ground.
- (3) Twenty five feet
- (4) Horizontal reference line

3. Turn on the low beam headlamps to illuminate the wall or screen and open the hood.

4. On the wall or screen you will observe a light pattern with flat edges at the top of the beam pattern. If the flat edges are not at the horizontal reference line, the beam will need to be adjusted.

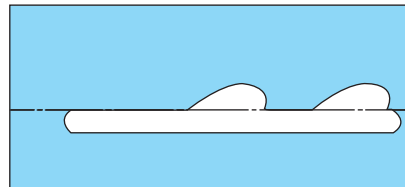

5. Locate the vertical adjuster on each headlamp, then use a 6 mm allen wrench or screwdriver to adjust the headlamp up or down.

6. HORIZONTAL AIM IS NOT REQUIRED FOR THIS VEHICLE AND IS NON-ADJUSTABLE.

7. Close the hood and turn off the lamps.

## Lights

### TURN SIGNAL CONTROL ⇐⇒

- Push down to activate the left turn signal.
- Push up to activate the right turn signal.

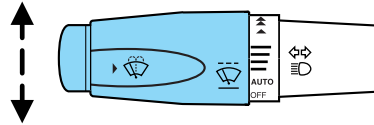

### INTERIOR LAMPS

#### Map lamps (if equipped)

The map lamps and controls are located on the dome lamp. Press the controls in front of each map lamp to activate the lamps.

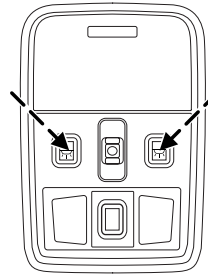

### BULBS

#### Replacing exterior bulbs

Check the operation of all the bulbs frequently.

#### Using the right bulbs

Replacement bulbs are specified in the chart below. Headlamp bulbs must be marked with an authorized "D.O.T." for North America and an "E" for Europe to assure lamp performance, light brightness and pattern and safe visibility. The correct bulbs will not damage the lamp assembly or void the lamp assembly warranty and will provide quality bulb burn time.

## Lights

Function	Trade Number
Headlamp low beam	H11LL
Headlamp low beam (HID)	D2R
Headlamp high beam	9005
Park and turn lamp (front)	3457 A/K (amber)
Side marker lamp (front)	3W4Z-15A424-5-AA
Foglamp	9145
Tail lamp, brakelamp, side lamp	3157K
Rear turn lamp	3157 A/K (amber)
Backup lamp	921
License plate lamp	168
High-mount brakelamp	3W4Z-13A613-AA
Map lamp (with moon roof)	906
Rail lamp (rear)	168
Map lamp (front)	906
Sun visor lighted mirror lamp	Part # E9SB-13465-BA
Glove compartment	194
Ashtray	194
Luggage compartment lamp	212-2
All replacement bulbs are clear in color except where noted.	
To replace all instrument panel lights - see your dealer.	

### Interior bulbs

Check the operation of all bulbs frequently.

### **Map lamps**

For bulb replacement, see a qualified service technician or your dealer.

## Lights

### Replacing headlamp bulbs

The headlamp assembly contains the low beam bulb, the high beam bulb, park/turn lamp bulb and led side marker. To replace any of these items, the headlamp assembly must be removed from the vehicle as follows:

1. Make sure headlamp switch is in the OFF position, then open the hood.
2. Lift the hood and remove the upper and lower sight shields by removing the seven plastic retaining pins.
3. On the headlamp assembly, remove the three headlamp attaching bolts (8mm socket).

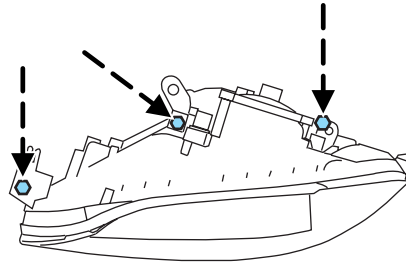

### Replacing headlamp bulbs - lowbeam

1. Remove the headlamp assembly as described under the *Replacing exterior bulb* header.
2. Remove the four T20 torx head screws holding the bulb retaining cover on.
3. Turn the bulb counterclockwise and remove it by pulling the bulb straight out.
4. Disconnect the electrical connector.

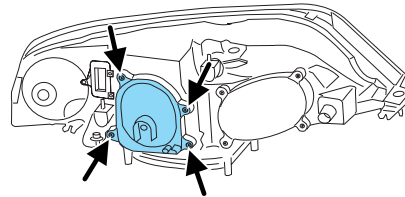

Handle a halogen headlamp bulb carefully and keep out of children's reach. Grasp the bulb only by its plastic base and do not touch the glass. The oil from your hand could cause the bulb to break the next time the headlamps are operated.

Install the new bulb in reverse order, while also replacing the seal on the bulb retaining cover. The kits for replacement seals are available at Lincoln or Ford dealers.

## Lights

### ***Replacing HID headlamp bulb (if equipped)***

The low beam headlamps on your vehicle use a “high intensity discharge” source. These lamps operate at a high voltage. The bulb is NOT replaceable. When the bulb is burned out, the lamp assembly must be replaced by your dealer or a qualified technician.

### ***Replacing headlamp bulbs - highbeam***

1. Remove the headlamp assembly as described under the *Replacing exterior bulb* header.
2. Remove the four T20 torx head screws holding the bulb retaining cover on.
3. Turn the bulb counterclockwise and remove it by pulling the bulb straight out.
4. Disconnect the electrical connector.

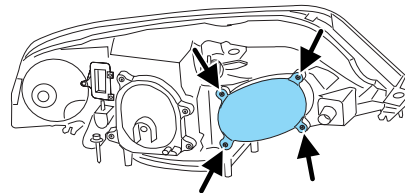

Install the new bulb in reverse order, while also replacing the seal on the bulb retaining cover. The kits for replacement seals are available at Lincoln or Ford dealers.

### ***Replacing the LED sidemarker***

1. Remove the headlamp assembly as described under the *Replacing exterior bulb* header.
2. Remove the three T20 torx head screws holding the bulb retaining cover on.
3. Pull the LED assembly straight out and replace with a new assembly.

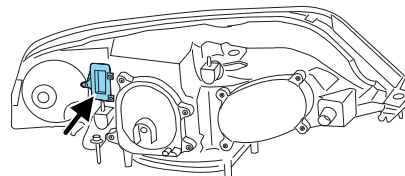

Install the new assembly in reverse order, while also replacing the seal on the bulb retaining cover. The kits for replacement seals are available at Lincoln or Ford dealers.

## Lights

### **Replacing front parking lamp/turn signal lamp bulbs**

1. Remove the headlamp assembly as described under the *Replacing exterior bulb* header.
2. Turn the bulb counterclockwise and pull it straight out of the headlamp assembly.

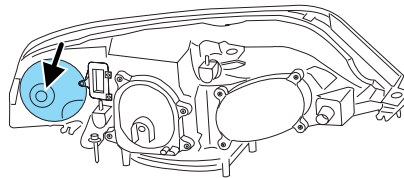

Install the new bulb in reverse order.

### **Replacing foglamp bulbs**

1. Make sure the headlamp switch is in the OFF position and disconnect the electrical connector from the foglamp bulb.
2. Rotate the foglamp bulb counterclockwise and remove from the foglamp.

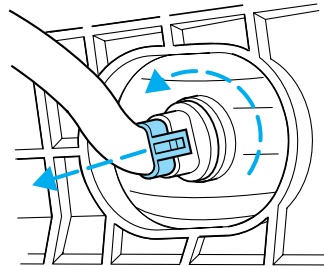

Install the new bulb in reverse order.

## Lights

### ***Replacing high-mount brakelamp bulbs***

Your vehicle is equipped with an LED center high-mount stop lamp. It is designed to last the life of the vehicle. If replacement is required, the entire assembly must be replaced as follows:

1. Pull down on the headliner, near the location of the high-mount stop lamp, to release the dual lock attachment.
2. Expose enough of the high-mount stop lamp to disconnect the electrical wire and remove the two retaining bolts (8 mm head).

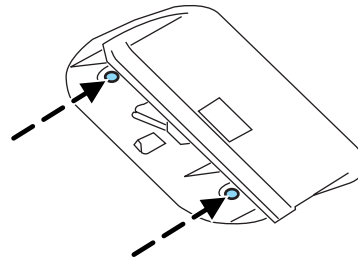

3. Remove and replace the high-mount stop lamp bulb.

Install the new lamp in reverse order.

### ***Replacing tail lamp/backup bulbs***

For bulb replacement, see a dealer or qualified technician.

### ***Replacing license plate lamp bulbs***

For bulb replacement, see a dealer or qualified technician.

## Driver Controls

### MULTI-FUNCTION LEVER

**Windshield wiper:** Rotate the end of the control away from you to increase the speed of the wipers; rotate towards you to decrease the speed of the wipers.

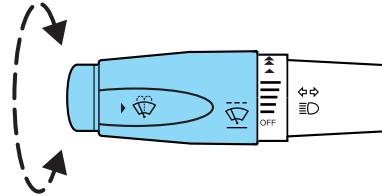

**Windshield washer:** Push the end of the stalk:

- Quickly pressing the end of the stalk switch causes a single wipe without washer fluid.
- Push and hold the end of the stalk to activate the washer. The wash cycle will continue for up to ten seconds or until released. After release, there will be three clearing wipes.

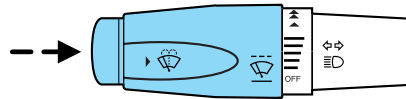

**Note:** The windshield wiper will not automatically cycle if the washer fluid is low, refer to *Windshield washer fluid* in the *Maintenance and Specifications* chapter.

### Moisture sensitive wipers (if equipped)

The moisture sensitive wipers will automatically activate when moisture is present on the windshield and the multifunction switch is set to one of five Auto sensitivity settings. The five Auto sensitivity settings determine how often the wipers will wipe based upon the moisture on the windshield. Rotating the knob from the Auto position towards the windshield selects a higher sensitivity and more wipes will occur. For fewer wipes, select a lower setting.

The wipers will continue to wipe as long as the presence of moisture is detected on the windshield. The number of wipes that occur will vary based on the amount of moisture detected on the windshield and the Auto setting. The sensitivity to moisture is automatically increased at night. When the ignition is turned ON, the wipers will perform one wipe if one of the five Auto settings is selected.

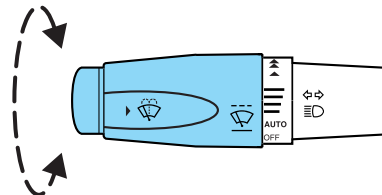

## Driver Controls

More or less wiping may occur under the following conditions:

- on cool mornings with high humidity
- in very light mist or rain
- salty water/mist
- hydrophobic coating applied to the windshield such as Rain-X or wax (use of these types of coatings are not recommended)

You can override the moisture sensitive wiper function by selecting HIGH, LOW and OFF.

The moisture sensitive wiper feature should be turned OFF prior to entering a car wash.

### Changing the wiper blades

To replace the wiper blades:

1. Pull the passenger side wiper arm away from the windshield into the service position. Turn the blade at an angle from the wiper arm.

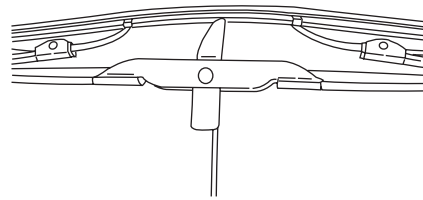

2. Firmly press the release tab from the bottom side of the wiper arm to unlock wiper blade from wiper arm.

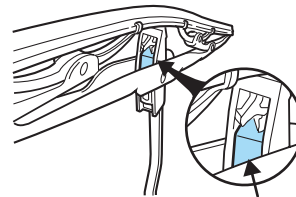

3. Pull the wiper blade down toward the windshield to remove it from the arm.

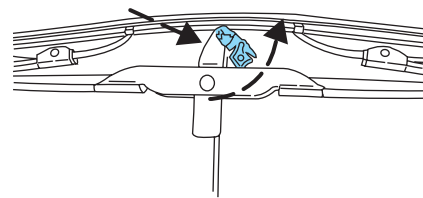

## Driver Controls

4. Attach the new wiper to the wiper arm and reposition the clip until it locks.

Repeat for driver's side wiper arm.

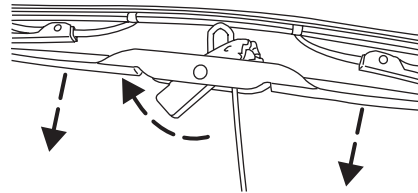

### POWER TILT/TELESCOPE STEERING COLUMN

The steering column can be adjusted manually by moving the four-way rocker adjustment control located below the turn signal/wiper control stalk. Hold the control to adjust.

The telescope function is adjusted by moving the control toward the driver to telescope out and toward the instrument panel to telescope in.

The tilt function is adjusted by moving the control up or down.

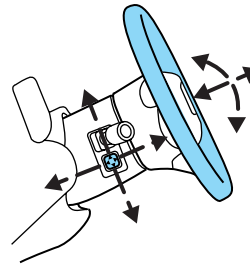

### Easy entry/exit feature

When you remove the key, the column will move, if this feature is activated through the Message Center, to the full in and up position, refer to the *Message Center* in the *Driver Controls* chapter. When the key is inserted into the ignition, the column will return to the previous setting.

### Memory feature

The steering column positions are saved when doing a memory set function and can be recalled along with the vehicle personality features when a memory position is selected through the remote entry transmitter, keyless entry keypad or memory switch on the driver's door (if equipped with memory feature). Refer to *Memory seats/steering column/mirrors/adjustable pedals* in the *Seating and Safety Restraints* chapter.

If the steering column adjustment control is pressed during memory recall it will cancel the automatic operation and the column will respond to manual adjustment of the control.

## Driver Controls



Never adjust the steering wheel when the vehicle is moving.

### STEERING COLUMN LOCK (IF EQUIPPED)

The steering column will automatically lock when the key is removed from the ignition. When the vehicle key is inserted into the ignition, the steering column will automatically unlock.

### ILLUMINATED VISOR MIRROR

To turn on the visor mirror lamps, lift the mirror cover. Adjust the amount of light by sliding the control.

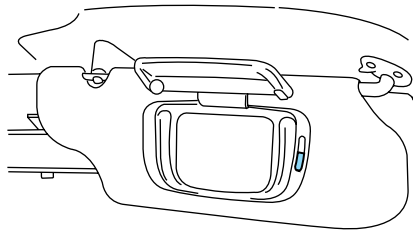

### OVERHEAD CONSOLE

The appearance of your vehicle's overhead console will vary according to your option package.

#### Storage compartment

Press to open the storage compartment.

The storage compartment may be used to secure sunglasses or a similar object.

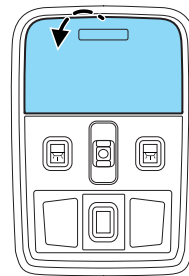

### AUXILIARY POWER POINT 12V

**Power outlets are designed for accessory plugs only. Do not hang any type of accessory or accessory bracket from the plug. Improper use of the power outlet can cause damage not covered by your warranty.**

## Driver Controls

The auxiliary power point is located on the instrument panel next to the cigarette lighter. Push the top door to access the power point.

**Do not plug optional electrical accessories into the cigarette lighter. Use the power point.**

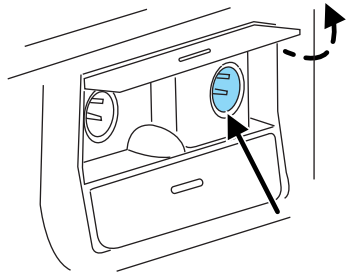

## POWER WINDOWS

 When closing the power windows, you should verify they are free of obstructions and ensure that children and/or pets are not in the proximity of the window openings.

Press the rocker switches to open and close windows.

- Press the bottom portion of the rocker switch to open.
- Press the top portion of the rocker switch to close.

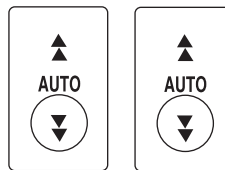

### Express Down (One Touch Down)

To make the front driver or passenger windows open fully without holding the window control, press the bottom portion of the driver window control completely down to the second detent or "Express Down" position. Press the control in either direction to stop window operation.

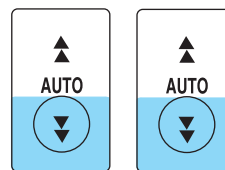

## Driver Controls

### Express Up (One Touch Up)

To make the front driver or passenger windows close fully without holding the window control, press the top portion of the driver window control completely down to the second detent or “Express Up” position. Press the control in either direction to stop window operation.

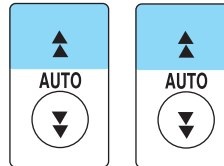

When closing the power windows, you should verify they are free of obstructions and ensure that children and/or pets are not in the proximity of the window openings.

### *Restoring the Express up functionality*

Under low battery power conditions, Express Up only functionality may be lost. To reset this function after restoring full battery power, press the rocker switch to the Express Up position, hold the switch until the glass reaches the stall position and continue to hold for 2 seconds.

### Accessory delay

With accessory delay, the window switches may be used for up to ten minutes after the ignition switch is turned to the OFF position or until either front door is opened.

### Bounce Back (Front Windows Only)

When an obstacle has been detected in the window opening as the window is moving upward, the window will automatically move down and stop at a prescribed position.

### *Bounce Back Override (Front Windows Only)*

To override Bounce Back, within 2 seconds after reaching Bounce Back position, if the rocker switch is moved from the Neutral to the Express Up position **the window will travel up with no bounce back protection**. If the switch is released before the window reaches fully closed position, the window will stop. For example: Bounce Back Override can be used to overcome the resistance of ice on the window or seals.

## Driver Controls

### Window lock

The window lock feature allows only the driver to operate the rear power windows.

To lock out the rear window controls press the right side of the control. Press the left side to restore the window controls.

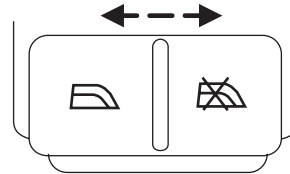

### MIRRORS

#### Automatic dimming inside rear view mirror (if equipped)

Your vehicle is equipped with an inside rear view mirror which has an auto-dimming function. The electronic day/night mirror will change from the clear state to the non-glare state when bright lights (glare) reach the mirror. When the mirror detects bright light from behind, it will automatically adjust (darken) to minimize glare at night only.

Press the AUTO control to turn the mirror on. Press the OFF control to turn the mirror off. Do not block the sensor on the front or back of the mirror since this may impair proper mirror performance. (Examples: no parking stickers or hanging tags.)

Ensure the mirror is pulled down low enough to prevent visibility interference with the overhead console. The mirror support arm has two pivot points which lets you adjust the mirror UP or DOWN and from SIDE to SIDE.

The mirror will automatically return to the clear state whenever the vehicle is placed in R (Reverse)(when the mirror is on).

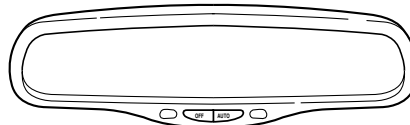

#### Electronic compass (if equipped)

The compass reading will remain accurate during most driving conditions. Unknown to the driver, the compass is continuously recalibrating due to magnetic fields and subtle, slow changes in vehicle magnetics which can occur over the life of the vehicle.

The compass reading will remain fixed when significant levels are experienced (such as steel bridges). The compass will return to normal operation upon leaving the magnetized area.

## Driver Controls

If highly magnetized items (such as magnetic mount antennas) are placed very near the compass the display will change to “C” for 15 seconds, then display all segments until the magnetized item is removed. If a “C” is displayed, refer to *Compass calibration adjustment*.

Most geographic areas (zones) have a magnetic north compass point that varies slightly from the northerly direction on maps. This variation is four degrees between adjacent zones and will become noticeable as the vehicle crosses multiple zones. A correct zone setting will eliminate this error. Refer to *Compass zone adjustment*.

### Compass zone adjustment

1. Determine which compass zone you are in by referring to the zone map.
2. Turn the ignition to the ON/RUN position.

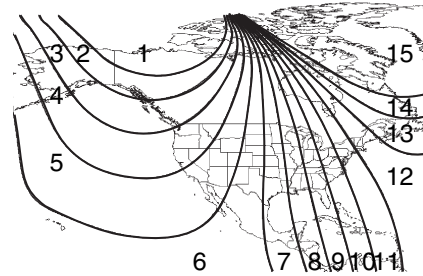

3. With the compass display turned on, press and hold the COMP side of the control for no more than six seconds until the zone selection number appears in the mirror display window. If a “C” appears repeat this step.

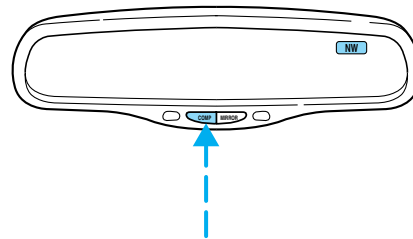

4. Release the COMP side of the control, then press it down again.
5. Repeatedly press until your zone number is shown in the mirror display, then release.
6. The display will show all segments, then return to normal compass mode within ten seconds.

### Compass calibration adjustment

Perform this adjustment in an open area free from steel structures and high voltage lines.



1. Start the vehicle.

## Driver Controls

2. Press and hold the COMP side of the control until “C” appears in the mirror display.
3. Drive the vehicle slowly (less than 5 km/h [3 mph]) in circles until the display reads a direction.
4. The compass is now calibrated.

### Power side view mirrors

To adjust your mirrors

1. Select  to adjust the left mirror or  to adjust the right mirror.
2. Move the disk control in the direction you wish to tilt the mirror.
3. Return to the center position to disable the adjust function.

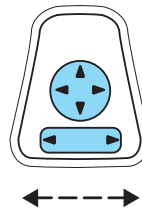

### Memory feature

The power side view mirror positions are saved when doing a memory set function and can be recalled along with the vehicle personality features when a memory position is selected through the remote entry transmitter, keyless entry keypad or memory switch on the driver's door (if equipped with memory feature). Refer to *Memory seats/steering column/mirrors/adjustable pedals* in the *Seating and Safety Restraints* chapter.

### Heated outside mirrors (if equipped)

Both mirrors are heated automatically to remove ice, mist and fog when the rear window defrost is activated.

**Do not remove ice from the mirrors with a scraper or attempt to readjust the mirror glass if it is frozen in place.**

**These actions could cause damage to the glass and mirrors.**

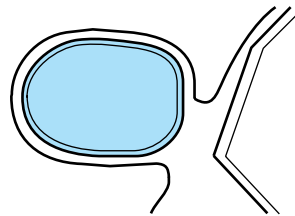

## Driver Controls

### Fold-away mirrors (if equipped)

Pull the side mirrors in carefully when driving through a narrow space, like an automatic car wash.

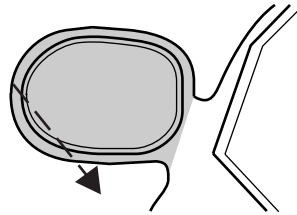

### POWER ADJUSTABLE FOOT PEDALS

The accelerator and brake pedal should only be adjusted when the vehicle is stopped and the gearshift lever is in the P (Park) position.

Press and hold the rocker control (located on the instrument panel) to adjust accelerator and brake pedal.

- Press the top of the control to adjust the pedals away from you.
- Press the bottom of the control to adjust the pedals towards you.

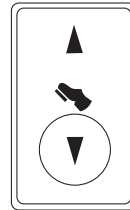

### Memory feature

The accelerator and brake pedal positions are saved when doing a memory set function and can be recalled along with the vehicle personality features when a memory position is selected through the remote entry transmitter, keyless entry keypad or memory switch on the driver's door (if equipped with memory feature). Refer to *Memory seats/steering column/mirrors/adjustable pedals* in the *Seating and Safety Restraints* chapter.



Never adjust the accelerator and brake pedal with feet on the pedals while the vehicle is moving.

### SPEED CONTROL

With speed control set, you can maintain a speed of 48 km/h (30 mph) or more without keeping your foot on the accelerator pedal. Speed control does not work at speeds below 48 km/h (30 mph).

## Driver Controls





Do not use the speed control in heavy traffic or on roads that are winding, slippery or unpaved.

### Setting speed control

The controls for using your speed control are located on the steering wheel for your convenience.

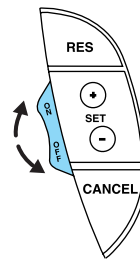
1. Press the ON control and release it.
2. Accelerate to the desired speed.



3. Press the SET + control and release it.
4. Take your foot off the accelerator pedal.
5. The indicator  light on the instrument cluster will turn on.

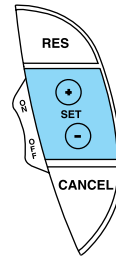

### Note:

- Vehicle speed may vary momentarily when driving up and down a steep hill.
- If the vehicle speed increases above the set speed on a downhill, you may want to apply the brakes to reduce the speed.
- If the vehicle speed decreases more than 16 km/h (10 mph) below your set speed on an uphill, your speed control will disengage.

## Driver Controls

### **Resuming a set speed**

Press the RES control and release it. This will automatically return the vehicle to the previously set speed. The RES control will not work if the vehicle speed is not faster than 48 km/h (30 mph).

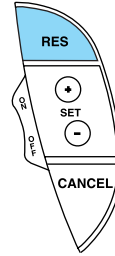

### **Increasing speed while using speed control**

There are two ways to set a higher speed:

- Press and hold the SET + control until you get to the desired speed, then release the control. You can also use the SET + control to operate the Tap-Up function. Press and release this control to increase the vehicle set speed in small amounts by 1.6 km/h (1 mph).
- Use the accelerator pedal to get to the desired speed. When the vehicle reaches that speed press and release the SET + control.

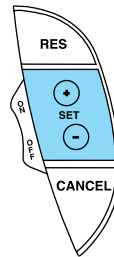

### **Reducing speed while using speed control**

There are two ways to reduce a set speed:

- Press and hold the CANCEL or SET - control until you get to the desired speed, then release the control. You can also use the CANCEL or SET - control to operate the Tap-Down function. Press and release this control to decrease the vehicle set speed in small amounts by 1.6 km/h (1 mph).

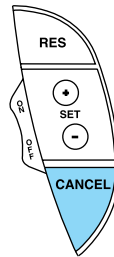

## Driver Controls

- Depress the brake pedal until the desired vehicle speed is reached, press the SET + control.

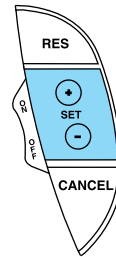

### **Turning off speed control**

There are two ways to turn off the speed control:

- Depress the brake pedal or the clutch pedal (if equipped). This will not erase your vehicle's previously set speed.
- Press the speed control OFF control.

**Note:** When you turn off the speed control or the ignition, your speed control set speed memory is erased.

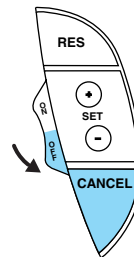

## STEERING WHEEL CONTROLS

These controls allow you to operate some audio control features.

### **Audio control features**

Press MEDIA to select AM, FM1, FM2, TAPE, or CD (if equipped).



## Driver Controls

### In AM, FM1, or FM2 mode:

- Press  $\Delta$  or  $\nabla$  to select preset stations within the selected radio band.

### In Tape mode:

- Press  $\Delta$  or  $\nabla$  to select the next selection on the tape.

### In CD mode:

- Press  $\Delta$  or  $\nabla$  to select the next selection on the CD.

### In any mode:

- Press VOL + or - to adjust volume.

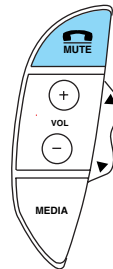
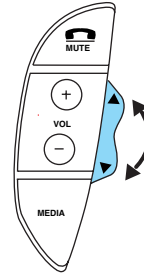

Press the PHONE/MUTE control to mute the playing media. Press again to return to the playing media.

If your vehicle is equipped with a factory installed cellular phone, refer to the *Phone/Mute Mode* section of the *Entertainment systems* chapter.

## Driver Controls

### **Navigation steering wheel controls (if equipped)**

These controls allow you to operate some audio and navigation control features when the vehicle is equipped with the navigation feature.

#### **Audio control features**

Press MEDIA to select:

- AM, FM1, FM2, or
- CD (if equipped).

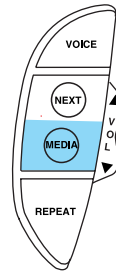

#### **In AM, FM1, or FM2 mode:**

- Press NEXT to select preset stations within the selected radio band.

#### **In CD mode:**

- Press NEXT to select the next selection on the CD.

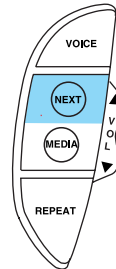

#### **In any mode:**

- Press VOL  $\Delta$  or  $\nabla$  to adjust volume.

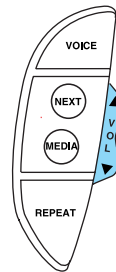

## Driver Controls

### Navigation control features

Press and hold VOICE until the voice icon appears to use the navigation voice guidance.

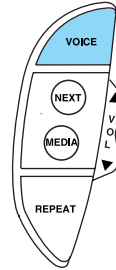

Press REPEAT control to hear previous command repeated from the navigation system.

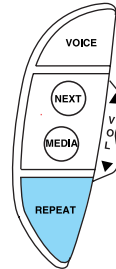

### MOON ROOF (IF EQUIPPED)

To open the moon roof:

- Push up on the control to raise the moon roof to the vent position.
- Push up on the control, while the moon roof is in the slide range, to activate the Auto-Tilt feature.
- Push the front portion of the control rearward to open the moon roof.
- Press the front portion of the control past the first detent to activate the **Auto Open** feature.

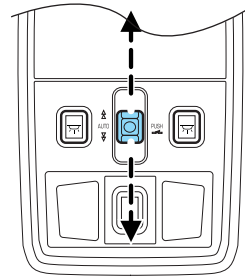

To close the moon roof:

- Press the rear portion of the control forward to close the moon roof.
- Press the rear portion of the control past the first detent to activate the **Auto close** feature.

## Driver Controls

- To close from the vent, intermediate and full open positions, push the rear portion of the control forward.



Do not let children play with the moon roof. They may seriously hurt themselves.



When closing the moon roof, you should verify they are free of obstructions and ensure that children and/or pets are not in the proximity of the window openings.

### **Bounce Back**

When an obstacle has been detected in the moon roof opening as the moon roof is closing, the moon roof will automatically open and stop at a prescribed position.

### **Bounce Back Override**

To override Bounce Back, within 2 seconds after reaching Bounce Back position, if the switch is moved from the Neutral to the auto close position **the moon roof will close with no bounce back protection.** If the switch is released before the moon roof reaches fully closed position, the moon roof will stop. For example: Bounce Back Override can be used to overcome the resistance of ice on the moon roof or seals.

### **HOMELINK® WIRELESS CONTROL SYSTEM (IF EQUIPPED)**

The HomeLink® Wireless Control System, located on the driver's visor, provides a convenient way to replace up to three hand-held transmitters with a single built-in device. This feature will learn the radio frequency codes of most current transmitters to operate garage doors, entry gate operators, security systems, entry door locks, and home or office lighting.



When programming your HomeLink® Wireless Control System to a garage door or gate, be sure that people and objects are out of the way to prevent potential harm or damage.

Do not use the HomeLink® Wireless Control System with any garage door opener that lacks safety stop and reverse features as required by U.S. federal safety standards (this includes any garage door opener model manufactured before April 1, 1982). A garage door which cannot detect an object, signaling the door to stop and reverse, does not meet current U.S. federal safety standards. For more information, contact HomeLink® at: **www.homelink.com** or **1-800-355-3515**.

## Driver Controls

Retain the original transmitter for use in other vehicles as well as for future programming procedures (i.e. new HomeLink® equipped vehicle purchase). It is also suggested that upon the sale of the vehicle, the programmed Homelink® buttons be erased for security purposes, refer to *Programming* in this section.

### Programming

**Do not program HomeLink® with the vehicle parked in the garage.**

**Note:** Your vehicle may require the ignition switch to be turned to the ACC position for programming and/or operation of the HomeLink®. It is also recommended that a new battery be placed in the hand-held transmitter of the device being programmed to HomeLink® for quicker training and accurate transmission of the radio-frequency signal.

1. Press and hold the two outside buttons releasing only when the red light begins to flash after 20 seconds. **Do not** repeat step one to program additional hand-held transmitters to the remaining two HomeLink® buttons. This will erase previously programmed hand-held transmitter signals into HomeLink®.

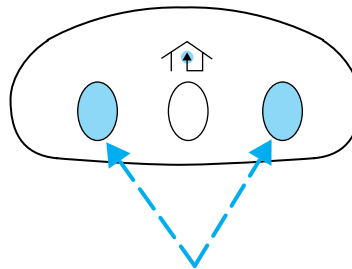

2. Position the end of your hand-held transmitter 2–8 cm (1–3 inches) away from the HomeLink® button you wish to program (located on your visor) while keeping the red light in view.

3. Simultaneously press and hold both the HomeLink® and hand-held transmitter button. **Do not release the buttons until step 4 has been completed.**

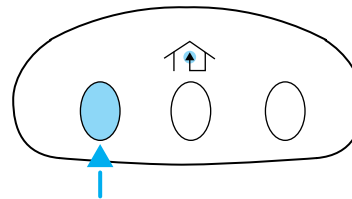

Some entry gates and garage door openers may require you to replace step 3 with procedures noted in the “Gate Operator and Canadian Programming” section for Canadian residents.

4. The red light will flash slowly and then rapidly. Release both buttons when the red light flashes rapidly. (The rapid flashing light indicates acceptance of the hand-held transmitters’ radio frequency signals.)

## Driver Controls

5. Press and hold the just-trained HomeLink® button and observe the red light. If the light is a constant red, programming is complete and your device should activate when the HomeLink® button is pressed and released. **Note:** To program the remaining two HomeLink® buttons, begin with step 2 in the “Programming” section — **do not** repeat step 1.

**Note:** If the red light blinks rapidly for two seconds and then turns to a continuous red, proceed with steps 6 through 8 to complete programming of a rolling code equipped device.

6. At the garage door opener receiver (motor-head unit) in the garage, locate the “learn” or “smart” button (usually near where the hanging antenna wire is attached to the unit).

7. Press and release the “learn” or “smart” button. (The name and color of the button may vary by manufacturer.)

**Note:** There are 30 seconds in which to initiate step eight.

8. Return to the vehicle and firmly press, hold for two seconds and release the HomeLink® button. Repeat the press/hold/release sequence again, and, depending on the brand of the garage door opener (or other rolling code equipped device), repeat this sequence a third time to complete the programming.

HomeLink® should now activate your rolling code equipped device. To program additional HomeLink® buttons begin with step 2 in the “Programming” section. For questions or comments, please contact HomeLink at [www.homelink.com](http://www.homelink.com) or 1-800-355-3515.

### Gate Operator & Canadian Programming

During programming, your hand-held transmitter may automatically stop transmitting — not allowing enough time for HomeLink® to accept the signal from the hand-held transmitter.

After completing steps 1 and 2 outlined in the “Programming” section, replace step 3 with the following:

**Note:** If programming a garage door opener or gate operator, it is advised to unplug the device during the “cycling” process to prevent overheating.

- Continue to press and hold the HomeLink® button (note step 3 in the “Programming” section) while you press and release — **every two seconds**

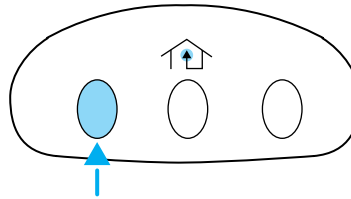

## Driver Controls

(“cycle”) your hand-held transmitter until the frequency signal has been accepted by the HomeLink®. The red indicator light will flash slowly and then rapidly after HomeLink® accepts the radio frequency signal.

- Proceed with step 4 in the “Programming” section.

### Operating the HomeLink® Wireless Control System

To operate, simply press and release the appropriate HomeLink® button. Activation will now occur for the trained product (garage door, gate operator, security system, entry door lock, or home or office lighting etc.). For convenience, the hand-held transmitter of the device may also be used at any time. In the event that there are still programming difficulties, contact HomeLink® at [www.homelink.com](http://www.homelink.com) or **1-800-355-3515**.

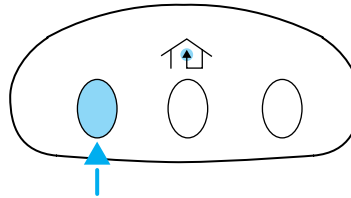

### Erasing HomeLink® buttons

To erase the three programmed buttons (individual buttons cannot be erased):

- Press and hold the two outer HomeLink® buttons until the red indicator light begins to flash-after 20 seconds. Release both buttons. Do not hold for longer than 30 seconds.

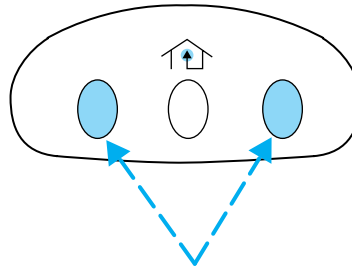

HomeLink® is now in the train (or learning) mode and can be programmed at any time beginning with step 2 in the “Programming” section.

### Reprogramming a single HomeLink® button

To program a device to HomeLink® using a HomeLink® button previously trained, follow these steps:

1. Press and hold the desired HomeLink® button. **Do NOT** release the button.
2. The red indicator light will begin to flash after 20 seconds. Without releasing the HomeLink® button, follow step 2 in the “Programming” section.

For questions or comments, contact HomeLink® at [www.homelink.com](http://www.homelink.com) or **1-800-355-3515**.

## Driver Controls

### CELL PHONE USE

The use of Mobile Communications Equipment has become increasingly important in the conduct of business and personal affairs. However, drivers must not compromise their own or others' safety when using such equipment. Mobile Communications can enhance personal safety and security when appropriately used, particularly in emergency situations. Safety must be paramount when using mobile communications equipment to avoid negating these benefits.

Mobile Communication Equipment includes, but is not limited to cellular phones, pagers, portable email devices, in vehicle communications systems, telematics devices and portable two-way radios.



A driver's first responsibility is the safe operation of the vehicle. The most important thing you can do to prevent a crash is to avoid distractions and pay attention to the road. Wait until it is safe to operate Mobile Communications Equipment.

### MESSAGE CENTER (IF EQUIPPED)

With the ignition in the RUN position, the message center, located on your instrument cluster, displays important vehicle information by monitoring vehicle systems. When you change displays, a brief indicator chime will sound. The system will also notify you of potential vehicle problems with a system warnings display followed by a long indicator chime.

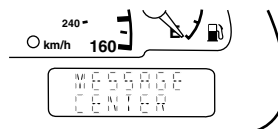

### Operator selectable features

These features are controlled by the message center controls located above the radio.

#### **FUEL**

Press this control for the following displays:

- Distance to Empty
- Average Fuel Economy
- Display On/Off



## Driver Controls

### **RESET**

Press this control to select and reset functions shown in the FUEL, SETUP and STATUS controls.

### **SETUP**

Press this control for the following displays:

- Language
- Units (English/Metric)
- Autolocks
- Easy Entry/Exit (if equipped)
- Lock Chirp (if equipped)

### **STATUS**

Selecting this function from the STATUS control causes the message center to cycle through each of the systems being monitored. For each of the monitored systems, the message center will indicate either an OK message or a warning message for four seconds.

The sequence of the status check report is as follows:

- oil life in XX%
- AC (cabin) filter XX%
- charging system
- engine temperature
- brake fluid level
- washer fluid level
- doors closed (driver and passenger side, front and rear). This message can only be reset by closing the door(s). If the RESET control is pressed, PLEASE CLOSE DOOR will be displayed.
- trunk status
- exterior lamps (front and rear turn, brake, tail and side repeater lamp (if equipped) status)
- Traction Control<sup>™</sup> or AdvanceTrac<sup>™</sup> (if equipped)

## Driver Controls

### Message center functions

#### ***Dist To Empty (DTE)***

Selecting this function from the FUEL control this function estimates approximately how far you can drive with the fuel remaining in your tank under normal driving



XXXX KM  
TO EMPTY

conditions. Remember to turn the ignition OFF when refueling to allow this feature to correctly detect the added fuel.

The DTE function will display LOW FUEL LEVEL and sound a tone for one second when you have approximately 80 km (50 miles) to empty. If you RESET this warning message, this display and tone will return within 10 minutes.

DTE is calculated using a running average fuel economy, which is based on your recent driving history of 800 km (500miles). This value is not the same as the average fuel economy display. The running average fuel economy is reinitialized to a factory default value if the battery is disconnected.

#### ***Fuel Econ Avg***

Select this function from the FUEL control to display your average fuel economy in liters/100 km or miles/gallon.



XXX AVERAGE  
L / 100 KM

If you calculate your average fuel economy by dividing liters of fuel used by 100 kilometers traveled (miles traveled by gallons used), your figure may be different than displayed for the following reasons:

- your vehicle was not perfectly level during fill-up
- differences in the automatic shut-off points on the fuel pumps at service stations
- variations in top-off procedure from one fill-up to another
- rounding of the displayed values to the nearest 0.1 liter (gallon)

#### ***Checking your highway fuel economy using the electronic message center display***

The following procedure will allow you to accurately monitor your actual highway fuel economy. Since this procedure requires the vehicle speed control system to be set to highway speeds, it must be run only on suitable roadways where long distance speed control can be safely maintained.

## Driver Controls

You may notice gradual improvement in fuel economy over the course of your vehicle's break-in period (approximately 1,600 kilometers [1,000 miles]).

1. Press the FUEL control to display miles to empty. Press again to display average fuel economy.



AVERAGE FUEL  
ECONOMY

2. Set the speed control. Refer to *Speed control* in this chapter.

3. Press the RESET control to clear the system memory.

- *Actual highway fuel economy is now displayed.* This current average measure will change as the speed control system changes the engine speed to maintain a constant vehicle speed. This is most noticeable in hilly environments.

4. Drive the vehicle at least 8 km (5 miles) with the speed control system engaged to display a stabilized average.

5. Record the highway fuel economy for future reference.

It is important to press the RESET control after setting the speed control to get accurate highway fuel economy readings.

### **Display On/Off**

Select this function from the FUEL control to turn your message center display OFF or ON.

### **Units (English/Metric)**

1. Select this function from the SETUP control for the current units to be displayed.

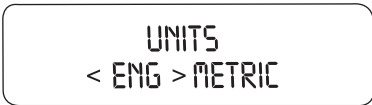

UNITS  
< ENG > METRIC

2. Press the RESET control to change from English to Metric.

### **Autolocks**

1. Select this function from the SETUP control for the current display mode.



AUTO LOCKS  
< ON > OFF

2. Press the RESET control to turn the autolocks ON or OFF.

## Driver Controls

### **Easy exit seat (if equipped)**

1. Select this function from the SETUP control for the current display mode.
2. Press the RESET control to turn the easy entry/exit ON or OFF.

EASY EXIT SEAT  
< ON >OFF

### **Lock chirp (if equipped)**

1. Select this function from the SETUP control for the current display mode.
2. Press the RESET control to turn the lock chirp ON or OFF.

LOCK CHIRP  
ON >OFF

### **Language**

1. Select this function from the SETUP control for the current language to be displayed.
2. Pressing the RESET control cycles the message center through each of the language choices.
3. Press and hold the RESET control to set the language choice.

ENGLISH  
RESET FOR NEW

FOR ENGLISH  
HOLD RESET

SET TO  
ENGLISH

### **System warnings**

System warnings alert you to possible problems or malfunctions in your vehicle's operating systems.

In the event of a multiple warning situation, the message center will cycle the display to show all warnings by displaying each one for 4 seconds.

The message center will display the last selected feature if there are no more warning messages. This allows you to use the full functionality of the message center after you acknowledge the warning by pressing the RESET control and clearing the warning message.

## Driver Controls

Warning messages that have been reset are divided into two categories:

- They will reappear on the display ten minutes from the reset.
- They will not reappear until an ignition OFF-RUN cycle has been completed.

This acts as a reminder that these warning conditions still exist within the vehicle.

Warnings	Status
Engine power reduced	Warning cannot be reset
Pull off road safely	
Turn off ignition	
Driver's door ajar	
Passenger door ajar	
Driver rear door ajar	
Passenger rear door ajar	
Park brake on & need service	
Park brake on	
Check engine temp	Warning returns after 10 minutes
Check charging system	
Transmission overheated	
Check transmission	
Low fuel level	
Check fuel cap	
ETC-engine failsafe mode	

## Driver Controls

Warnings	Status
Low brake fluid level	Warning returns after the ignition key is turned from OFF to RUN
Check tail lamps	
Check brake lamps	
Check front turn lamps	
Check side repeater lamps (if equipped)	
Check rear turn lamps	
Check Traction Control	
Check AdvanceTrac (if equipped)	
Trunk ajar	
Low washer fluid	
Check AC (cabin) filter	
Change oil soon	
Oil change required	
Service park brake	
Apply park brake	
Data error	

**ENGINE POWER REDUCED.** Displayed when the engine is overheating. Stop the vehicle as soon as safely possible and turn off the engine. If this warning stays on, contact your dealer as soon as possible.

**PULL OFF ROAD SAFELY.** Displayed when the engine is overheating. Stop the vehicle as soon as safely possible and turn off the engine. If this warning stays on, contact your dealer as soon as possible.

**TURN OFF IGNITION.** Displayed when the engine is overheating. Turn off the engine. If this warning stays on, contact your dealer as soon as possible.

**DRIVER'S DOOR AJAR.** Displayed when the driver's door is not completely closed.

**PASSENGER DOOR AJAR.** Displayed when the passenger side door is not completely closed.

**DRIVER'S REAR DOOR AJAR.** Displayed when the driver's rear door is not completely closed.

**PASSENGER REAR DOOR AJAR.** Displayed when the passenger side rear door is not completely closed.

## Driver Controls

**PARK BRAKE ON & NEED SERVICE.** Displayed when the park brake is ON and malfunctioning. If the warning stays on or continues to come on, contact your dealer as soon as possible.

**PARK BRAKE ON.** Displayed when the park brake is ON. If the warning stays on after the park brake is off, contact your dealer as soon as possible.

**CHECK ENGINE TEMP.** Displayed when the engine coolant is overheating. Stop the vehicle as soon as safely possible, turn off the engine and let it cool. Check the coolant and coolant level. Refer to *Engine coolant* in the *Maintenance and specifications* chapter. If the warning stays on or continues to come on, contact your dealer as soon as possible.

**CHECK CHARGING SYSTEM.** Displayed when the electrical system is not maintaining proper voltage. If you are operating electrical accessories when the engine is idling at a low speed, turn off as many of the electrical loads as soon as possible. If the warning stays on or comes on when the engine is operating at normal speeds, have the electrical system checked as soon as possible.

**TRANSMISSION OVERHEATED.** Indicates the transmission is overheating. This warning may appear when towing heavy loads or when driving in a low gear at a high speed for an extended period of time. Stop the vehicle as soon as safely possible, turn off the engine and let it cool. Check the transmission fluid and level. Refer to *Transmission fluid* in the *Maintenance and specifications* chapter. If the warning stays on or continues to come on, contact your dealer for transmission service as soon as possible.

**CHECK TRANSMISSION.** Indicates the transmission is not operating properly. If this warning stays on, contact your dealer as soon as possible.

**LOW FUEL LEVEL.** Displayed when you have approximately 80 km (50 miles) to empty.

**CHECK FUEL CAP.** Displayed when the fuel filler cap is not properly installed. Check the fuel filler cap for proper installation. Refer to *Fuel filler cap* in the *Maintenance and specifications* chapter.

**ETC-ENGINE FAILSAFE MODE.** Displayed when the engine has defaulted to a 'limp-home' operation. If the warning stays on or continues to come on, contact your dealer as soon as possible.

**LOW BRAKE FLUID.** Indicates the brake fluid level is low and the brake system should be inspected immediately. Refer to *Checking and adding brake fluid* in the *Maintenance and specifications* chapter.

## Driver Controls

**CHECK TAIL LAMPS.** Displayed when the tail lamps are activated and at least one is burned out. Check the lamps as soon as safely possible and have the burned out lamp replaced.

**CHECK BRAKE LAMPS.** Displayed when the brake lamps are activated and at least one is burned out. Check the lamps as soon as safely possible and have the burned out lamp replaced. The center high-mount brakelamp is not monitored.

**CHECK FRT TURN LAMPS.** Displayed when the turn signals are activated and at least one is burned out. Check the lamps as soon as safely possible and have the burned out lamp replaced.

**CHECK SIDE REPEATER LAMPS (if equipped).** Displayed when the turn signals are activated and at least one is burned out. Check the lamps as soon as possible and have the burned out lamp replaced.

**CHECK REAR TURN LAMPS.** Displayed when the turn signals are activated and at least one is burned out. Check the lamps as soon as possible and have the burned out lamp replaced.

**CHECK TRACTION CONTROL.** Displayed when the Traction Control™ system is not operating properly. If this message is displayed on the message center **and** the amber T/C OFF light in the Traction Control™ on/off switch is **not** illuminated, the Traction Control™ system will be partially operable. If this warning stays on, contact your dealer for service as soon as possible. For further information, refer to *Traction control™* in the *Driving* chapter.

**CHECK ADVANCETRAC (if equipped).** Displayed when the AdvanceTrac™ system is not operating properly. If this message is displayed on the message center the AdvanceTrac™ system will be partially operable. If this warning stays on while the engine is running, contact your dealer for service as soon as possible. For further information, refer to *AdvanceTrac™ stability enhancement system* in the *Driving* chapter.

**TRUNK AJAR.** Displayed when the trunk is not completely closed.

**LOW WASHER FLUID.** Indicates the washer fluid reservoir is less than one quarter full. Check the washer fluid level. Refer to *Checking and adding washer fluid* in the *Maintenance and specifications* chapter.

**CHECK A/C (cabin) FILTER.** Displayed when the A/C cabin filter life remaining is 5 percent or less. When A/C filter life left is between 5% and 0%, the CHANGE A/C FILTER SOON message will be displayed. When A/C filter life left reaches 0%, the A/C FILTER CHANGE REQUIRED message will be displayed.

## Driver Controls

To reset the A/C filter monitoring system to 100% after each A/C Filter change:

1. Press the STATUS control to access the System Check function, the message center will display A/C FILTER XXX% RESET FOR NEW.

A/C FILTER XX %  
RESET FOR NEW

2. Press and hold the RESET control to set to 100%, the message center will display IF NEW FILTER HOLD RESET.

IF NEW FILTER  
HOLD RESET

3. After a successful reset, the message center will display A/C FILTER LIFE SET TO 100%.

A/C FILTER LIFE  
SET TO XX %

**CHANGE OIL SOON/OIL CHANGE REQUIRED.** Displayed when the engine oil life remaining is 5 percent or less. When oil life left is between 5% and 0%, the CHANGE OIL SOON message will be displayed. When oil life left reaches 0%, the OIL CHANGE REQUIRED message will be displayed.

An oil change is required whenever indicated by the message center. USE ONLY RECOMMENDED ENGINE OILS.

To reset the oil monitoring system to 100% after each oil change [approximately 8,000 km (5,000 miles) or 180 days] perform the following:

1. Press the STATUS control to access the System Check function. Press RESET to reset oil %.

OIL LIFE XX %  
RESET FOR NEW

2. Press and hold the RESET control to set to 100%.

IF NEW OIL  
HOLD RESET

## Driver Controls

3. After a successful reset, the message center will display OIL LIFE SET TO 100%.

A rectangular message center display with rounded corners. The text inside reads "OIL LIFE SET" on the top line and "TO XX%" on the bottom line, where "XX" represents a two-digit number.

To reset the oil monitoring system to your personalized oil life %:

1. Press the STATUS control to access the System Check function. Press RESET to reset oil %.

A rectangular message center display with rounded corners. The text inside reads "OIL LIFE XX%" on the top line and "RESET FOR NEW" on the bottom line, where "XX" represents a two-digit number.

2. Press RESET and SETUP controls at the same time to activate a service mode which will display OIL LIFE XX% RESET TO ALTER.

A rectangular message center display with rounded corners. The text inside reads "OIL LIFE XX%" on the top line and "RESET TO ALTER" on the bottom line, where "XX" represents a two-digit number.

3. Press RESET until you find your personalized OIL LIFE XX%.

A rectangular message center display with rounded corners. The text inside reads "OIL LIFE SET" on the top line and "TO XX%" on the bottom line, where "XX" represents a two-digit number.

**SERVICE PARK BRAKE.** Displayed when the park brake needs servicing. If the warning stays on or continues to come on, contact your dealer as soon as possible.

**APPLY PARK BRAKE.** Displayed when the park brake needs to be applied. If the warning stays on or continues to come on, contact your dealer as soon as possible.

**DATA ERROR.** These messages indicate improper operation of the vehicle network communication between electronic modules.

- Fuel computer
- Engine sensor
- Gear selection
- Door sensor
- Trunk sensor
- Exterior lamps
- Traction Control<sup>™</sup> and AdvanceTrac<sup>™</sup> (if equipped)
- Memory feature

Contact your dealer as soon as possible if these messages occur on a regular basis.

## Driver Controls

### INTERIOR TRUNK CONTROL

Press the remote trunk release control on the instrument panel to open the trunk.

You can render the switch inoperable by locking the button with your master key. Do this and also lock your glove box before you give your vehicle to the valet personnel (**do not give them the master key or remote entry keyfob, only the gray valet key**).

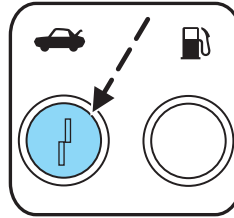

The remote trunk release control and power door locks will be disabled when the vehicle perimeter alarm system is armed. This control will not work until the vehicle perimeter alarm system is disarmed. Refer to *Perimeter Alarm System* in the *Locks and Security* chapter.

### FUEL DOOR RELEASE

Press the remote fuel door release control on the instrument panel to open the fuel door.

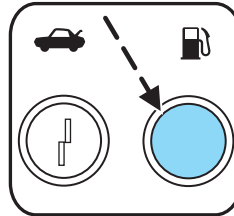

The fuel door has a manual override release located in the trunk. Pull the tab to open the fuel door.

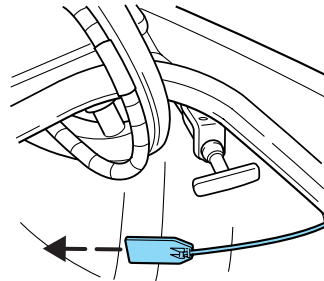

## Driver Controls

### REMOVAL/INSTALLATION OF ASHTRAY

In order to prevent damage, follow these instructions when removing/installing the ashtray.

Removal:

1. Push the ashtray face to slide open.

**Note:** Do not remove the ashtray drawer.

2. Pull the ashtray insert upward from the ashtray drawer and remove.

Installation:

1. Place the ashtray insert into the ashtray drawer.
2. Push the ashtray drawer in to close.

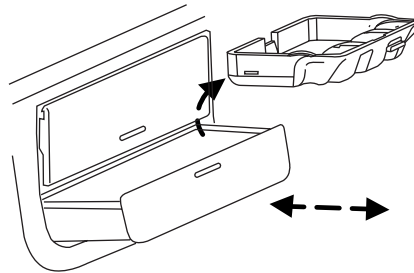

### CENTER CONSOLE

Your vehicle may be equipped with a variety of console features. These include:

1. Cupholders
2. Sliding arm rest (lift latch to slide forward or rearward)

**Note:** Slide the arm rest to the rearward position to open the utility compartment

3. Utility compartment, inside has power point (front drivers side), coin holders (front passenger side), and Cellular phone (if equipped)
4. Air vents to the rear seating positions
5. Traction control<sup>TM</sup>/AdvanceTrac<sup>TM</sup> (if equipped)
6. Electronic park brake

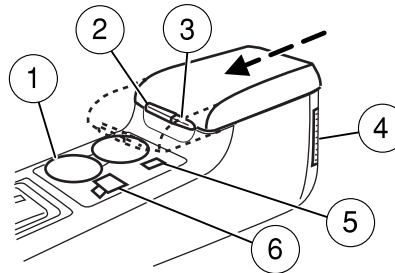

## Driver Controls

### POSITIVE RETENTION FLOOR MAT

Position the driver floor mat so that the eyelet is over the pointed end of the retention post and rotate forward to lock in. Make sure that the mat does not interfere with the operation of the accelerator or the brake pedal. To remove the floor mat, reverse the installation procedure.

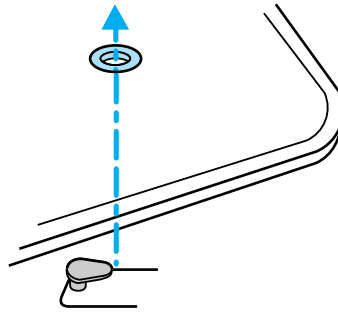

### CARGO NET (IF EQUIPPED)

The cargo net secures lightweight objects in the cargo area.



This net is not designed to restrain objects during a collision.

There are four straps on the net and six anchors in the trunk that can be used for securing different sized objects.

To attach the cargo net to the anchors:

- Take the bottom strap of one side of the net and push the anchor through the strap loop.
- Take the top strap of same side of the net and push the anchor through the strap loop.
- Repeat steps 1 and 2 for the other side.

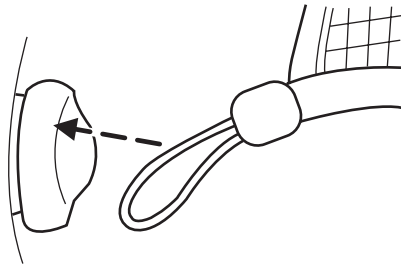

### LUGGAGE RACK (IF EQUIPPED)

The luggage rack is dealer installed only. See your local Lincoln Mercury dealership.

The maximum load is 75 kg (165 lb) on the luggage rack structure. The vehicle's roof panel is not designed to carry a load.

When loading the luggage rack, it is recommended to evenly distribute the load, as well as maintain a low center of gravity. Ensure that the load is securely fastened.

## Locks and Security

### KEYS

Your vehicle is equipped with two master keys and a valet key lock system. The master key will access the driver's door, trunk, glove box, remote trunk release control and ignition. The valet key will access door and ignition only.

Refer to the *Securilock Passive Anti-Theft System* section for information on Securilock keys.

### POWER DOOR LOCKS

Press the top of the control to unlock all doors and the bottom to lock all doors.

When the vehicle's security system is armed, the power door locks and remote trunk release control are disabled; these features will not work until the security system is disarmed.

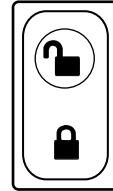

### Smart locks

With the key in any ignition position:

- The driver's door will automatically unlock if it is locked by the driver's power lock control while the driver's door is open.
- All doors will automatically unlock if the passenger's door is locked by the passenger's power lock control while the passenger's door is open.

The vehicle may still be locked with the key in the ignition, and performing one of the following actions:

- Pressing the manual lock button on the door.
- Operating the remote entry transmitter.
- Operating the keyless entry keypad.
- Operating the driver's door with a key.

### Opening all windows and moonroof (if equipped)

You can open the vehicle's windows and moonroof (if equipped) by using the door key or the  control on the remote entry transmitter.

Turn the key toward the front of the vehicle and hold it for more than two seconds to begin to open all the windows and moonroof. Releasing the key to the center position will stop all motion.

## Locks and Security

**Note:** The ignition must be in the OFF position and the accessory delay feature must not be activated in order for this feature to operate.

### ***Closing all windows and moonroof (if equipped)***

**Note:** This operation is only available using the door key.

You can close the vehicle's windows and moonroof (if equipped) by using the door key.

Turn the key toward the back of the vehicle and hold it for more than two seconds to begin to close all the windows and moonroof. Releasing the key to the center position will stop all motion.

**Note:** The ignition must be in the OFF position and the accessory delay feature must not be activated in order for this feature to operate.





The rear windows do not have bounce-back protection. If an obstruction occurs, turn the key toward the front of the vehicle and hold for more than two seconds in order to reopen all the windows and moonroof.



Before operating power windows and moonroofs, you should verify that they are free of obstructions and ensure that children and/or pets are not in the proximity of window openings.

### **Central locking/Two stage unlocking**

When unlocking the driver door with the key, turn it once toward the front of the vehicle to unlock that door only, if the two-stage unlocking is enabled. Turn the key a second time to unlock all doors. When locking, turn the key toward the back of the vehicle to lock all doors.

Two stage unlocking may be disabled (and the vehicle may be programmed for all vehicle doors to unlock by pressing the  control or by turning the key inside the driver's door key cylinder once toward the front of the vehicle) by simultaneously pressing the  and  controls on the remote entry transmitter for four seconds.

**Note:** The turn lamps will flash twice to confirm that a change to the feature has occurred.

## Locks and Security

### Childproof door locks

- When these locks are set, the rear doors cannot be opened from the inside.
- The rear doors can be opened from the outside when the doors are unlocked.

The childproof locks are located on the rear edge of each rear door and must be set separately for each door. **Note:** Setting the lock for one door will not automatically set the lock for both doors.

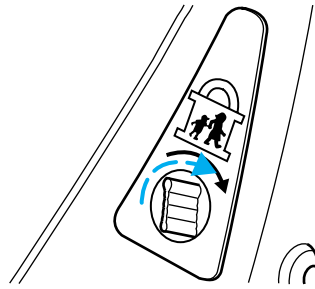

- Rotate the control in the direction of the arrow to engage the childproof lock.
- Rotate the control in the opposite direction to disengage the childproof lock.

### INTERIOR LUGGAGE COMPARTMENT RELEASE

Your vehicle is equipped with a mechanical interior luggage compartment release handle that provides a means of escape for children and adults in the event they become locked inside the luggage compartment.

Adults are advised to familiarize themselves with the operation and location of the release handle.

To open the luggage compartment door (lid) from within the luggage compartment, pull the illuminated “T” shaped handle and push up on the trunk lid. The handle is composed of a material that will glow for hours in darkness following brief exposure to ambient light.

The “T” shaped handle will be located either on the luggage compartment door (lid) or inside the luggage compartment near the tail lamps.

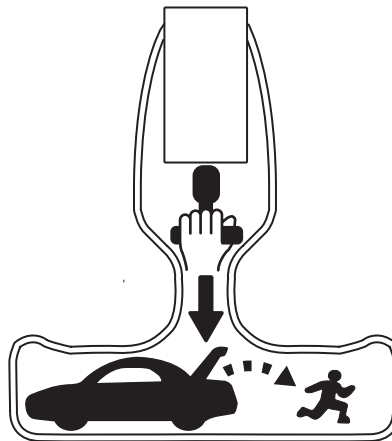

## Locks and Security

 Keep vehicle doors and luggage compartment locked and keep keys and remote transmitters out of a child's reach. Unsupervised children could lock themselves in the trunk and risk injury. Children should be taught not to play in vehicles.

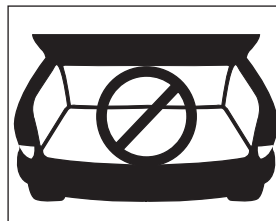

 On hot days, the temperature in the trunk or vehicle interior can rise very quickly. Exposure of people or animals to these high temperatures for even a short time can cause death or serious heat-related injuries, including brain damage. Small children are particularly at risk.

### REMOTE ENTRY SYSTEM

This device complies with part 15 of the FCC rules and with RS-210 of Industry Canada. Operation is subject to the following two conditions: (1) This device may not cause harmful interference, and (2) This device must accept any interference received, including interference that may cause undesired operation.

**Changes or modifications not expressly approved by the party responsible for compliance could void the user's authority to operate the equipment.**

The remote entry system allows you to perform the following tasks using the remote entry transmitter:

- unlock the vehicle doors.
- lock all the vehicle doors.
- open the trunk.
- activate the personal alarm.
- open all windows and moonroof (if equipped).
- arm and disarm the perimeter anti-theft system.
- operate the illuminated entry feature.



## Locks and Security

- operate the memory seat/mirror/steering column/adjustable pedals feature (if equipped).
- enable/disable the two-stage unlocking feature.

When the vehicle is armed, the interior power door lock controls and remote interior trunk release control are disabled. These features will not work until the vehicle is disarmed. Refer to *Central locking/Two-stage unlocking* information in this chapter.

If there is any potential remote keyless entry problem with your vehicle, ensure **ALL remote entry transmitters** are taken to the dealership to aid in troubleshooting.

### Unlocking the doors

1. Press  and release to:

- unlock the driver's door only, if the two-stage unlocking feature is enabled.
- unlock all doors, if the two-stage unlocking feature is disabled.
- deactivate the perimeter alarm (if activated). **Note:** The interior lamps will illuminate and the turn signal lamps will display two short flashes to indicate the deactivation of the perimeter alarm. Additionally, if the memory seat/mirror/steering column/adjustable pedals feature (if equipped) is activated, the corresponding seat/mirror/steering column/adjustable pedals positions will be recalled.

2. Press  and release again within five seconds to unlock all the doors.

The remote entry system comes with an illuminated entry feature. This feature turns on the puddle lamps and the interior lamps for 20 seconds or until the ignition is turned to the START position.

The inside lights will not turn off if:

- they have been turned on using the dimmer control or
- any door is open.

The battery saver feature will turn off the interior lamps 40 minutes after the ignition is turned to the OFF position.

### **Opening all windows and moonroof (if equipped)**

Press  and hold for more than two seconds in order to begin opening the windows and moonroof (if equipped).

- The  control can then be released and the windows and moonroof will complete the opening operation. **Note:** If the moonroof is in the vent range, the moonroof will move to full vent.

## Locks and Security

- If any other remote entry transmitter control is pressed during the opening operation, all window and moonroof movement will stop.

**Note:** The ignition must be in the OFF position and the accessory delay feature must be not activated in order for this feature to operate.

### Locking the doors

1. Press  and release to lock all the doors and arm the perimeter alarm system (also enables the ignition tamper security system).

- **Note:** With the first press of the  control, the turn signal lamps will flash once to confirm the doors, trunk and hood are closed. If any door, the trunk or the hood is open, the turn signal lamps will flash five times.

2. Press  and release again within three seconds to confirm that all the doors, trunk and hood are closed and locked.

- **Note:** With the second press of the  control (within 3 seconds of the first), the horn will chirp once to confirm the doors, trunk and hood are closed. The horn will chirp twice if any of the doors, the trunk or the hood are not properly closed (if enabled). The horn chirp feature may be enabled/disabled by an authorized dealer or by using the message center (if equipped). Refer to *Message center* in the *Driver controls* chapter for more information.

### Sounding a panic alarm

Press  on the remote transmitter to activate the alarm.

Press  a second time to deactivate the alarm. You may also deactivate the alarm in the following ways:

- Press  on the remote transmitter.
- Turn the ignition to the RUN position.
- Wait 30 seconds for the alarm to time-out.

### Opening the trunk

Press  once to open the trunk.

- Ensure that the trunk is closed and latched before driving your vehicle. Failure to properly latch the trunk may cause objects to fall out or block the driver's rear view.

## Locks and Security

### Replacing the battery

The remote entry transmitter uses one coin type three-volt lithium battery CR2032 or equivalent. The typical operating range for your remote entry transmitter is approximately 10 meters (33 feet). A decrease in the operating range could be caused by:

- weather conditions,
- nearby radio towers,
- structures around the vehicle and
- other vehicles parked next to the vehicle.

To replace the battery:

1. Twist a thin coin between the two halves of the remote entry transmitter near the key ring. **DO NOT TAKE THE FRONT PART OF THE REMOTE ENTRY TRANSMITTER APART.**
2. Remove the old battery.
3. Insert the new battery. Refer to the diagram inside the remote entry transmitter for the correct orientation of the battery.
4. Snap the two halves back together.

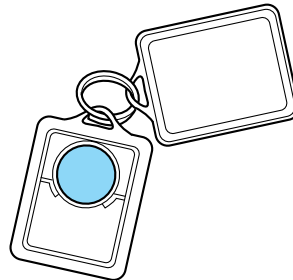

**Note:** Replacement of the battery will **not** cause the remote transmitter to become deprogrammed from your vehicle. The remote transmitter should operate normally after battery replacement.

### Replacing lost remote entry transmitters

If you would like to have your remote entry transmitter reprogrammed because you lost one, or would like to buy additional remote entry transmitters, you can either reprogram them yourself, or take **all remote entry transmitters** to your authorized dealer for reprogramming.

### *How to reprogram your remote entry transmitters*

You must have **all remote entry transmitters** (maximum of four) available before beginning this procedure.

## Locks and Security

To reprogram the remote entry transmitters:

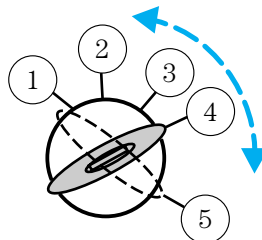

1. Ensure the vehicle is electronically unlocked.
2. Put the key in the ignition.
3. Turn the key from the 2 (OFF) position to 4 (RUN).
4. Cycle, eight times, rapidly (within 10 seconds) between the 2 (OFF) position and 4 (RUN). **Note:** The eighth turn must end in the 4 (RUN) position.
5. The doors will lock, then unlock, to confirm that the programming mode has been activated.
6. Within 20 seconds press any button on the remote entry transmitter. **Note:** If more than 20 seconds have passed you will need to start the procedure over again.
7. The doors will lock, then unlock, to confirm that this remote entry transmitter has been programmed.
8. Repeat Step 6 to program each additional remote entry transmitter.
9. Turn the ignition to the 2 (OFF) position after you have finished programming all of the remote entry transmitters.
10. The doors will lock, then unlock, to confirm that the programming mode has been exited.

### Illuminated entry

The remote entry system comes with an illuminated entry feature. This feature turns on the interior lamps for 20 seconds or until the ignition is turned to the START position.

The inside lights will not turn off if:

- they have been turned on using the dimmer control or
- any door is open.

The battery saver feature will turn off the interior lamps 40 minutes after the ignition is turned to the OFF position.

## Locks and Security

### **Autolock**

The autolock feature will lock the vehicle's doors when:

- all the doors are closed,
- the ignition is in the RUN position,
- you shift into forward or reverse, and
- the vehicle speed is greater than 5 km/h (3 mph).

### **Relock**

The autolock feature repeats when:

- either door is opened then closed while the ignition is in the RUN position, and
- you shift into forward or reverse, and
- the vehicle speed is greater than 5 km/h (3 mph).

### **Deactivating/activating autolock**

Your vehicle comes with the autolock feature activated; in order to deactivate the feature, take your vehicle to your authorized dealer, or use the message center (if equipped). Refer to *Message center* in the *Driver controls* chapter for more information.

### **Memory seat feature**

The remote entry system allows you to recall the memory seat/mirror/steering column/adjustable pedals feature.

Press  to automatically move the seat/mirror/steering column/adjustable pedals to the desired memory position. **Note:** The seat will not travel to its final position if the key is not in the ignition and the easy entry feature is enabled.

### **Activating the memory feature**

To activate this feature:

1. Position the seat, mirrors, steering column to and adjustable pedals the positions you desire.

## Locks and Security

2. Press the SET control on the driver's door panel.
3. Within 5 five seconds, press any control on the remote transmitter and then press the 1 or 2 control on the driver's door panel to associate with the Driver 1 or Driver 2 positions.
4. Repeat this procedure for another remote transmitter if desired.

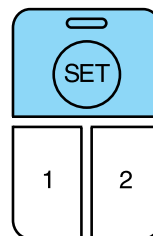

### **Deactivating the memory feature**

To deactivate this feature:

1. Press the SET control on the driver's door panel.
2. Within 5 five seconds, press any control on the remote transmitter which you would like to deactivate and then press the SET control on the driver's door panel again.
3. Repeat this procedure for another remote transmitter if desired.

### **KEYLESS ENTRY SYSTEM**

You can use the keyless entry keypad to:

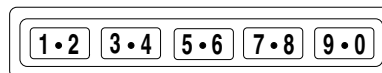

- lock or unlock the doors without using a key.
- open the trunk.
- recall memory seat/mirrors/steering column/adjustable pedals positions 1 or 2.

The keypad can be operated with the factory set 5–digit entry code; this code is located on the owner's wallet card in the glove box, is marked on the computer module, and is available from your authorized dealer. You can also create your own 5–digit personal entry code.

When pressing the controls on the keypad, press the middle of the controls to ensure a good activation.

### **Programming a personal entry code**

To create your own personal entry code:

1. Enter the factory set code.
2. Within five seconds press the 1 • 2 on the keypad. **Note:** The lock motors will cycle, locked then unlocked.

## Locks and Security

3. Enter your personal 5-digit code. Each number must be entered within five seconds of each other.

4. Enter a sixth digit to indicate which personality feature should be recalled by the personal code. **Note:** The lock motors will cycle, locked then unlocked.

- 1 • 2 recalls driver personality 1.
- 3 • 4 recalls driver personality 2.
- 9 • 0 does not recall a driver personality.

Wait 5 seconds without pressing a keypad button in order to store a personal entry code.

### Tips:

- Do not set a code that uses five of the same number.
- Do not use five numbers in sequential order.
- The factory set code will work even if you have set your own personal code.
- If you set a personal code and store it over an existing personal code it will erase that personal code only.

### Erasing personal code

1. Enter the factory set 5–digit code.

2. Press and hold the 1 • 2 for two seconds and release; this must be done within five seconds of completing step 1.



3. Press and hold the 1 • 2 for two seconds to erase the customer programmed code; this must be done within five seconds of completing step 2.

Your personal code is now erased and only the factory set 5–digit code will work.

### Anti-scan feature

If the wrong code has been entered 35 times, the keypad will go into an anti-scan mode. This mode disables the keypad for one minute and the keypad lamp will flash.

The anti-scan feature will turn off after:

- one minute of keypad inactivity.
- pressing the UNLOCK  control on the remote entry transmitter.
- the ignition is turned to the ON position.
- a key turned to the UNLOCK  position on the driver's door.

## Locks and Security

### Unlocking and locking the doors using keyless entry

**To unlock the driver's door**, enter the factory set 5-digit code or your personal code. Each number must be pressed within five seconds of each other. The interior lamps will illuminate when the driver's door is unlocked.

**To unlock all doors**, press the 3 • 4 control within five seconds.

**To lock all doors**, press the 7 • 8 and the 9 • 0 at the same time. You **do not** need to enter the keypad code first. **Note:** The interior lamps will turn off.

### ***Recalling a memory seat/mirrors/steering column/adjustable pedals position 1 or 2***

- Unlock the vehicle using the personal entry code 1 in order to recall memory position 1.
- Unlock the vehicle using the personal entry code 2 in order to recall memory position 2.

### Releasing the trunk with the keyless entry system

To release/open the trunk, enter the factory-set code or personal code (driver door unlocks) and press 5 • 6 within five seconds.

### **SECURILOCK™ PASSIVE ANTI-THEFT SYSTEM**

SecuriLock™ passive anti-theft system is an engine immobilization system. This system is designed to prevent the engine from being started unless a **coded key programmed to your vehicle** is used. The use of the wrong type of coded key may lead to a “no-start” condition.

Your vehicle comes with three coded keys; additional coded keys may be purchased from your dealer. The dealer can program your spare keys to your vehicle or you can program the keys yourself. Refer to *Programming spare keys* for instructions on how to program the coded key.

**Note:** The SecuriLock™ passive anti-theft system is not compatible with non-Ford aftermarket remote start systems. Use of these systems may result in vehicle starting problems and a loss of security protection.

**Note:** Large metallic objects, electronic devices that are used to purchase gasoline or similar items, or a second coded key on the same key chain may cause vehicle starting issues. You need to prevent these objects from touching the coded key while starting the engine. These objects will not cause damage to the coded key, but may cause a momentary issue if they are too close to the key when starting the

## Locks and Security

engine. If a problem occurs, turn the ignition off, remove all objects on the key chain away from the coded key and restart the engine.

### Theft indicator

The theft indicator is located on top of the instrument panel.

- When the ignition is in the ON position, the indicator will glow for 3 seconds to indicate normal system functionality.

If a problem occurs with the SecuriLock<sup>™</sup> system, the indicator will flash rapidly or glow steadily when the ignition is in the ON position. If this occurs, the vehicle should be taken to an authorized dealer for service.

### Replacement keys

If your keys are lost or stolen and you don't have an extra coded key, you will need to have your vehicle towed to a dealership. The key codes need to be erased from your vehicle and new coded keys will need to be programmed.

Replacing coded keys can be very costly. Store an extra programmed key away from the vehicle in a safe place to help prevent any inconveniences. Please visit an authorized dealer to purchase additional spare or replacement keys.

### Programming spare keys

You can program your own coded keys to your vehicle. Please read and understand the entire procedure before you begin.

#### Tips:

- A maximum of eight keys can be coded to your vehicle.
- Only use Securilock<sup>™</sup> keys.
- You must have two previously programmed coded keys (keys that already operate your vehicle's engine) and the new unprogrammed key(s) readily accessible.
- If no previously programmed coded keys are available, you must take your vehicle to your dealer to have the spare key(s) programmed.

## Locks and Security

1. Insert a previously programmed coded key into the ignition.
2. Turn the ignition from the 1 (LOCK) position to the 4 (RUN) position. Keep the ignition in the 4 (RUN) position for at least one second, but no more than 10 seconds.

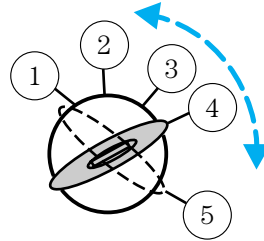

3. Turn the ignition to the 1 (LOCK) position, and remove the coded key from the ignition.
4. Within ten seconds of removing the previously programmed coded key, insert the other previously programmed coded key into the ignition.
5. Turn the ignition from the 1 (LOCK) position to the 4 (RUN) position. Keep the ignition in the 4 (RUN) position for at least one second but not more than 10 seconds.
6. Turn the ignition to the 1 (LOCK) position, and remove the second key from the ignition.
7. Within twenty seconds of removing the previously programmed coded key, insert the unprogrammed key (new/valet key) into the ignition.
8. Turn the ignition from the 1 (LOCK) position to the 4 (RUN) position. Keep the ignition in the 4 (RUN) position for at least one second.
9. Your new unprogrammed key is now programmed.

If the key has been successfully programmed it will start the vehicle's engine and the theft indicator light will illuminate for three seconds and then go out. If the key was not successfully programmed, it will not start your vehicle's engine and the theft indicator light will flash on and off. If failure repeats, bring your vehicle to your dealer to have the new key(s) programmed.

To program additional new unprogrammed key(s), repeat this procedure from step 1 for each additional key.

### PERIMETER ALARM SYSTEM

The perimeter anti-theft system will help prevent your vehicle from unauthorized entry.

If there is any potential perimeter anti-theft problem with your vehicle, ensure **ALL remote entry transmitters** are taken to the dealership to aid in troubleshooting.

## Locks and Security

### Arming the system

When armed, this system will respond if unauthorized entry is attempted. When unauthorized entry occurs, the system will flash the turn signal lamps and will sound the horn.

The system is ready to arm whenever key is removed from the ignition. Any of the following actions will prearm the alarm system:

- Press the  control on the remote entry transmitter.
- Press the driver or passenger interior power door lock control while that respective door is open, then close the door.
- Lock the vehicle with the key in the driver's door key cylinder.
- Lock the vehicle by pressing the 7 • 8 and the 9 • 0 on the keypad at the same time

### Theft indicator

When the vehicle is locked using one of the listed methods, the theft indicator located on the instrument panel will flash briefly every 2 seconds to indicate that the perimeter alarm system is armed.

### Disarming the system

You can disarm the system by any of the following actions:

- Unlock the doors by pressing the  control on your remote entry transmitter.
- Unlock the doors with a key. Turn the key full travel (toward the front of the vehicle) to ensure the alarm disarms.
- Unlock the doors by entering the factory-set code or any of the three custom codes into the keyless entry keypad.
- Turn the ignition to the 4 (RUN) position with a SecuriLock<sup>™</sup> coded key.

### Triggering the anti-theft system

The armed system will be triggered if any door, the trunk or the hood is opened without using the key or the remote entry transmitter.

## Seating and Safety Restraints

### SEATING

#### Notes:



Reclining the seatback can cause an occupant to slide under the seat's safety belt, resulting in severe personal injuries in the event of a collision.



Do not pile cargo higher than the seatbacks to reduce the risk of injury in a collision or sudden stop.

#### Adjustable head restraints

Head restraints help to limit head motion in the event of a rear collision. Adjust your head restraint so that it is located directly or as close as possible behind your head.

The head restraints can be moved up and down.

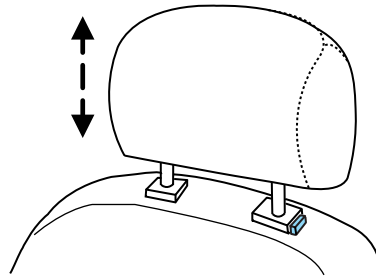

Push control to lower head restraint.

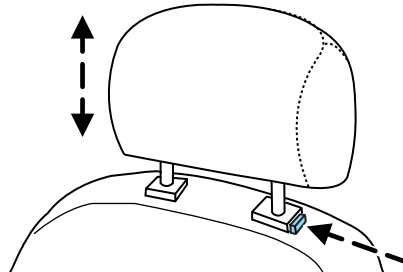

## Seating and Safety Restraints

### Using the manual lumbar support (if equipped)

The lumbar control is located on the front of the seat cushion.

Turn to adjust lumbar support.

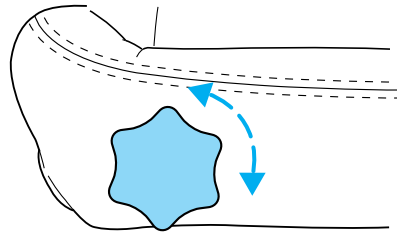

### Using the power lumbar support (if equipped)

The power lumbar control is located on the outboard side of the seat.

Press the front of the control to increase firmness.

Press the back of the control to decrease firmness.

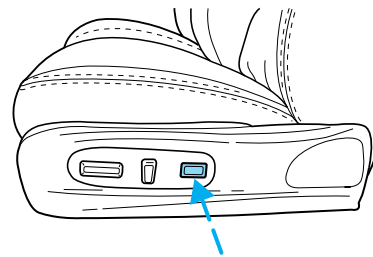

### Adjusting the power seats

The power seat controls are located on the outboard side of the seat.



Never adjust the driver's seat or seatback when the vehicle is moving.



Always drive and ride with your seatback upright and the lap belt snug and low across the hips.



Reclining the seatback can cause an occupant to slide under the seat's safety belt, resulting in severe personal injuries in the event of a collision.

## Seating and Safety Restraints

Rotate the vertical control to adjust the seatback.

- Driver
- Passenger

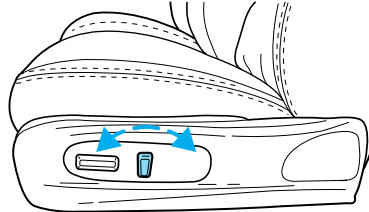

Slide the control forward or backward to move the seat forward or backward.

- Driver
- Passenger

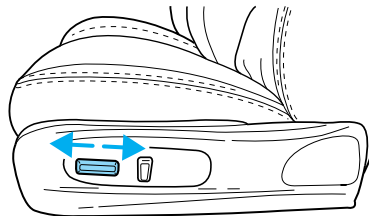

Move the control up or down to move the seat up and down.

- Driver
- Passenger

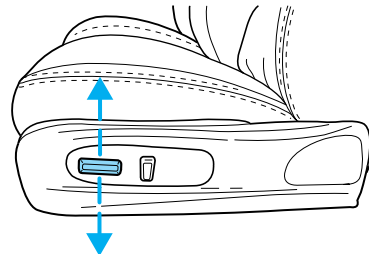

Move front/rear of control up or down to tilt the front/rear of the seat cushion.

- Driver

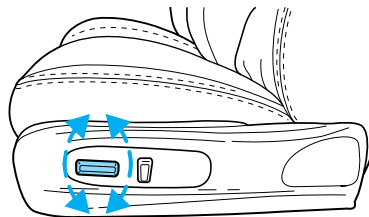

### Easy-access/easy-out feature (if equipped)

This feature automatically moves the driver's seat backward 5 cm (2 inches) when the key is removed from the ignition cylinder.

The seat will move 5 cm (2 inches) forward (to the original position) when the key is placed in the ignition cylinder.

## Seating and Safety Restraints

### ***Deactivating/activating the easy-access/easy-out feature***

The easy-access/easy-out feature can be turned off or on through the vehicle message center (if equipped). If your vehicle does not have a message center, the feature can be turned off or on by your dealer.

### **Memory seats/steering column/mirrors/adjustable pedals (if equipped)**

This system allows automatic positioning of the driver seat, adjustable pedals, outside rearview mirrors, and power adjusted tilt/telescope steering column to two programmable positions.

The memory seat control is located on the driver door.

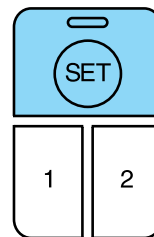

- To program position one, move the driver seat, steering column, exterior mirrors, and adjustable pedals to the desired position using the seat controls. Press the SET control. The SET control indicator light will briefly illuminate. While the light is illuminated, press control 1.
- To program position two, repeat the previous procedure using control 2.

A position can only be recalled when the transmission gearshift is in Park (automatic transmission). A memory seat position may be programmed at any time.

The memory seat positions are also recalled when you press your remote entry transmitter UNLOCK control and the transmitter is programmed to a memory seat position or when you enter a valid customer code 1 or 2 on the keypad.

To program the memory seat to remote entry transmitter, refer to *Remote entry system* in the *Locks and security chapter*.

**Note: The seat will not travel to its final position if the key is not in the ignition and the easy entry feature is enabled.**

### **Climate controlled seats operation**

The controls for the climate controlled seats are located on the dual electronic automatic temperature control (DEATC) system. Refer to *Climate controls* for more information.

## Seating and Safety Restraints

### ***Climate controlled seats air filter replacement***

The climate controlled seat system includes air filters that must be replaced periodically. Refer to the *Scheduled Maintenance Guide* for more information.

- There is a filter located under each front seat.

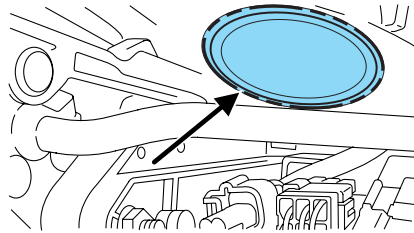

- They can be accessed from the second row seat. Move the front seat all the way forward and up to ease access.

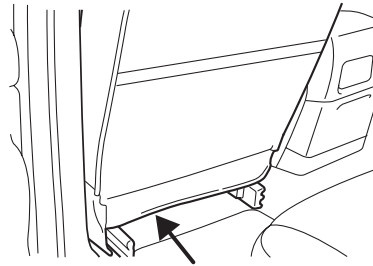

To remove an air filter:

- Remove key from ignition.
- Push up on the outside rigid edge of the air filter and rotate toward the front of the vehicle once tabs are released.

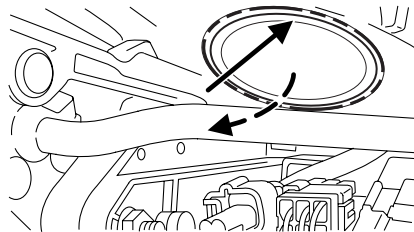

## Seating and Safety Restraints

- Remove filter.

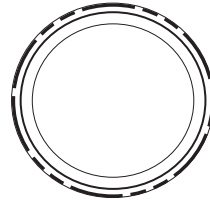

To install an air filter:

- First, position the filter in its housing making sure that the far forward end is all the way up in the housing. Then push in on the center of the outside edge of the filter and rotate up into the housing until it clips into position.

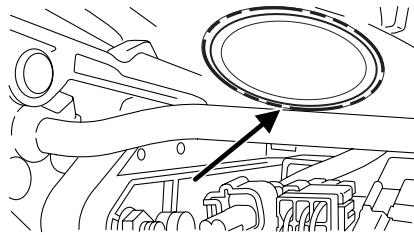

## REAR SEATS

### Adjustable rear head restraints (if equipped)

Head restraints help to limit head motion in the event of a rear collision. Adjust your head restraint so that it is located directly or as close as possible behind your head.

The head restraints can be moved up and down.

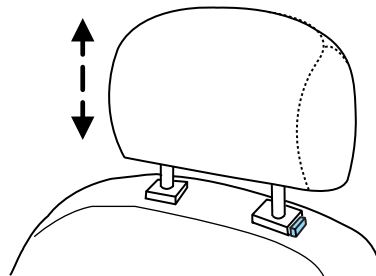

## Seating and Safety Restraints

Push control to lower head restraint.

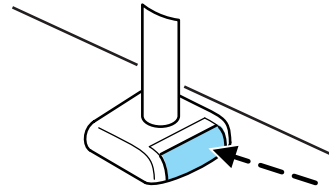

### Rear heated seats (if equipped)

- Push the bottom of the button for low heat.
- Push again to deactivate.



- Push the top of the button for high heat.
- Push again to deactivate.



The heated seats will activate when the ignition is in the RUN position. When activated, they will turn off automatically after 10 minutes or when the ignition is turned to the OFF position.

The indicator light will illuminate when each heated seat has been activated.

### 2nd seat/Split-folding rear seat

One or both rear seatbacks can be folded down to provide additional cargo space.

## Seating and Safety Restraints

To lower the seatback(s), pull the release handle(s) located inside the trunk.

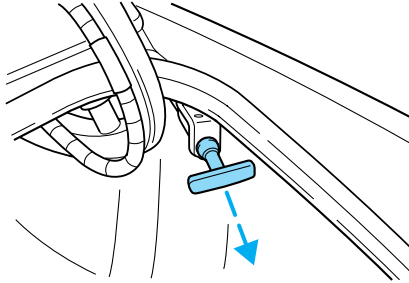

Fold the seatback(s) down.

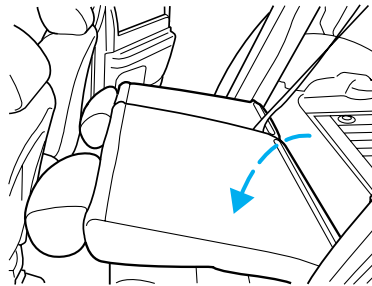

When raising the seatback(s), make sure you hear the seat latch into place.

Make sure that the safety belts for the rear center passengers are properly routed over the rear seatback.

### SAFETY RESTRAINTS

#### Personal Safety System

The Personal Safety System provides an improved overall level of frontal crash protection to front seat occupants and is designed to help further reduce the risk of air bag-related injuries. The system is able to analyze different occupant conditions and crash severity before activating the appropriate safety devices to help better protect a range of occupants in a variety of frontal crash situations.

Your vehicle's Personal Safety System consists of the following items:

- Driver and passenger dual-stage air bag supplemental restraints
- Driver and front passenger side air bags
- Driver and passenger side air curtains (if equipped)
- Front safety belts with pretensioners, energy management retractors, and safety belt usage sensors

## Seating and Safety Restraints

- Driver's seat position sensor
- Passenger occupant classification sensor
- Front crash severity sensor
- Restraints Control Module (RCM) with impact and safing sensors
- Restraint system warning light and back-up tone
- The electrical wiring for the air bags, crash sensor(s), safety belt pretensioners, front safety belt usage sensors, driver seat position sensor, passenger occupant classification sensor, and indicator lights

### ***How does the personal safety system work?***

The Personal safety system can adapt the deployment strategy of your vehicle's safety devices according to crash severity and occupant conditions. A collection of crash and occupant sensors provides information to the Restraints control module (RCM). During a crash, the RCM activates the safety belt pretensioners and/or either one or both stages of the dual-stage air bag supplemental restraints based on crash severity and occupant conditions.

The fact that the pretensioners or air bags did not activate for both front seat occupants in a collision does not mean that something is wrong with the system. Rather, it means the Personal safety system determined the accident conditions (crash severity, belt usage, etc.) were not appropriate to activate these safety devices. Front air bags and pretensioners are designed to activate only in frontal and near-frontal collisions, not rollovers, side-impacts, or rear-impacts unless the collision causes sufficient longitudinal deceleration.

### ***Driver and passenger dual-stage air bag supplemental restraints***

The dual-stage air bags offer the capability to tailor the level of air bag inflation energy. A lower, less forceful energy level is provided for more common, moderate-severity impacts. A higher energy level is used for the most severe impacts. Refer to *Air bag supplemental restraints* section in this chapter.

### ***Front crash severity sensor***

The front crash severity sensor enhances the ability to detect the severity of an impact. Positioned up front, it provides valuable information early in the crash event on the severity of the impact. This allows your Personal safety system to distinguish between different levels of crash severity and modify the deployment strategy of the dual-stage air bags and safety belt pretensioners.

## Seating and Safety Restraints

### ***Driver's seat position sensor***

The driver's seat position sensor allows your Personal safety system to tailor the deployment level of the driver dual-stage air bag based on seat position. The system is designed to help protect smaller drivers sitting close to the driver air bag by providing a lower air bag output level.

### ***Passenger occupant classification sensor (OCS)***

For air bags to do their job they must inflate with great force, and this force can pose a potentially deadly risk to occupants that are very close to the air bag when it begins to inflate. For some occupants, this occurs because they are initially sitting very close to the air bag. For other occupants, this occurs when the occupant is not properly restrained by seat belts or child safety seats and they move forward during pre-crash braking. The most effective way to reduce the risk of unnecessary injuries is to make sure all occupants are properly restrained. Accident statistics suggest that children are much safer when properly restrained in the rear seating positions than in the front.



Air bags can kill or injure a child in a child seat. **NEVER** place a rear-facing child seat in front of an active air bag. If you must use a forward-facing child seat in the front seat, move the seat all the way back.



Always transport children 12 years old and under in the back seat and always properly use appropriate child restraints.

The passenger occupant classification sensor can automatically turn off the passenger front air bag and side air bag (if equipped). The system is designed to help protect small (child size) occupants from air bag deployments when they are improperly seated or restrained in the front passenger seat contrary to proper child-seating or restraint usage recommendations. Even with this technology, parents are **STRONGLY** encouraged to always properly restrain children in the rear seat. The sensor also turns off the air bag(s) when the passenger seat is empty to prevent unnecessary replacement of the air bag(s) after a collision.

### ***Front safety belt usage sensors***

The front safety belt usage sensors detect whether or not the driver and front outboard passenger safety belts are fastened. This information allows your Personal safety system to tailor the air bag deployment and safety belt pretensioner activation depending upon safety belt usage. Refer to *Safety belt* section in this chapter.

## Seating and Safety Restraints

### ***Front safety belt pretensioners***

The safety belt pretensioners at the front outboard seating positions are designed to tighten the safety belts firmly against the occupant's body during a frontal or near-frontal collision. This maximizes the effectiveness of the safety belts and helps properly position the occupant relative to the air bag to improve protection. The safety belt pretensioners can be either activated alone or, if the collision is of sufficient severity, together with the air bags.

### ***Front safety belt energy management retractors***

The front safety belt energy management retractors allow webbing to be pulled out of the retractor in a gradual and controlled manner in response to the occupant's forward momentum. This helps reduce the risk of force-related injuries to the occupant's chest by limiting the load on the occupant. Refer to *Energy management feature* section in this chapter.

### ***Determining if the Personal safety system is operational***

The Personal safety system uses a warning light in the instrument cluster or a back-up tone to indicate the condition of the system. Refer to the *Warning light* section in the *Instrument cluster* chapter. Routine maintenance of the Personal safety system is not required.

The Restraints control module (RCM) monitors its own internal circuits and the circuits for the air bag supplemental restraints, crash sensor(s), safety belt pretensioners, front safety belt buckle sensors, driver seat position sensor, and passenger occupant classification sensor. In addition, the RCM also monitors the restraints warning light in the instrument cluster. A difficulty with the system is indicated by one or more of the following.

- The warning light will either flash or stay lit.
- The warning light will not illuminate immediately after ignition is turned on.
- A series of five beeps will be heard. The tone pattern will repeat periodically until the problem and warning light are repaired.

If any of these things happen, even intermittently, have the Personal safety system serviced at your dealership or by a qualified technician immediately. Unless serviced, the system may not function properly in the event of a collision.

## Seating and Safety Restraints

### Safety restraints precautions



Always drive and ride with your seatback upright and the lap belt snug and low across the hips.



To reduce the risk of injury, make sure children sit where they can be properly restrained.



Never let a passenger hold a child on his or her lap while the vehicle is moving. The passenger cannot protect the child from injury in a collision.



All occupants of the vehicle, including the driver, should always properly wear their safety belts, even when an air bag (SRS) is provided.



It is extremely dangerous to ride in a cargo area, inside or outside of a vehicle. In a collision, people riding in these areas are more likely to be seriously injured or killed. Do not allow people to ride in any area of your vehicle that is not equipped with seats and safety belts. Be sure everyone in your vehicle is in a seat and using a safety belt properly.



In a rollover crash, an unbelted person is significantly more likely to die than a person wearing a safety belt.



Each seating position in your vehicle has a specific safety belt assembly which is made up of one buckle and one tongue that are designed to be used as a pair. 1) Use the shoulder belt on the outside shoulder only. Never wear the shoulder belt under the arm. 2) Never swing the safety belt around your neck over the inside shoulder. 3) Never use a single belt for more than one person.



Always transport children 12 years old and under in the back seat and always properly use appropriate child restraints.

## Seating and Safety Restraints



Safety belts and seats can become hot in a vehicle that has been closed up in sunny weather; they could burn a small child. Check seat covers and buckles before you place a child anywhere near them.

### Combination lap and shoulder belts

- Front seat belts

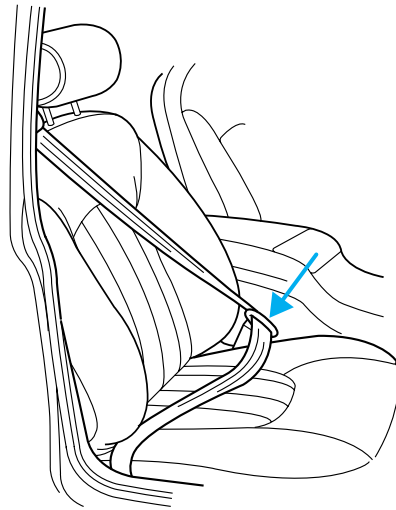

- Rear seat belts

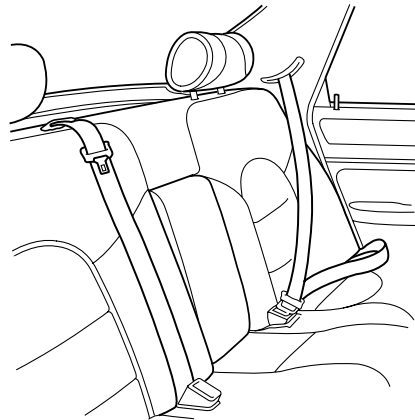

## Seating and Safety Restraints

1. Insert the belt tongue into the proper buckle (the buckle closest to the direction the tongue is coming from) until you hear a snap and feel it latch. Make sure the tongue is securely fastened in the buckle.

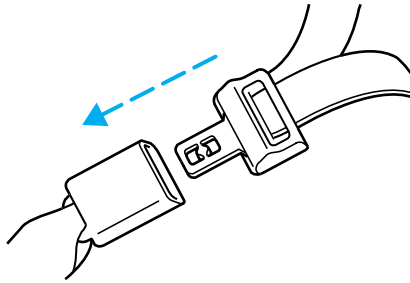

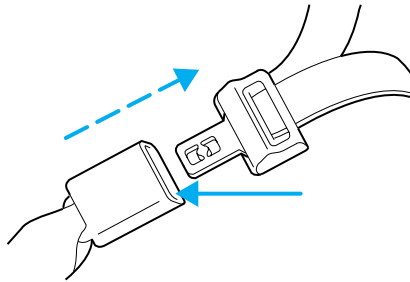

2. To unfasten, push the release button and remove the tongue from the buckle.



### Energy management feature

- This vehicle has a seat belt system with an energy management feature at the front outboard seating positions to help further reduce the risk of injury in the event of a head-on collision.
- This seat belt system has a retractor assembly that is designed to pay out webbing in a controlled manner. This feature is designed to help reduce the belt force acting on the occupant's chest.

 After any vehicle collision, the seat belt system at all passenger seating positions must be checked by a qualified technician to verify that the “automatic locking retractor” feature for child seats is still functioning properly. In addition, all seat belts should be checked for proper function.

 **BELT AND RETRACTOR ASSEMBLY MUST BE REPLACED** if the seat belt assembly “automatic locking retractor” feature or any other seat belt function is not operating properly when checked according to the procedures in Workshop Manual.

## Seating and Safety Restraints



Failure to replace the belt and retractor assembly could increase the risk of injury in collisions.

The front outboard and rear safety restraints in the vehicle are combination lap and shoulder belts. The front passenger and rear seat safety belts have two types of locking modes.

### Vehicle sensitive mode

This is the normal retractor mode, which allows free shoulder belt length adjustment to your movements and locking in response to vehicle movement. For example, if the driver brakes suddenly or turns a corner sharply, or the vehicle receives an impact of approximately 8 km/h (5 mph) or more, the combination safety belts will lock to help reduce forward movement of the driver and passengers.

### Automatic locking mode

#### *How to use the automatic locking mode*

- Buckle the combination lap and shoulder belt.

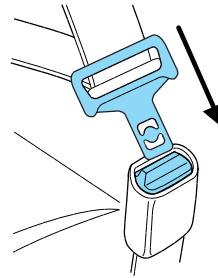

- Grasp the shoulder portion and pull downward until the entire belt is pulled out.



- Allow the belt to retract. As the belt retracts, you will hear a clicking sound. This indicates the safety belt is now in the automatic locking mode.

## Seating and Safety Restraints

In this mode, the shoulder belt is automatically pre-locked. The belt will still retract to remove any slack in the shoulder belt. The automatic locking mode is not available on the driver safety belt.

This mode should be used **any time** a child safety seat is installed in the vehicle. Children 12 years old and under should be properly restrained in the rear seat whenever possible. Refer to *Safety restraints for children* or *Safety seats for children* later in this chapter.

### **How to disengage the automatic locking mode**

Unbuckle the combination lap and shoulder belt and allow it to retract completely to disengage the automatic locking mode and activate the vehicle sensitive (emergency) locking mode.

 After any vehicle collision, the combination lap and shoulder belt system at all passenger seating positions must be checked by a qualified technician to verify that the “automatic locking retractor” feature for child seats is still functioning properly, in addition to other checks for proper seat belt system function.

 BELT AND RETRACTOR ASSEMBLY MUST BE REPLACED if the safety belt assembly “automatic locking retractor” feature or any other safety belt function is not operating properly. In addition, all safety belts should be checked for proper function. Failure to replace the belt and retractor assembly could increase the risk of injury in collisions.

### **Safety belt pretensioner**

Your vehicle is equipped with safety belt pretensioners at the driver and front passenger seating positions.

The safety belt pretensioner is a device which removes excess webbing from the safety belt system. The safety belt pretensioner uses the same crash sensor system as the front air bag supplemental restraint system (SRS). When the safety belt pretensioner deploys, webbing from the lap and shoulder belt is tightened. The driver and front passenger seat belt system (including retractors, buckles and height adjusters) must be replaced if the vehicle is involved in a collision that results in deployment of front air bags and safety belt pretensioners. Refer to the *Safety belt maintenance* section in this chapter.

## Seating and Safety Restraints



Failure to replace the safety belt assembly under the above conditions could result in severe personal injuries in the event of a collision.

### Front safety belt height adjustment

Adjust the height of the shoulder belt so the belt rests across the middle of your shoulder.

To adjust the shoulder belt height, push the button and slide the height adjuster up or down. Release the button and pull down on the height adjuster to make sure it is locked in place.



Position the safety belt height adjusters so that the belt rests across the middle of your shoulder. Failure to adjust the safety belt properly could reduce the effectiveness of the seat belt and increase the risk of injury in a collision.

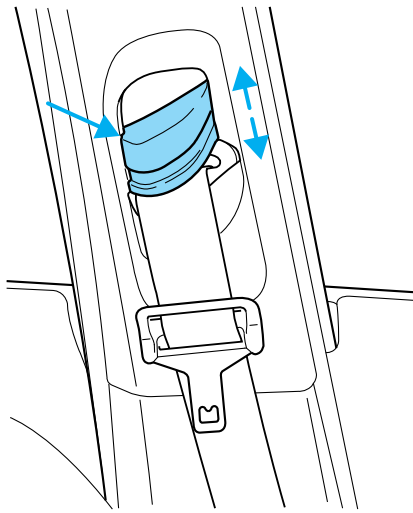

### Safety belt warning light and indicator chime

The safety belt warning light illuminates in the instrument cluster and a chime sounds to remind the occupants to fasten their safety belts.

## Seating and Safety Restraints

### Conditions of operation

If...	Then...
The driver's safety belt is not buckled before the ignition switch is turned to the RUN position...	The safety belt warning light illuminates 1-2 minutes and the warning chime sounds 4-8 seconds.
The driver's safety belt is buckled while the indicator light is illuminated and the warning chime is sounding...	The safety belt warning light and warning chime turn off.
The driver's safety belt is buckled before the ignition switch is turned to the RUN position...	The safety belt warning light and indicator chime remain off.

### BeltMinder

The BeltMinder feature is a supplemental warning to the safety belt warning function. This feature provides additional reminders by intermittently sounding a chime and illuminating the safety belt warning lamp in the instrument cluster when the driver's safety belt is unbuckled.

The BeltMinder feature uses information from the passenger occupant classification sensor to determine if a front seat passenger is present and therefore potentially in need of a warning. To avoid activating the BeltMinder feature for objects placed in the front passenger seat, warnings will only be given to large front seat occupants as determined by the passenger occupant classification sensor.

Both the driver's and passenger's safety belt usages are monitored and either may activate the BeltMinder feature. The warnings are the same for the driver and the front passenger. If the BeltMinder warnings have expired (warnings for approximately 5 minutes) for one occupant (driver or front passenger), the other occupant can still activate the BeltMinder feature.

## Seating and Safety Restraints

If...	Then...
The driver's and front passenger's safety belts are buckled before the ignition switch is turned to the ON position or less than 1-2 minutes have elapsed since the ignition switch has been turned ON...	The BeltMinder feature will not activate.
The driver's or front passenger's safety belt is not buckled when the vehicle has reached at least 5 km/h (3 mph) and 1-2 minutes have elapsed since the ignition switch has been turned to ON...	The BeltMinder feature is activated - the safety belt warning light illuminates and the warning chime sounds for 6 seconds every 30 seconds, repeating for approximately 5 minutes or until the safety belts are buckled.
The driver's or front passenger's safety belt becomes unbuckled for approximately 1 minute while the vehicle is traveling at least 5 km/h (3 mph) and more than 1-2 minutes have elapsed since the ignition switch has been turned to ON...	The BeltMinder feature is activated - the safety belt warning light illuminates and the warning chime sounds for 6 seconds every 30 seconds, repeating for approximately 5 minutes or until the safety belts are buckled.

## Seating and Safety Restraints

The following are reasons most often given for not wearing safety belts:  
(All statistics based on U.S. data)

Reasons given...	Consider...
"Crashes are rare events"	<b>36700 crashes occur every day.</b> The more we drive, the more we are exposed to "rare" events, even for good drivers. <i>1 in 4 of us will be seriously injured in a crash during our lifetime.</i>
"I'm not going far"	<b>3 of 4</b> fatal crashes occur within <b>25</b> miles of home.
"Belts are uncomfortable"	We design our safety belts to enhance comfort. If you are uncomfortable - try different positions for the safety belt upper anchorage and seatback which should be as upright as possible; this can improve comfort.
"I was in a hurry"	<b>Prime time for an accident.</b> BeltMinder reminds us to take a few seconds to buckle up.
"Safety belts don't work"	<b>Safety belts</b> , when used properly, <b>reduce risk of death</b> to front seat occupants by <b>45% in cars</b> , and by <b>60% in light trucks</b> .
"Traffic is light"	<b>Nearly 1 of 2 deaths occur in single-vehicle crashes</b> , many when no other vehicles are around.
"Belts wrinkle my clothes"	Possibly, but a serious crash can do much more than wrinkle your clothes, particularly if you are unbelted.
"The people I'm with don't wear belts"	Set the example, teen deaths occur 4 times more often in vehicles with TWO or MORE people. Children and younger brothers/sisters imitate behavior they see.

## Seating and Safety Restraints

Reasons given...	Consider...
"I have an air bag"	Air bags offer greater protection when used with safety belts. Frontal airbags are not designed to inflate in rear and side crashes or rollovers.
"I'd rather be thrown clear"	Not a good idea. <b>People</b> who are <b>ejected are 40 times more likely to DIE</b> . Safety belts help prevent ejection, WE CAN'T "PICK OUR CRASH".



Do not sit on top of a buckled safety belt to avoid the Belt Minder chime. Sitting on the safety belt will increase the risk of injury in an accident. To disable (one-time) or deactivate the Belt Minder feature please follow the directions stated below.

### ***One time disable***

If at any time the driver/front passenger quickly buckles then unbuckles, the BeltMinder feature for that seating position is disabled for the current ignition cycle. The BeltMinder feature will re-enable during the same ignition cycle if the occupant buckles and remains buckled for approximately 30 seconds. Confirmation is not given for the one time disable.

### ***Deactivating/activating the BeltMinder feature***

**The driver and front passenger BeltMinder are deactivated/activated independently. When deactivating/activating one seating position, do not buckle the other position as this will terminate the process.**

*Read steps 1 - 4 thoroughly before proceeding with the deactivation/activation programming procedure.*

The driver and front passenger BeltMinder features can be deactivated/activated by performing the following procedure:

Before following the procedure, make sure that:

- The parking brake is set
- The gearshift is in P (Park) (automatic transmission)
- The ignition switch is in the OFF position
- The driver and front passenger safety belts are unbuckled

## Seating and Safety Restraints



To reduce the risk of injury, do not deactivate/activate the Belt Minder feature while driving the vehicle.

1. Turn the ignition switch to the RUN (or ON) position. (DO NOT START THE ENGINE)
2. Wait until the safety belt warning light turns off. (Approximately 1 minute)
  - Step 3 must be completed within 50 seconds after the safety belt warning light turns off.
3. For the seating position being disabled, buckle then unbuckle the safety belt 9 times, ending in the unbuckled state. (Step 3 must be completed within 50 seconds after the safety belt warning light turns off.)
  - After step 3, the restraint system warning light (airbag light) will be turned on for three seconds.
4. Within 10 seconds of the light turning on, buckle then unbuckle the safety belt.
  - This will disable the BeltMinder feature for that seating position if it is currently enabled. As confirmation, the restraint system warning light will flash 4 times per second for 3 seconds.
  - This will enable the BeltMinder feature for that seating position if it is currently disabled. As confirmation, the restraint system warning light will flash 4 times per second for 3 seconds, followed by 3 seconds with the light off, then followed by the restraint system warning light flashing 4 times per second for 3 seconds again.

### Safety belt extension assembly

If the safety belt is too short when fully extended, there is a 20 cm (8 inch) safety belt extension assembly that can be added (part number 611C22). This assembly can be obtained from your dealer at no cost.

Use only extensions manufactured by the same supplier as the safety belt. Manufacturer identification is located at the end of the webbing on the label. Also, use the safety belt extension only if the safety belt is too short for you when fully extended.

## Seating and Safety Restraints



Do not use extensions to change the fit of the shoulder belt across the torso.

### Safety belt maintenance

Inspect the safety belt systems periodically to make sure they work properly and are not damaged. Inspect the safety belts to make sure there are no nicks, tears or cuts. Replace if necessary. All safety belt assemblies, including retractors, buckles, front seat belt buckle assemblies, buckle support assemblies (slide bar-if equipped), shoulder belt height adjusters (if equipped), shoulder belt guide on seatback (if equipped), child safety seat LATCH and tether anchors, and attaching hardware, should be inspected after a collision. Ford Motor Company recommends that all safety belt assemblies used in vehicles involved in a collision be replaced. However, if the collision was minor and a qualified technician finds that the belts do not show damage and continue to operate properly, they do not need to be replaced. Safety belt assemblies not in use during a collision should also be inspected and replaced if either damage or improper operation is noted.



Failure to inspect and if necessary replace the safety belt assembly under the above conditions could result in severe personal injuries in the event of a collision.

Refer to *Interior* in the *Cleaning* chapter.

### AIR BAG SUPPLEMENTAL RESTRAINT SYSTEM (SRS)

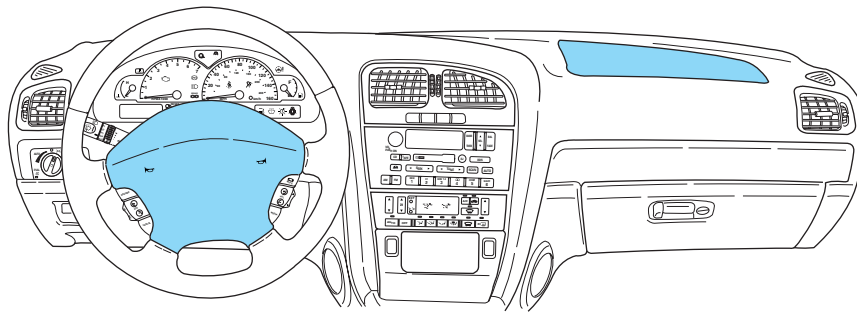



## Seating and Safety Restraints

### Important SRS precautions

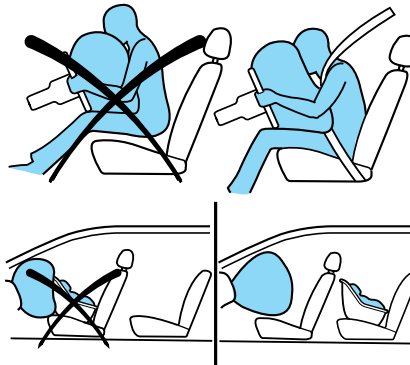
The SRS is designed to work with the safety belt to help protect the driver and right front passenger from certain upper body injuries. Air bags DO NOT inflate slowly; there is a risk of injury from a deploying air bag.



 All occupants of the vehicle, including the driver, should always properly wear their safety belts, even when an air bag (SRS) is provided.

 Always transport children 12 years old and under in the back seat and always properly use appropriate child restraints.

 The National Highway Traffic Safety Administration (NHTSA) recommends a minimum distance of at least 25 cm (10 inches) between an occupant's chest and the driver air bag module.

 Never place your arm over the air bag module as a deploying air bag can result in serious arm fractures or other injuries.

To properly position yourself away from the air bag:

- Move your seat to the rear as far as you can while still reaching the pedals comfortably.
- Recline the seat slightly one or two degrees from the upright position.

 Do not put anything on or over the air bag module. Placing objects on or over the air bag inflation area may cause those objects to be propelled by the air bag into your face and torso causing serious injury.

## Seating and Safety Restraints

 Do not attempt to service, repair, or modify the air bag supplemental restraint systems or its fuses. See your Ford or Lincoln Mercury dealer.

 Modifying or adding equipment to the front end of the vehicle (including frame, bumper, front end body structure and tow hooks) may affect the performance of the air bag system, increasing the risk of injury. Do not modify the front end of the vehicle.

### Children and air bags

Children must always be properly restrained. Accident statistics suggest that children are safer when properly restrained in the rear seating positions than in the front seating position. Failure to follow these instructions may increase the risk of injury in a collision.

 Air bags can kill or injure a child in a child seat. **NEVER** place a rear-facing child seat in front of an active air bag. If you must use a forward-facing child seat in the front seat, move the seat all the way back.

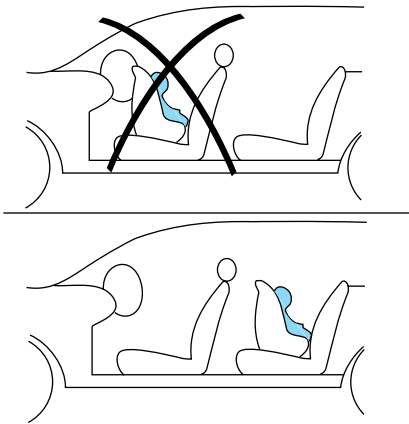

## Seating and Safety Restraints

### How does the safety belt pretensioner and air bag supplemental restraint system work?

The safety belt pretensioner and air bag SRS are designed to activate when the vehicle sustains longitudinal deceleration sufficient to cause the sensors to close an electrical circuit that initiates pretensioner activation and air bag inflation.

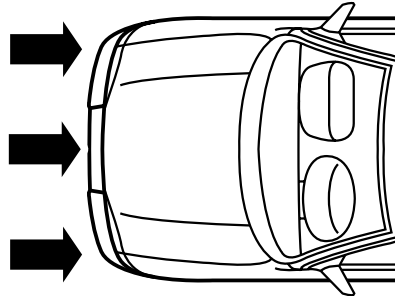

The fact that the pretensioners and air bags did not activate in a collision does not mean that something is wrong with the system. Rather, it means the forces were not of the type sufficient to cause activation. Front air bags and pretensioners are designed to activate in frontal and near-frontal collisions, not rollover, side-impact, or rear-impacts unless the collision causes sufficient longitudinal deceleration.

The air bags inflate and deflate rapidly upon activation. After air bag deployment, it is normal to notice a smoke-like, powdery residue or smell the burnt propellant. This may consist of cornstarch, talcum powder (to lubricate the bag) or sodium compounds (e.g., baking soda) that result from the combustion process that inflates the air bag. Small amounts of sodium hydroxide may be present which may irritate the skin and eyes, but none of the residue is toxic.



While the system is designed to help reduce serious injuries, contact with a deploying air bag may also cause abrasions, swelling or temporary hearing loss. Because air bags must inflate rapidly and with considerable force, there is the risk of death or serious injuries such as fractures, facial and eye injuries or internal injuries, particularly to occupants who

## Seating and Safety Restraints

are not properly restrained or are otherwise out of position at the time of air bag deployment. Thus, it is extremely important that occupants be properly restrained as far away from the air bag module as possible while maintaining vehicle control.



Several air bag system components get hot after inflation. Do not touch them after inflation.



If the air bag has deployed, **the air bag will not function again and must be replaced immediately.** If the air bag is not replaced, the unrepaired area will increase the risk of injury in a collision.

The SRS consists of:

- driver and passenger air bag modules (which include the inflators and air bags)
- side air bags. Refer to *Side air bag system* later in this chapter
- safety belt pretensioners
- one or more impact and safing sensors
- a readiness light and tone
- and the electrical wiring which connects the components

The diagnostic module monitors its own internal circuits and the supplemental air bag electrical system warning (including the impact sensors), the system wiring, the air bag system readiness light, the air bag back up power, the air bag ignitors and safety belt pretensioners.

### Determining if the system is operational

The SRS uses a readiness light in the instrument cluster or a tone to indicate the condition of the system. Refer to the *Air bag readiness* section in the *Instrument cluster* chapter. Routine maintenance of the air bag is not required.

Any difficulty with the system is indicated by one or more of the following:

- The readiness light will either flash or stay lit
- The readiness light will not illuminate immediately after ignition is turned to the RUN position



## Seating and Safety Restraints

- A series of five beeps will be heard. The tone pattern will repeat periodically until the problem and/or light are repaired.

If any of these things happen, even intermittently, have the SRS serviced at your dealership or by a qualified technician immediately. Unless serviced, the system may not function properly in the event of a collision.

### Side air bag system (if equipped)



Do not place objects or mount equipment on or near the air bag cover on the side of the seatbacks of the front seats or in front seat areas that may come into contact with a deploying air bag. Failure to follow these instructions may increase the risk of personal injury in the event of a collision.



Do not use accessory seat covers. The use of accessory seat covers may prevent the deployment of the side air bags and increase the risk of injury in an accident.



Do not lean your head on the door. The side air bag could injure you as it deploys from the side of the seatback.



Do not attempt to service, repair, or modify the air bag SRS, its fuses or the seat cover on a seat containing an air bag. See your Ford or Lincoln Mercury dealer.



All occupants of the vehicle should always wear their safety belts even when an air bag SRS is provided.

## Seating and Safety Restraints

### ***How does the side air bag system work?***

The side air bag system consists of the following:

- An inflatable nylon bag (air bag) with a gas generator concealed behind the outboard bolster of the driver and front passenger seatbacks.
- A special seat cover designed to allow air bag deployment.
- The same warning light, electronic control and diagnostic unit as used for the front air bags.
- Two crash sensors located under the outboard side of the front seats, attached near the floor.

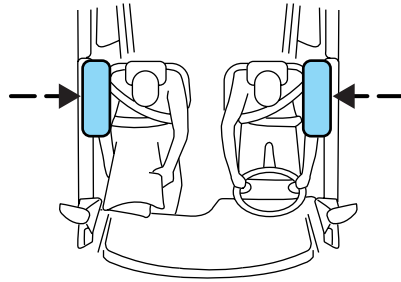

Side air bags, in combination with seat belts, can help reduce the risk of severe injuries in the event of a significant side impact collision.

The side air bags are fitted on the outboard side of the seatbacks of the front seats. In certain lateral collisions, the air bag on the side affected by the collision will be inflated, even if the respective seat is not occupied. The air bag was designed to inflate between the door panel and occupant to further enhance the protection provided occupants in side impact collisions.

The air bag SRS is designed to activate when the vehicle sustains lateral deceleration sufficient to cause the sensors to close an electrical circuit that initiates air bag inflation.

The fact that the air bags did not inflate in a collision does not mean that something is wrong with the system. Rather, it means the forces were not of the type sufficient to cause activation. Side air bags are designed to inflate in side-impact collisions, not roll-over, rear-impact, frontal or near-frontal collisions, unless the collision causes sufficient lateral deceleration.

## Seating and Safety Restraints

 Several air bag system components get hot after inflation. Do not touch them after inflation.

 If the side air bag has deployed, **the air bag will not function again. The side air bag system (including the seat) must be inspected and serviced by a qualified technician in accordance with the vehicle service manual.** If the air bag is not replaced, the unrepaired area will increase the risk of injury in a collision.

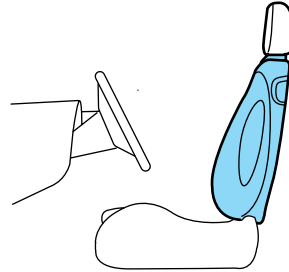

### ***Determining if the system is operational***

The SRS uses a readiness light in the instrument cluster or a tone to indicate the condition of the system. Refer to the *Air bag readiness* section in the *Instrument cluster* chapter. Routine maintenance of the air bag is not required.

Any difficulty with the system is indicated by one or more of the following:

- The readiness light (same light as used for front air bag system) will either flash or stay lit.
- The readiness light will not illuminate immediately after ignition is turned to the RUN position.
- A series of five beeps will be heard. The tone pattern will repeat periodically until the problem and light are repaired.

If any of these things happen, even intermittently, have the SRS serviced at your dealership or by a qualified technician immediately. Unless serviced, the system may not function properly in the event of a collision.

## Seating and Safety Restraints

### Side air curtain system (if equipped)

 Do not place objects or mount equipment on or near the airbag cover on the side of the seatbacks of the front seats or in front seat areas that may come into contact with a deploying airbag. Failure to follow these instructions may increase the risk of personal injury in the event of a collision.

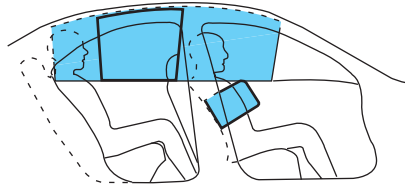

 Do not place objects or mount equipment on or near the headliner at the siderail that may come into contact with a deploying side air curtain. Failure to follow these instructions may increase the risk of personal injury in the event of a collision.

 Do not place objects or mount equipment on or near the side air curtain cover.

 Do not lean your head on the door. The side airbag could injure you as it deploys from the seat.

 Do not lean your head on the door. The side air curtain could injure you as it deploys from the headliner.

## Seating and Safety Restraints



Do not attempt to service, repair, or modify the side air curtain system, its fuses, the A, B, or C pillar trim, or the headliner on a vehicle containing a side air curtain. See your Ford or Lincoln Mercury dealer.



Do not attempt to service, repair, or modify the air bag supplemental restraint system, its fuses, or the seat cover on a seat containing an air bag. See your Ford or Lincoln Mercury dealer.



All occupants of the vehicle, including the driver, should always wear their safety belts even when an inflatable curtain is provided.



To reduce the risk of injury, do not obstruct or place objects in the deployment of the inflatable curtain.

## Seating and Safety Restraints

### ***How does the side air curtain system work?***

The side air curtain system consists of the following:

- An inflatable nylon curtain with a gas generator concealed behind the headliner and above the doors.
- The headliner will flex to open above the side doors to allow air curtain deployment.
- The same warning light, electronic control and diagnostic unit as used for the front airbags.
- Two crash sensors located under the outboard side of the front seats, attached near the floor.
- Two crash sensors located at the base of the “C” pillars above the wheel house.
- An inflatable nylon bag (airbag) with a gas generator concealed behind the outboard bolster of the driver and front passenger seatbacks.
- A special seat cover to allow airbag deployment (front seats only).

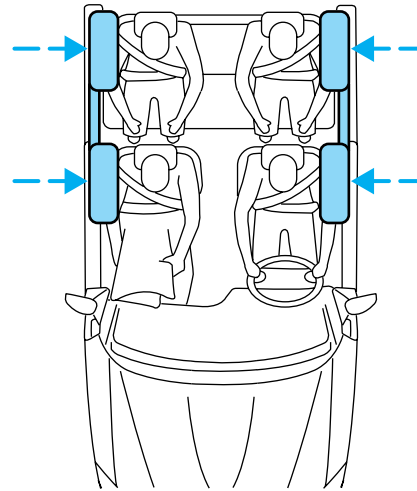

Side air curtains, in combination with seat belts, can help reduce the risk of severe injuries in the event of a significant side impact collision.

The side air curtains are mounted to the sheet metal above the first and second row seats. In certain lateral collisions, the air curtain on the side affected by the collision will be inflated, even if the respective seat is not occupied. The air curtain was designed to inflate between the side window area and occupant to further enhance the head protection provided to occupants in side impact collisions.

The air curtain SRS is designed to activate when the vehicle sustains lateral deceleration sufficient to cause the sensors to close an electrical circuit that initiates air curtain inflation.

The fact that the air curtains did not inflate in a collision does not mean that something is wrong with the system. Rather, it means the forces were not of the type sufficient to cause activation. Side air curtains are designed to inflate in side-impact collisions, not roll-over, rear-impact, frontal or near-frontal collisions, unless the collision causes sufficient lateral deceleration.

## Seating and Safety Restraints

 Several air bag system components get hot after inflation. Do not touch them after inflation.

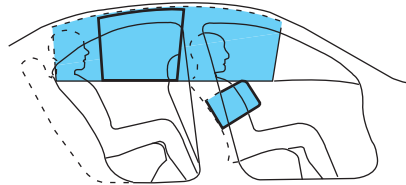

 If the side air curtain has deployed, **the air curtain will not function again. The side air curtain system (including the A, B and C pillar trim and headliner) must be inspected and serviced by a qualified technician in accordance with the vehicle service manual.** If the air curtain is not replaced, the unrepaired area will increase the risk of injury in a collision.

### ***Determining if the system is operational***

The SRS uses a readiness light in the instrument cluster or a tone to indicate the condition of the system. Refer to the *Air bag readiness* section in the *Instrument cluster* chapter. Routine maintenance of the air bag is not required.

Any difficulty with the system is indicated by one or more of the following:

- The readiness light (same light as used for front air bag system) will either flash or stay lit.
- The readiness light will not illuminate immediately after ignition is turned to the RUN position.
- A series of five beeps will be heard. The tone pattern will repeat periodically until the problem and light are repaired.

If any of these things happen, even intermittently, have the SRS serviced at your dealership or by a qualified technician immediately. Unless serviced, the system may not function properly in the event of a collision.

### **Disposal of air bags and air bag equipped vehicles (including pretensioners)**

See your local dealership or qualified technician. Air bags **MUST BE** disposed of by qualified personnel.

## Seating and Safety Restraints

### SAFETY RESTRAINTS FOR CHILDREN

See the following sections for directions on how to properly use safety restraints for children. Also see *Air bag supplemental restraint system (SRS)* in this chapter for special instructions about using air bags.

#### Important child restraint precautions

You are required by law to use safety restraints for children in the U.S. and Canada. If small children (generally children who are four years old or younger and who weigh 18 kg [40 lbs] or less) ride in your vehicle, you must put them in safety seats made especially for children. Check your local and state or provincial laws for specific requirements regarding the safety of children in your vehicle. When possible, always place children under age 12 in the rear seat of your vehicle. Accident statistics suggest that children are safer when properly restrained in the rear seating positions than in the front seating position.



Never let a passenger hold a child on his or her lap while the vehicle is moving. The passenger cannot protect the child from injury in a collision.

Always follow the instructions and warnings that come with any infant or child restraint you might use.

#### Children and safety belts

If the child is the proper size, restrain the child in a safety seat. Children who are too large for child safety seats (as specified by your child safety seat manufacturer) should always wear safety belts.

Follow all the important safety restraint and air bag precautions that apply to adult passengers in your vehicle.

If the shoulder belt portion of a combination lap and shoulder belt can be positioned so it does not cross or rest in front of the child's face or neck, the child should wear the lap and shoulder belt. Moving the child closer to the center of the vehicle may help provide a good shoulder belt fit.



Do not leave children, unreliable adults, or pets unattended in your vehicle.

## Seating and Safety Restraints

### **Child booster seats**

Children outgrow a typical convertible or toddler seat when they weigh 40 pounds and are around 4 years of age. Although the lap/shoulder belt will provide some protection, these children are still too small for lap/shoulder belts to fit properly, which could increase the risk of serious injury.

To improve the fit of both the lap and shoulder belt on children who have outgrown child safety seats, Ford Motor Company recommends use of a belt-positioning booster.

Booster seats position a child so that safety belts fit better. They lift the child up so that the lap belt rests low across the hips and the knees bend comfortably. Booster seats also make the shoulder belt fit better and more comfortably for growing children.

### **When children should use booster seats**

Children need to use booster seats from the time they outgrow the toddler seat until they are big enough for the vehicle seat and lap/shoulder belt to fit properly. Generally this is when they weigh about 80 lbs (about 8 to 12 years old).

Booster seats should be used until you can answer YES to ALL of these questions:

- Can the child sit all the way back against the vehicle seat back with knees bent comfortably at the edge of the seat without slouching?

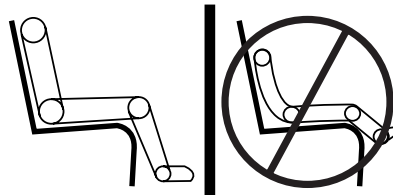

- Does the lap belt rest low across the hips?
- Is the shoulder belt centered on the shoulder and chest?
- Can the child stay seated like this for the whole trip?

## Seating and Safety Restraints

### ***Types of booster seats***

There are two types of belt-positioning booster seats:

- Those that are backless.

If your backless booster seat has a removable shield, remove the shield and use the lap/shoulder belt. If a seating position has a low seat back and no head restraint, a backless booster seat may place your child's head (top of ear level) above the top of the seat. In this case, move the backless booster to another seating position with a higher seat back and lap/shoulder belts.



- Those with a high back.

If, with a backless booster seat, you cannot find a seating position that adequately supports your child's head, a high back booster seat would be a better choice.



Both can be used in any vehicle in a seating position equipped with lap/shoulder belts if your child is over 40 lbs.

The shoulder belt should cross the chest, resting snugly on the center of the shoulder. The lap belt should rest low and snug across the hips, never up high across the stomach.

If the booster seat slides on the vehicle seat, placing a rubberized mesh sold as shelf or carpet liner under the booster seat may improve this condition.

## Seating and Safety Restraints

### The importance of shoulder belts

Using a booster without a shoulder belt increases the risk of a child's head hitting a hard surface in a collision. For this reason, you should never use a booster seat with a lap belt only. It is best to use a booster seat with lap/shoulder belts in the back seat- the safest place for children to ride.



Follow all instructions provided by the manufacturer of the booster seat.



Never put the shoulder belt under a child's arm or behind the back because it eliminates the protection for the upper part of the body and may increase the risk of injury or death in a collision.



Never use pillows, books, or towels to boost a child. They can slide around and increase the likelihood of injury or death in a collision.

## Seating and Safety Restraints

### SAFETY SEATS FOR CHILDREN



#### Child and infant or child safety seats

Use a safety seat that is recommended for the size and weight of the child. Carefully follow all of the manufacturer's instructions with the safety seat you put in your vehicle. If you do not install and use the safety seat properly, the child may be injured in a sudden stop or collision.

When installing a child safety seat:

- Review and follow the information presented in the *Air Bag Supplemental Restraint System* section in this chapter.
- Use the correct safety belt buckle for that seating position.
- Insert the belt tongue into the proper buckle until you hear a snap and feel it latch. Make sure the tongue is securely fastened in the buckle.
- Keep the buckle release button pointing up and away from the safety seat, with the tongue between the child seat and the release button, to prevent accidental unbuckling.
- Place seat back in upright position.
- Put the safety belt in the automatic locking mode. Refer to *Automatic locking mode*.

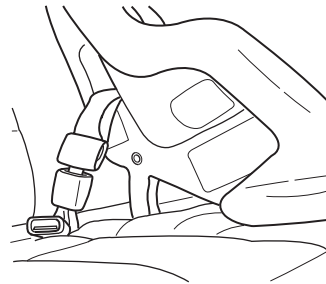

Ford recommends the use of a child safety seat having a top tether strap. Install the child safety seat in a seating position which is capable of providing a tether anchorage. For more information on top tether straps, refer to *Attaching safety seats with tether straps* in this chapter.

## Seating and Safety Restraints

 Carefully follow all of the manufacturer's instructions included with the safety seat you put in your vehicle. If you do not install and use the safety seat properly, the child may be injured in a sudden stop or collision.

 Rear-facing child seats or infant carriers should never be placed in the front seats.

### Installing child safety seats with combination lap and shoulder belts

 Air bags can kill or injure a child in a child seat. **NEVER** place a rear-facing child seat in front of an active air bag. If you must use a forward-facing child seat in the front seat, move the seat all the way back.

 Children 12 and under should be properly restrained in the rear seat whenever possible.

1. Position the child safety seat in a seat with a combination lap and shoulder belt.

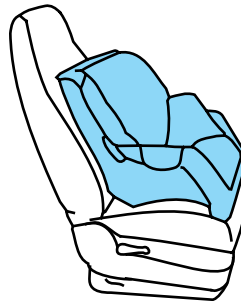

## Seating and Safety Restraints

2. Pull down on the shoulder belt and then grasp the shoulder belt and lap belt together.

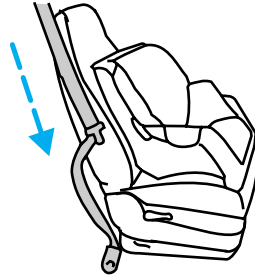

3. While holding the shoulder and lap belt portions together, route the tongue through the child seat according to the child seat manufacturer's instructions. Be sure the belt webbing is not twisted.

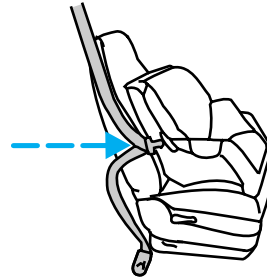

4. Insert the belt tongue into the proper buckle (the buckle closest to the direction the tongue is coming from) for that seating position until you hear a snap and feel the latch engage. Make sure the tongue is latched securely by pulling on it.

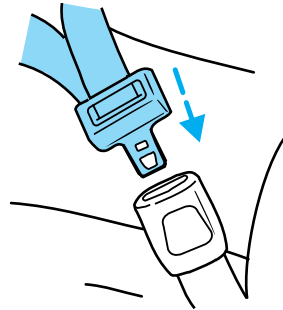

## Seating and Safety Restraints

5. To put the retractor in the automatic locking mode, grasp the shoulder portion of the belt and pull downward until all of the belt is pulled out and a click is heard.

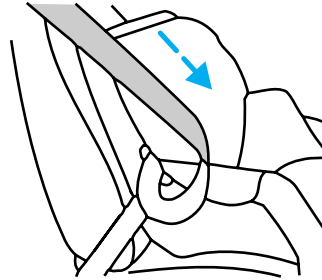

6. Allow the belt to retract. The belt will click as it retracts to indicate it is in the automatic locking mode.

7. Pull the lap belt portion across the child seat toward the buckle and pull up on the shoulder belt while pushing down with your knee on the child seat.

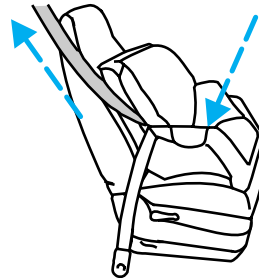

8. Allow the safety belt to retract to remove any slack in the belt.

9. Before placing the child in the seat, forcibly move the seat forward and back to make sure the seat is securely held in place. To check this, grab the seat at the belt path and attempt to move it side to side and forward. There should be no more than one inch of movement for proper installation.

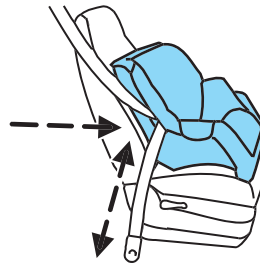

10. Try to pull the belt out of the retractor to make sure the retractor is in the automatic locking mode (you should not be able to pull more belt out). If the retractor is not locked, unbuckle the belt and repeat steps two through nine.

Check to make sure the child seat is properly secured before each use.

## Seating and Safety Restraints

### Attaching child safety seats with tether straps

Most new forward-facing child safety seats include a tether strap which goes over the back of the seat and hooks to an anchoring point. Tether straps are available as an accessory for many older safety seats. Contact the manufacturer of your child seat for information about ordering a tether strap.

The rear seats of your vehicle are equipped with built-in tether strap anchors located behind the seats as described below.

The tether anchors in your vehicle are located under a cover marked with the tether anchor symbol (shown with title).

The tether strap anchors in your vehicle are in the following positions (shown from top view):

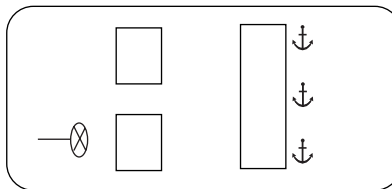

Attach the tether strap only to the appropriate tether anchor as shown. The tether strap may not work properly if attached somewhere other than the correct tether anchor.

1. Position the child safety seat on the seat cushion.
2. Route the child safety seat tether strap over the back of the seat.

For vehicles with adjustable head restraints, route the tether strap under the head restraint and between the head restraint posts, otherwise route the tether strap over the top of the seatback.

3. Locate the correct anchor for the selected seating position.



## Seating and Safety Restraints

4. Open the tether anchor cover.

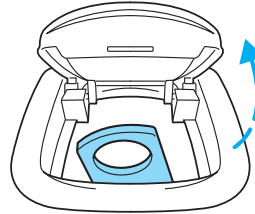

5. Clip the tether strap to the anchor as shown.



If the tether strap is clipped incorrectly, the child safety seat may not be retained properly in the event of a collision.

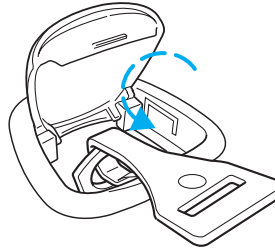

6. Refer to the *Installing child safety seats in combination lap and shoulder belt seating positions* section of this chapter for further instructions to secure the child safety seat.

7. Tighten the child safety seat tether strap according to the manufacturer's instructions.



If the safety seat is not anchored properly, the risk of a child being injured in a collision greatly increases.

## Seating and Safety Restraints

### Attaching safety seats with LATCH (Lower Anchors and Tethers for Children) attachments for child seat anchors

Some child safety seats have two rigid or webbing mounted attachments that connect to two anchors at certain seating positions in your vehicle. This type of child seat eliminates the need to use seat belts to attach the child seat. For forward-facing child seats, the tether strap must also be attached to the proper tether anchor. See *Attaching safety seats with tether straps* in this chapter.

Your vehicle has LATCH anchors for child seat installation at the seating positions marked with the child seat symbol.

The anchors on both sides of the center of the rear seat are provided primarily for child seats at the outboard seats, and are further apart than the pairs of lower anchors for child seat installation at other seats. A child seat with rigid LATCH attachments cannot be installed at the center rear seat. A

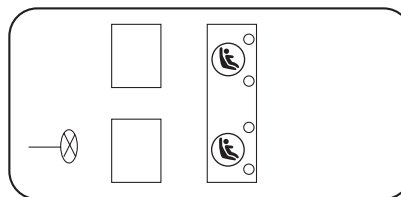

child seat with LATCH attachments on belt webbing can be used at the center rear seat unless a child seat at an outboard rear seat is attached to one of these lower anchors. Install a child seat onto the lower anchors at the center rear seat **ONLY IF** the child restraint manufacturer recommends that the child seat can be installed to anchors that are spaced up to 500 mm (19 in) apart.



Never attach two LATCH child safety seats to the same anchor. In a crash, one anchor may not be strong enough to hold two child safety seat attachments and may break, causing serious injury or death.

## Seating and Safety Restraints

The lower anchors for child seat installation are located at the rear section of the rear seat between the cushion and seat back. The LATCH anchors are below the locator symbols on the seat back.

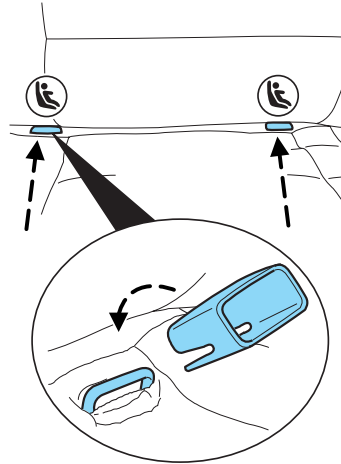

Follow the child seat manufacturer's instructions to properly install a child seat with LATCH attachments. Two plastic LATCH guides can be obtained at no charge from any Ford or Lincoln-Mercury dealer. They snap onto the LATCH lower anchors in the seat to help attach a child seat with rigid attachments. The guides hold the seat trim away to expose the anchor and make it easier to attach some child seats.



Attach LATCH lower attachments of the child seat only to the anchors shown.

If you install a child seat with rigid LATCH attachments, do not tighten the tether strap enough to lift the child seat off the vehicle seat cushion when the child is seated in it. Keep the tether strap just snug without lifting the front of the child seat. Keeping the child seat just touching the vehicle seat gives the best protection in a severe crash.

Each time you use the safety seat, check that the seat is properly attached to the lower anchors and tether anchor. Try to tilt the child seat from side to side. Also try to tug the seat forward. Check to see if the anchors hold the seat in place.





If the safety seat is not anchored properly, the risk of a child being injured in a crash greatly increases.

### STARTING

#### Positions of the ignition

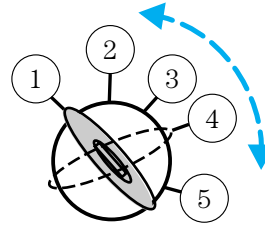
1. LOCK, locks the gearshift lever and allows key removal. (The steering wheel will not lock after key removal.)
2. OFF, shuts off the engine and all accessories without locking the steering wheel. This position also allows the automatic transmission shift lever to be moved from the P (Park) position without the brake pedal being depressed.



 When the key is in the ignition OFF position, the automatic transmission shift lever can be moved from the P (Park) position without the brake pedal depressed. To avoid unwanted vehicle movement, always set the parking brake.

3. ACCESSORY, allows the electrical accessories such as the radio to operate while the engine is not running.
4. RUN, all electrical circuits operational. Warning lights illuminated. Key position when driving.
5. START, cranks the engine. Release the key as soon as the engine starts.

#### Preparing to start your vehicle

Engine starting is controlled by the powertrain control system. This system meets all Canadian Interference-Causing Equipment standard requirements regulating the impulse electrical field strength of radio noise.

When starting a fuel-injected engine, don't press the accelerator before or during starting. Only use the accelerator when you have difficulty starting the engine. For more information on starting the vehicle, refer to *Starting the engine* in this chapter.

 Extended idling at high engine speeds can produce very high temperatures in the engine and exhaust system, creating the risk of fire or other damage.

## Driving

 Do not park, idle, or drive your vehicle in dry grass or other dry ground cover. The emission system heats up the engine compartment and exhaust system, which can start a fire.

 Do not start your vehicle in a closed garage or in other enclosed areas. Exhaust fumes can be toxic. Always open the garage door before you start the engine. See *Guarding against exhaust fumes* in this chapter for more instructions.

 If you smell exhaust fumes inside your vehicle, have your dealer inspect your vehicle immediately. Do not drive if you smell exhaust fumes.

### **Important safety precautions**

When the engine starts, the idle RPM runs faster to warm the engine. If the engine idle speed does not slow down automatically, have the vehicle checked.

Before starting the vehicle:

1. Make sure all occupants buckle their safety belts. For more information on safety belts and their proper usage, refer to the *Seating and safety restraints* chapter.
2. Make sure the headlamps and electrical accessories are off.
  - Make sure the parking brake is set.

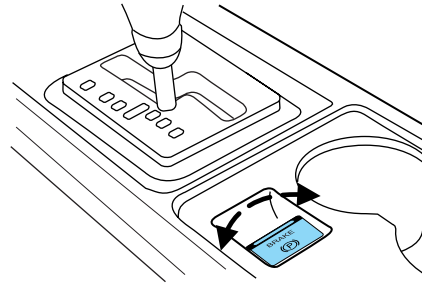

- Make sure the gearshift is in P (Park).

## Driving

- Turn the key to 4 (ON) without turning the key to 5 (START).

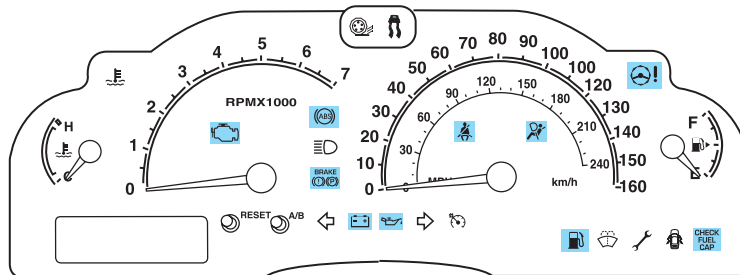
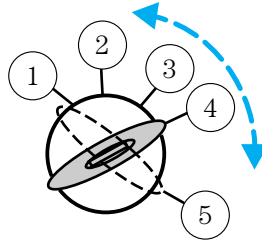

Make sure the corresponding lights illuminate or illuminate briefly. If a light fails to illuminate, have the vehicle serviced.

- If the driver's safety belt is fastened, the  light may not illuminate.

### Starting the engine

1. Turn the key to 4 (ON) without turning the key to 5 (START). If there is difficulty in turning the key, rotate the steering wheel until the key turns freely. This condition may occur when:

- the front wheels are turned
- a front wheel is against the curb

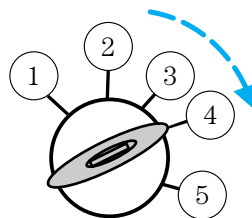

Turn the key to 5 (START), then release the key as soon as the engine starts. Excessive cranking could damage the starter.

**Note:** If the engine does not start within five seconds on the first try, turn the key to 3 (OFF), wait 10 seconds and try again.

### Using the engine block heater (if equipped)

An engine block heater warms the engine coolant which aids in starting and heater/defroster performance. Use of an engine block heater is

## Driving

strongly recommended if you live in a region where temperatures reach  $-23^{\circ}\text{C}$  ( $-10^{\circ}\text{F}$ ) or below. For best results, plug the heater in at least three hours before starting the vehicle. The heater can be plugged in the night before starting the vehicle.



To reduce the risk of electrical shock, do not use your heater with ungrounded electrical systems or two-pronged (cheater) adapters.

### Guarding against exhaust fumes

Carbon monoxide is present in exhaust fumes. Take precautions to avoid its dangerous effects.



If you smell exhaust fumes inside your vehicle, have your dealer inspect your vehicle immediately. Do not drive if you smell exhaust fumes.

### Important ventilating information

If the engine is idling while the vehicle is stopped for a long period of time, open the windows at least 2.5 cm (one inch) or adjust the heating or air conditioning to bring in fresh air.

## BRAKES

Occasional brake noise is normal. If a metal-to-metal, continuous grinding or continuous squeal sound is present, the brake linings may be worn-out and should be inspected by a qualified service technician. If the vehicle has continuous vibration or shudder in the steering wheel while braking, the vehicle should be inspected by a qualified service technician.

### Four-wheel anti-lock brake system (ABS)

Your vehicle is equipped with an Anti-lock Braking System (ABS). This system helps you maintain steering control during emergency stops by keeping the brakes from locking. Noise from the ABS pump motor and brake pedal pulsation may be observed during ABS braking; any pulsations or mechanical noise you may feel or hear is normal.

### **ABS warning lamp**

The lamp in the instrument cluster momentarily illuminates when the ignition is turned to ON. If the light does not illuminate during start up, remains on or flashes, the ABS may be disabled and may need to be serviced.

Even when the ABS is disabled, normal braking is still effective. (If your BRAKE warning lamp illuminates with the parking brake released, have your brake system serviced immediately.)

### BRAKE



#### **Using ABS**

When hard braking is required, apply continuous force on the brake pedal; do not pump the brake pedal since this will reduce the effectiveness of the ABS and will increase your vehicle's stopping distance. The ABS will be activated immediately, allowing you to retain full steering control during hard braking and on slippery surfaces. However, the ABS does not decrease stopping distance.

#### **Parking brake (P)**

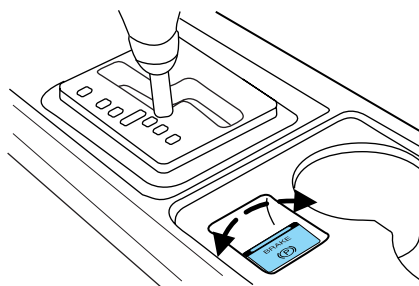

To set the parking brake, pull the lever up. To release the parking brake, make sure the ignition is turned to ON, depress the brake pedal, then gently push the parking brake lever down.

The BRAKE warning lamp will illuminate and will remain illuminated until the parking brake is released.

### BRAKE



The parking brake will automatically disengage when the gearshift lever is moved from P (Park) with the ignition on or if the engine is running. The parking brake will also disengage if a gear is selected and the accelerator pedal is depressed.

If the battery is disconnected (or removed), it will be necessary to reset the parking brake; the message center will display APPLY PARK BRAKE

## Driving

or APPLY ((P)). With the ignition on and the engine not running, depress the brake pedal and apply the parking brake. The brake lamp will illuminate; this is normal and the parking brake is now reset. To release the parking brake, push the lever down with your foot on the brake pedal.

### STEERING

To prevent damage to the power steering system:

- Never hold the steering wheel at its furthest turning points (until it stops) for more than a few seconds when the engine is running.
- Do not operate the vehicle with a low power steering pump fluid level (below the MIN mark on the reservoir).

If the power steering system breaks down (or if the engine is turned off), you can steer the vehicle manually, but it takes more effort.

If the steering wanders or pulls, check for:

- an improperly inflated tire
- uneven tire wear
- loose or worn suspension components
- loose or worn steering components
- improper steering alignment

### Speed sensitive steering

The steering in your vehicle is speed sensitive. At high speeds, steering assist will decrease to improve steering feel. At lower speeds, maneuverability will be increased.

If the amount of effort required to steer your vehicle changes while driving at a constant vehicle speed, have the power steering system checked by your dealer or a qualified service technician.

### TRACTION CONTROL™

Your vehicle may be equipped with a Traction Control™ system. This system helps you maintain the stability and steerability of your vehicle, especially on slippery road surfaces such as snow- or ice-covered roads and gravel roads. The system will allow your vehicle to make better use of available traction in these conditions.

During Traction Control™ operation, the traction control active light will illuminate, you may hear an electric motor type of sound coming from the engine compartment and the engine will not “rev-up” when you push further on the accelerator. This is normal system behavior and should be no reason for concern.

The Traction Control<sup>™</sup> switch, located on the center console by the gearshift lever, has an indicator light that illuminates when the system is off. The Traction Control<sup>™</sup> system will automatically turn on every time the ignition is turned off and on.

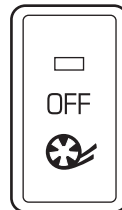

If you should become stuck in snow or ice or on a very slippery road surface, try switching the Traction Control<sup>™</sup> system off. This may allow excess wheel spin to “dig” the vehicle out and enable a successful “rocking” maneuver.

If a system fault is detected, the traction control switch’s OFF indicator will illuminate and your vehicle should be serviced.

### **AdvanceTrac<sup>™</sup> Stability Enhancement System (if equipped)**

The AdvanceTrac<sup>™</sup> system provides a stability enhancement feature as well as a traction enhancement feature. It helps your vehicle maintain traction, when driving on slippery and/or hilly road surfaces, by detecting and controlling wheel spin. Excessive wheel spin is controlled by momentarily reducing engine power and rapidly applying the anti-lock brakes. The system is a driver aid which makes your vehicle easier to handle primarily on snow and ice-covered roads.

If your vehicle should become stuck in deep snow or mud, try switching the AdvanceTrac<sup>™</sup> system off by pressing the AdvanceTrac<sup>™</sup> button. This will allow your tires to “dig” for traction.

If the AdvanceTrac<sup>™</sup> system is activated excessively in a short period of time, the brake portion of the system will shut down to allow the brakes to cool down. A limited AdvanceTrac<sup>™</sup> function using only engine power reduction will still help control the wheels from over-spinning. When the brakes have cooled down, the system will again function normally. Anti-lock braking is not affected by this condition and will function normally during the cool-down period.

AdvanceTrac<sup>™</sup> enhances your vehicle’s stability during maneuvers that require all available tire traction, like in wet/snowy/icy road conditions and/or when performing emergency maneuvers. In an emergency lane-change, the driver will experience better overall vehicle traction, and have better control of the vehicle.

The AdvanceTrac<sup>™</sup> system helps the driver maintain steering control if the vehicle begins to slide excessively left or right or spin out.

## Driving

AdvanceTrac™ will attempt to correct the sliding motion by applying brake force at individual tires and, if necessary, by reducing engine power.

Driving conditions which may activate AdvanceTrac™ include:

- Taking a turn too fast
- Maneuvering quickly to avoid an accident, pedestrian or obstacle
- Hitting a patch of ice
- Changing lanes on a snow-rutted road
- Entering a snow-free road from a snow-covered side street, or vice versa
- Entering a paved road from a gravel road, or vice versa
- Hitting a curb while turning
- Driving on slick surfaces
- Cornering while towing a heavily loaded trailer (refer to *Trailer Towing* in this chapter)

The AdvanceTrac™ system automatically turns on when the engine is started. However, the system does not function when the vehicle is traveling in R (Reverse); the ABS and traction enhancement features will continue to function.

The AdvanceTrac™ button allows the driver to control the availability of the AdvanceTrac™ system. AdvanceTrac™ system status is indicated by a warning indicator light with a “sliding car” icon in the instrument cluster that will flash when the system is active and an indicator light in the control button that will illuminate when the system is turned off. In vehicles with a

message center, the message “ADVANCETRAC OFF” will be displayed.

If a failure is detected in the AdvanceTrac™ system, the warning indicator light in the instrument cluster will stay on. If the warning indicator light in the instrument cluster remains on while the engine is running, have the system serviced immediately.

Pressing the control once will disable the AdvanceTrac™ stability enhancement and the engine power reduction portion of the traction

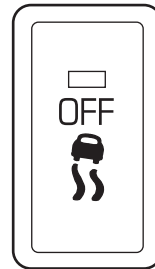

## Driving

enhancement feature; the brake portion of the traction enhancement feature will still function normally. Pressing and holding the control for more than five seconds will disable the AdvanceTrac™ stability enhancement **and** traction enhancement feature. If the vehicle is stuck in snow or mud or when driving in deep sand, switching off the AdvanceTrac™ system may be beneficial so the wheels are allowed to spin. If your vehicle seems to lose engine power while driving in deep sand or very deep snow, switching off the AdvanceTrac™ stability enhancement feature will restore full engine power and will enhance momentum through the obstacle.

Some drivers may notice a slight movement of the brake pedal when the AdvanceTrac™ performs a system self-check. During AdvanceTrac™ operation you may experience the following:

- A rumble or grinding noise
- A slight deceleration of the vehicle
- The AdvanceTrac™ indicator light will flash
- If your foot is on the brake pedal, you will feel a vibration in the pedal.
- If the driving condition is severe and your foot is not on the brake, the brake pedal will move to apply higher brake forces. You may also hear a whoosh of air from under the instrument panel during this severe condition.

All these conditions are normal during AdvanceTrac™ operation.

**Do not alter or modify your vehicle's wheel/tire size, suspension or steering; the resulting changes to the vehicle's handling can adversely affect the AdvanceTrac™ system.**

**Modification/Addition of supplemental radio components, such as a subwoofer, may adversely affect the performance of the AdvanceTrac™ system.**



Aggressive driving in any road conditions can cause you to lose control of your vehicle increasing the risk of severe personal injury or property damage. The occurrence of an AdvanceTrac™ event is an indication that at least some of the tires have exceeded their ability to grip the road; this may lead to an increased risk of loss of vehicle control, vehicle rollover, personal injury and death. If you experience a severe road event, SLOW DOWN.

## Driving

### AUTOMATIC TRANSMISSION OPERATION

#### Brake-shift interlock

This vehicle is equipped with a brake-shift interlock feature that prevents the gearshift lever from being moved from P (Park) when the ignition is in the RUN position unless brake pedal is depressed.

If you cannot move the gearshift lever out of P (Park) with ignition in the RUN position and the brake pedal depressed:

1. Apply the parking brake, turn ignition key to LOCK, then remove the key.
2. Insert the key and turn it to OFF. **Apply the brake pedal and shift to N (Neutral).**



When the key is in the ignition OFF position, the automatic transmission shift lever can be moved from the P (Park) position without the brake pedal depressed. To avoid unwanted vehicle movement, always set the parking brake.

3. Start the vehicle.

If it is necessary to use the above procedure to move the gearshift lever, it is possible that a fuse has blown or the vehicle's brakelamps are not operating properly. Refer to *Fuses and relays* in the *Roadside emergencies* chapter.



Do not drive your vehicle until you verify that the brakelamps are working.



Always set the parking brake fully and make sure the gearshift is latched in P (Park). Turn the ignition to the LOCK position and remove the key whenever you leave your vehicle.



If the parking brake is fully released, but the brake warning lamp remains illuminated, the brakes may not be working properly. See your dealer or a qualified service technician.

### Driving with a 5-speed automatic transmission

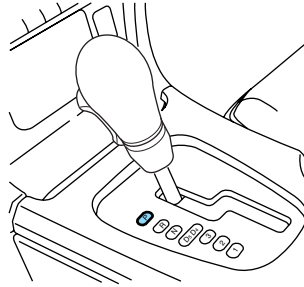

Your transmission is equipped with an adaptive learning strategy found in the vehicle computer. This feature is designed to increase durability, and provide consistent shift feel over the life of the vehicle. A new vehicle or transmission may have firm and/or soft shifts. This operation is considered normal and will not affect function or durability of the transmission. Over time, the adaptive learning process will fully update transmission operation. Additionally, whenever the battery is disconnected or a new battery installed, the strategy must be relearned.

#### **P (Park)**

This position locks the transmission and prevents the rear wheels from turning.

To put your vehicle in gear:

- Start the engine
- Depress the brake pedal
- Move the gearshift lever into the desired gear

To put your vehicle in P (Park):

- Come to a complete stop
- Move the gearshift lever and securely latch it in P (Park)



Always set the parking brake fully and make sure the gearshift is latched in P (Park). Turn the ignition to the LOCK position and remove the key whenever you leave your vehicle.

#### **R (Reverse)**

With the gearshift lever in R (Reverse), the vehicle will move backward. Always come to a complete stop before shifting into and out of R (Reverse).

## Driving

### **N (Neutral)**

With the gearshift lever in N (Neutral), the vehicle can be started and is free to roll. Hold the brake pedal down while in this position.

### **Drive 5 (Overdrive)**

The normal driving position for the best fuel economy. Transmission operates in gears one through five.

### **Drive 4 (Overdrive cancelled)**

Activated when the transmission shift lever is moved to the D4 position.

- This position allows for all forward gears 1–4, except overdrive.
- Provides engine braking.
- Use when driving conditions cause excessive shifting from O/D to other gears. Examples: city traffic, hilly terrain, heavy loads, trailer towing and when engine braking is required.
- To return to D5 (overdrive mode), move the transmission shift lever into the D5 position.
- Select D4 at higher speeds will cause the transmission to downshift into fourth gear.

### **3 (Third)**

This position allows for third gear only.

- Provides engine braking.
- To return to D5 or D4, move the transmission shift lever into the D5 or D4 position.
- Selecting 3 (Third) at higher speeds will cause the transmission to downshift to third gear at the appropriate vehicle speed.

### **2 (Second)**

This position allows for second gear only.

- Provides engine braking.
- Use to start-up on slippery roads.
- To return to D5 or D4, move the transmission shift lever into the D5, D4 or 3 (Third) position.
- Selecting 2 (Second) at higher speeds will cause the transmission to downshift to second gear at the appropriate vehicle speed.

### **1 (First)**

- Provides maximum engine braking.
- Allows upshifts by moving shift lever.
- Will not downshift into first gear at high speeds; will cause the transmission to downshift to a lower gear, then allows for first gear when the vehicle reaches slower speeds.

### **Forced downshifts**

- Allowed in Overdrive or Drive.
- Depress the accelerator to the floor.
- Allows transmission to select an appropriate gear.

### ***Driving with a 5-speed automatic transmission with the Select Shift Transmission (SST) shifter (if equipped)***

#### ***Understanding gearshift positions***

The Select Shift Transmission (SST) shifter allows the driver to select between the transmission's automatic shift mode or the manually selected shift mode.

#### ***Automatic shift mode***

Operates like a normal automatic transmission for P (Park), R (Reverse), N (Neutral), D5 and D4.

Refer to *Driving with a 5-speed automatic transmission* in this chapter for P (Park), R (Reverse), N (Neutral), D5 and D4 information.

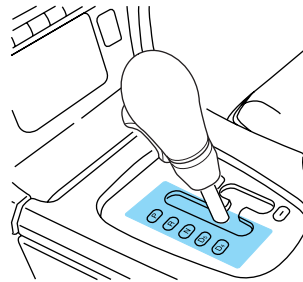

## Driving

### **Manual shift mode**

With the gearshift lever in D5 (Overdrive), the gearshift lever can be moved to the right and into the manual shift mode. The transmission will remain in the manual shift mode until the gearshift lever is moved back to D5 (Overdrive).

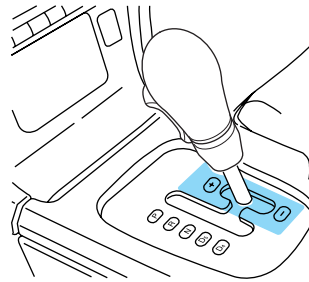

### **+ and - position operation**

These positions allow the driver to manually select the appropriate upshift (+) or downshift (-) and gear range.

- Can only be entered from the D5 position.
- Gear ranges 1–5 provide the same function and ratio as found in the D5 or D4 automatic mode positions.
- Transmission will not upshift or downshift unless the selector lever is moved forward or rearward.
- One tap forward (+) will **command** the transmission to upshift one gear range.
- One tap rearward (-) will **command** the transmission to downshift one gear range.
- Upshifts are allowed at any vehicle speed, with the exception of 4th and 5th gear. The transmission will not do a 4th or 5th gear start. Ensure that the transmission is returned to 1st gear once the vehicle is stopped. If this is not done, and the transmission is in 2nd or 3rd gear, the vehicle will remain in that gear. However, if the transmission is in 4th or 5th gear, the transmission will automatically return to 1st gear.
- When downshifting at normal road speeds, the transmission will only allow a downshift into the **next lower** gear.

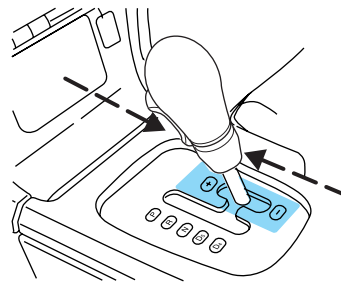

## Driving

- If shifter (-) is tapped more than once in rapid succession, the transmission will downshift only into the next lower gear, then when the vehicle reaches a speed below a calibrated entry speed, the transmission will allow a downshift into the next lower gear if again selected by the driver. This is to prevent engine and transmission damage and to keep the engine and transmission within allowable RPM ranges.
- An electronic indicator on the instrument cluster will display the selected gear.

### **Recommended shift speeds**

Upshift according to the following chart:

<b>Recommended upshift schedule</b>	
Shift from:	
1 - 2	24 km/h (15 mph)
2 - 3	40 km/h (25 mph)
3 - 4	64 km/h (40 mph)
4 - 5	72 km/h (45 mph)

### ***If your vehicle gets stuck in mud or snow***

If your vehicle gets stuck in mud or snow, it may be rocked out by shifting from forward and reverse gears, stopping between shifts in a steady pattern. Press lightly on the accelerator in each gear.

**Do not rock the vehicle if the engine is not at normal operating temperature or damage to the transmission may occur.**

**Do not rock the vehicle for more than a minute or damage to the transmission and tires may occur, or the engine may overheat.**

### **REAR PARK ASSIST**

The rear park assist system sounds a tone to warn the driver of obstacles near the rear bumper when the R (Reverse) gear is selected.



To help avoid personal injury, please read and understand the limitations of the rear park assist system as contained in this section. The park assist is only an aid for some (generally large and fixed) objects when moving in reverse on a flat surface at “parking speeds”. Inclement weather may also affect the function of the system; this may include reduced performance or a false activation.

## Driving



To help avoid personal injury, always use caution when in R (Reverse) and when using the rear park assist.



This system is not designed to prevent contact with small or moving objects. The system is designed to provide a warning to assist the driver in detecting objects to avoid damaging the vehicle. The system may not detect smaller objects, particularly those close to the ground.

The system will assist the driver in detecting certain objects while the vehicle slowly moves in reverse at speeds less than 10 km/h (6 mph). The system is not effective at speeds greater than 10 km/h (6 mph) and may not detect certain angular or moving objects.

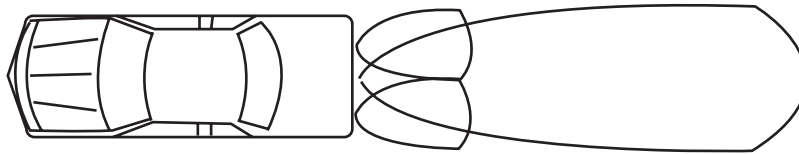

The system detects obstacles within approximately five meters (16.4 ft.) behind the rear bumper with a decreased coverage area at the outer corners of the bumper. In the figure, the smaller objects behind the vehicle represent the near-vehicle and bumper corner coverage area of the park aid system and the large object represents the extended coverage area. As you move closer to the obstacle, the rate of the tone increases. When the distance to the obstacle is less than 45.0 cm (18 in.), the tone will sound continuously. If the system detects an object that is approaching the vehicle at such as rate that rapid braking is required, a very high rate tone will sound. If this tone is heard while reversing, the driver is advised to slow down immediately until the tone either changes to a slower rate or stops.

## Driving

The rear park assist is automatically enabled when the gear selector is placed in R (Reverse) and the ignition is ON. A park assist control allows the driver to disable the system only when the ignition is ON, and the gear selector is in R (Reverse).

The OFF indicator remains illuminated when the system is disabled. The system defaults to ON every time the R (Reverse) gear is selected. Press the control to disable or enable the system.

The indicator will remain illuminated to indicate a failure of the rear park assist.

**Always keep the sensors (located on the rear bumper/fascia) free from snow, ice and large accumulations of dirt (do not clean the sensors with sharp objects). These elements may cause the system to operate inaccurately.**

**If the vehicle sustains damage to the rear bumper/fascia, leaving it misaligned or bent, the sensing zone may be altered causing inaccurate measurement of obstacles or false alarms.**

### DRIVING THROUGH WATER

If driving through deep or standing water is unavoidable, proceed very slowly especially if the depth is not known. Never drive through water that is higher than the bottom of the hubs (for trucks) or the bottom of the wheel rims (for cars). Traction or brake capability may be limited and your vehicle may stall. Water may also enter your engine's air intake and severely damage your engine.

Once through the water, always dry the brakes by moving your vehicle slowly while applying light pressure on the brake pedal. Wet brakes do not stop the vehicle as quickly as dry brakes. **Driving through deep water where the transmission vent tube is submerged may allow water into the transmission and cause internal transmission damage.**

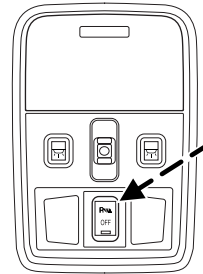

## Driving

### VEHICLE LOADING

Before loading a vehicle, familiarize yourself with the following terms:

- **Base Curb Weight:** Weight of the vehicle including any standard equipment, fluids, lubricants, etc. It does not include occupants or aftermarket equipment.
- **Payload:** Combined maximum allowable weight of cargo, occupants and optional equipment. The payload equals the gross vehicle weight rating minus base curb weight.
- **GVW (Gross Vehicle Weight):** Base curb weight plus payload weight.
- **GVWR (Gross Vehicle Weight Rating):** Maximum allowable total weight of the base vehicle, occupants, optional equipment and cargo. The GVWR is specific to each vehicle and is listed on the Safety Certification Label on the driver's door pillar.
- **GAWR (Gross Axle Weight Rating):** Carrying capacity for each axle system. The GAWR is specific to each vehicle and is listed on the Safety Certification Label on the driver's door pillar.

The Safety Certification Label, located on the driver's door pillar, lists vehicle weight rating limitations. Before adding any additional equipment, refer to these limitations.

Always ensure that the weight of occupants, cargo and equipment is within the weight limitations, including both gross vehicle weight and front and rear gross axle weight rating limits.

**Note:** Do not exceed the GVWR or the GAWR specified on the certification label.



Exceeding any vehicle weight rating limitation could result in serious damage to the vehicle, loss of vehicle control, vehicle rollover, and/or personal injury.

Do not use replacement tires with lower load carrying capacities than the originals because they may lower the vehicle's GVWR and GAWR limitations. Replacement tires with a higher limit than the originals do not increase the GVWR and GAWR limitations.

### TRAILER TOWING

Your vehicle is not equipped to tow. No towing packages are available through Ford or Lincoln/Mercury dealers.

### **RECREATIONAL TOWING (ALL WHEELS ON THE GROUND)**

Follow these guidelines for your specific powertrain combination to tow your vehicle with all four wheels on the ground (such as behind a recreational vehicle).

These guidelines are designed to ensure that your transmission is not damaged due to insufficient lubrication.

#### **All Rear Wheel Drive (RWD) vehicles:**

This applies to all cars and 4x2 trucks/sport utilities with rear wheel drive capability.

- Place the transmission in N (Neutral)
- Maximum speed is 56 km/h (35 mph)
- Maximum distance is 80 km (50 miles)

If a distance of 80 km (50 miles) or a speed of 56 km/h (35 mph) must be exceeded, you must disconnect the driveshaft.

**Ford recommends the driveshaft be removed/installed only by a qualified technician. Improper removal/installation of the driveshaft may cause damage to the driveshaft and internal transmission components.** See your local dealer for driveshaft removal/installation.

## Roadside Emergencies

### GETTING ROADSIDE ASSISTANCE

To fully assist you should you have a vehicle concern, Ford Motor Company offers a complimentary roadside assistance program. This program is separate from the New Vehicle Limited Warranty. The service is available:

- 24-hours, seven days a week
- for the New Vehicle Limited Warranty period of three years or 60,000 km (36,000 miles), whichever occurs first on Ford and Mercury vehicles, and four years or 80,000 km (50,000 miles) on Lincoln vehicles.

Roadside assistance will cover:

- changing a flat tire
- jump-starts
- lock-out assistance
- limited fuel delivery
- towing of your disabled vehicle to the nearest Ford Motor Company dealership, or your selling dealer if within 56.3 km (35 miles) of the nearest Ford Motor Company dealership (one tow per disablement). Even non-warranty related tows, like accidents or getting stuck in the mud or snow, are covered (some exclusions apply, such as impound towing or repossession).

### Canadian customers refer to your Owner Information Guide for information on:

- coverage period
- exact fuel amounts
- towing of your disabled vehicle
- emergency travel expense reimbursement
- travel planning benefits

### USING ROADSIDE ASSISTANCE

Complete the roadside assistance identification card and place it in your wallet for quick reference. In the United States, this card is found in the Owner Guide portfolio in the glove compartment in Ford vehicles and is mailed to you if you own a Mercury or Lincoln. In Canada, the card is found in the Owner Information Guide in the glove compartment.

U.S. Ford or Mercury vehicle customers who require roadside assistance, call 1-800-241-3673; Lincoln vehicle customers call 1-800-521-4140.

## Roadside Emergencies

Canadian customers who require roadside assistance, call 1-800-665-2006.

If you need to arrange roadside assistance for yourself, Ford Motor Company will reimburse a reasonable amount. To obtain reimbursement information, U.S. Ford or Mercury vehicles customers call 1-800-241-3673; Lincoln vehicle customers call 1-800-521-4140.

Canadian customers who need to obtain reimbursement information, call 1-800-665-2006.

### ROADSIDE COVERAGE BEYOND BASIC WARRANTY

In the United States, you may purchase additional roadside assistance coverage beyond this period through the Ford Auto Club by contacting your Ford or Lincoln Mercury dealer.

Similarly in Canada, for uninterrupted Roadside Assistance coverage, you may purchase extended coverage prior to your Basic Warranty's Roadside Assistance expiring. For more information and enrollment, contact 1-877-294-2582 or visit our website at [www.ford.ca](http://www.ford.ca).

### HAZARD FLASHER

The hazard flasher is located on the steering column, just behind the steering wheel. The hazard flashers will operate when the ignition is in any position.

Push in the flasher control and all front and rear direction signals will flash. Press the flasher control again to turn them off. Use it when your vehicle is disabled and is creating a safety hazard for other motorists.

**Note:** With extended use, the flasher may run down your battery.

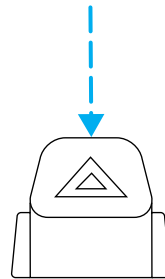

## Roadside Emergencies

### FUEL PUMP SHUT-OFF SWITCH FUEL RESET

This device stops the electric fuel pump from sending fuel to the engine when your vehicle has had a substantial jolt.

After an accident, if the engine cranks but does not start, this switch may have been activated.

This switch is located in the driver's footwell, behind the kick panel.

To reset the switch:

1. Turn the ignition OFF.
2. Check the fuel system for leaks.
3. If no leaks are apparent, reset the switch by pushing in on the reset button.
4. Turn the ignition ON.
5. Wait a few seconds and return the key to OFF.
6. Make another check for leaks.

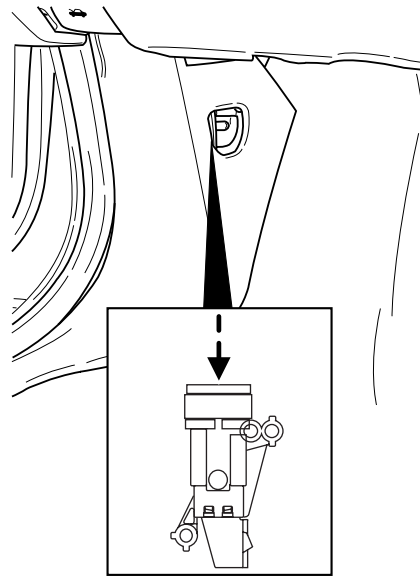

### FUSES AND RELAYS

#### Fuses

If electrical components in the vehicle are not working, a fuse may have blown. Blown fuses are identified by a broken wire within the fuse. Check the appropriate fuses before replacing any electrical components.

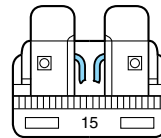

**Note:** Always replace a fuse with one that has the specified amperage rating. Using a fuse with a higher amperage rating can cause severe wire damage and could start a fire.

## Roadside Emergencies

### *Standard fuse amperage rating and color*

COLOR					
Fuse rating	Mini fuses	Standard fuses	Maxi fuses	Cartridge maxi fuses	Fuse link cartridge
2A	Grey	Grey	—	—	—
3A	Violet	Violet	—	—	—
4A	Pink	Pink	—	—	—
5A	Tan	Tan	—	—	—
7.5A	Brown	Brown	—	—	—
10A	Red	Red	—	—	—
15A	Blue	Blue	—	—	—
20A	Yellow	Yellow	Yellow	Blue	Blue
25A	Natural	Natural	—	—	—
30A	Green	Green	Green	Pink	Pink
40A	—	—	Orange	Green	Green
50A	—	—	Red	Red	Red
60A	—	—	Blue	—	Yellow
70A	—	—	Tan	—	Brown
80A	—	—	Natural	—	Black

### **Passenger compartment fuse panel**

The fuse panel is located on the right-hand side kick panel. Remove the panel cover to access the fuses.

To remove a fuse use the fuse puller tool provided on the fuse panel cover.

## Roadside Emergencies

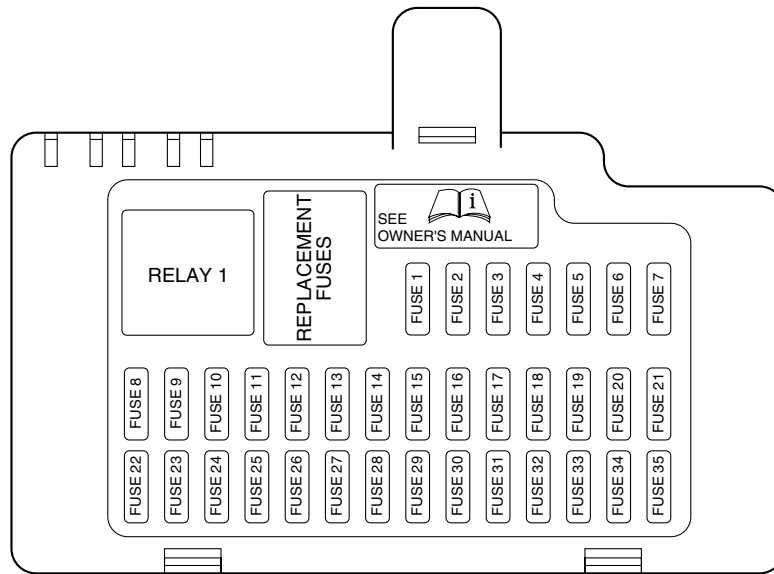

The fuses are coded as follows.

Fuse/Relay Location	Fuse Amp Rating	Passenger Compartment Fuse Panel Description
1	5A	Starter relay coil
2	5A	Radio
3	5A	ABS/TCS/AdvanceTrac™
4	5A	Cluster, Powertrain Control Module (PCM) relay, Fuel pump relay, REM, Transit relay
5	10A	Restraints Control Module (RCM), Passenger Occupant Detection System (PODS) electronic control unit
6	10A	OBD II

## Roadside Emergencies

Fuse/Relay Location	Fuse Amp Rating	Passenger Compartment Fuse Panel Description
7	5A	DDM, DSM, Anti-theft LED, Power mirror switch, Electric Park Brake (EPB) switch
8	5A	Right front turn, Right front repeater, Right front sidemarker, Right front park lamps
9	15A	Right front low beam/HID
10	5A	Left front turn, Left front repeater, Left front sidemarker, Left front park lamps
11	10A	Left front high beam
12	5A	Rain sensor, Electrochromic mirror
13	5A	Cluster
14	5A	DATC
15	5A	O/D cancel, ABS/Traction-Assist switch
16	5A	Heated seat controls, Climate control seat module
17	5A	RCM, Alternator warning lamp
18	20A	Radio, CIA, Navigation unit
19	15A	Tilt/Tele motors
20	10A	FEM, DATC, Cluster, REM
21	7.5A	Not used (spare)
22	10A	DDM, Driver door mirror
23	10A	Right front high beam
24	5A	PATS
25	15A	Left front low beam/HID
26	5A	Wiper module
27	10A	Radio, Navigation unit
28	5A	Not Used (spare)
29	5A	FEM, Reverse park assist

## Roadside Emergencies

Fuse/Relay Location	Fuse Amp Rating	Passenger Compartment Fuse Panel Description
30	5A	FEM, Passenger power mirror
31	—	Not used
32	20A	Cigar lighter
33	10A	Switch backlighting, FEM
34	10A	Not used (spare)
35	5A	Stop lamp signal

### Front power distribution box

The front power distribution box is located in the engine compartment. The power distribution box contains high-current fuses that protect your vehicle's main electrical systems from overloads.

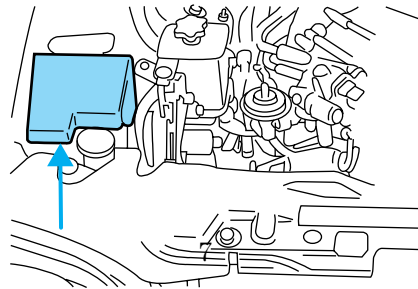

Always disconnect the battery before servicing high current fuses.



To reduce risk of electrical shock, always replace the cover to the Power Distribution Box before reconnecting the battery or refilling fluid reservoirs.

If the battery has been disconnected and reconnected, refer to the *Battery* section of the *Maintenance and specifications* chapter.

## Roadside Emergencies

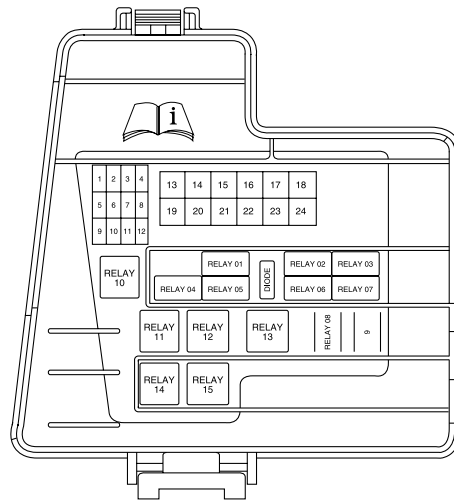

The high-current fuses are coded as follows.

Fuse/Relay Location	Fuse Amp Rating	Power Distribution Box Description
1	10A*	A/C clutch, Coolant control valve, Auxiliary coolant pump
2	—	Not used
3	15A*	Fog lamp
4	20A*	Horn
5	15A*	Fuel injectors, Electric cooling fan, Mass Air Flow (MAF) sensor
6	15A*	Transmission solenoid, EGR
7	—	Not used
8	—	Not used
9	—	Not used
10	—	Not used
11	15A*	HEGOs
12	15A*	Coil-on-plug

## Roadside Emergencies

Fuse/Relay Location	Fuse Amp Rating	Power Distribution Box Description
13	30A**	Heated wiper park
14	30A**	ABS module
15	—	Not used
16	30A**	Blower motor
17	—	Not used
18	—	Not used
19	30A**	Electric park brake
20	30A**	Wiper motor
21	30A**	Starter solenoid
22	40A**	ABS motor
23	—	Not used
24	—	Not used
Relay 01	—	Not used
Relay 02	—	Not used
Relay 03	—	Coil-on-plug and HEGOs
Relay 04	—	Right-hand HID headlamps
Relay 05	—	Auxiliary coolant pump (V8 engines)
Relay 06	—	Left-hand HID headlamps
Relay 07	—	Fog lamps
Relay 08	—	A/C clutch
Fuse 09	—	Not used
Relay 10	—	Blower motor
Relay 11	—	Not used
Relay 12	—	Heated wiper park
Relay 13	—	Horn
Relay 14	—	PCM power
Relay 15	—	Starter motor
Diode	—	PCM

\*Mini fuses \*\*Cartridge fuses

## Roadside Emergencies

### ***In-line fuse for electric cooling fan***

There is a 60A maxi fuse for the electric cooling fan located in a wiring harness behind the front passenger side trim panel under the dash panel. The trim panel must be removed and the carpet on the front passenger side must be lifted to access this fuse. See a qualified technician to have this fuse replaced, if necessary.

### **Rear power distribution box**

The rear power distribution box is located in the luggage compartment under the spare tire well cover. The power distribution box contains high-current fuses that protect your vehicle's main electrical systems from overloads.

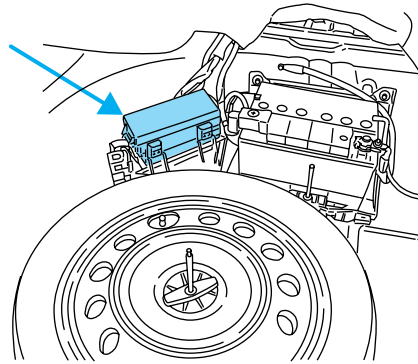

Always disconnect the battery before servicing high current fuses.



To reduce risk of electrical shock, always replace the cover to the Power Distribution Box before reconnecting the battery or refilling fluid reservoirs.

If the battery has been disconnected and reconnected, refer to the *Battery* section of the *Maintenance and specifications* chapter.

## Roadside Emergencies

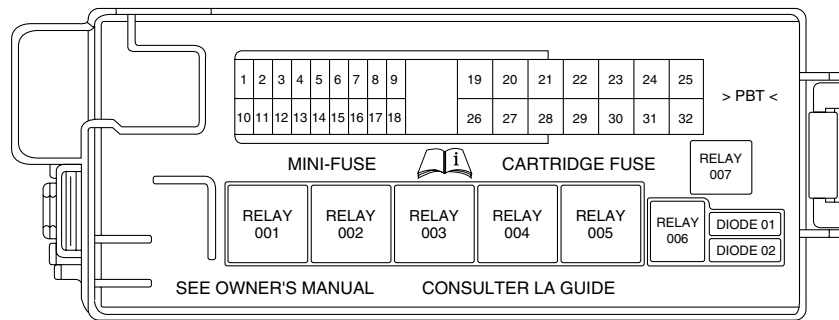

The high-current fuses are coded as follows.

Fuse/Relay Location	Fuse Amp Rating	Power Distribution Box Description
1	15A*	Decklid release solenoid, Passenger door lock motors, Steering column lock
2	10A*	Right rear turn lamp, License plate lamp
3	5A*	Left rear stop/tail lamp
4	10A*	Fuel door release solenoid, Decklid lamp
5	10A*	Courtesy and map lamps, Radio antenna module
6	10A*	Left rear turn and back-up lamps
7	5A*	Right rear stop/tail lamp
8	5A*	Center high-mounted stop lamp
9	5A*	Heated mirror
10	20A*	Power point - console
11	20A*	Rear heated seats
12	20A*	Power point - ashtray
13	—	Not used
14	10A*	Navigation unit
15	5A*	Alternator sense

## Roadside Emergencies

Fuse/Relay Location	Fuse Amp Rating	Power Distribution Box Description
16	20A*	Moonroof
17	15A*	Fuel pump motor
18	20A*	Navigation amp, Subwoofer
19	20A**	REM - Left rear window
20	30A**	Front window motors
21	20A**	Driver lumbar, Power seats
22	20A**	Ignition switch
23	30A**	SSP4
24	30A**	SSP3
25	40A**	P-J/B
26	30A**	Climate control seat module
27	30A**	SSP1
28	20A**	Passenger lumbar, Power seats
29	40A**	Rear defroster
30	20A**	REM - Right rear window
31	30A**	Powertrain main power
32	30A**	SSP2
Relay 001	—	SSP1
Relay 002	—	SSP4
Relay 003	—	Rear defroster
Relay 004	—	SSP3
Relay 005	—	SSP2
Relay 006	—	Not used
Relay 007	—	Fuel pump motor
Diode 01	—	Not used
Diode 02	—	Fuel pump motor
*Mini fuses **Maxi fuses		

### CHANGING THE TIRES

If you get a flat tire while driving, do not apply the brake heavily. Instead, gradually decrease your speed. Hold the steering wheel firmly and slowly move to a safe place on the side of the road.

## Roadside Emergencies



The use of tire sealants is not recommended and may compromise the integrity of your tires.

### Temporary spare tire information

Your vehicle may have a temporary or full-size spare tire. The temporary spare tire for your vehicle is labeled as such. It is smaller than a regular tire and is designed for emergency use only. Drive cautiously and replace the temporary spare tire as soon as possible.



If you use the temporary spare tire continuously or do not follow these precautions, the tire could fail, causing you to lose control of the vehicle, possibly injuring yourself or others.

When driving with the temporary spare tire **do not:**

- exceed 80 km/h (50 mph)
- load the vehicle beyond maximum vehicle load rating listed on the Safety Compliance Label
- tow a trailer
- use tire chains
- drive through an automatic car wash, because of the vehicle's reduced ground clearance
- try to repair the temporary spare tire or remove it from its wheel
- drive for long distances when the temporary-use spare is on
- use the wheel for any other type of vehicle
- use more than one temporary spare tire at a time

Use of a temporary spare tire at any one wheel location can lead to impairment of the following:

- Handling, stability and braking performance
- Comfort and noise
- Ground clearance and parking at curbs
- Winter driving capability

## Roadside Emergencies

### Tire change procedure

 To prevent the vehicle from moving when you change a tire, be sure the parking brake is set, then block (in both directions) the wheel that is diagonally opposite (other side and end of the vehicle) to the tire being changed.

 If the vehicle slips off the jack, you or someone else could be seriously injured.

1. Park on a level surface, activate hazard flashers and set parking brake.
2. Place gearshift lever in P (Park) , turn engine OFF, and block the diagonally opposite wheel.
3. Lift the trunk cargo cover and remove the spare tire, jack and lug wrench. (On V8 Sport models, the lug nut wrench is attached to the jack assembly. To use the wrench, remove it from the jack and extend the shaft.)

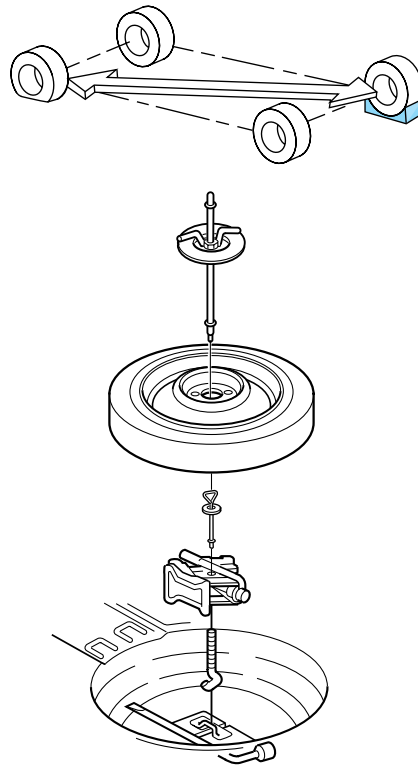

## Roadside Emergencies

4. Loosen each wheel lug nut one-half turn counterclockwise but do not remove them until the wheel is raised off the ground.

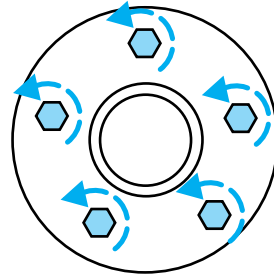

5. Put the jack in the jack notch next to the tire you are changing. Turn the jack handle clockwise until the wheel is completely off the ground.

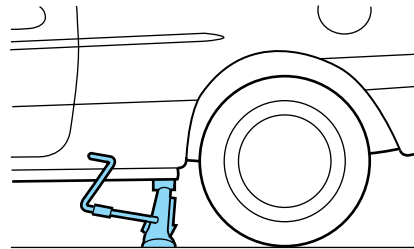

**Never use the rear differential as a jacking point.**

 To lessen the risk of personal injury, do not put any part of your body under the vehicle while changing a tire. Do not start the engine when your vehicle is on the jack. The jack is only meant for changing the tire.

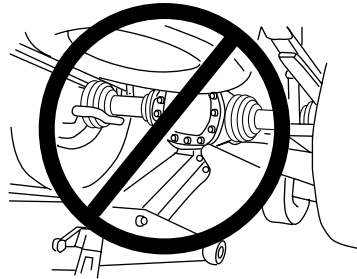

6. Remove the lug nuts with the lug wrench.

7. Replace the flat tire with the spare tire, making sure the valve stem is facing outward. Reinstall lug nuts until the wheel is snug against the hub. Do not fully tighten the lug nuts until the wheel has been lowered.

If you are using the temporary tire, the lug nut washers will not appear to be flush with the rim. This is normal only when using the temporary spare tire.

8. Lower the wheel by turning the jack handle counterclockwise.

## Roadside Emergencies

9. Remove the jack and fully tighten the lug nuts in the order shown.

10. Put flat tire, jack and lug wrench away. Make sure jack is fastened so it does not rattle when you drive.

11. Unblock the wheels.

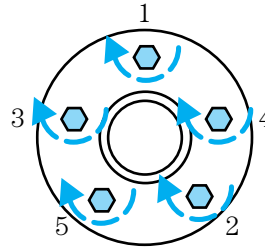

### Anti-theft lug nuts (if equipped)

If your vehicle is equipped with this feature, one of the lug nuts on each wheel must be removed and replaced with a special key. The key and registration card are attached to the lug wrench and stored with the spare tire. If you lose the key, send the registration card to the manufacturer (not the dealer) to get a replacement key. If the lug wrench/lug nut key assembly is lost, see your nearest Ford or Lincoln Mercury dealer who has access to the master set of keys. **Do not use an impact wrench with the anti-theft key.**

To remove the anti-theft lug nut:

1. Insert the key over the locking lug nut. Make sure you hold the key square to the lug nut. If you hold the key at an angle, you could damage the key and the lug nut.

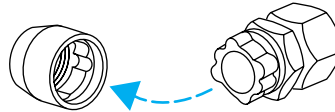

2. Place the lug nut wrench over the lug nut key and apply pressure on the key with the wrench.

3. Turn the wrench in a counterclockwise direction to remove the lug nut.

To install the anti-theft lug nut:

1. Insert the key over the locking lug nut.

2. Place the lug nut wrench over the lug nut key and apply pressure on the key with the wrench.

3. Install the lug nut by turning the wrench clockwise.

## Roadside Emergencies

### JUMP STARTING YOUR VEHICLE



The gases around the battery can explode if exposed to flames, sparks, or lit cigarettes. An explosion could result in injury or vehicle damage.



Batteries contain sulfuric acid which can burn skin, eyes and clothing, if contacted.

**Do not attempt to push-start your vehicle. Automatic transmissions do not have push-start capability; also, the catalytic converter may become damaged.**

In the event of battery failure, you can open the trunk by using your master key on the key cylinder **located behind the driver's seat.**

### Preparing your vehicle

Your battery is located in the trunk of your vehicle.

When the battery is disconnected or a new battery is installed, the transmission must relearn its shift strategy. As a result, the transmission may have firm and/or soft shifts. This operation is considered normal and will not affect function or durability of the transmission. Over time, the adaptive learning process will fully update transmission operation.

1. **Use only a 12-volt supply to start your vehicle.**
2. Do not disconnect the battery of your disabled vehicle as this could damage the vehicle's electrical system. Keep the battery vent hose attached at all times.
3. Park the booster vehicle close to the trunk of your disabled vehicle making sure the two vehicles **do not** touch. Set the parking brake on both vehicles and stay clear of the engine cooling fan and other moving parts.
4. Check all battery terminals and remove any excessive corrosion before you attach the battery cables. Ensure the vent caps are tight and level.
5. Turn the heater fan on in both vehicles to protect any electrical surges. Turn all other accessories off.

## Roadside Emergencies

### Connecting the jumper cables

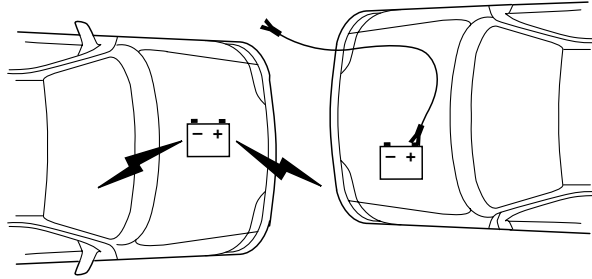

1. Connect the positive (+) jumper cable to the positive (+) terminal of the discharged battery.

**Note:** In the illustrations, *lightning bolts* are used to designate the assisting (boosting) battery.

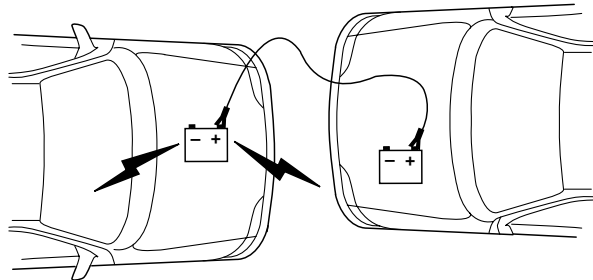

2. Connect the other end of the positive (+) cable to the positive (+) terminal of the assisting battery.

## Roadside Emergencies

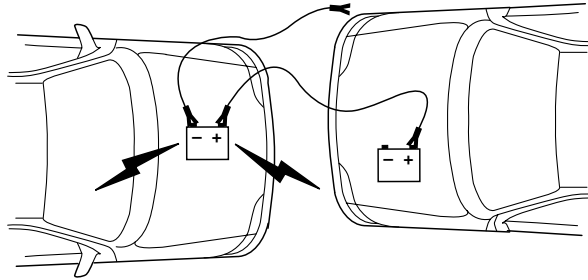

3. Connect the negative (-) cable to the negative (-) terminal of the assisting battery.

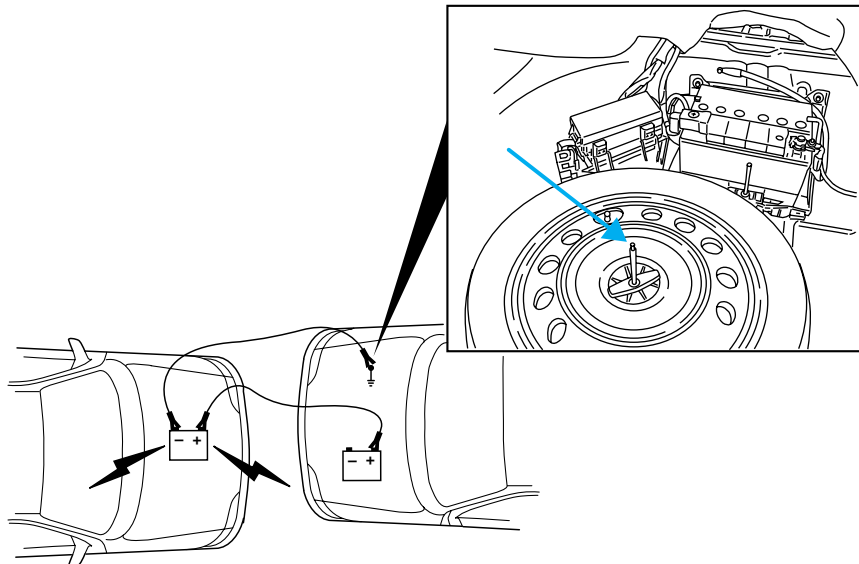

4. Make the final connection of the negative (-) cable to the spare tire tie-down stud. (Your vehicle may be equipped with a plastic cap on top of the tire tie-down stud. This cap must be removed prior to attaching the cable to the stud.)

## Roadside Emergencies



Do not connect the end of the second cable to the negative (-) terminal of the battery to be jumped. A spark may cause an explosion of the gases that surround the battery.

5. Ensure that the cables are clear of fan blades, belts, moving parts of both engines, or any fuel delivery system parts.

### **Jump starting**

1. Start the engine of the booster vehicle and run the engine at moderately increased speed.
2. Start the engine of the disabled vehicle.
3. Once the disabled vehicle has been started, run both engines for an additional three minutes before disconnecting the jumper cables.

## Roadside Emergencies

### Removing the jumper cables

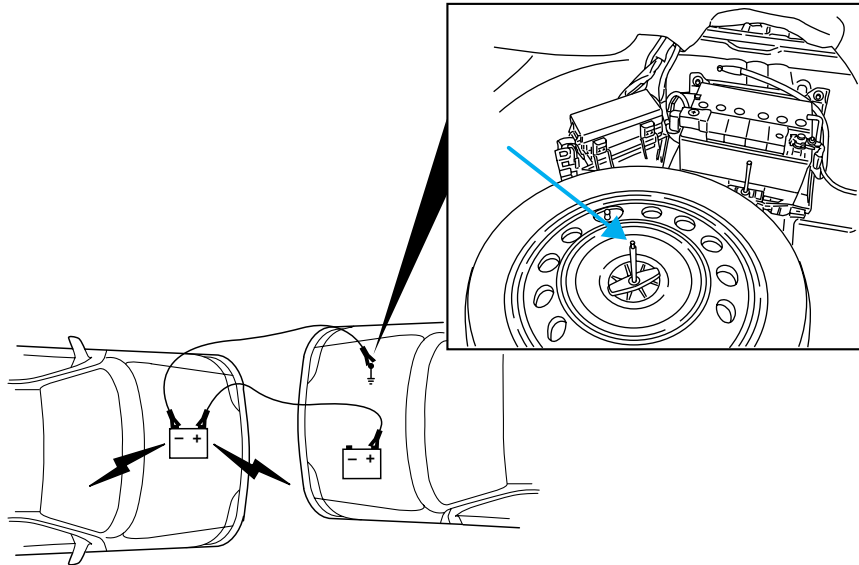

**Remove the jumper cables in the reverse order that they were connected.**

1. Remove the jumper cable from the spare tire tie-down stud.

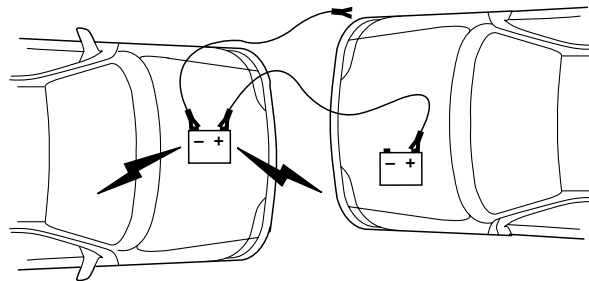

2. Remove the jumper cable on the negative (-) connection of the booster vehicle's battery.

## Roadside Emergencies

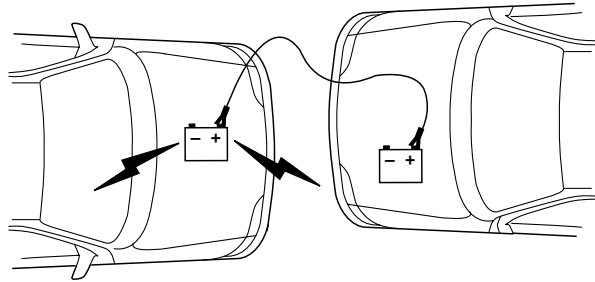

3. Remove the jumper cable from the positive (+) terminal of the booster vehicle's battery.

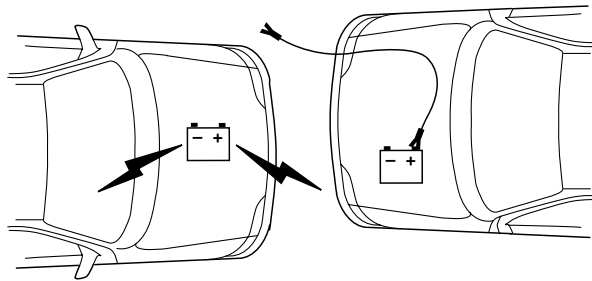

4. Remove the jumper cable from the positive (+) terminal of the disabled vehicle's battery.

After the disabled vehicle has been started and the jumper cables removed, allow it to idle for several minutes so the engine computer can *relearn* its idle conditions.

## Roadside Emergencies

### WRECKER TOWING

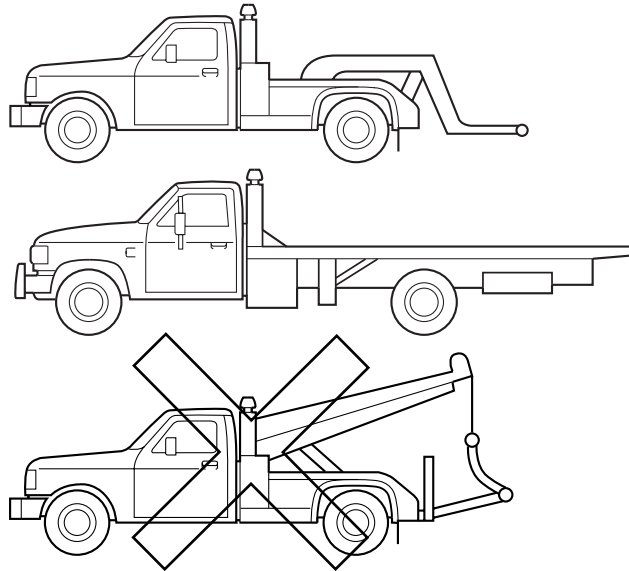

If you need to have your vehicle towed, contact a professional towing service or, if you are a member of a roadside assistance program, your roadside assistance service provider.

It is recommended that your vehicle be towed with a wheel lift or flatbed equipment. Do not tow with a slingbelt. Ford Motor Company has not approved a slingbelt towing procedure.

**If the vehicle is towed by other means or incorrectly, vehicle damage may occur.**

Ford Motor Company produces a towing manual for all authorized tow truck operators. Have your tow truck operator refer to this manual for proper hook-up and towing procedures for your vehicle.

## Customer Assistance

### GETTING THE SERVICES YOU NEED

#### At home

Ford Motor Company and Ford of Canada have authorized dealerships to service your vehicle. It is preferred that you return to the authorized dealer where your vehicle was purchased when warranty repairs are needed. However, you may also take your vehicle to another Ford Motor Company or Ford of Canada dealership authorized for warranty repairs. Certain warranty repairs require special training though, so not all dealers are authorized to perform all warranty repairs. That means that depending on the warranty repair needed, the vehicle may need to be taken to another dealer. If a particular dealership cannot assist you, then contact the Customer Relationship Center.

If you have questions or concerns, or are unsatisfied with the service you are receiving, follow these steps:

1. Contact your Sales Representative or Service Advisor at your selling/servicing dealership.
2. If your inquiry or concern remains unresolved, contact the Sales Manager or Service Manager at the dealership.
3. If the inquiry or concern cannot be resolved at the dealership level, please contact the Ford Customer Relationship Center.

#### Away from home

If you own a Ford or Mercury vehicle and are away from home when your vehicle needs service, or if you need more help than the dealership could provide, after following the steps described above, contact the Ford Customer Relationship Center to find an authorized dealership to help you.

In the United States:

Ford Motor Company  
Customer Relationship Center  
16800 Executive Plaza Drive  
P.O. Box 6248  
Dearborn, Michigan 48121  
1-800-392-3673 (FORD)  
(TDD for the hearing impaired: 1-800-232-5952)  
[www.ford.com](http://www.ford.com)

## Customer Assistance

In Canada:  
Customer Relationship Centre  
Ford Motor Company of Canada, Limited  
P.O. Box 2000  
Oakville, Ontario L6J 5E4  
1-800-565-3673 (FORD)  
[www.ford.ca](http://www.ford.ca)

If you own a Lincoln vehicle and are away from home when your vehicle needs service, or if you need more help than the dealership could provide, after following the steps described above, contact the Ford Customer Relationship Center to find an authorized dealership to help you.

In the United States:  
Ford Motor Company  
Customer Relationship Center  
16800 Executive Plaza Drive  
P.O. Box 6248  
Dearborn, Michigan 48121  
1-800-521-4140  
(TDD for the hearing impaired: 1-800-232-5952)  
[www.ford.com](http://www.ford.com)

In Canada:  
Customer Relationship Centre  
Ford Motor Company of Canada, Limited  
P.O. Box 2000  
Oakville, Ontario L6J 5E4  
1-800-565-3673 (FORD)  
[www.ford.ca](http://www.ford.ca)

In order to help you service your Ford or Lincoln Mercury vehicle, please have the following information available when contacting a Customer Relationship Center:

- Your telephone number (home and business)
- The name of the dealer and the city where the dealership is located
- The year and make of your vehicle
- The date of vehicle purchase
- The current odometer reading
- The vehicle identification number (VIN)

If you still have a complaint involving a warranty dispute, you may wish to contact the Dispute Settlement Board (U.S.).

## Customer Assistance

In some states (in the U.S.) you must directly notify Ford in writing before pursuing remedies under your state's warranty laws. Ford is also allowed a final repair attempt in some states.

In the United States, a warranty dispute must be submitted to the Dispute Settlement Board before taking action under the Magnuson-Moss Warranty Act, or to the extent allowed by state law, before pursuing replacement or repurchase remedies provided by certain state laws. This dispute handling procedure is not required prior to enforcing state created rights or other rights which are independent of the Magnuson-Moss Warranty Act or state replacement or repurchase laws.

### **FORD EXTENDED SERVICE PLAN**

You can get more protection for your new car or light truck by purchasing Ford Extended Service Plan (Ford ESP) coverage. Ford ESP is an optional service contract which is backed by Ford Motor Company or Ford Motor Service Company (in the U.S.) and Ford of Canada (in Canada). It provides the following:

- Benefits during the warranty period depending on the plan you purchase (such as: reimbursement for rentals; coverage for certain maintenance and wear items).
- Protection against covered repair costs after your Bumper-to-Bumper Warranty expires.

You may purchase Ford ESP from any participating Ford and Lincoln Mercury and Ford of Canada dealer. There are several plans available in various time, distance and deductible combinations which can be tailored to fit your own driving needs. Ford ESP also offers reimbursement benefits for towing and rental coverage.

When you buy Ford ESP, you receive Peace-of-Mind protection throughout the United States and Canada, provided by a network of more than 5,000 participating Ford or Lincoln Mercury and Ford of Canada dealers.

If you did not take advantage of the Ford Extended Service Plan at the time of purchasing your vehicle, you may still be eligible. Since this information is subject to change, please ask your dealer for complete details about Ford Extended Service Plan coverage options, or visit the Ford ESP website at [www.ford-esp.com](http://www.ford-esp.com).

## Customer Assistance

### THE DISPUTE SETTLEMENT BOARD (U.S. ONLY)

The Dispute Settlement Board is:

- an independent, third-party arbitration program for warranty disputes.
- available free to owners and lessees of qualifying Ford Motor Company vehicles.

The Dispute Settlement Board may not be available in all states. Ford Motor Company reserves the right to change eligibility limitations, modify procedures and/or to discontinue this service without notice and without incurring obligations per applicable state law.

### What kinds of cases does the Board review?

Unresolved warranty repair concerns or vehicle performance concerns as on Ford and Lincoln Mercury cars and Ford and Lincoln Mercury light trucks which are within the terms of any applicable written new vehicle warranty are eligible for review, except those involving:

- a non-Ford product
- a non-Ford dealership
- sales disputes between customer and dealer except those associated with warranty repairs or concerns with the vehicle's performance as designed
- a request for reimbursement of consequential expenses unless a service or product concern is being reviewed
- items not covered by the New Vehicle Limited Warranty (including maintenance and wear items)
- alleged personal injury/property damage claims
- cases currently in litigation
- vehicles not used primarily for family, personal or household purposes (except in states where the Dispute Settlement Board is required to review commercial vehicles)
- vehicles with non-U.S. warranties

Concerns are ineligible for review if the New Vehicle Limited Warranty has expired at receipt of your application and, in certain states eligibility is dependent upon the customer's possession of the vehicle.

Eligibility may differ according to state law. For example, see the unique brochures for California, West Virginia, Georgia and Wisconsin purchasers/lessees.

## Customer Assistance

### **Board membership**

The Board consists of:

- Three consumer representatives
- A Ford or Lincoln Mercury dealership representative

Consumer candidates for Board membership are recruited and trained by an independent consulting firm. The dealership Board member is chosen from Ford and Lincoln Mercury dealership management, recognized for their business leadership qualities.

### ***What the Board needs***

To have your case reviewed you must complete the application in the DSB brochure and mail it to the address provided on the application form. Some states will require you to use certified mail, with return receipt requested.

Your application is reviewed and, if it is determined to be eligible, you will receive an acknowledgment indicating:

- The file number assigned to your application.
- The toll-free phone number of the DSB's independent administrator.

Your dealership and a Ford Motor Company representative will then be asked to submit statements.

To properly review your case, the Board needs the following information:

- Legible copies of all documents and maintenance or repair orders relevant to the case.
- The year, make, model, and Vehicle Identification Number (VIN) listed on your vehicle ownership license.
- The date of repair(s) and mileage at the time of occurrence(s).
- The current mileage.
- The name of the dealer(s) who sold or serviced the vehicle.
- A brief description of your unresolved concern.
- A brief summary of the action taken by the dealer(s) and Ford Motor Company.
- The names (if known) of all the people you contacted at the dealership(s).
- A description of the action you expect to resolve your concern.

You will receive a letter of explanation if your application does not qualify for Board review.

## Customer Assistance

### ***Oral presentations***

If you would like to make an oral presentation, indicate YES to question 6 on the application. While it is your right to make an oral presentation before the Board, this is not a requirement and the Board will decide the case whether or not an oral presentation is made. An oral presentation may be requested by the Board as well.

### ***Making a decision***

Board members review all available information related to each complaint, including oral presentations, and arrive at a fair and impartial decision. Board review may be terminated at any time by either party.

Every effort is made to decide the case within 40 days of the date that all requested information is received by the Board. Since the Board generally meets once a month, it may take longer for the Board to consider some cases.

After a case is reviewed, the Board mails you a decision letter and a form on which to accept or reject the Board's decision. The decisions of the Board are binding on Ford (and, in some cases, on the dealer) but not on consumers who are free to pursue other remedies available to them under state or federal law.

### **To request a DSB Brochure/Application**

For a brochure/application, speak to your dealer or write/call to the Board at the following address/phone number:

Dispute Settlement Board  
P.O. Box 5120  
Southfield, MI 48086-5120  
1-800-428-3718

You may also contact the North American Customer Relationship Center at 1-800-392-3673 (Ford), TDD for the hearing impaired: 1-800-232-5952 or by writing to the Center at the following address:

Ford Motor Company  
Customer Relationship Center  
16800 Executive Plaza Drive  
P.O. Box 6248  
Dearborn, Michigan 48121

## Customer Assistance

### **UTILIZING THE MEDIATION/ARBITRATION PROGRAM (CANADA ONLY)**

In those cases where you continue to feel that the efforts by Ford and the dealer to resolve a factory-related vehicle service concern have been unsatisfactory, Ford of Canada participates in an impartial third party mediation/arbitration program administered by the Canadian Motor Vehicle Arbitration Plan (CAMVAP).

The CAMVAP program is a straight-forward and relatively speedy alternative to resolve a disagreement when all other efforts to produce a settlement have failed. This procedure is without cost to you and is designed to eliminate the need for lengthy and expensive legal proceedings.

In the CAMVAP program, impartial third-party arbitrators conduct hearings at mutually convenient times and places in an informal environment. These impartial arbitrators review the positions of the parties, make decisions and, when appropriate, render awards to resolve disputes. CAMVAP decisions are fast, fair, and final; the arbitrator's award is binding both to you and Ford of Canada.

CAMVAP services are available in all territories and provinces. For more information, without charge or obligation, call your CAMVAP Provincial Administrator directly at 1-800-207-0685.

### **GETTING ASSISTANCE OUTSIDE THE U.S. AND CANADA**

Before exporting your vehicle to a foreign country, contact the appropriate foreign embassy or consulate. These officials can inform you of local vehicle registration regulations and where to find unleaded fuel.

If you cannot find unleaded fuel or can only get fuel with an anti-knock index lower than is recommended for your vehicle, contact a district or owner relations/customer relationship office.

The use of leaded fuel in your vehicle without proper conversion may damage the effectiveness of your emission control system and may cause engine knocking or serious engine damage. Ford Motor Company/Ford of Canada is not responsible for any damage caused by use of improper fuel.

In the United States, using leaded fuel may also result in difficulty importing your vehicle back into the U.S.

## Customer Assistance

If your vehicle must be serviced while you are traveling or living in Central or South America, the Caribbean, or the Middle East, contact the nearest Ford dealership. If the dealership cannot help you, write or call:

FORD MOTOR COMPANY  
WORLDWIDE DIRECT MARKET OPERATIONS  
1555 Fairlane Drive  
Fairlane Business Park #3  
Allen Park, Michigan 48101  
U.S.A.  
Telephone: (313) 594-4857  
FAX: (313) 390-0804

If you are in another foreign country, contact the nearest Ford dealership. If the dealership employees cannot help you, they can direct you to the nearest Ford affiliate office.

If you buy your vehicle in North America and then relocate outside of the U.S. or Canada, register your vehicle identification number (VIN) and new address with Ford Motor Company Worldwide Direct Market Operations.

### **ORDERING ADDITIONAL OWNER'S LITERATURE**

To order the publications in this portfolio, contact Helm, Incorporated at:

HELM, INCORPORATED  
P.O. Box 07150  
Detroit, Michigan 48207

Or call:

**For a free publication catalog, order toll free: 1-800-782-4356**

Monday-Friday 8:00 a.m. - 6:00 p.m. EST

Helm, Incorporated can also be reached by their website:  
[www.helminc.com](http://www.helminc.com).

*(Items in this catalog may be purchased by credit card, check or money order.)*

### **Obtaining a French owner's guide**

French Owner's Guides can be obtained from your dealer or by writing to Ford Motor Company of Canada, Limited, Service Publications, P.O. Box 1580, Station B, Mississauga, Ontario L4Y 4G3.

## Customer Assistance

### **IN CALIFORNIA (U.S. ONLY)**

California Civil Code Section 1793.2(d) requires that, if a manufacturer or its representative is unable to repair a motor vehicle to conform to the vehicle's applicable express warranty after a reasonable number of attempts, the manufacturer shall be required to either replace the vehicle with one substantially identical or repurchase the vehicle and reimburse the buyer in an amount equal to the actual price paid or payable by the consumer (less a reasonable allowance for consumer use). The consumer has the right to choose whether to receive a refund or replacement vehicle.

California Civil Code Section 1793.22(b) presumes that the manufacturer has had a reasonable number of attempts to conform the vehicle to its applicable express warranties if, within the first 18 months of ownership of a new vehicle or the first 29,000 km (18,000 miles), whichever occurs first:

1. Two or more repair attempts are made on the same nonconformity likely to cause death or serious bodily injury OR
2. Four or more repair attempts are made on the same nonconformity (a defect or condition that substantially impairs the use, value or safety of the vehicle) OR
3. The vehicle is out of service for repair of nonconformities for a total of more than 30 calendar days (not necessarily all at one time)

In the case of 1 or 2 above, the consumer must also notify the manufacturer of the need for the repair of the nonconformity at the following address:

Ford Motor Company  
16800 Executive Plaza Drive  
Mail Drop 3NE-B  
Dearborn, MI 48126

## Customer Assistance

### REPORTING SAFETY DEFECTS (U.S. ONLY)

If you believe that your vehicle has a defect which could cause a crash or could cause injury or death, you should immediately inform the National Highway Traffic Safety Administration (NHTSA) in addition to notifying Ford Motor Company.

*Ford Motor Company*

If NHTSA receives similar complaints, it may open an investigation, and if it finds that a safety defect exists in a group of vehicles, it may order a recall and remedy campaign. However, NHTSA cannot become involved in individual problems between you, your dealer, or Ford Motor Company.

To contact NHTSA, you may either call the Auto Safety Hotline toll-free at 1-800-424-9393 (or 366-0123 in the Washington D.C. area) or write to:

NHTSA  
U.S. Department of Transportation  
Washington, D.C. 20590

You can also obtain other information about motor vehicle safety from the Hotline.

### WASHING THE EXTERIOR

Wash your vehicle regularly with cool or lukewarm water and a neutral Ph shampoo, such as Motorcraft Detail Wash (ZC-3-A), which is available from your dealer.

- Never use strong household detergents or soap, such as dish washing or laundry liquid. These products can discolor and spot painted surfaces.
- Never wash a vehicle that is “hot to the touch” or during exposure to strong, direct sunlight.
- Always use a clean sponge or carwash mitt with plenty of water for best results.
- Dry the vehicle with a chamois or soft terry cloth towel in order to eliminate water spotting.
- It is especially important to wash the vehicle regularly during the winter months, as dirt and road salt are difficult to remove and cause damage to the vehicle.
- Immediately remove items such as gasoline, diesel fuel, bird droppings and insect deposits because they can cause damage to the vehicle’s paintwork and trim over time.
- Remove any exterior accessories, such as antennas, before entering a car wash.
- **Suntan lotions and insect repellents can damage any painted surface; if these substances come in contact with your vehicle, wash off as soon as possible.**

### WAXING

Applying a polymer paint sealant to your vehicle every six months will assist in reducing minor scratches and paint damage.

- Wash the vehicle first.
- Do not use waxes that contain abrasives.
- Do not allow paint sealant to come in contact with any non-body (low-gloss black) colored trim, such as grained door handles, roof racks, bumpers, side moldings, mirror housings or the windshield cowl area. The paint sealant will “gray” or stain the parts over time.

### PAINT CHIPS

Your dealer has touch-up paint and sprays to match your vehicle’s color. Take your color code (printed on a sticker in the driver’s door jam) to your dealer to ensure you get the correct color.

## Cleaning

- Remove particles such as bird droppings, tree sap, insect deposits, tar spots, road salt and industrial fallout before repairing paint chips.
- Always read the instructions before using the products.

### ALUMINUM WHEELS AND WHEEL COVERS

Aluminum wheels and wheel covers are coated with a clearcoat paint finish. In order to maintain their shine:

- Clean weekly with Motorcraft Wheel and Tire Cleaner (ZC-37-A), which is available from your dealer. Heavy dirt and brake dust accumulation may require agitation with a sponge. Rinse thoroughly with a strong stream of water.
- Never apply any cleaning chemical to hot or warm wheel rims or covers.
- Some automatic car washes may cause damage to the finish on your wheel rims or covers. Chemical-strength cleaners, or cleaning chemicals, in combination with brush agitation to remove brake dust and dirt, could wear away the clearcoat finish over time.
- Do not use hydrofluoric acid-based or high caustic-based wheel cleaners, steel wool, fuels or strong household detergent.
- To remove tar and grease, use Ford Extra Strength Tar and Road Oil Removal (B7A-19520-AA), available from your dealer.

### ENGINE

Engines are more efficient when they are clean because grease and dirt buildup keep the engine warmer than normal. When washing:

- Take care when using a power washer to clean the engine. The high-pressure fluid could penetrate the sealed parts and cause damage.
- Do not spray a hot engine with cold water to avoid cracking the engine block or other engine components.
- Spray Motorcraft Engine Shampoo and Degreaser (ZC-20) on all parts that require cleaning and pressure rinse clean.
- Cover the highlighted areas to prevent water damage when cleaning the engine.

## Cleaning

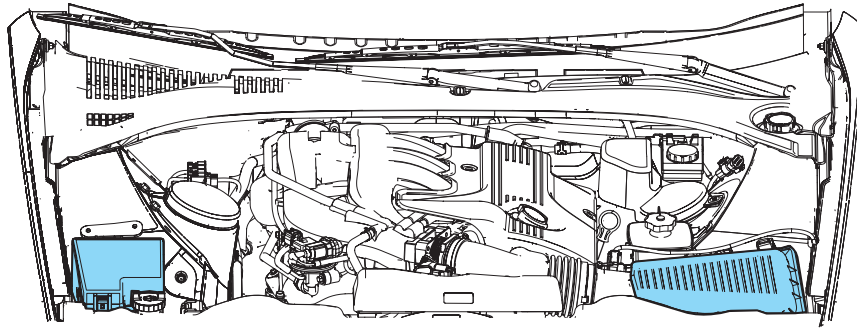

- **3.0L DOHC V6 engine**

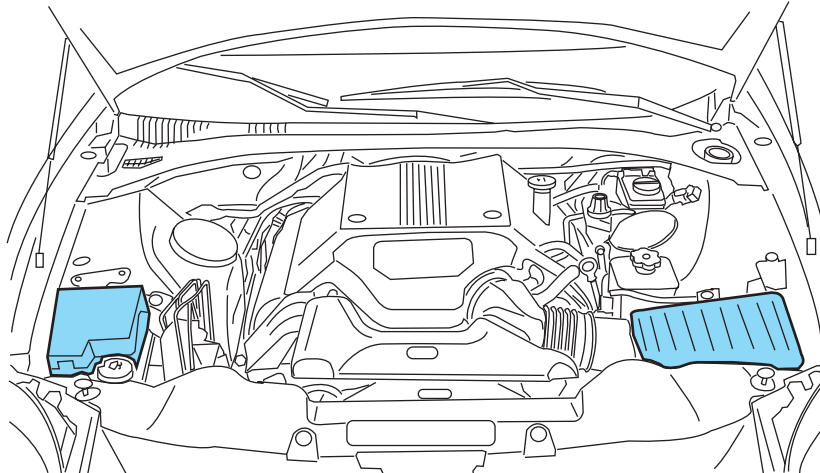

- **3.9L-4V V8 engine**
- Never wash or rinse the engine while it is running; water in the running engine may cause internal damage.

## Cleaning

### PLASTIC (NON-PAINTED) EXTERIOR PARTS

Use only approved products to clean plastic parts. These products are available from your dealer.

- For routine cleaning, use Motorcraft Detail Wash (ZC-3-A).
- If tar or grease spots are present, use Ford Extra Strength Tar and Road Oil Removal (B7A-19520-AA).

### WINDOWS AND WIPER BLADES

The windshield, rear window and wiper blades should be cleaned regularly. If the wiper does not wipe properly, substances on the windshield, rear window or the wiper blades may be the cause. These may include hot wax treatments used by commercial car washes, tree sap, or other organic contamination. To clean these items, please follow these tips:

- The windshield or rear window may be cleaned with a non-abrasive cleaner such as Motorcraft Ultra Clear Spray Glass Cleaner (ZC-23), available from your dealer.
- Do not use abrasives, as they may cause scratches.
- Do not use fuel, kerosene, or paint thinner to clean any parts.
- Wiper blades can be cleaned with isopropyl (rubbing) alcohol or windshield washer solution. Be sure to replace wiper blades when they appear worn or do not function properly.

### INSTRUMENT PANEL AND CLUSTER LENS

Clean the instrument panel with a damp cloth, then dry with a dry cloth.

- Avoid cleaners or polish that increase the gloss of the upper portion of the instrument panel. The dull finish in this area helps protect the driver from undesirable windshield reflection.



Do not use chemical solvents or strong detergents when cleaning the steering wheel or instrument panel to avoid contamination of the air bag system.

- Be certain to wash or wipe your hands clean if you have been in contact with certain products such as insect repellent and suntan lotion in order to avoid possible damage to the interior painted surfaces.

## Cleaning

### CLEANING SEATS EQUIPPED WITH SIDE AIR BAGS

Remove dust and loose dirt with a vacuum cleaner. In order to remove stains and soil, clean with Extra Strength Upholstery Cleaner (E8AZ-19523-AA).

**Never saturate the seat covers with any cleaning solution.**



Do not use chemical solvents or strong detergents when cleaning the seat where the side air bag is mounted. Such products could contaminate the side air bag system and affect performance of the side air bag in a collision. The air bag may not function correctly and not provide injury reduction benefits.

### INTERIOR TRIM

- Clean the interior trim areas with a damp cloth, then dry by wiping with a dry, soft, clean cloth.
- Do not use household or glass cleaners as these may damage the finish.

### INTERIOR

For fabric, carpets, cloth seats, safety belts and seats equipped with side air bags:

- Remove dust and loose dirt with a vacuum cleaner.
- Remove light stains and soil with Ford Extra Strength Upholstery Cleaner (E8AZ-19523-AA).
- If grease or tar is present on the material, spot-clean the area first with Motorcraft Spot and Stain Remover (ZC-14).
- Never saturate the seat covers with cleaning solution.
- Do not use household cleaning products or glass cleaners, which can stain and discolor the fabric and affect the flame retardant abilities of the seat materials.



Do not use cleaning solvents, bleach or dye on the vehicle's safety belts, as these actions may weaken the belt webbing.



Do not use chemical solvents or strong detergents when cleaning the seat-mounted side air bag. Such products could contaminate the side air bag system and affect performance of the side air bag in a collision.

## Cleaning

### LEATHER SEATS (IF EQUIPPED)

Your leather seating surfaces have a clear, protective coating over the leather.

- To clean, use a soft cloth with Motorcraft Deluxe Leather and Vinyl Cleaner (ZC-11-A). Dry the area with a soft cloth.
- To help maintain its resiliency and color, use the Motorcraft Deluxe Leather Care Kit (ZC-11-D), available from your authorized dealer.
- Do not use household cleaning products, alcohol solutions, solvents or cleaners intended for rubber, vinyl and plastics, or oil/petroleum-based leather conditioners. These products may cause premature wearing of the clear, protective coating.

### UNDERBODY

Flush the complete underside of your vehicle frequently. Keep body and door drain holes free from packed dirt.

### FORD, LINCOLN AND MERCURY CAR CARE PRODUCTS

Your Ford, Lincoln or Mercury dealer has many quality products available to clean your vehicle and protect its finishes. These quality products have been specifically engineered to fulfill your automotive needs; they are custom designed to complement the style and appearance of your vehicle. Each product is made from high quality materials that meet or exceed rigid specifications. For best results, use the following products or products of equivalent quality:

Motorcraft Custom Clearcoat Polish (ZC-8-A)

Ford Custom Vinyl Protectant\* (not available in Canada)  
(F2AZ-19530-A)

Motorcraft Vinyl Cleaner (Canada only) (CXC-93)

Motorcraft Vinyl Conditioner (Canada only) (CXC-94)

Motorcraft Deluxe Leather and Vinyl Cleaner (not available in Canada)  
(ZC-11-A)

Ford Extra Strength Tar and Road Oil Remover\* (not available in Canada)  
(B7A-19520-AA)

Ford Extra Strength Upholstery Cleaner (not available in Canada)  
(E8AZ-19523-AA)

Motorcraft Custom Bright Metal Cleaner (ZC-15)

## Cleaning

Motorcraft Wheel and Tire Cleaner (ZC-37-A)

Motorcraft Dash and Vinyl Cleaner (ZC-38-A)

Motorcraft Car Care Kit (ZC-26)

Ford Premium Car Wash Concentrate (F2SZ-19523-WC)

Motorcraft Carlite Glass Cleaner (Canada only) (CXC-100)

Motorcraft Spot and Stain Remover (ZC-14)

Motorcraft Detail Wash (ZC-3-A)

Motorcraft Tire Detailer (ZC-28)

Motorcraft Triple Clean (ZC-13)

Motorcraft Ultra-Clear Spray Glass Cleaner (not available in Canada)  
(ZC-23)

Motorcraft Engine Shampoo and Degreaser (ZC-20)

\* May be sold with the Motorcraft name

## Maintenance and Specifications

### SERVICE RECOMMENDATIONS

To help you service your vehicle:

- We highlight do-it-yourself items in the engine compartment for easy location.
- We provide a scheduled maintenance guide which makes tracking routine service easy.

If your vehicle requires professional service, your dealership can provide the necessary parts and service. Check your *Warranty Guide/Owner Information Guide* to find out which parts and services are covered.

Use only recommended fuels, lubricants, fluids and service parts conforming to specifications. Motorcraft parts are designed and built to provide the best performance in your vehicle.

### PRECAUTIONS WHEN SERVICING YOUR VEHICLE

- Do not work on a hot engine.
- Make sure that nothing gets caught in moving parts.
- Do not work on a vehicle with the engine running in an enclosed space, unless you are sure you have enough ventilation.
- Keep all open flames and other lit material away from the battery and all fuel related parts.

#### Working with the engine off

1. Set the parking brake and ensure the gearshift is securely latched in P (Park).
2. Turn off the engine and remove the key.
3. Block the wheels to prevent the vehicle from moving unexpectedly.

#### Working with the engine on

1. Set the parking brake and shift to P (Park).
2. Block the wheels.

**Note:** Do not start your engine with the air cleaner removed and do not remove it while the engine is running.

## Maintenance and Specifications

### OPENING THE HOOD

1. Inside the vehicle, pull the hood release handle located at the bottom left of the instrument panel.
2. Go to the front of the vehicle and release the auxiliary latch that is located under the front center of the hood by pushing upward on the handle.
3. Lift the hood until the lift cylinders hold it open.

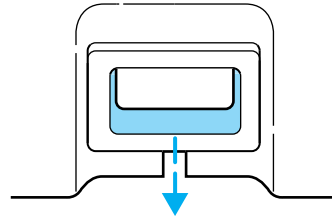

## Maintenance and Specifications

### IDENTIFYING COMPONENTS IN THE ENGINE COMPARTMENT

#### 3.0L DOHC V6 engine

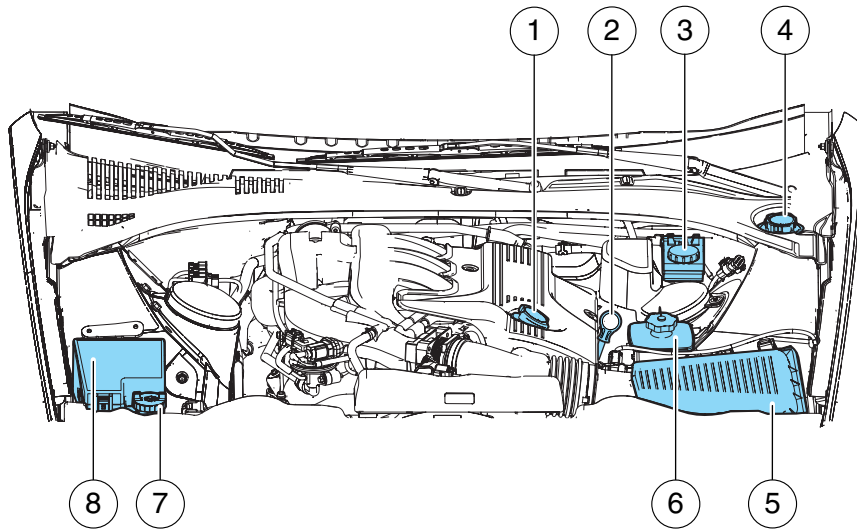

1. Engine oil filler cap
2. Engine oil dipstick
3. Brake fluid reservoir
4. Engine coolant reservoir
5. Air filter assembly
6. Power steering fluid reservoir
7. Windshield washer fluid reservoir
8. Power distribution box

## Maintenance and Specifications

### 3.9L-4V V8 engine

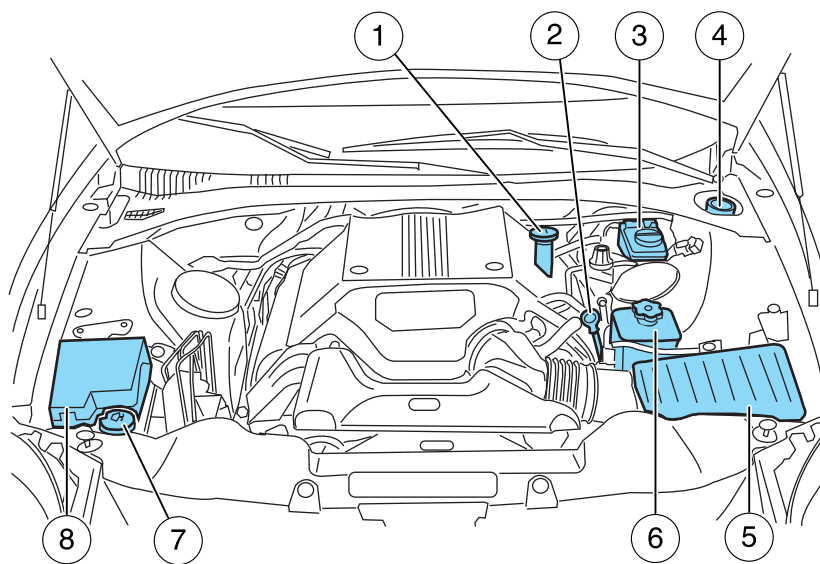

1. Engine oil filler cap
2. Engine oil dipstick
3. Brake fluid reservoir
4. Engine coolant reservoir
5. Air filter assembly
6. Power steering fluid reservoir
7. Windshield washer fluid reservoir
8. Power distribution box

## Maintenance and Specifications

### WINDSHIELD WASHER FLUID

Add fluid to fill the reservoir if the level is low. In very cold weather, do not fill the reservoir completely.

Only use a washer fluid that meets Ford specification WSB-M8B16-A2. Refer to *Lubricant specifications* in this chapter.

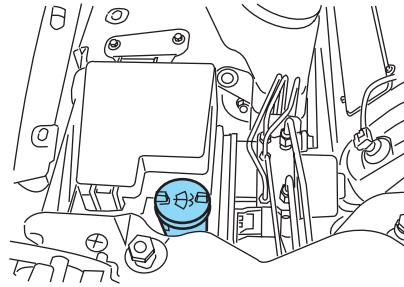

State or local regulations on volatile organic compounds may restrict the use of methanol, a common windshield washer antifreeze additive. Washer fluids containing non-methanol antifreeze agents should be used only if they provide cold weather protection without damaging the vehicle's paint finish, wiper blades or washer system.



If you operate your vehicle in temperatures below 4.5° C (40° F), use washer fluid with antifreeze protection. Failure to use washer fluid with antifreeze protection in cold weather could result in impaired windshield vision and increase the risk of injury or accident.

**Note:** Do not put washer fluid in the engine coolant reservoir. Washer fluid placed in the cooling system may harm engine and cooling system components.

### ENGINE OIL

#### Checking the engine oil

Refer to the scheduled maintenance guide for the appropriate intervals for checking the engine oil.

1. Make sure the vehicle is on level ground.
2. Turn the engine off and wait a few minutes for the oil to drain into the oil pan.
3. Set the parking brake and ensure the gearshift is securely latched in P (Park).
4. Open the hood. Protect yourself from engine heat.

## Maintenance and Specifications

5. Locate and carefully remove the engine oil level indicator (dipstick).

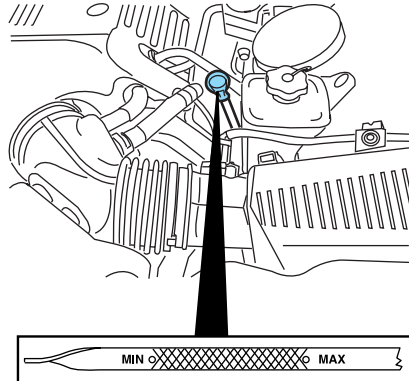

6. Wipe the indicator clean. Insert the indicator fully, then remove it again.

- If the oil level is **between the MIN and MAX marks**, the oil level is acceptable. **DO NOT ADD OIL.**
- If the oil level is below the MIN mark, add enough oil to raise the level within the MIN-MAX range.

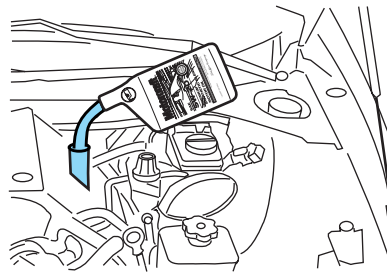

- Oil levels above the MAX mark may cause engine damage. Some oil must be removed from the engine by a service technician.

7. Put the indicator back in and ensure it is fully seated.

### Adding engine oil

1. Check the engine oil. For instructions, refer to *Checking the engine oil* in this chapter.
2. If the engine oil level is not within the normal range, add only certified engine oil of the recommended viscosity. Remove the engine oil filler cap and use a funnel to pour the engine oil into the opening.

## Maintenance and Specifications

3. Recheck the engine oil level. Make sure the oil level is not above the MAX mark on the engine oil level indicator (dipstick).
4. Install the indicator and ensure it is fully seated.
5. Fully install the engine oil filler cap by turning the filler cap clockwise tightly until clicks are heard, or until it is snug.

**To avoid possible oil loss, DO NOT operate the vehicle with the engine oil level indicator and/or the engine oil filler cap removed.**

### Engine oil and filter recommendations

Look for this certification trademark.

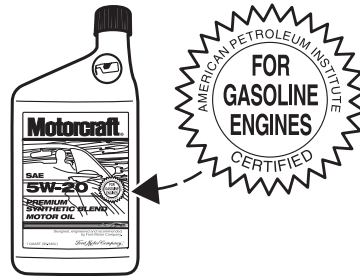

### **SAE 5W-20 engine oil is recommended.**

Only use oils “Certified For Gasoline Engines” by the American Petroleum Institute (API). Use Motorcraft or an equivalent oil meeting Ford Specification WSS-M2C153-H. **SAE 5W-20 oil provides optimum fuel economy and durability performance meeting all requirements for your vehicle’s engine.**

Change your engine oil and filter according to the appropriate schedule listed in the scheduled maintenance guide.

Do not use supplemental engine oil additives, oil treatments or engine treatments. They are unnecessary and could, under certain conditions, lead to engine damage which is not covered by your warranty.

Ford production and aftermarket (Motorcraft) oil filters are designed for added engine protection and long life. If a replacement oil filter is used that does not meet Ford material and design specifications, start-up engine noises of knock may be experienced.

It is recommended you use the appropriate Motorcraft oil filter (or another brand meeting Ford specifications) for your engine application.

## Maintenance and Specifications

### BATTERY

Your vehicle is equipped with a Motorcraft maintenance-free battery which is located in the luggage compartment, next to the spare tire.

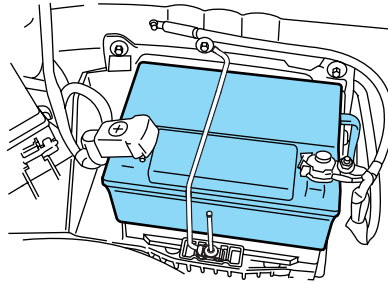



Your battery is designed to purge any battery gases to the outside of the vehicle by means of a vent hose. This vent hose **MUST** be attached at all times. Replacement batteries must be of the same vented design.

**If your battery has a cover/shield, make sure it is reinstalled after the battery has been cleaned or replaced.**

Your battery normally does not require additional water during its life of service. For longer, trouble-free operation, keep the top of the battery clean and dry. Make certain that the vent hose is attached. Also, make certain the battery cables are always tightly fastened to the battery terminals.

If you see any corrosion on the battery or terminals, remove the cables from the terminals and clean with a wire brush. You can neutralize the acid with a solution of baking soda and water.

 Batteries normally produce explosive gases which can cause personal injury. Therefore, do not allow flames, sparks or lighted substances to come near the battery. When working near the battery, always shield your face and protect your eyes. Always provide proper ventilation.

 When lifting a plastic-cased battery, excessive pressure on the end walls could cause acid to flow through the vent caps, resulting in personal injury and/or damage to the vehicle or battery. Lift the battery with a battery carrier or with your hands on opposite corners.

## Maintenance and Specifications



Keep batteries out of reach of children. Batteries contain sulfuric acid. Avoid contact with skin, eyes or clothing. Shield your eyes when working near the battery to protect against possible splashing of acid solution. In case of acid contact with skin or eyes, flush immediately with water for a minimum of 15 minutes and get prompt medical attention. If acid is swallowed, call a physician immediately.



Battery posts, terminals and related accessories contain lead and lead compounds. **Wash hands after handling.**

Because your vehicle's engine is electronically controlled by a computer, some control conditions are maintained by power from the battery. When the battery is disconnected or a new battery is installed, the engine must relearn its idle and fuel trim strategy for optimum driveability and performance. To begin this process:

1. With the vehicle at a complete stop, set the parking brake (Refer to *Parking Brake* in the *Driving* chapter for information on how to properly reset parking brake.).
  2. Put the gearshift lever in P (Park), turn off all accessories and start the engine.
  3. Run the engine until it reaches normal operating temperature.
  4. Allow the engine to idle for at least one minute.
  5. Turn the A/C on and allow the engine to idle for at least one minute.
  6. Drive the vehicle to complete the relearning process.
- The vehicle may need to be driven to relearn the idle and fuel trim strategy.
  - **If you do not allow the engine to relearn its idle trim, the idle quality of your vehicle may be adversely affected until the idle trim is eventually relearned.**

When the battery is disconnected or a new battery installed, the transmission must relearn its adaptive strategy. As a result of this, the transmission may shift firmly. This operation is considered normal and will not affect function or durability of the transmission. Over time the adaptive learning process will fully update transmission operation to its optimum shift feel.

If the battery has been disconnected or a new battery has been installed, the clock and the preset radio stations must be reset once the battery is reconnected.

## Maintenance and Specifications

- Always dispose of automotive batteries in a responsible manner. Follow your local authorized standards for disposal. Call your local authorized recycling center to find out more about recycling automotive batteries.

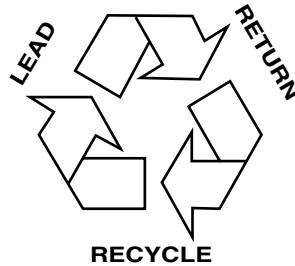

### ENGINE COOLANT

#### Checking engine coolant

The concentration and level of engine coolant should be checked at the mileage intervals listed in the scheduled maintenance guide. The coolant concentration should be maintained at 50/50 coolant and distilled water, which equates to a freeze point of  $-36^{\circ}\text{C}$  ( $-34^{\circ}\text{F}$ ). Coolant concentration testing is possible with a hydrometer or antifreeze tester (such as the Rotunda Battery and Antifreeze Tester, 014-R1060). The level of coolant should be maintained at the “cold full” or “cold fill range” level in the coolant reservoir. If the level falls below, add coolant per the instructions in the *Adding engine coolant* section.

Your vehicle was factory-filled with a 50/50 engine coolant and water concentration. If the concentration of coolant falls below 40% or above 60%, the engine parts could become damaged or not work properly. **A 50–50 mixture of coolant and water provides the following:**

- **Freeze protection down to  $-36^{\circ}\text{C}$  ( $-34^{\circ}\text{F}$ ).**
- **Boiling protection up to  $129^{\circ}\text{C}$  ( $265^{\circ}\text{F}$ ).**
- **Protection against rust and other forms of corrosion.**
- **Enables calibrated gauges to work properly.**

## Maintenance and Specifications

When the engine is cold, check the level of the engine coolant in the reservoir.



- The engine coolant should be at the “cold fill level” or within the “cold fill range” as listed on the engine coolant reservoir (depending upon application).
- Refer to the Scheduled Maintenance Guide for service interval schedules.
- Be sure to read and understand *Precautions when servicing your vehicle* in this chapter.

If the engine coolant has not been checked at the recommended interval, the engine coolant reservoir may become low or empty. If the reservoir is low or empty, add engine coolant to the reservoir. Refer to *Adding engine coolant* in this chapter.

**Note:** Automotive fluids are not interchangeable; do not use engine coolant, antifreeze or windshield washer fluid outside of its specified function and vehicle location.

### Adding engine coolant

When adding coolant, make sure it is a 50/50 mixture of engine coolant and distilled water. Add the mixture to the coolant reservoir, **when the engine is cool**, until the appropriate fill level is obtained.

## Maintenance and Specifications



Do not add engine coolant when the engine is hot. Steam and scalding liquids released from a hot cooling system can burn you badly. Also, you can be burned if you spill coolant on hot engine parts.



Do not put engine coolant in the windshield washer fluid container. If sprayed on the windshield, engine coolant could make it difficult to see through the windshield.

- **Add Motorcraft Premium Gold Engine Coolant (yellow-colored), VC-7-A (VC-7-B in Oregon), meeting Ford Specification WSS-M97B51-A1.**

**Note:** Use of Motorcraft Cooling System Stop Leak Pellets, VC-6, may darken the color of Motorcraft Premium Gold Engine Coolant from yellow to golden tan.

- **Do not add/mix an orange-colored, extended life coolant such as Motorcraft Speciality Orange Engine Coolant, VC-2 (US) or CXC-209 (Canada), meeting Ford specification WSS-M97B44-D with the factory-filled coolant.** Mixing Motorcraft Speciality Orange Engine Coolant or any orange-colored extended life product with your factory filled coolant can result in degraded corrosion protection.
- A large amount of water without engine coolant may be added, in case of emergency, to reach a vehicle service location. In this instance, the cooling system must be drained and refilled with a 50/50 mixture of engine coolant and distilled water as soon as possible. Water alone (without engine coolant) can cause engine damage from corrosion, overheating or freezing.
- **Do not use alcohol, methanol, brine or any engine coolants mixed with alcohol or methanol antifreeze (coolant).** Alcohol and other liquids can cause engine damage from overheating or freezing.
- **Do not add extra inhibitors or additives to the coolant.** These can be harmful and compromise the corrosion protection of the engine coolant.

For vehicles with overflow coolant systems with a non-pressurized cap on the coolant recovery system, add coolant to the coolant recovery reservoir when the engine is cool. Add the proper mixture of coolant and water to the “cold full” level. For all other vehicles, which have a coolant degas system with a pressurized cap, or if it is necessary to remove the coolant pressure relief cap on the radiator of a vehicle with an overflow system, follow these steps to add engine coolant.

## Maintenance and Specifications



To reduce the risk of personal injury, make sure the engine is cool before unscrewing the coolant pressure relief cap. The cooling system is under pressure; steam and hot liquid can come out forcefully when the cap is loosened slightly.

1. Before you begin, turn the engine off and let it cool.
2. When the engine is cool, wrap a thick cloth around the coolant pressure relief cap on the coolant reservoir (an opaque plastic bottle). Slowly turn cap counterclockwise (left) until pressure begins to release.
3. Step back while the pressure releases.
4. When you are sure that all the pressure has been released, use the cloth to turn it counterclockwise and remove the cap.
5. Fill the coolant reservoir slowly with the proper coolant mixture (see above), to within the “cold fill range” or the “cold full” level on the reservoir. If you removed the radiator cap in an overflow system, fill the radiator until the coolant is visible and radiator is almost full.
6. Replace the cap. Turn until tightly installed. (Cap must be tightly installed to prevent coolant loss.)

After any coolant has been added, check the coolant concentration, refer to *Checking Engine Coolant* section. If the concentration is not 50/50 (protection to  $-34^{\circ}\text{F}/-36^{\circ}\text{C}$ ), drain some coolant and adjust the concentration. It may take several drains and additions to obtain a 50/50 coolant concentration.

Whenever coolant has been added, the coolant level in the coolant reservoir should be checked the next few times you drive the vehicle. If necessary, add enough 50/50 concentration of engine coolant and distilled water to bring the liquid level to the proper level.

If you have to add more than 1.0 liter (1.0 quart) of engine coolant per month, have your dealer check the engine cooling system. Your cooling system may have a leak. Operating an engine with a low level of coolant can result in engine overheating and possible engine damage.

### Recycled engine coolant

Ford Motor Company does NOT recommend the use of recycled engine coolant in vehicles originally equipped with Motorcraft Premium Gold Engine Coolant since a Ford-approved recycling process is not yet available.



Used engine coolant should be disposed of in an appropriate manner. Follow your community's regulations and standards for recycling and disposing of automotive fluids.

## Maintenance and Specifications

### Coolant refill capacity

To find out how much fluid your vehicle's cooling system can hold, refer to *Refill capacities* in this chapter.

Fill your engine coolant reservoir as outlined in *Adding engine coolant* in this chapter.

### Severe climates

If you drive in extremely cold climates (less than  $-36^{\circ}\text{C}$  [ $-34^{\circ}\text{F}$ ):

- **It may be necessary to increase the coolant concentration above 50%.**
- **NEVER increase the coolant concentration above 60%.**
- **Increased engine coolant concentrations above 60% will decrease the overheat protection characteristics of the engine coolant and may cause engine damage.**
- **Refer to the chart on the coolant container to ensure the coolant concentration in your vehicle will provide adequate freeze protection at the temperatures in which you drive in the winter months.**

If you drive in extremely hot climates:

- **It is still necessary to maintain the coolant concentration above 40%.**
- **NEVER decrease the coolant concentration below 40%.**
- **Decreased engine coolant concentrations below 40% will decrease the corrosion protection characteristics of the engine coolant and may cause engine damage.**
- **Decreased engine coolant concentrations below 40% will decrease the freeze protection characteristics of the engine coolant and may cause engine damage.**
- **Refer to the chart on the coolant container to ensure the coolant concentration in your vehicle will provide adequate protection at the temperatures in which you drive.**

Vehicles driven year-round in non-extreme climates should use a 50/50 mixture of engine coolant and distilled water for optimum cooling system and engine protection.



### What you should know about fail-safe cooling

If the engine coolant supply is depleted, this feature allows the vehicle to be driven temporarily before incremental component damage is incurred. The "fail-safe" distance depends on ambient temperatures, vehicle load and terrain.

## Maintenance and Specifications

### **How fail-safe cooling works**

If the engine begins to overheat:

- The engine coolant temperature gauge will move to the H (hot) area.
- The  symbol will illuminate.
- The  symbol will illuminate.
- The  symbol will illuminate.



If the engine reaches a preset over-temperature condition, the engine will automatically switch to alternating cylinder operation. Each disabled cylinder acts as an air pump and cools the engine.

When this occurs the vehicle will still operate. However:

- The engine power will be limited.
- The air conditioning system will be disabled.

Continued operation will increase the engine temperature and the engine will completely shut down, causing steering and braking effort to increase.

Once the engine temperature cools, the engine can be re-started. Take your vehicle to a service facility as soon as possible to minimize engine damage.

### **When fail-safe mode is activated**

You have limited engine power when in the fail-safe mode, so drive the vehicle with caution. The vehicle will not be able to maintain high-speed operation and the engine will run rough. Remember that the engine is capable of completely shutting down automatically to prevent engine damage, therefore:

1. Pull off the road as soon as safely possible and turn off the engine.
2. Arrange for the vehicle to be taken to a service facility.
3. If this is not possible, wait a short period for the engine to cool.
4. Check the coolant level and replenish if low.



Never remove the coolant reservoir cap while the engine is running or hot.

5. Re-start the engine and take your vehicle to a service facility.

## Maintenance and Specifications

**Driving the vehicle without repairing the engine problem increases the chance of engine damage. Take your vehicle to a service facility as soon as possible.**

### WHAT YOU SHOULD KNOW ABOUT AUTOMOTIVE FUELS

#### Important safety precautions



Do not overfill the fuel tank. The pressure in an overfilled tank may cause leakage and lead to fuel spray and fire.



The fuel system may be under pressure. If the fuel filler cap is venting vapor or if you hear a hissing sound, wait until it stops before completely removing the fuel filler cap. Otherwise, fuel may spray out and injure you or others.



If you do not use the proper fuel filler cap, excessive pressure or vacuum in the fuel tank may damage the fuel system or cause the fuel cap to disengage in a collision, which may result in possible personal injury.



Automotive fuels can cause serious injury or death if misused or mishandled.



Gasoline may contain benzene, which is a cancer-causing agent.

Observe the following guidelines when handling automotive fuel:

- Extinguish all smoking materials and any open flames before fueling your vehicle.
- Always turn off the vehicle before fueling.
- Automotive fuels can be harmful or fatal if swallowed. Fuel such as gasoline is highly toxic and if swallowed can cause death or permanent injury. If fuel is swallowed, call a physician immediately, even if no symptoms are immediately apparent. The toxic effects of fuel may not be visible for hours.



## Maintenance and Specifications

- Avoid inhaling fuel vapors. Inhaling too much fuel vapor of any kind can lead to eye and respiratory tract irritation. In severe cases, excessive or prolonged breathing of fuel vapor can cause serious illness and permanent injury.
- Avoid getting fuel liquid in your eyes. If fuel is splashed in the eyes, remove contact lenses (if worn), flush with water for 15 minutes and seek medical attention. Failure to seek proper medical attention could lead to permanent injury.
- Fuels can also be harmful if absorbed through the skin. If fuel is splashed on the skin and/or clothing, promptly remove contaminated clothing and wash skin thoroughly with soap and water. Repeated or prolonged skin contact with fuel liquid or vapor causes skin irritation.
- Be particularly careful if you are taking “Antabuse” or other forms of disulfiram for the treatment of alcoholism. Breathing gasoline vapors, or skin contact could cause an adverse reaction. In sensitive individuals, serious personal injury or sickness may result. If fuel is splashed on the skin, promptly wash skin thoroughly with soap and water. Consult a physician immediately if you experience an adverse reaction.



When refueling always shut the engine off and never allow sparks or open flames near the filler neck. Never smoke while refueling. Fuel vapor is extremely hazardous under certain conditions. Care should be taken to avoid inhaling excess fumes.



The flow of fuel through a fuel pump nozzle can produce static electricity, which can cause a fire if fuel is pumped into an ungrounded fuel container.

Use the following guidelines to avoid static build-up when filling an ungrounded fuel container:

- Place approved fuel container on the ground.
- DO NOT fill a fuel container while it is in the vehicle (including the cargo area).
- Keep the fuel pump nozzle in contact with the fuel container while filling.
- DO NOT use a device that would hold the fuel pump handle in the fill position.

## Maintenance and Specifications

### Fuel Filler Cap

Your fuel tank filler cap has an indexed design with a 1/8 turn on/off feature.

When fueling your vehicle:

1. Turn the engine off.
2. Carefully turn the filler cap counterclockwise 1/8 of a turn until it stops.
3. Pull to remove the cap from the fuel filler pipe.
4. To install the cap, align the tabs on the cap with the notches on the filler pipe.
5. Turn the filler cap clockwise 1/8 of a turn until it stops.

If the “Check Fuel Cap” indicator comes on and stays on after you start the engine, the fuel filler cap may not be properly installed. Turn off the engine, remove the fuel filler cap, align the cap properly and reinstall it.

**If you must replace the fuel filler cap, replace it with a fuel filler cap that is designed for your vehicle. The customer warranty may be void for any damage to the fuel tank or fuel system if the correct genuine Ford or Motorcraft fuel filler cap is not used.**



The fuel system may be under pressure. If the fuel filler cap is venting vapor or if you hear a hissing sound, wait until it stops before completely removing the fuel filler cap. Otherwise, fuel may spray out and injure you or others.



If you do not use the proper fuel filler cap, excessive pressure or vacuum in the fuel tank may damage the fuel system or cause the fuel cap to disengage in a collision, which may result in possible personal injury.

### Choosing the right fuel

Use only UNLEADED FUEL. The use of leaded fuel is prohibited by law and could damage your vehicle.

Do not use fuel containing methanol. It can damage critical fuel system components.

Your vehicle was not designed to use fuel or fuel additives with metallic compounds, including manganese-based compounds containing MMT.

Repairs to correct the effects of using a fuel for which your vehicle was not designed may not be covered by your warranty.

## Maintenance and Specifications

### Octane recommendations

Your vehicle is designed to use “Premium” unleaded gasoline with an (R+M)/2 octane rating of 91 or higher for optimum performance.

The use of gasolines with lower octane ratings may degrade performance. We do not recommend the use of gasolines labeled as “Premium” in high altitude areas that are sold with octane ratings of less than 91.

Do not be concerned if your engine sometimes knocks lightly. However, if it knocks heavily under most driving conditions while you are using fuel with the recommended octane rating, see your dealer or a qualified service technician to prevent any engine damage.

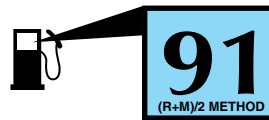

### Fuel quality

If you are experiencing starting, rough idle or hesitation driveability problems during a cold start, try a different brand of “Premium” unleaded gasoline. If the problems persist, see your dealer or a qualified service technician.

It should not be necessary to add any aftermarket products to your fuel tank if you continue to use high quality fuel of the recommended octane rating. Aftermarket products could cause damage to the fuel system. Repairs to correct the effects of using an aftermarket product in your fuel may not be covered by your warranty.

Many of the world’s automakers issued the World-wide Fuel Charter that recommends gasoline specifications to provide improved performance and emission control system protection for your vehicle. Gasolines that meet the World-wide Fuel Charter should be used when available. Ask your fuel supplier about gasolines that meet the World-wide Fuel Charter.

### Cleaner air

Ford endorses the use of reformulated “cleaner-burning” gasolines to improve air quality.

### Running out of fuel

Avoid running out of fuel because this situation may have an adverse affect on powertrain components.

If you have run out of fuel:

- You may need to cycle the ignition from OFF to ON several times after refueling, to allow the fuel system to pump the fuel from the tank to the engine.

## Maintenance and Specifications

- Your “Check Engine” indicator may come on. For more information on the “Check Engine” indicator, refer to the *Instrument Cluster* chapter.

### Fuel Filter

For fuel filter replacement, see your dealer or a qualified service technician. Refer to the scheduled maintenance guide for the appropriate intervals for changing the fuel filter.

**Replace the fuel filter with an authorized Motorcraft part. The customer warranty may be void for any damage to the fuel system if an authorized Motorcraft fuel filter is not used.**

### ESSENTIALS OF GOOD FUEL ECONOMY

#### Measuring techniques

Your best source of information about actual fuel economy is you, the driver. You must gather information as accurately and consistently as possible. Fuel expense, frequency of fill-ups or fuel gauge readings are NOT accurate as a measure of fuel economy. We do not recommend taking fuel economy measurements during the first 1,600 km (1,000 miles) of driving (engine break-in period). You will get a more accurate measurement after 3,000 km–5,000 km (2,000 miles–3,000 miles).

#### Filling the tank

The advertised fuel capacity of the fuel tank on your vehicle is equal to the rated refill capacity of the fuel tank as listed in the *Refill capacities* section of this chapter.

The advertised capacity is the amount of the indicated capacity and the empty reserve combined. Indicated capacity is the difference in the amount of fuel in a full tank and a tank when the fuel gauge indicates empty. Empty reserve is the small amount of fuel remaining in the fuel tank after the fuel gauge indicates empty.

**The amount of usable fuel in the empty reserve varies and should not be relied upon to increase driving range. When refueling your vehicle after the fuel gauge indicates empty, you might not be able to refuel the full amount of the advertised capacity of the fuel tank due to the empty reserve still present in the tank.**

For consistent results when filling the fuel tank:

- Turn the engine/ignition switch to the off position prior to refueling, an error in the reading will result if the engine is left running.

## Maintenance and Specifications

- Use the same filling rate setting (low — medium — high) each time the tank is filled.
- Allow no more than 2 automatic click-offs when filling.
- Always use fuel with the recommended octane rating.
- Use a known quality gasoline, preferably a national brand.
- Use the same side of the same pump and have the vehicle facing the same direction each time you fill up.
- Have the vehicle loading and distribution the same every time.

Your results will be most accurate if your filling method is consistent.

### Calculating fuel economy

1. Fill the fuel tank completely and record the initial odometer reading (in kilometers or miles).
2. Each time you fill the tank, record the amount of fuel added (in liters or gallons).
3. After at least three to five tank fill-ups, fill the fuel tank and record the current odometer reading.
4. Subtract your initial odometer reading from the current odometer reading.
5. Follow one of the simple calculations in order to determine fuel economy:

Calculation 1: **Multiply liters used by 100, then divide by total kilometers traveled.**

Calculation 2: **Divide total miles traveled by total gallons used.**

Keep a record for at least one month and record the type of driving (city or highway). This will provide an accurate estimate of the vehicle's fuel economy under current driving conditions. Additionally, keeping records during summer and winter will show how temperature impacts fuel economy. In general, lower temperatures give lower fuel economy.

### Driving style — good driving and fuel economy habits

Give consideration to the lists that follow and you may be able to change a number of variables and improve your fuel economy.

#### **Habits**

- Smooth, moderate operation can yield up to 10% savings in fuel.
- Steady speeds without stopping will usually give the best fuel economy.

## Maintenance and Specifications

- Idling for long periods of time (greater than one minute) may waste fuel.
- Anticipate stopping; slowing down may eliminate the need to stop.
- Sudden or hard accelerations may reduce fuel economy.
- Slow down gradually.
- Driving at reasonable speeds (traveling at 88 km/h [55 mph] uses 15% less fuel than traveling at 105 km/h [65 mph]).
- Revving the engine before turning it off may reduce fuel economy.
- Using the air conditioner or defroster may reduce fuel economy.
- You may want to turn off the speed control in hilly terrain if unnecessary shifting between third and fourth gear occurs. Unnecessary shifting of this type could result in reduced fuel economy.
- Warming up a vehicle on cold mornings is not required and may reduce fuel economy.
- Resting your foot on the brake pedal while driving may reduce fuel economy.
- Combine errands and minimize stop-and-go driving.

### **Maintenance**

- Keep tires properly inflated and use only recommended size.
- Operating a vehicle with the wheels out of alignment will reduce fuel economy.
- Use recommended engine oil. Refer to *Lubricant specifications* in this chapter.
- Perform all regularly scheduled maintenance items. Follow the recommended maintenance schedule and owner maintenance checks found in your vehicle scheduled maintenance guide.

### **Conditions**

- Heavily loading a vehicle or towing a trailer may reduce fuel economy at any speed.
- Carrying unnecessary weight may reduce fuel economy (approximately 0.4 km/L [1 mpg] is lost for every 180 kg [400 lb] of weight carried).
- Adding certain accessories to your vehicle (for example bug deflectors, rollbars/light bars, running boards, ski/luggage racks) may reduce fuel economy.

## Maintenance and Specifications

- Using fuel blended with alcohol may lower fuel economy.
- Fuel economy may decrease with lower temperatures during the first 12–16 km (8–10 miles) of driving.
- Driving on flat terrain offers improved fuel economy as compared to driving on hilly terrain.
- Transmissions give their best fuel economy when operated in the top cruise gear and with steady pressure on the gas pedal.
- Close windows for high speed driving.

### EPA window sticker

Every new vehicle should have the EPA window sticker. Contact your dealer if the window sticker is not supplied with your vehicle. The EPA window sticker should be your guide for the fuel economy comparisons with other vehicles.

It is important to note the box in the lower left corner of the window sticker. These numbers represent the Range of L/100 km (MPG) expected on the vehicle under optimum conditions. Your fuel economy may vary depending upon the method of operation and conditions.

### EMISSION CONTROL SYSTEM

Your vehicle is equipped with various emission control components and a catalytic converter which will enable your vehicle to comply with applicable exhaust emission standards. To make sure that the catalytic converter and other emission control components continue to work properly:

- Use only the specified fuel listed.
- Avoid running out of fuel.
- Do not turn off the ignition while your vehicle is moving, especially at high speeds.
- Have the items listed in your scheduled maintenance guide performed according to the specified schedule.

The scheduled maintenance items listed in the scheduled maintenance guide are essential to the life and performance of your vehicle and to its emissions system.

If other than Ford, Motorcraft or Ford-authorized parts are used for maintenance replacements or for service of components affecting emission control, such non-Ford parts should be equivalent to genuine Ford Motor Company parts in performance and durability.

## Maintenance and Specifications



Do not park, idle, or drive your vehicle in dry grass or other dry ground cover. The emission system heats up the engine compartment and exhaust system, which can start a fire.

Illumination of the “Check Engine” light, charging system warning light or the temperature warning light, fluid leaks, strange odors, smoke or loss of engine power, could indicate that the emission control system is not working properly.



Exhaust leaks may result in entry of harmful and potentially lethal fumes into the passenger compartment.

Do not make any unauthorized changes to your vehicle or engine. By law, vehicle owners and anyone who manufactures, repairs, services, sells, leases, trades vehicles, or supervises a fleet of vehicles are not permitted to intentionally remove an emission control device or prevent it from working. Information about your vehicle’s emission system is on the Vehicle Emission Control Information Decal located on or near the engine. This decal identifies engine displacement and gives some tune up specifications.

Please consult your *Warranty Guide* for complete emission warranty information.

### Readiness for Inspection/Maintenance (I/M) testing

In some localities, it may be a legal requirement to pass an I/M test of the on-board diagnostics system. If your “Check Engine/Service Engine Soon” light is on, refer to the description in the *Warning lights and chimes* section of the *Instrument cluster* chapter. Your vehicle may not pass the I/M test with the “Check Engine/Service Engine Soon” light on.

If the vehicle’s powertrain system or its battery has just been serviced, the on-board diagnostics system is reset to a “not ready for I/M test” condition. To ready the on-board diagnostics system for I/M testing, a minimum of 30 minutes of city and highway driving is necessary as described below:

- First, at least 10 minutes of driving on an expressway or highway.
- Next, at least 20 minutes driving in stop-and-go, city-type traffic with at least four idle periods.

Allow the vehicle to sit for at least eight hours without starting the engine. Then, start the engine and complete the above driving cycle. The engine must warm up to its normal operating temperature. Once started, do not turn off the engine until the above driving cycle is complete.

## Maintenance and Specifications

### POWER STEERING FLUID

Refer to the scheduled maintenance guide for the service interval schedules. If adding fluid is necessary, use only MERCON® ATF.

1. Start the engine and let it run until it reaches normal operating temperature (the engine coolant temperature gauge indicator will be near the center of the normal area between H and C).
2. While the engine idles, turn the steering wheel left and right several times.
3. Turn the engine off.
4. Check the fluid level in the reservoir. It should be between the MIN and MAX lines. Do not add fluid if the level is in this range.
5. If the fluid is low, add fluid in small amounts, continuously checking the level until it reaches the range between the MIN and MAX lines. Be sure to put the cap back on the reservoir.

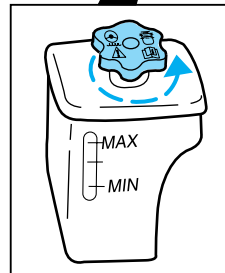
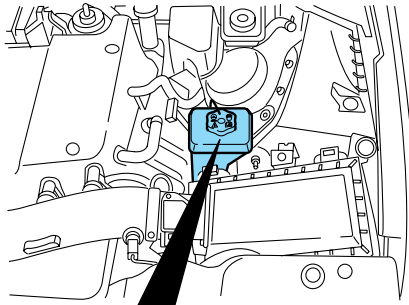

### BRAKE FLUID RESERVOIR

The fluid level will drop slowly as the brakes wear, and will rise when the brake components are replaced. Fluid levels between the “MIN” and “MAX” lines are within the normal operating range, there is no need to add fluid. If the fluid levels are outside of the normal operating range, the performance of your brake system could be compromised, seek service from your dealer immediately.

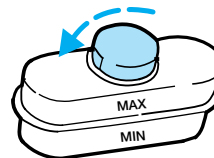

### TRANSMISSION FLUID

#### Checking automatic transmission fluid

The 5R55S transmission does not have a transmission fluid dipstick.

## Maintenance and Specifications

Refer to your scheduled maintenance guide for scheduled intervals for fluid checks and changes. Your transmission does not consume fluid. However, the fluid level should be checked if the transmission is not working properly, i.e., if the transmission slips or shifts slowly or if you notice some sign of fluid leakage.

**Transmission fluid should be checked and, if required, fluid should be added by a qualified technician.**

Before adding any fluid, make sure the correct type is used. Use only MERCON® V automatic transmission fluid. The type of fluid used is indicated on the transmission fluid pan, extension housing and also in the *Lubricant specifications* section in this chapter.

**Use of a non-approved automatic transmission fluid may cause internal transmission component damage and void the warranty.**

Do not use supplemental transmission fluid additives, treatments or cleaning agents. The use of these materials may affect transmission operation and result in damage to internal transmission components.

### AIR FILTER MAINTENANCE

Refer to the scheduled maintenance guide for the appropriate intervals for changing the air filter element.

When changing the air filter element, use only the Motorcraft air filter element listed. Refer to *Motorcraft Part Numbers*.

**Note:** Do not start your engine with the air cleaner removed and do not remove it while the engine is running.

#### Changing the air filter element

1. Loosen the hose clamp on the outlet tube at the air filter housing.

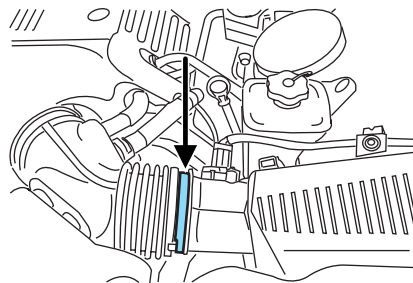

## Maintenance and Specifications

2. Release the two clamps that secure the cover to the air filter housing and place the cover aside.

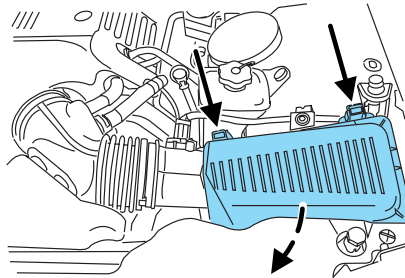

3. Remove the air filter element from the air filter housing.

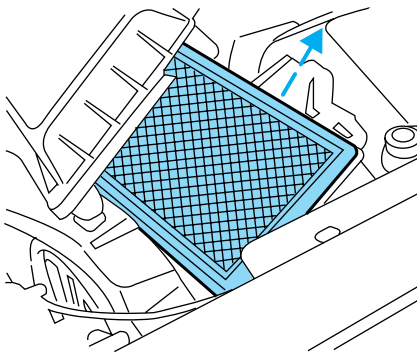

4. Wipe the air filter housing and cover clean to remove any dirt or debris and to ensure good sealing.

5. Install a new air filter element. Be careful not to crimp the filter element edges between the air filter housing and cover. This could cause filter damage and allow unmetered air to enter the engine if not properly seated.

6. Replace the air filter housing cover and secure the clamps.

### INFORMATION ABOUT UNIFORM TIRE QUALITY GRADING

New vehicles are fitted with tires that have a rating on them called Tire Quality Grades. The Quality grades can be found where applicable on the tire sidewall between tread shoulder and maximum section width. For example:

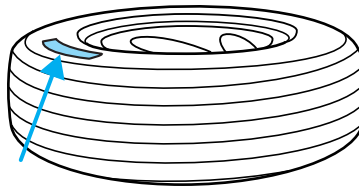

## Maintenance and Specifications

### • Treadwear 200 Traction AA Temperature A

These Tire Quality Grades are determined by standards that the United States Department of Transportation has set.

Tire Quality Grades apply to new pneumatic tires for use on passenger cars. They do not apply to deep tread, winter-type snow tires, space-saver or temporary use spare tires, tires with nominal rim diameters of 10 to 12 inches or limited production tires as defined in Title 49 Code of Federal Regulations Part 575.104(c)(2).

**U.S. Department of Transportation-Tire quality grades:** The U.S. Department of Transportation requires Ford to give you the following information about tire grades exactly as the government has written it.

### Treadwear

The treadwear grade is a comparative rating based on the wear rate of the tire when tested under controlled conditions on a specified government test course. For example, a tire graded 150 would wear one and one-half (1 1/2) times as well on the government course as a tire graded 100. The relative performance of tires depends upon the actual conditions of their use, however, and may depart significantly from the norm due to variations in driving habits, service practices, and differences in road characteristics and climate.

### Traction AA A B C

The traction grades, from highest to lowest are AA, A, B, and C. The grades represent the tire's ability to stop on wet pavement as measured under controlled conditions on specified government test surfaces of asphalt and concrete. A tire marked C may have poor traction performance.



The traction grade assigned to this tire is based on straight-ahead braking traction tests, and does not include acceleration, cornering, hydroplaning or peak traction characteristics.

### Temperature A B C

The temperature grades are A (the highest), B and C, representing the tire's resistance to the generation of heat and its ability to dissipate heat when tested under controlled conditions on a specified indoor laboratory test wheel. Sustained high temperature can cause the material of the tire to degenerate and reduce tire life, and excessive temperature can lead to sudden tire failure. The grade C corresponds to a level of performance

## Maintenance and Specifications

which all passenger car tires must meet under the Federal Motor Vehicle Safety Standard No. 109. Grades B and A represent higher levels of performance on the laboratory test wheel than the minimum required by law.



The temperature grade for this tire is established for a tire that is properly inflated and not overloaded. Excessive speed, underinflation, or excessive loading, either separately or in combination, can cause heat buildup and possible tire failure.

### SERVICING YOUR TIRES

#### Checking the tire pressure

- Use an accurate tire pressure gauge.
- Check the tire pressure when tires are cold, after the vehicle has been parked for at least one hour or has been driven less than 5 km (3 miles).
- Adjust tire pressure to recommended specifications found on the Safety Certification Label located on the driver's door pillar.



Improperly inflated tires can affect vehicle handling and can fail suddenly, possibly resulting in loss of vehicle control.

#### Tire rotation

Because your vehicle's tires perform different jobs, they often wear differently. To make sure your tires wear evenly and last longer, rotate them as indicated in the scheduled maintenance guide. If you notice that the tires wear unevenly, have them checked.

# Maintenance and Specifications

- Four tire rotation

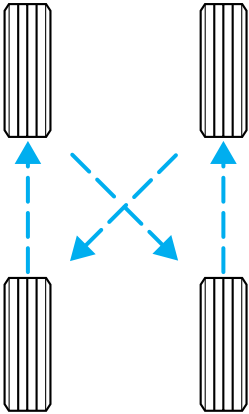

- Five tire rotation (with full-size spare tire)

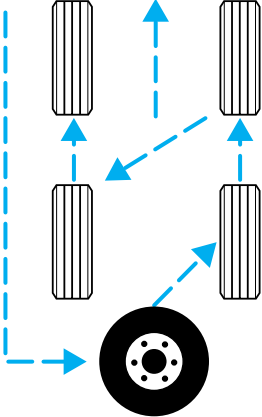

## Maintenance and Specifications

- Unidirectional tire rotation

For vehicles equipped with original equipment unidirectional tires and full-size spare, your vehicle can be driven with the unidirectional full-size spare, rotating counter to the directional arrow on the tire sidewall.

Your unidirectional full-size spare tire is rotated for wear balance. Best performance may be achieved by remounting the tire to the wheel, if necessary, to permit tire rotation with the directional arrow on the tire sidewall.

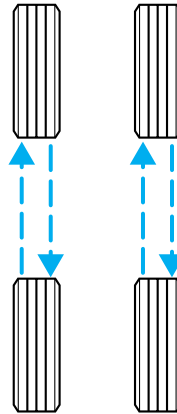

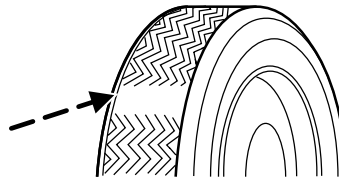

### Replacing the tires

Replace the tires when the wear band is visible through the tire treads.



 When replacing full size tires, never mix radial bias-belted, or bias-type tires. Use only the tire sizes that are listed on the Certification or Tire Label. Make sure that all tires are the same size, speed rating, and load-carrying capacity. Use only the tire combinations recommended on the label. If you do not follow these precautions, your vehicle may not drive properly and safely.

 Make sure that all replacement tires are of the same size, type, load-carrying capacity and tread design (e.g., “All Terrain”, “Touring”, etc.), as originally offered by Ford.

 Failure to follow these precautions may adversely affect the handling of the vehicle, and increase the risk of loss of vehicle control, vehicle rollover and/or personal injury.

## Maintenance and Specifications

Tires that are larger or smaller than your vehicle's original tires may also affect the accuracy of your speedometer.

### SNOW TIRES AND CHAINS



Snow tires must be the same size and grade as the tires you currently have on your vehicle.

The tires on your vehicle have all weather treads to provide traction in rain and snow. However, in some climates, you may need to use snow tires or chains.

Follow these guidelines when using snow tires and chains:

- Use only SAE Class S chains with P225/55R16 tires.
- Do not use tire chains with size P235/50R17 tires. Use of SAE Class S chains or other chain types may damage your vehicle.
- Install chains securely, verifying that the chains do not touch any wiring, brake lines or fuel lines.
- Drive cautiously. If you hear the chains rub or bang against your vehicle, stop and re-tighten the chains. If this does not work, remove the chains to prevent damage to your vehicle.
- If possible, avoid fully loading your vehicle.
- Remove the tire chains when they are no longer needed. Do not use tire chains on dry roads.
- The suspension insulation and bumpers will help prevent vehicle damage. Do not remove these components from your vehicle when using snow tires or chains.

### MOTORCRAFT PART NUMBERS

Component	3.0L-4V V6 engine	3.9L-4V V8 engine
Air filter element	FA-1679	FA-1679
Fuel filter	FG-1011	FG-1011
Battery (standard)	BXT-66-650	BXT-66-650
Battery (optional)	BXT-66-750	BXT-66-750
Oil filter	FL-400S	FL-218
PCV valve	EV-257	N/A
Spark plugs*	AGSF-22FSM	AGSP-32F

\* Refer to Vehicle Emissions Control Information (VECI) decal for spark plug information.

## Maintenance and Specifications

### REFILL CAPACITIES

Fluid	Ford Part Name	Application	Capacity
Brake fluid	Motorcraft High Performance DOT 3 Motor Vehicle Brake Fluid <sup>1</sup>	All	Fill to MAX line on reservoir
Engine oil (includes filter change) <sup>6</sup>	Motorcraft SAE 5W-20 Premium Synthetic Blend Motor Oil (US)	3.0L-4V V6 engine	6.5L (6.9 quarts)
	Motorcraft SAE 5W-20 Super Premium Motor Oil (Canada)	3.9L-4V V8 engine	6.2L (6.5 quarts)
Engine coolant <sup>2</sup>	Motorcraft Premium Gold Engine Coolant (yellow-colored)	3.0L-4V V6 engine	10.6L (11.2 quarts)
		3.9L-4V V8 engine	11.3L (11.9 quarts)
Power steering fluid	Motorcraft MERCON® ATF	All	Fill to MAX line on reservoir
Rear axle <sup>3</sup>	Motorcraft SAE 75W-140 High Performance Synthetic Rear Axle Lubricant	All	1.2-1.3L (2.5-2.7 pints)
Fuel tank	N/A	All	68.2L (18.0 gallons)
Transmission fluid <sup>4</sup>	Motorcraft MERCON®V ATF	Automatic (5R55S)	11.2L (11.9 quarts) <sup>5</sup>

## Maintenance and Specifications

Fluid	Ford Part Name	Application	Capacity
Windshield washer fluid	Motorcraft Premium Windshield Washer Concentrate	All	Fill to line on reservoir

<sup>1</sup>Use only brake fluids certified to meet Ford specifications. Refer to *Lubricant Specifications* in this chapter. DOT 3 fluid is recommended. However, if DOT 3 is not available, DOT 4 fluid can be used.

<sup>2</sup>Add the coolant type originally equipped in your vehicle.

<sup>3</sup>Your vehicle's rear axle is filled with a synthetic rear axle lubricant and is considered lubricated for life. These lubricants do not need to be checked or changed unless a leak is suspected, service is required or the axle assembly has been submerged in water. The axle lubricant should be changed any time the rear axle has been submerged in water. Fill 6 mm to 14 mm (1/4 inch to 9/16 inch) below bottom of fill hole.

<sup>4</sup>Ensure the correct automatic transmission fluid is used. MERCON® and MERCON® V are not interchangeable. DO NOT MIX MERCON® and MERCON® V. Refer to the scheduled maintenance guide to determine the correct service interval.

<sup>5</sup>Approximate dry capacity, includes cooler and tubes. Fluid level should be checked by a qualified service technician.

<sup>6</sup>Use of sythetic or sythetic blend motor oil is not mandatory. Engine oil need only meet the requirements of Ford specification WSS-M2C153-H and the API Certification mark.

## Maintenance and Specifications

### LUBRICANT SPECIFICATIONS

Item	Ford part name	Ford part number	Ford specification
Brake fluid	Motorcraft High Performance DOT 3 Motor Vehicle Brake Fluid <sup>1</sup>	PM-1	ESA-M6C25-A and DOT 3
Door weatherstrips	Silicone Lubricant	F5AZ-19553-AA	ESR-M13P4-A
Door latch, hood latch, auxiliary hood latch, door hinges, striker plates, seat tracks and fuel filler door hinge	Multi-Purpose Grease	XG-4 or XL-5	ESR-M1C159-A or ESB-M1C93-B
Engine coolant	Motorcraft Premium Gold Engine Coolant (yellow-colored)	VC-7-A	WSS-M97B51-A1
Engine oil (all engines)	Motorcraft SAE 5W-20 Premium Synthetic Blend Motor Oil (US) Motorcraft SAE 5W-20 Super Premium Motor Oil (Canada)	XO-5W20-QSP (US) CXO-5W20-LSP12 (Canada)	WSS-M2C153-H with API Certification Mark
Lock cylinders	Motorcraft Penetrating and Lock Lubricant	Motorcraft XL-1	none
Power steering fluid	Motorcraft MERCON® ATF	XT-2-QDX	MERCON®

## Maintenance and Specifications

Item	Ford part name	Ford part number	Ford specification
Rear Axle Lubricant	Motorcraft SAE 75W-140 High Performance Synthetic Rear Axle Lubricant <sup>2</sup>	XY-75W140-QL	WSL-M2C192-A
Automatic transmission fluid	Motorcraft MERCON®V ATF <sup>3</sup>	XT-5-QM	MERCON®V
Windshield washer fluid	Ultra-clear Windshield Washer Concentrate	C9AZ-19550-AC	ESR-M17P5-A

<sup>1</sup>Use only brake fluids certified to meet Ford specifications. DOT 3 fluid is recommended. However, if DOT 3 is not available, DOT 4 fluid can be used.

<sup>2</sup>Ford design rear axles contain a synthetic lubricant that does not require changing unless the axle has been submerged in water.

<sup>3</sup>Ensure the correct automatic transmission fluid is used. MERCON® and MERCON® V are not interchangeable. DO NOT MIX MERCON® and MERCON® V. Refer to the scheduled maintenance guide to determine the correct service interval.

### ENGINE DATA

Engine	3.0L-4V V6 engine	3.9L-4V V8 engine
Displacement	2 968 cc (181 cid)	3 949 cc (241 cid)
Required fuel	91 octane	91 octane
Firing order	1-4-2-5-3-6	1-5-4-2-6-3-7-8
Spark plug gap	1.30-1.45 mm (0.051-0.057 inch)	0.99-1.09 mm (0.039-0.043 inch)
Ignition system	Coil on plug	Coil on plug
Compression ratio	10.5:1	10.75:1

## Maintenance and Specifications

### VEHICLE DIMENSIONS

Vehicle dimensions	mm (in)
(1) Overall length	4925 mm (193.9 in)
(2) Overall width	1859 mm (73.2 in)
(3) Overall height	1424 mm (56.0 in)
(4) Wheelbase	2909 mm (114.5 in)
(5) Tread - Front	1540 mm (60.6 in)
(5) Tread - Rear	1543 mm (60.7 in)

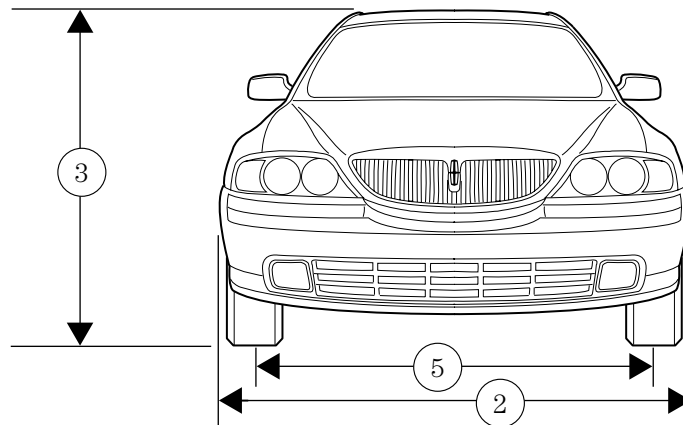

## Maintenance and Specifications

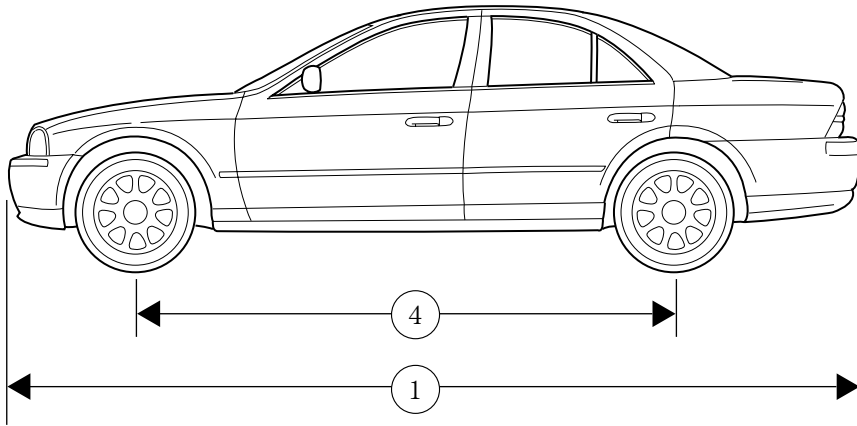

### IDENTIFYING YOUR VEHICLE

#### Certification label

The National Highway Traffic Safety Administration Regulations require that a Certification Label be affixed to a vehicle and prescribe where the Certification Label may be located. The Certification Label is located on the driver's side A-pillar.

<b>MFD. BY FORD MOTOR CO. IN U.S.A.</b>		
DATE: XXXXX	GVWR:XXXXXXXXXX	
FRONT GAWR: XXXXXX/XXXXXXXX		
REAR GAWR: XXXXXX/XXXXXXXX		
THIS VEHICLE CONFORMS TO ALL APPLICABLE FEDERAL MOTOR VEHICLE SAFETY, BUMPER, AND THEFT PREVENTION STANDARDS IN EFFECT ON THE DATE OF MANUFACTURE SHOWN ABOVE.		
VIN: XXXXXXXXXXXXXXXXXXXX		XXXXX
TYPE: XXXXXXXXXXXXXXXXXXXX		XXXXX
EXT PNT: XXXXXX XXXXXX	RC: XX	D50: XXXX
BAR   INT TR   TP/PS   R   AXLE   TR   SPR		
X XX XXX X XX X XXXX		
UPC VF85B-1520472-AB		

## Maintenance and Specifications

### Vehicle identification number (VIN)

The vehicle identification number is attached to a metal tag and is located on the driver side instrument panel. (Please note that in the graphic XXXX is representative of your vehicle identification number.)

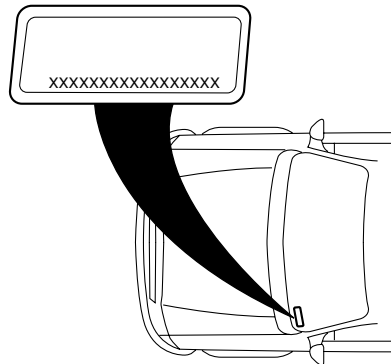

1. World manufacturer identifier
2. Brake type and gross vehicle weight rating (GVWR)
3. Vehicle line, series, body type
4. Engine type
5. Check digit
6. Model year
7. Assembly plant
8. Production sequence number

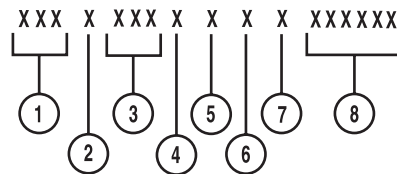

### Engine number

The engine number (the last eight numbers of the vehicle identification number) is stamped on the engine block, transmission, frame and transfer case (if equipped).

### **FORD ACCESSORIES FOR YOUR VEHICLE**

A wide selection of genuine Ford accessories are available for your vehicle through your local authorized Ford, Lincoln, Mercury or Ford of Canada dealer. These quality accessories have been specifically engineered to fulfill your automotive needs; they are custom designed to complement the style and aerodynamic appearance of your vehicle. In addition, each accessory is made from high quality materials and meets or exceeds Ford's rigorous engineering and safety specifications. Ford Motor Company will repair or replace any properly dealer-installed Ford accessory found to be defective in factory-supplied materials or workmanship during the warranty period, as well as any component damaged by the defective accessory. The accessory will be warranted for whichever provides you the greatest benefit:

- 12 months or 20,000 km (12,000 miles) (whichever occurs first), or
- the remainder of your new vehicle limited warranty.

This means that genuine Ford accessories purchased along with your new vehicle and installed by the dealer are covered for the full length of your New Vehicle's Limited Warranty — 3 years or 60,000 km (36,000 miles) (whichever occurs first). Contact your dealer for details and a copy of the warranty.

#### **Not all accessories are available for all models.**

Following is a list of several Ford Genuine Accessory products. Not all accessories are available for all models. To find out what accessories are available for your vehicle, please contact your dealer or visit our online store at: [www.lincolnaccessories.com](http://www.lincolnaccessories.com).

#### **Vehicle Security**

Styled wheel locks

Vehicle security systems

#### **Comfort and convenience**

Cargo nets

Cargo organizers (trunk)

Cargo tray

Electrochromic compass inside mirror

Engine block heater

Remote start system

## Accessories

### Travel equipment

Luggage/cargo basket

Removable roof rack

Removable roof rack adapters (bike, ski, snowboard)

### Protection and appearance equipment

Air bag anti-theft locks

All weather floor mats

Alloy wheels (chrome and painted)

Car cover

Carpet floor mats

First aid kit

Front end covers (mini and full)

Highway safety kit

Molded splash guards

Moon roof air deflector

Park pilot/reverse park aid

Rear spoiler

Side window deflector

For maximum vehicle performance, keep the following information in mind when adding accessories or equipment to your vehicle:

- When adding accessories, equipment, passengers and luggage to your vehicle, do not exceed the total weight capacity of the vehicle or of the front or rear axle (GVWR or GAWR as indicated on the Safety compliance certification label). Consult your dealer for specific weight information.
- The Federal Communications Commission (FCC) and Canadian Radio Telecommunications Commission (CRTC) regulate the use of mobile communications systems - such as two-way radios, telephones and theft alarms - that are equipped with radio transmitters. Any such equipment installed in your vehicle should comply with FCC or CRTC regulations and should be installed only by a qualified service technician.

## Accessories

- Mobile communications systems may harm the operation of your vehicle, particularly if they are not properly designed for automotive use or are not properly installed. When operated, such systems may cause the engine to stumble or stall or cause the transmission to be damaged or operate improperly. In addition, such systems may be damaged or their performance may be affected by operating your vehicle. (Citizens band [CB] transceivers, garage door openers and other transmitters with outputs of five watts or less will not ordinarily affect your vehicle's operation.)
- Ford cannot assume responsibility for any adverse affects or damage that may result from the use of such equipment.

## Index

### A

- Accessory delay .....95
  - AdvanceTrac .....191
  - Air bag supplemental restraint system .....161–162, 166, 169
    - and child safety seats .....163
    - description .....162, 166, 169
    - disposal .....172
    - driver air bag .....164, 167, 171
    - indicator light .....165, 168, 172
    - operation .....164, 167, 171
    - passenger air bag ...164, 167, 171
    - side air bag .....166, 169
  - Air cleaner filter .....269, 275
  - Air conditioning .....72, 74
  - Antifreeze  
(see Engine coolant) .....253
  - Anti-lock brake system  
(see Brakes) .....188–189
  - Anti-theft system .....137
    - arming the system .....138
    - disarming a triggered system .....138
  - Audio system (see Radio) ...16, 20
  - Automatic transmission
    - driving an automatic overdrive .....195
    - fluid, adding .....268
    - fluid, checking .....268
    - fluid, refill capacities .....276
    - fluid, specification .....279
  - Axle
    - lubricant specifications ..278–279
    - refill capacities .....276
- ### B
- Battery .....251
  - acid, treating emergencies ....251
  - jumping a disabled battery ....220
  - maintenance-free .....251
  - replacement, specifications ..275
  - servicing .....251
- ### C
- BeltMinder .....156
  - Brakes .....188
    - anti-lock .....188–189
    - anti-lock brake system (ABS) warning light .....188
    - fluid, checking and adding ....268
    - fluid, refill capacities .....276
    - fluid, specifications .....278–279
    - lubricant specifications ..278–279
    - parking .....189
    - shift interlock .....194
  - Bulbs .....84
  - Capacities for refilling fluids ....276
  - Cargo net .....123
  - Cassette tape player .....16
  - CD-single premium .....20
  - Cell phone use .....110
  - Certification Label .....281
  - Changing a tire .....215
  - Child safety restraints .....173
    - child safety belts .....173
  - Child safety seats .....177
    - attaching with tether straps ..181
    - in front seat .....178
    - in rear seat .....178
  - Cleaning your vehicle
    - engine compartment .....238
    - instrument panel .....240
    - interior .....241
    - interior trim .....241

## Index

- plastic parts .....240
- washing .....237
- waxing .....237
- wheels .....238
- wiper blades .....240
- Climate control (see Air conditioning or Heating) .....72, 74
- Compass, electronic .....96
  - calibration .....97
  - set zone adjustment .....97
- Console .....122
  - overhead .....93
- Controls
  - power seat .....140
  - steering column .....102
- Coolant
  - checking and adding .....253
  - refill capacities .....257, 276
  - specifications .....278–279
- Cruise control (see Speed control) .....99
- Customer Assistance .....204
  - Ford accessories for your vehicle .....242
  - Ford Extended Service Plan .....229
  - Getting assistance outside the U.S. and Canada .....233
  - Getting roadside assistance ...204
  - Getting the service you need .....227
  - Ordering additional owner's literature .....234
  - The Dispute Settlement Board .....230
  - Utilizing the Mediation/Arbitration Program .....233
- D**
  - Daytime running lamps (see Lamps) .....81
  - Defrost
    - rear window .....79
  - Dipstick
    - automatic transmission fluid .....268
    - engine oil .....248
  - Doors
    - central unlocking .....125
    - lubricant specifications .....278
  - Driving under special conditions .....199
    - through water .....201
- E**
  - Emergencies, roadside
    - jump-starting .....220
  - Emergency Flashers .....205
  - Emission control system .....266
  - Engine .....279–280
    - cleaning .....238
    - coolant .....253
    - fail-safe coolant .....257
    - idle speed control .....251
    - lubrication
      - specifications .....278–279
      - refill capacities .....276
      - service points .....246–247
  - Engine block heater .....187
  - Engine oil .....248
    - checking and adding .....248
    - dipstick .....248
    - filter, specifications .....250, 275
    - recommendations .....250
    - refill capacities .....276
    - specifications .....278–279
  - Exhaust fumes .....188

## Index

### F

- Fail safe cooling .....257
- Floor mats .....123
- Fluid capacities .....276
- Foglamps .....81
- Fuel .....259
  - calculating fuel
  - economy .....112, 263
  - cap .....261
  - capacity .....276
  - choosing the right fuel .....261
  - comparisons with EPA fuel
  - economy estimates .....266
  - detergent in fuel .....262
  - filling your vehicle
  - with fuel .....259, 261, 263
  - filter, specifications .....263, 275
  - improving fuel economy .....263
  - octane rating .....262, 279–280
  - quality .....262
  - running out of fuel .....262
  - safety information relating
  - to automotive fuels .....259
- Fuses .....206–207

### G

- Garage door opener .....106
- Gas cap (see Fuel cap) .....261
- Gas mileage  
(see Fuel economy) .....263
- Gauges .....14
- GAWR (Gross Axle  
Weight Rating) .....202
  - definition .....202
  - driving with a heavy load .....202
  - location .....202

### GVWR (Gross Vehicle

- Weight Rating) .....202
  - calculating .....202
  - definition .....202
  - driving with a heavy load .....202
  - location .....202

### H

- Hazard flashers .....205
- Head restraints .....139, 144
- Headlamps .....80
  - aiming .....82
  - autolamp system .....80
  - bulb specifications .....84
  - daytime running lights .....81
  - flash to pass .....82
  - replacing bulbs .....86–87
  - turning on and off .....80
- Heating
  - heating and air conditioning  
system .....72, 74
- HomeLink universal  
transceiver (see Garage  
door opener) .....106–107, 109
- Hood .....245

### I

- Ignition .....185, 279–280
- Infant seats  
(see Safety seats) .....177
- Inspection/maintenance  
(I/M) testing .....267
- Instrument panel
  - cleaning .....240
  - cluster .....10
  - lighting up panel and  
interior .....82

### J

- Jack .....215

## Index

- positioning .....215
- storage .....215
- Jump-starting your vehicle .....220
- K**
- Keyless entry system .....133
  - autolock .....132
- Keys .....124
  - positions of the ignition .....185
  - valet key .....124
- L**
- Lamps
  - autolamp system .....80
  - bulb replacement
  - specifications chart .....84
  - cargo lamps .....82
  - daytime running light .....81
  - fog lamps .....81
  - headlamps .....80
  - headlamps, flash to pass .....82
  - instrument panel, dimming .....82
  - interior lamps .....84–85
  - replacing bulbs .....84, 86–89
- Lane change indicator  
(see Turn signal) .....84
- Lights, warning and indicator ....10
  - anti-lock brakes (ABS) .....188
- Load limits .....202
  - GAWR .....202
  - GVWR .....202
  - trailer towing .....202
- Locks
  - autolock .....132
  - childproof .....126
  - doors .....124
- Lubricant specifications ...278–279
- Lug nuts, anti-theft .....219
- Lumbar support, seats .....140
- M**
- Message center .....110, 112
  - select button .....110
  - warning messages .....114
- Mirrors .....93, 96
  - automatic dimming
    - rearview mirror .....96
    - fold away .....99
  - heated .....98
  - programmable memory .....132
  - side view mirrors (power) .....98
- Moon roof .....105
- Motorcraft parts .....263, 275
- N**
- Navigation system .....24
  - cd functions .....37
  - destination mode .....50
  - map mode .....41
  - quick start .....26
  - radio functions .....30
- O**
- Octane rating .....262
- Oil (see Engine oil) .....248
- P**
- Parking brake .....189
- Parts (see Motorcraft parts) ....275
- Passenger Occupant  
Classification Sensor .....148
- Pedals (see Power  
adjustable foot pedals) .....99
- Power adjustable foot pedals ....99

## Index

- Power distribution box  
(see Fuses) .....210, 213
- Power door locks .....124
- Power steering .....190
  - fluid, checking and adding ....268
  - fluid, refill capacity .....276
  - fluid, specifications .....278–279
- Power Windows .....94
- R**
- Radio .....16, 20
- Rear Park Assist .....199
- Rear window defroster .....79
- Relays .....206
- Remote entry system .....128
  - opening the trunk .....129
- Roadside assistance .....204
- Roof rack .....123
- S**
- Safety Belt Maintenance .....161
- Safety belts (see  
Safety restraints) .....146, 150–155
- Safety defects, reporting .....236
- Safety restraints .....146, 150–155
  - belt minder .....156
  - extension assembly .....160
  - for adults .....151–154
  - for children .....173
  - Occupant Classification  
Sensor .....148
  - safety belt maintenance .....161
  - warning light and  
chime .....155–156
- Safety seats for children .....177
- Seat belts (see  
Safety restraints) .....146
- Seats .....139
  - child safety seats .....177
  - cleaning .....241
  - climate control .....143
  - easy access/easyout  
feature .....141
  - memory seat .....132, 142
- Select Shift Transmission  
(SST) shifter .....197
- Servicing your vehicle .....244
- Spare tire (see  
Changing the Tire) .....216
- Spark plugs,  
specifications .....275, 279–280
- Specification chart,  
lubricants .....278–279
- Speed control .....99
- Starting your vehicle .....185–187
  - jump starting .....220
- Steering
  - speed sensitive .....190
- Steering column lock .....93
- Steering wheel
  - controls .....102
  - tilting .....92
- T**
- Tilt steering wheel .....92
- Tires .....215, 270–272
  - changing .....215–217
  - checking the pressure .....272
  - replacing .....274
  - rotating .....272
  - snow tires and chains .....275
  - tire grades .....271
  - treadwear .....271

## Index

- Towing .....202  
  recreational towing .....203  
  trailer towing .....202  
  wrecker .....226
- Traction control .....190
- Transmission .....194  
  fluid, checking and adding  
  (automatic) .....268  
  fluid, refill capacities .....276  
  lubricant specifications ..278–279
- Trunk .....126  
  remote release .....121, 129
- Turn signal .....84
- V**
- Vehicle dimensions .....280
- Vehicle Identification Number  
(VIN) .....282
- Vehicle loading .....202
- Ventilating your vehicle .....188
- W**
- Warning lights (see Lights) .....10
- Washer fluid .....248
- Water, Driving through .....201
- Windows  
  power .....94
- Windshield washer fluid and  
wipers .....90  
  checking and adding fluid ....248  
  replacing wiper blades .....91
- Wrecker towing .....226









