

Table of Contents

Introduction	4
Instrument Cluster	10
Warning lights and chimes	10
Gauges	14
Entertainment Systems	16
AM/FM stereo with CDX6/MP3	16
Auxiliary input jack (Line in)	22
Satellite radio information	24
Family entertainment system	27
Navigation system	53
Climate Controls	54
Automatic temperature control	54
Rear window defroster	61
Lights	63
Headlamps	63
Turn signal control	67
Bulb replacement	68
Driver Controls	75
Windshield wiper/washer control	75
Steering wheel adjustment	76
Power windows	79
Mirrors	82
Speed control	83
Message center	92
Locks and Security	108
Keys	108
Locks	110
Anti-theft system	123

Table of Contents

Seating and Safety Restraints	129
Seating	129
Safety restraints	140
Airbags	155
Child restraints	170
Tires, Wheels and Loading	181
Tire information	183
Tire inflation	185
Tire Pressure Monitoring System (TPMS)	198
Vehicle loading	202
Trailer towing	208
Recreational towing	212
Driving	214
Starting	214
Brakes	217
Traction Control™/AdvanceTrac®	219
Transmission operation	223
Roadside Emergencies	235
Getting roadside assistance	235
Hazard flasher switch	236
Fuel pump shut-off switch	237
Fuses and relays	237
Changing tires	245
Lug nut torque	251
Jump starting	251
Wrecker towing	257
Customer Assistance	259
Reporting safety defects (U.S. only)	265
Reporting safety defects (Canada only)	265
Cleaning	266

Table of Contents

Maintenance and Specifications	273
Engine compartment	275
Engine oil	277
Battery	281
Engine coolant	283
Fuel information	288
Air filter(s)	302
Part numbers	303
Maintenance product specifications and capacities	304
Engine data	307
Accessories	310
Index	312

All rights reserved. Reproduction by any means, electronic or mechanical including photocopying, recording or by any information storage and retrieval system or translation in whole or part is not permitted without written authorization from Ford Motor Company. Ford may change the contents without notice and without incurring obligation.

Copyright © 2007 Ford Motor Company

Introduction

CALIFORNIA Proposition 65 Warning



WARNING: Engine exhaust, some of its constituents, and certain vehicle components contain or emit chemicals known to the State of California to cause cancer and birth defects or other reproductive harm. In addition, certain fluids contained in vehicles and certain products of component wear contain or emit chemicals known to the State of California to cause cancer and birth defects or other reproductive harm.

PERCHLORATE MATERIAL

Certain components of this vehicle such as airbag modules, seat belt pretensioners, and button cell batteries may contain Perchlorate Material – Special handling may apply for service or vehicle end of life disposal. See www.dtsc.ca.gov/hazardouswaste/perchlorate.

CONGRATULATIONS

Congratulations on acquiring your new Lincoln. Please take the time to get well acquainted with your vehicle by reading this handbook. The more you know and understand about your vehicle, the greater the safety and pleasure you will derive from driving it.

For more information on Ford Motor Company and its products visit the following website:

- In the United States: www.ford.com
- In Canada: www.ford.ca
- In Mexico: www.ford.com.mx
- In Australia: www.ford.com.au

Additional owner information is given in separate publications.

This *Owner's Guide* describes every option and model variant available and therefore some of the items covered may not apply to your particular vehicle. Furthermore, due to printing cycles it may describe options before they are generally available.

Remember to pass on the *Owner's Guide* when reselling the vehicle. It is an integral part of the vehicle.



Fuel pump shut-off switch: In the event of an accident the safety switch will automatically cut off the fuel supply to the engine. The switch can also be activated through sudden vibration (e.g. collision when parking). To reset the switch, refer to the *Fuel pump shut-off switch* in the *Roadside Emergencies* chapter.

Introduction

SAFETY AND ENVIRONMENT PROTECTION

Warning symbols in this guide

How can you reduce the risk of personal injury to yourself or others? In this guide, answers to such questions are contained in comments highlighted by the warning triangle symbol. These comments should be read and observed.

Warning symbols on your vehicle

When you see this symbol, it is imperative that you consult the relevant section of this guide before touching or attempting adjustment of any kind.



Protecting the environment

We must all play our part in protecting the environment. Correct vehicle usage and the authorized disposal of waste, cleaning and lubrication materials are significant steps towards this aim. Information in this respect is highlighted in this guide with the tree symbol.



BREAKING-IN YOUR VEHICLE

Your vehicle does not need an extensive break-in. Try not to drive continuously at the same speed for the first 1,000 miles (1,600 km) of new vehicle operation. Vary your speed frequently in order to give the moving parts a chance to break in.

Drive your new vehicle at least 500 miles (800 km) before towing a trailer. Additionally, during the first 500 miles (800 km) that you tow a trailer, do not drive over 70 mph (112 km/h) and do not make starts at full throttle. This style of driving will help the engine and other parts of your vehicle break in at the heavier loads. For more detailed information about towing a trailer, refer to *Trailer towing* in the *Tires, Wheels and Loading* chapter.

Do not add friction modifier compounds or special break-in oils during the first few thousand miles (kilometers) of operation, since these additives may prevent piston ring seating. See *Engine oil* in the *Maintenance and Specifications* chapter for more information on oil usage.

Introduction

SPECIAL NOTICES

New Vehicle Limited Warranty

For a detailed description of what is covered and what is not covered by your vehicle's New Vehicle Limited Warranty, refer to the *Warranty Guide* that is provided to you along with your *Owner's Guide*.

Special instructions

For your added safety, your vehicle is fitted with sophisticated electronic controls.



Please read the section *Airbag supplemental restraint system (SRS)* in the *Seating and Safety Restraints* chapter. Failure to follow the specific warnings and instructions could result in personal injury.



Front seat mounted rear-facing child or infant seats should **NEVER** be placed in front of an active passenger airbag.

Service Data Recording

Service data recorders in your vehicle are capable of collecting and storing diagnostic information about your vehicle. This potentially includes information about the performance or status of various systems and modules in the vehicle, such as engine, throttle, steering or brake systems. In order to properly diagnose and service your vehicle, Ford Motor Company, Ford of Canada, and service and repair facilities may access vehicle diagnostic information through a direct connection to your vehicle when diagnosing or servicing your vehicle.

Event Data Recording

Other modules in your vehicle — event data recorders — are capable of collecting and storing data during a crash or near crash event. The recorded information may assist in the investigation of such an event. The modules may record information about both the vehicle and the occupants, potentially including information such as:

- how various systems in your vehicle were operating;
- whether or not the driver and passenger seatbelts were buckled;
- how far (if at all) the driver was depressing the accelerator and/or the brake pedal;
- how fast the vehicle was traveling; and

Introduction

- where the driver was positioning the steering wheel.

To access this information, special equipment must be directly connected to the recording modules. Ford Motor Company and Ford of Canada do not access event data recorder information without obtaining consent, unless pursuant to court order or where required by law enforcement, other government authorities or other third parties acting with lawful authority. Other parties may seek to access the information independently of Ford Motor Company and Ford of Canada.

Cell phone use

The use of Mobile Communications Equipment has become increasingly important in the conduct of business and personal affairs. However, drivers must not compromise their own or others' safety when using such equipment. Mobile Communications can enhance personal safety and security when appropriately used, particularly in emergency situations. Safety must be paramount when using mobile communications equipment to avoid negating these benefits.

Mobile Communication Equipment includes, but is not limited to cellular phones, pagers, portable email devices, in-vehicle communications systems, telematics devices and portable two-way radios.



Driving while distracted can result in loss of vehicle control, accident and injury. Ford strongly recommends that drivers use extreme caution when using any device that may take their focus off the road. The drivers primary responsibility is the safe operation of their vehicle. Only use cell phones and other devices not essential to the driving task when it is safe to do so.







Export unique (Non–United States/Canada) vehicle specific information

For your particular global region, your vehicle may be equipped with features and options that are different from the ones that are described in this *Owner's Guide*. A market unique supplement may be supplied that complements this book. By referring to the market unique supplement, if provided, you can properly identify those features, recommendations and specifications that are unique to your vehicle. This *Owner's Guide* is written primarily for the U.S. and Canadian Markets. Features or equipment listed as standard may be different on units built for Export. **Refer to this Owner's Guide for all other required information and warnings.**

Introduction













These are some of the symbols you may see on your vehicle.

Vehicle Symbol Glossary

Safety Alert		See Owner's Guide	
Fasten Safety Belt		Airbag - Front	
Airbag - Side		Child Seat	
Child Seat Installation Warning		Child Seat Lower Anchor	
Child Seat Tether Anchor		Brake System	
Anti-Lock Brake System		Brake Fluid - Non-Petroleum Based	
Powertrain Malfunction		Speed Control	
Master Lighting Switch		Hazard Warning Flasher	
Fog Lamps-Front		Fuse Compartment	
Fuel Pump Reset		Windshield Wash/Wipe	
Windshield Defrost/Demist		Rear Window Defrost/Demist	

Introduction

Vehicle Symbol Glossary

Power Windows Front/Rear		Power Window Lockout	
Child Safety Door Lock/Unlock		Interior Luggage Compartment Release Symbol	
Panic Alarm		Engine Oil	
Engine Coolant		Engine Coolant Temperature	
Do Not Open When Hot		Battery	
Avoid Smoking, Flames, or Sparks		Battery Acid	
Explosive Gas		Fan Warning	
Power Steering Fluid		Maintain Correct Fluid Level	
Emission System		Engine Air Filter	
Passenger Compartment Air Filter		Jack	
Check Fuel Cap		Low Tire Pressure Warning	

Instrument Cluster

WARNING LIGHTS AND CHIMES

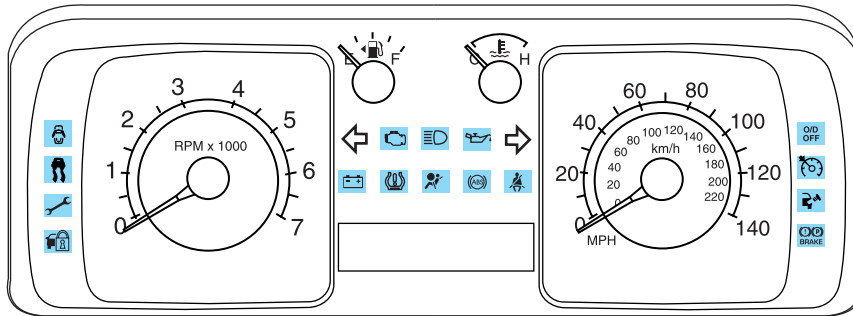

Warning lights and gauges can alert you to a vehicle condition that may become serious enough to cause extensive repairs. A warning light may illuminate when a problem exists with one of your vehicle's functions. Many lights will illuminate when you start your vehicle to make sure the bulbs work. If any light remains on after starting the vehicle, refer to the respective system warning light for additional information.

Service engine soon: The *Service engine soon* indicator light

illuminates when the ignition is first turned to the ON position to check

the bulb and to indicate whether the vehicle is ready for Inspection/Maintenance (I/M) testing. Normally, the "Service engine soon" light will stay on until the engine is cranked, then turn itself off if no malfunctions are present. However, if after 15 seconds the "Service engine soon" light blinks eight times, it means that the vehicle is not ready for I/M testing. See the *Readiness for Inspection/Maintenance (I/M) testing* in the *Maintenance and Specifications* chapter.

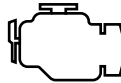

Solid illumination after the engine is started indicates the On Board Diagnostics System (OBD-II) has detected a malfunction. Refer to *On board diagnostics (OBD-II)* in the *Maintenance and Specifications* chapter. If the light is blinking, engine misfire is occurring which could damage your catalytic converter. Drive in a moderate fashion (avoid heavy acceleration and deceleration) and have your vehicle serviced immediately by your authorized dealer.

Instrument Cluster



Under engine misfire conditions, excessive exhaust temperatures could damage the catalytic converter, the fuel system, interior floor coverings or other vehicle components, possibly causing a fire.

Powertrain malfunction/reduced power:

Illuminates when a powertrain or a AWD fault has been detected. Contact your authorized dealer as soon as possible.



Check fuel cap: Illuminates when the fuel cap may not be properly installed. Continued driving with this light on may cause the Check engine warning light to come on, refer to *Fuel filler cap* in the *Maintenance and Specification* chapter.



Brake system warning light: To confirm the brake system warning light is functional, it will momentarily illuminate when the ignition is turned to the ON position



when the engine is not running, or in a position between ON and START, or by applying the parking brake when the ignition is turned to the ON position. If the brake system warning light does not illuminate at this time, seek service immediately from your authorized dealer. Illumination after releasing the parking brake indicates low brake fluid level or a brake system malfunction and the brake system should be inspected immediately by your authorized dealer.



Driving a vehicle with the brake system warning light on is dangerous. A significant decrease in braking performance may occur. It will take you longer to stop the vehicle. Have the vehicle checked by your authorized dealer. Driving extended distances with the parking brake engaged can cause brake failure and the risk of personal injury.

Instrument Cluster

Anti-lock brake system: If the ABS light stays illuminated or continues to flash, a malfunction has been detected, have the system serviced immediately by your authorized dealer. Normal braking is still functional unless the brake warning light also is illuminated.



Airbag readiness: If this light fails to illuminate when ignition is turned to ON, continues to flash or remains on, have the system serviced immediately by your authorized dealer. A chime will also sound when a malfunction in the supplemental restraint system has been detected.



Safety belt: Reminds you to fasten your safety belt. A Belt-Minder® chime will also sound to remind you to fasten your safety belt. Refer to the *Seating and safety restraints* chapter to activate/deactivate the Belt-Minder® chime feature.



Charging system: Illuminates when the battery is not charging properly.



Engine oil pressure: Illuminates when the oil pressure falls below the normal range, refer to *Engine oil* in the *Maintenance and Specifications* chapter.



Traction Control™/AdvanceTrac® active: Illuminates when the Traction Control™ is active. If the light remains on, have the system serviced immediately, refer to the *Driving* chapter for more information.



Low tire pressure warning: Illuminates when your tire pressure is low. If the light remains ON at start up or while driving, the tire pressure should be checked. Refer to *Inspecting and Inflating Your Tires* in the *Tires, Wheels and*

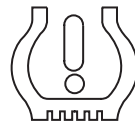

Instrument Cluster

Loading chapter. When the ignition is first turned to ON, the light will illuminate for 3 seconds to ensure the bulb is working. If the light does not turn ON or begins to flash, have the system inspected by your authorized dealer. For more information on this system, refer to *Understanding Your Tire Pressure Monitoring System* in the *Tires, Wheels and Loading* chapter.

Speed control: Illuminates when the speed control is engaged. Turns off when the speed control system is disengaged.



O/D off: Illuminates when the overdrive function of the transmission has been turned OFF, refer to the *Driving* chapter. If the light flashes steadily or does not illuminate, have the transmission serviced soon, or damage may occur.

O/D
OFF

Anti-theft system: Flashes when the SecuriLock[™] Passive Anti-theft System has been activated.



Door ajar: Illuminates when the ignition is in the ON position and any door is open.



Turn signal: Illuminates when the left or right turn signal or the hazard lights are turned on. If the indicators flash faster, check for a burned out bulb.



High beams: Illuminates when the high beam headlamps are turned on.



Key-in-ignition warning chime: Sounds when the key is left in the ignition in the OFF/LOCK or ACCESSORY position and the driver's door is opened.

Headlamps on warning chime: Sounds when the headlamps or parking lamps are on, the ignition is off (the key is not in the ignition) and the driver's door is opened.

Instrument Cluster

Parking brake ON chime: Sounds when the parking brake is left ON and the vehicle is driven. If the warning stays on after the park brake is off, contact your authorized dealer as soon as possible.

Message center activation chime: Sounds when some warning messages appear in the message center display for the first time.

Overspeed chime (if equipped): Sounds when the vehicle speed reaches 75 mph (120 km/h) or higher.

GAUGES

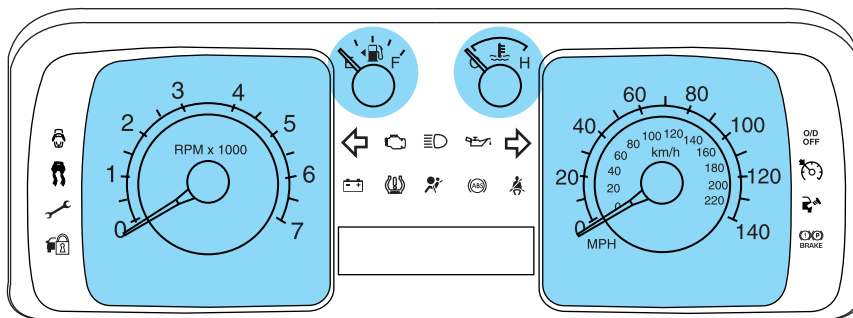

Speedometer: Indicates the current vehicle speed.

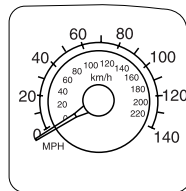

Engine coolant temperature gauge: Indicates engine coolant temperature. At normal operating temperature, the needle will be in the normal range (between “H” and “C”). **If it enters the red section, the engine is overheating. Stop the vehicle as soon as safely possible, switch off the engine and let the engine cool.**

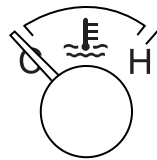

Instrument Cluster



Never remove the coolant reservoir cap while the engine is running or hot.

Fuel gauge: Indicates approximately how much fuel is left in the fuel tank (when the ignition is in the ON position). The fuel gauge may vary slightly when the vehicle is in motion or on a grade.



The FUEL icon and arrow indicates which side of the vehicle the fuel filler door is located.

Refer to *Filling the tank* in the *Maintenance and Specifications* chapter for more information.

Tachometer: Indicates the engine speed in revolutions per minute. Driving with your tachometer pointer continuously at the top of the scale may damage the engine.

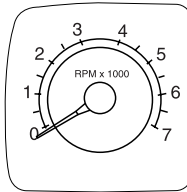

Odometer: Registers the total miles (kilometers) of the vehicle.

Refer to *Message Center* in the *Driver Controls* chapter on how to switch the display from Metric to English.

NW 000000.0 mi

Trip odometer: Registers the miles (kilometers) of individual journeys. Press and release the message center INFO button until “TRIP” appears in the display (this represents the trip mode). Press the control again to select Trip A and Trip B features. Press and hold the RESET button for two seconds to reset.

TRIP A OR B XXX.X mi
NW 000000.0 mi

Entertainment Systems

AUDIO SYSTEMS

AM/FM In-dash six CD/MP3 satellite compatible sound system

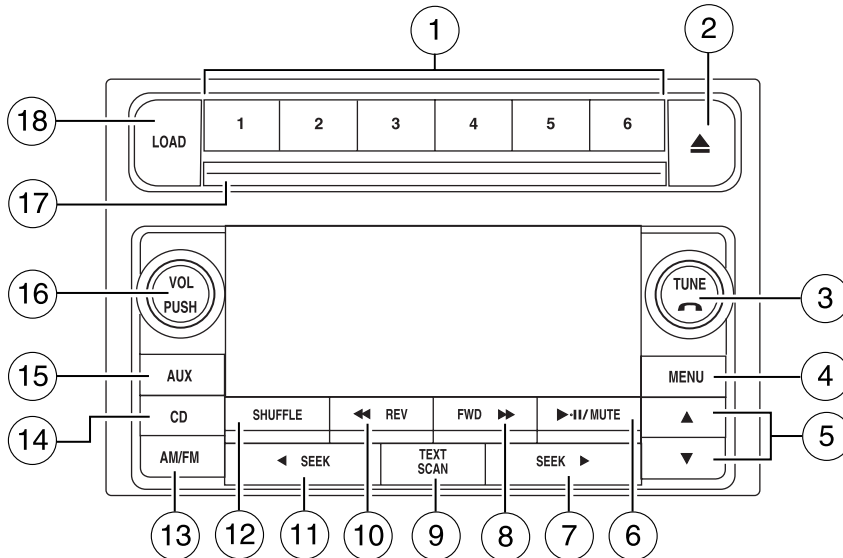

Accessory delay: Your vehicle is equipped with accessory delay. With this feature, the window controls, radio and moon roof (if equipped) may be used for up to ten minutes after the ignition is turned off or until either front door is opened.

THX: Your vehicle may be equipped with the THX® II certified premium audio system. This system creates optimal acoustic quality for all seating positions and road conditions. The system offers an advanced speaker system, amplifier, subwoofer and equalization.



1. Memory presets: To set a station: Select frequency band AM/FM1/FM2; tune to a station, press and hold a preset button until sound returns. PRESET SAVED will appear in the display. You may store up to 18 stations, six presets in AM, FM1 and FM2.

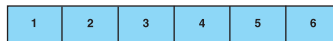

Entertainment Systems

In satellite Radio mode (if equipped), there are 18 available presets, six each for SAT1, SAT2 and SAT3. To save satellite channels in your memory presets, tune to the desired channel then press and hold a preset control until sound returns.

Satellite radio is available only with a valid SIRIUS subscription. Check with your authorized dealer for availability.

2. **▲ (Eject):** Press to eject the current CD/MP3. To eject a specific CD/MP3, press ▲ and the corresponding memory preset. Press and hold ▲ to auto eject all discs in the system.



3. **TUNE:** In radio mode, turn to go up/down the frequency band in individual increments.



In MP3 mode, with folder mode active, turn to advance to the next/previous MP3 folder.

In satellite radio mode (if equipped), press ◀ SEEK, SEEK ▶ to tune to the next/previous channel.

In CATEGORY MODE, press ▲ / ▼ to scroll through the list of available SIRIUS channel categories (Pop, Rock, News, etc.). Refer to *Category Mode* under *Menu* for further information.

Satellite radio is available only with a valid SIRIUS subscription. Check with your authorized dealer for availability.

4. **MENU:** Press MENU repeatedly to scroll through the following modes:



Setting the clock: Press MENU until SET HOURS or SET MINUTES is displayed. Use ▲ / ▼ to manually increase/decrease. Press MENU again to disengage clock mode.

CATEGORY (satellite radio, if equipped): Press MENU until the currently active category appears in the display (CATEGORY MODE). In CATEGORY MODE, press ▲ / ▼ to scroll through the list of available Sirius channel Categories (Pop, Rock, News, etc.) Once you have selected a category, use ◀ SEEK, SEEK ▶ to select the next/previous channel in that specific category. Press and hold the SCAN button to hear a brief sampling of the satellite radio channels in the selected category. Set category to CATEGORY ALL to seek or scan all available

Entertainment Systems

SIRIUS satellite radio channels. To select a different category, press MENU until the category appears in the display. Press ▲ / ▼ to select a different category. You may also select CATEGORY ALL to seek all available Sirius categories and channels.

Satellite radio is available only with a valid SIRIUS subscription. Check with your authorized dealer for availability.

RBDS ON/OFF: Press ▲ / ▼ to turn RBDS ON or OFF.

Program Type: If RBDS is ON, press ▲ / ▼ to find the desired program type, then use ◀ SEEK ▶ or SCAN to search for FM radio stations broadcasting the desired program type.

RBDS (Radio Broadcast Data System): Available in FM mode only. Allows you to search RBDS-equipped stations for certain categories of music or announcements. With RBDS ON, you may select from: Info (Information), Alert, Test, Religious, R&B, Classical, Jazz, Oldies, Country, Top 40, Soft and Rock as described under *Program Type* above. When the desired category appears in the display, press ◀ SEEK, SEEK ▶ to initiate the search. The system will cycle through the FM frequency band searching for stations broadcasting the selected category type. If the desired program type is not found after searching the frequency band three times, the search will stop. The announcement categories are as follows:

- **Alert:** Searches for RBDS stations actively broadcasting important messages relating to weather or government emergencies.
- **Test:** Searches for RBDS stations actively broadcasting a test message.

Autoset: Allows you to set the strongest local radio stations without losing your original manually set preset stations for AM/FM1/FM2.

Use ▲ / ▼ to turn on/off.

When the six strongest stations are filled, the station stored in preset 1 will begin playing. If there are less than six strong stations, the system will store the last one in the remaining presets.

Bass: Press ▲ / ▼ to adjust the bass setting.

Treble: Press ▲ / ▼ to adjust the treble setting.

Balance: Press ▲ / ▼ to adjust the audio between the right and left speakers.

Fade: Press ▲ / ▼ to adjust the audio between the front and rear speakers.

Entertainment Systems

Speed sensitive volume: Radio volume automatically changes slightly with vehicle speed to compensate for road and wind noise. Use ▲ / ▼ to adjust. Recommended level is 1–3. Level 7 is the maximum setting.

Occupancy mode (if equipped): Use ▲ / ▼ to select and optimize sound for ALL SEATS, DRIVERS SEAT or REAR SEATS.

Compression: Available in CD mode, this feature brings soft and loud CD passages together for a more consistent listening level. Press MENU until compression status is displayed. Press ▲ / ▼ to turn the feature on/off.

5. **Select:** These controls are used in Menu mode to select various settings/options.



6. **Play/Pause/Mute: In radio mode,** press to mute the playing media. AUDIO MUTE will appear in the display. Press again to return to the playing media.



In CD/MP3 mode, press to pause the playing media. CDX PAUSE will appear in the display. Press again to return to the playing media.

7. **SEEK ► : In radio or CD/MP3 mode,** press to access the next strong station or track.



In satellite radio mode (if equipped), press SEEK ► to seek to the next channel. If a specific category is selected, (Jazz, Rock, News, etc.), press SEEK ► to seek to the next channel in the selected category. Press and hold SEEK ► to fast seek through the next channels.

In TEXT MODE, press SEEK ► to view the additional display text when “>” is active in the display.

In CATEGORY MODE, press ▲ / ▼ to select a category.

Satellite radio is available only with a valid SIRIUS subscription. Check with your authorized dealer for availability.

8. **FWD (Fast Forward):** Press FWD to manually advance in a CD/MP3 track.



Entertainment Systems

9. **TEXT/SCAN:** In radio mode, when listening to a RBDS-equipped station, press and hold for a brief sampling of radio stations.



In **CD/MP3 mode**, press and release to view the track title, artist name or disc title. Press and hold for a brief sampling of all tracks on the current disc.

In **satellite radio mode (if equipped)**, press and release to enter TEXT MODE and toggle between channel name/channel category and the current song title/artist.

In **TEXT MODE**, sometimes the display requires additional text to be displayed. When the ">" indicator is active, press SEEK ► to view the additional display text. When the "<" indicator is active, press ◀ SEEK to view the previous display text.

10. **REV (Reverse):** Press REV to manually reverse in a CD track.



11. **◀ SEEK:** In radio and CD/MP3 mode, press to access the previous strong station or track.



In **satellite radio mode (if equipped)**, press ◀ SEEK to seek to the previous channel. If a specific category is selected, (Jazz, Rock, News, etc.), press ◀ SEEK to seek to the previous channel in the selected category. Press and hold ◀ SEEK to fast seek through the previous channels.

In **TEXT MODE** press ◀ SEEK to view the previous display text when "<" is active in the display.

Satellite radio is available only with a valid SIRIUS subscription. Check with your authorized dealer for availability.

12. **SHUFFLE:** Press to play all tracks on the current disc in random order.



13. **AM/FM:** Press to select AM/FM1/FM2 frequency band.



14. **CD:** Press to enter CD mode. If a CD is already loaded into the system, CD play will begin where it ended last. If no CD is loaded, NO DISC will appear in the display.



Entertainment Systems

CD units are designed to play commercially pressed 4.75 in (12 cm) audio compact discs only. Due to technical incompatibility, certain recordable and re-recordable compact discs may not function correctly when used in Ford CD players. Dirty, warped or damaged CDs, irregular shaped CDs, CDs with a scratch protection film attached, and CDs with homemade paper (adhesive) labels should not be inserted into the CD player. The label may peel and cause the CD to become jammed. It is recommended that homemade CDs be identified with permanent felt tip marker rather than adhesive labels. Ballpoint pens may damage CDs. Please contact your authorized dealer for further information.

15. **AUX:** Press repeatedly to cycle through FES/DVD (if equipped), LINE IN (auxiliary audio mode) and SAT1, SAT2 and SAT3 modes (satellite radio, if equipped). For location and further information on auxiliary audio mode, refer to *Auxiliary input jack* later in this chapter. *Satellite radio is available only with a valid SIRIUS radio subscription. Check with your authorized dealer for availability.*



16. **ON/OFF/Volume:** Press to turn ON/OFF. Turn to increase/decrease volume.



If the volume is set above a certain level and the ignition is turned off, the volume will come back on at a "nominal" listening level when the ignition switch is turned back on.

17. **CD slot:** Insert a CD/MP3 label side up.



18. **LOAD:** Press to load a CD/MP3. Press LOAD and a memory preset to load to a specific slot. Press and hold to autoload up to six CD/MP3s.



Entertainment Systems

Auxiliary input jack (Line in)

Your vehicle is equipped with an Auxiliary Input Jack (AIJ). The Auxiliary Input Jack provides a way to connect your portable music player to the in-vehicle audio system. This allows the audio from a portable music player to be played through the vehicle speakers with high fidelity. To achieve optimal performance, please observe the following instructions when attaching your portable music device to the audio system.

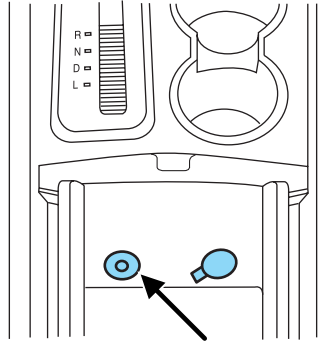

Required equipment:

1. Any portable music player designed to be used with headphones
2. An audio extension cable with stereo male 1/8 in. (3.5 mm) connectors at each end

To play your portable music player using the auxiliary input jack:

1. Begin with the vehicle parked and the radio turned off.
2. Ensure that the battery in your portable music player is new or fully charged and that the device is turned off.
3. Attach one end of the audio extension cable to the headphone output of your player and the other end of the audio extension cable to the AIJ in your vehicle.
4. Turn the radio on, using either a tuned FM station or a CD loaded into the system. Adjust the volume to a comfortable listening level.
5. Turn the portable music player on and adjust the volume to 1/2 the volume.
6. Press AUX on the vehicle radio repeatedly until LINE IN appears in the display.
You should hear audio from your portable music player although it may be low.
7. Adjust the sound on your portable music player until it reaches the level of the FM station or CD by switching back and forth between the AUX and FM or CD controls.

Entertainment Systems

Troubleshooting:

1. Do not connect the audio input jack to a line level output. Line level outputs are intended for connection to a home stereo and are not compatible with the AIJ. The AIJ will only work correctly with devices that have a headphone output with a volume control.
2. Do not set the portable music player's volume level higher than is necessary to match the volume of the CD or FM radio in your audio system as this will cause distortion and will reduce sound quality. Many portable music players have different output levels, so not all players should be set at the same levels. Some players will sound best at full volume and others will need to be set at a lower volume.
3. If the music sounds distorted at lower listening levels, turn the portable music player volume down. If the problems persists, replace or recharge the batteries in the portable music player.
4. The portable music player must be controlled in the same way manner when it is used with headphones as the AIJ does not provide control (play, pause, etc.) over the attached portable music player.
5. For safety reasons, connecting or adjusting the settings on your portable music player should not be attempted while the vehicle is moving. Also, the portable music player should be stored in a secure location, such as the center console or the glove box, when the vehicle is in motion. The audio extension cable must be long enough to allow the portable music player to be safely stored while the vehicle is in motion.

GENERAL AUDIO INFORMATION

Radio frequencies:

AM and FM frequencies are established by the Federal Communications Commission (FCC) and the Canadian Radio and Telecommunications Commission (CRTC). Those frequencies are:

AM: 530, 540–1700, 1710 kHz

FM: 87.7, 87.9–107.7, 107.9 MHz

Radio reception factors:

There are three factors that can affect radio reception:

- Distance/strength: The further you travel from an FM station, the weaker the signal and the weaker the reception.
- Terrain: Hills, mountains, tall buildings, power lines, electric fences, traffic lights and thunderstorms can interfere with your reception.
- Station overload: When you pass a broadcast tower, a stronger signal may overtake a weaker one and play while the weak station frequency is displayed.

Entertainment Systems

CD/CD player care

Do:

- Handle discs by their edges only. Never touch the playing surface.
- Inspect discs before playing. Clean only with an approved CD cleaner and wipe from the center out.

Don't:

- Expose discs to direct sunlight or heat sources for extended periods of time.
- Clean using a circular motion.

CD units are designed to play commercially pressed 4.75 in (12 cm) audio compact discs only. Due to technical incompatibility, certain recordable and re-recordable compact discs may not function correctly when used in Ford CD players. Irregular shaped CDs, CDs with a scratch protection film attached, and CDs with homemade paper (adhesive) labels should not be inserted into the CD player. The label may peel and cause the CD to become jammed. It is recommended that homemade CDs be identified with permanent felt tip marker rather than adhesive labels. Ballpoint pens may damage CDs. Please contact your authorized dealer for further information.

Audio system warranty and service

Refer to the *Warranty Guide* for audio system warranty information. If service is necessary, see your dealer or qualified technician.

Satellite radio information (if equipped)

Satellite radio channels: SIRIUS broadcasts a variety of music, news, sports, weather, traffic and entertainment satellite radio channels. For more information and a complete list of SIRIUS satellite radio channels, visit www.sirius.com in the United States, www.sirius-canada.ca in Canada, or call SIRIUS at 1-888-539-7474.

Satellite radio reception factors: To receive the satellite signal, your vehicle has been equipped with a satellite radio antenna located on the roof of your vehicle. The vehicle roof provides the best location for an unobstructed, open view of the sky, a requirement of a satellite radio system. Like AM/FM, there are several factors that can affect satellite radio reception performance:

- Antenna obstructions: For optimal reception performance, keep the antenna clear of snow and ice build-up and keep luggage and other material as far away from the antenna as possible.

Entertainment Systems

- Terrain: Hills, mountains, tall buildings, bridges, tunnels, freeway overpasses, parking garages, dense tree foliage and thunderstorms can interfere with your reception.
- Station overload: When you pass a ground based broadcast repeating tower, a stronger signal may overtake a weaker one and result in an audio mute.

Unlike AM/FM audible static, you will hear an audio mute when there is a satellite radio signal interference. Your radio display may display NO SIGNAL to indicate the interference.

SIRIUS satellite radio service: SIRIUS Satellite Radio is a subscription based satellite radio service that broadcasts music, sports, news and entertainment programming. A service fee is required in order to receive SIRIUS service. Vehicles that are equipped with a factory installed SIRIUS Satellite Radio system include:

- Hardware and limited subscription term, which begins on the date of sale or lease of the vehicle.
- Online media player providing access to all 65 SIRIUS music channels over the internet (U.S. customers only).

For information on extended subscription terms, contact SIRIUS at 1-888-539-7474.

Note: SIRIUS reserves the unrestricted right to change, rearrange, add or delete programming including canceling, moving or adding particular channels, and its prices, at any time, with or without notice to you. Ford Motor Company shall not be responsible for any such programming changes.

Satellite Radio Electronic Serial Number (ESN): This 12-digit Satellite Serial Number is needed to activate, modify or track your satellite radio account. You will need this number when communicating with SIRIUS. While in Satellite Radio mode, you can view this number on the radio display by pressing AUX and Preset 1 control simultaneously.

Entertainment Systems

Radio Display	Condition	Action Required
ACQUIRING	Radio requires more than two seconds to produce audio for the selected channel.	No action required. This message should disappear shortly.
SAT FAULT	Internal module or system failure present.	If this message does not clear within a short period of time, or with an ignition key cycle, your receiver may have a fault. See your authorized dealer for service.
INVALID CHNL	Channel no longer available.	This previously available channel is no longer available. Tune to another channel. If the channel was one of your presets, you may choose another channel for that preset button.
UNSUBSCRIBED	Subscription not available for this channel.	Contact SIRIUS at 1-888-539-7474 to subscribe to the channel or tune to another channel.
NO TEXT	Artist information not available.	Artist information not available at this time on this channel. The system is working properly.

Entertainment Systems

Radio Display	Condition	Action Required
NO TEXT	Song title information not available.	Song title information not available at this time on this channel. The system is working properly.
NO TEXT	Category information not available.	Category information not available at this time on this channel. The system is working properly.
NO SIGNAL	Loss of signal from the SIRIUS satellite or SIRIUS tower to the vehicle antenna.	You are in a location that is blocking the SIRIUS signal (i.e., tunnel, under an overpass, dense foliage, etc). The system is working properly. When you move into an open area, the signal should return.
UPDATING	Update of channel programming in progress.	No action required. The process may take up to three minutes.
CALL SIRIUS 1-888-539-7474	Satellite service has been deactivated by SIRIUS Satellite Radio.	Call SIRIUS at 1-888-539-7474 to re-activate or resolve subscription issues.

FAMILY ENTERTAINMENT DVD SYSTEM (IF EQUIPPED)

Your vehicle may be equipped with a Family Entertainment System (FES) which allows you to listen to audio CDs, MP3 discs, watch DVDs and to plug in and play a variety of standard video game systems. The DVD player is capable of playing standard DVDs, CDs, MP3s and is compatible with CD-R/W, CD-R and certain CD-ROM media.

Please review this material to become familiar with the FES features and controls as well as the very important safety information.

Entertainment Systems

Quick start

Your Family Entertainment System includes a DVD system, two sets of wireless infrared (IR) headphones and a wireless infrared (IR) remote control.

To play a DVD in the DVD system:

The DVD system can play DVD-Video, DVD-R, DVD-R/W discs as well as audio CDs and video CDs. To ensure proper disc operation, check the disc for finger prints, scratches and cleanliness. Clean with a soft cloth, wiping from center to edge.

1. Ensure that the vehicle ignition is in the RUN or ACCESSORY position.

2. Insert a DVD into the system, label-side up to turn on the system.

It will load automatically and begin

to play. If a DVD is already loaded in the system, press PLAY on the DVD player.



The power indicator will turn on automatically indicating the DVD system is ON.



Press VIDEO to change the source displayed on the screen. Press repeatedly to cycle through: DVD-DISC, DVD-AUX, NON-DVD, OFF.



Press the power button to turn the system OFF. The indicator light will turn off indicating the system is off.



Note: The audio from the DVD system will play over all vehicle speakers and can be adjusted by the radio volume control.

To play a CD in the DVD system:

The DVD system can play audio CDs, CD-R and CD-R/W, CD-ROM and video CDs. To ensure proper disc operation, check the disc for finger prints and scratches. Clean the disc with a soft cloth, wiping from the center to the edge.

Entertainment Systems

1. Ensure that the vehicle ignition is in the RUN or ACCESSORY position.

2. Insert a CD into the system, label-side up to turn on the DVD system. It will load and automatically begin to play. If there is already a CD in the system, press PLAY on the DVD player.



3. The disc will begin to play and the 'CD Audio Disc' screen will display. From this screen, you can also select from COMPRESSION, SHUFFLE and SCAN features.



To play an MP3 disc in the DVD system:

1. Ensure that the vehicle ignition is in the RUN or ACCESSORY position.

2. Insert an MP3 disc into the system, label-side up to turn on the DVD system. It will load and automatically begin to play. If there is already a disc in the system, press PLAY on the DVD player.



3. The disc will begin to play and the 'MP3 Audio Disc' screen will display and allow you to access the COMPRESSION, SHUFFLE, SCAN and FOLDER MODE features.



To play an auxiliary source through the DVD system

The DVD system can be used to connect and play auxiliary electronic devices such as game systems, personal camcorders, video cassette recorders, etc.

1. Ensure that the vehicle ignition is in the RUN or ACCESSORY position.

Entertainment Systems

2. Press the power button to turn the DVD system on. The indicator light next to the power button will illuminate.



3. Connect an auxiliary audio/video source by connecting RCA cords (not included) to the RCA jacks on the left hand side of the system.

- Yellow (1) — video input
- White (2) — left channel audio input
- Red (3) — right channel audio input

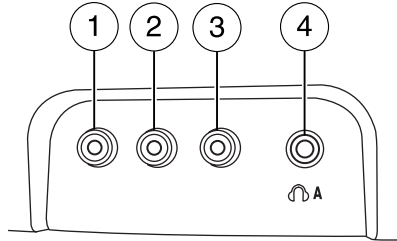

4. Press MEDIA on the DVD system to change the media source to AUX.

5. Press VIDEO on the DVD system to change the video source to DVD-AUX. If your source is properly plugged in, it will appear on the LCD (Liquid Crystal Display) screen. If your auxiliary source does not have a video signal, or if the DVD system does not detect a video signal from the auxiliary source, the screen will remain black. If the video source is set to DVD-AUX, the display will automatically turn on if a video signal is detected.

To listen to audio over the headphones (Dual play mode):

1. You may listen to channels A and B over wired or wireless headphones. Refer to *Using the infrared wireless headphones* and *Using wired headphones* for further information.

- Black (4) — wired headphone output (wired headphones not included)

2. Press the headphone/speaker button on the DVD player.



A green light will illuminate next to either the A or B Headphone Control Button to indicate which channel is active (able to be controlled).

3. Press MEDIA to change the audio source of the active channel (A or B). The audio source will be shown on the display. You may change the active channel by pressing the A or B headphone control button.

Entertainment Systems

Note: Channel A can access any possible media source (AM, FM1, FM2, SAT (if equipped), CD, DVD, AUX). Channel B can only access DVD and AUX sources.



Note: Refer to *Single play/Dual play* for more information.

Using the infrared (IR) wireless headphones:

1. Press the power control on the earpiece to turn the headphones ON.
2. Select Channel A or B for each set of wireless headphones by using the A/B control on the ear piece.
3. Adjust the headphone volume using the rotary dial on the earpiece.

Using wired headphones (not included):

 Do not leave children unattended in the vehicle and do not let children operate the system while unsupervised. If wired headphones or auxiliary systems are used, children may become entangled in the cords and seriously injure themselves.

1. Connect the wired headphones in to the headphone jacks on either side of the DVD system. Each side is labeled  A or  B. Headphones plugged into jack A will listen to Channel A and headphones plugged into jack B will listen to Channel B.
2. Adjust the volume levels using the volume controls on the DVD system.



To adjust display brightness:

To decrease/increase the brightness level on the display screen, press the brightness control on the DVD system. A display will appear at the bottom of the screen indicating the brightness level. The brightness display will only appear when the menu is not displayed.



Entertainment Systems

DVD player controls

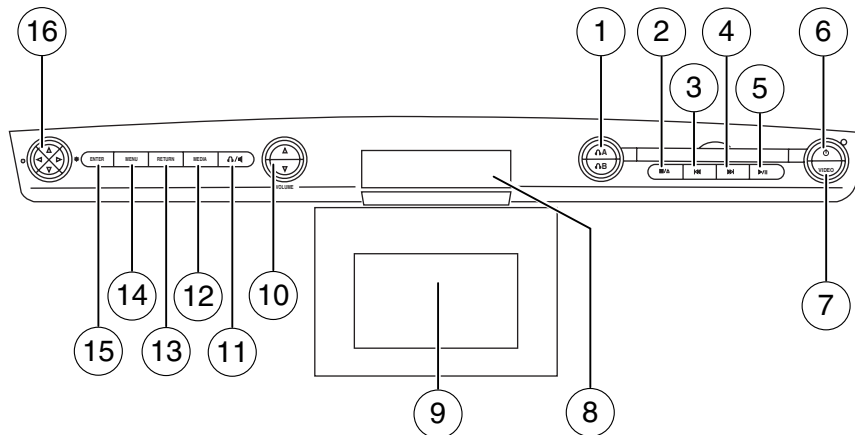

1. **Headphone control A/B:** Press to select either the A or B headphone source. Then press MEDIA to select the desired playing media for that headset. When a headphone channel has been selected (A or B), selections will affect the source on that channel only.



Note: Headphone A can access any possible media (AM, FM1, FM2, SAT (if equipped), CD, CASSETTE, DVD, DVD-AUX). Headphone B can only access DVD and DVD-AUX.

For further information, refer to *Single play/Dual play* later in this section.

2. **■ / ▲ (Stop/Eject):** Press once to stop and press a second time to eject a disc from the DVD system.



3. **◀◀ (Reverse):** Press and release for the previous chapter or track. Press and hold to reverse search a DVD, Video CD, or FES CD in DVD/CD mode.



Entertainment Systems

4. **▶▶** (Fast forward): Press and release for the next chapter or track. Press and hold to forward search a DVD, Video CD, or FES CD in DVD/CD mode.



5. **▶ / ||** (Play/Pause): Press (Play) to select DVD mode (and to turn the DVD system on if it is off). If a disc is present, it will resume or begin to play. Press (Pause) while playing a disc to pause a DVD or CD.



6. **On/Off**: Press to turn the DVD system On/Off.



7. **VIDEO**: Press repeatedly to cycle through the following video state options which will be indicated on the bottom right hand corner of the display: DVD DISC, DVD-AUX, NON-DVD and Off (no indicator). If you select the DVD-AUX video source, the display will turn off if there is no video signal detected. When a video signal is detected on the auxiliary video input, and the display is in the DVD-AUX video mode, the display will automatically turn on.



8. **Infrared (IR) Receiver & Transmitter**: System sensor which reads the signals from the remote control and sends audio signals to the infrared (IR) wireless headphones.

9. **LCD screen**: The eight inch diagonal screen rotates down to view and up into housing to store when not in use. Ensure that the screen is latched into the housing when being stored.

10. **Volume**: When in Single Play, press to increase (▲) or decrease (▼) the volume over all speakers. When in Dual Play, press to increase (▲) or decrease (▼) the



volume for the wired headphones. (Wireless headphone volume is controlled with the rotary dial on the right ear piece.)

Entertainment Systems

11.  (Headphones/Speakers): Press once for Dual Play (Headphone mode- the rear speakers are muted) and press again for Single Play (same media playing through all speakers). For further interaction information, refer to *Single Play/Dual play*.

12. **MEDIA:** Press repeatedly to select from the various possible playing media sources (AM, FM1, FM2, SAT (if equipped), CD, CASSETTE, DVD, DVD-AUX). The media will show in the status display on the top of the screen when in Dual Play mode. When in Single Play mode, the media source will be displayed on the radio.



Note: Channel A can access any possible media source (AM, FM1, FM2, SAT (if equipped), CD, CASSETTE, DVD, DVD-AUX). Channel B can only access DVD and DVD-AUX sources.

13. **RETURN:** Press to return to the playing media or to resume playback.



14. **MENU:** When playing a DVD, press MENU once to enter the DVD disc menu (if available) and press twice to enter the system set-up menu. From the set-up menu, you may select from Angle, Aspect Ratio, Language, Subtitles, Disc resume, Compression, Restore Defaults and Back. For more detailed information, refer to *Menu mode*.



15. **ENTER:** Press to select/confirm the current selection.



16. **Cursor /Brightness controls:**

Use the cursor controls to make various selections when in any menu. When not in a menu, and in DVD mode, press ◀ / ▶ to adjust the brightness. A display bar will appear at the bottom of the screen indicating the brightness levels.

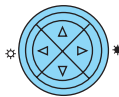

Entertainment Systems

Remote control

Unless otherwise stated, all operations can be carried out with the remote control. Always point the remote control directly at the player. Ensure that there are no obstructions between the remote and player.

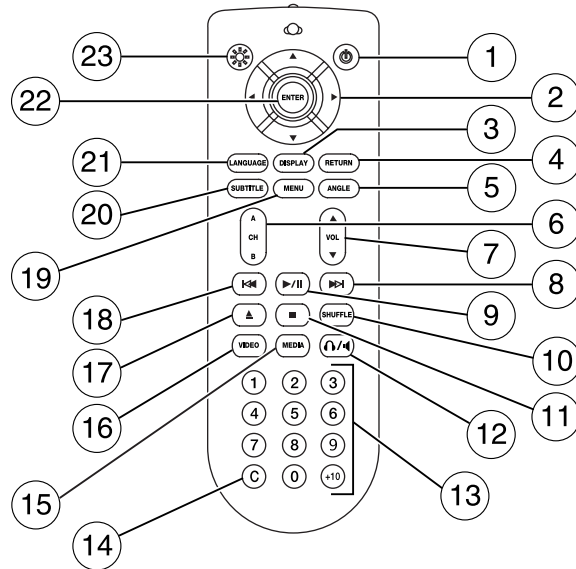

- 1. Power control:** Press to turn the FES (Family Entertainment System) ON/OFF.
- 2. Cursor controls:** Use in various active menus to advance the cursor up/down/left/right. When not in a Menu, the left and right cursor controls decrease and increase the display brightness.
- 3. DISPLAY:** Press to access the on-screen display of the FES functions and adjustments.
- 4. RETURN:** Press to return to the previous menu screen.
- 5. ANGLE (DVD dependent):** Press to select the angle to view the scene.
- 6. Channel A/B:** Press to select either A or B headphones and then use the MEDIA control to select the desired playing media for the headphones.

Entertainment Systems

7. **VOL (Volume):** When in Single Play, press to increase (▲) or decrease (▼) the volume over all speakers. When in Dual Play, press to increase (▲) or decrease (▼) the volume for the wired headphones. (Wireless headphone volume is controlled with the rotary dial on the right ear piece.)
8. **Fast Forward/Next:** In DVD mode, press and hold for a quick advance within the DVD. Press and release to advance to the next chapter. In CD/MP3 mode, press to access the next track.
9. **Play/Pause:** Press to play or pause a DVD.
10. **SHUFFLE:** Press to play all tracks on the current CD/MP3 disc in random order.
11. **STOP:** Press to stop the current DVD or CD/MP3.
12.  **Speaker/Headphone** (Single/Dual Play): Press to toggle between Single Play (same media playing through all speakers) and Dual Play (headphone mode — the rear speakers are muted).
13. **Keypad:** Use the numeric controls to enter in a specific CD/MP3 track or DVD chapter to be played.
14. **C (Cancel):** Press to cancel/clear the numeric input (i.e. chapter number).
15. **MEDIA:** Press to cycle through the possible media sources: AM, FM1, FM2, SAT (if equipped), CD, CASSETTE, DVD, LINE IN (if equipped), DVD-AUX.
Channel B can only access DVD and AUX sources.
16. **VIDEO:** Press to cycle through video states: DVD-DISC, DVD-AUX, NON-DVD, Off.
17. **EJECT:** Press to eject a disc from the FES.
18. **Fast reverse/Previous:** When a DVD is playing, press and hold for a quick reverse within the DVD. Press and release for the previous chapter. Press PLAY to resume normal playback speed and volume. In CD/MP3 mode, press to access the previous track.
19. **MENU:** Press to access the DVD disc menu for selections. Press MENU again when in the DVD disc menu to access the system set-up menu.
20. **SUBTITLE** (DVD dependent): Press to turn the subtitle feature ON or OFF.
21. **LANGUAGE** (DVD dependent): Press to select the desired language.

Entertainment Systems

22. **ENTER:** Press to select the highlighted menu option.

23. **ILLUMINATION:** Press to illuminate the remote control and backlight all of the buttons.

Battery replacement

Batteries are supplied with the remote control unit. Since all batteries have a limited shelf life, replace them when the unit fails to control the DVD player.

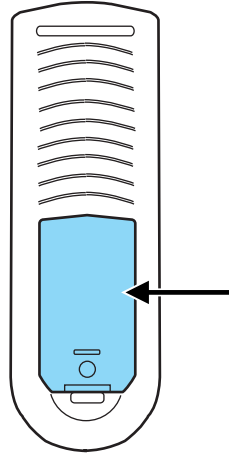

Remove the screw and unlatch the battery cover to access the batteries.
The remote control unit uses two AAA batteries which are supplied with the unit.

Entertainment Systems

Headphones

Wireless headphones

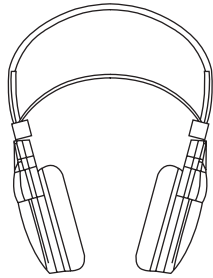

Your FES system is equipped with two sets of battery powered, infrared wireless headphones. Two AAA batteries are needed to operate the headphones. (Batteries are included.)

Additional infrared wireless headphones may be purchased for use with the system. Also, wired headphones may be purchased and plugged in where indicated on the left and right hand sides of the system. Refer to *Wired Headphones* below.

To install the batteries, remove the screw at the bottom of the cover. Then, lightly press down on top and slide the cover off.

When replacing the batteries, use two new batteries (alkaline recommended) and install them with the correct orientation as indicated in the battery housing.

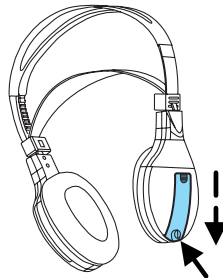

Entertainment Systems

To operate the headphones:

- Press ON/OFF on the ear piece to turn on the headphones. A red indicator light will illuminate indicating the headphones are ON. Press ON/OFF again to turn the headphones off.
- Adjust the headphones to comfortably fit your head using the headband adjustment.
- Select the desired audio source (Channel A or B) for each set of wireless headphones by using the A/B selection switch on the ear piece.
- Adjust the volume control to the desired listening level.

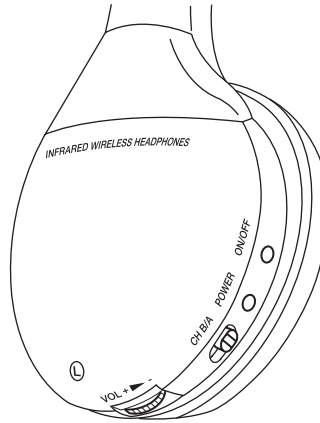

Ensure that the headphones are turned off when not in use. After approximately one minute of not being in use (no infrared signal is received), the wireless headphones will automatically turn off. They will also turn off after two hours of continuous use as a power save feature. If this happens, simply turn the headphones on again and continue use.

Wired headphones



Do not leave children unattended in the vehicle and do not let children operate the system while unsupervised. If wired headphones or auxiliary systems are used, children may become entangled in the cords and seriously injure themselves.

You may purchase wired headphones for your FES (Family Entertainment System). Plug them into the 3.5 mm headphone jack(s) located on the left and right sides of the system. (Channel A is located on the left side and Channel B is located on the right side.) These headphones will be active when in Dual Play mode.

To listen to the audio on wired headphones (not included), connect the wired headphones into the headphone jacks on the sides of the DVD system. The wired headphone jack for Channel A is located on the left side of the FES and is labeled  A. Headphones plugged into this headphone jack will hear audio from the audio source selected to be the

Entertainment Systems

Channel A source. The wired headphone jack for Channel B is located on the right side of the FES and is labeled  B. Headphones plugged into this headphone jack will hear audio from the audio source selected to be the Channel B source.

Adjust the headphone volume using the volume control on the DVD system.



Operation

Single play/Dual play



Your DVD and audio system work together with the infrared headphones and wired headphones (not included) to enable the front and rear seat passengers to listen to a variety of sources a variety of ways.

Single Play: Single play consists of all occupants in the vehicle listening to the same playing media over the front and rear speakers. When the DVD system is on, and the same source is playing through the front and rear speakers, SINGLE PLAY will appear in the front radio display.

Dual Play: Dual play is when the rear seat passengers choose to listen to a different playing media than the front seat passengers. With the DVD and Rear Seat Controls turned ON, the rear seat passengers may choose to listen to the radio, CD, MP3, DVD, or DVD-AUX media sources over headphones while the front speakers play the chosen selection for the front audio system, they may listen to another over the headphones. DUAL PLAY will appear in the radio display.

When both the front seat passengers and the rear seat passengers listen to the same audio source, SHARED MODE will appear on the radio.

Note: If the front seat passengers are listening to the radio, the rear seat passengers can also listen to the radio, however they will be limited to listening to the same radio channel.

Press  /  on the DVD player to listen to audio over the headphones.



The headphone control will now be active and a green light next to the A or B headphone control buttons will illuminate. The system can output two different audio sources over the headphones. These are called Channel A and Channel B. Both Channel A and Channel B can be listened to on the wired headphones (not included) or on the infrared (IR) wireless headphones.

Entertainment Systems

Press the Headphone Control button A to change the audio source for Channel A.



Press MEDIA to change the audio source for Channel A. This information will display on the DVD system screen.



Press the Headphone Control button B to change the audio source for Channel B.



Press MEDIA to change the audio source for Channel B. This information will display on the DVD system screen. Channel B can listen to either the DVD media or the DVD system auxiliary inputs (DVD-AUX).

Operation with an aftermarket audio system (Headphone only mode)

When the Family Entertainment System (FES) detects that the original radio supplied by Ford Motor Company has been removed from the vehicle, the Family Entertainment System will work in a state referred to as "Headphone Only Mode".

While operating in Headphone Only Mode, the system will have limited functionality.

- The system will only output audio to the headphones. It will not be capable of providing audio to the speakers.
- The available sources in FES Headphone Only Mode are DVD-DISC and DVD-AUX, regardless of headphone channel (A or B).
- When a disc is inserted into the FES while in Headphone Only Mode, both headphone channels (A&B) will be connected to FES-DISC.

Entertainment Systems

Menu mode

Press MENU once on the DVD system to access the DVD disc menu if available.

Press MENU twice to access the DVD set-up menu and the following features:

1. ZOOM
2. ANGLE
3. ASPECT RATIO
4. LANGUAGE
5. SUB TITLES

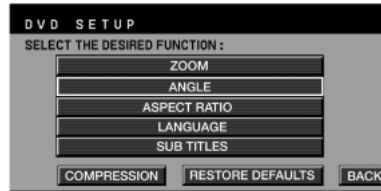

Angle mode

Select ANGLE to select various angles of view for the DVD.

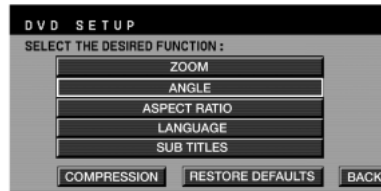

This is disc dependent — some DVD discs may have more viewing angles to select from. Once you have made your selection, press ENTER to confirm. The system default is Angle 1.

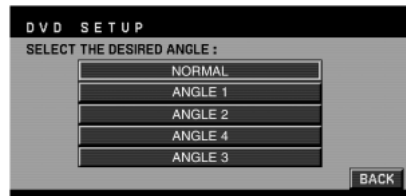

Aspect ratio

Select ASPECT RATIO to select the viewing size and shape of the video displayed on the LCD screen. This is disc dependent.



Entertainment Systems

You can select from: WIDE, LETTER BOX or PAN SCAN. Once you have made your selection, press ENTER to confirm. The LCD screen display will immediately change to your selection after the system resumes playback of the DVD. The system default is WIDE (16:9). This is disc dependent.

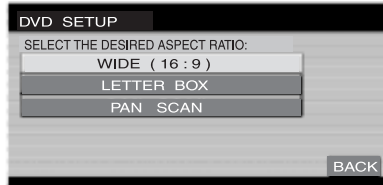

Language

Select LANGUAGE to select the language you would like to use for audio output (English, Spanish, French). This is disc dependent.



Once you have made your selection, press ENTER to confirm. The system default is English.



Subtitles

Select SUBTITLES to turn the subtitle option on or off. The system default is OFF.

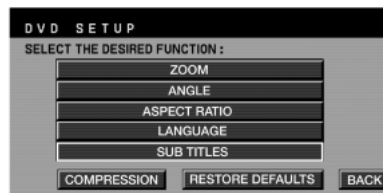

Entertainment Systems

Once you have made your selection, press ENTER to confirm. This is disc dependent.

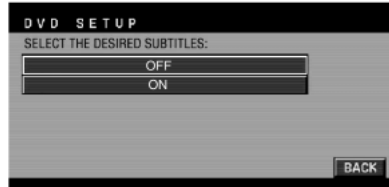

Audio CDs

To play audio CDs on your DVD system:

1. Ensure that the vehicle ignition is in the RUN or ACCESSORY position.
2. Ensure that the DVD system is ON.
3. Insert an audio CD into the DVD system, label side up.

4. The track and elapsed time will appear in the status bar. Use the DVD cursor controls on the bezel to highlight which track you would like to play. You can also use the cursor controls to highlight



COMPRESSION, SHUFFLE or

SCAN. Once you have highlighted

the desired track or function, press ENTER on the DVD bezel to confirm your selection.

COMP (Compression): Compression brings soft and loud CD passages together for a more consistent listening level when in CD mode. Press to turn the feature ON/OFF

SHUFFLE: Press to hear all tracks on the current CD in random order. Press again to stop.

SCAN: Press for a brief sampling of all tracks on the current CD. Press again to stop.

Playing MP3 discs

To play an MP3 disc on your DVD system:

1. Ensure that the vehicle ignition is in the RUN or ACCESSORY position.
2. Ensure that the DVD system is ON.
3. Insert the MP3 disc into the DVD system, label side up.

Entertainment Systems

4. The folder, track and elapsed time will appear in the status bar. The screen will list the Artist, Title, Album and File Name.

COMP (Compression):

Compression brings soft and loud CD/MP3 passages together for a more consistent listening level when in CD mode. Press to turn the feature ON/OFF



SHUFFLE: Press to hear all tracks on the current MP3 folder in random order. Press again to stop.

SCAN: Press for a brief sampling of all tracks on the current MP3 folder. Press again to stop.

FOLDER LIST: Press access folder mode and to go to the previous/next folder in the MP3 disc.

MP3 disc quality factors

Several factors can effect disc playback quality:

- Disc capacity — Each disc contains about 650 MB of storage capacity. We do not recommend using high capacity discs containing 700MB of storage.
- Disc type — Some CD-RW discs may operate inconsistently and may cause an error message to appear. We recommend burning MP3 files onto CD-R discs.
- Disc finalization — The disc may be left open for the purpose of adding sessions to it at a later time, but be sure to close each session or the disc will not play.
- Bit rate — The player supports bit rates from 32–320 kbps, as well as variable bit rate MP3 files, but lower bit rates will have a noticeable effect on sound quality and are recommended only for speech or low fidelity music material. We recommend that you encode MP3 files using a high quality encoder.
- PC configuration — Encoding MP3 files requires intensive use of your computer's resources. Follow the PC configuration recommendations of the encoder software vendor. We recommend that you avoid running other software applications on your PC during MP3 encoding to avoid undesirable noise and distortion.

Entertainment Systems

CD, MP3 and CD player care

- Handle discs by their edges only. Never touch the playing surface.
- Do not expose discs to direct sunlight or heat sources for extended periods of time.
- Do not insert more than one disc into the slot of the CD player (if equipped).
- Always store discs out of direct sunlight. Excessive heat may damage or warp discs.
- Use care when handling and playing CD-R and CD-RW discs, which are more susceptible to damage from heat, light and stress than are regular CDs.
- Always insert and remove a disc by holding the disc flat, with the playing surface facing down, in order to prevent damage to the disc or the player.
- Never insert any object other than a compact disc (CD) or digital versatile disc (DVD) into the player, as doing so may damage the player and may cause injury to you.
- Do not disassemble the player. The laser used in disc playback is extremely harmful to the eyes.

The FES DVD system is designed to play commercially pressed 12 cm (4.75 in) audio compact discs and digital versatile discs (DVD) only. Due to technical incompatibility, certain recordable and re-recordable compact discs may not function correctly when used in Ford CD and DVD players. Irregular shaped CDs or DVDs, CDs or DVDs with a scratch protection film attached, and CDs with homemade paper (adhesive) labels should not be inserted into the FES DVD system. The label may peel and cause the CD or DVD to become jammed. It is recommended that homemade CDs or DVDs be identified with permanent felt tip marker rather than adhesive labels. Ball point pens may damage CDs or DVDs. Please contact your authorized dealer for further information.

Playing a DVD

1. Ensure that the vehicle ignition is in the RUN or ACCESSORY position.
2. Ensure that the navigation system is on.
3. Insert a DVD label-side up into the system.
4. Use the DVD bezel controls to:

Entertainment Systems

Press to play or pause a DVD.



Press to stop or eject a DVD.



Press and release to go to the previous chapter. Press and hold for a fast reverse search.



Press and release to go to the next chapter. Press and hold for a fast forward search.



Press when not in menu mode to adjust brightness, or when in menu mode to navigate through the menu selections.



Press to adjust volume levels.



Slow play

1. With a DVD playing, press pause.



2. Press and hold the reverse or advance button to enter into slow play mode. Once in slow play mode, press and release the reverse or advance button repeatedly to cycle through 1/4 and 1/2. These will display on the status bar on top of the screen as the screens cycle through at this rate.



Frame by frame

1. With a DVD playing, press pause.



2. Press the right cursor button. The DVD will advance one frame. Each press of the right cursor button will advance the DVD video by one frame.



Entertainment Systems

Headphone/auxiliary jacks

There are wired headphones (not included) and auxiliary jacks on the left and right side of your DVD system. They can be used to plug in wired headphones or to connect and play auxiliary electronic devices such as game systems, personal camcorders, video cassette recorders, etc.

On the left side of the system is the Headphone A input jack. This headphone will listen to the media selected on the Channel A source. When you need to make any adjustments to the media, volume, etc, ensure that the Channel A source is highlighted. For more information, refer to *Headphone adjustments*.

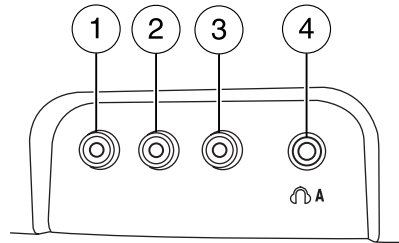

Also located here are the various auxiliary jacks which can be used to plug in a VCR, camcorder, video games, etc. The specific jacks are as follows:

1. Yellow: video input
2. White: left channel audio input
3. Red: right channel audio input
4. Black: wired headphone jack (not included)

The B headphone jack (5) is located on the right side of the DVD system. Plug in wired headphones (not included) here.

Note: The B headphones can only access DVD and AUX modes. They cannot access radio sources.

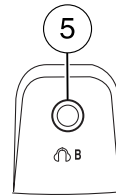

Audio displays

Your DVD system interacts closely with the front audio system. Status messages will appear in the radio display showing the DVD status. Some possible radio display messages:

- SINGLE PLAY or DUAL PLAY
- DVD LOAD
- DVD MENU
- DVD STOP

Entertainment Systems

Audio interaction

You can then also use the front audio controls to advance, reverse, play and pause a DVD. While a DVD is playing you may use the following controls on the front radio:

- **SEEK:** Press to advance to the previous (◀) or next (▶) DVD chapters.
- **▶ ||** : Press to play a DVD or to pause the DVD.

When the radio displays “DVD MENU”, press PLAY on the radio (memory preset #6), to play the disc.

Parental control for the DVD system

Your Family Entertainment System (FES) allows you to have control over the rear seat controls in a few different ways. The DVD system is automatically activated when the vehicle ignition is ON, which allows the rear seat passengers to use the DVD system.

There are three levels of control of the FES buttons. The states are  FULL (enabled), LOCAL or LOCKED (disabled). To change the level of control, press the memory preset controls 3 and 5 simultaneously on the front audio controls. The control level will cycle each time the buttons are pressed simultaneously. The three states are described as:

FULL (enabled): The FES has control over the primary (speaker) and secondary (headphone) audio sources.

LOCAL: The FES has control over the secondary source (headphones) only. The radio will ignore button presses that affect the primary (speaker) audio source.

LOCKED (disabled): The FES buttons are locked and all FES button presses are ignored by the radio and the FES except for load and eject.

When the DVD system is ON, you can then press the memory preset  controls 2 and 4 simultaneously to toggle between Single Play and Dual Play. In Single Play mode, all speakers listen to the same media. In Dual Play mode, rear seat passengers can use the infrared wireless, or wired (not included) headphones to listen to a different playing media than the front seat passengers.

Entertainment Systems

General information

Macrovision: This product incorporates copyright protection technology that is protected by method claims of certain U.S. patents and other intellectual property rights owned by Macrovision Corporation and other rights owners. Use of this copyright protection technology must be authorized by Macrovision Corporation, and is intended for home and other limited viewing uses only unless otherwise authorized by Macrovision Corporation. Reverse engineering or disassembly is prohibited.

MP3: Supply of this product only conveys a license for private, non-commercial use and does not convey a license nor imply any right to use this product in any commercial (i.e. revenue generating) real time broadcasting (terrestrial, satellite, cable and /or any other media) broadcasting/streaming via internet, intranets and/or other networks or in other electronic content distribution systems, such as pay-audio or audio-on-demand applications. An independent license for such use is required. For details, please visit [http:// www.mp3licensing.com](http://www.mp3licensing.com).

Safety information

Read all of the safety and operating instructions before operating the system and retain for future reference.

Do not attempt to service, repair or modify the Family Entertainment System (FES). See your dealer.

Do not insert foreign objects into the DVD compartment.



Do not leave children unattended in the vehicle and do not let children operate the system while unsupervised. If wired headphones or auxiliary systems are used, children may become entangled in the cords and seriously injure themselves.



The front glass on the liquid crystal display (LCD) flip-down screen may break when hit with a hard surface. If the glass breaks, do not touch the liquid crystalline material. In case of contact with skin, wash immediately with soap and water.



The driver should not attempt to operate any function of the DVD system while the vehicle is in motion. Give full attention to driving and to the road. Pull off the road in a safe place before inserting or extracting DVDs from the system. A remote control is included in the system to allow the rear seat occupants to operate the FES functions without distracting the driver.

Entertainment Systems

Do not expose the liquid crystal display (LCD) flip-down screen to direct sunlight or intensive ultraviolet rays for extensive periods of time. Ultraviolet rays deteriorate the liquid crystal.

Be sure to review User Manuals for video games and video game equipment when used as auxiliary inputs for your Family Entertainment System (FES).

Do not operate video games or video equipment if the power cords and/or cables are broken, split or damaged. Carefully place cords and/or cables where they will not be stepped on or interfere with the operation of seats and/or compartments.

Disconnect video games and video equipment power cords and/or cables when not in use.

Avoid touching auxiliary input jacks with your fingers. Do not blow on them or allow them to get wet or dirty.

Do not clean any part of the DVD player with benzene, paint thinner or any other solvent.

Federal Communication Commission (FCC) Compliance

Changes or modifications not approved by Ford Lincoln-Mercury could void user's authority to operate the equipment. This equipment has been tested and found to comply with the limits for a Class B digital device, pursuant to Part 15 of the FCC Rules. These limits are designed to provide reasonable protection against harmful interference in a residential installation. This equipment generates, uses and can radiate radio frequency energy and, if not installed and used in accordance with the instructions, may cause harmful interference and radio communications.

However, there is no guarantee that interference will not occur in a particular installation. If this equipment does cause harmful interference to radio or television reception, which can be determined by turning the equipment off and on, the user is encouraged to consult the dealer or an experienced radio/TV technician for help.

Entertainment Systems

Care and service of the DVD player

Environmental extremes

DVD players which are subjected to harsh environmental conditions may be damaged or perform at less than maximum capability. To avoid these outcomes, whenever possible avoid exposing your DVD player to:

- extremely hot or cold temperatures.
- direct sunlight.
- high humidity.
- a dusty environment.
- locations where strong magnetic fields are generated.

Temperature extremes

When the vehicle is parked under direct sunlight or in an extremely cold place for a long period of time, wait until the cabin temperature of the vehicle is at normal temperature before operating the system.

Humidity and moisture condensation

Moisture in the air will condense in the DVD player under extremely humid conditions or when moving from a cold place to a warm one. Moisture condensation may cause damage to the DVD and/or player. If moisture condensation occurs, do not insert a CD or DVD into the player. If one is already in the player, remove it. Turn the DVD player ON to dry the moisture before inserting a DVD. This could take an hour or more.

Foreign substances

Exercise care to prevent dirt and foreign objects from entering the DVD player compartment. Be especially careful not to spill liquids of any kind onto the media controls or into the system. If liquid is accidentally spilled onto the system, immediately turn the system OFF and consult a qualified service technician.

Cleaning the liquid crystal display (LCD) flip-down screen

Clean the display screen by applying a small amount of water or any ammonia-based household glass cleaner directly to a soft cloth. Rub the screen gently until the dust, dirt or fingerprints are removed. Do not spray the screen directly with water or glass cleaning solvents. Overspray from these fluids could drip down into the internal electronics of the screen and cause damage. Do not apply excessive pressure while cleaning the screen.

Entertainment Systems

Cleaning DVD and CD discs

Inspect all discs for contamination before playing. If necessary, clean discs only with an approved DVD and CD cleaner and wipe from the center out to the edge. Do not use circular motion.

Compatibility with aftermarket audio systems (headphone only mode)

When the Family Entertainment System (FES) detects that the original radio supplied by Ford Motor Company has been removed from the vehicle, the FES will work in a state referred to as "Headphone Only Mode." This mode allows the FES to operate as a standalone system, without interface to the radio.

While operating in Headphone Only Mode, the system will have limited functionality.

- The system will only output audio to the headphones. It will not be capable of providing audio to the speakers.
- The available sources in FES Headphone Only Mode are DVD-DISC and DVD-AUX, regardless of headphone channel (A or B).
- When a disc is inserted into the FES while in Headphone Only Mode, both headphone channels (A and B) will be connected to FES-DISC.

NAVIGATION SYSTEM (IF EQUIPPED)

Your vehicle may be equipped with a Navigation System. Refer to the *Navigation supplement* for further information.

Climate Controls

DUAL AUTOMATIC TEMPERATURE CONTROL (DATC) SYSTEM (IF EQUIPPED)

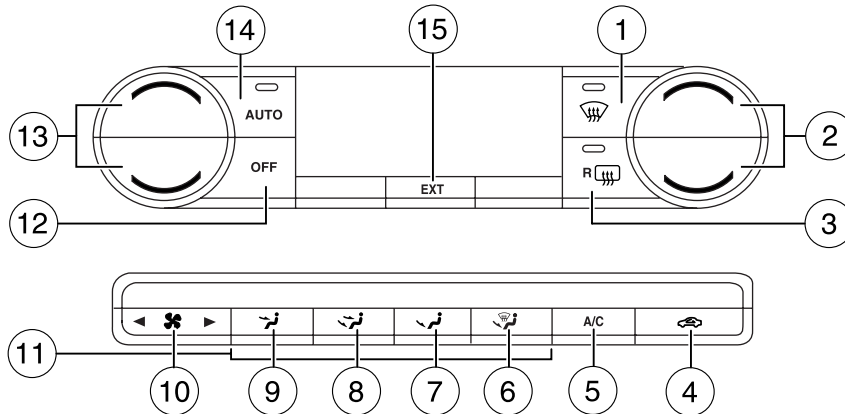







Temperature conversion: To switch between Fahrenheit and Celsius, refer to *Message center* in the *Driver Controls* chapter.

MAX A/C setting: In order to achieve maximum cooling performance, press , A/C, , and set the temperature to 60°F (16°C) and the highest blower setting.

1. **Defrost:** Distributes outside air through the windshield defroster vents and demister vents. Can be used to clear the windshield of fog and thin ice. The system will automatically provide outside air to reduce window fogging. To exit defrost select another mode.
2. **Passenger side temperature control:** Press to increase/decrease the temperature on the passenger side of the vehicle. Allows the passenger to choose and control a different temperature than the driver, if desired.
3. **Rear defroster:** Press to activate/deactivate the rear window defroster. Refer to *Rear window defroster* later in this chapter for more information.
4. **Recirculated air:** Press to activate/deactivate air recirculation in the vehicle. Recirculated air may reduce the amount of time needed to cool down the interior of the vehicle and may also help reduce undesired odors from reaching the interior of the vehicle. Recirculation can be engaged manually in any airflow selection except defrost. Recirculation may turn off automatically in some airflow modes to reduce fog potential.

Climate Controls

5. **A/C:** Press to activate/deactivate air conditioning. Use with recirculated air to improve cooling performance and efficiency. Engages automatically in AUTO,  (defrost) and  (floor/defrost).
6.  : Distributes air through the windshield defroster vents, demister vents, floor vents and rear seat floor vents. The system will automatically provide outside air to reduce window fogging.
7.  : Distributes air through the floor vents and rear seat floor vents. The system will automatically provide outside air to reduce window fogging. **Note:** You may notice a small amount of air flowing from the defroster vents and demister vents.
8.  : Distributes air through the instrument panel vents, center console vents, floor vents and rear seat floor vents.
9.  : Distributes air through the instrument panel vents and center console vents.
10.  **Fan Speed:** Press to manually increase or decrease the fan speed. To return to automatic fan operation, press AUTO.
11. **Manual override controls:** Allows you to manually select where airflow is distributed. To return to full automatic control, press AUTO.
12. **OFF:** Outside air is shut out and the fan will not operate.
13. **Driver side temperature control:** Press to increase/decrease the temperature on the driver side of the vehicle in dual zone or the temperature of both the driver and passenger sides in single zone.
14. **AUTO:** To engage automatic temperature control, press AUTO and select the desired temperature using the temperature control. The system will automatically determine fan speed, airflow distribution, A/C on or off, and outside or recirculated air, to heat or cool the vehicle to reach the desired temperature. Press and hold AUTO for about two seconds to toggle between single zone and dual zone temperature control.
15. **EXT:** Press to display outside temperature. Press again to display cabin temperature settings. **Note:** Exterior readings are more accurate when the vehicle is moving.

Climate Controls

Dual Automatic Temperature Control (DATC) system with heated seats (if equipped)

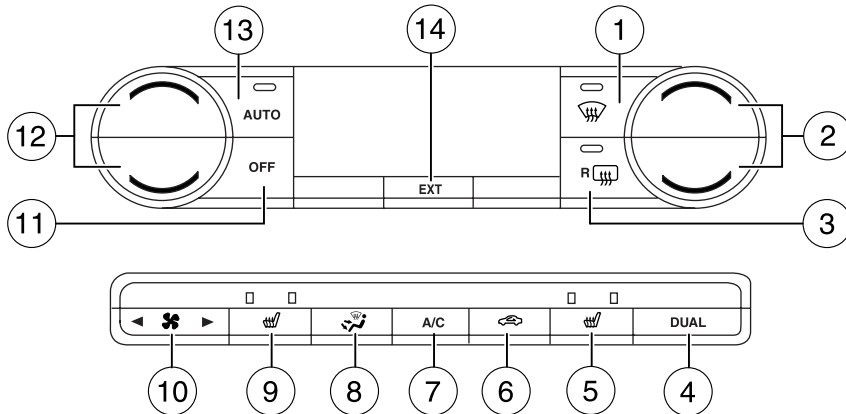











Temperature conversion: To switch between Fahrenheit and Celsius, refer to *Message center* in the *Driver Controls* chapter.

MAX A/C setting: In order to achieve maximum cooling performance, press , A/C, , and set the temperature to 60°F (16°C) and the highest blower setting.

- Defrost:** Distributes outside air through the windshield defroster vents and demister vents. Can be used to clear the windshield of fog and thin ice. The system will automatically provide outside air to reduce window fogging. To exit defrost, select another distribution mode.
- Passenger side temperature control:** Press to increase/decrease the temperature on the passenger side of the vehicle. Allows the passenger to choose and control a different temperature than the driver, if desired.
- Rear defroster:** Press to activate/deactivate the rear window defroster. Refer to *Rear window defroster* later in this chapter for more information.
- DUAL:** Press to engage/disengage separate passenger side temperature control.
- Passenger heated seat:** Press to control the passenger heated seat. Refer to *Heated seats* in the *Seating and Safety Restraints* chapter for more information.

Climate Controls

6.  **Recirculated air:** Press to activate/deactive air recirculation in the vehicle. Recirculated air may reduce the amount of time needed to cool down the interior of the vehicle and may also help reduce undesired odors from reaching the interior of the vehicle. Recirculation can be engaged manually in any airflow selection except defrost. Recirculation may turn off automatically in some airflow modes to reduce fog potential.
7. **A/C:** Press to activate/deactivate air conditioning. Use with recirculated air to improve cooling performance and efficiency. Engages automatically in AUTO,  (defrost) and  (floor/defrost).
8.  **Manual override controls:** Allows you to manually select where airflow is distributed. Press to toggle through the air distribution modes listed below. The selected mode will illuminate in the display. To return to full automatic control, press AUTO.
 -  : Distributes air through the windshield defroster vents, demister vents, floor vents and rear seat floor vents. The system will automatically provide outside air to reduce window fogging.
 -  : Distributes air through the floor vents and rear seat floor vents. The system will automatically provide outside air to reduce window fogging. **Note:** You may notice a small amount of air flowing from the defroster vents and demister vents.
 -  : Distributes air through the instrument panel vents, center console vents, floor vents and rear seat floor vents.
 -  : Distributes air through the instrument panel vents and center console vents.
9.  **Driver heated seat control:** Press to control the driver heated seat. Refer to *Heated seats* in the *Seating and Safety Restraints* chapter for more information.
10.  **Fan Speed:** Press to manually increase or decrease the fan speed. To return to automatic fan operation, press AUTO.
11. **OFF:** Outside air is shut out and the fan will not operate.
12. **Driver side temperature control:** Press to increase/decrease the temperature on the driver side of the vehicle in dual zone or the temperature of both the driver and passenger side in single zone.
13. **AUTO:** To engage automatic temperature control, press AUTO and select the desired temperature using the temperature control. The system will automatically determine fan speed, airflow distribution, A/C on or off, and outside or recirculated air, to heat or cool the vehicle to reach the desired temperature.

Climate Controls

14. **EXT:** Press to display outside temperature. Press again to display cabin temperature settings. **Note:** Exterior readings are more accurate when the vehicle is moving.

Dual Automatic Temperature Control (DATC) system with heated and cooled seats (if equipped)

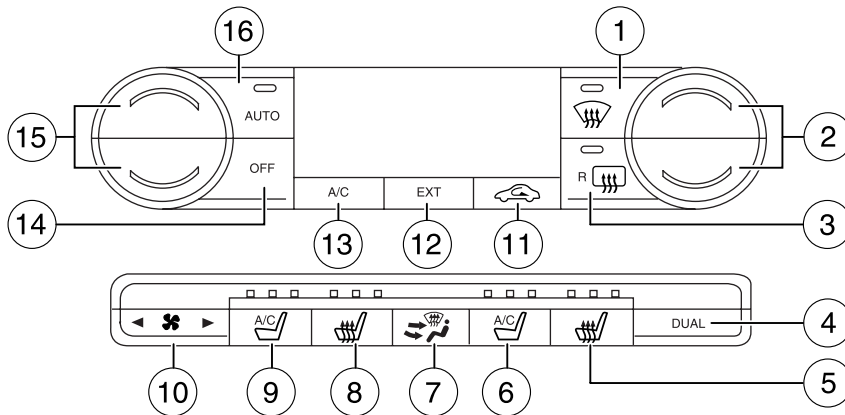











Temperature conversion: To switch between Fahrenheit and Celsius, refer to *Message center* in the *Driver Controls* chapter.



MAX A/C setting: In order to achieve maximum cooling performance, press , A/C, , and set the temperature to 60°F (16°C) and the highest blower setting.

1. **Defrost:** Distributes outside air through the windshield defroster vents and demister vents. Can be used to clear the windshield of fog and thin ice. The system will automatically provide outside air to reduce window fogging. To exit defrost, select another distribution mode.
2. **Passenger side temperature control:** Press to increase/decrease the temperature on the passenger side of the vehicle. Allows the passenger to choose and control a different temperature than the driver, if desired.
3. **Rear defroster:** Press to activate/deactivate the rear window defroster. Refer to the *Rear window defroster* section in this chapter for more information.
4. **DUAL** zone selector: Press to engage/disengage separate passenger side temperature control.

Climate Controls

5.  **Passenger heated seat:** Press to control the passenger heated seat. Refer to *Heated and cooled seats* in the *Seating and Safety Restraints* chapter for more information.
6.  **Passenger cooled seat:** Press to control the passenger cooled seat. Refer to *Heated and cooled seats* in the *Seating and Safety Restraints* chapter for more information.
7.  **Manual override controls:** Allows you to manually select where airflow is distributed. Press to toggle through the air distribution modes listed below. The selected mode will illuminate in the display. To return to full automatic control, press AUTO.
 -  : Distributes air through the windshield defroster vents, demister vents, floor vents and rear seat floor vents. The system will automatically provide outside air to reduce window fogging.
 -  : Distributes air through the floor vents and rear seat floor vents. The system will automatically provide outside air to reduce window fogging. **Note:** You may notice a small amount of air flowing from the demister and defroster vents.
 -  : Distributes air through the instrument panel vents, center console vents, floor vents and rear seat floor vents.
 -  : Distributes air through the instrument panel vents and center console vents.
8.  **Driver heated seat:** Press to control the driver heated seat. Refer to *Heated and cooled seats* in the *Seating and Safety Restraints* chapter for more information.
9.  **Driver cooled seat:** Press to control the driver cooled seat. Refer to *Heated and cooled seats* in the *Seating and Safety Restraints* chapter for more information.
10.  **Fan Speed:** Press to manually increase or decrease the fan speed. To return to automatic fan operation, press AUTO.
11.  **Recirculated air:** Press to activate/deactivate air recirculation in the vehicle. Recirculated air may reduce the amount of time need to cool down the interior of the vehicle and may also help reduce undesired odors from reaching the interior of the vehicle. Recirculation can be engaged manually in any airflow selection except defrost. Recirculation may turn off automatically in some airflow modes to reduce fog potential.
12. **EXT:** Press to display outside temperature. Press again to display cabin temperature settings. **Note:** Exterior readings are more accurate when the vehicle is moving.

Climate Controls



13. **A/C:** Press to activate/deactivate air conditioning. Use with recirculated air to improve cooling performance and efficiency. Engages automatically in AUTO,  (defrost) and  (floor/defrost).

14. **OFF:** Outside air is shut out and the fan will not operate.

15. **Driver side temperature control:** Press to increase/decrease the temperature on the driver side of the vehicle in dual zone or the temperature of both the driver and passenger sides in single zone.

16. **AUTO:** To engage automatic temperature control, press AUTO and select the desired temperature using the temperature control. The system will automatically determine fan speed, airflow distribution, A/C on or off, and outside or recirculated air, to heat or cool the vehicle to reach the desired temperature.

Operating tips





- To reduce fog build up on the windshield during humid weather, select  (defrost) or  (floor/defrost).
- To reduce humidity build up inside the vehicle, do not drive with the system OFF or with  (recirculated air) engaged and A/C off.
- Do not put objects under the front seats that will interfere with the airflow to the back seats.
- Remove any snow, ice or leaves from the air intake area at the base of the windshield.
- To improve the A/C cool down, drive with the windows slightly open for 2-3 minutes after start up or until the vehicle has been “aired out.”

For maximum cooling performance in MAX A/C mode:

• Automatic operation:

1. Press AUTO for full automatic operation.
2. Do not override A/C or  (recirculated air).
3. Set the temperature to 60°F (16°C).

• Manual operation:

1. Select  or .
2. Select A/C and  (recirculated air). Use  (recirculated air) with A/C to provide colder airflow.
3. Set the temperature to 60°F (16°C).

Climate Controls

4. Set highest fan setting initially, then adjust to maintain comfort.

To aid in side window defogging/demisting in cold weather:

1. Select .
2. Select A/C.
3. Adjust the temperature control to maintain comfort.
4. Set the fan speed to the highest setting.
5. Direct the outer instrument panel vents towards the side windows.

To increase airflow to the outer instrument panel vents, close the vents located in the middle of the instrument panel.



Do not place objects on top of the instrument panel as these objects may become projectiles in a collision or sudden stop.

REAR WINDOW DEFROSTER

The rear defroster control is located on the climate control panel and works to clear the rear window of fog and thin ice.

The ignition must be in the 3 (RUN) position to operate the rear window defroster.

Press the control to turn the rear window defroster on. An indicator light on the button will illuminate when active. The rear window defroster turns off automatically after 10 minutes or when the ignition is turned to the 1 (LOCK) or 2 (ACC) position. To manually turn off the rear window defroster at any time, press the control again.

If your vehicle is equipped with both rear defroster and heated mirrors, the same button will activate both.

Do not use razor blades or other sharp objects to clean the inside of the rear window or to remove decals from the inside of the rear window. This may cause damage to the heated grid lines and will not be covered by your warranty.

Climate Controls

CABIN AIR FILTER

The cabin air filter element is designed to reduce the concentration of airborne particles such as dust, spores and pollen in the air being supplied to the interior of the vehicle. The presence of a particulate filter element provides the following benefits:



- Improves the your driving comfort by reducing particle concentration.
- Improves the interior compartment cleanliness.
- Protects the climate control components from particle deposits.

Note: A cabin air filter must be installed at all times to prevent foreign objects from entering the system. Running the system without a filter in place could result in degradation or damage to the system.

The access door for the filter is located behind the glove box. For replacement intervals regarding the cabin air filter, see the *scheduled maintenance information*. For more information regarding your filter, see your authorized dealer.

Lights

HEADLAMP CONTROL

Rotate the headlamp control to the first position  to turn on the parking lamps. Rotate to the second position  to turn on the headlamps.

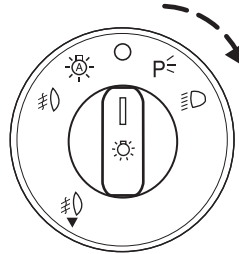

Adaptive headlamps (if equipped)

The headlamp beams move in the same direction as the steering wheel which provides more visibility when driving around curves.

Note: The system has a power-up movement check feature. When the vehicle is started, the lamps track left to right, then back to center to alert the driver that the system is working properly.

Autolamp control

The autolamp system provides light sensitive automatic on-off control of the exterior lights normally controlled by the headlamp control.

The autolamp system also keeps the lights on for approximately 20 seconds or, if equipped with a message center, you can select a delay from 0–180 seconds, after the ignition switch is turned to OFF.

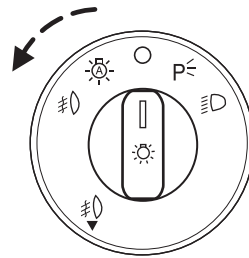

- To turn autolamps on, rotate the control counterclockwise.
- To turn autolamps off, rotate the control clockwise to OFF.

Note: Some vehicles may be equipped with a *headlamps on with windshield wipers feature*. If the windshield wipers are turned on (for a fixed period of time) the exterior lamps will turn on with headlamp control in the Autolamp position.



Lights

Foglamp control

The headlamp control also operates the foglamps. The foglamps can be turned on when the headlamp control is in the ,  or  positions and the high beams are not turned on.

Pull headlamp control towards you to turn foglamps on. The foglamp indicator light  will illuminate.

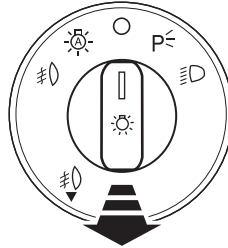

High beams

Push the lever toward the instrument panel to activate. Pull the lever towards you to deactivate.

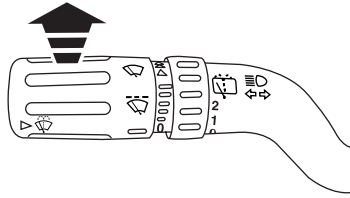

Flash to pass

Pull toward you slightly to activate and release to deactivate.

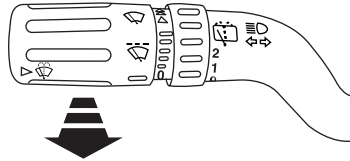

Daytime running lamps (DRL) (if equipped)

Turns the headlamps on at reduced intensity output. To activate:

- the ignition must be in the ON position and
- the headlamp control must be in the OFF or Parking lamps position.

Lights

 Always remember to turn on your headlamps at dusk or during inclement weather. The Daytime Running Lamp (DRL) system does not activate the tail lamps and generally may not provide adequate lighting during these conditions. Failure to activate your headlamps under these conditions may result in a collision.

PANEL DIMMER CONTROL

Use to adjust the brightness of the instrument panel and all applicable switches in the vehicle during headlamp and parklamp operation.

Move the control to the full upright position, past detent, to turn on the interior lamps.

At dusk and dawn, the brightness are illuminated to higher than normal intensity to enhance contrast and visibility. The system automatically “dims down” as ambient light reaches the dash-mounted sensor. The interior control lights dim progressively in four steps until they reach nighttime operating levels. Certain displays like the message center and the climate control unit do not change with the dimmer control till the dash-mounted sensor senses full night conditions.

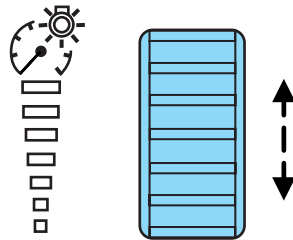

AIMING THE HEADLAMPS

The headlamps on your vehicle are properly aimed at the assembly plant.

If your vehicle has been in an accident the alignment of your headlamps should be checked by your authorized dealer.

Vertical aim adjustment

1. Park the vehicle directly in front of a wall or screen on a level surface, approximately 25 feet (7.6 meters) away.

Lights

- (1) 8 feet (2.4 meters)
- (2) Center height of lamp to ground
- (3) 25 feet (7.6 meters)
- (4) Horizontal reference line

2. Measure the height of the headlamp bulb center from the ground and mark an 8 foot (2.5 meter) horizontal reference line on the vertical wall or screen at this height (a piece of masking tape works well).

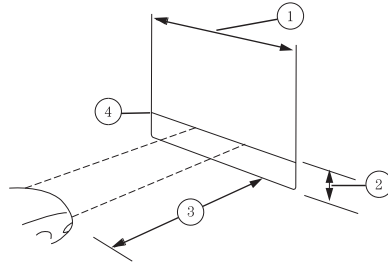

3. Turn on the low beam headlamps to illuminate the wall or screen and open the hood.

To see a clearer light pattern for adjusting, you may want to block the light from one headlamp while adjusting the other.

4. On the wall or screen you will observe an area of high intensity light. The top of the high intensity area should touch the horizontal reference line, if not, the beam will need to be adjusted using the next step.

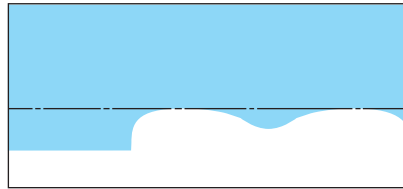

5. Locate the vertical adjuster on each headlamp. Using a Phillips #2 screwdriver, turn the adjuster either clockwise (to adjust down) or counterclockwise (to adjust up). The horizontal edge of the brighter light should touch the horizontal reference line.

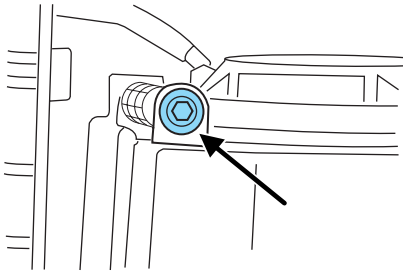

6. Close the hood and turn off the lamps.

HORIZONTAL AIM IS NOT REQUIRED FOR THIS VEHICLE AND IS NON-ADJUSTABLE.

Lights

TURN SIGNAL CONTROL ⇐⇒

- Push down to activate the left turn signal.
- Push up to activate the right turn signal.

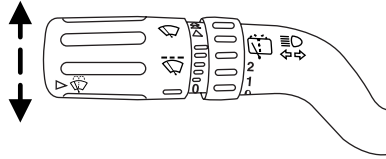

INTERIOR LAMPS

Front row map lamps (if equipped)

To turn on the map lamps, press the outer edge of the clear lens. The front row map lamp lights when:

- any door is opened.
- the instrument panel dimmer switch is rotated until the courtesy lamps come on.
- the remote entry controls are pressed and the ignition is OFF.

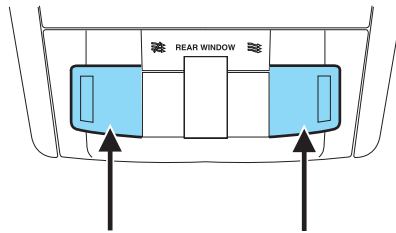

Map/dome lamp (if equipped)

The dome lamp lights when:

- any door is opened,
- the instrument panel dimmer switch is rotated up until the courtesy lamps come on, and
- any of the remote entry controls are pressed and the ignition is OFF.

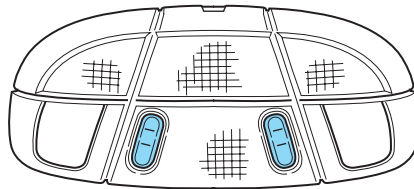

The map lamps are activated by pressing the controls on either side of the lens.

Lights

Rear courtesy lamp

Located in the rear cargo area, the courtesy lamp lights when:

- any door is opened.
- any of the remote entry controls are pressed and the ignition is OFF.

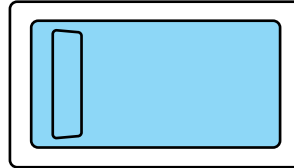

BULB REPLACEMENT

Headlamp Condensation

The headlamps are vented to equalize pressure. When moist air enters the headlamp(s) through the vents, there is a possibility that condensation can occur. This condensation is normal and will clear within 45 minutes of headlamp operation.

Using the right bulbs

Replacement bulbs are specified in the chart below. Headlamp bulbs must be marked with an authorized “D.O.T.” for North America and an “E” for Europe to ensure lamp performance, light brightness and pattern and safe visibility. The correct bulbs will not damage the lamp assembly or void the lamp assembly warranty and will provide quality bulb burn time.

Function	Number of bulbs	Trade number
Headlamp high beam	2	9005
Headlamp low beam	2	H11
Front sidemarker lamp	2	168
Front park/turn signal lamp	2	3157NAK (amber)
Rear sidemarker lamp	2	194
Stop/tail/turn lamp	2	4157 K
*Backup lamp	N/A	LED
License plate lamp	2	C5W
High-mount brake lamp	5	W5W

Lights

Function	Number of bulbs	Trade number
Foglamp (if equipped)	2	H11
Map lamp	2	12V6W
Second row dome/reading lamp	3	578
Rear courtesy lamp	1	1600XB
Visor vanity lamp - Slide on Rail system (SOR) (if equipped)	2	37
All replacement bulbs are clear in color except where noted.		
To replace all instrument panel lights - see your authorized dealer.		
*To replace these lamps - see your authorized dealer.		

Replacing the interior bulbs

Check the operation of all bulbs frequently.

Replacing exterior bulbs

Check the operation of all the bulbs frequently.

Replacing headlamp bulbs

1. Make sure that the headlamp control is in the OFF position.
2. Open the hood.
3. Reach over the front bolster.

Highbeam bulb

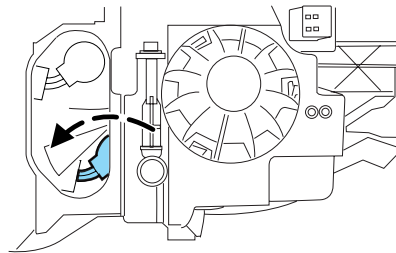

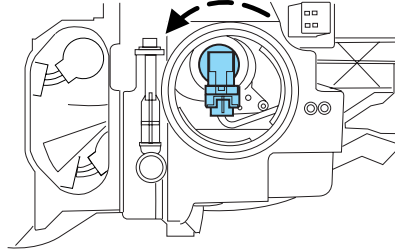

Lights

Lowbeam bulb

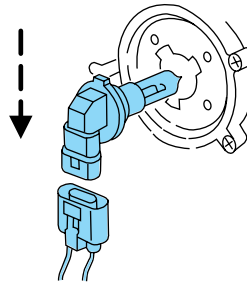

4. Remove the bulb cover. Note: The left side has a side access bulb cover instead of a back access bulb cover
5. Remove the bulb by turning it counterclockwise and then pulling it straight out.
6. Disconnect the electrical connector from the bulb.
7. Connect the electrical connector on the new bulb.



 Handle a halogen headlamp bulb carefully and keep out of children's reach. Grasp the bulb only by its plastic base and do not touch the glass. The oil from your hand could cause the bulb to break the next time the headlamps are operated.

8. Insert the glass end of the new bulb into the headlamp assembly. When the grooves in the plastic base are aligned, turn the new bulb clockwise to install.
9. Install the bulb cover.

Replacing front parking lamp/turn signal bulbs

1. Make sure that the headlamp control is in the OFF position.
2. Open the hood.
3. Reach over the front bolster.

70

Lights

4. Remove the bulb cover.
5. Rotate the bulb socket counterclockwise and remove from the lamp assembly.

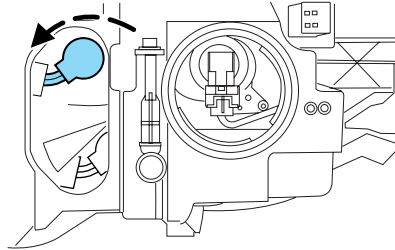

6. Carefully pull the bulb out of the socket and push in the new bulb.
7. Install the bulb socket into the lamp assembly and rotate clockwise.
8. Install the bulb cover.

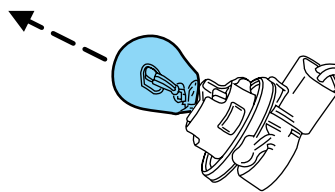

Replacing front side marker bulbs

1. Make sure the headlamp control is in the OFF position.
2. Pry the lamp away from the vehicle at the rear of lamp at the wheel opening. (Rotate lamp from the wheel opening away from the vehicle), as the lamp separates from the vehicle, slide the lamp towards the wheel opening to disengage lamp
3. Rotate the lamp clockwise while holding the electrical connector in place with your other hand. After rotating the lamp 90 degrees clockwise, pull and disengage the wire harness and bulb from the lamp.
4. With the bulb exposed, carefully remove the bulb from the socket by grasping the bulb and pulling it away from the wire harness. Replace with a new bulb, and reverse the removal steps to complete the process.

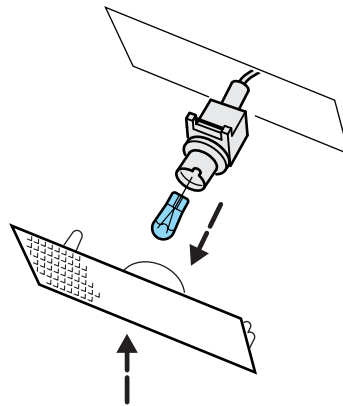

Lights

Replacing tail/stop/turn/sidemarkers/backup lamp bulbs

The tail/stop/turn/sidemarkers/backup lamp bulbs are located in the same portion of the tail lamp assembly, one just below the other. Follow the same steps to replace either bulb.

Note: Your vehicle is equipped with a backup lamp assembly containing integral multiple light emitting diodes (LED). See your authorized dealer for the replacement LED module.

1. Make sure the headlamp switch is in the OFF position and then open the liftgate to expose the lamp assembly bolts.

2. Remove the two bolts from the lamp assembly.

3. Carefully remove the lamp assembly away from the vehicle by pulling the assembly straight out to expose the bulb socket. **DO NOT TIP THE LAMP ASSEMBLY SIDEWAYS.**

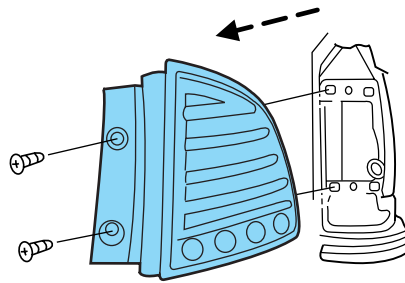

4. Rotate the bulb socket counterclockwise and remove from lamp assembly.

5. Pull bulb straight out of socket and snap in the new bulb.

6. Install the bulb socket into the lamp assembly and rotate clockwise.

7. Carefully install the tail lamp assembly on the vehicle by securing the lamp assembly with two bolts.

Replacing supplemental liftgate lamp assembly

Your vehicle is equipped with a liftgate lamp assembly containing integral multiple light emitting diodes (LED). If one or more LEDs burn out, the complete lamp module has to be replaced. See your authorized dealer for the replacement LED module.

Lights

Replacing high-mount brake lamp bulbs

1. Remove the two screws and move the lamp assembly away from the liftgate.

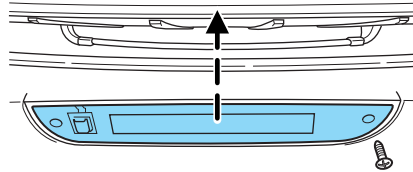

2. Remove the bulb holder from the lamp assembly by depressing the snaps.

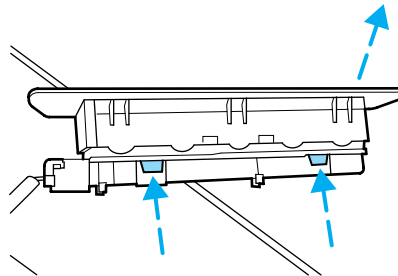

3. Pull the bulb straight out of the socket and push in the new bulb.

Install the new bulbs in reverse order.

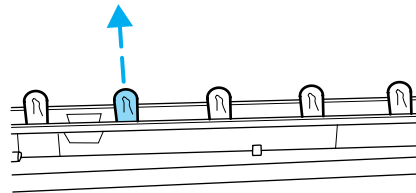

Replacing license plate lamp bulbs

1. Make sure the headlamp switch is in the OFF position.

2. Remove the two screws and the license plate lamp assembly from the liftgate.

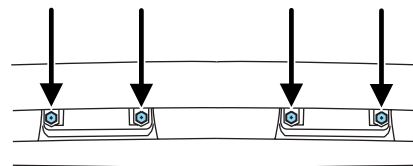

Lights

- Carefully pull the bulb straight out from the lamp assembly.
Install new bulb(s) in reverse order.

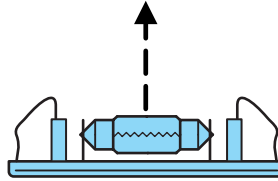

Replacing foglamp bulbs

- Make sure the foglamp switch is in the OFF position.
- From underneath the vehicle, remove the splash shield and rotate the harness/bulb assembly counterclockwise, to remove from the fog lamp.
- Carefully disconnect the bulb from the harness assembly via the two snap clips.
Install the new bulb in reverse order.

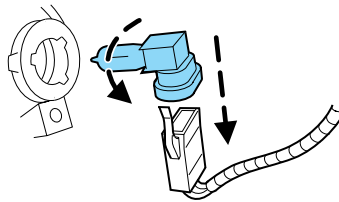

Driver Controls

MULTI-FUNCTION LEVER

Windshield wiper: Rotate the end of the control away from you to increase the speed of the wipers; rotate towards you to decrease the speed of the wipers.

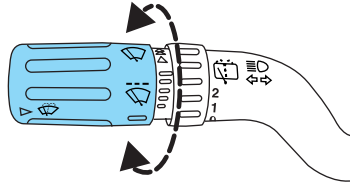

Speed dependent wipers: When the wiper control is on, the speed of the wipers will automatically adjust with the vehicle speed. The faster your vehicle is travelling the faster the wipers will go.

Windshield washer: Push the end of the stalk:

- briefly: causes a single swipe of the wipers without washer fluid.
- a quick push and hold: the wipers will swipe three times with washer fluid.
- a long push and hold: the wipers and washer fluid will be activated for up to ten seconds.

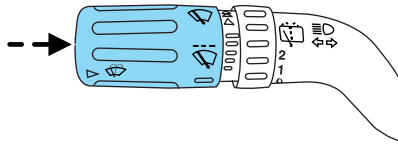

Note: Do not operate the washer when the washer reservoir is empty. This may cause the washer pump to overheat. Check the washer fluid level frequently. Do not operate the wipers when the windshield is dry. This may scratch the glass, damage the wiper blades and cause the wiper motor to burn out. Before operating the wiper on a dry windshield, always use the windshield washer. In freezing weather, be sure the wiper blades are not frozen to the windshield before operating the wipers.

Windshield wiper features (if equipped with Autolamp feature)

The exterior lamps will turn on with the ignition on, headlamp control in the Autolamp position and the windshield wipers are turned on (for a fixed period of time).

Driver Controls

Rear window wiper/washer controls

For rear wiper operation, rotate the rear window wiper and washer control to the desired position. Select:

2 — Normal speed operation of rear wiper.

1 — Intermittent operation of rear wiper.

OFF — Rear wiper and washer off.

For rear wash cycle, rotate (and hold as desired) the rear wiper/washer control to either  position.

From either position, the control will automatically return to the INT 2 or OFF position.

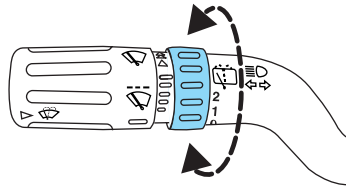

TILT/TELESCOPE STEERING WHEEL

To adjust the steering wheel:

1. Pull the lever down to unlock the steering column.

2. While the lever is in the down position, move the steering wheel up or down and in or out until you find the desired position.

3. While holding the steering wheel in place, pull the lever up to its original position to lock the steering column.

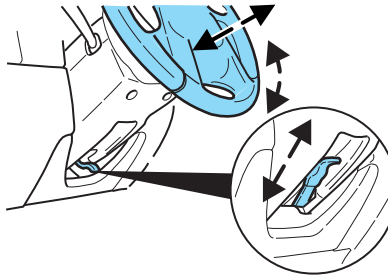

Never adjust the steering wheel when the vehicle is moving.

Driver Controls

ILLUMINATED VISOR MIRROR

Lift the mirror cover to turn on the visor mirror lamp.

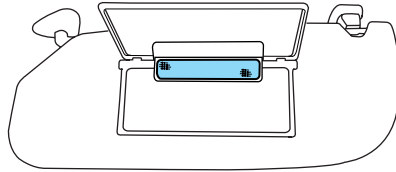

Slide on rod feature

The visor will slide back and forth on the rod for increased sunlight coverage. Rotate the visor towards the side window and extend it rearward for additional sunlight coverage.

Note: To stow the visor back into the headliner, visor must be retracted before moving it back towards the windshield.

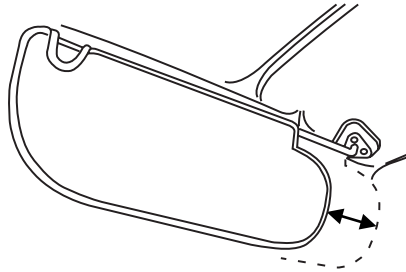

OVERHEAD CONSOLE

The appearance of your vehicle's overhead console will vary according to your option package.

Forward storage bin (if equipped)

The storage compartment may be used to store a pair of sunglasses. Press the release area on the rear edge of the bin door to open the storage compartment. The door will open to full open position.

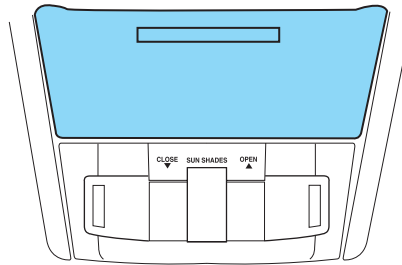

Driver Controls

CENTER CONSOLE

Your vehicle may be equipped with a variety of console features. These include:

1. Cupholders
2. Tissue box holder (if equipped) (located on underside of console lid)
3. Rear power point
4. Utility compartment with a Secondary storage bin with coin holder slots (on hinges inside utility compartment), power point, AIJ (Audio Input Jack), and a Multi Position Bin Divider (2 positions vertical / 1 position horizontal)

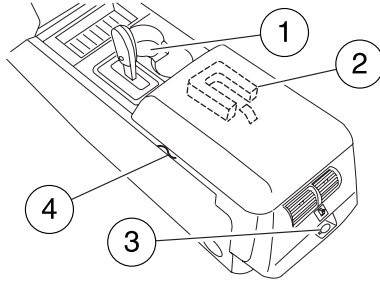

Use only soft cups in the cupholder. Hard objects can injure you in a collision.

AUXILIARY POWER POINT (12VDC)

Power outlets are designed for accessory plugs only. Do not insert any other object in the power outlet as this will damage the outlet and blow the fuse. Do not hang any type of accessory or accessory bracket from the plug. Improper use of the power outlet can cause damage not covered by your warranty.

The auxiliary power point is located on the instrument panel.

A second auxiliary power point is located in the center console utility compartment.

Do not use the power point for operating the cigarette lighter element (if equipped).

To prevent the fuse from being blown, do not use the power point(s) over the vehicle capacity of 12 VDC/180W. If the power point or cigar lighter socket is not working, a fuse may have blown. Refer to *Fuses and relays* in the *Roadside Emergencies* chapter for information on checking and replacing fuses.

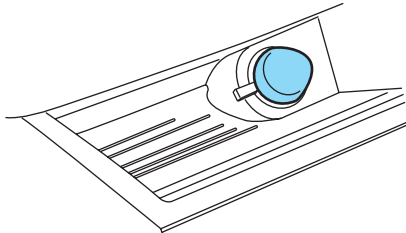

Driver Controls

To prevent the battery from being discharged, do not use the power point longer than necessary when the engine is not running.

Always keep the power point caps closed when not being used.

A third auxiliary power point is located on the rear side of the center console. The power point is accessible from the rear seats.

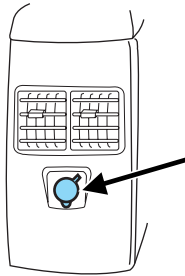

The rear auxiliary power point is located on the left rear quarter panel. The power point is accessible from the liftgate or behind the rear seat.

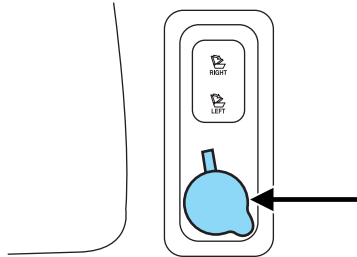

Cigar/Cigarette lighter (if equipped)

Do not plug optional electrical accessories into the cigarette lighter socket.

Do not hold the lighter in with your hand while it is heating, this will damage the lighter element and socket. The lighter will be released from its heating position when it is ready to be used.

Improper use of the lighter can cause damage not covered by your warranty.

POWER WINDOWS



Do not leave children unattended in the vehicle and do not let children play with the power windows. They may seriously injure themselves.

Driver Controls

 When closing the power windows, you should verify they are free of obstructions and ensure that children and/or pets are not in the proximity of the window openings.

Press and pull the switches to open and close windows.

- Push down (to the first detent) and hold the switch to open.
- Pull up (to the first detent) and hold the switch to close.

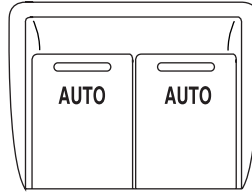

Express down (One Touch Down, Front windows only)

Allows the driver and passenger's window to open fully without holding the control down. Push the switch completely down to the second detent and release quickly. The window will open fully. Momentarily press the switch to any position to stop the window operation.

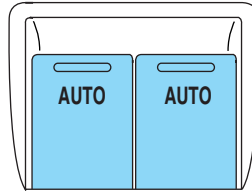

Express Up (One Touch Up, Front windows only)

Allows the driver and passenger's window to close fully without holding the control up. Pull the switch completely up to the second detent and release quickly. The window will close fully. Momentarily press the switch to any position to stop the window operation.

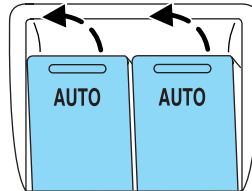

Note: Refer to the *Locks and Security* chapter for the *Opening front windows and panoramic roof* feature.

Bounce-Back

When the window is moving upward and an obstacle or a rough road condition interferes with the window's movement, the window will automatically reverse direction and move down. This is known as "bounce-back". If the ignition is turned OFF (without accessory delay

Driver Controls

being active) during bounce-back, the window will move down until the bounce back position is reached.

Security Override

If during a bounce-back condition, the switch is released to the neutral position, then held in the one touch up position within two seconds after the window reaches the bounce-back position, **the window will travel up with no bounce-back protection.** If the switch is released before the window reaches fully closed or the ignition is turned OFF (without accessory delay being active), the window will stop. Security override can be used if the window movement is restricted in some way, for example, if there is ice on the window or seals.

Window lock

The window lock feature allows only the driver and front passenger to operate the power windows.

To lock out all the window controls (except for the driver and front passenger) press the right side of the control. Press the left side to restore the window controls.

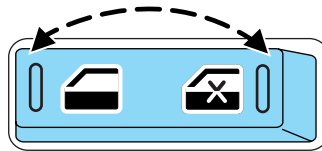

Accessory delay

With accessory delay, the audio system, power windows, and moon roof (if equipped) operate for up to ten minutes after the ignition switch is turned from the ON to the OFF position or until either front door is opened.

AUTOMATIC DIMMING REAR VIEW MIRRORS

Your vehicle is equipped with an inside rear view mirror and a driver's outside mirror that has an auto-dimming function. The electronic day/night mirror will change from the normal (high reflective) state to the non-glare (darkened) state when bright lights (glare) reach the inside mirror. When the inside mirror detects bright light from behind the vehicle, the inside rear view mirror and the driver's outside mirror will automatically adjust (darken) to minimize glare.

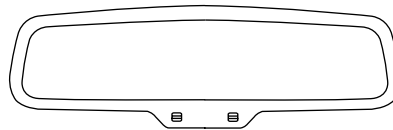

Driver Controls

The mirrors will automatically return to the normal state whenever the vehicle is placed in R (Reverse) to ensure a bright clear view when backing up.

Do not block the sensors on the front and back of the inside rear view mirror since this may impair proper mirror performance.

EXTERIOR MIRRORS

Power side view mirrors

To adjust your mirrors:

1. Rotate the control clockwise to adjust the right mirror and rotate the control counterclockwise to adjust the left mirror.
2. Move the control in the direction you wish to tilt the mirror.
3. Return to the center position to lock mirrors in place.

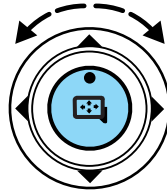

Fold-away mirrors

Pull the side mirrors in carefully when driving through a narrow space, like an automatic car wash.

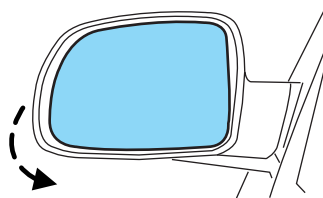

Heated outside mirrors (if equipped)

Both mirrors are heated automatically to remove ice, mist and fog when the rear window defrost is activated.

Do not remove ice from the mirrors with a scraper or attempt to readjust the mirror glass if it is frozen in place.

These actions could cause damage to the glass and mirrors.

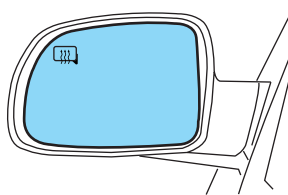

Driver Controls

SPEED CONTROL

With speed control set, you can maintain a set speed without keeping your foot on the accelerator pedal.



Do not use the speed control in heavy traffic or on roads that are winding, slippery or unpaved.

Setting speed control

The controls for using your speed control are located on the steering wheel for your convenience.

1. Press the ON control and release it.
2. Accelerate to the desired speed.
3. Press the SET + control and release it.
4. Take your foot off the accelerator pedal.
5. The indicator  light on the instrument cluster will turn on.

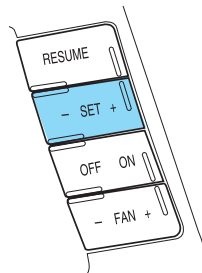
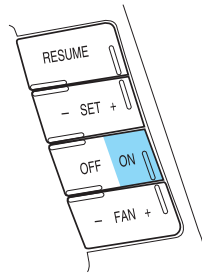

Note:

- Vehicle speed may vary momentarily when driving up and down a steep hill.
- If the vehicle speed increases above the set speed on a downhill, you may want to apply the brakes to reduce the speed.
- If the vehicle speed decreases more than 10 mph (16 km/h) below your set speed on an uphill, your speed control will disengage.

Disengaging speed control

To disengage the speed control:

- Depress the brake pedal.

Driver Controls

Disengaging the speed control will not erase previous set speed.

Resuming a set speed

Press the RESUME control and release it. This will automatically return the vehicle to the previously set speed.

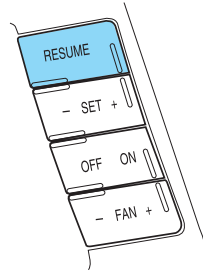

Increasing speed while using speed control

There are two ways to set a higher speed:

- Press and hold the SET + control until you get to the desired speed, then release the control. You can also use the SET + control to operate the Tap-Up function. Press and release this control to increase the vehicle set speed in small amounts by 1 mph (1.6 km/h).
- Use the accelerator pedal to get to the desired speed. When the vehicle reaches that speed press and release the SET + control.

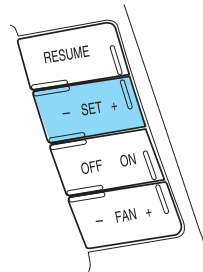

Reducing speed while using speed control

There are two ways to reduce a set speed:

- Press and hold the SET - control until you get to the desired speed, then release the control. You can also use the SET - control to operate the Tap-Down function. Press and release this control to decrease the vehicle set speed in small amounts by 1 mph (1.6 km/h).

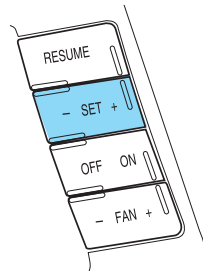

Driver Controls

- Depress the brake pedal until the desired vehicle speed is reached and press the SET control.

Turning off speed control

There are two ways to turn off the speed control:

- Depress the brake pedal. This will not erase your vehicle's previously set speed.
- Press the speed control OFF control.

Note: When you turn off the speed control or the ignition, your speed control set speed memory is erased.

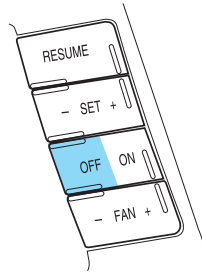

STEERING WHEEL CONTROLS

These controls allow you to operate some radio and climate control features.

Radio control features

Press MEDIA to select:

- AM, FM1, FM2, or CD
- LINE IN (Auxiliary input jack)

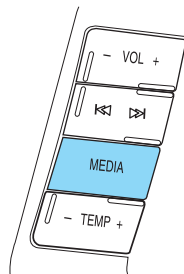

Driver Controls

In Radio mode:

- Press **⏮ ⏭** to access the next/previous preset station.

In CD mode:

- Press **⏮ ⏭** to listen to the next track on the disc.

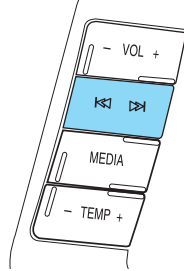

In any mode:

- Press VOL + or - to adjust the volume.

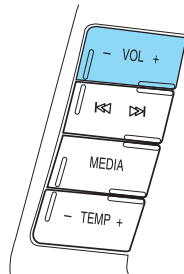

Climate control features

Press TEMP + or - to adjust temperature.

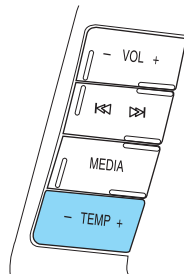

Driver Controls

Press FAN + or - to adjust fan speed.

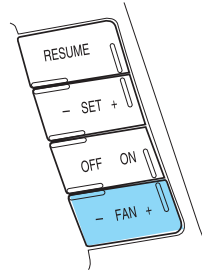

PANORAMIC VISTA ROOF™ AND POWER SUNSHADES (IF EQUIPPED)

The panoramic Vista Roof™ and power sunshade controls are located on the overhead console.



Do not let children play with the panoramic Vista Roof™ and power sunshade or leave children unattended in the vehicle. They may seriously hurt themselves.



When closing the panoramic Vista Roof™ and power sunshade, you should verify that it is free of obstructions and ensure that children and/or pets are not in the proximity of the panoramic Vista Roof™ and power sunshade opening.

To operate power sunshades:

Press the OPEN portion of the control to open the sunshade. The front and rear sunshades open simultaneously. Press the CLOSE portion of the control to close the front and rear sunshades.

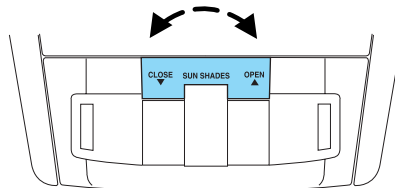

Note: Closing the sunshade will also close the panoramic Vista Roof™, if open.

Driver Controls

To open the panoramic Vista

Roof™: Press and hold to open manually. The panoramic Vista Roof™ is equipped with a one-touch open feature. Firmly press and release the rear control. The panoramic Vista Roof™ will open to the “comfort” position. Firmly press and release the control again to fully open. To stop the one-touch open feature press any control again.

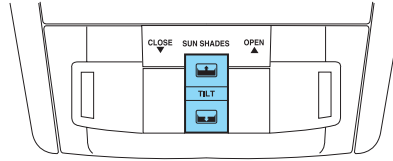

Note: Opening the panoramic Vista Roof™ will also open the sunshades, if closed.

Note: The panoramic Vista Roof™ will open to the “**comfort**” position first before opening all the way. The “comfort” position helps to alleviate rumbling wind noise which may happen in the vehicle with the roof fully opened.

To close the panoramic Vista Roof™: Press and release the front control until the glass panel stops at the “Express close” position. Firmly press and hold the control again to fully close.

To vent the panoramic Vista Roof™: From the closed position, press and release the TILT control. To vent the panoramic Vista Roof™ from any position, press and hold the TILT control. To close, press and hold the front control.

Note: If the panoramic Vista Roof™ is excessively operated, the glass and shade motors will automatically go into a fail-safe jog mode (manual intermittent operation) to prevent overheating and/or damage to the motor. The motors will revert back to normal operation after a period of idle time.

HOMELINK® WIRELESS CONTROL SYSTEM (IF EQUIPPED)

The HomeLink® Wireless Control System, located on the driver's visor, provides a convenient way to replace up to three hand-held transmitters with a single built-in device. This feature will learn the radio frequency codes of most transmitters to operate garage doors, entry gate operators, security systems, entry door locks, and home or office lighting.

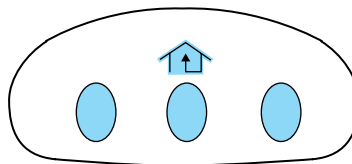

Driver Controls



When programming your HomeLink® Wireless Control System to a garage door or gate, be sure that people and objects are out of the way to prevent potential harm or damage.

Do not use the HomeLink® Wireless Control System with any garage door opener that lacks safety stop and reverse features as required by U.S. federal safety standards (this includes any garage door opener model manufactured before April 1, 1982). A garage door which cannot detect an object, signaling the door to stop and reverse, does not meet current U.S. federal safety standards. For more information, contact HomeLink® at: **www.homelink.com** or **1-800-355-3515**.

Retain the original transmitter for use in other vehicles as well as for future programming procedures (i.e. new HomeLink® equipped vehicle purchase). It is also suggested that upon the sale of the vehicle, the programmed HomeLink® buttons be erased for security purposes, refer to *Programming* in this section.

Programming

Do not program HomeLink® with the vehicle parked in the garage.

Note: Your vehicle may require the ignition switch to be turned to the ACC position for programming and/or operation of the HomeLink®. It is also recommended that a new battery be placed in the hand-held transmitter of the device being programmed to HomeLink® for quicker training and accurate transmission of the radio-frequency signal.

1. Press and hold the two outside buttons releasing only when the indicator light begins to flash after 20 seconds. **Do not** repeat Step 1 to program additional hand-held transmitters to the remaining two HomeLink® buttons. This will erase previously programmed hand-held transmitter signals into HomeLink®.

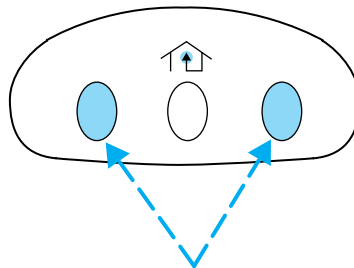

2. Position the end of your hand-held transmitter 1–3 inches (2–8 cm) away from the HomeLink® button you wish to program (located on your visor) while keeping the indicator light in view.

Driver Controls

3. Simultaneously press and hold both the chosen HomeLink® and hand-held transmitter buttons until the HomeLink® indicator light changes from a slow to a rapidly blinking light. Now you may release both the HomeLink® and hand-held transmitter buttons.

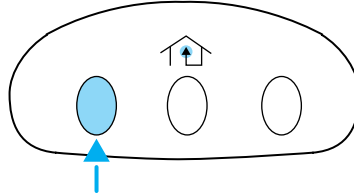

Note: Some entry gates and garage door openers may require you to replace Step 3 with procedures noted in the “Gate Operator and Canadian Programming” in this section for Canadian residents.

4. Firmly **press, hold for five seconds and release** the programmed HomeLink® button up to two separate times to activate the door. If the door does not activate, press and hold the just-trained HomeLink® button and observe the indicator light.

- If the indicator light **stays on constantly, programming is complete** and your device should activate when the HomeLink® button is pressed and released.
- If the indicator light blinks **rapidly for two seconds and then turns to a constant light continue with “Programming” Steps 5 through 7** to complete programming of a rolling code equipped device (most commonly a garage door opener).

5. At the garage door opener receiver (motor-head unit) in the garage, locate the “learn” or “smart” button (usually near where the hanging antenna wire is attached to the unit).

6. Firmly press and release the “learn” or “smart” button. (The name and color of the button may vary by manufacturer.)

Note: There are 30 seconds in which to initiate Step 7.

7. Return to the vehicle and firmly **press, hold for two seconds and release** the programmed HomeLink® button. Repeat the **press/hold/release** sequence again and, depending on the brand of the garage door opener (or other rolling code equipped device), repeat this sequence a third time to complete the programming.

HomeLink® should now activate your rolling code equipped device. To program additional HomeLink® buttons begin with Step 2 in the “Programming” section. For questions or comments, please contact HomeLink® at **www.homelink.com** or **1-800-355-3515**.

Driver Controls

Gate Operator & Canadian Programming

During programming, your hand-held transmitter may automatically stop transmitting — not allowing enough time for HomeLink® to accept the signal from the hand-held transmitter.

After completing Steps 1 and 2 outlined in the “Programming” section, replace Step 3 with the following:

Note: If programming a garage door opener or gate operator, it is advised to unplug the device during the “cycling” process to prevent overheating.

- Continue to press and hold the HomeLink® button (note Step 3 in the “Programming” section) while you press and release — **every two seconds** (“cycle”) your hand-held transmitter until the frequency signal has been accepted by the HomeLink®. The indicator light will flash slowly and then rapidly after HomeLink® accepts the radio frequency signal.
- Proceed with Step 4 in the “Programming” section.

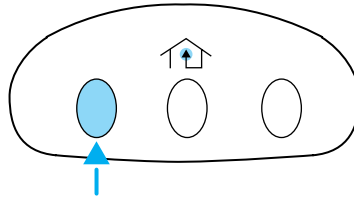

Operating the HomeLink® Wireless Control System

To operate, simply press and release the appropriate HomeLink® button. Activation will now occur for the trained product (garage door, gate operator, security system, entry door lock, or home or office lighting etc.). For convenience, the hand-held transmitter of the device

may also be used at any time. In the event that there are still programming difficulties, contact HomeLink® at www.homelink.com or **1-800-355-3515**.

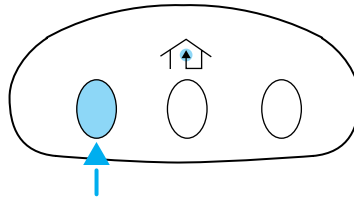

Driver Controls

Erasing HomeLink® buttons

To erase the three programmed buttons (individual buttons cannot be erased):

- Press and hold the two outer HomeLink® buttons until the indicator light begins to flash—after 20 seconds. Release both buttons. Do not hold for longer than 30 seconds.

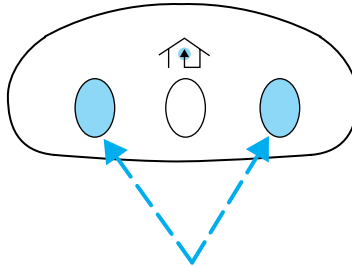

HomeLink® is now in the train (or learning) mode and can be programmed at any time beginning with Step 2 in the “Programming” section.

Reprogramming a single HomeLink® button

To program a device to HomeLink® using a HomeLink® button previously trained, follow these steps:

1. Press and hold the desired HomeLink® button. **Do NOT** release the button.
2. The indicator light will begin to flash after 20 seconds. Without releasing the HomeLink® button, follow Step 2 in the “Programming” section.

For questions or comments, contact HomeLink® at www.homelink.com or **1-800-355-3515**.

MESSAGE CENTER

With the ignition in the RUN position, the message center, located on your instrument cluster, displays important vehicle information **through a constant monitor of vehicle systems**. You

may select display features on the message center for a display of status. The system will also notify you of potential vehicle problems with a display of system warnings followed by a long indicator chime.

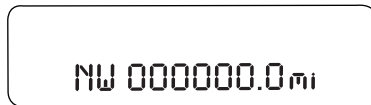

Driver Controls

Selectable features

Reset

Press this control to select and reset functions shown in the INFO menu and SETUP menu.

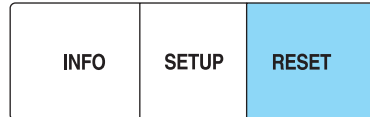

Info menu

This control displays the following control displays:

- Odometer
- Trip Odometer A or B
- Distance to Empty
- Average Fuel Economy
- Average Speed
- Compass
- Trip Elapsed Drive Time 1 or 2



Odometer/Trip odometer

Refer to *Gauges* in the *Instrument Cluster* chapter.

Distance to empty (DTE)

Selecting this function from the INFO menu estimates approximately how far you can drive with the fuel remaining in your tank under normal driving conditions.

Remember to turn the ignition OFF when refueling to allow this feature to correctly detect the added fuel.

The DTE function will display LOW FUEL LEVEL when you have approximately 50 miles (80 km) to empty. If you RESET this warning message, this display will return within 10 minutes.

DTE is calculated using a running average fuel economy, which is based on your recent driving history of 500 miles (800 km). This value is not the same as the average fuel economy display. The running average fuel economy is reinitialized to a factory default value if the battery is disconnected.



Driver Controls

Average fuel economy (AFE)

Select this function from the INFO menu to display your average fuel economy in miles/gallon or liters/100 km.



If you calculate your average fuel economy by dividing 100 miles traveled by gallons of fuel used (kilometers traveled by liters used), your figure may be different than displayed for the following reasons:

- Your vehicle was not perfectly level during fill-up
- Differences in the automatic shut-off points on the fuel pumps at service stations
- Variations in top-off procedure from one fill-up to another
- Rounding of the displayed values to the nearest 0.1 gallon (liter)

1. Drive the vehicle at least 5 miles (8 km) with the speed control system engaged to display a stabilized average.

2. Record the highway fuel economy for future reference.

It is important to press the RESET control (press and hold RESET for 2 seconds in order to reset the function) after setting the speed control to get accurate highway fuel economy readings.

For more information refer to *Fuel Information* in the *Maintenance and Specifications* chapter.

Average Speed

Select this function from the INFO menu to display AVERAGE SPEED and press the RESET control (press and hold RESET for 2 seconds in order to reset the function). Your average speed from that point will be displayed until RESET is pressed and held for two seconds again.

Compass display

Select this function from the INFO menu. Press the INFO button repeatedly until the Compass and Odometer are displayed. (Do not select Trip, DTE, or AFE. The top of the message center must be blank).

The compass reading may be affected when you drive near large buildings, bridges, power lines and powerful broadcast antenna. Magnetic or metallic objects placed in, on or near the vehicle may also affect compass accuracy.

Driver Controls

Usually, when something affects the compass readings, the compass will correct itself after a few days of operating your vehicle in normal conditions. If the compass still appears to be inaccurate, a manual calibration may be necessary. Refer to *Compass zone/calibration adjustment*.

Most geographic areas (zones) have a magnetic north compass point that varies slightly from the northerly direction on maps. This variation is four degrees between adjacent zones and will become noticeable as the vehicle crosses multiple zones. A correct zone setting will eliminate this error. Refer to *Compass zone/calibration adjustment*.

Compass zone/calibration adjustment

Perform this adjustment in an open area free from steel structures and high voltage lines.

For optimum calibration, turn off all electrical accessories (heater/air conditioning, wipers, etc.) and make sure all vehicle doors are shut.

1. Turn ignition to the RUN position.
2. Start the engine.
3. Press the INFO button repeatedly until the Compass and Odometer are displayed. (Do not select Trip, DTE, or AFE. The top of the message center must be blank).

Note: If the compass displays "CAL 000000.0 mi" instead of heading information, the compass will need to be calibrated. Slowly drive the vehicle in a circle (less than 3 mph [5 km/h]) until the "CAL" indicator changes to display compass heading. This may take up to 3 circles to complete calibration.

4. Determine your magnetic zone by referring to the zone map.

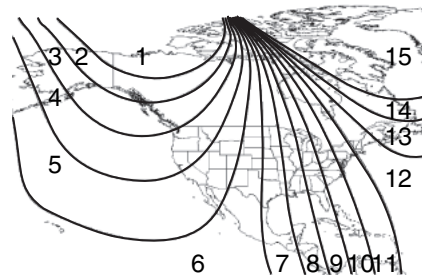

Driver Controls

5. Press and hold the RESET until the message center display changes to show the current zone setting.

RESET FOR ZONE
INFO TO EXIT

6. Release the RESET control, then slowly press RESET down again.

SETUP ZONE XX
RESET IF DONE

7. Press the SETUP control repeatedly until the correct zone setting for your geographic location is displayed on the message center. To exit the zone setting mode press and release the RESET control.

8. Press the RESET control to start the compass calibration function.

RESET FOR CAL
INFO TO EXIT

9. Slowly drive the vehicle in a circle (less than 3 mph [5 km/h]) until the CIRCLE SLOWLY TO CALIBRATE indicator changes to CALIBRATION COMPLETED. This will take up to three circles to complete calibration.

CIRCLE SLOWLY
TO CALIBRATE

10. The compass is now calibrated.

Trip elapsed drive time

Select this function from the INFO menu to display a timer.

To operate the Trip Elapsed Drive Time perform the following:

1. Press and release RESET in order to start the timer.
2. Press and release RESET to pause the timer.
3. Press and hold RESET for 2 seconds in order to reset the timer.

TIME 1 OR 2 XX:XX:XX
NW 000000.0 mi

Driver Controls

Setup menu

Press this control for the following displays:

- System Check
- Units (English/Metric)
- Autolamp
- Autolock
- Autounlock
- Power Liftgate (if equipped)
- Easy entry/exit seat (if equipped)
- Reverse sensing system (Park Assist) (if equipped)
- Language

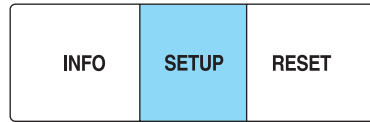

System check

Selecting this function from the SETUP menu causes the message center to cycle through each of the systems being monitored. For each of the monitored systems, the message center will indicate either an OK message or a warning message for two to four seconds.

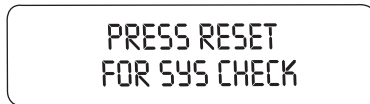

Pressing the RESET control cycles the message center through each of the systems being monitored.

The sequence of the system check report is as follows:

1. DOORS CLOSED
2. ENGINE TEMPERATURE
3. OIL PRESSURE
4. BRAKE FLUID LEVEL
5. WASHER FLUID LEVEL
6. FUEL LEVEL
7. DISTANCE TO EMPTY

Driver Controls

Units (English/Metric)

1. Select this function from the SETUP menu for the current units to be displayed.
2. Press the RESET control to change from English to Metric.



UNITS
< ENG > METRIC

Autolamp delay

This feature keeps your headlights on for up to three minutes after the ignition is switched off.

1. To disable/enable the autolamp delay feature, select this function from the SETUP control for the current display mode.
2. Press the RESET control to select the new Autolamp delay values of 0, 10, 20, 30, 60, 90, 120 or 180 seconds.



AUTOLAMP (SEC)
< 0 > 10 20

Autolock

This feature automatically locks all vehicle doors when the vehicle is shifted into any gear, putting the vehicle in motion.

1. To disable/enable the autolock feature, select this function from the SETUP control for the current display mode.
2. Press the RESET control to turn the autolock ON or OFF.



AUTOLOCK
< ON > OFF

Autounlock

This feature automatically unlocks all vehicle doors when the driver's door is opened within 10 minutes of the ignition being turned off.

1. To disable/enable the autounlock feature, select this function from the SETUP MENU.
2. Press and hold the RESET control switch to turn the autounlock ON or OFF.
3. Press the RESET control switch for the next SETUP MENU item or wait for more than 4 seconds to return to the INFO MENU.



AUTOUNLOCK
> ON OFF

Driver Controls

Easy entry/exit (if equipped)

This feature automatically moves the drivers seat backwards for easy exit from the vehicle.

1. To disable/enable the easy entry/exit seat feature, select this function from the SETUP control for the current display mode.

EASY ENTRY
< ON > OFF

2. Press the RESET control to turn the easy entry/exit seat ON or OFF.

Power Liftgate (if equipped)

This feature allows users to open/close the rear liftgate at the touch of a button.

1. To disable/enable the power liftgate feature, select this function from the SETUP control for the current display mode.

POWER LIFTGATE
ON <OFF>

2. Press the RESET control to turn the power liftgate ON or OFF.

Reverse Sensing System (Park assist) (if equipped)

This feature sounds a warning tone to warn the driver of obstacles near the rear bumper, and functions only when R (Reverse) gear is selected.

1. Select this function from the SETUP menu to disable the reverse sensing system feature.

PARK ASSIST
< ON > OFF

2. Press the RESET control to turn the rear park assist OFF. When R (Reverse) gear is selected, PARK ASSIST OFF will be displayed.

Language

1. Select this function from the SETUP menu for the current language to be displayed.

ENGLISH
RESET FOR NEW

Driver Controls

2. Pressing the RESET control cycles the message center through each of the language choices.

FOR ENGLISH
HOLD RESET

Selectable languages are English, Spanish and French.

3. Press and hold the RESET control for 2 seconds to set the language choice.

SET TO
ENGLISH

System warnings

System warnings alert you to possible problems or malfunctions in your vehicle's operating systems.

In the event of a multiple warning situation, the message center will cycle the display to show all warnings by displaying each one for several seconds.

The message center will display the last selected feature if there are no more warning messages. This allows you to use the full functionality of the message center after you acknowledge the warning by pressing the RESET control and clearing the warning message.

Warning messages that have been reset are divided into three categories:

- They will not disappear until a condition is changed.
- They will reappear on the display ten minutes from the reset.
- They will not reappear until an ignition LOCK/OFF-ON cycle has been completed.

This acts as a reminder that these warning conditions still exist within the vehicle.

Warnings	Status
Driver door ajar	Warning cannot be reset (PLEASE CLOSE DOOR) will be displayed
Passenger door ajar	
Rear left door ajar	
Rear right door ajar	
Park brake engaged	RELEASE PARK BRAKE will be displayed

Driver Controls

Warnings	Status
Low fuel level	Warning returns after 10 minutes
Check brake system	
Low brake fluid level	Warning returns after the ignition key is turned from LOCK/OFF to RUN
Liftgate ajar	
Low tire pressure	
Tire pressure monitor fault	
Tire pressure sensor fault	
Compass data error	
Integrated key programming status	Maximum number of Integrated Keys exceeded

DRIVER DOOR AJAR. Displayed when the driver's door is not completely closed.

PASSENGER DOOR AJAR. Displayed when the passenger side door is not completely closed.

REAR LEFT DOOR AJAR. Displayed when the rear left door is not completely closed.

REAR RIGHT DOOR AJAR. Displayed when the rear right door is not completely closed.

PARK BRAKE ENGAGED. Displayed when the manual park brake is set, the engine is running and the vehicle is driven more than 3 mph (5 km). If the warning stays on after the park brake is released, contact your authorized dealer as soon as possible.

LOW FUEL LEVEL. Displayed as an early reminder of a low fuel condition.

CHECK BRAKE SYSTEM. Displayed when the brake system needs servicing. If the warning stays on or continues to come on, contact your authorized dealer as soon as possible.

LOW BRAKE FLUID LEVEL. Indicates the brake fluid level is low and the brake system should be inspected immediately. Refer to *Brake fluid reservoir* in the *Maintenance and Specifications* chapter.

LIFTGATE AJAR. Displayed when the liftgate is not completely closed.

LOW TIRE PRESSURE. Displayed when one or more tires on your vehicle have low tire pressure. Refer to *Inflating Your Tires* in the *Tires, Wheels and Loading* chapter.

Driver Controls

TIRE PRESSURE MONITOR FAULT. Displayed when the Tire Pressure Monitoring System is malfunctioning. If the warning stays on or continues to come on, have the system inspected by your authorized dealer.

TIRE PRESSURE SENSOR FAULT. Displayed when a tire pressure sensor is malfunctioning, or your spare tire is in use. For more information on how the system operates under these conditions, refer to *Understanding Your Tire Pressure Monitoring System* in the *Tires, Wheels and Loading* chapter. If the warning stays on or continues to come on, have the system inspected by your authorized dealer.

COMPASS DATA ERROR. Displayed when the compass is not operating properly. If the warning stays on or continues to come on, contact your authorized dealer as soon as possible.

INTEGRATED KEY PROGRAMMING STATUS. Displayed when an attempt is made to program a fifth Integrated Key to the Remote Key Entry System. For more information on Integrated Key, refer to *Locks and Security* chapter in this manual.

POSITIVE RETENTION FLOOR MAT (IF EQUIPPED)



Do not install additional floor mats on top of the factory installed floor mats as they may interfere with the accelerator or the brake pedals.

To install floor mats that have a retention post:

Position the floor mat so that the eyelet is over the pointed end of the retention post and rotate forward to lock in. Make sure that the mat does not interfere with the operation of the accelerator or the brake pedal. To remove the floor mat, reverse the installation procedure.

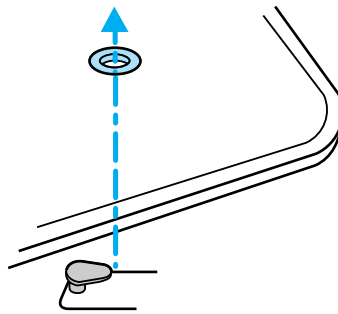

Driver Controls

POWER LIFTGATE (PLG) (IF EQUIPPED)

You can power open or close the liftgate with the following controls.

- instrument panel control button
- integrated keyhead transmitter button
- outside liftgate control button
- control button in the rear cargo area

Opening and Closing the power liftgate:



WARNING: Make sure all persons are clear of the power liftgate area before using the power liftgate control.



Keep keys out of reach of children. Do not allow children to play near an open or moving power liftgate.

The liftgate will only operate with the vehicle in P (Park).

When the liftgate is being power closed, a chime will sound three times as the liftgate begins to power close. A single chime indicates a problem with the close request, caused by:

- the ignition is in Run and the transmission is not in Park
- or the Battery Voltage is below the minimum operating voltage
- or the vehicle speed is at or above 3 mph (5 kph)

A fast continuous chime during power closing indicates there is an excessive load on the liftgate (snow, bike rack, etc.) or a possible strut malfunction. If any excessive load is removed and you still have a faster chime, have the system serviced immediately by your authorized dealer.

Do not attempt to manually force the liftgate to travel faster than the power system will permit. This will activate the obstacle detection feature.

Exercise care, when power opening or closing the liftgate in a garage or other enclosed area with a low ceiling or close to a wall/garage door. The liftgate could be damaged from the contact. Disable the power feature and operate the liftgate manually if necessary.

When power operating the liftgate at temperatures below 32° F (0° C), the liftgate may stop about 5 inches (12.7 cm) from the full open position. The liftgate can be fully opened by pushing it upward to the maximum open position.

Driver Controls

The Power Liftgate feature can be enabled or disabled using the Message Center. With the control in the OFF position, power operation is disabled from the liftgate handle button and from the rear cargo area button. The integrated keyhead transmitter and instrument panel switch will operate the liftgate regardless of the position state of the Message Center. Refer to the *Message Center* section in this chapter.

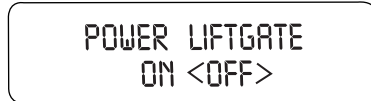

To power open or close the liftgate from the Instrument panel:

Press the button, located to the left of the steering column, once to power open or close the liftgate.

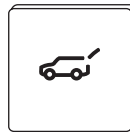

To power open or close the liftgate with the integrated keyhead transmitter:

Press  twice within 3 seconds to power open or close the liftgate. Refer to *Remote Entry System* in the *Locks and security* chapter.



To power close the liftgate with the rear cargo area control button:

Press and release the control on the left rear quarter panel to close the liftgate.

Note: The rear cargo area control button is disabled when the liftgate is latched.

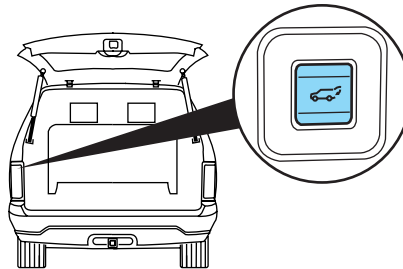

Driver Controls



Warning, keep clear of the liftgate when activating the rear switch.

Note: The liftgate movement direction can be reversed with a second press of the instrument panel, or the rear cargo area control button, or a second double press of the integrated keyhead transmitter button.

To power open the liftgate with outside liftgate control button:

1. To open, unlock the liftgate with the integrated keyhead transmitter or power door unlock control.
2. Push the control button located above the liftgate outside handle to unlatch and power open the liftgate.

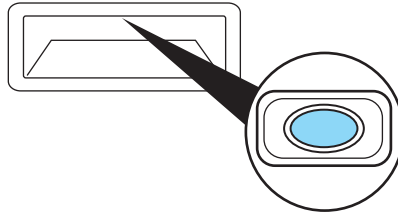

Note: For the best performance allow the power system to open the liftgate after pushing the control. Manually pushing or pulling the liftgate may activate the system's obstacle detection feature and stop the power system.

To manually operate the liftgate:

1. Disable the liftgate power function. Refer to the *Message Center* in this chapter.
2. Open and close the liftgate as you would a standard liftgate. Refer to the *Manual liftgate* in this chapter.

Note: In case of operation in extreme cold -40°F (-40°C), or on extreme inclines, manual operation of the liftgate is suggested.

Obstacle detection

The power liftgate system is equipped with an obstacle detection feature.

If the power liftgate is closing, the system will reverse to full open when it detects an obstacle. A chime will sound 3 times when an obstacle is detected as the liftgate begins to reopen. Once the obstacle is removed, the liftgate can be closed under power.

If the power liftgate is opening, the system will stop and a chime will sound 3 times when an obstacle is detected. Once the obstacle is removed, the liftgate can again be operated normally.

Driver Controls

Resetting the power liftgate:

The power liftgate may not operate properly and may need to be reset if any of these conditions occur:

- a low voltage or dead battery or disconnected battery
- the liftgate has been left open or unlatched for more than six (6) hours

To reset the power liftgate:

1. Ensure the battery is properly connected and charged.
2. Manually close and fully latch the liftgate.
3. Power open the liftgate by using the integrated keyhead transmitter, or the instrument panel control button. The outside liftgate control button can also be used if the power liftgate is enabled in the Message Center.

Note: If the battery is disconnected, discharged, or a new battery is installed, the power liftgate needs to be power opened to the full open position to reset the power liftgate positions.

MANUAL LIFTGATE (IF EQUIPPED)

The liftgate cargo area is only intended for cargo, not for passengers. You can open and close the liftgate from outside the vehicle. It cannot be opened from inside the cargo area.

Note: In the event of a power failure, the latch can be accessed and released through the access panel in the liftgate trim.

To open, push the control button located above the liftgate outside handle to unlatch the liftgate, then pull on the outside handle to access the cargo area.

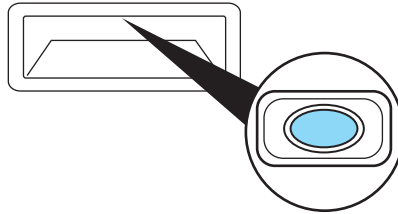

- Exercise care when opening or closing the liftgate in a garage or other enclosed area. The liftgate could be damaged against a garage door, low ceiling or wall.
- Do not hang anything (bike rack, etc.) from the spoiler/glass or liftgate. Doing so could cause serious damage to the liftgate and its components.
- Do not leave the liftgate open while driving. Doing so could cause serious damage to the liftgate and its components as well as allowing carbon monoxide to enter the vehicle.

Driver Controls

 Make sure that the liftgate is closed to prevent exhaust fumes from being drawn into the vehicle. This will also prevent passengers and cargo from falling out. If you must drive with the liftgate door open, keep the vehicle well ventilated so outside air comes into the vehicle.

Liftgate ajar signal

If the liftgate is not fully latched, you will receive a “LIFTGATE AJAR” message on the instrument panel. If you see this message, check the liftgate door to ensure it is fully latched.

CARGO MANAGEMENT SYSTEM (IF EQUIPPED)

The cargo management system consists of storage compartments located in the floor of the rear cargo area.

1. To open, lift the release handle and the lid.
2. To close, lower the lid.

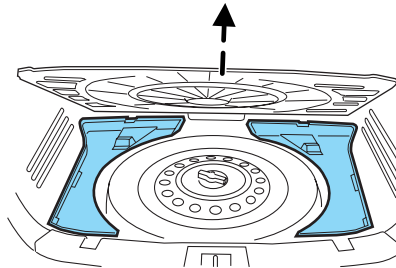

LUGGAGE RACK (IF EQUIPPED)

The load **must be** placed directly on the luggage rack. The vehicle's roof panel **is not** designed to carry a load.

When loading the luggage rack, it is recommended to evenly distribute the load, as well as maintain a low center of gravity. Ensure that the load is securely fastened. The maximum load for the roof rack is 100 lbs (44 kg).

Your fuel economy will decrease when you drive with items on the luggage rack. When the rack is loaded, check the tightness of the load before driving and at each refueling stop.

 Loaded vehicles, with a higher center of gravity, may handle differently than unloaded vehicles. Extra precautions, such as slower speeds and increased stopping distance, should be taken when driving a heavily loaded vehicle.

Locks and Security

KEYS

Your vehicle is equipped with two Integrated Keyhead Transmitters (IKTs). The IKT functions as both a programmed ignition key that operates all the locks and starts the vehicle, and a remote keyless entry transmitter. Vehicles with a power liftgate will have a four-button IKT while vehicles without a power liftgate will have a three-button IKT.

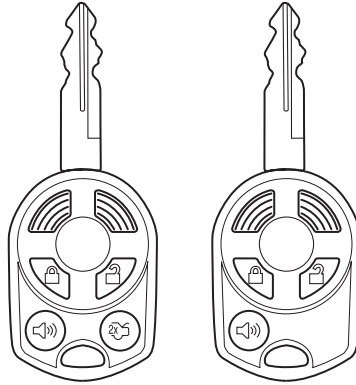

Your IKTs are programmed to your vehicle; using a non-programmed key will not permit your vehicle to start. If you lose your authorized dealer supplied IKTs, replacement IKTs are available through your authorized dealer. Standard SecuriLock[™] keys without remote entry transmitter functionality can also be purchased from your authorized dealer if desired.

Always carry a spare key with you in case of an emergency.

For more information regarding programming replacement IKTs, refer to the *SecuriLock[™] passive anti-theft system* section later in this chapter.

Note: Your vehicle's IKTs were issued with an adhesive security label on them that provides important vehicle key cut information. It is recommended that you maintain the label in a safe place for future reference, such as the inside front cover of this *Owner's Guide*.





Locks and Security

RECOMMENDED HANDLING OF THE INTEGRATED KEYHEAD TRANSMITTER (IKT)

To avoid inadvertently activating the remote entry functions of your vehicle, it is recommended that the Integrated Keyhead Transmitter (IKT) be handled properly when starting and turning off your vehicle.

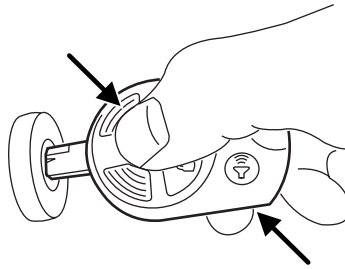
When inserting the IKT into the ignition cylinder, place your thumb on the center thumb rest of the IKT and forefinger on the logo badge on the opposite side.



To gain more leverage when rotating the IKT in the ignition lock cylinder, you can readjust the location of your thumb to grasp the IKT on the outer edge next to the  control.

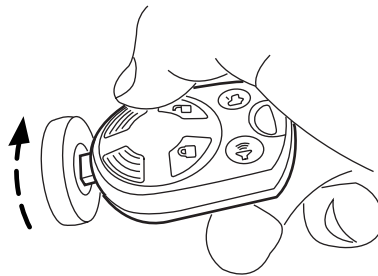

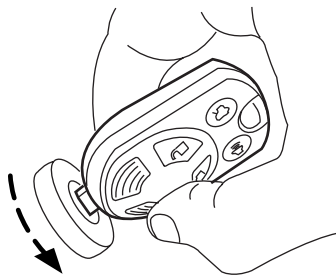

Likewise, when rotating the IKT to the 1 (LOCK) position in the ignition lock cylinder, the bottom edge of the IKT adjacent to the  control can be utilized.



Locks and Security

POWER DOOR LOCKS

- Press the  control to unlock all doors.
- Press the  control to lock all doors.

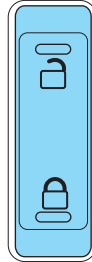

Smart locks

This feature helps to prevent you from locking yourself out of the vehicle if your key is still in the ignition.

When you open one of the front doors or the liftgate and you lock the vehicle with the power door lock control (on the driver or passenger door trim panel), all the doors will lock, then all doors will automatically unlock reminding you that your key is still in the ignition.

The vehicle can still be locked, with the key in the ignition, by locking the driver's door with a key, using the lock control on the remote entry transmitter portion of your Integrated Keyhead Transmitter, or locking the vehicle with the keyless entry keypad (if equipped).

If both front doors and the liftgate are closed, the vehicle can be locked from any method, regardless of whether the key is in the ignition or not.

Autolock feature

The autolock feature will lock all the doors when:

- all the doors are closed,
- the ignition is in the 3 (RUN) position,
- you shift into any gear putting the vehicle in motion, and
- the vehicle attains a speed greater than 12 mph (20 km/h) for greater than 2 seconds.

The autolock feature repeats when:

- any door is opened then closed while the ignition is in the 3 (RUN) position and the vehicle speed is 9 mph (15 km/h) or lower, and
- the vehicle then attains a speed greater than 12 mph (20 km/h) for greater than 2 seconds.

Locks and Security

Deactivating/activating autolock feature

Your vehicle comes with the autolock features activated; there are four methods to enable/disable this feature:

- Through your authorized dealer,
- by using a power door unlock/lock procedure,
- using a keypad procedure (if equipped), or
- or by using the instrument cluster message center (if equipped). Refer to *Message center* in the *Driver Controls* chapter.

Note: The autolock feature can be activated/deactivated independently of the autounlock feature.

Power door lock switch autolock enable/disable procedure

Before starting, ensure the ignition is in the 1 (LOCK) position and all vehicle doors are closed. You must complete Steps 1–5 within 30 seconds or the procedure will have to be repeated. If the procedure needs to be repeated, wait a minimum of 30 seconds before beginning again.

1. Place the key in the ignition and turn the ignition to the 3 (RUN) position.

2. Press the power door unlock control on the door panel three times.

3. Turn the ignition from the 3 (RUN) position to the 1 (LOCK) position.

4. Press the power door unlock control on the door panel three times.

5. Turn the ignition back to the 3 (RUN) position. The horn will chirp one time to confirm programming mode has been entered and is active.

6. To enable/disable the autolock feature, press the unlock control, then press the lock control. The horn will chirp once if autolock was deactivated or twice (one short and one long chirp) if autolock was activated.

7. Turn the ignition to the 1 (LOCK) position. The horn will chirp once to confirm the procedure is complete.

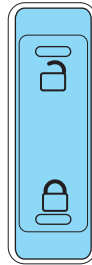

Locks and Security

Keyless entry key pad autolock enable/disable procedure

1. Turn the ignition to the 1 (LOCK) position.
2. Close all the doors.
3. Enter factory-set 5-digit entry code.
4. Press and hold the 3 • 4. While holding the 3 • 4 press the 7 • 8.
5. Release the 7 • 8.
6. Release the 3 • 4.

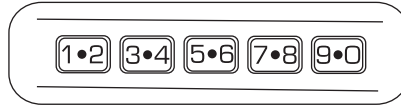

The user should receive a **horn chirp** to indicate the system has been disabled or a chirp followed by a honk to indicate the system has been enabled.

Autounlock feature

The autounlock feature will unlock all the doors when:

- the ignition is in the 3 (RUN) position, all the doors are closed, and the vehicle has been in motion at a speed greater than 12 mph (20 km/h);
- the vehicle has then come to a stop and the ignition is turned to the 1 (LOCK) or 2 (ACC) position; and
- the driver door is opened within 10 minutes of the ignition being transitioned to the 1 (LOCK) or 2 (ACC) position.

Note: The doors will not autounlock if the vehicle has been electronically locked before the driver door is opened.

Deactivating/activating autounlock feature

Your vehicle comes with the autounlock features activated; there are four methods to enable/disable this feature:

- Through your authorized dealer,
- by using a power door unlock/lock sequence,
- using a keypad procedure (if equipped), or
- or by using the instrument cluster message center (if equipped). Refer to *Message center* in the *Driver Controls* chapter.

Note: The autounlock feature can be activated/deactivated independently of the autolock feature.

Locks and Security

Power door lock switch autounlock enable/disable procedure

Before starting, ensure the ignition is in the 1 (LOCK) position and all vehicle doors are closed. You must complete Steps 1–5 within 30 seconds or the procedure will have to be repeated. If the procedure needs to be repeated, wait a minimum of 30 seconds before beginning again.

1. Place the key in the ignition and turn the ignition to the 3 (RUN) position.

2. Press the power door unlock control on the door panel three times.

3. Turn the ignition from the 3 (RUN) position to the 1 (LOCK) position.

4. Press the power door unlock control on the door panel three times.

5. Turn the ignition back to the 3 (RUN) position. The horn will chirp one time to confirm programming mode has been entered and is active.

6. To enable/disable the autounlock feature, press the lock control, then press the unlock control. The horn will chirp once if autounlock was deactivated or twice (one short and one long chirp) if autounlock was activated.

7. Turn the ignition to the 1 (LOCK) position. The horn will chirp once to confirm the procedure is complete.

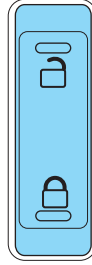

Keyless entry key pad autounlock enable/disable procedure

1. Turn the ignition to the 1 (LOCK) position.

2. Close all the doors.

3. Enter factory-set 5-digit entry code.

4. Press and hold the 3 • 4. While holding the 3 • 4, press and release the 7 • 8. While still holding the 3 • 4, press and release the 7 • 8 a second time.

5. Release the 3 • 4.

The user should receive a **horn chirp** to indicate the system has been disabled or a chirp followed by a honk to indicate the system has been enabled.

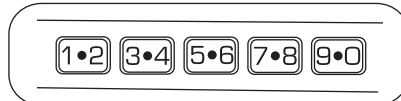

Locks and Security

CHILDPROOF DOOR LOCKS

- When these locks are set, the rear doors cannot be opened from the inside.
- The rear doors can be opened from the outside when the doors are unlocked.

The childproof locks are located on rear edge of each rear door and must be set separately for each door. Setting the lock for one door will not automatically set the lock for both doors.

- Insert the key and turn to the lock position (key horizontal) to engage the childproof locks.
- Insert the key and turn to the unlock position (key vertical) to disengage the childproof locks.

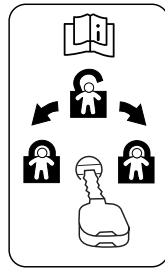
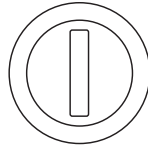

REMOTE ENTRY SYSTEM

The Integrated Keyhead Transmitter (IKT) complies with part 15 of the FCC rules and with RSS-210 of Industry Canada. Operation is subject to the following two conditions: (1) This device may not cause harmful interference, and (2) This device must accept any interference received, including interference that may cause undesired operation.

Changes or modifications not expressly approved by the party responsible for compliance could void the user's authority to operate the equipment.

Locks and Security

There are 2 possible types of IKTs:

- Vehicles equipped with a power lift gate

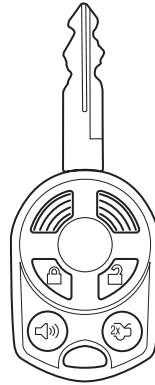

- Vehicles not equipped with a power lift gate

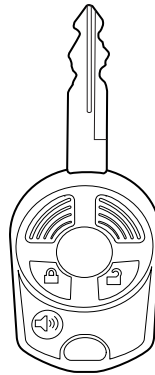

The typical operating range for your IKT is approximately 33 feet (10 meters). A decrease in operating range could be caused by:

- weather conditions,
- nearby radio towers,
- structures around the vehicle, or
- other vehicles parked next to your vehicle.

Locks and Security



The IKT allows you to:

- remotely unlock the vehicle doors.
- remotely lock all the vehicle doors.
- remotely open the power liftgate (if equipped).
- activate the personal alarm.
- arm and disarm the perimeter anti-theft system.
- operate the illuminated entry feature.

The remote entry lock/unlock feature operates in any ignition position except while the key is held in the 4 (START) position. The panic feature operates with the key in the 1 (LOCK) position.

If there are problems with the remote entry system, make sure to take **ALL Integrated Keyhead Transmitters** with you to the authorized dealer in order to aid in troubleshooting the problem.

Unlocking the doors/two stage unlock



1. Press  and release to unlock the driver's door. **Note:** The interior lamps will illuminate.
2. Press  and release again within five seconds to unlock all the doors.

The remote entry system activates the illuminated entry feature; this feature turns on the lamps for 25 seconds or until the ignition is turned to the 3 (RUN) position.

The inside lights will not turn off if:

- they have been turned on using the dimmer control or
- any door is open.

The battery saver feature will turn off the interior lamps 10 minutes after the ignition is turned to the 1 (LOCK) position.

Two stage unlocking may be disabled or re-enabled by simultaneously pressing the  and  controls on the IKT for four seconds (disabling two stage unlock allows all vehicle doors to unlock simultaneously). The turn lamps will flash twice to indicate that two-stage unlock was enabled or disabled.

Opening front windows and panoramic roof (if equipped)



Press  and hold for more than two seconds in order to begin opening the two front windows and venting the panoramic roof (if equipped).

- The  control can then be released and the windows and panoramic roof will complete the opening operation.
- If any other remote entry transmitter control is pressed during the opening operation, both windows and panoramic roof movement will stop.

Locks and Security

Note: The ignition must be in the 1 (LOCK) position and the accessory delay feature must be not activated in order for this feature to operate.

Locking the doors

1. Press  and release to lock all the doors. The turn lamps will flash.
2. Press  and release again within five seconds to confirm that all the doors are closed. **Note:** The doors will lock again, the horn will chirp and the turn lamps will flash once if all the doors and liftgate are closed.

Note: If any door or the liftgate is not closed, or if the hood is not closed in vehicles equipped with the perimeter alarm feature, the horn will chirp twice and the lamps will not flash.

Opening the power liftgate (if equipped)

Press  twice within 3 seconds to fully unlatch and open the liftgate.



Make sure all persons are clear of the liftgate area before using power liftgate control.

In order to fully lower and latch the liftgate, press the control twice.

If the liftgate stops mid travel, it may have detected an obstacle. Check to ensure the liftgate swing zone is free from obstruction and reset the power assist by manually closing the liftgate. Normal operation can then be resumed.





Make sure the liftgate is closed to prevent exhaust fumes from being drawn into the vehicle. This will also prevent passengers and cargo from falling out. If you must drive with the liftgate open, keep the vents open so outside air comes into the vehicle.

Car finder

Press  twice within 3 seconds. The horn will chirp and the turn lamps will flash. It is recommended that this method be used to locate your vehicle, rather than using the panic alarm.

Sounding a panic alarm

Press and hold  for 1.5 seconds to activate the alarm. The horn will sound and the turn lamps will flash for a maximum of 3 minutes. The alarm can be deactivated with a short press and release of , by turning the ignition to RUN, or by allowing the alarm to time out after 3 minutes.

Locks and Security

Note: The panic alarm will only operate when the ignition is in the 1 (LOCK) position.

Memory seat feature (if equipped)

The Integrated Keyhead Transmitter allows you to recall the memory seat/mirror feature.

Press  to automatically move the seat/mirror to the desired memory position. **Note:** The seat will not travel to its final position if the key is not in the ignition and the easy entry feature is enabled.

Activating the memory feature

To activate this feature:

1. Position the seat and mirrors to the desired positions.
2. Press the SET control on the driver's door panel.
3. Within 5 five seconds, press the lock or unlock control on the Integrated keyhead Transmitter and then press the 1 or 2 control on the driver's door panel which you would like to associate with the seat and Driver 1 or Driver 2 positions.
4. Repeat this procedure for another Integrated Keyhead Transmitter if desired.

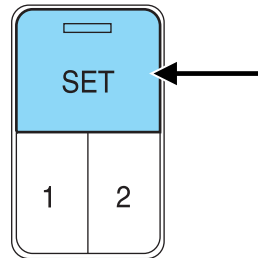

Deactivating the memory feature

To deactivate this feature:

1. Press the SET control on the driver's door panel.
2. Within five seconds, press the lock or unlock control on the Integrated Keyhead Transmitter which you would like to deactivate and then press the SET control on the driver's door panel again.
3. Repeat this procedure for another Integrated Keyhead Transmitter if desired.

Replacing the battery

The Integrated Keyhead Transmitter uses one coin type three-volt lithium battery CR2032 or equivalent.

Locks and Security

To replace the battery:

1. Twist a thin coin in the slot of the IKT near the key ring in order to remove the battery cover.

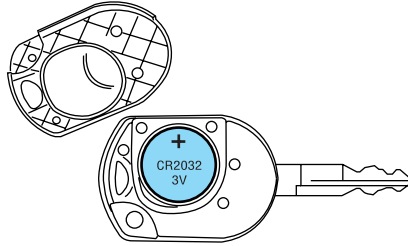

2. Do not wipe off any grease on the battery terminals on the back surface of the circuit board.

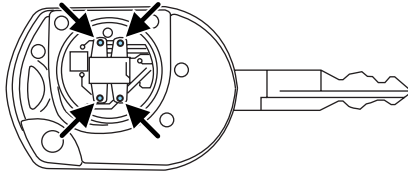

3. Remove the old battery. **Note:** Please refer to local regulations when disposing of transmitter batteries.

4. Insert the new battery. Refer to the instructions inside the IKT for the correct orientation of the battery. Press the battery down to ensure that the battery is fully seated in the battery housing cavity.

5. Snap the battery cover back onto the key.

Note: Replacement of the battery will **not** cause the IKT to become deprogrammed from your vehicle. The IKT should operate normally after battery replacement.

Replacing lost Integrated Keyhead Transmitters (IKTs)

If you would like to have your Integrated Keyhead Transmitters reprogrammed because you lost one, or would like to buy additional IKTs, you can either reprogram them yourself, or take **all IKTs** to your authorized dealer for reprogramming.

How to reprogram your Integrated Keyhead Transmitters (IKTs)

To program a new Integrated Keyhead Transmitter yourself, refer to *Programming spare keys* in the *SecuriLock™ passive anti-theft* section of this chapter. **Note:** At least two IKTs are required to perform this procedure yourself.

Locks and Security

Illuminated entry

The interior lamps and puddle lamps (if equipped) illuminate when the Integrated Keyhead Transmitter or the keyless entry system keypad is used to unlock the door(s).

The illuminated entry system will turn off the interior lights if:

- the ignition is turned to the 3 (RUN) position, or
- the Integrated Keyhead Transmitter lock control is pressed, or
- the vehicle is locked using the keyless entry keypad (if equipped), or
- after 25 seconds of illumination.

The inside lights will not turn off if:

- they have been turned on with the dimmer control, or
- any door is open.

Perimeter lamps illuminated entry

With the Integrated Keyhead Transmitter system, the following items will illuminate when the  (unlock) control on the transmitter is pressed:

- Head lamps
- Park lamps
- Tail lamps

The lamps will automatically turn off:

- if the ignition switch is turned to the 3 (RUN) position, or
- the Integrated Keyhead Transmitter lock control is pressed, or
- the vehicle is locked using the keyless entry keypad (if equipped), or
- after 25 seconds of illumination.

Note: On some vehicles, the perimeter lamps illuminated entry feature will not activate in daylight conditions.

Deactivating/activating perimeter lamps illuminated entry

You may enable/disable this feature by having your vehicle serviced by your authorized dealer.

You may also perform the following power door lock sequence to enable/disable the perimeter lamps feature. **Note:** Before starting, ensure the ignition is in the 1 (LOCK) position and all vehicle doors are closed. You must complete Steps 1–5 within 30 seconds or the procedure will have to be repeated. If the procedure needs to be repeated, wait a minimum of 30 seconds before beginning again.

Locks and Security

1. Place the key in the ignition and turn the ignition to the 3 (RUN) position.

2. Press the power door unlock control on the door panel three times.

3. Turn the ignition from the 3 (RUN) position to the 1 (LOCK) position.

4. Press the power door unlock control on the door panel three times.

5. Turn the ignition back to the 3 (RUN) position. The horn will chirp one time to confirm programming mode has been entered and is active.

6. Press the power door unlock control twice within 5 seconds. **Note:** The horn will chirp once to indicate the perimeter lighting feature has been deactivated. The horn will chirp once and honk once (one short and one long) to indicate the perimeter lighting feature has been activated.

7. Turn the ignition to the 1 (LOCK) position to exit the procedure.

Note: The horn will chirp once to confirm the procedure is complete.

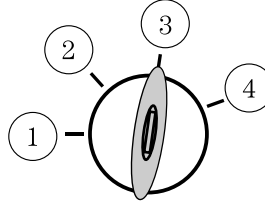

Illuminated exit

- When all vehicle doors are closed and the key is removed from the ignition, the interior dome lamps (and the exterior mirror puddle lamps, if equipped) will illuminate.

The lights will turn off if all the doors remain closed and

- 25 seconds elapse, or
- the key is inserted in the ignition.

Battery saver

The battery saver will shut off the interior lamps 10 minutes after the ignition has been turned to the 1 (LOCK) position.

- If the dome lamps were turned on using the panel dimmer control, the battery saver will shut them off 10 minutes after the ignition has been turned to the 1 (LOCK) position.
- If the courtesy lamps were turned on because one of the vehicle doors or the trunk was opened, the battery saver will shut them off 10 minutes after the ignition has been turned to the 1 (LOCK) position.
- The battery saver will shut off the headlamps 10 minutes after the ignition has been turned to the 1 (LOCK) position.

Locks and Security

KEYLESS ENTRY SYSTEM

You can use the keyless entry keypad to:

- lock or unlock the doors without using a key.
- recall memory seat/power mirrors positions (if equipped).

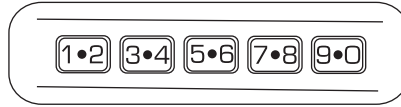

The keypad can be operated with the factory set 5–digit entry code; this code is located on the owner’s wallet card in the glove box and is available from your authorized dealer. You can also create up to three of your own 5–digit personal entry codes.

When pressing the controls on the keypad, press the middle of the controls to ensure a good activation.

Programming a personal entry code and keypad association to memory seats and mirrors (if equipped)

To create your own personal entry code:

1. Enter the factory set code.
2. Within five seconds press the 1 • 2 on the keypad.
3. Enter your personal 5-digit code. Each number must be entered within five seconds of each other.
4. To associate the entry code with a memory setting, enter a sixth digit to indicate which driver should be set in a memory recalled by the personal entry code:
 - Pressing 1 • 2 recalls Driver 1 settings.
 - Pressing 3 • 4 recalls Driver 2 settings.
 - Pressing other keypad buttons or not pressing a keypad button as a sixth digit does not set a driver and will not recall a memory setting.**Note:** The factory-set code cannot be associated with a memory setting.
5. The doors will lock then unlock to confirm that your personal keycode has been programmed to the module.

Tips:

- Do not set a code that uses five of the same number.
- Do not use five numbers in sequential order.
- The factory set code will work even if you have set your own personal code.

Locks and Security

Erasing personal code

1. Enter the factory set 5–digit code.
2. Within five seconds, press the 1 • 2 on the keypad and release.
3. Press and hold the 1 • 2 for two seconds. This must be done within five seconds of completing Step 2.

All personal codes are now erased and only the factory set 5–digit code will work.

Anti-scan feature

If the wrong code has been entered 7 times (35 consecutive button presses), the keypad will go into an anti-scan mode. This mode disables the keypad for one minute and the keypad lamp will flash.

The anti-scan feature will turn off after:

- one minute of keypad inactivity.
- pressing the UNLOCK  control on the remote entry transmitter portion of your Integrated Keyhead Transmitter.
- the ignition is turned to the 3 (RUN) position.

Unlocking and locking the doors using keyless entry

To unlock the driver's door, enter the factory set 5-digit code or your personal code. Each number must be pressed within five seconds of each other. The interior lamps will illuminate. **Note:** If the two-stage unlocking feature is disabled, all doors will unlock; for more information regarding two-stage unlocking, refer to the *Two stage unlocking* section earlier in this chapter.

To unlock all doors, enter the factory set code or your personal code, then press the 3 • 4 control within five seconds.

To lock all doors, press the 7 • 8 and the 9 • 0 at the same time (with the driver's door closed). You **do not** need to enter the keypad code first.

SECURILOCK™ PASSIVE ANTI-THEFT SYSTEM

SecuriLock™ passive anti-theft system is an engine immobilization system. This system is designed to help prevent the engine from being started unless a **coded Integrated Keyhead Transmitter (IKT) programmed to your vehicle** is used. The use of the wrong type of coded key may lead to a “no-start” condition.

Locks and Security

Your vehicle comes with two coded Integrated Keyhead Transmitters; additional coded IKTs may be purchased from your authorized dealer. Standard SecuriLock[™] keys without remote entry transmitter functionality can also be purchased from your authorized dealer if desired. The authorized dealer can program your spare IKTs to your vehicle or you can program the IKTs yourself. Refer to *Programming spare Integrated Keyhead Transmitters* for instructions on how to program the coded key.

Note: The SecuriLock[™] passive anti-theft system is not compatible with non-Ford aftermarket remote start systems. Use of these systems may result in vehicle starting problems and a loss of security protection.

Note: Large metallic objects, electronic devices that are used to purchase gasoline or similar items, or a second coded key on the same key chain may cause vehicle starting issues. You need to prevent these objects from touching the coded IKT while starting the engine. These objects will not cause damage to the coded IKT, but may cause a momentary issue if they are too close to the IKT when starting the engine. If a problem occurs, turn the ignition off, remove all objects on the key chain away from the coded IKT and restart the engine.

Anti-theft indicator

The anti-theft indicator is located in the instrument panel cluster.

- When the ignition is in the 1 (LOCK) position, the indicator will flash once every 2 seconds to indicate the SecuriLock[™] system is functioning as a theft deterrent.
- When the ignition is in the 3 (RUN) position, the indicator will glow for 3 seconds to indicate normal system functionality.



If a problem occurs with the SecuriLock[™] system, the indicator will flash rapidly or glow steadily when the ignition is in the 3 (RUN) position. If this occurs, the vehicle will not start and should be taken to an authorized dealer for service.

Automatic arming

The vehicle is armed immediately after switching the ignition to the 1 (LOCK) position.

Locks and Security

The theft indicator will flash every two seconds to act as a theft deterrent when the vehicle is armed.



Automatic disarming

The vehicle is disarmed immediately after the ignition is turned to the 3 (RUN) position.

The theft indicator will illuminate for three seconds and then go out. If the theft indicator stays on for an extended period of time or flashes rapidly, have the system serviced by your authorized dealer.

Replacement Integrated Keyless Transmitters (IKT) and coded keys

Note: Your vehicle comes equipped with two Integrated Keyhead Transmitters (IKTs). The IKT functions as both a programmed ignition key that operates all the locks and starts the vehicle, as well as a remote keyless entry transmitter. A maximum of eight coded keys can be programmed to your vehicle; only four of these eight keys can be IKTs with remote entry functionality.

If your IKTs or standard SecuriLock[™] coded keys are lost or stolen and you don't have an extra coded key, you will need to have your vehicle towed to an authorized dealer. The key codes need to be erased from your vehicle and new coded keys will need to be programmed.

Replacing coded keys can be very costly. Store an extra programmed key away from the vehicle in a safe place to help prevent any inconveniences. Please visit an authorized dealer to purchase additional spare or replacement keys.

Programming spare keys

You can program your own Integrated Keyhead Transmitters or standard SecuriLock[™] coded keys to your vehicle. This procedure will program both the engine immobilizer keycode and the remote entry transmitter portion of the IKT to your vehicle. **Note:** A maximum of eight coded keys can be programmed to your vehicle; only four of these eight can be IKTs with remote entry functionality.

Tips:

- Only use Integrated Keyhead Transmitters (IKTs) or standard SecuriLock[™] keys.
- You must have two previously programmed coded keys (keys that already operate your vehicle's engine) and the new unprogrammed key(s) readily accessible.

Locks and Security

- If two previously programmed coded keys are not available, you must take your vehicle to your authorized dealer to have the spare key(s) programmed.

Please read and understand the entire procedure before you begin.

1. Insert the first previously programmed **coded key** into the ignition.

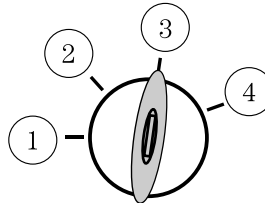

2. Turn the ignition from the 1 (LOCK) position to the 3 (RUN) position. Keep the ignition in the 3 (RUN) position for at least three seconds, but no more than 10 seconds.

3. Turn the ignition to the 1 (LOCK) position and remove the first **coded key** from the ignition.

4. Within ten seconds of turning the ignition to the 1 (LOCK) position, insert the second previously **coded key** into the ignition.

5. Turn the ignition from the 1 (LOCK) position to the 3 (RUN) position. Keep the ignition in the 3 (RUN) position for at least three seconds, but no more than 10 seconds.

6. Turn the ignition to the 1 (LOCK) position and remove the second previously programmed **coded key** from the ignition.

7. Within twenty seconds of turning the ignition to the 1 (LOCK) position and removing the previously programmed **coded key**, insert the new unprogrammed key (new key/valet key) into the ignition.

8. Turn the ignition from the 1 (LOCK) position to the 3 (RUN) position. Keep the ignition in the 3 (RUN) position for at least six seconds.

9. Remove the newly programmed **coded key** from the ignition.

If the key has been successfully programmed it will start the vehicle's engine and will operate the remote entry system (if the new key is an Integrated Keyhead Transmitter). The theft indicator light will illuminate for three seconds and then go out to indicate successful programming.

If the key was not successfully programmed, it will not start your vehicle's engine and/or will not operate the remote entry features. The theft indicator light may flash on and off. Wait 20 seconds and you may repeat Steps 1 through 8. If failure repeats, bring your vehicle to your authorized dealer to have the new key(s) programmed.

To program additional new unprogrammed key(s), wait twenty seconds and then repeat this procedure from Step 1.

Locks and Security

PERIMETER ALARM SYSTEM

The perimeter anti-theft system will help protect your vehicle from unauthorized entry.

If there is any potential perimeter anti-theft problem with your vehicle, ensure **ALL Integrated Keyhead Transmitters** are brought to the authorized dealer to aid in troubleshooting.

Arming the system

When armed, this system will respond if unauthorized entry is attempted. When unauthorized entry occurs, the system will flash the turn signal lamps and will sound the horn.

The system is ready to arm whenever the key is in the 1 (LOCK) position, or is removed from the ignition. Either of the following actions will prearm the alarm system:

- Press the  control on the remote entry transmitter portion of your Integrated Keyhead Transmitter.

When you press the lock control twice within five seconds on the remote entry transmitter portion of your IKT, the horn will chirp once to let you know that all doors, the hood and the liftgate are closed. If any of these are not closed, the horn will chirp twice to warn you that a door, the hood or the liftgate is still open.

- Press the driver or passenger interior door lock control while the door is open, then close the door.

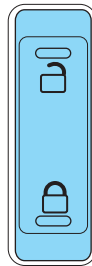

- Press the 7 • 8 and 9 • 0 controls on the keyless entry pad (if equipped) at the same time to lock the doors (driver's door must be closed).



There is a 20 second countdown when any of the above actions occur before the vehicle becomes armed.

Locks and Security

Each door, the hood, and the liftgate is armed individually, and if any are open, they must be closed before the open entry point (door, hood, or liftgate) can enter the 20 second countdown.

The turn signal lamps will flash once when all doors, the hood and the liftgate are closed indicating the vehicle is locked and entering the 20 second countdown.

Disarming the system

You can disarm the system by any of the following actions:

- Unlock the doors by using the remote entry transmitter portion of your Integrated Keyhead Transmitter.
- Unlock the doors by using your keyless entry pad (if equipped).
- Unlock the driver's door with a key. Turn the key full rearward (toward the rear of the vehicle) to ensure the alarm disarms.
- Turn ignition to the 3 (ON) position with a valid SecuriLock[™] key or Integrated Keyhead Transmitter (IKT).
- Press the panic control on the remote entry transmitter portion of your IKT. This will only shut off the horn and turn lamps when the alarm is sounding. The alarm system will still be armed.

Pressing the power door UNLOCK control within the 20 second prearmed mode will return the vehicle to a disarmed state.

Triggering the anti-theft system

The armed system will be triggered if:

- Any door, the hood or the liftgate is opened without using the door key, keypad or the remote entry transmitter portion of your IKT.
- The ignition is turned to the 3 (ON) position with an invalid SecuriLock[™] key or IKT.

Seating and Safety Restraints

SEATING

Notes:



Reclining the seatback can cause an occupant to slide under the seat's safety belt, resulting in severe personal injuries in the event of a collision.



Do not pile cargo higher than the seatbacks to reduce the risk of injury in a collision or sudden stop.



Before returning the seatback to its original position, make sure that cargo or any objects are not trapped behind the seatback. After returning the seatback to its original position, pull on the seatback to ensure that it has fully latched. An unlatched seat may become dangerous in the event of a sudden stop or collision.

Adjustable head restraints

Head restraints help to limit head motion in the event of a rear collision. Adjust your head restraint so that it is located directly or as close as possible behind your head.

The head restraints can be moved up by pulling up on the head restraint.

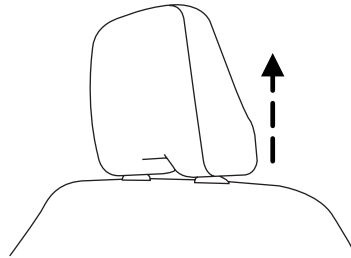

Seating and Safety Restraints

Push release button to lower head restraint.

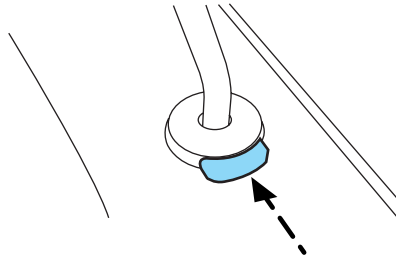

Using the manual lumbar support (if equipped)

The lumbar control is located on the side of the seat cushion.

Lift up or down to adjust lumbar support.

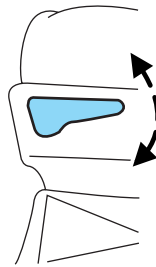

Adjusting the front power seat



Never adjust the driver's seat or seatback when the vehicle is moving.



Do not pile cargo higher than the seatbacks to reduce the risk of injury in a collision or sudden stop.





Always drive and ride with your seatback upright and the lap belt snug and low across the hips.



Reclining the seatback can cause an occupant to slide under the seat's safety belt, resulting in severe personal injuries in the event of a collision.

Seating and Safety Restraints

 Sitting improperly out of position or with the seat back reclined too far can take off weight from the seat cushion and affect the decision of the front passenger sensing system, resulting in serious injury or death in a crash. Always sit upright against your seatback, with your feet on the floor.

 To reduce the risk of possible serious injury: Do not hang objects off seat back or stow objects in the seatback map pocket (if equipped) when a child is in the front passenger seat. Do not place objects underneath the front passenger seat or between the seat and the center console (if equipped). Check the “passenger airbag off” or “pass airbag off” indicator lamp for proper airbag status. Refer to *Front passenger sensing system* section for additional details. Failure to follow these instructions may interfere with the front passenger seat sensing system.

The control is located on the outboard side of the seat cushion.

Press the switch in the direction of the arrows to move the seat forward, backward, up or down.

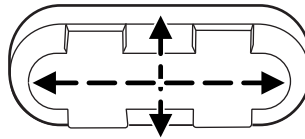

Tilt Function

Move the switch in the direction of the arrows to tilt the seat forward or backward.

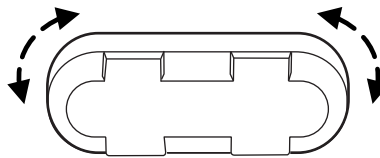

Seating and Safety Restraints

Power recline (if equipped)

Press the control to recline the seatback forward or rearward.

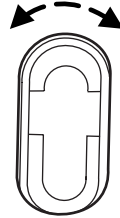

Using the power lumbar support (if equipped)

The power lumbar control is located on the outboard side of the seat.

Press one side of the control to adjust firmness.

Press the other side of the control to adjust softness.

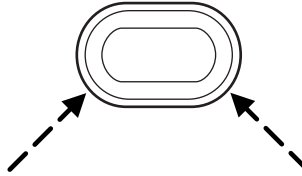

Memory seat and mirrors (if equipped)

This system allows automatic positioning of the driver seat and outside rearview mirrors, to two programmable positions.

The memory seat control is located on the driver door.

- To program position one, move the driver seat and exterior mirrors to the desired positions using the associated controls. Press the SET control. The SET control light will briefly illuminate. While the light is illuminated, press control 1.
- To program position two, repeat the previous procedure using control 2.

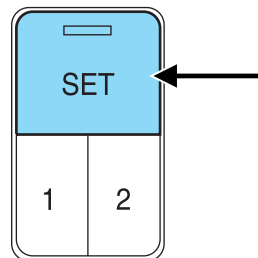

Seating and Safety Restraints

A position can only be recalled when the transmission gearshift is in Park (automatic transmission). A memory seat position may be programmed at any time.

The memory seat positions are also recalled when you press your remote entry transmitter UNLOCK control and the transmitter is programmed to a memory seat position or when you enter a valid customer code 1 or 2 on the keypad.

To program the memory seat to remote entry transmitter, refer to *Remote entry system* in the *Locks and Security* chapter.

Note: The seat will not travel to its final position if the key is not in the ignition and the easy entry feature is enabled.

Easy-entry/easy-exit feature (if equipped)

This feature automatically moves the driver's seat rearward 2 inches (5 cm) when:

- the transmission is in N (Neutral) or P (Park)
- the key is removed from the ignition cylinder

The seat will move forward (to the original position) when:

- the transmission is in N (Neutral) or P (Park)
- the key is placed in the ignition cylinder

Heated seats (if equipped)

The heated seats will only function when the ignition is in RUN.

To operate the heated seats:

- Push the control located on the climate control system panel once to activate high heat.
- Push twice to activate low heat.
- Push a third time to deactivate.



The indicator light on the control will illuminate when activated. For low heat, one light will be lit; for high heat, both lights will be lit.

Seating and Safety Restraints

Heated and cooled seats (if equipped)

Heated seats

The heated seats will only function when the engine is running.

To operate the heated seats:

Press once to activate the high heat setting (3 indicator lights). Continue pressing to scroll through the other settings; medium heat (2 indicator lights), low heat (1 indicator light) or off.



The heated seats will turn off after 15 minutes.

If the vehicle falls below 350 RPMs while the heated seats are on, the feature will turn itself off and will need to be reactivated.

Cooled seats

The cooled seats will only function when the engine is running.

To operate the cooled seats:

Press once to activate the high cool setting (3 indicator lights). Continue pressing to scroll through the other settings; medium cool (2 indicator lights), low cool (1 indicator light) or off.



The cooled seats will turn off after 30 minutes.

If the vehicle falls below 350 RPMs while the cooled seats are on, the feature will turn itself off and will need to be reactivated.

Climate controlled seats air filter replacement (if equipped)

The climate controlled seat system includes air filters that must be replaced periodically. Refer to the *Scheduled Maintenance Guide* for more information.

Seating and Safety Restraints

- There is a filter located under each front seat.

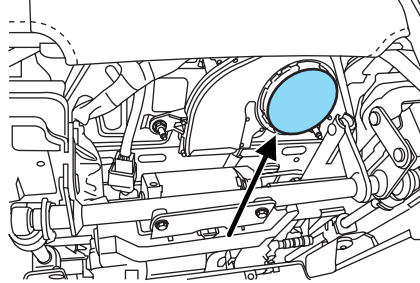

- The filter can be accessed from the first row seat. Move the front seats all the way back and up to ease access.

To remove an air filter:

- Remove key from ignition.
- Push up on the outside rigid edge of the filter and rotate toward the front of the vehicle once tabs are released.

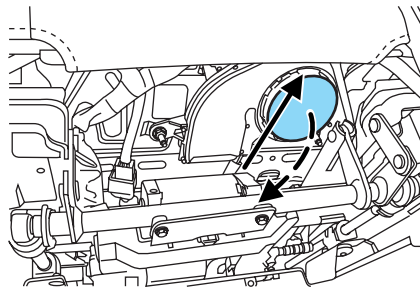

- Remove filter.

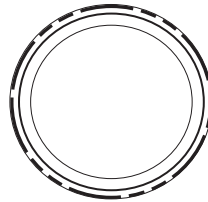

Seating and Safety Restraints

To install a filter:

- First, position the filter in it's housing making sure that the far forward end is all the way up in the housing. Then push in on the center of the outside edge of the filter and rotate up into the housing until it clips into position.

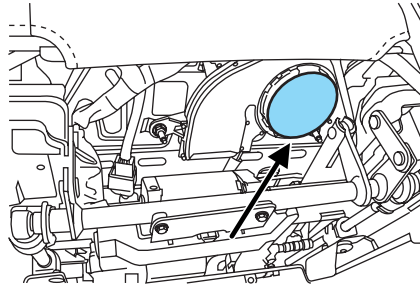

REAR SEATS

Head restraints

Lift the head restraint so that it is located directly or as close as possible behind your head.

The head restraints can be moved up by pulling up on the head restraint.

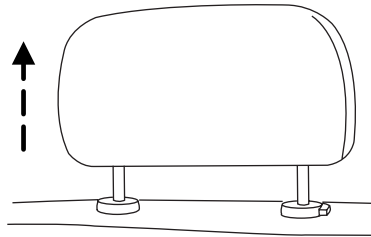

Push release button to lower head restraint.

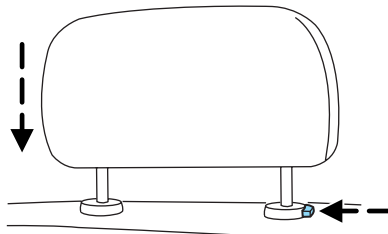

Seating and Safety Restraints

Folding down the 60/40 rear seats

Note: The head restraints should be placed in the full down position before folding the seatback down.

Note: Ensure that no objects such as books, purses, or briefcases are on the floor in front of, are on, or under the second row seat cushion before actuating the release lever to cycle the seats to the load-floor position.

 To prevent possible damage to the seat or safety belts, ensure that the safety belts are not buckled when moving the seat to the load floor position.

2nd row manual folding seat

To fold down the rear seat, pull up on the lever on the outboard side of the seat cushion and let the seatback rotate downward into the load floor position.

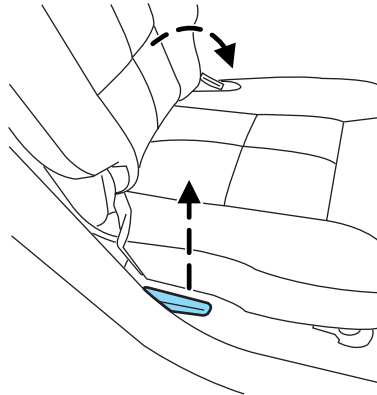

2nd row EasyFold™ seatback release (if equipped)

 Ensure that the seat is unoccupied when folding it down. Folding the seat while occupied could result in damage to the seat or injury.

Note: The power feature is operational when the vehicle is in park and the liftgate has been open for less than 10 minutes.

The control buttons are located on the left-hand rear quarter trim panel (accessible from the liftgate area).

Seating and Safety Restraints

Press and hold the control mechanism to lower the seatback. The top portion lowers the right (40%) seatback, and the bottom portion lowers the left (60%) seatback.

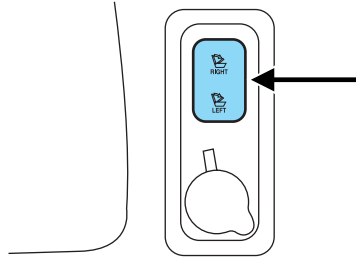

Returning the 2nd row seatback to the upright position

 Before returning the seatback to its original position, make sure that cargo or any objects are not trapped behind the seatback. After returning the seatback to its original position, pull on the seatback to ensure that the latches are engaged. An unlatched seat may become dangerous in the event of a sudden stop or collision.

Rotate the seatback upward until the seatback latches in the upright position. The seatback will click when it is locked into position.

Adjusting the second row seatback

 Reclining the seatback can cause an occupant to slide under the seat's safety belt, resulting in severe personal injuries in the event of a collision.

The second row seat reclines for additional comfort. To adjust the second row seatback to the desired position, while seated, pull the release lever up and push the seatback rearward.

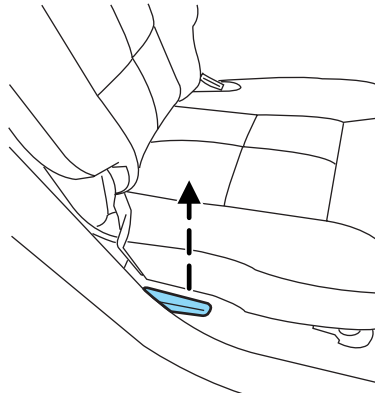

Seating and Safety Restraints

Seat mounted armrest and cupholders

Your vehicle is equipped with a rear seat armrest. To fold the armrest down, release the latch located on the seatback by pressing down and pulling forward.

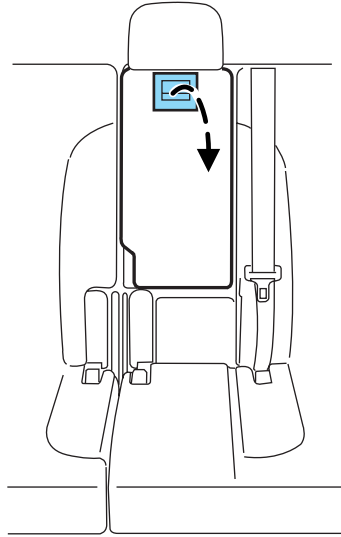

To access the cup holders, lift up one of the slotted areas on the cover.

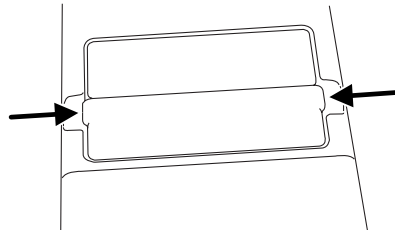

Use only soft cups in the cupholder. Hard objects can injure you in a collision.

Returning the 2nd row armrest to the upright position

Close the cover on the cup holders. Rotate the armrest rearward until the armrest is in the latched position. The armrest will click when it is latched into position.

Seating and Safety Restraints

Rear heated seats (if equipped)

The rear seat heat controls are located on the rear door panels.

To operate the heated seats:

- Push the indicated side of the control for maximum heat.
- Push again to deactivate.

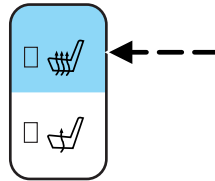

- Push the indicated side of the control for minimum heat.
- Push again to deactivate.

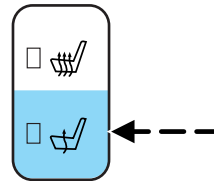

The heated seat module resets at every ignition run cycle. While the ignition is in the ON position, activating the high or low heated seat switch enables heating mode. When activated, they will turn off automatically when the engine is turned off.

The indicator light will illuminate when the heated seats have been activated.

SAFETY RESTRAINTS

Personal Safety System™

The Personal Safety System™ provides an improved overall level of frontal crash protection to front seat occupants and is designed to help further reduce the risk of airbag-related injuries. The system is able to analyze different occupant conditions and crash severity before activating the appropriate safety devices to help better protect a range of occupants in a variety of frontal crash situations.

Your vehicle's Personal Safety System™ consists of:

- Driver and passenger dual-stage airbag supplemental restraints.
- Front outboard safety belts with pretensioners, energy management retractors (first row only), and safety belt usage sensors.
- Driver's seat position sensor.

Seating and Safety Restraints

- Front passenger sensing system
- “Passenger airbag off” or “pass airbag off” indicator lamp
- Front crash severity sensors.
- Restraints Control Module (RCM) with impact and safing sensors.
- Restraint system warning light and back-up tone.
- The electrical wiring for the airbags, crash sensor(s), safety belt pretensioners, front safety belt usage sensors, driver seat position sensor, front passenger sensing system, and indicator lights.

How does the Personal Safety System™ work?

The Personal Safety System™ can adapt the deployment strategy of your vehicle’s safety devices according to crash severity and occupant conditions. A collection of crash and occupant sensors provides information to the Restraints Control Module (RCM). During a crash, the RCM activates the safety belt pretensioners and/or either one or both stages of the dual-stage airbag supplemental restraints based on crash severity and occupant conditions.

The fact that the pretensioners or airbags did not activate for both front seat occupants in a collision does not mean that something is wrong with the system. Rather, it means the Personal Safety System™ determined the accident conditions (crash severity, belt usage, etc.) were not appropriate to activate these safety devices. Front airbags are designed to activate only in frontal and near-frontal collisions (not rollovers, side impacts or rear impacts) unless the collision causes sufficient longitudinal deceleration. The pretensioners are designed to activate in frontal and near-frontal collisions, and in rollovers and side collisions when the Safety Canopy is activated.

Driver and passenger dual-stage airbag supplemental restraints

The dual-stage airbags offer the capability to tailor the level of airbag inflation energy. A lower, less forceful energy level is provided for more common, moderate-severity impacts. A higher energy level is used for the most severe impacts. Refer to *Airbag supplemental restraints* section in this chapter.

Front crash severity sensor

The front crash severity sensor enhances the ability to detect the severity of an impact. Positioned up front, it provides valuable information early in the crash event on the severity of the impact. This allows your Personal Safety System™ to distinguish between different

Seating and Safety Restraints

levels of crash severity and modify the deployment strategy of the dual-stage airbags and safety belt pretensioners.

Driver's seat position sensor

The driver's seat position sensor allows your Personal Safety System™ to tailor the deployment level of the driver dual-stage airbag based on seat position. The system is designed to help protect smaller drivers sitting close to the driver airbag by providing a lower airbag output level.

Front passenger sensing system

For airbags to do their job they must inflate with great force, and this force can pose a potentially deadly risk to occupants that are very close to the airbag when it begins to inflate. For some occupants, this occurs because they are initially sitting very close to the airbag. For other occupants, this occurs when the occupant is not properly restrained by safety belts or child safety seats and they move forward during pre-crash braking. The most effective way to reduce the risk of unnecessary injuries is to make sure all occupants are properly restrained. Accident statistics suggest that children are much safer when properly restrained in the rear seating positions than in the front.



Air bags can kill or injure a child in a child seat. **NEVER** place a rear-facing child seat in front of an active air bag. If you must use a forward-facing child seat in the front seat, move the seat all the way back.



Always transport children 12 years old and under in the back seat and always properly use appropriate child restraints.

The front passenger sensing system can automatically turn off the front passenger airbag and passenger seat-mounted side airbag. The system is designed to help protect small (child size) occupants from frontal airbag deployments when they are seated or restrained in the front passenger seat contrary to proper child-seating or restraint usage recommendations. Even with this technology, parents are **STRONGLY** encouraged to always properly restrain children in the rear seat. The sensor also turns off the passenger front airbag and passenger seat-mounted side airbag (if equipped) when the passenger seat is empty and the safety belt is unbuckled.

Front safety belt usage sensors

The front safety belt usage sensors detect whether or not the driver and front outboard passenger safety belts are fastened. This information

Seating and Safety Restraints

allows your Personal Safety System™ to tailor the airbag deployment and safety belt pretensioner activation depending upon safety belt usage. Refer to *Safety belt* section in this chapter.

Front safety belt pretensioners

The safety belt pretensioners at the front outboard seating positions are designed to tighten the safety belts firmly against the occupant's body during frontal collisions, and in rollover and side collisions when the Safety Canopy is activated. This helps increase the effectiveness of the safety belts. In frontal collisions, the safety belt pretensioners can be activated alone or, if the collision is of sufficient severity, together with the front airbags.

Front safety belt energy management retractors

The front outboard safety belt energy management retractors allow webbing to be pulled out of the retractor in a gradual and controlled manner in response to the occupant's forward momentum. This helps reduce the risk of force-related injuries to the occupant's chest by limiting the load on the occupant. Refer to *Energy management feature* section in this chapter.

Determining if the Personal Safety System™ is operational

The Personal Safety System™ uses a warning light in the instrument cluster or a back-up tone to indicate the condition of the system. Refer to the *Warning light* section in the *Instrument Cluster* chapter. Routine maintenance of the Personal Safety System™ is not required.

The Restraints Control Module (RCM) monitors its own internal circuits and the circuits for the airbag supplemental restraints, crash sensor(s), safety belt pretensioners, front safety belt buckle sensors, driver seat position sensor, and front passenger sensing system. In addition, the RCM also monitors the restraints warning light in the instrument cluster. A difficulty with the system is indicated by one or more of the following.

- The warning light will either flash or stay lit.
- The warning light will not illuminate immediately after ignition is turned on.
- A series of five beeps will be heard. The tone pattern will repeat periodically until the problem and warning light are repaired.

If any of these things happen, even intermittently, have the Personal Safety System™ serviced at an authorized dealer immediately. Unless serviced, the system may not function properly in the event of a collision.

Seating and Safety Restraints

Safety belt precautions



Always drive and ride with your seatback upright and the lap belt snug and low across the hips.



To reduce the risk of injury, make sure children sit where they can be properly restrained.



Never let a passenger hold a child on his or her lap while the vehicle is moving. The passenger cannot protect the child from injury in a collision.



All occupants of the vehicle, including the driver, should always properly wear their safety belts, even when an air bag supplemental restraint system (SRS) is provided.



It is extremely dangerous to ride in a cargo area, inside or outside of a vehicle. In a collision, people riding in these areas are more likely to be seriously injured or killed. Do not allow people to ride in any area of your vehicle that is not equipped with seats and safety belts. Be sure everyone in your vehicle is in a seat and using a safety belt properly.



In a rollover crash, an unbelted person is significantly more likely to die than a person wearing a seat belt.



Each seating position in your vehicle has a specific safety belt assembly which is made up of one buckle and one tongue that are designed to be used as a pair. 1) Use the shoulder belt on the outside shoulder only. Never wear the shoulder belt under the arm. 2) Never swing the safety belt around your neck over the inside shoulder. 3) Never use a single belt for more than one person.



Always transport children 12 years old and under in the back seat and always properly use appropriate child restraints.

Seating and Safety Restraints

Combination lap and shoulder belts

1. Insert the belt tongue into the proper buckle (the buckle closest to the direction the tongue is coming from) until you hear a snap and feel it latch. Make sure the tongue is securely fastened in the buckle.

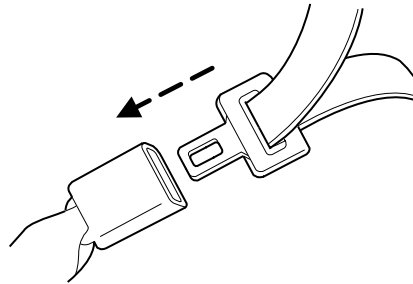

2. To unfasten, push the release button and remove the tongue from the buckle.

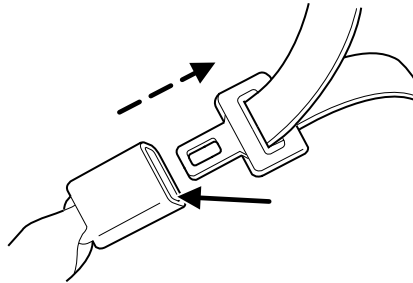

All restraints in the vehicle are combination lap and shoulder belts.

While you are fastened in the safety belt, the combination lap/shoulder belt adjusts to your movement. However, if you brake hard, turn hard, or if your vehicle receives an impact of 5 mph (8 km/h) or more, the safety belt will become locked and help reduce your forward movement.

Energy Management Feature — Front Outboard

- This vehicle has a safety belt system with an energy management feature at the front seats to help further reduce the risk of injury in the event of a head-on collision.
- This safety belt system has a retractor assembly that is designed to extend the safety belt webbing in a controlled manner. This helps reduce the belt force acting on the user's chest.

 Failure to inspect and replace if necessary the Belt and Retractor assembly after an accident could increase the risk of injury in a collision.

Seating and Safety Restraints

All safety restraints in the vehicle are combination lap and shoulder belts. All of the passenger combination lap and shoulder belts have two types of locking modes described below:

Vehicle sensitive mode

This is the normal retractor mode, which allows free shoulder belt length adjustment to your movements and locking in response to vehicle movement. For example, if the driver brakes suddenly or turns a corner sharply, or the vehicle receives an impact of approximately 5 mph (8 km/h) or more, the combination safety belts will lock to help reduce forward movement of the driver and passengers.

Automatic locking mode

How to use the automatic locking mode

- Buckle the combination lap and shoulder belt.

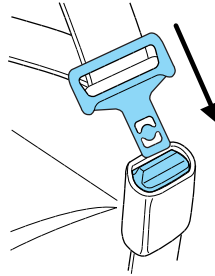

- Grasp the shoulder portion and pull downward until the entire belt is pulled out.



- Allow the belt to retract. As the belt retracts, you will hear a clicking sound. This indicates the safety belt is now in the automatic locking mode.

Seating and Safety Restraints

When to use the automatic locking mode

In this mode, the shoulder belt is automatically pre-locked. The belt will still retract to remove any slack in the shoulder belt. The automatic locking mode is not available on the driver safety belt.

This mode should be used **any time** a child safety seat, except a booster, is installed in passenger front or rear seating positions. Children 12 years old and under should be properly restrained in the rear seat whenever possible. Refer to *Safety restraints for children* or *Safety seats for children* later in this chapter.

How to disengage the automatic locking mode



Ford Motor Company recommends that all passenger safety belt assemblies and attaching hardware should be inspected by an authorized dealer after any collision to verify that the "automatic locking retractor" feature for child seats is still working properly. Safety belt assemblies should be inspected by an authorized dealer and must be replaced if either damage or improper operation is noted. Failure to replace the belt and retractor assembly could increase the risk of injury in a collision.

Unbuckle the combination lap/shoulder belt and allow it to retract completely to disengage the automatic locking mode and activate the vehicle sensitive (emergency) locking mode.

Safety belt pretensioner

Your vehicle is equipped with safety belt pretensioners at the driver and front outboard passenger seating positions.

The safety belt pretensioner tightens the safety belts firmly against the occupant's body at the start of the crash.



The driver and front passenger safety belt system (including retractors, buckles and height adjusters) must be replaced if the vehicle is involved in a collision that results in deployment of front airbags, seat-mounted side airbags and Safety Canopy[™], and safety belt pretensioners.

Seating and Safety Restraints

Safety belt height adjustment

Your vehicle has safety belt height adjustments at the front outboard seating positions. Adjust the height of the shoulder belt so the belt rests across the middle of your shoulder.

To adjust the shoulder belt height, pull on the center button and slide the height adjuster up or down. Release the button and pull down on the height adjuster to make sure it is locked in place.

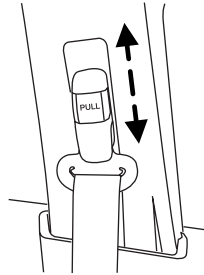

Position the safety belt height adjusters so that the belt rests across the middle of your shoulder. Failure to adjust the safety belt properly could reduce the effectiveness of the safety belt and increase the risk of injury in a collision.

Second row comfort guide

The second row outboard lap/shoulder belt is equipped with a belt comfort guide. This guide is attached to the head restraint and is stored in a pocket in the seatback. It is used to adjust the comfort of the shoulder belt for smaller occupants in the outboard second row seats.

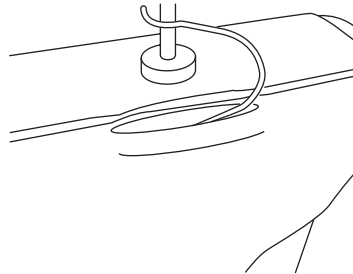

Seating and Safety Restraints

To adjust the comfort guide:

1. Slip the shoulder belt into the belt guide.
2. Slide the guide up or down along the webbing so that the belt is centered on the occupant's shoulder.

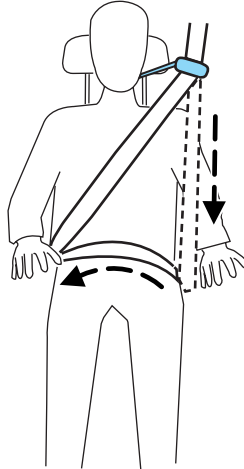

Position the safety belt comfort guide so that the belt rests across the middle of your shoulder. Failure to adjust the safety belt properly could reduce the effectiveness of the safety belt and increase the risk of injury in a collision.

Safety belt extension assembly

If the safety belt is too short when fully extended, there is a 8 inch (20 cm) safety belt extension assembly that can be added (part number 611C22). This assembly can be obtained from an authorized dealer.

Use only extensions manufactured by the same supplier as the safety belt. Manufacturer identification is located at the end of the webbing on the label. Also, use the safety belt extension only if the safety belt is too short for you when fully extended.



Do not use extensions to change the fit of the shoulder belt across the torso.

Seating and Safety Restraints

Safety belt maintenance

Inspect the safety belt systems periodically to make sure they work properly and are not damaged. Inspect the safety belts to make sure there are no nicks, tears or cuts. Replace if necessary. All safety belt assemblies, including retractors, buckles, front safety belt buckle assemblies, buckle support assemblies (slide bar-if equipped), shoulder belt height adjusters (if equipped), shoulder belt guide on seatback (if equipped), child safety seat LATCH and tether anchors, and attaching hardware, should be inspected after a collision. Ford Motor Company recommends that all safety belt assemblies in use in vehicles involved in a collision be replaced. However, if the collision was minor and an authorized dealer finds that the belts do not show damage and continue to operate properly, they do not need to be replaced. Safety belt assemblies not in use during a collision should also be inspected and replaced if either damage or improper operation is noted.



Failure to inspect and if necessary replace the safety belt assembly under the above conditions could result in severe personal injuries in the event of a collision.

For proper care of soiled safety belts, refer to *Interior* in the *Cleaning* chapter.

Safety belt warning light and indicator chime

The safety belt warning light illuminates in the instrument cluster and a chime sounds to remind the occupants to fasten their safety belts.

Conditions of operation

If...	Then...
The driver's safety belt is not buckled before the ignition switch is turned to the ON position...	The safety belt warning light illuminates 1-2 minutes and the warning chime sounds 4-8 seconds.
The driver's safety belt is buckled while the indicator light is illuminated and the warning chime is sounding...	The safety belt warning light and warning chime turn off.
The driver's safety belt is buckled before the ignition switch is turned to the ON position...	The safety belt warning light and indicator chime remain off.

Seating and Safety Restraints

Belt-Minder®

The Belt-Minder® feature is a supplemental warning to the safety belt warning function. This feature provides additional reminders by intermittently sounding a chime and illuminating the safety belt warning light in the instrument cluster when the driver's and front passenger's safety belt is unbuckled.

The Belt-Minder® feature uses information from the front passenger sensing system to determine if a front seat passenger is present and therefore potentially in need of a warning. To avoid activating the Belt-Minder® feature for objects placed in the front passenger seat, warnings will only be given to large front seat occupants as determined by the front passenger sensing system.

Both the driver's and passenger's safety belt usages are monitored and either may activate the Belt-Minder® feature. The warnings are the same for the driver and the front passenger. If the Belt-Minder® warnings have expired (warnings for approximately 5 minutes) for one occupant (driver or front passenger), the other occupant can still activate the Belt-Minder® feature.

If...	Then...
The driver's and front passenger's safety belts are buckled before the ignition switch is turned to the ON position or less than 1-2 minutes have elapsed since the ignition switch has been turned ON...	The Belt-Minder® feature will not activate.
The driver's or front passenger's safety belt is not buckled when the vehicle has reached at least 3 mph (5 km/h) and 1-2 minutes have elapsed since the ignition switch has been turned to ON...	The Belt-Minder® feature is activated - the safety belt warning light illuminates and the warning chime sounds for 6 seconds every 30 seconds, repeating for approximately 5 minutes or until the safety belts are buckled.

Seating and Safety Restraints

If...	Then...
The driver's or front passenger's safety belt becomes unbuckled for approximately 1 minute while the vehicle is traveling at least 3 mph (5 km/h) and more than 1-2 minutes have elapsed since the ignition switch has been turned to ON...	The Belt-Minder® feature is activated - the safety belt warning light illuminates and the warning chime sounds for 6 seconds every 30 seconds, repeating for approximately 5 minutes or until the safety belts are buckled.

The following are reasons most often given for not wearing safety belts (All statistics based on U.S. data):

Reasons given...	Consider...
"Crashes are rare events"	36700 crashes occur every day. The more we drive, the more we are exposed to "rare" events, even for good drivers. <i>1 in 4 of us will be seriously injured in a crash during our lifetime.</i>
"I'm not going far"	3 of 4 fatal crashes occur within 25 miles (40 km) of home.
"Belts are uncomfortable"	We design our safety belts to enhance comfort. If you are uncomfortable - try different positions for the safety belt upper anchorage and seatback which should be as upright as possible; this can improve comfort.
"I was in a hurry"	Prime time for an accident. Belt-Minder® reminds us to take a few seconds to buckle up.
"Safety belts don't work"	Safety belts , when used properly, reduce risk of death to front seat occupants by 45% in cars , and by 60% in light trucks .

Seating and Safety Restraints

Reasons given...	Consider...
“Traffic is light”	Nearly 1 of 2 deaths occur in single-vehicle crashes , many when no other vehicles are around.
“Belts wrinkle my clothes”	Possibly, but a serious crash can do much more than wrinkle your clothes, particularly if you are unbelted.
“The people I’m with don’t wear belts”	Set the example, teen deaths occur 4 times more often in vehicles with TWO or MORE people. Children and younger brothers/sisters imitate behavior they see.
“I have an airbag”	Airbags offer greater protection when used with safety belts. Frontal airbags are not designed to inflate in rear and side crashes or rollovers.
“I’d rather be thrown clear”	Not a good idea. People who are ejected are 40 times more likely to DIE . Safety belts help prevent ejection, WE CAN’T “PICK OUR CRASH”.



Do not sit on top of a buckled safety belt or insert a latchplate into the buckle to avoid the Belt-Minder® chime. To do so may adversely affect the performance of the vehicle’s air bag system.

One time disable

If at any time the driver/front passenger quickly buckles then unbuckles the safety belt for that seating position, the Belt-Minder® is disabled for the current ignition cycle. The Belt-Minder® feature will enable during the same ignition cycle if the occupant buckles and remains buckled for approximately 30 seconds. Confirmation is not given for the one time disable.

Deactivating/activating the Belt-Minder® feature

The driver and front passenger Belt-Minder® are deactivated/activated independently. When deactivating/activating one seating position, do not buckle the other position as this will terminate the process.

Seating and Safety Restraints

Read Steps 1 - 4 thoroughly before proceeding with the deactivation/activation programming procedure.

Note: The driver and front passenger Belt-Minder® features must be disabled/enabled separately. Both cannot be disabled/enabled during the same key cycle.

The driver and front passenger Belt-Minder® features can be deactivated/activated by performing the following procedure:

Before following the procedure, make sure that:

- The parking brake is set
- The gearshift is in N (Neutral) (manual transmission)
- The gearshift is in P (Park) (automatic transmission)
- The ignition switch is in the OFF position
- The driver and front passenger safety belts are unbuckled



While the design allows you to deactivate your Belt-Minder®, this system is designed to improve your chances of being safely belted and surviving an accident. We recommend you leave the Belt-Minder® system activated for yourself and others who may use the vehicle. To reduce the risk of injury, do not deactivate/activate the Belt-Minder® feature while driving the vehicle.

1. Turn the ignition switch to the RUN (or ON) position. (DO NOT START THE ENGINE)
2. Wait until the safety belt warning light turns off. (Approximately 1–2 minutes)
 - Step 3 must be completed within 50 seconds after the safety belt warning light turns off.
3. For the seating position being disabled, at a moderate speed, buckle then unbuckle the safety belt 9 times, ending in the unbuckled state. (Step 3 must be completed within 50 seconds after the safety belt warning light turns off.)
 - After Step 3, the safety belt warning light will be turned on for three seconds.
4. Within approximately 7 seconds of the light turning off, buckle then unbuckle the safety belt.
 - This will disable the Belt-Minder® feature for that seating position if it is currently enabled. As confirmation, the safety belt warning light will flash 4 times per second for 3 seconds.

Seating and Safety Restraints

- This will enable the Belt-Minder® feature for that seating position if it is currently disabled. As confirmation, the safety belt warning light will flash 4 times per second for 3 seconds, followed by 3 seconds with the light off, then followed by the safety belt warning light flashing 4 times per second for 3 seconds again.

AIRBAG SUPPLEMENTAL RESTRAINT SYSTEM (SRS)

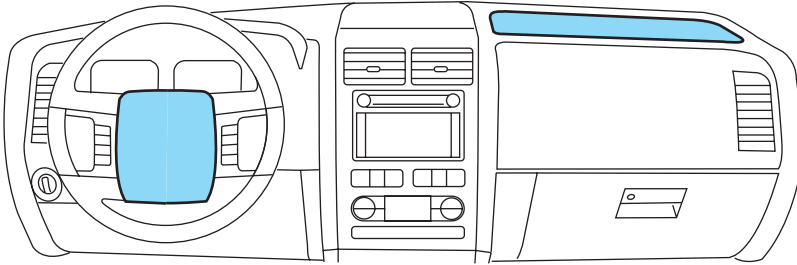

Important supplemental restraint system precautions

Airbags DO NOT inflate slowly or gently and the risk of injury from a deploying airbag is greatest close to the trim covering the airbag module.

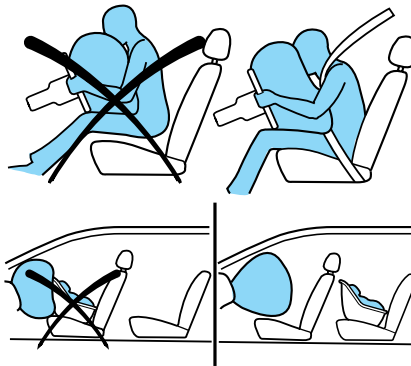

 All occupants of the vehicle, including the driver, should always properly wear their safety belts, even when an air bag supplemental restraint system (SRS) is provided.

 Always transport children 12 years old and under in the back seat and always properly use appropriate child restraints.

Seating and Safety Restraints

 National Highway Traffic Safety Administration (NHTSA) recommends a minimum distance of at least 10 inches (25 cm) between an occupant's chest and the driver airbag module.

 Never place your arm over the airbag module as a deploying airbag can result in serious arm fractures or other injuries.

Steps you can take to properly position yourself away from the airbag:

- Move your seat to the rear as far as you can while still reaching the pedals comfortably.
- Recline the seat slightly (one or two degrees) from the upright position.

 Do not put anything on or over the airbag module. Placing objects on or over the airbag inflation area may cause those objects to be propelled by the airbag into your face and torso causing serious injury.

 Do not attempt to service, repair, or modify the airbag supplemental restraint system (SRS) or its fuses. See your authorized dealer.

 Modifying or adding equipment to the front end of the vehicle (including frame, bumper, front end body structure and tow hooks) may affect the performance of the airbag system, increasing the risk of injury. Do not modify the front end of the vehicle.

Seating and Safety Restraints

Children and airbags

Children must always be properly restrained. Accident statistics suggest that children are safer when properly restrained in the rear seating positions than in the front seating position. Failure to follow these instructions may increase the risk of injury in a collision.

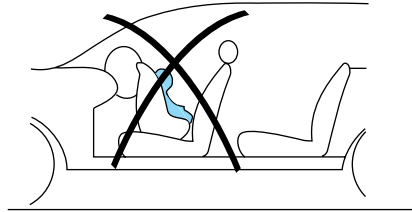

Airbags can kill or injure a child in a child seat.

NEVER place a rear-facing child seat in front of an active airbag. If you must use a forward-facing child seat in the front seat, move the seat all the way back.

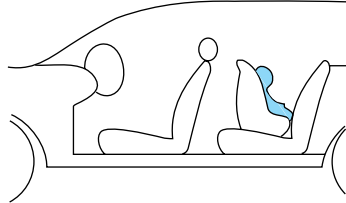

How does the safety belt pretensioner and airbag supplemental restraint system work?

The safety belt pretensioner and airbag SRS are designed to activate when the vehicle sustains longitudinal deceleration sufficient to cause the sensors to close an electrical circuit that initiates pretensioner activation and airbag inflation.

The fact that the airbags did not activate in a collision does not mean that something is wrong with the system. Rather, it means the forces were not of the type sufficient to cause activation. Front airbags are designed to activate in frontal and near-frontal collisions, not rollover, side-impact, or rear-impacts unless the collision causes sufficient longitudinal deceleration.

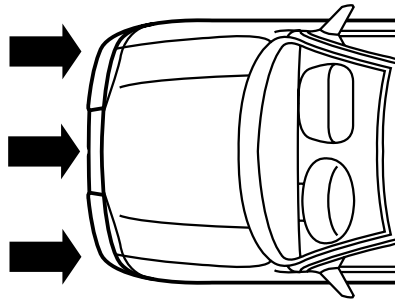

Seating and Safety Restraints

The airbags inflate and deflate rapidly upon activation. After airbag deployment, it is normal to notice a smoke-like, powdery residue or smell the burnt propellant. This may consist of cornstarch, talcum powder (to lubricate the bag) or sodium compounds (e.g., baking soda) that result from the combustion process that inflates the airbag. Small amounts of sodium hydroxide may be present which may irritate the skin and eyes, but none of the residue is toxic.



While the system is designed to help reduce serious injuries, contact with a deploying airbag may also cause abrasions, swelling or temporary hearing loss. Because airbags must inflate rapidly and with considerable force, there is the risk of death or serious injuries such as fractures, facial and eye injuries or internal injuries, particularly to occupants who are not properly restrained or are otherwise out of position at the time of airbag deployment. Thus, it is extremely important that occupants be properly restrained as far away from the airbag module as possible while maintaining vehicle control.



Several air bag system components get hot after inflation. Do not touch them after inflation.



If the air bag has deployed, **the air bag will not function again and must be replaced immediately.** If the air bag is not replaced, the unrepaired area will increase the risk of injury in a collision.

The SRS consists of:

- driver and passenger airbag modules (which include the inflators and airbags)
- seat-mounted side airbags (if equipped). Refer to *Seat-mounted side airbag system* later in this chapter
- safety belt pretensioners
- one or more impact and safing sensors

158

Seating and Safety Restraints

- a readiness light and tone
- and the electrical wiring which connects the components
- Side curtain airbag system. Refer to *Safety Canopy™ system* later in this chapter.
- Front passenger sensing system. Refer to *Front passenger sensing system*. later in this chapter.
- “Passenger airbag off” or “pass airbag off” indicator lamp. Refer to *Front passenger sensing system*. later in this chapter.

The diagnostic module monitors its own internal circuits and the supplemental airbag electrical system wiring (including the impact sensors), the system wiring, the airbag system readiness light, the airbag back up power, the airbag ignitors and safety belt pretensioners.

Front passenger sensing system

The front passenger sensing system is designed to meet the regulatory requirements of Federal Motor Vehicle Safety Standard (FMVSS) 208 and is designed to disable (will not inflate) the front passenger’s frontal airbag under certain conditions.

The front passenger sensing system works with sensors that are part of the front passenger’s seat and safety belt. The sensors are designed to detect the presence of a properly seated occupant and determine if the front passenger’s frontal airbag should be enabled (may inflate) or disabled (will not inflate).

The front passenger sensing system will disable (will not inflate) the front passenger’s frontal airbag if:

- the front passenger seat is unoccupied, or has small/medium objects in the front seat.
- the system determines that an infant is present in a rear-facing infant seat that is installed according to the manufacturer’s instructions.
- the system determines that a small child is present in a forward-facing child restraint that is installed according to the manufacturer’s instructions.
- the system determines that a small child is present in a booster seat.
- a front passenger takes his/her weight off of the seat for a period of time.

Seating and Safety Restraints

The front passenger sensing system uses a "passenger airbag off" or "pass airbag off" indicator which will illuminate and stay lit to remind you that the front passenger frontal airbag is disabled. The indicator lamp is located in the center stack of the instrument panel above the climate controls.



Note: The indicator lamp will illuminate for a short period of time when the ignition is turned to the ON position to confirm it is functional.

When the front passenger seat is not occupied (empty seat) or in the event that the front passenger frontal airbag is enabled (may inflate), the indicator lamp will be unlit.

The front passenger sensing system is designed to disable (will not inflate) the front passenger's frontal airbag when a rear facing infant seat, a forward-facing child restraint, or a booster seat is detected.

- When the front passenger sensing system disables (will not inflate) the front passenger frontal airbag, the indicator lamp will illuminate and stay lit to remind you that the front passenger frontal airbag is disabled.
- If the child restraint has been installed and the indicator lamp is not lit, then turn the vehicle off, remove the child restraint from the vehicle and reinstall the restraint following the child restraint manufacturer's instructions.

The front passenger sensing system is designed to enable (may inflate) the front passenger's frontal airbag anytime the system senses that a person of adult size is sitting properly in the front passenger seat.

- When the front passenger sensing system enables the front passenger frontal airbag (may inflate), the indicator lamp will be unlit and stay unlit.

If a person of adult size is sitting in the front passenger's seat, but the "passenger airbag off" or "pass airbag off" indicator lamp is lit, it is possible that the person isn't sitting properly in the seat. If this happens:

- Turn the vehicle off and ask the person to place the seatback in the full upright position.
- Have the person sit upright in the seat, centered on the seat cushion, with the person's legs comfortably extended.
- Restart the vehicle and have the person remain in this position for about two minutes. This will allow the system to detect that person and enable the passenger's frontal airbag.

Seating and Safety Restraints

- If the indicator lamp remains lit even after this, the person should be advised to ride in the rear seat.

Occupant	Pass Airbag Off Indicator Lamp	Passenger Airbag
Empty seat	Unlit	Disabled
Small child in child safety seat or booster	Lit	Disabled
Small child with safety belt buckled or unbuckled	Lit	Disabled
Adult	Unlit	Enabled



Even with Advanced Restraints Systems, children 12 and under should be properly restrained in the back seat.

After all occupants have adjusted their seats and put on safety belts, it's very important that they continue to sit properly. A properly seated occupant sits upright, leaning against the seat back, and centered on the seat cushion, with their feet comfortably extended on the floor. Sitting improperly can increase the chance of injury in a crash event. For example, if an occupant slouches, lies down, turns sideways, sits forward, leans forward or sideways, or puts one or both feet up, the chance of injury during a crash is greatly increased.



Sitting improperly out of position or with the seat back reclined too far can take off weight from the seat cushion and affect the decision of the front passenger sensing system, resulting in serious injury or death in a crash.

Always sit upright against your seatback, with your feet on the floor.

The front passenger sensing system may detect small or medium objects placed on the seat cushion. For most objects that are in the front passenger seat, the passenger airbag will be disabled. Even though the passenger airbag is disabled, the "pass airbag off" lamp may or may not be illuminated according to the table below.

Seating and Safety Restraints

Objects	Pass Airbag Off Indicator Lamp	Passenger Airbag
Small (i.e. 3 ring binder, small purse, bottled water)	Unlit	Disabled
Medium (i.e. heavy briefcase, fully packed luggage)	Lit	Disabled
Empty seat, or small to medium object with safety belt buckled	Lit	Disabled

If you think that the status of the passenger airbag off indicator lamp is incorrect, check for the following:

- Objects lodged underneath the seat
- Objects between the seat cushion and the center console (if equipped)
- Objects hanging off the seat back
- Objects stowed in the seatback map pocket (if equipped)
- Objects placed on the occupant's lap
- Cargo interference with the seat
- Other passengers pushing or pulling on the seat
- Rear passenger feet and knees resting or pushing on the seat

The conditions listed above may cause the weight of a properly seated occupant to be incorrectly interpreted by the front passenger sensing system. The person in the front passenger seat may appear heavier or lighter due to the conditions described in the list above.



To reduce the risk of possible serious injury:

Do not stow objects in seat back map pocket (if equipped) or hang objects off seat back if a child is in the front passenger seat. Do not place objects underneath the front passenger seat or between the seat and the center console (if equipped). Check the "passenger airbag off" or "pass airbag off" indicator lamp for proper airbag status. Failure to follow these instructions may interfere with the front passenger seat sensing system.

Seating and Safety Restraints

In case there is a problem with the front passenger sensing system, the airbag readiness light in the instrument cluster will stay lit.



If the airbag readiness light is lit, do the following:

The driver and/or adult passengers should check for any objects that may be lodged underneath the front passenger seat or cargo interfering with the seat.

If objects are lodged and/or cargo is interfering with the seat; please take the following steps to remove the obstruction:

- Pull the vehicle over.
- Turn the vehicle off.
- Driver and/or adult passengers should check for any objects lodged underneath the front passenger seat or cargo interfering with the seat.
- Remove the obstruction(s) (if found).
- Restart the vehicle.
- Wait at least 2 minutes and verify that the airbag readiness light is no longer illuminated
- If the airbag readiness light remains illuminated, this may or may/not be a problem due to the front passenger sensing system.

DO NOT attempt to repair or service the system; take your vehicle immediately to an authorized dealer.

If it is necessary to modify an advanced front airbag system to accommodate a person with disabilities, contact the Ford Customer Relationship Center at the phone number shown in the *Customer Assistance* section of this *Owner's Guide*.



Any alteration/modification to the front passenger seat may affect the performance of the front passenger sensing system.

Determining if the system is operational

The supplemental restraint system uses a warning indicator light in the instrument cluster or a back-up tone to indicate the condition of the system. Refer to the *Warning lights and chimes* section in the *Instrument Cluster* chapter. Routine maintenance of the airbag is not required.

Seating and Safety Restraints

A difficulty with the system is indicated by one or more of the following:

- The readiness light (same light for front and side airbag system) will either flash or stay lit.
- The readiness light will not illuminate immediately after ignition is turned on.
- A series of five beeps will be heard. The tone pattern will repeat periodically until the problem and/or light are repaired.



If any of these things happen, even intermittently, have the supplemental restraint system serviced at an authorized dealer immediately. Unless serviced, the system may not function properly in the event of a collision.

Seat-mounted side airbag system



Do not place objects or mount equipment on or near the airbag cover on the side of the seatbacks of the front seats or in front seat areas that may come into contact with a deploying airbag. Failure to follow these instructions may increase the risk of personal injury in the event of a collision.



Do not use accessory seat covers. The use of accessory seat covers may prevent the deployment of the side airbags and increase the risk of injury in an accident.



Do not lean your head on the door. The side airbag could injure you as it deploys from the side of the seatback.



Do not attempt to service, repair, or modify the airbag SRS, its fuses or the seat cover on a seat containing an airbag. See your authorized dealer.



All occupants of the vehicle should always wear their safety belts even when an airbag SRS is provided.

Seating and Safety Restraints

How does the side airbag system work?

The design and development of the side airbag system included recommended testing procedures that were developed by a group of automotive safety experts known as the Side Airbag Technical Working Group. These recommended testing procedures help reduce the risk of injuries related to the deployment of side airbags.

The side airbag system consists of the following:

- An inflatable nylon bag (airbag) with a gas generator concealed behind the outboard bolster of the driver and front passenger seatbacks.
- The same warning light, electronic control and diagnostic unit as used for the front airbags.
- Two crash sensors mounted on the B pillar (one on each side of the vehicle).
- Two crash sensors located at the C pillar behind the rear doors (one on each side of the vehicle).

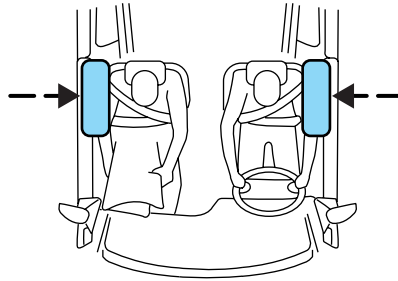

Side airbags, in combination with safety belts, can help reduce the risk of severe injuries in the event of a significant side impact collision.

The side airbags are fitted on the outboard side of the seatbacks of the front seats. In certain lateral collisions, the airbag on the side affected by the collision will be inflated. If the front passenger sensing system detects an empty seat, the front passenger seat-mounted side airbag will be deactivated. The airbag was designed to inflate between the door panel and occupant to further enhance the protection provided occupants in side impact collisions.

The airbag SRS is designed to activate when the vehicle sustains lateral deceleration sufficient to cause the sensors to close an electrical circuit that initiates airbag inflation.

The fact that the airbags did not inflate in a collision does not mean that something is wrong with the system. Rather, it means the forces were not of the type sufficient to cause activation. Side airbags are designed to inflate in side-impact collisions, not roll-over, rear-impact, frontal or near-frontal collisions, unless the collision causes sufficient lateral deceleration.

Seating and Safety Restraints



Several air bag system components get hot after inflation. Do not touch them after inflation.



If the side airbag has deployed, **the airbag will not function again. The side airbag system (including the seat) must be inspected and serviced by an authorized dealer.** If the airbag is not replaced, the unrepaired area will increase the risk of injury in a collision.

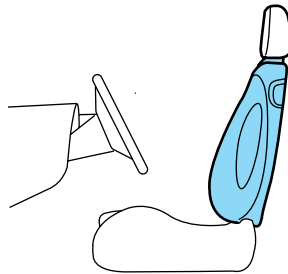

Determining if the system is operational

The SRS uses a readiness light in the instrument cluster or a tone to indicate the condition of the system. Refer to the *Airbag readiness* section in the *Instrument cluster* chapter. Routine maintenance of the airbag is not required.

Any difficulty with the system is indicated by one or more of the following:

- The readiness light (same light as used for front airbag system) will either flash or stay lit.
- The readiness light will not illuminate immediately after ignition is turned to the RUN position.
- A series of five beeps will be heard. The tone pattern will repeat periodically until the problem and light are repaired.

If any of these things happen, even intermittently, have the SRS serviced at an authorized dealer immediately. Unless serviced, the system may not function properly in the event of a collision.

Seating and Safety Restraints

Safety Canopy™ system

 Do not place objects or mount equipment on or near the headliner at the siderail that may come into contact with a deploying Safety Canopy™. Failure to follow these instructions may increase the risk of personal injury in the event of a collision.

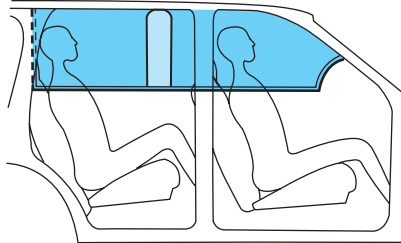

 Do not lean your head on the door. The Safety Canopy™ could injure you as it deploys from the headliner.

 Do not attempt to service, repair, or modify the Safety Canopy™ system, its fuses, the A, B, C or D pillar trim, or the headliner on a vehicle containing a Safety Canopy™. See your authorized dealer.

 All occupants of the vehicle including the driver should always wear their safety belts even when an airbag SRS and Safety Canopy™ system is provided.

 To reduce risk of injury, do not obstruct or place objects in the deployment path of the inflatable Safety Canopy™.

Seating and Safety Restraints

How does the Safety Canopy™ system work?

The design and development of the Safety Canopy™ system included recommended testing procedures that were developed by a group of automotive safety experts known as the Side Airbag Technical Working Group. These recommended testing procedures help reduce the risk of injuries related to the deployment of side airbags (including the Safety Canopy™).

The Safety Canopy™ system consists of the following:

- An inflatable nylon curtain with a gas generator concealed behind the headliner and above the doors (one on each side of vehicle).
- A headliner designed to flex open above the side doors to allow Safety Canopy™ deployment.
- The same readiness airbag light, electronic control and diagnostic unit as used for the front airbags.
- Two crash sensors mounted on the B pillar (one on each side of the vehicle).
- Two crash sensors located at the C pillar behind the rear doors (one on each side of the vehicle).
- Rollover sensor in the restraints control module (RCM).

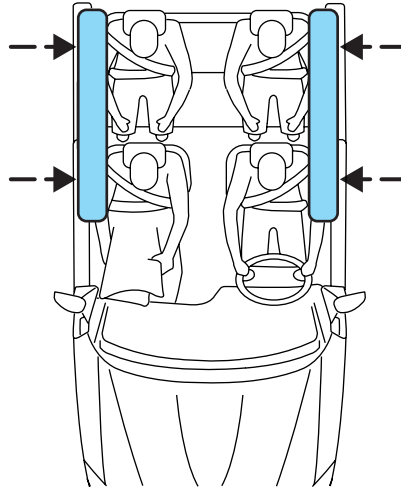

The Safety Canopy™ system, in combination with safety belts, can help reduce the risk of severe injuries in the event of a significant side impact collision or rollover event.

Children 12 years old and under should always be properly restrained in the second or third row seats. The Safety Canopy™ will not interfere with children restrained using a properly installed child or booster seat because it is designed to inflate downward from the headliner above the doors along the side window opening.

Seating and Safety Restraints

The Safety Canopy™ system is designed to activate when the vehicle sustains lateral deceleration sufficient to cause the side crash sensor to close an electrical circuit that initiates Safety Canopy™ inflation or when a certain likelihood of a rollover event is detected by the rollover sensor.

The Safety Canopy™ is mounted to roof side-rail sheet metal, behind the headliner, along the entire side of the vehicle. In certain lateral collisions or rollover events, the Safety Canopy™ system will be activated, regardless of which seats are occupied. The Safety Canopy™ is designed to inflate between the side window area and occupants to further enhance protection provided in side impact collisions and rollover events.

The fact that the Safety Canopy™ did not activate in a collision does not mean that something is wrong with the system. Rather, it means the forces were not of the type sufficient to cause activation. The Safety Canopy™ is designed to inflate in certain side impact collisions or rollover events, not in rear impact, frontal or near-frontal collisions, unless the collision causes sufficient lateral deceleration or rollover.



Several Safety Canopy™ system components get hot after inflation. Do not touch them after inflation.



If the Safety Canopy™ system has deployed, **the Safety Canopy™ will not function again unless replaced. The Safety Canopy™ system (including the A, B, C, and D pillar trim and headliner) must be inspected and serviced by an authorized dealer.** If the Safety Canopy™ is not replaced, the unrepaired area will increase the risk of injury in a collision.

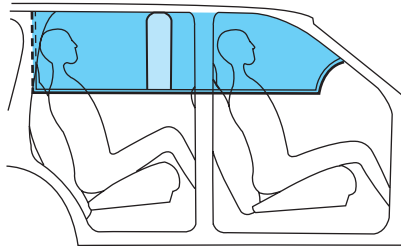

Determining if the system is operational

The SRS uses a readiness light in the instrument cluster or a tone to indicate the condition of the system. Refer to the *Airbag readiness* section in the *Instrument Cluster* chapter. Routine maintenance of the airbag is not required.

Seating and Safety Restraints

Any difficulty with the system is indicated by one or more of the following:

- The readiness airbag light (same light as for front airbag system) will either flash or stay lit.
- The readiness light will not illuminate immediately after ignition is turned on.
- A series of five beeps will be heard. The tone pattern will repeat periodically until the problem and light are repaired.

If any of these things happen, even intermittently, have the SRS serviced at your authorized dealer immediately. Unless serviced, the system may not function properly in the event of a collision or rollover event.

Disposal of airbags and airbag equipped vehicles (including pretensioners)

See your authorized dealer. Airbags MUST BE disposed of by qualified personnel.

SAFETY RESTRAINTS FOR CHILDREN

See the following sections for directions on how to properly use safety restraints for children. Also see *Airbag supplemental restraint system (SRS)* in this chapter for special instructions about using airbags.

Important child restraint precautions

You are required by law to use safety restraints for children in the U.S. and Canada. If small children (generally children who are four years old or younger and who weigh 40 lb. [18 kg] or less) ride in your vehicle, you must put them in safety seats made especially for children. Many states require that children use approved booster seats until they are eight years old. Check your local and state or provincial laws for specific requirements regarding the safety of children in your vehicle. When possible, always place children under age 12 in the rear seat of your vehicle. Accident statistics suggest that children are safer when properly restrained in the rear seating positions than in the front seating position.



Never let a passenger hold a child on his or her lap while the vehicle is moving. The passenger cannot protect the child from injury in a collision.

Always follow the instructions and warnings that come with any infant or child restraint you might use.

Seating and Safety Restraints

Children and safety belts

If the child is the proper size, restrain the child in a safety seat. Children who are too large for child safety seats (as specified by your child safety seat manufacturer) should always wear safety belts.

Follow all the important safety restraint and airbag precautions that apply to adult passengers in your vehicle.

If the shoulder belt portion of a combination lap and shoulder belt can be positioned so it does not cross or rest in front of the child's face or neck, the child should wear the lap and shoulder belt. Moving the child closer to the center of the vehicle may help provide a good shoulder belt fit.



Do not leave children, unreliable adults, or pets unattended in your vehicle.

Child booster seats

Children outgrow a typical convertible or toddler seat when they weigh 40 lb. (18 kg) and are around 4 years of age. Although the lap/shoulder belt will provide some protection, these children are still too small for lap/shoulder belts to fit properly, which could increase the risk of serious injury in a crash.

To improve the fit of both the lap and shoulder belt on children who have outgrown child safety seats, Ford Motor Company recommends use of a belt-positioning booster.

Booster seats position a child so that safety belts fit better. They lift the child up so that the lap belt rests low across the hips and the knees bend comfortably. Booster seats may also make the shoulder belt fit better and more comfortably. Try to keep the belt near the middle of the shoulder.

When children should use booster seats

Children need to use booster seats from the time they outgrow the toddler seat until they are big enough for the vehicle seat and lap/shoulder belt to fit properly. Generally this is when they weigh about 80 lb. (36 kg) (about 8 to 12 years old).

Seating and Safety Restraints

Booster seats should be used until you can answer YES to ALL of these questions:

- Can the child sit all the way back against the vehicle seat back with knees bent comfortably at the edge of the seat without slouching?

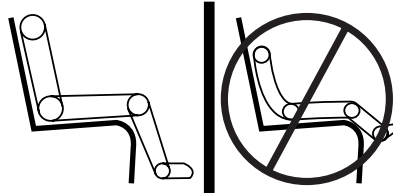

- Does the lap belt rest low across the hips?
- Is the shoulder belt centered on the shoulder and chest?
- Can the child stay seated like this for the whole trip?

Types of booster seats

There are two types of belt-positioning booster seats:

- Those that are backless.

If your backless booster seat has a removable shield, remove the shield and use the lap/shoulder belt. If a seating position has a low seat back and no head restraint, a backless booster seat may place your child's head (top of ear level) above the top of the seat. In this case, move the backless booster to another seating position with a higher seat back and lap/shoulder belts.



- Those with a high back.

If, with a backless booster seat, you cannot find a seating position that adequately supports your child's head, a high back booster seat would be a better choice.



Either type can be used at any seating position equipped with lap/shoulder belts if your child is over 40 lb. (18 kg).

Seating and Safety Restraints

Children and booster seats vary widely in size and shape. Choose a booster that keeps the lap belt low and snug across the hips, never up across the stomach, and lets you adjust the shoulder belt to cross the chest and rest snugly near the center of the shoulder. The drawings below compare the ideal fit (center) to a shoulder belt uncomfortably close to the neck and a shoulder belt that could slip off the shoulder.

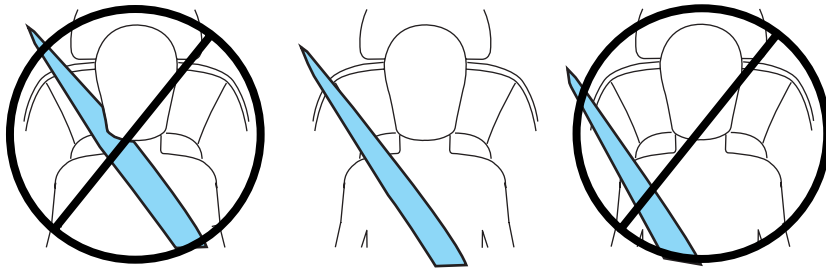

If the booster seat slides on the vehicle seat, placing a rubberized mesh sold as shelf or carpet liner under the booster seat may improve this condition.

The importance of shoulder belts

Using a booster without a shoulder belt increases the risk of a child's head hitting a hard surface in a collision. For this reason, you should never use a booster seat with a lap belt only. It is best to use a booster seat with lap/shoulder belts in the back seat- the safest place for children to ride.



Move a child to a different seating location if the shoulder belt does not stay positioned on the shoulder during use.



Follow all instructions provided by the manufacturer of the booster seat.



Never put the shoulder belt under a child's arm or behind the back because it eliminates the protection for the upper part of the body and may increase the risk of injury or death in a collision.

Seating and Safety Restraints



Never use pillows, books, or towels to boost a child. They can slide around and increase the likelihood of injury or death in a collision.

SAFETY SEATS FOR CHILDREN

Child and infant or child safety seats

Use a safety seat that is recommended for the size and weight of the child. Carefully follow all of the manufacturer's instructions with the safety seat you put in your vehicle. If you do not install and use the safety seat properly, the child may be injured in a sudden stop or collision.

When installing a child safety seat:

- Review and follow the information presented in the *Airbag Supplemental Restraint System* section in this chapter.
- Use the correct safety belt buckle for that seating position.
- Insert the belt tongue into the proper buckle until you hear a snap and feel it latch. Make sure the tongue is securely fastened in the buckle.
- Keep the buckle release button pointing up and away from the safety seat, with the tongue between the child seat and the release button, to prevent accidental unbuckling.
- Place seat back in upright position.
- Put the safety belt in the automatic locking mode. Refer to *Automatic locking mode*.
- LATCH lower anchors are recommended for use by children up to 48 lb (22 kg) in a child restraint. Top tether anchors can be used for children up to 60 lb (27 kg) in a child restraint, and to provide upper torso restraint for children up to 80 lb (36 kg) using an upper torso harness and a belt-positioning booster.

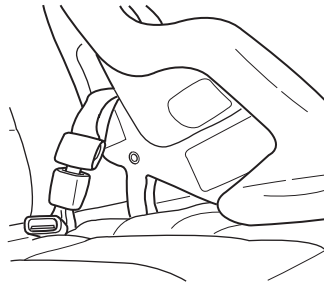

Ford Motor Company recommends the use of a child safety seat having a top tether strap. Install the child safety seat in a seating position with LATCH and tether anchors. For more information on top tether straps

Seating and Safety Restraints

and anchors, refer to *Attaching safety seats with tether straps* in this chapter. For more information of LATCH anchors refer to *Attaching safety seats with LATCH (Lower Anchors and Tethers for Children) attachments* in this chapter.

 Carefully follow all of the manufacturer's instructions included with the safety seat you put in your vehicle. If you do not install and use the safety seat properly, the child may be injured in a sudden stop or collision.

 Rear-facing child seats or infant carriers should never be placed in front of an active passenger airbag.

Installing child safety seats with combination lap and shoulder belts

 Airbags can kill or injure a child in a child seat. **NEVER** place a rear-facing child seat in front of an active airbag. If you must use a forward-facing child seat in the front seat, move the seat all the way back.

 Children 12 and under should be properly restrained in the rear seat whenever possible.

1. Position the child safety seat in a seat with a combination lap and shoulder belt.

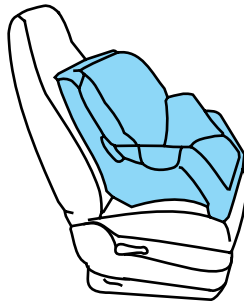

Seating and Safety Restraints

2. Pull down on the shoulder belt and then grasp the shoulder belt and lap belt together.

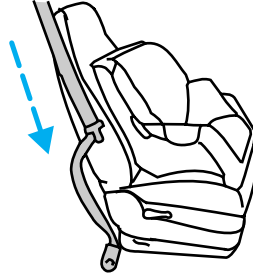

3. While holding the shoulder and lap belt portions together, route the tongue through the child seat according to the child seat manufacturer's instructions. Be sure the belt webbing is not twisted.

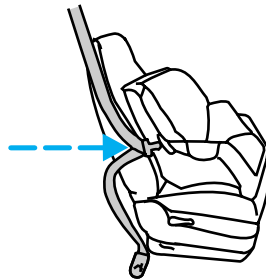

4. Insert the belt tongue into the proper buckle (the buckle closest to the direction the tongue is coming from) for that seating position until you hear a snap and feel the latch engage. Make sure the tongue is latched securely by pulling on it.

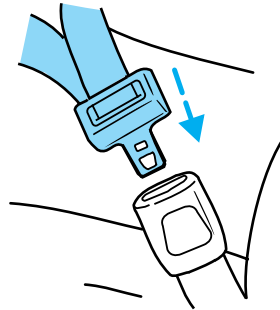

Seating and Safety Restraints

5. To put the retractor in the automatic locking mode, grasp the shoulder portion of the belt and pull downward until all of the belt is pulled out and a click is heard.

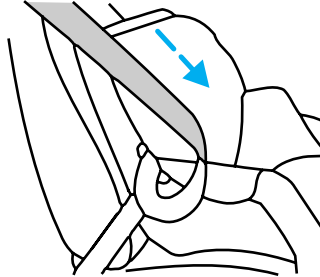

6. Allow the belt to retract. The belt will click as it retracts to indicate it is in the automatic locking mode.

7. Pull the lap belt portion across the child seat toward the buckle and pull up on the shoulder belt while pushing down with your knee on the child seat.

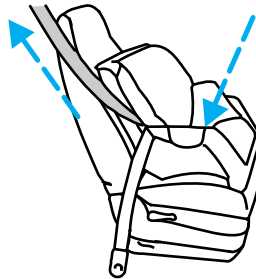

8. Allow the safety belt to retract to remove any slack in the belt.

9. Before placing the child in the seat, forcibly move the seat forward and back to make sure the seat is securely held in place. To check this, grab the seat at the belt path and attempt to move it side to side and forward. There should be no more than one inch of movement for proper installation.

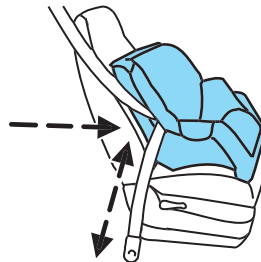

10. Try to pull the belt out of the retractor to make sure the retractor is in the automatic locking mode (you should not be able to pull more belt out). If the retractor is not locked, unbuckle the belt and repeat Steps 2 through 9.

Check to make sure the child seat is properly secured before each use.

Seating and Safety Restraints

Attaching child safety seats with tether straps

Most new forward-facing child safety seats include a tether strap which goes over the back of the seat and hooks to an anchoring point. Tether straps are available as an accessory for many older safety seats. Contact the manufacturer of your child seat for information about ordering a tether strap.

The rear seats of your vehicle are equipped with built-in tether strap anchors located behind the seats as described below.

The tether anchors in your vehicle are located under the second row seat gap cover marked with tether anchor symbols (shown with title).

The tether strap anchors in your vehicle are in the following positions (shown from top view):

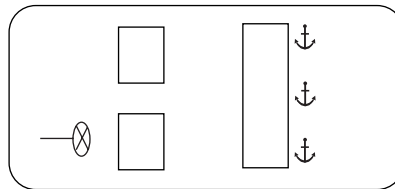

Attach the tether strap only to the appropriate tether anchor as shown. The tether strap may not work properly if attached somewhere other than the correct tether anchor.



Do not use seat anchors as cargo tie downs.

1. Position the child safety seat on the seat cushion.
2. Route the child safety seat tether strap over the back of the seat.

For vehicles with adjustable head restraints, route the tether strap under the head restraint and between the head restraint posts, otherwise route the tether strap over the top of the seatback.

3. Locate the correct anchor behind the gap cover for the selected seating position.

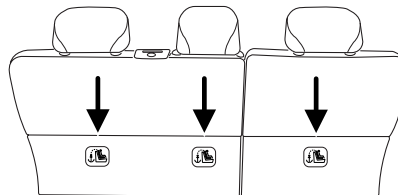

Seating and Safety Restraints

4. Clip the tether strap to the anchor as shown.



If the tether strap is clipped incorrectly, the child safety seat may not be retained properly in the event of a collision.

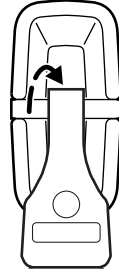

5. Install the child safety seat tightly using the LATCH anchors or safety belts. Follow the instructions in this chapter.

6. Tighten the child safety seat tether strap according to the manufacturer's instructions.



If the safety seat is not anchored properly, the risk of a child being injured in a collision greatly increases.

Attaching safety seats with LATCH (Lower Anchors and Tethers for Children) attachments for child seat anchors

Some child safety seats have two rigid or webbing mounted attachments that connect to two anchors at certain seating positions in your vehicle. This type of child seat eliminates the need to use safety belts to attach the child seat. For forward-facing child seats, the tether strap must also be attached to the proper tether anchor. See *Attaching safety seats with tether straps* in this chapter.

Your vehicle has LATCH anchors for child seat installation at the seating positions marked with the child seat symbol.

The anchors at the center of the rear seat are further apart than the sets of lower anchors for child seat installation at other seating positions. A child seat with rigid LATCH attachments cannot be installed at this seating position. LATCH compatible child seats (with attachments on belt webbing) can be used at this seating position only if the child seat instructions state that the child seat can be installed to anchors that are spaced up to 20

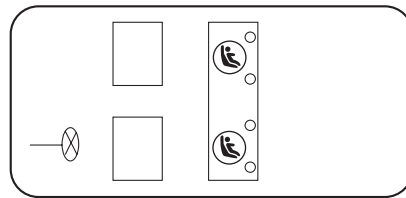

Seating and Safety Restraints

inches (500 mm) apart. Do not attach a child seat to any lower anchor if an adjacent child seat is attached to that anchor.

 Never attach two LATCH child safety seats to the same anchor. In a crash, one anchor may not be strong enough to hold two child safety seat attachments and may break, causing serious injury or death.

The lower anchors for child seat installation are located at the rear section of the rear seat between the cushion and seat back. The LATCH anchors are below the locator symbols on the seat back.

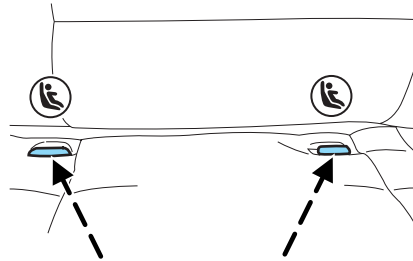

Follow the child seat manufacturer's instructions to properly install a child seat with LATCH attachments.

 Attach LATCH lower attachments of the child seat only to the anchors shown.

If you install a child seat with rigid LATCH attachments, do not tighten the tether strap enough to lift the child seat off the vehicle seat cushion when the child is seated in it. Keep the tether strap just snug without lifting the front of the child seat. Keeping the child seat just touching the vehicle seat gives the best protection in a severe crash.

Each time you use the safety seat, check that the seat is properly attached to the lower anchors and tether anchor. Try to tilt the child seat from side to side. Also try to tug the seat forward. Check to see if the anchors hold the seat in place.

 If the safety seat is not anchored properly, the risk of a child being injured in a crash greatly increases.

Tires, Wheels and Loading

NOTICE TO UTILITY VEHICLE AND TRUCK OWNERS

Utility vehicles handle differently than passenger cars in the various driving conditions that are encountered on streets, highways and off-road. Utility vehicles are not designed for cornering at speeds as high as passenger cars any more than low-slung sports cars are designed to perform satisfactorily under off-road conditions.

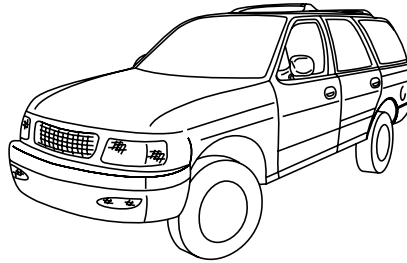

 Utility vehicles have a significantly higher rollover rate than other types of vehicles. To reduce the risk of serious injury or death from a rollover or other crash you must:

- Avoid sharp turns and abrupt maneuvers;
- Drive at safe speeds for the conditions;
- Keep tires properly inflated;
- Never overload or improperly load your vehicle; and
- Make sure every passenger is properly restrained.

 In a rollover crash, an unbelted person is significantly more likely to die than a person wearing a seat belt. All occupants must wear seat belts and children/infants must use appropriate restraints to minimize the risk of injury or ejection.

Study your *Owner's Guide* for specific information about equipment features, instructions for safe driving and additional precautions to reduce the risk of an accident or serious injury.

VEHICLE CHARACTERISTICS

All Wheel Drive (AWD) System (if equipped)

Your vehicle may be equipped with a full-time All Wheel Drive (AWD) system. With the AWD option, power will be delivered to the front wheels and distributed to the rear wheels as needed. This increases traction which may enable you to safely drive over terrain and road conditions that a conventional two-wheel drive vehicle cannot. The AWD system is active all the time and requires no input from the operator.

Tires, Wheels and Loading

Note: Your AWD vehicle is not intended for off-road use. The AWD feature gives your vehicle some limited off-road capabilities in which driving surfaces are relatively level, obstruction-free and otherwise similar to normal on-road driving conditions. Operating your vehicle under other than those conditions could subject the vehicle to excessive stress which might result in damage which is not covered under your warranty.

For AWD vehicles, a spare tire of a different size other than the tire provided should never be used. A dissimilar spare tire size (other than the spare tire provided) or major dissimilar tire sized between the front and rear axles could cause the AWD system to stop functioning and default to front wheel drive.



Do not become overconfident in the ability of AWD vehicles. Although a AWD vehicle may accelerate better than two-wheel drive vehicle in low traction situations, it won't stop any faster than two-wheel drive vehicles. Always drive at a safe speed.

How your vehicle differs from other vehicles

Utility Vehicles can differ from some other vehicles in a few noticeable ways. Your vehicle may be:

- Higher – to allow higher load carrying capacity.
- Shorter – to give it the capability to approach inclines. All other things held equal, a shorter wheelbase may make your vehicle quicker to respond to steering inputs than a vehicle with a longer wheelbase.

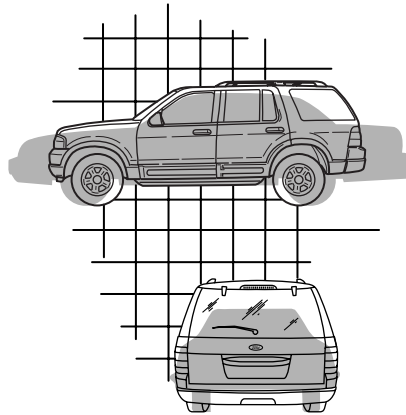

Tires, Wheels and Loading

- Narrower — to provide greater maneuverability in tight spaces.

As a result of the above dimensional differences, Utility Vehicles often will have a higher center of gravity and a greater difference in center of gravity between the loaded and unloaded condition.

These differences that make your vehicle so versatile also make it handle differently than an ordinary passenger car.

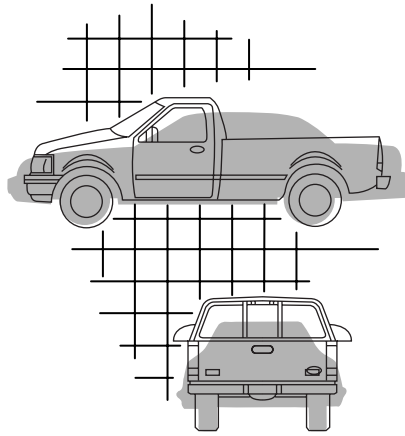

INFORMATION ABOUT UNIFORM TIRE QUALITY GRADING

New vehicles are fitted with tires that have a rating on them called Tire Quality Grades. The Quality grades can be found where applicable on the tire sidewall between tread shoulder and maximum section width. For example:

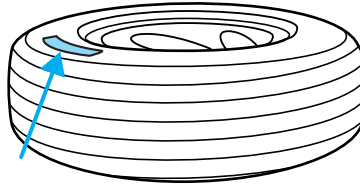

- **Treadwear 200 Traction AA Temperature A**

These Tire Quality Grades are determined by standards that the United States Department of Transportation has set.

Tire Quality Grades apply to new pneumatic tires for use on passenger cars. They do not apply to deep tread, winter-type snow tires, space-saver or temporary use spare tires, tires with nominal rim diameters of 10 to 12 inches or limited production tires as defined in Title 49 Code of Federal Regulations Part 575.104(c)(2).

U.S. Department of Transportation-Tire quality grades: The U.S. Department of Transportation requires Ford Motor Company to give you the following information about tire grades exactly as the government has written it.

Tires, Wheels and Loading

Treadwear

The treadwear grade is a comparative rating based on the wear rate of the tire when tested under controlled conditions on a specified government test course. For example, a tire graded 150 would wear one and one-half (1 1/2) times as well on the government course as a tire graded 100. The relative performance of tires depends upon the actual conditions of their use, however, and may depart significantly from the norm due to variations in driving habits, service practices, and differences in road characteristics and climate.

Traction AA A B C

The traction grades, from highest to lowest are AA, A, B, and C. The grades represent the tire's ability to stop on wet pavement as measured under controlled conditions on specified government test surfaces of asphalt and concrete. A tire marked C may have poor traction performance.



The traction grade assigned to this tire is based on straight-ahead braking traction tests, and does not include acceleration, cornering, hydroplaning or peak traction characteristics.

Temperature A B C

The temperature grades are A (the highest), B and C, representing the tire's resistance to the generation of heat and its ability to dissipate heat when tested under controlled conditions on a specified indoor laboratory test wheel. Sustained high temperature can cause the material of the tire to degenerate and reduce tire life, and excessive temperature can lead to sudden tire failure. The grade C corresponds to a level of performance which all passenger car tires must meet under the Federal Motor Vehicle Safety Standard No. 109. Grades B and A represent higher levels of performance on the laboratory test wheel than the minimum required by law.



The temperature grade for this tire is established for a tire that is properly inflated and not overloaded. Excessive speed, underinflation, or excessive loading, either separately or in combination, can cause heat buildup and possible tire failure.

TIRES

Tires are designed to give many thousands of miles of service, but they must be maintained in order to get the maximum benefit from them.

184

Tires, Wheels and Loading

Glossary of tire terminology

- **Tire label:** A label showing the OE (Original Equipment) tire sizes, recommended inflation pressure and the maximum weight the vehicle can carry.
- **Tire Identification Number (TIN):** A number on the sidewall of each tire providing information about the tire brand and manufacturing plant, tire size and date of manufacture. Also referred to as DOT code.
- **Inflation pressure:** A measure of the amount of air in a tire.
- **Standard load:** A class of P-metric or Metric tires designed to carry a maximum load at 35 psi [37 psi (2.5 bar) for Metric tires]. Increasing the inflation pressure beyond this pressure will not increase the tire's load carrying capability.
- **Extra load:** A class of P-metric or Metric tires designed to carry a heavier maximum load at 41 psi [43 psi (2.9 bar) for Metric tires]. Increasing the inflation pressure beyond this pressure will not increase the tire's load carrying capability.
- **kPa:** Kilopascal, a metric unit of air pressure.
- **PSI:** Pounds per square inch, a standard unit of air pressure.
- **Cold inflation pressure:** The tire pressure when the vehicle has been stationary and out of direct sunlight for an hour or more and prior to the vehicle being driven for 1 mile (1.6 km).
- **Recommended inflation pressure:** The cold inflation pressure found on the Safety Compliance Certification Label or Tire Label located on the B-Pillar or the edge of the driver's door.
- **B-pillar:** The structural member at the side of the vehicle behind the front door.
- **Bead area of the tire:** Area of the tire next to the rim.
- **Sidewall of the tire:** Area between the bead area and the tread.
- **Tread area of the tire:** Area of the perimeter of the tire that contacts the road when mounted on the vehicle.
- **Rim:** The metal support (wheel) for a tire or a tire and tube assembly upon which the tire beads are seated.

INFLATING YOUR TIRES

Safe operation of your vehicle requires that your tires are properly inflated. Remember that a tire can lose up to half of its air pressure without appearing flat.

Tires, Wheels and Loading

Every day before you drive, check your tires. If one looks lower than the others, use a tire gauge to check pressure of all tires and adjust if required.

At least once a month and before long trips, inspect each tire and check the tire pressure with a tire gauge (including spare, if equipped). Inflate all tires to the inflation pressure recommended by Ford Motor Company.

Use a tire gauge to check the tire inflation pressure, including the spare (if equipped), at least monthly and before long trips. You are strongly urged to buy a reliable tire pressure gauge, as automatic service station gauges may be inaccurate. Ford recommends the use of a digital or dial-type tire pressure gauge rather than a stick-type tire pressure gauge.

Use the recommended cold inflation pressure for optimum tire performance and wear. Under-inflation or over-inflation may cause uneven treadwear patterns.



Under-inflation is the most common cause of tire failures and may result in severe tire cracking, tread separation or "blowout", with unexpected loss of vehicle control and increased risk of injury. Under-inflation increases sidewall flexing and rolling resistance, resulting in heat buildup and internal damage to the tire. It also may result in unnecessary tire stress, irregular wear, loss of vehicle control and accidents. A tire can lose up to half of its air pressure and not appear to be flat!

Always inflate your tires to the Ford recommended inflation pressure even if it is less than the maximum inflation pressure information found on the tire. The Ford recommended tire inflation pressure is found on the Safety Compliance Certification Label or Tire Label which is located on the B-Pillar or the edge of the driver's door. Failure to follow the tire pressure recommendations can cause uneven treadwear patterns and adversely affect the way your vehicle handles.

Maximum Permissible Inflation Pressure is the tire manufacturer's maximum permissible pressure and/or the pressure at which the maximum load can be carried by the tire. This pressure is normally higher than the manufacturer's recommended cold inflation pressure which can be found on the Safety Compliance Certification Label or Tire Label which is located on the B-Pillar or the edge of the driver's door. The cold inflation pressure should never be set lower than the recommended pressure on the Safety Compliance Certification Label or Tire Label.

Tires, Wheels and Loading

When weather temperature changes occur, tire inflation pressures also change. A 10°F (6°C) temperature drop can cause a corresponding drop of 1 psi (7 kPa) in inflation pressure. Check your tire pressures frequently and adjust them to the proper pressure which can be found on the Safety Compliance Certification Label or Tire Label.

To check the pressure in your tire(s):

1. Make sure the tires are cool, meaning they are not hot from driving even a mile.

If you are checking tire pressure when the tire is hot, (i.e. driven more than 1 mile [1.6 km]), never “bleed” or reduce air pressure. The tires are hot from driving and it is normal for pressures to increase above recommended cold pressures. A hot tire at or below recommended cold inflation pressure could be significantly under-inflated.

Note: If you have to drive a distance to get air for your tire(s), check and record the tire pressure first and add the appropriate air pressure when you get to the pump. It is normal for tires to heat up and the air pressure inside to go up as you drive.

2. Remove the cap from the valve on one tire, then firmly press the tire gauge onto the valve and measure the pressure.

3. Add enough air to reach the recommended air pressure.

Note: If you overfill the tire, release air by pushing on the metal stem in the center of the valve. Then recheck the pressure with your tire gauge.

4. Replace the valve cap.

5. Repeat this procedure for each tire, including the spare.

Note: Some spare tires operate at a higher inflation pressure than the other tires. For T-type/mini-spare tires (see *Dissimilar Spare Tire/Wheel Information* section for description): Store and maintain at 60psi (4.15 bar). For Full Size and Dissimilar spare tires (see *Dissimilar Spare Tire/Wheel Information* section for description): Store and maintain at the higher of the front and rear inflation pressure as shown on the Tire Label.

6. Visually inspect the tires to make sure there are no nails or other objects embedded that could poke a hole in the tire and cause an air leak.

7. Check the sidewalls to make sure there are no gouges, cuts or bulges.

Tires, Wheels and Loading

TIRE CARE

Inspecting your tires

Periodically inspect the tire treads for uneven or excessive wear and remove objects such as stones, nails or glass that may be wedged in the tread grooves. Check for holes or cuts that may permit air leakage from the tire and make necessary repairs. Also inspect the tire sidewalls for cracking, cuts, bruises and other signs of damage or excessive wear. If internal damage to the tire is suspected, have the tire demounted and inspected in case it needs to be repaired or replaced. For your safety, tires that are damaged or show signs of excessive wear should not be used because they are more likely to blow out or fail.

Improper or inadequate vehicle maintenance can cause tires to wear abnormally. Inspect all your tires, including the spare, frequently, and replace them if one or more of the following conditions exist:

Tire wear

When the tread is worn down to 1/16th of an inch (2 mm), tires must be replaced to help prevent your vehicle from skidding and hydroplaning. Built-in treadwear indicators, or “wear bars”, which look like narrow strips of smooth rubber across the tread will appear on the tire when the tread is worn down to 1/16th of an inch (2 mm).

When the tire tread wears down to the same height as these “wear bars”, the tire is worn out and must be replaced.

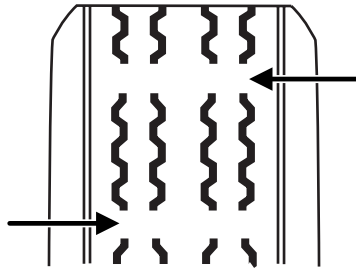

Damage

Periodically inspect the tire treads and sidewalls for damage (such as bulges in the tread or sidewalls, cracks in the tread groove and separation in the tread or sidewall). If damage is observed or suspected have the tire inspected by a tire professional. Tires can be damaged during off-road use, so inspection after off-road use is also recommended.

Tires, Wheels and Loading



Age

Tires degrade over time depending on many factors such as weather, storage conditions, and conditions of use (load, speed, inflation pressure, etc.) the tires experience throughout their lives. In general, tires should be replaced after six years regardless of tread wear. However, heat caused by hot climates or frequent high loading conditions can accelerate the aging process and may require tires to be replaced more frequently.

You should replace your spare tire when you replace the road tires or after six years due to aging even if it has not been used.

U.S. DOT Tire Identification Number (TIN)

Both U.S. and Canada Federal regulations require tire manufacturers to place standardized information on the sidewall of all tires. This information identifies and describes the fundamental characteristics of the tire and also provides a U.S. DOT Tire Identification Number for safety standard certification and in case of a recall.

This begins with the letters “DOT” and indicates that the tire meets all federal standards. The next two numbers or letters are the plant code designating where it was manufactured, the next two are the tire size code and the last four numbers represent the week and year the tire was built. For example, the numbers 317 mean the 31st week of 1997. After 2000 the numbers go to four digits. For example, 2501 means the 25th week of 2001. The numbers in between are identification codes used for traceability. This information is used to contact customers if a tire defect requires a recall.

Tire replacement requirements

Your vehicle is equipped with tires designed to provide a safe ride and handling capability.

Tires, Wheels and Loading



Only use replacement tires and wheels that are the same size, load index, speed rating and type (such as P-metric versus LT-metric or all-season versus all-terrain) as those originally provided by Ford. The recommended tire and wheel size may be found on either the Safety Compliance Certification Label or the Tire Label which is located on the B-Pillar or edge of the driver's door. If this information is not found on these labels then you should consult your Ford dealer. Use of any tire or wheel not recommended by Ford can affect the safety and performance of your vehicle, which could result in an increased risk of loss of vehicle control, vehicle rollover, personal injury and death. Additionally the use of non-recommended tires and wheels could cause steering, suspension, axle or transfer case/power transfer unit failure. If you have questions regarding tire replacement, see an authorized dealer.



When mounting replacement tires and wheels, you should not exceed the maximum pressure indicated on the sidewall of the tire to set the beads without additional precautions listed below. If the beads do not seat at the maximum pressure indicated, re-lubricate and try again.

When inflating the tire for mounting pressures up to 20 psi greater than the maximum pressure on the tire sidewall, the following precautions must be taken to protect the person mounting the tire:

1. Make sure that you have the correct tire and wheel size.
2. Lubricate the tire bead and wheel bead seat area again.
3. Stand at a minimum of 12 feet away from the tire wheel assembly.
4. Use both eye and ear protection.

For a mounting pressure more than 20 psi greater than the maximum pressure, a Ford Dealer or other tire service professional should do the mounting.

Always inflate steel carcass tires with a remote air fill with the person inflating standing at a minimum of 12 ft. away from the tire wheel assembly.

Important: Remember to replace the wheel valve stems when the road tires are replaced on your vehicle.

It is recommended that the two front tires or two rear tires generally be replaced as a pair.

Tires, Wheels and Loading

The tire pressure sensors mounted in the wheels (originally installed on your vehicle) are not designed to be used in aftermarket wheels.

The use of wheels or tires not recommended by Ford Motor Company may affect the operation of your Tire Pressure Monitoring System.

If the TPMS indicator is flashing, your TPMS is malfunctioning. Your replacement tire might be incompatible with your TPMS, or some component of the TPMS may be damaged.

Safety practices

Driving habits have a great deal to do with your tire mileage and safety.

- Observe posted speed limits
- Avoid fast starts, stops and turns
- Avoid potholes and objects on the road
- Do not run over curbs or hit the tire against a curb when parking



If your vehicle is stuck in snow, mud, sand, etc., **do not** rapidly spin the tires; spinning the tires can tear the tire and cause an explosion. A tire can explode in as little as three to five seconds.



Do not spin the wheels at over 35 mph (56 km/h). The tires may fail and injure a passenger or bystander.

Highway hazards

No matter how carefully you drive there's always the possibility that you may eventually have a flat tire on the highway. Drive slowly to the closest safe area out of traffic. This may further damage the flat tire, but your safety is more important.

If you feel a sudden vibration or ride disturbance while driving, or you suspect your tire or vehicle has been damaged, immediately reduce your speed. Drive with caution until you can safely pull off the road. Stop and inspect the tires for damage. If a tire is under-inflated or damaged, deflate it, remove wheel and replace it with your spare tire and wheel. If you cannot detect a cause, have the vehicle towed to the nearest repair facility or tire dealer to have the vehicle inspected.

Tires, Wheels and Loading

Tire and wheel alignment

A bad jolt from hitting a curb or pothole can cause the front end of your vehicle to become misaligned or cause damage to your tires. If your vehicle seems to pull to one side when you're driving, the wheels may be out of alignment. Have an authorized dealer check the wheel alignment periodically.

Wheel misalignment in the front or the rear can cause uneven and rapid treadwear of your tires and should be corrected by an authorized dealer. Front wheel drive (FWD) vehicles and those with an independent rear suspension (if equipped) may require alignment of all four wheels.

The tires should also be balanced periodically. An unbalanced tire and wheel assembly may result in irregular tire wear.

Tire rotation

Rotating your tires at the recommended interval (as indicated in the *scheduled maintenance information* that comes with your vehicle) will help your tires wear more evenly, providing better tire performance and longer tire life. Unless otherwise specified, rotate the tires approximately every 5,000 miles (8,000 km).

- Front Wheel Drive (FWD)/ All Wheel Drive vehicles (front tires at top of diagram)

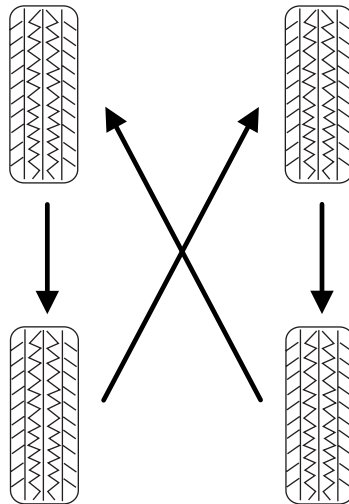

Sometimes irregular tire wear can be corrected by rotating the tires.

Tires, Wheels and Loading

Note: If your tires show uneven wear ask an authorized dealer to check for and correct any wheel misalignment, tire imbalance or mechanical problem involved before tire rotation.

Note: Your vehicle may be equipped with a dissimilar spare tire/wheel. A dissimilar spare tire/wheel is defined as a spare tire and/or wheel that is different in brand, size or appearance from the road tires and wheels. If you have a dissimilar spare tire/wheel it is intended for temporary use only and should not be used in a tire rotation.

Note: After having your tires rotated, inflation pressure must be checked and adjusted to the vehicle requirements.

INFORMATION CONTAINED ON THE TIRE SIDEWALL

Both U.S. and Canada Federal regulations require tire manufacturers to place standardized information on the sidewall of all tires. This information identifies and describes the fundamental characteristics of the tire and also provides a U.S. DOT Tire Identification Number for safety standard certification and in case of a recall.

Information on “P” type tires

P215/65R15 95H is an example of a tire size, load index and speed rating. The definitions of these items are listed below. (Note that the tire size, load index and speed rating for your vehicle may be different from this example.)

1. **P:** Indicates a tire, designated by the Tire and Rim Association (T&RA), that may be used for service on cars, SUVs, minivans and light trucks.

Note: If your tire size does not begin with a letter this may mean it is designated by either ETRTO (European Tire and Rim Technical Organization) or JATMA (Japan Tire Manufacturing Association).

2. **215:** Indicates the nominal width of the tire in millimeters from sidewall edge to sidewall edge. In general, the larger the number, the wider the tire.

3. **65:** Indicates the aspect ratio which gives the tire’s ratio of height to width.

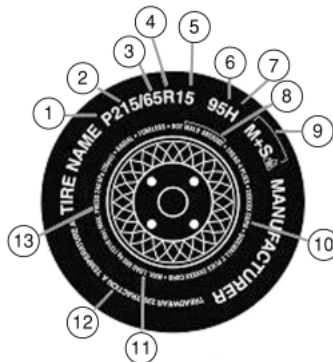

Tires, Wheels and Loading

4. **R:** Indicates a “radial” type tire.

5. **15:** Indicates the wheel or rim diameter in inches. If you change your wheel size, you will have to purchase new tires to match the new wheel diameter.

6. **95:** Indicates the tire’s load index. It is an index that relates to how much weight a tire can carry. You may find this information in your *Owner’s Guide*. If not, contact a local tire dealer.

Note: You may not find this information on all tires because it is not required by federal law.

7. **H:** Indicates the tire’s speed rating. The speed rating denotes the speed at which a tire is designed to be driven for extended periods of time under a standard condition of load and inflation pressure. The tires on your vehicle may operate at different conditions for load and inflation pressure. These speed ratings may need to be adjusted for the difference in conditions. The ratings range from 81 mph (130 km/h) to 186 mph (299 km/h). These ratings are listed in the following chart.

Note: You may not find this information on all tires because it is not required by federal law.

Letter rating	Speed rating - mph (km/h)
M	81 mph (130 km/h)
N	87 mph (140 km/h)
Q	99 mph (159 km/h)
R	106 mph (171 km/h)
S	112 mph (180 km/h)
T	118 mph (190 km/h)
U	124 mph (200 km/h)
H	130 mph (210 km/h)
V	149 mph (240 km/h)
W	168 mph (270 km/h)
Y	186 mph (299 km/h)

Note: For tires with a maximum speed capability over 149 mph (240 km/h), tire manufacturers sometimes use the letters ZR. For those with a maximum speed capability over 186 mph (299 km/h), tire manufacturers always use the letters ZR.

Tires, Wheels and Loading

8. **U.S. DOT Tire Identification Number (TIN):** This begins with the letters “DOT” and indicates that the tire meets all federal standards. The next two numbers or letters are the plant code designating where it was manufactured, the next two are the tire size code and the last four numbers represent the week and year the tire was built. For example, the numbers 317 mean the 31st week of 1997. After 2000 the numbers go to four digits. For example, 2501 means the 25th week of 2001. The numbers in between are identification codes used for traceability. This information is used to contact customers if a tire defect requires a recall.

9. **M+S or M/S:** Mud and Snow, or

AT: All Terrain, or

AS: All Season.

10. **Tire Ply Composition and Material Used:** Indicates the number of plies or the number of layers of rubber-coated fabric in the tire tread and sidewall. Tire manufacturers also must indicate the ply materials in the tire and the sidewall, which include steel, nylon, polyester, and others.

11. **Maximum Load:** Indicates the maximum load in kilograms and pounds that can be carried by the tire. Refer to the Safety Compliance Certification Label, which is located on the B-Pillar or the edge of the driver’s door, for the correct tire pressure for your vehicle.

12. Treadwear, Traction and Temperature Grades

- **Treadwear:** The treadwear grade is a comparative rating based on the wear rate of the tire when tested under controlled conditions on a specified government test course. For example, a tire graded 150 would wear one and one-half (1½) times as well on the government course as a tire graded 100.
- **Traction:** The traction grades, from highest to lowest are AA, A, B, and C. The grades represent the tire’s ability to stop on wet pavement as measured under controlled conditions on specified government test surfaces of asphalt and concrete. A tire marked C may have poor traction performance.
- **Temperature:** The temperature grades are A (the highest), B and C, representing the tire’s resistance to the generation of heat and its ability to dissipate heat when tested under controlled conditions on a specified indoor laboratory test wheel.

Tires, Wheels and Loading

13. **Maximum Permissible Inflation Pressure:** Indicates the tire manufacturers' maximum permissible pressure and/or the pressure at which the maximum load can be carried by the tire. This pressure is normally higher than the manufacturer's recommended cold inflation pressure which can be found on the Safety Compliance Certification Label or Tire Label which is located on the B-Pillar or the edge of the driver's door. The cold inflation pressure should never be set lower than the recommended pressure on the vehicle label.

The tire suppliers may have additional markings, notes or warnings such as standard load, radial tubeless, etc.

Additional information contained on the tire sidewall for "LT" type tires

"LT" type tires have some additional information beyond those of "P" type tires; these differences are described below:

1. **LT:** Indicates a tire, designated by the Tire and Rim Association (T&RA), that is intended for service on light trucks.

2. **Load Range/Load Inflation Limits:** Indicates the tire's load-carrying capabilities and its inflation limits.

3. **Maximum Load Dual lb. (kg)**

at psi (kPa) cold: Indicates the maximum load and tire pressure when the tire is used as a dual; defined as four tires on the rear axle (a total of six or more tires on the vehicle).

4. **Maximum Load Single lb. (kg) at psi (kPa) cold:** Indicates the maximum load and tire pressure when the tire is used as a single; defined as two tires (total) on the rear axle.

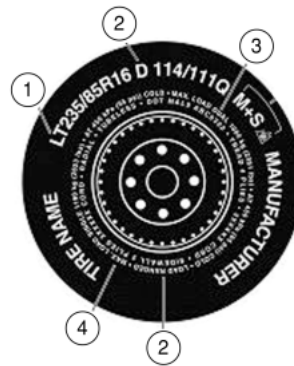

Tires, Wheels and Loading

Information on “T” type tires

“T” type tires have some additional information beyond those of “P” type tires; these differences are described below:

T145/80D16 is an example of a tire size.

Note: The temporary tire size for your vehicle may be different from this example.

1. **T:** Indicates a type of tire, designated by the Tire and Rim Association (T&RA), that is intended for temporary service on cars, SUVs, minivans and light trucks.

2. **145:** Indicates the nominal width of the tire in millimeters from sidewall edge to sidewall edge. In general, the larger the number, the wider the tire.

3. **80:** Indicates the aspect ratio which gives the tire’s ratio of height to width. Numbers of 70 or lower indicate a short sidewall.

4. **D:** Indicates a “diagonal” type tire.

R: Indicates a “radial” type tire.

5. **16:** Indicates the wheel or rim diameter in inches. If you change your wheel size, you will have to purchase new tires to match the new wheel diameter.

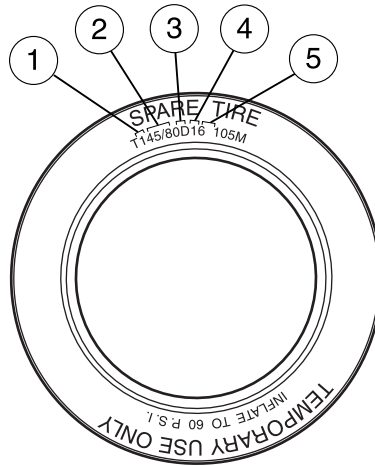

Location of the tire label

You will find a Tire Label containing tire inflation pressure by tire size and other important information located on the B-Pillar or the edge of the driver’s door. Refer to the payload description and graphic in the *Vehicle loading — with and without a trailer* section.

Tires, Wheels and Loading

TIRE PRESSURE MONITORING SYSTEM (TPMS)

Each tire, including the spare (if provided), should be checked monthly when cold and inflated to the inflation pressure recommended by the vehicle manufacturer on the

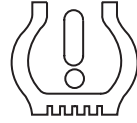

vehicle placard or tire inflation pressure label. (If your vehicle has tires of a different size than the size indicated on the vehicle placard or tire inflation pressure label, you should determine the proper tire inflation pressure for those tires.)

As an added safety feature, your vehicle has been equipped with a tire pressure monitoring system (TPMS) that illuminates a low tire pressure telltale when one or more of your tires is significantly under-inflated. Accordingly, when the low tire pressure telltale illuminates, you should stop and check your tires as soon as possible, and inflate them to the proper pressure. Driving on a significantly under-inflated tire causes the tire to overheat and can lead to tire failure. Under-inflation also reduces fuel efficiency and tire tread life, and may affect the vehicle's handling and stopping ability.

Please note that the TPMS is not a substitute for proper tire maintenance, and it is the driver's responsibility to maintain correct tire pressure, even if under-inflation has not reached the level to trigger illumination of the TPMS low tire pressure telltale.

The Tire Pressure Monitoring System complies with part 15 of the FCC rules and with RSS-210 of Industry Canada. Operation is subject to the following two conditions: (1) This device may not cause harmful interference, and (2) This device must accept any interference received, including interference that may cause undesired operation.



The Tire Pressure Monitoring System is NOT a substitute for manually checking tire pressure. The tire pressure should be checked periodically (at least monthly) using a tire gauge, see *Inflating your tires* in this chapter. Failure to properly maintain your tire pressure could increase the risk of tire failure, loss of control, vehicle rollover and personal injury.

Tires, Wheels and Loading

Changing tires with TPMS

Each road tire is equipped with a tire pressure sensor fastened to the inside rim of the wheel. The pressure sensor is covered by the tire and is not visible unless the tire is removed. The pressure sensor is located opposite (180 degrees) from the valve stem. Care must be taken when changing the tire to avoid damaging the sensor. It is recommended that you always have your tires serviced by an authorized dealer.

The tire pressure should be checked periodically (at least monthly) using an accurate tire gauge, refer to *Inflating your tires* in this chapter.

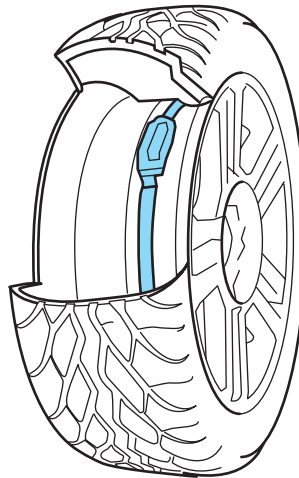

Understanding your Tire Pressure Monitoring System (TPMS)

The Tire Pressure Monitoring System measures pressure in your four road tires and sends the tire pressure readings to your vehicle. The Low Tire Warning Lamp will turn ON if the tire pressure is significantly low. Once the light is illuminated, your tires are under inflated and need to be inflated to the manufacturer's recommended tire pressure. Even if the light turns ON and a short time later turns OFF, your tire pressure still needs to be checked.

When your temporary spare tire is installed

When one of your road tires needs to be replaced with the temporary spare, the TPMS system will continue to identify an issue to remind you that the damaged road wheel/tire needs to be repaired and put back on your vehicle.

To restore the full functionality of the Tire Pressure Monitoring System, have the damaged road wheel/tire repaired and remounted on your vehicle. For additional information, refer to *Changing tires with TPMS* in this section.

Tires, Wheels and Loading

When you believe your system is not operating properly

The main function of the Tire Pressure Monitoring System is to warn you when your tires need air. It can also warn you in the event the system is no longer capable of functioning as intended. Please refer to the following chart for information concerning your Tire Pressure Monitoring System:

Low Tire Pressure Warning Light	Possible cause	Customer Action Required
Solid Warning Light	Tire(s) under-inflated	1. Check your tire pressure to ensure tires are properly inflated; refer to <i>Inflating your tires</i> in this chapter. 2. After inflating your tires to the manufacturer's recommended inflation pressure as shown on the Tire Label (located on the edge of driver's door or the B-Pillar), the vehicle must be driven for at least two minutes over 20 mph (32 km/h) before the light will turn OFF.
	Spare tire in use	Your temporary spare tire is in use. Repair the damaged road wheel/tire and reinstall it on the vehicle to restore system functionality. For a description on how the system functions, refer to <i>When your temporary spare tire is installed</i> in this section.
	TPMS malfunction	If your tires are properly inflated and your spare tire is not in use and the light remains ON, have the system inspected by your authorized dealer.

Tires, Wheels and Loading

Low Tire Pressure Warning Light	Possible cause	Customer Action Required
Flashing Warning Light	Spare tire in use	Your temporary spare tire is in use. Repair the damaged road wheel and re-mount it on the vehicle to restore system functionality. For a description of how the system functions under these conditions, refer to <i>When your temporary spare tire is installed</i> in this section.
	TPMS malfunction	If your tires are properly inflated and your spare tire is not in use and the TPMS warning light is still ON, have the system inspected by your authorized dealer.

When inflating your tires

When putting air into your tires (such as at a gas station or in your garage), the Tire Pressure Monitoring System may not respond immediately to the air added to your tires.

It may take up to two minutes of driving over 20 mph (32 km/h) for the light to turn OFF after you have filled your tires to the recommended inflation pressure.

How temperature affects your tire pressure

The Tire Pressure Monitoring System (TPMS) monitors tire pressure in each pneumatic tire. While driving in a normal manner, a typical passenger tire inflation pressure may increase approximately 2 to 4 psi (14 to 28 kPa) from a cold start situation. If the vehicle is stationary over night with the outside temperature significantly lower than the daytime temperature, the tire pressure may decrease approximately 3 psi (20.7 kPa) for a drop of 30° F (16.6°C) in ambient temperature. This lower pressure value may be detected by the TPMS as being significantly lower than the recommended inflation pressure and activate the TPMS warning for low tire pressure. If the low tire pressure warning light is ON, visually check each tire to verify that no tire is flat. (If one or more tires are flat, repair as necessary.) Check air pressure in the road tires. If any tire is under-inflated, carefully drive the vehicle to the nearest location where air can be added to the tires. Inflate all the tires to the recommended inflation pressure.

Tires, Wheels and Loading

SNOW TIRES AND CHAINS



Snow tires must be the same size and grade as the tires you currently have on your vehicle.

The tires on your vehicle have all weather treads to provide traction in rain and snow. However, in some climates, you may need to use snow tires and chains. If you need to use chains, it is recommended that only cable chains are used with steel wheels (of the same size and specifications) as chains may chip aluminum wheels.

Follow these guidelines when using snow tires and chains:

- Use only cable chains on 18 inch wheels with P245/60R18 tires.
- Install cable chains securely, verifying that the chains do not touch any wiring, brake lines or fuel lines.
- Drive cautiously. If you hear the cable chains rub or bang against your vehicle, stop and re-tighten the cable chains. If this does not work, remove the cable chains to prevent damage to your vehicle.
- If possible, avoid fully loading your vehicle.
- Remove the tire cable chains when they are no longer needed. Do not use tire cable chains on dry roads.
- The suspension insulation and bumpers will help prevent vehicle damage. Do not remove these components from your vehicle when using snow tires and cable chains.

VEHICLE LOADING – WITH AND WITHOUT A TRAILER

This section will guide you in the proper loading of your vehicle and/or trailer, to keep your loaded vehicle weight within its design rating capability, with or without a trailer. Properly loading your vehicle will provide maximum return of vehicle design performance. Before loading your vehicle, familiarize yourself with the following terms for determining your vehicle's weight ratings, with or without a trailer, from the vehicle's Tire Label or Safety Compliance Certification Label:

Base Curb Weight – is the weight of the vehicle including a full tank of fuel and all standard equipment. It does not include passengers, cargo, or optional equipment.

Vehicle Curb Weight – is the weight of your new vehicle when you picked it up from your authorized dealer plus any aftermarket equipment.

202

Tires, Wheels and Loading

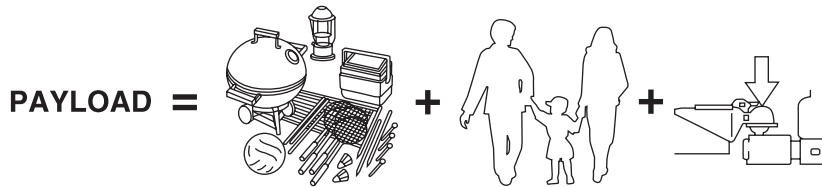

Payload – is the combined weight of cargo and passengers that the vehicle is carrying. The maximum payload for your vehicle can be found on the Tire Label on the B-Pillar or the edge of the driver's door (vehicles exported outside the US and Canada may not have a Tire Label). Look for **“THE COMBINED WEIGHT OF OCCUPANTS AND CARGO SHOULD NEVER EXCEED XXX kg OR XXX lb.”** for maximum payload. The payload listed on the Tire Label is the maximum payload for the vehicle as built by the assembly plant. If any aftermarket or authorized-dealer installed equipment has been installed on the vehicle, the weight of the equipment must be subtracted from the payload listed on the Tire Label in order to determine the new payload.

 The appropriate loading capacity of your vehicle can be limited either by volume capacity (how much space is available) or by payload capacity (how much weight the vehicle should carry). Once you have reached the maximum payload of your vehicle, do not add more cargo, even if there is space available. Overloading or improperly loading your vehicle can contribute to loss of vehicle control and vehicle rollover.

Tires, Wheels and Loading

Example only:

TIRE AND LOADING INFORMATION				
SEATING CAPACITY		TOTAL 5	FRONT 2	REAR 3
The combined weight of occupants and cargo should never exceed : XXX kg or XXX lbs.				
TIRE	SIZE	COLD TIRE PRESSURE	SEE OWNERS MANUAL FOR ADDITIONAL INFORMATION	
FRONT	LT225/75R 16.5E	200 KPA, 29 PSI		
REAR	LT225/75R 16.5E	200 KPA, 29 PSI		
SPARE	T145/80D16 P225/60R17	420 KPA, 60 PSI 200 KPA, 29 PSI		

TIRE AND LOAD INFORMATION				
SEATING CAPACITY		TOTAL XX	FRONT XX	REAR X
NOMBRE DE PLACES		TOTAL	AVANT	ARRIERE
The combined weight of occupants and cargo should never exceed : XXX kg. La charge du véhicule (occupants et bagages) ne doit jamais dépasser : XXX lbs.				
TIRE PNEUS	SIZE DIMENSIONS	COLD TIRE PRESSURE PRESSION A FROID	SEE OWNERS MANUAL FOR ADDITIONAL INFORMATION CONSULTER LE GUIDE DU PROPRIETAIRE POUR DE PLUS AMPLES RENSEIGNEMENTS	
FRONT/ AVANT	LT225/75R 16.5E	200 KPA, 29 PSI		
REAR/ ARRIERE	LT225/75R 16.5E	200 KPA, 29 PSI		
SPARE/ PNEU DE SECOURS	T145/80D16 P225/60R17	420 KPA, 60 PSI 200 KPA, 29 PSI		

CARGO

=



+

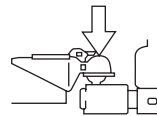

Cargo Weight – includes all weight added to the Base Curb Weight, including cargo and optional equipment. When towing, trailer tongue load weight is also part of cargo weight.

GAW (Gross Axle Weight) – is the total weight placed on each axle (front and rear) – including vehicle curb weight and all payload.

204

2007 MKX (mkx)
Owners Guide (post-2002-fmt)
USA (fus)

Tires, Wheels and Loading

GAWR (Gross Axle Weight Rating) – is the maximum allowable weight that can be carried by a single axle (front or rear). **These numbers are shown on the Safety Compliance Certification Label located on the B-Pillar or the edge of the driver's door. The total load on each axle must never exceed its GAWR.**

Note: For trailer towing information refer to *Trailer towing* found in this chapter or the *RV and Trailer Towing Guide* provided by your authorized dealer.

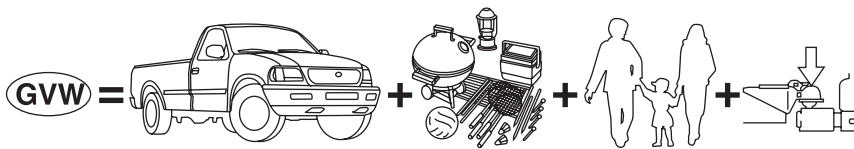

GVW (Gross Vehicle Weight) – is the Vehicle Curb Weight + cargo + passengers.

GVWR (Gross Vehicle Weight Rating) – is the maximum allowable weight of the fully loaded vehicle (including all options, equipment, passengers and cargo). **The GVWR is shown on the Safety Compliance Certification Label located on the B-Pillar or the edge of the driver's door. The GVW must never exceed the GVWR.**

MFD. BY FORD MOTOR CO.					
DATE: XX/XX	GVWR: XXXXLB/ XXXXKKG				
FRONT GAWR: XXXXL	REAR GAWR: XXXXLB				
XXXXKKG	WITH	XXXXKKG	WITH		
XXXX/XXXXXXX	TIRES	XXXX/XXXXXXX	TIRES		
XXXX.XX	RIMS	XXXX.XX	RIMS		
AT XXX kPa/XX	PSI COLD	AT XXX kPa/XX	PSI COLD		
THIS VEHICLE CONFORMS TO ALL APPLICABLE FEDERAL MOTOR VEHICLE SAFETY AND THEFT PREVENTION STANDARDS IN EFFECT ON THE DATE OF MANUFACTURE SHOWN ABOVE.					
VIN: XXXXXXXXXXXXXXXXX			XXXXX		
TYPE: XXX			XXXXX		
EXT PNT: XX	RC: XX	DSO:			
WB ¹ BRK ²	INT TR ³	TP/PS ⁴	R ⁵	AXLE ⁶	TR SPR ⁷ XXXXX
XXX X	XX	X	XX	X XX	XXX
XXXXXXXXXXXX XXX XXXX-XXXXXX-XX					



Exceeding the Safety Compliance Certification Label vehicle weight rating limits could result in substandard vehicle handling or performance, engine, transmission and/or structural damage, serious damage to the vehicle, loss of control and personal injury.

Tires, Wheels and Loading

$$\text{GCW} = \text{GVW} + \text{Trailer}$$

GCW (Gross Combined Weight) – is the weight of the loaded vehicle (GVW) plus the weight of the fully loaded trailer.

GCWR (Gross Combined Weight Rating) – is the maximum allowable weight of the vehicle and the loaded trailer – including all cargo and passengers – that the vehicle can handle without risking damage. (Important: The towing vehicles' braking system is rated for operation at GVWR, not at GCWR. Separate functional brakes should be used for safe control of towed vehicles and for trailers where the GCW of the towing vehicle plus the trailer exceed the GVWR of the towing vehicle. **The GCW must never exceed the GCWR.**

Maximum Loaded Trailer Weight – is the highest possible weight of a fully loaded trailer the vehicle can tow. It assumes a vehicle with only mandatory options, no cargo (internal or external), a tongue load of 10–15% (conventional trailer), and driver only (150 lb. [68 kg]). **Consult your authorized dealer (or the *RV and Trailer Towing Guide* provided by your authorized dealer) for more detailed information.**



Do not exceed the GVWR or the GAWR specified on the Safety Compliance Certification Label.



Do not use replacement tires with lower load carrying capacities than the original tires because they may lower the vehicle's GVWR and GAWR limitations. Replacement tires with a higher limit than the original tires do not increase the GVWR and GAWR limitations.



Exceeding any vehicle weight rating limitation could result in serious damage to the vehicle and/or personal injury.

Steps for determining the correct load limit:

1. Locate the statement “The combined weight of occupants and cargo should never exceed XXX kg or XXX lbs.” on your vehicle's placard.
2. Determine the combined weight of the driver and passengers that will be riding in your vehicle.

Tires, Wheels and Loading

3. Subtract the combined weight of the driver and passengers from XXX kg or XXX lbs.

4. The resulting figure equals the available amount of cargo and luggage load capacity. For example, if the “XXX” amount equals 1,400 lbs. and there will be five 150 lb. passengers in your vehicle, the amount of available cargo and luggage load capacity is 650 lbs. ($1400 - 750$ (5×150) = 650 lb.). In metric units ($635 - 340$ (5×68) = 295 kg.)

5. Determine the combined weight of luggage and cargo being loaded on the vehicle. That weight may not safely exceed the available cargo and luggage load capacity calculated in Step 4.

6. If your vehicle will be towing a trailer, load from your trailer will be transferred to your vehicle. Consult this manual to determine how this reduces the available cargo and luggage load capacity of your vehicle.

The following gives you a few examples on how to calculate the available amount of cargo and luggage load capacity:

- Another example for your vehicle with 1400 lb. (635 kg) of cargo and luggage capacity. You decide to go golfing. Is there enough load capacity to carry you, 4 of your friends and all the golf bags? You and four friends average 220 lb. (99 kg) each and the golf bags weigh approximately 30 lb. (13.5 kg) each. The calculation would be: $1400 - (5 \times 220) - (5 \times 30) = 1400 - 1100 - 150 = 150$ lb. Yes, you have enough load capacity in your vehicle to transport four friends and your golf bags. In metric units, the calculation would be: $635 \text{ kg} - (5 \times 99 \text{ kg}) - (5 \times 13.5 \text{ kg}) = 635 - 495 - 67.5 = 72.5$ kg.
- A final example for your vehicle with 1400 lb. (635 kg) of cargo and luggage capacity. You and one of your friends decide to pick up cement from the local home improvement store to finish that patio you have been planning for the past 2 years. Measuring the inside of the vehicle with the rear seat folded down, you have room for 12-100 lb. (45 kg) bags of cement. Do you have enough load capacity to transport the cement to your home? If you and your friend each weigh 220 lb. (99 kg), the calculation would be: $1400 - (2 \times 220) - (12 \times 100) = 1400 - 440 - 1200 = -240$ lb. No, you do not have enough cargo capacity to carry that much weight. In metric units, the calculation would be: $635 \text{ kg} - (2 \times 99 \text{ kg}) - (12 \times 45 \text{ kg}) = 635 - 198 - 540 = -103$ kg. You will need to reduce the load weight by at least 240 lb. (104 kg). If you remove 3-100 lb. (45 kg) cement bags, then the load calculation would be:
 $1400 - (2 \times 220) - (9 \times 100) = 1400 - 440 - 900 = 60$ lb. Now you have the load capacity to transport the cement and your friend home. In metric units, the calculation would be: $635 \text{ kg} - (2 \times 99 \text{ kg}) - (9 \times 45 \text{ kg}) = 635 - 198 - 405 = 32$ kg.

Tires, Wheels and Loading

The above calculations also assume that the loads are positioned in your vehicle in a manner that does not overload the Front or the Rear Gross Axle Weight Rating specified for your vehicle on the Safety Compliance Certification Label found on the edge of the driver's door.

TRAILER TOWING

Trailer towing with your vehicle may require the use of a trailer tow option package.

Trailer towing puts additional loads on your vehicle's engine, transmission, axle, brakes, tires, and suspension. For your safety and to maximize vehicle performance, be sure to use the proper equipment while towing.

When towing maximum loads under high outside temperatures and on steep grades, the A/C system may cycle on and off to protect the engine from overheating. This may result in a temporary increase of interior temperatures.

Follow these guidelines to ensure safe towing procedure:

- Stay within your vehicle's load limits.
- Thoroughly prepare your vehicle for towing. Refer to *Preparing to tow* in this chapter.
- Use extra caution when driving while trailer towing. Refer to *Driving while you tow* in this chapter.
- Service your vehicle more frequently if you tow a trailer. Refer to the severe duty schedule in the scheduled maintenance guide.
- Do not tow a trailer until your vehicle has been driven at least 500 miles (800 km).
- Refer to the instructions included with towing accessories for the proper installation and adjustment specifications.

Do not exceed the maximum loads listed on the Safety Compliance Certification label. For load specification terms found on the label, refer to *Vehicle loading* in this chapter. Remember to figure in the tongue load of your loaded vehicle when figuring the total weight.

Tires, Wheels and Loading

FWD			
GCWR (Gross Combined Weight Rating)/Trailer Weight			
Engine	Maximum GCWR-lb. (kg)	Trailer weight range-lb. (kg) (0-Maximum)	Tongue load-lb. (kg) (0-Maximum)
3.5L Class I towing (standard)	7350 (3334)	0-2000 (0-907)	0-200 (0-91)
3.5L Class II towing (optional)	8470 (3810)	0-3500 (0-1588)	0-350 (0-159)

AWD			
GCWR (Gross Combined Weight Rating)/Trailer Weight			
Engine	Maximum GCWR-lb. (kg)	Trailer weight range-lb. (kg) (0-Maximum)	Tongue load-lb. (kg) (0-Maximum)
3.5L Class I towing (standard)	7550 (3425)	0-2000 (0-907)	0-200 (0-91)
3.5L Class II towing (optional)	8690 (3942)	0-3500 (0-1588)	0-350 (0-159)



Do not exceed the GVWR or the GAWR specified on the certification label.



Towing trailers beyond the maximum recommended gross trailer weight exceeds the limit of the vehicle and could result in engine damage, transmission damage, structural damage, loss of vehicle control, vehicle rollover and personal injury.

Preparing to tow

Use the proper equipment for towing a trailer and make sure it is properly attached to your vehicle. See your authorized dealer or a reliable trailer dealer if you require assistance.

Tires, Wheels and Loading

Hitches

Do not use hitches that clamp onto the vehicle's bumper or attach to the axle. You must distribute the load in your trailer so that 10%–15% of the total weight of the trailer is on the tongue.

Safety chains

Always connect the trailer's safety chains to the hook retainers on the hitch. To connect the trailer's safety chains, cross the chains under the trailer tongue and allow slack for turning corners.

If you use a rental trailer, follow the instructions that the rental agency gives to you.

Do not attach safety chains to the bumper.

Trailer brakes

Be sure your trailer conforms to all applicable local and Federal Regulations regarding trailer braking. If your trailer is equipped with electronically controlled brakes you will need to have an electronic brake controller with associated wiring installed to your vehicle by an authorized dealer.



Do not connect a trailer's hydraulic brake system directly to your vehicle's brake system. Your vehicle may not have enough braking power and your chances of having a collision greatly increase.

The braking system of the tow vehicle is rated for operation at the GVWR not GCWR.

Trailer lamps

Trailer lamps are required on most towed vehicles. Make sure all running lights, brake lights, turn signals and hazard lights are working.

Do not splice into the vehicle lamp wiring for trailer lamps. Your vehicle uses an advanced electronic module to control and monitor your vehicle lamps. Splicing into the wiring or attaching wiring to the vehicle bulb. may DISABLE the rear vehicle lamps or cause them not to function properly. Your lamp outage feature may also be disabled or provide incorrect information.

See your authorized dealer or trailer rental agency for proper instructions and equipment for hooking up trailer lamps.

Tires, Wheels and Loading

Trailer tow connector (equipped on vehicles with a Class II trailer tow/prep package)

The trailer tow connector is located under the rear bumper, on the driver's side of the vehicle.

Refer to the following chart for information regarding the factory-equipped trailer tow connector:

Trailer tow connector	
Color	Function
1. Dark Green	Right hand turn signal/brake/hazard flasher
2. Yellow	Left hand turn signal/brake/hazard flasher
3. Brown	Tail lamps/parking lamps
4. White	Ground

Driving while you tow

When towing a trailer:

- Keep your speed no faster than 70 mph (112 km/h) during the first 500 miles (800 km) of towing a trailer, and don't make full throttle starts.
- Turn off the speed control. The speed control may shut off automatically when you are towing on long, steep grades.
- Consult your local motor vehicle speed regulations for towing a trailer.
- To eliminate excessive shifting, use a lower gear. This will also assist in transmission cooling. (For additional information, refer to the *Understanding the positions of the 6-speed automatic transmission* section in this chapter.
- Anticipate stops and brake gradually.
- Do not exceed the GCWR rating or transmission damage may occur.

Servicing after towing

If you tow a trailer for long distances, your vehicle will require more frequent service intervals. Refer to your *Scheduled Maintenance Guide* for more information.

Tires, Wheels and Loading

Trailer towing tips

- Practice turning, stopping and backing up before starting on a trip to get the feel of the vehicle trailer combination. When turning, make wider turns so the trailer wheels will clear curbs and other obstacles.
- Allow more distance for stopping with a trailer attached.
- If you are driving down a long or steep hill, shift to a lower gear. Do not apply the brakes continuously, as they may overheat and become less effective.
- The trailer tongue weight should be 10–15% of the loaded trailer weight.
- If you will be towing a trailer frequently in hot weather, hilly conditions, at GCWR, or any combination of these factors, consider refilling your rear axle with synthetic gear lube if not already so equipped. Refer to the *Maintenance and Specifications* chapter for the lubricant specification. Remember that regardless of the rear axle lube used, do not tow a trailer for the first 500 miles (800 km) of a new vehicle, and that the first 500 miles (800 km) of towing be done at no faster than 70 mph (112 km/h) with no full throttle starts.
- After you have traveled 50 miles (80 km), thoroughly check your hitch, electrical connections and trailer wheel lug nuts.
- To aid in engine/transmission cooling and A/C efficiency during hot weather while stopped in traffic, place the gearshift lever in P (Park).
- Vehicles with trailers should not be parked on a grade. If you must park on a grade, place wheel chocks under the trailer's wheels.

RECREATIONAL TOWING

Follow these guidelines for your specific powertrain combination to tow your vehicle for personal travel (such as behind a motor home or a truck).

In case of roadside emergency with a disabled vehicle, please refer to *Wrecker towing* in the *Roadside Emergencies* chapter.

These guidelines are designed to prevent damage to your vehicle.

Front Wheel Drive (FWD) vehicles:

Tow your Front Wheel Drive vehicle with all four wheels on the ground or with the front wheels off the ground by using a tow dolly. If you are using a tow dolly follow the instructions specified by the equipment provider.

Tires, Wheels and Loading

All Wheel Drive (AWD) vehicles:

Tow your All Wheel Drive vehicle with all four wheels on the ground or with all four wheels off the ground using a vehicle transport trailer. **Do not tow your All Wheel Drive vehicle with the front wheels off the ground (by using a tow dolly) and the rear wheels on the ground.** This will cause damage to your AWD system. If you are using a vehicle transport trailer, follow the instruction specified by the equipment provider.

Note: If you tow your vehicle with all four wheels on the ground, follow these instructions:

- Tow only in the forward direction
- Release the parking brake
- Place the transmission shift lever in Neutral (N)
- Turn the key in the ignition to the ACC position (refer to *Starting* in the *Driving* chapter). The ACC position also unlocks the steering wheel.
- Do not exceed 65 mph (105 km/h)
- Start the engine and allow it to run for five minutes at the beginning of each day and at each fuel stop.

Driving

STARTING

Positions of the ignition

1. LOCK, locks the automatic transaxle gearshift lever and allows key removal. This position also shuts the engine and all electrical accessories off without locking the steering wheel. To lock the steering wheel, remove the key then turn the steering wheel.

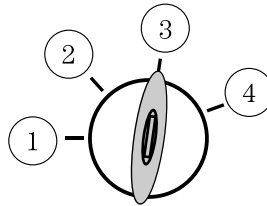

2. ACC, allows the electrical accessories such as the radio to operate while the engine is not running. This position also unlocks the steering wheel.

3. RUN, all electrical circuits operational. Warning lights illuminated. Key position when driving.

4. START, cranks the engine. Release the key as soon as the engine starts.

Preparing to start your vehicle

Engine starting is controlled by the powertrain control system. This system meets all Canadian Interference-Causing Equipment standard requirements regulating the impulse electrical field strength of radio noise.

When starting a fuel-injected engine, avoid pressing the accelerator before or during starting. Only use the accelerator when you have difficulty starting the engine. For more information on starting the vehicle, refer to *Starting the engine* in this chapter.





Extended idling at high engine speeds can produce very high temperatures in the engine and exhaust system, creating the risk of fire or other damage.



Do not park, idle, or drive your vehicle in dry grass or other dry ground cover. The emission system heats up the engine compartment and exhaust system, which can start a fire.

Driving

 Do not start your vehicle in a closed garage or in other enclosed areas. Exhaust fumes can be toxic. Always open the garage door before you start the engine. See *Guarding against exhaust fumes* in this chapter for more instructions.

 If you smell exhaust fumes inside your vehicle, have your dealer inspect your vehicle immediately. Do not drive if you smell exhaust fumes.

Important safety precautions

When the engine starts, the idle RPM runs faster to warm the engine. If the engine idle speed does not slow down automatically, have the vehicle checked.

Before starting the vehicle:

1. Make sure all vehicle occupants buckle their safety belts. For more information on safety belts and their proper usage, refer to the *Seating and Safety Restraints* chapter.
2. Make sure the headlamps and electrical accessories are off.
 - Make sure the parking brake is set.

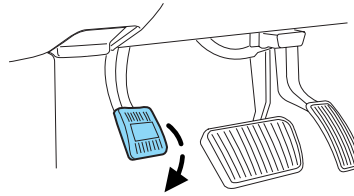

Driving

- Make sure the gearshift is in P (Park).

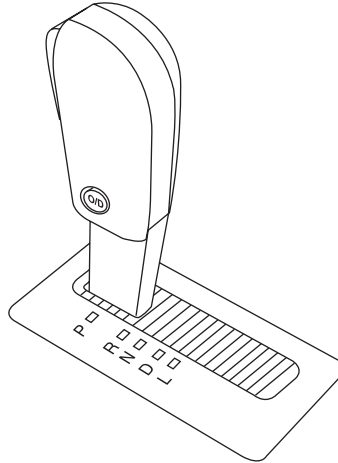

3. Turn the key to 3 (RUN) without turning the key to 4 (START).

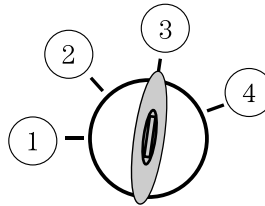

Some warning lights will briefly illuminate. See *Warning lights and chimes* in the *Instrument Cluster* chapter for more information regarding the warning lights.

Starting the engine

1. Turn the key to 3 (RUN) without turning the key to 4 (START).
2. Turn the key to 4 (START), then release the key as soon as the engine starts. Excessive cranking could damage the starter.

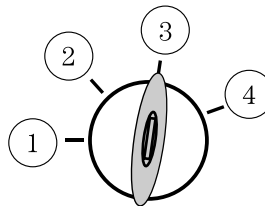

Driving

Note: If the engine does not start within five seconds on the first try, turn the key to LOCK, wait 10 seconds and try again. If the engine still fails to start, press the accelerator to the floor and try again; this will allow the engine to crank with the fuel shut off in case the engine is flooded with fuel.

Guarding against exhaust fumes

Carbon monoxide is present in exhaust fumes. Take precautions to avoid its dangerous effects.



If you smell exhaust fumes inside your vehicle, have your dealer inspect your vehicle immediately. Do not drive if you smell exhaust fumes.

Important ventilating information

If the engine is idling while the vehicle is stopped for a long period of time, open the windows at least one inch (2.5 cm) or adjust the heating or air conditioning to bring in fresh air.

ENGINE BLOCK HEATER (IF EQUIPPED)

An engine block heater warms the engine coolant which aids in starting and heater/defroster performance. Use of an engine block heater is strongly recommended if you live in a region where temperatures reach -10°F (-23°C) or below. For best results, plug the heater in at least three hours before starting the vehicle. The heater can be plugged in the night before starting the vehicle.



To reduce the risk of electrical shock, do not use your heater with ungrounded electrical systems or two-pronged (cheater) adapters.

BRAKES

Occasional brake noise is normal. If a metal-to-metal, continuous grinding or continuous squeal sound is present, the brake linings may be worn-out and should be inspected by an authorized dealer. If the vehicle has continuous vibration or shudder in the steering wheel while braking, the vehicle should be inspected by an authorized dealer.

Driving

Refer to *Brake system warning light* in the *Instrument Cluster* chapter for information on the brake system warning light.



Four-wheel anti-lock brake system (ABS)

Your vehicle is equipped with an Anti-lock Braking System (ABS). This system helps you maintain steering control during emergency stops by keeping the brakes from locking. Noise from the ABS pump motor and brake pedal pulsation may be observed during ABS braking and the brake pedal may suddenly travel a little farther as soon as ABS braking is done and normal brake operation resumes. These are normal characteristics of the ABS and should be no reason for concern.

Using ABS

When hard braking is required, apply continuous force on the brake pedal; do not pump the brake pedal since this will reduce the effectiveness of the ABS and will increase your vehicle's stopping distance. The ABS will be activated immediately, allowing you to retain steering control during hard braking and on slippery surfaces. However, the ABS does not decrease stopping distance.

ABS warning lamp

The ABS lamp in the instrument cluster momentarily illuminates when the ignition is turned on. If the light does not illuminate during start up, remains on or flashes, the ABS may be disabled and may need to be serviced.



Even when the ABS is disabled, normal braking is still effective. (If your BRAKE warning lamp illuminates with the parking brake released, have your brake system serviced immediately by an authorized dealer.)

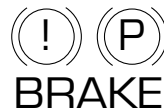

Parking brake

Apply the parking brake whenever the vehicle is parked. To set the parking brake, press the parking brake pedal down until the pedal stops.

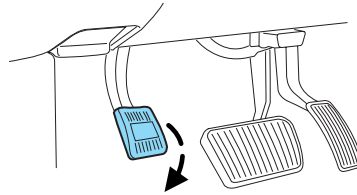

The BRAKE warning lamp in the instrument cluster illuminates and remains illuminated (when the ignition is turned ON) until the parking brake is released.



Always set the parking brake fully and make sure that the gearshift is securely latched in P (Park).

The parking brake is not recommended to stop a moving vehicle. However, if the normal brakes fail, the parking brake can be used to stop your vehicle in an emergency. Since the parking brake applies only the rear brakes, the vehicle's stopping distance will increase greatly and the handling of your vehicle will be adversely affected.

Push the parking brake pedal downward again to release the parking brake. Driving with the parking brake on will cause the brakes to wear out quickly and reduce fuel economy.

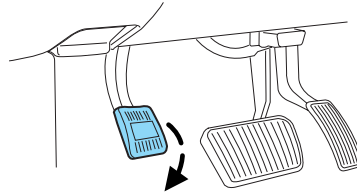

Note: If the vehicle is driven with the parking brake applied, a chime will sound.

ADVANCETRAC® WITH ROLL STABILITY CONTROL™ (RSC) STABILITY ENHANCEMENT SYSTEM

The AdvanceTrac® with RSC system provides stability enhancement features such as Roll Stability Control™ (RSC), Electronic Stability Control (ESC) and Traction Control (TCS) for certain driving situations. The system includes an AdvanceTrac® with RSC on/off button, and a “sliding car” icon in the instrument cluster.

Driving

The Anti-lock Braking System (ABS) will work with the regular brakes in order to prevent wheel lock during a braking event. This feature will also help provide better steerability during braking.

During AdvanceTrac® with RSC operation you may experience the following:

- A rumble, grunting, or grinding noise after startup and when driving off
- A slight deceleration of the vehicle
- The AdvanceTrac® with RSC indicator light will flash when the system is activated.
- If your foot is on the brake pedal, you will feel a vibration in the pedal.

Traction Control

Traction Control helps your vehicle maintain traction, when driving on slippery and/or hilly road surfaces, by detecting and controlling wheel spin. Excessive wheel spin is controlled by momentarily reducing engine power and/or applying the anti-lock brakes.

If your vehicle should become stuck in deep snow or mud, try switching the AdvanceTrac® with RSC system off by pressing the AdvanceTrac® with RSC button momentarily. This will allow your wheels to spin and your tires to “dig” for traction. If your vehicle seems to lose engine power while driving in deep sand or very deep snow, switching off the AdvanceTrac with RSC stability enhancement feature will restore full engine power and torque to each wheel.

If the AdvanceTrac® with RSC system is activated excessively in a short period of time, the brake portion of the system will disable to allow the brakes to cool down. In this situation, Traction Control will use only engine power reduction to help control the wheels from over-spinning. When the brakes have cooled down, the system will again function normally. Anti-lock braking, RSC and ESC are not affected by this condition and will function normally during the cool-down period.

During Traction Control events the “sliding car” icon in the instrument cluster will flash momentarily.

Electronic Stability Control (ESC)

The Electronic Stability Control (ESC) with RSC system may enhance your vehicle’s stability during adverse maneuvers.

The AdvanceTrac® with RSC system helps the driver maintain steering control. AdvanceTrac® with RSC will attempt to correct the vehicle motion by applying brake force at individual tires and, if necessary, by reducing engine power.

During Electronic Stability Control events the “sliding car” icon in the instrument cluster will flash momentarily.

Driving maneuvers which may activate AdvanceTrac® with RSC system include:

- Taking a turn too fast.
- Maneuvering quickly to avoid an accident, pedestrian or obstacle.
- Driving over a patch of ice.
- Changing lanes on a snow-rutted road.
- Entering a snow-free road from a snow-covered side street, or vice versa.
- Entering a paved road from a gravel road, or vice versa.
- Driving on slick surfaces.
- Cornering while towing a heavily loaded trailer (refer to *Trailer towing* in the *Tires, Wheels and Loading* chapter.)

Roll Stability Control™ (RSC)

The RSC system works in conjunction with the AdvanceTrac® system to help maintain roll stability of the vehicle during aggressive maneuvers by applying brake force to one or more wheels.

During Roll Stability Control™ (RSC) events the “sliding car” icon in the instrument cluster will flash momentarily.

Driving conditions that may activate AdvanceTrac® with RSC include:

- Emergency lane-change
- Taking a turn too fast
- Quick maneuvering to avoid an accident, pedestrian or obstacle

AdvanceTrac® with RSC button and icon functionality

The AdvanceTrac® with RSC system automatically turns on each time the engine is started, even if it was turned off when the engine was last shut down. The “sliding car” icon which is located with the warning lights in the instrument cluster will illuminate during bulb check at initial start-up and then go off. This tells you that the system is normal and active. All functions of the AdvanceTrac® with RSC system (RSC, ESC, Engine Traction Control, and Brake Traction Control) will be tested at start up. When the system is left active, the “sliding car” icon will flash only when any of the components of the system are affecting the vehicle’s performance, otherwise the light will remain off. Consequently, the “sliding car” icon will not be illuminated during most of your normal driving.

Driving

The AdvanceTrac® with RSC button, located on the center stack of the instrument panel, allows the driver to control certain features of the AdvanceTrac® with RSC system below 45 mph (70 km/h). If the



vehicle is below 45 mph (70 km/h), pressing the AdvanceTrac® with RSC button will disable RSC, ESC and Engine Traction Control and steadily illuminate the “sliding car” icon. The AdvanceTrac® with RSC system will remain enabled when the vehicle speed is above 45 mph (70 km/h) even if the button has been pressed.

In R (Reverse), ABS and the Traction Control feature will continue to function, however ESC and RSC are disabled.

All these conditions are normal during AdvanceTrac® with RSC operation.



Do not alter or modify your vehicle's suspension or steering; the resulting changes to the vehicle's handling can adversely affect the AdvanceTrac® with RSC system.



Aggressive driving in any road conditions can cause you to lose control of your vehicle increasing the risk of severe personal injury or property damage. The occurrence of a AdvanceTrac® with RSC event is an indication that at least some of the tires have exceeded their ability to grip the road; this may lead to an increased risk of loss of vehicle control, vehicle rollover, personal injury and death. If you experience a severe road event, SLOW DOWN.

If a failure is detected in the AdvanceTrac® with RSC system, and the AdvanceTrac® with RSC button has not been pushed, the warning indicator light in the instrument cluster will stay on. If the warning indicator light in the instrument cluster remains on while the engine is running, have the system serviced by an authorized dealer immediately.

STEERING

To help prevent damage to the power steering system:

- Never hold the steering wheel at its furthest turning points (until it stops) for more than a few seconds when the engine is running.
- Do not operate the vehicle with a low power steering fluid level (below the MIN mark on the reservoir).

Driving

- Some noise is normal during operation. If the noise is excessive, check for a low power steering fluid level before seeking service by your authorized dealer.
- Heavy or uneven steering efforts may be caused by a low power steering fluid level. Check for a low power steering fluid level before seeking service by your authorized dealer.
- Do not fill the power steering fluid reservoir above the MAX mark on the reservoir.

If the power steering system breaks down (or if the engine is turned off), you can steer the vehicle manually, but it takes more effort.

If the steering wanders or pulls, check for:

- an improperly inflated tire
- uneven tire wear
- loose or worn suspension components
- loose or worn steering components
- improper steering alignment

A high crown in the road or high crosswinds may also make the steering seem to wander/pull.

AUTOMATIC TRANSMISSION OPERATION

Brake-shift interlock

This vehicle is equipped with a brake-shift interlock feature that prevents the gearshift lever from being moved from P (Park) when the ignition is in the RUN position unless brake pedal is depressed.

If you cannot move the gearshift lever out of P (Park) with ignition in the RUN position and the brake pedal depressed:

Driving

1. Apply the parking brake, turn ignition key to LOCK, then remove the key.
2. Using a screwdriver (or similar tool), remove the protective cover to the interlock release access hole on the console. Insert the screwdriver (or similar tool) to release the interlock.
3. Start the vehicle.

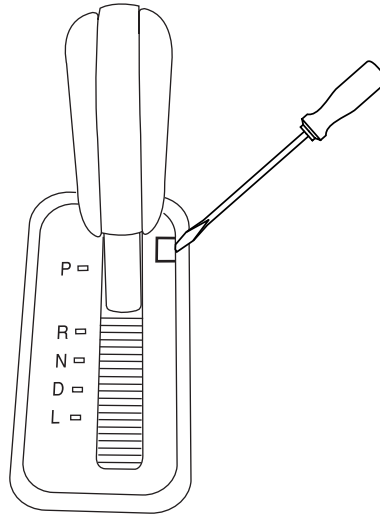

If it is necessary to use the above procedure to move the gearshift lever, it is possible that a fuse has blown or the vehicle's brakelamps are not operating properly. Refer to *Fuses and relays* in the *Roadside Emergencies* chapter.



Do not drive your vehicle until you verify that the brakelamps are working.



Always set the parking brake fully and make sure the gearshift is latched in P (Park). Turn the ignition to the LOCK position and remove the key whenever you leave your vehicle.



If the parking brake is fully released, but the brake warning lamp remains illuminated, the brakes may not be working properly. See your authorized dealer as soon as possible.

Automatic Transaxle Adaptive Learning

Your transaxle is equipped with an adaptive learning strategy found in the vehicle computer. This feature is designed to increase durability and

Driving

provide consistent shift feel over the life of the vehicle. A new vehicle or transaxle may have firm and/or soft shifts. This operation is considered normal and will not affect function or durability of the transaxle. Over time, the adaptive learning process will fully update transaxle operation. Additionally, whenever the battery is disconnected or a new battery installed, the strategy must be relearned.

Understanding the gearshift positions of the 6-speed automatic transaxle

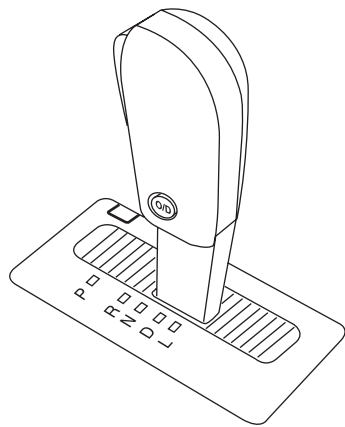

P (Park)

This position locks the transaxle and prevents the front wheels from turning.

To put your vehicle in gear:

- Depress the brake pedal
- Move the gearshift lever into the desired gear

To put your vehicle in P (Park):

- Come to a complete stop
- Move the gearshift lever and securely latch it in P (Park)

 Always set the parking brake fully and make sure the gearshift is latched in P (Park). Turn the ignition to the LOCK position and remove the key whenever you leave your vehicle.

Driving

R (Reverse)

With the gearshift lever in R (Reverse), the vehicle will move backward. Always come to a complete stop before shifting into and out of R (Reverse).

N (Neutral)

With the gearshift lever in N (Neutral), the vehicle can be started and is free to roll. Hold the brake pedal down while in this position.

D (Drive) with Overdrive

The normal driving position for the best fuel economy. Transaxle operates in gears one through six.

D (Drive) with Grade Assist

Overdrive can be deactivated by pressing the transmission control switch on the side of the gearshift lever. This will also activate Grade Assist.

- Transaxle operates in gears one through five.
- Provides engine braking. Depending on conditions the transaxle will automatically downshift to increase the level of engine braking while descending grades.
- Use when driving conditions cause excessive shifting from O/D to other gears. Examples: hilly terrain, mountainous areas and when engine braking is required.
- O/D OFF lamp in the instrument cluster is illuminated.
- To return to O/D (overdrive mode), press the transmission control switch. The O/D OFF lamp in the instrument cluster will not be illuminated.
- O/D (overdrive) is automatically returned each time the key is turned off.

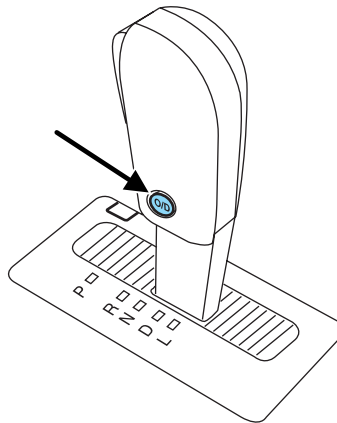

**O/D
OFF**

L (Low)

- Provides maximum engine braking.
- Will downshift to the lowest available gear for the current vehicle speed; allows for first gear when vehicle reaches slower speeds.

If your vehicle gets stuck in mud or snow

If your vehicle gets stuck in mud or snow, it may be rocked out by shifting between forward and reverse gears, stopping between shifts in a steady pattern. Press lightly on the accelerator in each gear.

Do not rock the vehicle if the engine is not at normal operating temperature or damage to the transmission may occur.

Do not rock the vehicle for more than a minute or damage to the transmission and tires may occur, or the engine may overheat.

If your vehicle is equipped with AdvanceTrac® with RSC, it may be beneficial to turn the system off so the wheels are allowed to spin.

REVERSE SENSING SYSTEM (IF EQUIPPED)

The Reverse Sensing System (RSS) sounds a tone to warn the driver of obstacles near the rear bumper when the R (Reverse) is selected and the vehicle is moving at speeds less than 3 mph (5 km/h). The system is not effective at speeds above 3 mph (5 km/h) and may not detect certain angular or moving objects.



To help avoid personal injury, please read and understand the limitations of the reverse sensing system as contained in this section. Reverse sensing is only an aid for some (generally large and fixed) objects when moving in reverse on a flat surface at “parking speeds”. Inclement weather may also affect the function of the RSS; this may include reduced performance or a false activation.



To help avoid personal injury, always use caution when in R (Reverse) and when using the RSS.



This system is not designed to prevent contact with small or moving objects. The system is designed to provide a warning to assist the driver in detecting large stationary objects to avoid damaging the vehicle. The system may not detect smaller objects, particularly those close to the ground.

Driving



Certain add-on devices such as large trailer hitches, bike or surfboard racks and any device that may block the normal detection zone of the RSS system may create false beeps.

The RSS detects obstacles up to six feet (two meters) from the rear bumper with a decreased coverage area at the outer corners of the bumper, (refer to the figures for approximate zone coverage areas). As you move closer to the obstacle, the rate of the tone increases. When the obstacle is less than 10 inches (25.0 cm) away, the tone will sound continuously. If the RSS detects a stationary or receding object further than 10 inches (25.0 cm) from the side of the vehicle, the tone will sound for only three seconds. Once the system detects an object approaching, the tone will sound again.

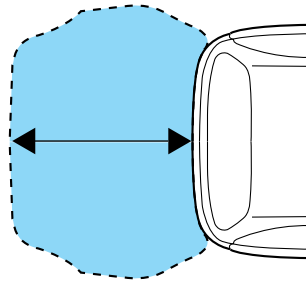
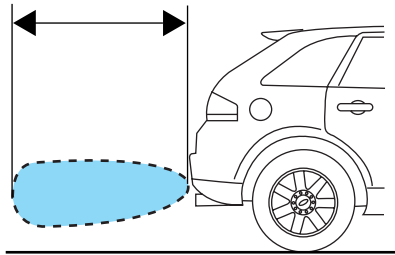

The RSS automatically turns on when the gear selector is placed in R (Reverse) and the ignition is ON. A control in the message center allows the driver to disable the system only when the ignition is ON and the gear selector is in R (Reverse). Refer to *Message center* in the *Driver Controls* chapter for more information.

Keep the RSS sensors (located on the rear bumper/fascia) free from snow, ice and large accumulations of dirt (do not clean the sensors with sharp objects). If the sensors are covered, it will affect the accuracy of the RSS.

If your vehicle sustains damage to the rear bumper/fascia, leaving it misaligned or bent, the sensing zone may be altered causing inaccurate measurement of obstacles or false alarms.

ALL WHEEL DRIVE (AWD) SYSTEM (IF EQUIPPED)

Your vehicle may be equipped with a full-time All Wheel Drive (AWD) system. With the AWD option, power will be delivered to the front wheels and distributed to the rear wheels as needed. The AWD system is active all the time and requires no input from the operator.

All components of the AWD system are sealed for life and require no maintenance.

If your vehicle is equipped with AWD, a spare tire of a different size other than the tire provided should never be used. A dissimilar spare tire size (other than the spare tire provided) or major dissimilar tire sizes between the front and rear axles could cause the AWD system to stop functioning and default to front wheel drive and could damage the system.

Note: Your AWD vehicle is not intended for severe off-road use. The AWD feature gives your vehicle some limited off-road capabilities in which driving surfaces are relatively level, obstruction-free and otherwise similar to normal on-road driving conditions. Operating your vehicle under other than those conditions could subject the vehicle to excessive stress which might result in damage which is not covered under your warranty.

Driving off-highway with AWD vehicles

AWD vehicles are equipped for driving on sand, snow, mud and rough roads and have operating characteristics that are somewhat different from conventional vehicles, both on and off the highway.

When driving at slow speeds off-highway under high outside temperatures, use L (Low) gear when possible. L (Low) gear operation will maximize the engine and transmission cooling capability.

Under severe operating conditions, the A/C may cycle on and off to protect overheating of the engine.

Basic operating principles

- Drive slower in strong crosswinds which can affect the normal steering characteristics of your vehicle.
- Be extremely careful when driving on pavement made slippery by loose sand, water, gravel, snow or ice.

Driving

If your vehicle goes off the edge of the pavement

- If your vehicle goes off the edge of the pavement, slow down, but avoid severe brake application, ease the vehicle back onto the pavement only after reducing your speed. Do not turn the steering wheel too sharply while returning to the road surface.
- It may be safer to stay on the apron or shoulder of the road and slow down gradually before returning to the pavement. You may lose control if you do not slow down or if you turn the steering wheel too sharply or abruptly.
- It often may be less risky to strike small objects, such as highway reflectors, with minor damage to your vehicle rather than attempt a sudden return to the pavement which could cause the vehicle to slide sideways out of control or rollover. Remember, your safety and the safety of others should be your primary concern.

If your vehicle gets stuck

If your vehicle gets stuck in mud or snow it may be rocked out by shifting between forward and reverse gears, stopping between shifts, in a steady pattern. Press lightly on the accelerator in each gear.

If your vehicle is equipped with AdvanceTrac® with Roll Stability Control™, it may be beneficial to disengage the AdvanceTrac® with Roll Stability Control™ system while attempting to rock the vehicle.

Do not rock the vehicle if the engine is not at normal operating temperature or damage to the transmission may occur.

Do not rock the vehicle for more than a few minutes or damage to the transmission and tires may occur or the engine may overheat.



Always set the parking brake fully and make sure the gearshift is latched in P (Park). Turn the ignition to the LOCK position and remove the key whenever you leave your vehicle.



If the parking brake is fully released, but the brake warning lamp remains illuminated, the brakes may not be working properly. See your authorized dealer.



Do not spin the wheels at over 35 mph (56 km/h). The tires may fail and injure a passenger or bystander.

Emergency maneuvers

- In an unavoidable emergency situation where a sudden sharp turn must be made, remember to avoid “over-driving” your vehicle (i.e., turn the steering wheel only as rapidly and as far as required to avoid the emergency). Excessive steering will result in less vehicle control, not more. Additionally, smooth variations of the accelerator and/or brake pedal pressure should be utilized if changes in vehicle speed are called for. Avoid abrupt steering, acceleration or braking which could result in an increased risk of loss of vehicle control, vehicle rollover and/or personal injury. Use all available road surface to return the vehicle to a safe direction of travel.
- In the event of an emergency stop, avoid skidding the tires and do not attempt any sharp steering wheel movements.
- If the vehicle goes from one type of surface to another (i.e., from concrete to gravel) there will be a change in the way the vehicle responds to a maneuver (steering, acceleration or braking). Again, avoid these abrupt inputs.

AWD Systems (if equipped)

With AWD, the vehicle uses all four wheels to power the vehicle. This increases traction, enabling you to drive over terrain and road conditions that a conventional two-wheel drive vehicle cannot.

Sand

When driving over sand, try to keep all four wheels on the most solid area of the trail. Avoid reducing the tire pressures but shift to a lower gear and drive steadily through the terrain. Apply the accelerator slowly and avoid spinning the wheels.

Do not drive your AWD vehicle in deep sand for an extended period of time. This will cause the AWD system to overheat. If the rear tires stop spinning while the front tires spin in deep sand, turn off the vehicle and allow the AWD system to cool down for a minimum of 15 minutes. After the system has cooled down, normal AWD function will return. When driving at slow speeds in deep sand under high outside temperatures, use L (Low) gear when possible. L (Low) gear operation will maximize the engine and transmission cooling capability.

Under severe operating conditions, the A/C may cycle on and off to protect overheating of the engine.

Avoid excessive speed because vehicle momentum can work against you and cause the vehicle to become stuck to the point that assistance may

Driving

be required from another vehicle. Remember, you may be able to back out the way you came if you proceed with caution.

Mud and water

If you must drive through high water, drive slowly. Traction or brake capability may be limited.

When driving through water, determine the depth; avoid water higher than the bottom of the wheel rims (for cars) or the bottom of the hubs (for trucks) (if possible) and proceed slowly. If the ignition system gets wet, the vehicle may stall.

Once through water, always try the brakes. Wet brakes do not stop the vehicle as effectively as dry brakes. Drying can be improved by moving your vehicle slowly while applying light pressure on the brake pedal.

Be cautious of sudden changes in vehicle speed or direction when you are driving in mud. Even AWD vehicles can lose traction in slick mud. As when you are driving over sand, apply the accelerator slowly and avoid spinning your wheels. If the vehicle does slide, steer in the direction of the slide until you regain control of the vehicle.

After driving through mud, clean off residue stuck to rotating driveshafts and tires. Excess mud stuck on tires and rotating driveshafts causes an imbalance that could damage drive components.

Driving through deep water may damage the transmission.

If the front or rear axle is submerged in water, the axle lubricant and PTU (Power Transfer Unit) lubricant should be checked and changed if necessary.

“Tread Lightly” is an educational program designed to increase public awareness of land-use regulations and responsibilities in our nation's wilderness areas. Ford Motor

Company joins the U.S. Forest Service and the Bureau of Land Management in encouraging you to help preserve our national forest and other public and private lands by “treading lightly.”



Driving on hilly or sloping terrain

Although natural obstacles may make it necessary to travel diagonally up or down a hill or steep incline, you should always try to drive straight up or straight down. **Avoid driving crosswise or turning on steep slopes or hills.** A danger lies in losing traction, slipping sideways and possibly rolling over. Whenever driving on a hill, determine beforehand

the route you will use. Do not drive over the crest of a hill without seeing what conditions are on the other side. Do not drive in reverse over a hill without the aid of an observer.

When climbing a steep slope or hill, start in a lower gear rather than downshifting to a lower gear from a higher gear once the ascent has started. This reduces strain on the engine and the possibility of stalling.

If you do stall out, do not try to turnaround because you might roll over. It is better to back down to a safe location.

Apply just enough power to the wheels to climb the hill. Too much power will cause the tires to slip, spin or lose traction, resulting in loss of vehicle control.

Descend a hill in the same gear you would use to climb up the hill to avoid excessive brake application and brake overheating. Do not descend in neutral; instead, disengage overdrive or manually shift to a lower gear. When descending a steep hill, avoid sudden hard braking as you could lose control. The front wheels have to be turning in order to steer the vehicle.

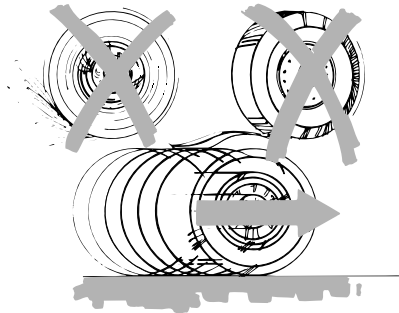

Your vehicle has anti-lock brakes, therefore apply the brakes steadily. Do not “pump” the brakes.

Driving on snow and ice

Note: Excessive tire slippage can cause transaxle damage.

AWD vehicles have advantages over 2WD vehicles in snow and ice but can skid like any other vehicle.

Should you start to slide while driving on snowy or icy roads, turn the steering wheel in the direction of the slide until you regain control.

Avoid sudden applications of power and quick changes of direction on snow and ice. Apply the accelerator slowly and steadily when starting from a full stop.

Avoid sudden braking as well. Although an AWD vehicle may accelerate better than a two-wheel drive vehicle in snow and ice, it won't stop any faster, because as in other vehicles, braking occurs at all four wheels. Do not become overconfident as to road conditions.

Driving

Make sure you allow sufficient distance between you and other vehicles for stopping. Drive slower than usual and consider using one of the lower gears. In emergency stopping situations, apply the brake steadily. Since your vehicle is equipped with a four wheel anti-lock brake system (ABS), do not “pump” the brakes. Refer to the *Brakes* section of this chapter for additional information on the operation of the anti-lock brake system.

Maintenance and Modifications

The suspension and steering systems on your vehicle have been designed and tested to provide predictable performance whether loaded or empty and durable load carrying capability. For this reason, Ford Motor Company strongly recommends that you do not make modifications such as adding or removing parts (such as lift kits or stabilizer bars) or by using replacement parts not equivalent to the original factory equipment.

Any modifications to a vehicle that raise the center of gravity can make it more likely the vehicle will rollover as a result of a loss of control.

Ford Motor Company recommends that caution be used with any vehicle equipped with a high load or device (such as ladder or luggage racks).

Failure to maintain your vehicle properly may void the warranty, increase your repair cost, reduce vehicle performance and operational capabilities and adversely affect driver and passenger safety. Frequent inspection of vehicle chassis components is recommended if the vehicle is subjected to off-highway usage.

DRIVING THROUGH WATER

If driving through deep or standing water is unavoidable, proceed very slowly especially when the depth is not known. Never drive through water that is higher than the bottom of the wheel rims (for cars) or the bottom of the hubs (for trucks).

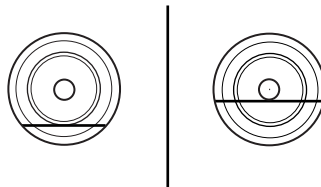

When driving through water, traction or brake capability may be limited. Also, water may enter your engine's air intake and severely damage your engine or your vehicle may stall. **Driving through deep water where the transmission vent tube is submerged may allow water into the transmission and cause internal transmission damage.**

Once through the water, always dry the brakes by moving your vehicle slowly while applying light pressure on the brake pedal.

Wet brakes do not stop the vehicle as quickly as dry brakes.

Roadside Emergencies

ROADSIDE ASSISTANCE

Getting roadside assistance

To fully assist you should you have a vehicle concern, Ford Motor Company offers a complimentary roadside assistance program. This program is separate from the New Vehicle Limited Warranty. The service is available:

- 24-hours, seven days a week
- for the period of five years or 60,000 miles (100,000 km), whichever occurs first on Ford and Mercury vehicles, and six years or 70,000 miles (110,000 km) on Lincoln vehicles.

Roadside assistance will cover:

- a flat tire change with a good spare (except Ford GT which has a tire inflation kit)
- battery jump start
- lock-out assistance (key replacement cost is the customer's responsibility)
- fuel delivery – Independent Service Contractors, if not prohibited by state, local or municipal law shall deliver up to 2.0 gallons (7.5L) of gasoline or 5 gallons (18.9L) of diesel fuel to a disabled vehicle. Fuel delivery service is limited to two no-charge occurrences within a 12-month period.
- winch out – available within 100 feet (30.5 meters) of a paved or county maintained road, no recoveries.
- towing – Ford/Mercury/Lincoln eligible vehicle towed to an authorized dealer within 35 miles (56.3 km) of the disablement location or to the nearest authorized dealer. If a member requests to be towed to an authorized dealer more than 35 miles (56.3 km) from the disablement location, the member shall be responsible for any mileage costs in excess of 35 miles (56.3 km).

Trailers shall be covered up to \$100 if the disabled eligible vehicle requires service at the nearest authorized dealer. If the trailer is disabled, but the towing vehicle is operational, the trailer does not qualify for any roadside services.

Canadian customers refer to your Customer Information Guide for information on:

- coverage period
- exact fuel amounts

Roadside Emergencies

- towing of your disabled vehicle
- emergency travel expense reimbursement
- travel planning benefits

Using roadside assistance

Complete the roadside assistance identification card and place it in your wallet for quick reference. In the United States, this card is found in the Owner Guide portfolio in the glove compartment. In Canada, the card is found in the *Customer Information Guide* in the glove compartment.

U.S. Ford or Mercury vehicle customers who require roadside assistance, call 1-800-241-3673; Lincoln vehicle customers call 1-800-521-4140.

Canadian customers who require roadside assistance, call 1-800-665-2006.

If you need to arrange roadside assistance for yourself, Ford Motor Company will reimburse a reasonable amount. To obtain reimbursement information, U.S. Ford or Mercury vehicles customers call 1-800-241-3673; Lincoln vehicle customers call 1-800-521-4140.

Canadian customers who need to obtain reimbursement information, call 1-800-665-2006.

Roadside coverage beyond basic warranty

In the United States, you may purchase additional roadside assistance coverage beyond this period through the Ford Auto Club by contacting your authorized dealer.

Similarly in Canada, for uninterrupted Roadside Assistance coverage, you may purchase extended coverage prior to your Basic Warranty's Roadside Assistance expiring. For more information and enrollment, contact 1-877-294-2582 or visit our website at www.ford.ca.

HAZARD FLASHER CONTROL

The hazard flasher is located on the instrument panel by the radio. The hazard flashers will operate when the ignition is in any position or if the key is not in the ignition.



Push in the flasher control and all front and rear direction signals will flash. Press the flasher control again to turn them off. Use it when your vehicle is disabled and is creating a safety hazard for other motorists.

Roadside Emergencies

Note: With extended use, the flasher may run down your battery.

FUEL PUMP SHUT-OFF SWITCH

This device stops the electric fuel pump from sending fuel to the engine when your vehicle has had a substantial jolt.

After an accident, if the engine cranks but does not start, this switch may have been activated.

This switch is located behind a panel on the left side of the cargo area.

To reset the switch:

1. Turn the ignition OFF.
2. Check the fuel system for leaks.
3. If no leaks are apparent, reset the switch by pushing in on the reset button.
4. Turn the ignition ON.
5. Wait a few seconds and return the key to OFF.
6. Make another check for leaks.

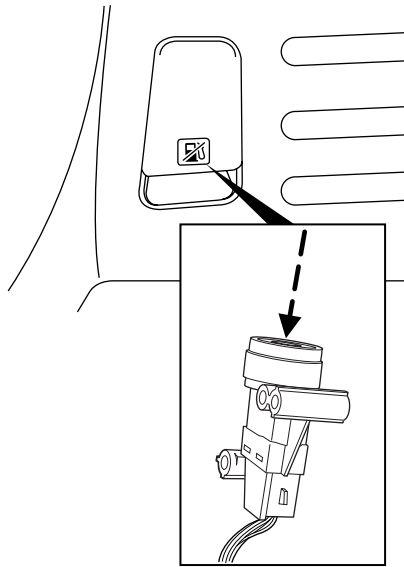

FUSES AND RELAYS

Fuses

If electrical components in the vehicle are not working, a fuse may have blown. Blown fuses are identified by a broken wire within the fuse. Check the appropriate fuses before replacing any electrical components.

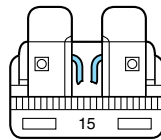

Note: Always replace a fuse with one that has the specified amperage rating. Using a fuse with a higher amperage rating can cause severe wire damage and could start a fire.

Roadside Emergencies

Standard fuse amperage rating and color

COLOR					
Fuse rating	Mini fuses	Standard fuses	Maxi fuses	Cartridge maxi fuses	Fuse link cartridge
2A	Grey	Grey	—	—	—
3A	Violet	Violet	—	—	—
4A	Pink	Pink	—	—	—
5A	Tan	Tan	—	—	—
7.5A	Brown	Brown	—	—	—
10A	Red	Red	—	—	—
15A	Blue	Blue	—	—	—
20A	Yellow	Yellow	Yellow	Blue	Blue
25A	Natural	Natural	—	—	—
30A	Green	Green	Green	Pink	Pink
40A	—	—	Orange	Green	Green
50A	—	—	Red	Red	Red
60A	—	—	Blue	Yellow	Yellow
70A	—	—	Tan	—	Brown
80A	—	—	Natural	Black	Black

Passenger compartment fuse panel

The fuse panel is located behind a trim panel on the left side of the driver's footwell near the parking brake. To remove the trim panel, slide the release lever to the right then pull the trim panel out.

To remove the fuse panel cover, press in the tabs on both sides of the cover, then pull the cover off.

To reinstall the fuse panel cover, place the top part of the cover on the fuse panel, then push the bottom part of the cover until it clicks into place. Gently pull on the cover to make sure it is secure.

To reinstall the trim panel, align the tabs on the bottom of the panel with the grooves, push the panel shut and slide the release lever to the left to secure the panel.

To remove a fuse, use the fuse puller tool provided on the fuse panel cover.

238

Roadside Emergencies

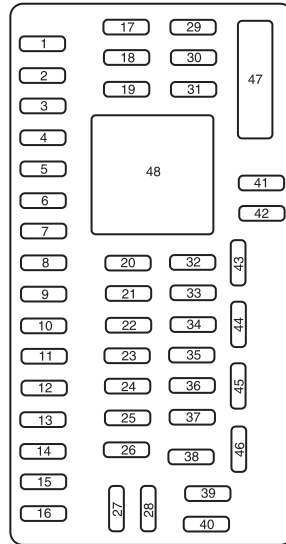

The fuses are coded as follows.

Fuse/Relay Location	Fuse Amp Rating	Passenger Compartment Fuse Panel Description
1	30A	Driver front smart window
2	15A	Not used (Spare)
3	15A	Family entertainment system (FES)/Rear seat control
4	30A	Passenger front smart window
5	10A	Keypad illumination, 2nd row seat, Tire Pressure Monitoring System (TPMS), Brake Shift Interlock (BSI)
6	20A	Turn signals
7	10A	Low beam headlamps (left)
8	10A	Low beam headlamps (right)
9	15A	Interior lights, Cargo lamps

Roadside Emergencies

Fuse/Relay Location	Fuse Amp Rating	Passenger Compartment Fuse Panel Description
10	15A	Backlighting, Puddle lamps
11	10A	All wheel drive
12	7.5A	Power mirror switch, Driver side power seat memory, Driver seat module – Keep alive power (KA)
13	7.5A	Not used
14	10A	Power liftgate module
15	10A	Climate control
16	15A	Not used (Spare)
17	20A	All power lock motor feeds, Liftgate release, Moon roof
18	20A	THX system
19	25A	Rear wiper
20	15A	Datalink
21	15A	Fog lamps
22	15A	Park lamps
23	15A	High beam headlamps
24	20A	Horn relay
25	10A	Demand lamps/Interior lamps
26	10A	Instrument panel cluster
27	20A	Ignition switch
28	5A	Radio
29	5A	Instrument panel cluster
30	5A	Overdrive cancel switch
31	10A	Compass, Automatic dimming rear view mirror
32	10A	Not used (Spare)
33	10A	Not used (Spare)
34	5A	Steering angle sensor
35	10A	Rear park assist, AWD, Heated seat module
36	5A	PATS transceiver

Roadside Emergencies

Fuse/Relay Location	Fuse Amp Rating	Passenger Compartment Fuse Panel Description
37	10A	Climate control
38	20A	THX System
39	20A	Radio
40	20A	Not used (Spare)
41	15A	Delayed accessory function for radio and lock switch illumination
42	10A	Not used (Spare)
43	10A	Rear wiper logic
44	10A	Customer accessory feed
45	5A	Front wiper logic, Climate control relay feed
46	7.5A	Occupant Classification Sensor (OCS), Passenger Airbag Deactivation Indicator (PADI)
47	30A Circuit Breaker	Power windows
48	—	Delayed accessory relay

Power distribution box

The power distribution box is located in the engine compartment. The power distribution box contains high-current fuses that protect your vehicle's main electrical systems from overloads.



Always disconnect the battery before servicing high current fuses.



To reduce risk of electrical shock, always replace the cover to the Power Distribution Box before reconnecting the battery or refilling fluid reservoirs.

If the battery has been disconnected and reconnected, refer to the *Battery* section of the *Maintenance and Specifications* chapter.

Roadside Emergencies

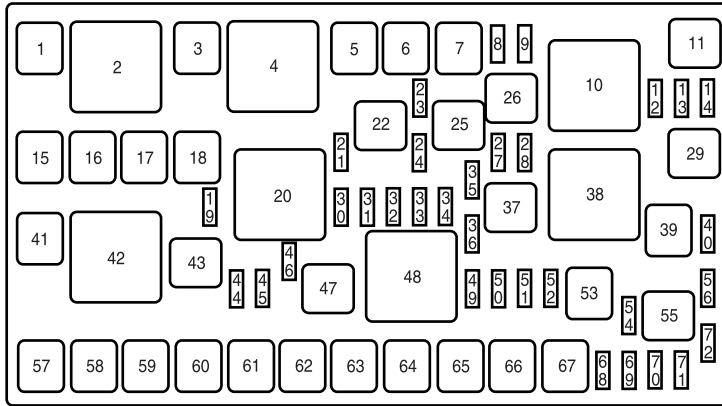

The high-current fuses are coded as follows:

Fuse/Relay Location	Fuse Amp Rating	Power Distribution Box Description
1	—	Not used
2	—	Blower motor relay
3	—	Not used
4	—	Not used
5	40A**	Cooling fan (vehicles with trailer tow)
	60A**	Cooling fan (vehicles without trailer tow)
6	40A**	Cooling fan (trailer tow only)
7	30A**	Rear heated seats
8	10A*	Alternator
9	20A*	Trailer tow parking lamps
10	—	Not used
11	—	Trailer tow parking lamp relay
12	—	Not used
13	—	Not used
14	—	Not used

Roadside Emergencies

Fuse/Relay Location	Fuse Amp Rating	Power Distribution Box Description
15	40A**	ABS pump motor
16	30A**	Front heated seats
17	20A**	Cigar lighter/Power point
18	30A**	Panorama moon roof
19	—	Fuel pump diode
20	—	PCM relay
21	7.5A*	PCM – Keep alive power (KA)
22	—	Trailer tow left stop/turn lamp relay
23	—	Not used
24	15A*	Trailer tow left stop/turn lamp
25	—	Rear seat release relay
26	—	Fuel pump relay
27	10A*	Rear seat release
28	15A*	Heated mirror
29	—	Heated mirror relay
30	15A*	VPWR 1 – PCM
31	10A*	VPWR 3 – PCM
32	10A*	VPWR 2 – PCM
33	15A*	VPWR 4 – PCM
34	—	Not used
35	10A*	A/C clutch
36	—	Not used
37	—	A/C clutch relay
38	—	Rear window defroster relay
39	40A**	Rear window defroster
40	—	Not used
41	30A**	Starter
42	—	Starter relay
43	—	Backup lamp relay
44	10A*	Backup lamps

Roadside Emergencies

Fuse/Relay Location	Fuse Amp Rating	Power Distribution Box Description
45	—	Not used
46	15A*	Trailer tow right stop/turn lamp
47	—	Trailer tow right stop/turn lamp relay
48	—	Run/Start relay
49	10A*	PCM ISPR
50	10A*	ABS Run/Start
51	5A*	Adaptive lighting
52	5A*	Fuel pump relay coil
53	30A**	SPDJB Run/Start
54	—	Not used
55	—	Not used
56	—	A/C clutch diode
57	40A**	ABS valves
58	30A**	Front wipers
59	30A**	Power liftgate
60	30A**	Driver power seat
61	30A**	Passenger power seat
62	—	Not used
63	40A**	Blower motor
64	20A**	Cigar lighter/Power point
65	20A**	Cigar lighter/Power point
66	20A**	Cigar lighter/Power point
67	—	Not used
68	15A*	Fuel pump
69	—	Not used
70	—	Not used
71	10A*	Stop lamps
72	—	Not used

* Mini Fuses ** Cartridge Fuses

Roadside Emergencies

CHANGING THE TIRES

If you get a flat tire while driving, do not apply the brake heavily. Instead, gradually decrease your speed. Hold the steering wheel firmly and slowly move to a safe place on the side of the road.

Note: The tire pressure monitoring system (TPMS) indicator light will illuminate when the spare tire is in use. To restore the full functionality of the monitoring system, all road wheels equipped with tire pressure monitoring sensors must be mounted on the vehicle.

Have a flat serviced by an authorized dealer in order to prevent damage to the TPMS sensors, refer to *Tire Pressure Monitoring System (TPMS)* in the *Tires, Wheels and Loading* chapter.



The use of tire sealants may damage your tires. The use of tire sealants may also damage your Tire Pressure Monitoring System and should not be used.



Refer to *Tire Pressure Monitoring System (TPMS)* in the *Tires, Wheels and Loading* chapter for important information. If the tire pressure monitor sensor becomes damaged, it will no longer function.

Dissimilar spare tire/wheel information



Failure to follow these guidelines could result in an increased risk of loss of vehicle control, injury or death.

If you have a dissimilar spare tire/wheel, then it is intended for temporary use only. This means that if you need to use it, you should replace it as soon as possible with a road tire/wheel that is the same size and type as the road tires and wheels that were originally provided by Ford. If the dissimilar spare tire or wheel is damaged, it should be replaced rather than repaired.

A dissimilar spare tire/wheel is defined as a spare tire and/or wheel that is different in brand, size or appearance from the road tires and wheels and can be one of three types:

1. **T-type mini-spares:** This spare tire begins with the letter “T” for tire size and may have “Temporary Use Only” molded in the sidewall
2. **Full-size dissimilar spare with label on wheel:** This spare tire has a label on the wheel that states: “THIS TIRE AND WHEEL FOR TEMPORARY USE ONLY”

Roadside Emergencies

When driving with one of the dissimilar spare tires listed above, **do not:**

- Exceed 50 mph (80 km/h)
- Load the vehicle beyond maximum vehicle load rating listed on the Safety Compliance Label
- Tow a trailer
- Use snow chains on the end of the vehicle with the dissimilar spare tire
- Use more than one dissimilar spare tire at a time
- Use commercial car washing equipment
- Try to repair the dissimilar spare tire

Use of one of the dissimilar spare tires listed above at any one wheel location can lead to impairment of the following:

- Handling, stability and braking performance
- Comfort and noise
- Ground clearance and parking at curbs
- Winter weather driving capability
- Wet weather driving capability

For vehicles equipped with 4WD, it is not recommended that the vehicle be operated in 4WD modes with a temporary emergency spare tire. If 4WD operation is necessary, do not operate above speeds of 10 mph (16 km/h) or for distances above 50 miles (80 km).

3. Full-size dissimilar spare without label on wheel

When driving with the full-size dissimilar spare tire/wheel, **do not:**

- Exceed 70 mph (113 km/h)
- Use more than one dissimilar spare tire/wheel at a time
- Use commercial car washing equipment
- Use snow chains on the end of the vehicle with the dissimilar spare tire/wheel

Roadside Emergencies

The usage of a full-size dissimilar spare tire/wheel can lead to impairment of the following:

- Handling, stability and braking performance
- Comfort and noise
- Ground clearance and parking at curbs
- Winter weather driving capability
- Wet weather driving capability
- All-Wheel driving capability (if applicable)
- Load leveling adjustment (if applicable)

When driving with the full-size dissimilar spare tire/wheel additional caution should be given to:

- Towing a trailer
- Driving vehicles equipped with a camper body
- Driving vehicles with a load on the cargo rack

Drive cautiously when using a full-size dissimilar spare tire/wheel and seek service as soon as possible.

Stopping and securing the vehicle

1. Park on a level surface, activate hazard flashers and set the parking brake.
2. Place the gearshift lever in P (Park) and turn the engine OFF.

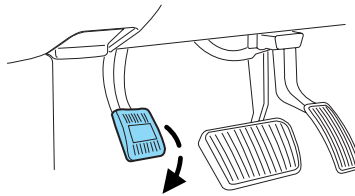

Roadside Emergencies

Removing the spare tire and jack

1. Lift the carpeted load floor panel located in the rear of the vehicle.
2. Remove the wing nut securing the spare tire by turning it counterclockwise.
3. Lift and remove the spare tire.
4. Remove the spacer and bag containing the jack assembly.
5. Remove the jack and wrench from the bag. Fold down the wrench socket to use to loosen the lug nuts and operate the jack.

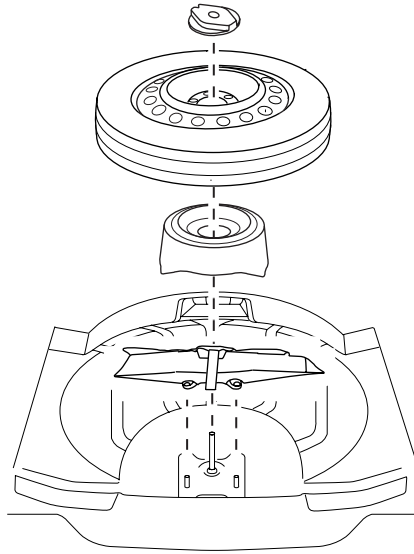

Tire change procedure



When one of the front wheels is off the ground, the transaxle alone will not prevent the vehicle from moving or slipping off the jack, even if the vehicle is in P (Park).



To help prevent the vehicle from moving when you change a tire, be sure to place the transaxle in P (Park), set the parking brake and block (in both directions) the wheel that is diagonally opposite (other side and end of the vehicle) to the tire being changed.



If the vehicle slips off the jack, you or someone else could be seriously injured.

Roadside Emergencies

 Do not attempt to change a tire on the side of the vehicle close to moving traffic. Pull far enough off the road to avoid the danger of being hit when operating the jack or changing the wheel.

1. Block the diagonally opposite wheel.

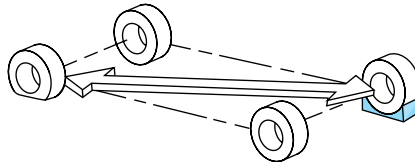

2. Remove wheel cover (if equipped) with the lug wrench tip and loosen each wheel lug nut one-half turn counterclockwise but do not remove them until the wheel is raised off the ground.

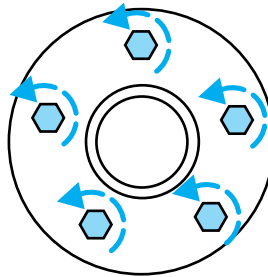

Roadside Emergencies

3. Align the slot on top of the jack with the sheet metal flange indicated by the jack locator triangle next to the tire you are changing. Turn the jack handle clockwise until the wheel is completely off the ground.



To lessen the risk of personal injury, do not put any part of your body under the vehicle while changing a tire. Do not start the engine when your vehicle is on the jack. The jack is only meant for changing the tire.

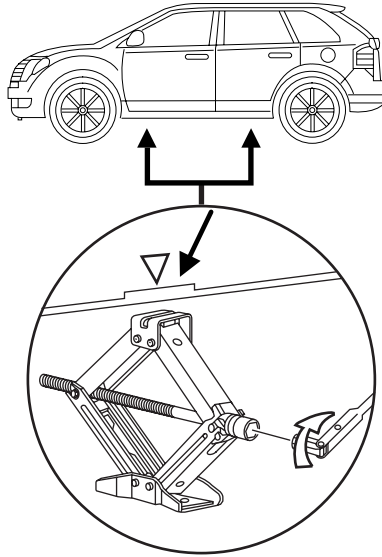

4. Remove the lug nuts with the lug

wrench.

5. Replace the flat tire with the spare tire, making sure the valve stem is facing outward. Reinstall the lug nuts until the wheel is snug against the hub. Do not fully tighten the lug nuts until the wheel has been lowered.

6. Lower the wheel by turning the jack handle counterclockwise.

7. Remove the jack and fully tighten the lug nuts in the order shown. Refer to *Wheel lug nut torque specifications* later in this chapter for the proper lug nut torque specification.

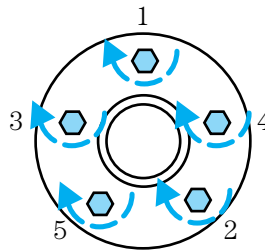

Stowing the flat/spare tire and jack

1. Fully collapse the jack, fold the wrench socket into the handle and place the both into the bag making sure to secure the tabs.

250

Roadside Emergencies

- Place the jack assembly in the spare tire well aligning it with the two vertical studs.
- Place the tire in the spare tire well over the jack assembly.

If you are stowing a flat tire, place the tire in the spare tire well with the valve stem facing down. Rotate the tire until the jack assembly is able to protrude through a wheel opening.

If you are stowing the spare tire, place the spacer and spare in the spare tire well in its original position.

- Secure the wheel by replacing the wing nut and turning clockwise.

WHEEL LUG NUT TORQUE SPECIFICATIONS

Retighten the lug nuts to the specified torque within 100 miles (160 km) after any wheel disturbance (rotation, flat tire, wheel removal, etc.).

Lug nut socket size/Bolt size	Wheel lug nut torque*	
	lb.ft.	N•m
Lug nut socket size: $\frac{3}{4}$ inch (19 mm) hex Bolt size: $\frac{1}{2}$ x 20	100	135

* Torque specifications are for nut and bolt threads free of dirt and rust. Use only Ford recommended replacement fasteners.



When a wheel is installed, always remove any corrosion, dirt or foreign materials present on the mounting surfaces of the wheel or the surface of the wheel hub, brake drum or brake disc that contacts the wheel. Ensure that any fasteners that attach the rotor to the hub are secured so they do not interfere with the mounting surfaces of the wheel. Installing wheels without correct metal-to-metal contact at the wheel mounting surfaces can cause the wheel nuts to loosen and the wheel to come off while the vehicle is in motion, resulting in loss of control.

Note: If there is corrosion on the area where the wheel contacts the hub, apply a thin film of grease or anti-seize compound on that area.

JUMP STARTING



The gases around the battery can explode if exposed to flames, sparks, or lit cigarettes. An explosion could result in injury or vehicle damage.

Roadside Emergencies



Batteries contain sulfuric acid which can burn skin, eyes and clothing, if contacted.

Do not attempt to push-start your automatic transmission vehicle. Automatic transmissions do not have push-start capability. Attempting to push-start a vehicle with an automatic transmission may cause transmission damage.

Preparing your vehicle

When the battery is disconnected or a new battery is installed, the automatic transmission must relearn its shift strategy. As a result, the transmission may have firm and/or soft shifts. This operation is considered normal and will not affect function or durability of the transmission. Over time, the adaptive learning process will fully update transmission operation.

1. **Use only a 12-volt supply to start your vehicle.**
2. Do not disconnect the battery of the disabled vehicle as this could damage the vehicle's electrical system.
3. Park the booster vehicle close to the hood of the disabled vehicle making sure the two vehicles **do not** touch. Set the parking brake on both vehicles and stay clear of the engine cooling fan and other moving parts.
4. Check all battery terminals and remove any excessive corrosion before you attach the battery cables. Ensure that vent caps are tight and level.
5. Turn the heater fan on in both vehicles to protect from any electrical surges. Turn all other accessories off.

Connecting the jumper cables

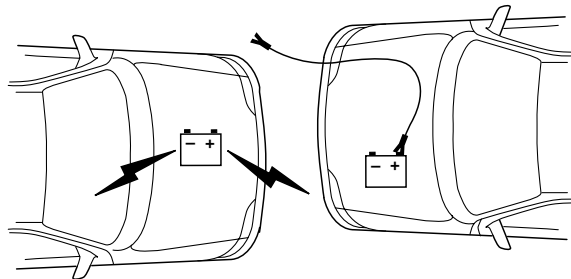

Roadside Emergencies

1. Connect the positive (+) jumper cable to the positive (+) terminal of the discharged battery.

Note: In the illustrations, *lightning bolts* are used to designate the assisting (boosting) battery.

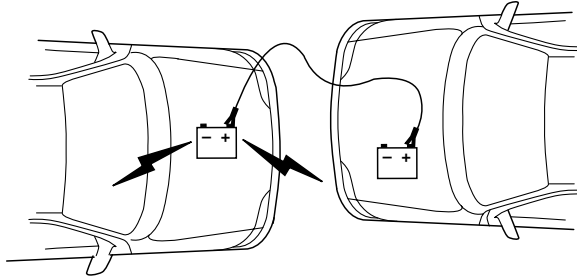

2. Connect the other end of the positive (+) cable to the positive (+) terminal of the assisting battery.

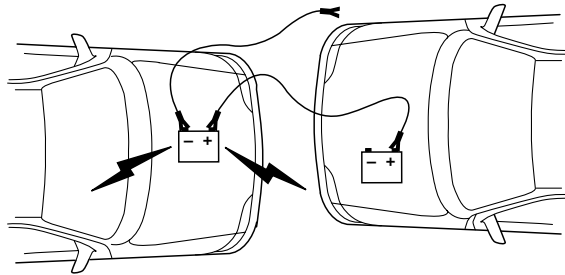

3. Connect the negative (-) cable to the negative (-) terminal of the assisting battery.

Roadside Emergencies

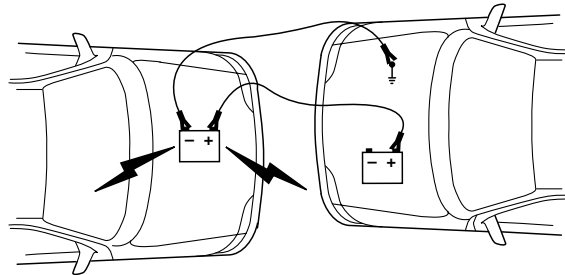

4. Make the final connection of the negative (-) cable to an exposed metal part of the stalled vehicle's engine, away from the battery and the carburetor/fuel injection system. **Do not** use fuel lines, engine rocker covers or the intake manifold as *grounding* points.



Do not connect the end of the second cable to the negative (-) terminal of the battery to be jumped. A spark may cause an explosion of the gases that surround the battery.

5. Ensure that the cables are clear of fan blades, belts, moving parts of both engines, or any fuel delivery system parts.

Jump starting

1. Start the engine of the booster vehicle and run the engine at moderately increased speed.
2. Start the engine of the disabled vehicle.
3. Once the disabled vehicle has been started, run both engines for an additional three minutes before disconnecting the jumper cables.

Roadside Emergencies

Removing the jumper cables

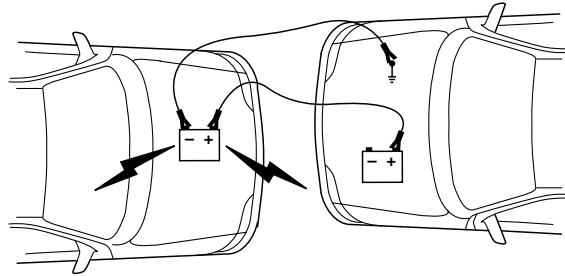

Remove the jumper cables in the reverse order that they were connected.

1. Remove the jumper cable from the *ground* metal surface.

Note: In the illustrations, *lightning bolts* are used to designate the assisting (boosting) battery.

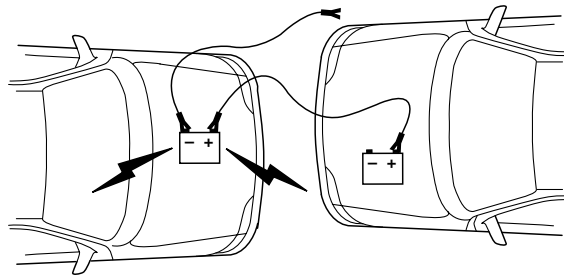

2. Remove the jumper cable on the negative (-) connection of the booster vehicle's battery.

Roadside Emergencies

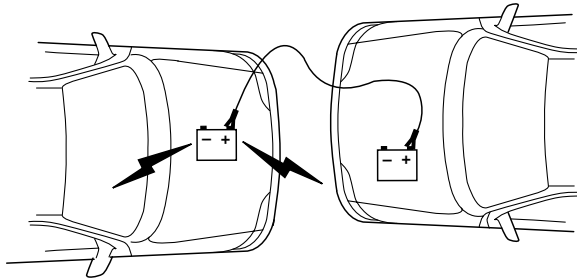

3. Remove the jumper cable from the positive (+) terminal of the booster vehicle's battery.

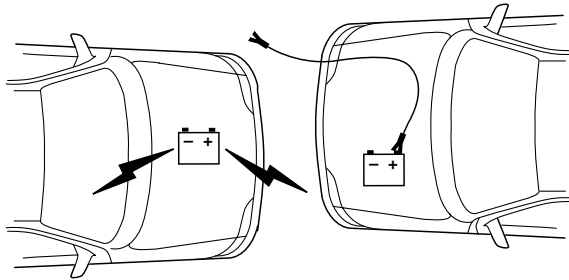

4. Remove the jumper cable from the positive (+) terminal of the disabled vehicle's battery.

After the disabled vehicle has been started and the jumper cables removed, allow it to idle for several minutes so the engine computer can *relearn* its idle conditions.

Roadside Emergencies

WRECKER TOWING

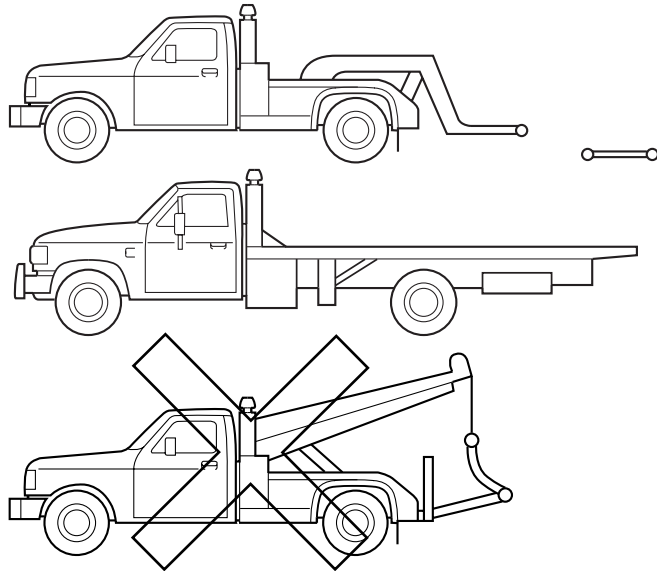

If you need to have your vehicle towed, contact a professional towing service or, if you are a member of a roadside assistance program, your roadside assistance service provider.

It is recommended that your vehicle be towed with a wheel lift and dollies or flatbed equipment. Do not tow with a slingbelt. Ford Motor Company has not approved a slingbelt towing procedure.

On FWD vehicles, if your vehicle is to be towed from the front, ensure proper wheel lift equipment is used to raise the front wheels off the ground. The rear wheels can be left on the ground when towed in this fashion.

If your vehicle is to be towed from the rear using wheel lift equipment, it is recommended that the front wheels (drive wheels) be placed on a dolly to prevent damage to the automatic transaxle.

On AWD vehicles, it is **required** that your vehicle be towed with a wheel lift and dollies or flatbed equipment with all the wheels off the ground to prevent damage to the automatic transaxle, AWD system or vehicle.

Roadside Emergencies

If the vehicle is towed by other means or incorrectly, vehicle damage may occur.

In case of a roadside emergency with a disabled vehicle (without access to wheel dollies, car hauling trailer, or flatbed transport vehicle) your vehicle (regardless of transmission powertrain configuration) can be flat towed (all wheels on the ground) under the following conditions:

- Place the transmission in N (Neutral).
- Maximum distance is 50 miles (80 km).
- Maximum speed is not to exceed 35 mph (56 km/h).

Ford Motor Company produces a towing manual for all authorized tow truck operators. Have your tow truck operator refer to this manual for proper hook-up and towing procedures for your vehicle.

Customer Assistance

GETTING THE SERVICES YOU NEED

At home

You must take your Lincoln or Mercury vehicle to an authorized dealer for warranty repairs. While any authorized dealer handling your vehicle line will provide warranty service, we recommend you return to your selling authorized dealer who wants to ensure your continued satisfaction. Please note that certain warranty repairs require special training and/or equipment, so not all authorized dealers are authorized to perform all warranty repairs. This means that, depending on the warranty repair needed, you may have to take your vehicle to another authorized dealer. A reasonable time must be allowed to perform a repair after taking your vehicle to the authorized dealer. Repairs will be made using Ford or Motorcraft parts, or remanufactured or other parts that are authorized by Ford.

If you have questions or concerns, or are unsatisfied with the service you are receiving, follow these steps:

1. Contact your Sales Representative or Service Advisor at your selling/servicing authorized dealer.
2. If your inquiry or concern remains unresolved, contact the Sales Manager, Service Manager or Customer Relations Manager.
3. If you require assistance or clarification on Ford Motor Company policies or procedures, please contact the Lincoln Mercury Customer Relationship Center at 1-800-521-4140.

Away from home

If you own a Ford or Mercury vehicle and are away from home when your vehicle needs service, or if you need more help than the authorized dealer could provide, after following the steps described above, contact the Ford Customer Relationship Center to find an authorized dealer to help you.

In the United States:

Ford Motor Company
Customer Relationship Center
P.O. Box 6248
Dearborn, MI 48121
1-800-392-3673 (FORD)
(TDD for the hearing impaired: 1-800-232-5952)
www.customersaskford.com

In Canada:

Customer Relationship Centre

Customer Assistance

Ford Motor Company of Canada, Limited
P.O. Box 2000
Oakville, Ontario L6J 5E4
1-800-565-3673 (FORD)
www.ford.ca

If you own a Lincoln vehicle and are away from home when your vehicle needs service, or if you need more help than the authorized dealer could provide, after following the steps described above, contact the Ford Customer Relationship Center to find an authorized dealer to help you.

In the United States:
Ford Motor Company
Customer Relationship Center
P.O. Box 6248
Dearborn, MI 48121
1-800-521-4140
(TDD for the hearing impaired: 1-800-232-5952)
www.customersaskford.com

In Canada:
Lincoln Centre
Ford Motor Company of Canada, Limited
P.O. Box 2000
Oakville, Ontario L6J 5E4
1-800-387-9333
www.lincolncanada.com

In order to help you service your Lincoln vehicle, please have the following information available when contacting the Lincoln Centre:

- Your telephone number (home and business)
- The name of the authorized dealer and the city where the authorized dealer is located
- The year and make of your vehicle
- The date of vehicle purchase
- The current odometer reading
- The vehicle identification number (VIN)

Additional Assistance

If you still have a complaint involving a warranty dispute, you may wish to contact the Better Business Bureau (BBB) AUTO LINE program (U.S. only).

In some states (in the U.S.) you must directly notify Ford in writing before pursuing remedies under your state's warranty laws. Ford is also allowed a final repair attempt in some states.

260

Customer Assistance

In the United States, a warranty dispute must be submitted to the BBB AUTO LINE before taking action under the Magnuson-Moss Warranty Act, or to the extent allowed by state law, before pursuing replacement or repurchase remedies provided by certain state laws. This dispute handling procedure is not required prior to enforcing state created rights or other rights which are independent of the Magnuson-Moss Warranty Act or state replacement or repurchase laws.

IN CALIFORNIA (U.S. ONLY)

California Civil Code Section 1793.2(d) requires that, if a manufacturer or its representative is unable to repair a motor vehicle to conform to the vehicle's applicable express warranty after a reasonable number of attempts, the manufacturer shall be required to either replace the vehicle with one substantially identical or repurchase the vehicle and reimburse the buyer in an amount equal to the actual price paid or payable by the consumer (less a reasonable allowance for consumer use). The consumer has the right to choose whether to receive a refund or replacement vehicle.

California Civil Code Section 1793.22(b) presumes that the manufacturer has had a reasonable number of attempts to conform the vehicle to its applicable express warranties if, within the first 18 months of ownership of a new vehicle or the first 18,000 miles (29,000 km), whichever occurs first:

1. Two or more repair attempts are made on the same non-conformity likely to cause death or serious bodily injury OR
2. Four or more repair attempts are made on the same nonconformity (a defect or condition that substantially impairs the use, value or safety of the vehicle) OR
3. The vehicle is out of service for repair of nonconformities for a total of more than 30 calendar days (not necessarily all at one time)

In the case of 1 or 2 above, the consumer must also notify the manufacturer of the need for the repair of the nonconformity at the following address:

Ford Motor Company
16800 Executive Plaza Drive
Mail Drop 3NE-B
Dearborn, MI 48126

THE BETTER BUSINESS BUREAU (BBB) AUTO LINE PROGRAM (U.S. ONLY)

Your satisfaction is important to Ford Motor Company and to your dealer. Experience has shown that our customers have been very successful in

Customer Assistance

achieving satisfaction by following the three-step procedure outlined on the front page of the Warranty Guide. However, if your warranty concern has not been resolved using the three-step procedure, you may be eligible to participate in the BBB AUTO LINE program.

The BBB AUTO LINE program consists of two parts – mediation and arbitration. Initially, the BBB will try to resolve your question or concern through mediation. Mediation is a process through which a representative of the BBB will contact the parties and explore options for settlement of your claim. If mediation is not successful, customers with eligible claims may participate in the BBB AUTO LINE arbitration process. An arbitration hearing will be scheduled so that you can present your case in an informal setting before an impartial person. The arbitrator will consider the testimony provided and make a decision after the hearing. You are not bound by the decision but may choose to accept it. If you choose to accept the BBB AUTO LINE decision then Ford must abide by the accepted decision as well. If the arbitrator has decided in your favor and you accept the decision, the BBB AUTO LINE program will contact you to ensure that Ford has complied with the decision in a timely manner. Disputes submitted to the BBB AUTO LINE program are usually decided within forty days after you file your claim with the BBB.

To initiate a claim with the BBB AUTO LINE, you will be asked for your name and address, general information about your new vehicle, information about your warranty concerns and any steps you have already taken to try to resolve them. You will then be mailed a Customer Claim Form that you will need to complete, provide proof of vehicle ownership, sign and return the Customer Claim Form to the BBB. Upon receipt, the BBB will review the claim for eligibility under the Program Summary Guidelines.

You can get more information by calling BBB AUTO LINE at 1-800-955-5100, or writing to:

**BBB AUTO LINE
4200 Wilson Boulevard, Suite 800
Arlington, Virginia 22203-1833**

Note: Ford Motor Company reserves the right to change eligibility limitations, modify procedures, or to discontinue this process at any time without notice and without obligation.

UTILIZING THE MEDIATION/ARBITRATION PROGRAM (CANADA ONLY)

For vehicles delivered to authorized Canadian dealers. In those cases where you continue to feel that the efforts by Ford of Canada and the

Customer Assistance

authorized dealer to resolve a factory-related vehicle service concern have been unsatisfactory, Ford of Canada participates in an impartial third party mediation/arbitration program administered by the Canadian Motor Vehicle Arbitration Plan (CAMVAP).

The CAMVAP program is a straight-forward and relatively speedy alternative to resolve a disagreement when all other efforts to produce a settlement have failed. This procedure is without cost to you and is designed to eliminate the need for lengthy and expensive legal proceedings.

In the CAMVAP program, impartial third-party arbitrators conduct hearings at mutually convenient times and places in an informal environment. These impartial arbitrators review the positions of the parties, make decisions and, when appropriate, render awards to resolve disputes. CAMVAP decisions are fast, fair, and final as the arbitrator's award is binding both to you and Ford of Canada.

CAMVAP services are available in all territories and provinces. For more information, without charge or obligation, call your CAMVAP Provincial Administrator directly at 1-800-207-0685.

FORD EXTENDED SERVICE PLAN

You can get more protection for your new car or light truck by purchasing Ford Extended Service Plan (Ford ESP) coverage. It provides the following:

- Benefits during the warranty period depending on the plan you purchase (such as: reimbursement for rentals; coverage for certain maintenance and wear items).
- Protection against covered repair costs after your Bumper-to-Bumper Warranty expires.

You may purchase Ford ESP from any participating authorized dealer. There are several plans available in various time, distance and deductible combinations which can be tailored to fit your own driving needs. Ford ESP also offers reimbursement benefits for towing and rental coverage.

When you buy Ford ESP, you receive Peace-of-Mind protection throughout the United States and Canada, provided by a network of more than 4,600 participating authorized dealers.

If you did not take advantage of the Ford Extended Service Plan at the time of purchasing your vehicle, you may still be eligible. Since this information is subject to change, please ask your authorized dealer for complete details about Ford Extended Service Plan coverage options, or visit the Ford ESP website at www.ford-esp.com.

Customer Assistance

GETTING ASSISTANCE OUTSIDE THE U.S. AND CANADA

Before exporting your vehicle to a foreign country, contact the appropriate foreign embassy or consulate. These officials can inform you of local vehicle registration regulations and where to find unleaded fuel.

If you cannot find unleaded fuel or can only get fuel with an anti-knock index lower than is recommended for your vehicle, contact a regional office or owner relations/customer relationship office.

The use of leaded fuel in your vehicle without proper conversion may damage the effectiveness of your emission control system and may cause engine knocking or serious engine damage. Ford Motor Company/Ford of Canada is not responsible for any damage caused by use of improper fuel. Using leaded fuel may also result in difficulty importing your vehicle back into the U.S.

If your vehicle must be serviced while you are traveling or living in Central America, the Caribbean, or the Middle East, contact the nearest authorized dealer. If the authorized dealer cannot help you, write or call:

FORD MOTOR COMPANY
FORD EXPORT OPERATIONS

1555 Fairlane Drive
Fairlane Business Park #3
Allen Park, Michigan 48101
U.S.A.

Telephone: (313) 594-4857
FAX: (313) 390-0804

If you are in another foreign country, contact the nearest authorized dealer. If the authorized dealer employees cannot help you, they can direct you to the nearest Ford affiliate office.

If you buy your vehicle in North America and then relocate outside of the U.S. or Canada, register your vehicle identification number (VIN) and new address with Ford Motor Company Export Operations.

Customers in the U.S. should call 1-800-392-3673.

ORDERING ADDITIONAL OWNER'S LITERATURE

To order the publications in this portfolio, contact Helm, Incorporated at:

HELM, INCORPORATED
P.O. Box 07150
Detroit, Michigan 48207

Or call:

For a free publication catalog, order toll free: 1-800-782-4356

264

2007 MKX (mkx)
Owners Guide (post-2002-fmt)
USA (fus)

Customer Assistance

Monday-Friday 8:00 a.m. - 6:00 p.m. EST

Helm, Incorporated can also be reached by their website:
www.helminc.com.

(Items in this catalog may be purchased by credit card, check or money order.)

Obtaining a French owner's guide

French Owner's Guides can be obtained from your authorized dealer or by writing to:

Ford Motor Company of Canada, Limited
Service Publications CHQ202
The Canadian Road
P.O. Box 2000
Oakville, ON, Canada
L6J 5E4

REPORTING SAFETY DEFECTS (U.S. ONLY)

If you believe that your vehicle has a defect which could cause a crash or could cause injury or death, you should immediately inform the National Highway Traffic Safety



Administration (NHTSA) in addition to notifying Ford Motor Company.

If NHTSA receives similar complaints, it may open an investigation, and if it finds that a safety defect exists in a group of vehicles, it may order a recall and remedy campaign. However, NHTSA cannot become involved in individual problems between you, your dealer, or Ford Motor Company.

To contact NHTSA, you may call the Vehicle Safety Hotline toll-free at 1-888-327-4236 (TTY: 1-800-424-9153); go to <http://www.safercar.gov>; or write to:

Administrator
NHTSA
400 Seventh Street, SW
Washington, D.C. 20590

You can also obtain other information about motor vehicle safety from <http://www.safercar.gov>.

REPORTING SAFETY DEFECTS (CANADA ONLY)

If you believe that your vehicle has a defect which could cause a crash or could cause injury or death, you should immediately inform Transport Canada, using their toll-free number: 1-800-333-0510.

Cleaning

WASHING THE EXTERIOR

Wash your vehicle regularly with cool or lukewarm water and a neutral pH shampoo, such as Motorcraft Detail Wash (ZC-3-A), which is available from your authorized dealer.

- Never use strong household detergents or soap, such as dish washing or laundry liquid. These products can discolor and spot painted surfaces.
- Never wash a vehicle that is “hot to the touch” or during exposure to strong, direct sunlight.
- Always use a clean sponge or car wash mitt with plenty of water for best results.
- Dry the vehicle with a chamois or soft terry cloth towel in order to eliminate water spotting.
- It is especially important to wash the vehicle regularly during the winter months, as dirt and road salt are difficult to remove and cause damage to the vehicle.
- Immediately remove items such as gasoline, diesel fuel, bird droppings and insect deposits because they can cause damage to the vehicle’s paintwork and trim over time. Use Bug and Tar Remover, ZC-42, which is available from your authorized dealer.
- Remove any exterior accessories, such as antennas, before entering a car wash.
- **Suntan lotions and insect repellents can damage any painted surface; if these substances come in contact with your vehicle, wash off as soon as possible.**

Exterior chrome

- Wash the vehicle first, using cool or lukewarm water and a neutral pH shampoo, such as Motorcraft Detail Wash (ZC-3-A).
- Use Custom Bright Metal Cleaner (ZC-15), available from your authorized dealer. Apply the product as you would a wax to clean bumpers and other chrome parts; allow the cleaner to dry for a few minutes, then wipe off the haze with a clean, dry rag.
- **Never use abrasive materials such as steel wool or plastic pads as they can scratch the chrome surface.**
- After polishing chrome bumpers, apply a coating of Motorcraft Premium Liquid Wax (ZC-53-A), available from your authorized dealer, or an equivalent quality product to help protect from environmental effects.

266

WAXING

Applying Motorcraft Paint Sealant (ZC-45) to your vehicle every six months will assist in reducing minor scratches and paint damage.

- Wash the vehicle first.
- Do not use waxes that contain abrasives; use Motorcraft Premium Liquid Wax (ZC-53-A), which is available from your authorized dealer, or an equivalent quality product.
- Do not allow paint sealant to come in contact with any non-body (low-gloss black) colored trim, such as grained door handles, roof racks, bumpers, side moldings, mirror housings or the windshield cowl area. The paint sealant will “gray” or stain the parts over time.

PAINT CHIPS

Your authorized dealer has touch-up paint to match your vehicle’s color. Take your color code (printed on a sticker in the driver’s door jamb) to your authorized dealer to ensure you get the correct color.

- Remove particles such as bird droppings, tree sap, insect deposits, tar spots, road salt and industrial fallout before repairing paint chips.
- Always read the instructions before using the products.

ALUMINUM WHEELS AND WHEEL COVERS

Aluminum wheels and wheel covers are coated with a clearcoat paint finish. In order to maintain their shine:

- Clean weekly with Motorcraft Wheel and Tire Cleaner (ZC-37-A), which is available from your authorized dealer. Heavy dirt and brake dust accumulation may require agitation with a sponge. Rinse thoroughly with a strong stream of water.
- Never apply any cleaning chemical to hot or warm wheel rims or covers.
- Some automatic car washes may cause damage to the finish on your wheel rims or covers. Chemical-strength cleaners, or cleaning chemicals, in combination with brush agitation to remove brake dust and dirt, could wear away the clearcoat finish over time.
- Do not use hydrofluoric acid-based or high caustic-based wheel cleaners, steel wool, fuels or strong household detergent.
- To remove tar and grease, use Motorcraft Bug and Tar Remover (ZC-42), available from your authorized dealer.

Cleaning

ENGINE

Engines are more efficient when they are clean because grease and dirt buildup keep the engine warmer than normal. When washing:

- Take care when using a power washer to clean the engine. The high-pressure fluid could penetrate the sealed parts and cause damage.
- Do not spray a hot engine with cold water to avoid cracking the engine block or other engine components.
- Spray Motorcraft Engine Shampoo and Degreaser (ZC-20) on all parts that require cleaning and pressure rinse clean.
- Cover the highlighted areas to prevent water damage when cleaning the engine.

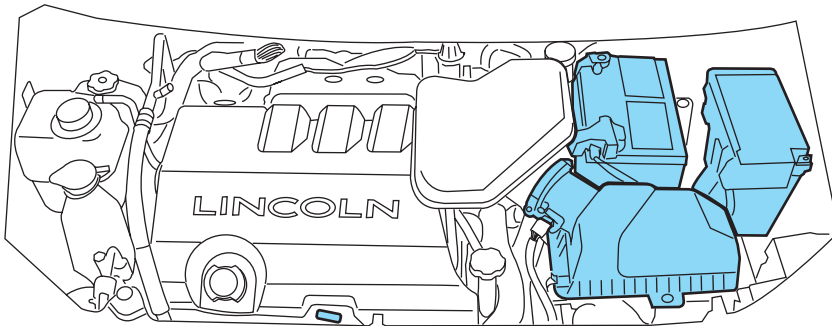

- **3.5L engine**
- Never wash or rinse the engine while it is running; water in the running engine may cause internal damage.

PLASTIC (NON-PAINTED) EXTERIOR PARTS

Use only approved products to clean plastic parts. These products are available from your authorized dealer.

- For routine cleaning, use Motorcraft Detail Wash (ZC-3-A).
- If tar or grease spots are present, use Motorcraft Bug and Tar Remover (ZC-42).
- For plastic headlamp lenses, use Motorcraft Ultra Clear Spray Glass Cleaner (ZC-23).

WINDOWS AND WIPER BLADES

The windshield, rear and side windows and the wiper blades should be cleaned regularly. If the wipers do not wipe properly, substances on the vehicle's glass or the wiper blades may be the cause. These may include hot wax treatments used by commercial car washes, water repellent coatings, tree sap, or other organic contamination; these contaminants may cause squeaking or chatter noise from the blades, and streaking and smearing of the windshield. To clean these items, follow these tips:

- The windshield, rear windows and side windows may be cleaned with a non-abrasive cleaner such as Motorcraft Ultra-Clear Spray Glass Cleaner (ZC-23), available from your authorized dealer.
- The wiper blades can be cleaned with isopropyl (rubbing) alcohol or Motorcraft Premium Windshield Washer Concentrate (ZC-32-A), available from your authorized dealer. This washer fluid contains special solution in addition to alcohol which helps to remove the hot wax deposited on the wiper blade and windshield from automated car wash facilities. Be sure to replace wiper blades when they appear worn or do not function properly.
- Do not use abrasives, as they may cause scratches.
- Do not use fuel, kerosene, or paint thinner to clean any parts.

If you cannot remove those streaks after cleaning with the glass cleaner or if the wipers chatter and move in a jerky motion, clean the outer surface of the windshield and the wiper blades using a sponge or soft cloth with a neutral detergent or mild-abrasive cleaning solution. After cleaning, rinse the windshield and wiper blades with clean water. The windshield is clean if beads do not form when you rinse the windshield with water.

Do not use sharp objects, such as a razor blade, to clean the inside of the rear window or to remove decals, as it may cause damage to the rear window defroster's heated grid lines.

PANORAMIC ROOF DEFLECTOR (IF EQUIPPED)

Vacuum the wind deflector cloth to remove insects & loose dirt. Clean with Motorcraft Professional Strength Carpet & Upholstery Cleaner (ZC-54).

Cleaning

INSTRUMENT PANEL/INTERIOR TRIM AND CLUSTER LENS

Clean the instrument panel, interior trim areas and cluster lens with a clean and damp white cotton cloth, then with a clean and dry white cotton cloth; you may also use Motorcraft Dash & Vinyl Cleaner (ZC-38-A) on the instrument panel and interior trim areas.

- Avoid cleaners or polishes that increase the gloss of the upper portion of the instrument panel. The dull finish in this area helps protect the driver from undesirable windshield reflection.
- Be certain to wash or wipe your hands clean if you have been in contact with certain products such as insect repellent and suntan lotion in order to avoid possible damage to the interior painted surfaces.
- Do not use household or glass cleaners as these may damage the finish of the instrument panel, interior trim and cluster lens.



Do not use chemical solvents or strong detergents when cleaning the steering wheel or instrument panel to avoid contamination of the airbag system.

If a staining liquid like coffee/juice has been spilled on the instrument panel or on interior trim surfaces, clean as follows:

1. Wipe up spilled liquid using a clean white cotton cloth.
2. Apply Motorcraft Deluxe Leather and Vinyl Cleaner (ZC-11-A) [In Canada use Motorcraft Multi-Purpose Cleaner (CXC-101)] to the wiped area and spread around evenly.
3. Apply more Motorcraft cleaner to a clean white cotton cloth and press the cloth onto the soiled area—allow this to set at room temperature for 30 minutes.
4. Remove the soaked cloth, and if it is not soiled badly, use this cloth to clean the area by using a rubbing motion for 60 seconds.
5. Following this, wipe area dry with a clean white cotton cloth.

INTERIOR

For fabric, carpets, cloth seats and safety belts:

- Remove dust and loose dirt with a vacuum cleaner.
- Remove light stains and soil with Motorcraft Professional Strength Carpet & Upholstery Cleaner (ZC-54).
- If grease or tar is present on the material, spot-clean the area first with Motorcraft Spot and Stain Remover (ZC-14).

Cleaning

- If a ring forms on the fabric after spot cleaning, clean the entire area immediately (but do not oversaturate) or the ring will set.
- Do not use household cleaning products or glass cleaners, which can stain and discolor the fabric and affect the flame retardant abilities of the seat materials.



Do not use cleaning solvents, bleach or dye on the vehicle's seatbelts, as these actions may weaken the belt webbing.

LEATHER SEATS

Your leather seating surfaces have a clear, protective coating over the leather.

- To clean, use a soft cloth with Motorcraft Deluxe Leather and Vinyl Cleaner (ZC-11-A). Dry the area with a soft cloth.
- To help maintain its resiliency and color, use the Motorcraft Deluxe Leather Care Kit (ZC-11-D), available from your authorized dealer.
- Do not use household cleaning products, alcohol solutions, solvents or cleaners intended for rubber, vinyl and plastics, or oil/petroleum-based leather conditioners. These products may cause premature wearing of the clear, protective coating.

Note: In some instances, color or dye transfer can occur when wet clothing comes in contact with leather upholstery. If this occurs, the leather should be cleaned immediately to avoid permanent staining.

CLEANING THE CLIMATE CONTROLLED SEATS (IF EQUIPPED)

Remove dust and loose dirt with a whisk broom or a vacuum cleaner. Remove fresh spots immediately. Clean the seat with a damp cloth, using a mild soap and water solution, if necessary.

UNDERBODY

Flush the complete underside of your vehicle frequently. Keep body and door drain holes free from packed dirt.

Cleaning

FORD AND LINCOLN MERCURY CAR CARE PRODUCTS

Your Ford or Lincoln Mercury authorized dealer has many quality products available to clean your vehicle and protect its finishes. These quality products have been specifically engineered to fulfill your automotive needs; they are custom designed to complement the style and appearance of your vehicle. Each product is made from high quality materials that meet or exceed rigid specifications. For best results, use the following products or products of equivalent quality:

- Motorcraft Bug and Tar Remover (ZC-42)
- Motorcraft Car Care Kit (ZC-26)
- Motorcraft Car Wash (Canada only) (CXC-21)
- Motorcraft Custom Bright Metal Cleaner (ZC-15)
- Motorcraft Custom Clear Coat Polish (ZC-8-A)
- Motorcraft Custom Vinyl Protectant (U.S. only) (ZC-40-A)
- Motorcraft Dash and Vinyl Cleaner (ZC-38-A)
- Motorcraft Deluxe Leather and Vinyl Cleaner (U.S. only) (ZC-11-A)
- Motorcraft Detail Wash (ZC-3-A)
- Motorcraft Dusting Cloth (ZC-24)
- Motorcraft Engine Shampoo and Degreaser (U.S. only) (ZC-20)
- Motorcraft Engine Shampoo (Canada only) (CXC-66-A)
- Motorcraft One Step Wash and Wax Concentrate (ZC-6-A)
- Motorcraft Paint Sealant (ZC-45)
- Motorcraft Premium Car Wash Concentrate (U.S. only) (ZC-17-B)
- Motorcraft Premium Glass Cleaner (Canada only) (CXC-100)
- Motorcraft Premium Liquid Wax (ZC-53-A)
- Motorcraft Premium Windshield Washer Concentrate (ZC-32-A)
- Motorcraft Professional Strength Carpet & Upholstery Cleaner (ZC-54)
- Motorcraft Spot and Stain Remover (U.S. only) (ZC-14)
- Motorcraft Tire Clean and Shine (ZC-28)
- Motorcraft Triple Clean (U.S. only) (ZC-13)
- Motorcraft Ultra-Clear Spray Glass Cleaner (ZC-23)
- Motorcraft Vinyl Cleaner (Canada only) (CXC-93)
- Motorcraft Wheel and Tire Cleaner (ZC-37-A)

272

Maintenance and Specifications

SERVICE RECOMMENDATIONS

To help you service your vehicle, we provide *scheduled maintenance information* which makes tracking routine service easy.

If your vehicle requires professional service, your authorized dealer can provide the necessary parts and service. Check your *Warranty Guide* to find out which parts and services are covered.

Use only recommended fuels, lubricants, fluids and service parts conforming to specifications. Motorcraft parts are designed and built to provide the best performance in your vehicle.

PRECAUTIONS WHEN SERVICING YOUR VEHICLE

- Do not work on a hot engine.
- Make sure that nothing gets caught in moving parts.
- Do not work on a vehicle with the engine running in an enclosed space, unless you are sure you have enough ventilation.
- Keep all open flames and other lit material away from the battery and all fuel related parts.

Working with the engine off

1. Set the parking brake and ensure the gearshift is securely latched in P (Park).
2. Turn off the engine and remove the key.
3. Block the wheels to prevent the vehicle from moving unexpectedly.

Working with the engine on

1. Set the parking brake and shift to P (Park).
2. Block the wheels.



To reduce the risk of vehicle damage and/or personal burn injuries do not start your engine with the air cleaner removed and do not remove it while the engine is running.

Maintenance and Specifications

OPENING THE HOOD

1. Inside the vehicle, pull the hood release handle located under the bottom of the instrument panel near the steering column.

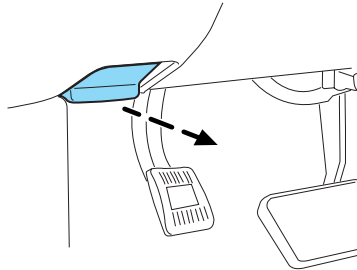

2. Go to the front of the vehicle and release the auxiliary latch that is located under the front center of the hood.

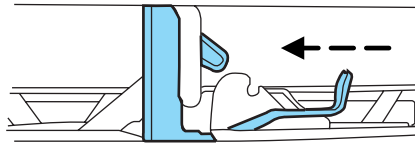

3. Lift the hood and support it with the prop rod.

Maintenance and Specifications

IDENTIFYING COMPONENTS IN THE ENGINE COMPARTMENT

3.5L V6 engine

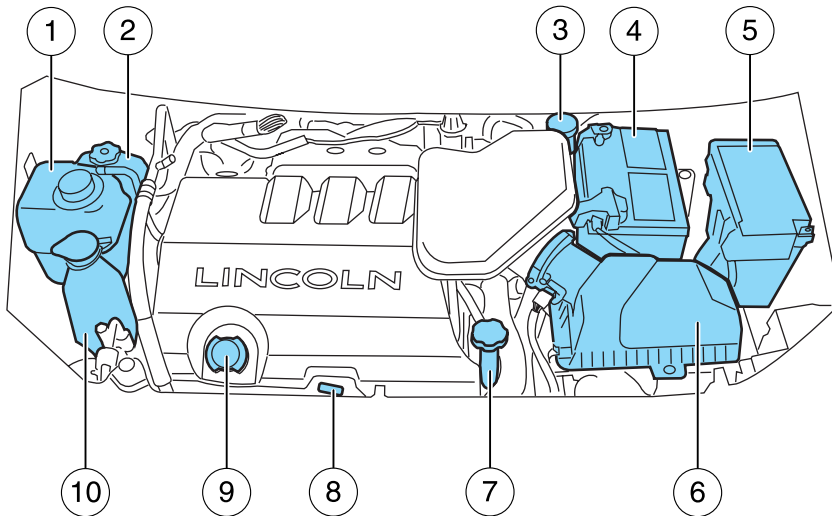

1. Engine coolant reservoir
2. Power steering fluid reservoir
3. Brake fluid reservoir
4. Battery
5. Power distribution box
6. Air filter assembly
7. Transmission fluid dipstick
8. Engine oil dipstick
9. Engine oil filler cap
10. Windshield washer fluid reservoir

Maintenance and Specifications

WINDSHIELD WASHER FLUID

Add fluid to fill the reservoir if the level is low. In very cold weather, do not fill the reservoir completely.

Only use a washer fluid that meets Ford specification WSB-M8B16-A2. Do not use any special washer fluid such as windshield water repellent type fluid or bug wash. They may cause squeaking, chatter noise, streaking and smearing. Refer to the *Maintenance product specifications and capacities* section in this chapter.

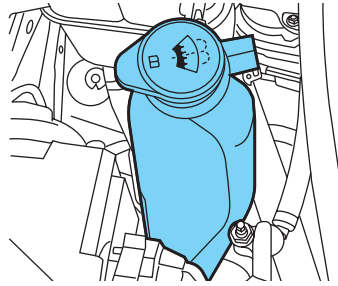

State or local regulations on volatile organic compounds may restrict the use of methanol, a common windshield washer antifreeze additive. Washer fluids containing non-methanol antifreeze agents should be used only if they provide cold weather protection without damaging the vehicle's paint finish, wiper blades or washer system.



If you operate your vehicle in temperatures below 40° F (4.5°C), use washer fluid with antifreeze protection. Failure to use washer fluid with antifreeze protection in cold weather could result in impaired windshield vision and increase the risk of injury or accident.

Note: Do not put washer fluid in the engine coolant reservoir. Washer fluid placed in the cooling system may harm engine and cooling system components.

CHANGING THE WIPER BLADES

1. Pull the wiper arm away from the vehicle. Turn the blade at an angle from the wiper arm. Push the lock pin manually to release the blade and pull the wiper blade down toward the windshield to remove it from the arm.

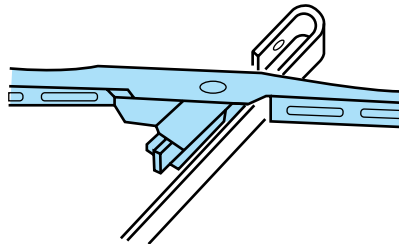

2. Attach the new wiper to the wiper arm and press it into place until a click is heard.

Replace wiper blades at least once per year for optimum performance.

Maintenance and Specifications

Poor wiper quality can be improved by cleaning the wiper blades and the windshield, refer to *Windows and wiper blades* in the *Cleaning* chapter.

To prolong the life of the wiper blades, it is highly recommended to scrape off the ice on the windshield before turning on the wipers. The layer of ice has many sharp edges and can damage the micro edge of the wiper rubber element.

Changing rear window wiper blade

The rear wiper arm is designed without a service position. This reduces the risk of damage to the blade in an automatic car wash.

To replace the wiper blade:

1. Grab the wiper arm just below the blade attachment and pull it as far away from the glass as possible. Do not use excessive force because it can break the wiper arm at the heel. Hold it there until the next step.
2. Grab the wiper blade with your other hand and use your fingers to push the wiper arm tip through the wiper blade center to separate the blade from the arm.
3. Attach the new wiper to the wiper arm and press it into place until a click is heard.

If you find this procedure too difficult, please see your dealer.

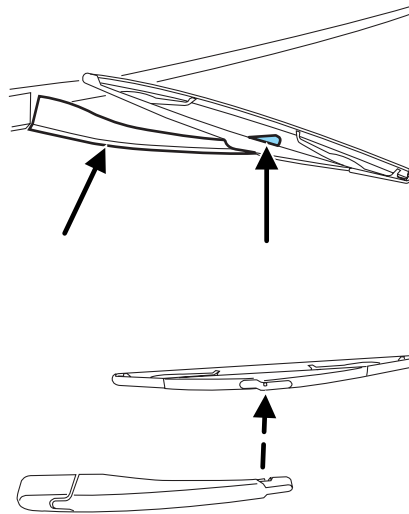

ENGINE OIL

Checking the engine oil

Refer to the *scheduled maintenance information* for the appropriate intervals for checking the engine oil.

1. Make sure the vehicle is on level ground.
2. Turn the engine off and wait a few minutes for the oil to drain into the oil pan.

Maintenance and Specifications

3. Set the parking brake and ensure the gearshift is securely latched in P (Park).
 4. Open the hood. Protect yourself from engine heat.
 5. Locate and carefully remove the engine oil level indicator (dipstick).
- 3.5L V6 engine

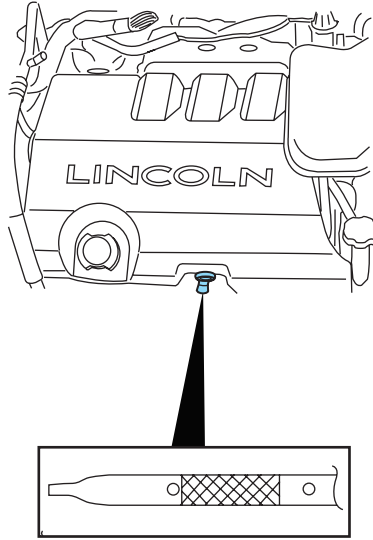

6. Wipe the indicator clean. Insert the indicator fully, then remove it again.

- If the oil level is **within this range**, the oil level is acceptable. **DO NOT ADD OIL.**

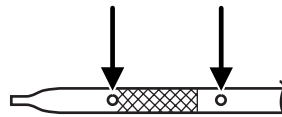

- If the oil level is **below this mark**, engine **oil must be added** to raise the level within the normal operating range.

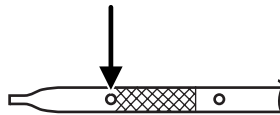

Maintenance and Specifications

- 3.5L V6 engine

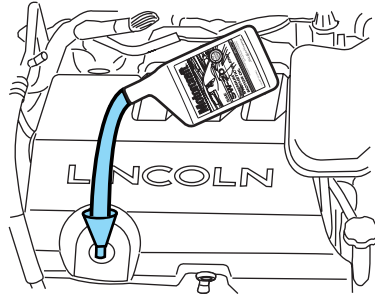

- If required, add engine oil to the engine. Refer to *Adding engine oil* in this chapter.
- **Do not overfill the engine with oil. Oil levels above this mark may cause engine damage.** If the engine is overfilled, some oil must be removed from the engine by an authorized dealer.

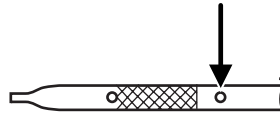

7. Put the indicator back in and ensure it is fully seated.

Adding engine oil

1. Check the engine oil. For instructions, refer to *Checking the engine oil* in this chapter.
2. If the engine oil level is not within the normal operating range, add only certified engine oil of the recommended viscosity. Remove the engine oil filler cap and use a funnel to pour the engine oil into the opening.
3. Recheck the engine oil level. Make sure the oil level is not above the normal operating range on the engine oil level indicator (dipstick).
4. Install the indicator and ensure it is fully seated.
5. Fully install the engine oil filler cap by turning the filler cap clockwise until it stops.

To avoid possible oil loss, DO NOT operate the vehicle with the engine oil level indicator and/or the engine oil filler cap removed.

Maintenance and Specifications

Engine oil and filter recommendations

Look for this certification trademark.

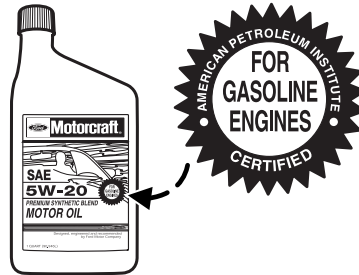

Use SAE 5W-20 engine oil

Only use oils “Certified For Gasoline Engines” by the American Petroleum Institute (API). An oil with this trademark symbol conforms to the current engine and emission system protection standards and fuel economy requirements of the International Lubricant Standardization and Approval Committee (ILSAC), comprised of U.S. and Japanese automobile manufacturers.

To protect your engine’s warranty use Motorcraft SAE 5W-20 or an equivalent SAE 5W-20 oil meeting Ford specification WSS-M2C930-A.

SAE 5W-20 oil provides optimum fuel economy and durability performance meeting all requirements for your vehicle’s engine.

Do not use supplemental engine oil additives, cleaners or other engine treatments. They are unnecessary and could lead to engine damage that is not covered by Ford warranty.

Change your engine oil and filter according to the appropriate schedule listed in *scheduled maintenance information*.

Ford production and aftermarket (Motorcraft) oil filters are designed for added engine protection and long life. If a replacement oil filter is used that does not meet Ford material and design specifications, start-up engine noises or knock may be experienced.

It is recommended you use the appropriate Motorcraft oil filter or another with equivalent performance for your engine application.

Maintenance and Specifications

BATTERY

Your vehicle is equipped with a Motorcraft maintenance-free battery which normally does not require additional water during its life of service.

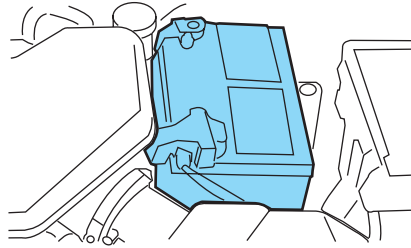

If your battery has a cover/shield, make sure it is reinstalled after the battery has been cleaned or replaced.

For longer, trouble-free operation, keep the top of the battery clean and dry. Also, make certain the battery cables are always tightly fastened to the battery terminals.

If you see any corrosion on the battery or terminals, remove the cables from the terminals and clean with a wire brush. You can neutralize the acid with a solution of baking soda and water.

It is recommended that the negative battery cable terminal be disconnected from the battery if you plan to store your vehicle for an extended period of time. This will minimize the discharge of your battery during storage.

Note: Electrical or electronic accessories or components added to the vehicle by the dealer or the owner may adversely affect battery performance and durability.

 Batteries normally produce explosive gases which can cause personal injury. Therefore, do not allow flames, sparks or lighted substances to come near the battery. When working near the battery, always shield your face and protect your eyes. Always provide proper ventilation.

 When lifting a plastic-cased battery, excessive pressure on the end walls could cause acid to flow through the vent caps, resulting in personal injury and/or damage to the vehicle or battery. Lift the battery with a battery carrier or with your hands on opposite corners.

Maintenance and Specifications



Keep batteries out of reach of children. Batteries contain sulfuric acid. Avoid contact with skin, eyes or clothing. Shield your eyes when working near the battery to protect against possible splashing of acid solution. In case of acid contact with skin or eyes, flush immediately with water for a minimum of 15 minutes and get prompt medical attention. If acid is swallowed, call a physician immediately.



Battery posts, terminals and related accessories contain lead and lead compounds. **Wash hands after handling.**

Because your vehicle's engine is electronically controlled by a computer, some control conditions are maintained by power from the battery. When the battery is disconnected or a new battery is installed, the engine must relearn its idle and fuel trim strategy for optimum driveability and performance. To begin this process:

1. With the vehicle at a complete stop, set the parking brake.
2. Put the gearshift in P (Park), turn off all accessories and start the engine.
3. Run the engine until it reaches normal operating temperature.
4. Allow the engine to idle for at least one minute.
5. Turn the A/C on and allow the engine to idle for at least one minute.
6. Release the parking brake. With your foot on the brake pedal and with the A/C on, put the vehicle in D (Drive) and allow the engine to idle for at least one minute.
7. Drive the vehicle to complete the relearning process.
 - The vehicle may need to be driven 10 miles (16 km) or more to relearn the idle and fuel trim strategy.
 - **If you do not allow the engine to relearn its idle trim, the idle quality of your vehicle may be adversely affected until the idle trim is eventually relearned.**

If the battery has been disconnected or a new battery has been installed, the clock and radio settings must be reset once the battery is reconnected.

Maintenance and Specifications

- Always dispose of automotive batteries in a responsible manner. Follow your local authorized standards for disposal. Call your local authorized recycling center to find out more about recycling automotive batteries.

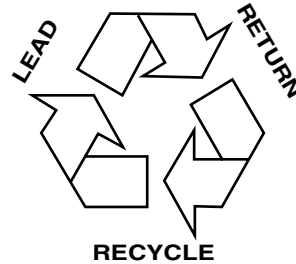

ENGINE COOLANT

Checking engine coolant

The concentration and level of engine coolant should be checked at the intervals listed in *scheduled maintenance information*. The coolant concentration should be maintained at 50/50 coolant and distilled water, which equates to a freeze point of -34°F (-36°C). Coolant concentration testing is possible with a hydrometer or antifreeze tester (such as the Rotunda Battery and Antifreeze Tester, 014-R1060). The level of coolant should be maintained at the "FULL COLD" level or within the "COLD FILL RANGE" in the coolant reservoir. If the level falls below, add coolant per the instructions in the *Adding engine coolant* section.

Your vehicle was factory-filled with a 50/50 engine coolant and water concentration. If the concentration of coolant falls below 40% or above 60%, the engine parts could become damaged or not work properly. **A 50-50 mixture of coolant and water provides the following:**

- **Freeze protection down to -34°F (-36°C).**
- **Boiling protection up to 265°F (129°C).**
- **Protection against rust and other forms of corrosion.**
- **Enables calibrated gauges to work properly.**

When the engine is cold, check the level of the engine coolant in the reservoir.

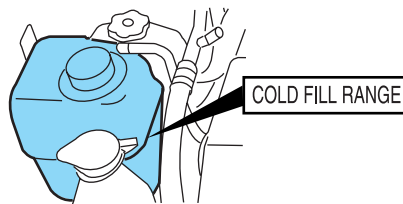

- The engine coolant should be at the "FULL COLD" level or within the "COLD FILL RANGE" as listed on the engine coolant reservoir (depending upon application).

Maintenance and Specifications

- Refer to *scheduled maintenance information* for service interval schedules.
- Be sure to read and understand *Precautions when servicing your vehicle* in this chapter.

If the engine coolant has not been checked at the recommended interval, the engine coolant reservoir may become low or empty. If the reservoir is low or empty, add engine coolant to the reservoir. Refer to *Adding engine coolant* in this chapter.

Note: Automotive fluids are not interchangeable; do not use engine coolant, antifreeze or windshield washer fluid outside of its specified function and vehicle location.

Adding engine coolant

When adding coolant, make sure it is a 50/50 mixture of engine coolant and distilled water. Add the mixture to the coolant reservoir, **when the engine is cool**, until the appropriate fill level is obtained.



Do not add engine coolant when the engine is hot. Steam and scalding liquids released from a hot cooling system can burn you badly. Also, you can be burned if you spill coolant on hot engine parts.



Do not put engine coolant in the windshield washer fluid container. If sprayed on the windshield, engine coolant could make it difficult to see through the windshield.

- **Add Motorcraft Premium Gold Engine Coolant or equivalent meeting Ford specification WSS-M97B51-A1.** Refer to *Maintenance product specifications and capacities* in this chapter.

Note: Do not use stop leak pellets or cooling system sealants/additives as they can cause damage to the engine cooling and/or heating systems. This damage would not be covered under your vehicle's warranty.

- **Do not add/mix an orange-colored, extended life coolant such as Motorcraft Specialty Orange Engine Coolant, meeting Ford specification WSS-M97B44-D, or DEX-COOL® brand with the factory-filled coolant.** Mixing Motorcraft Specialty Orange Engine Coolant or any orange-colored extended life product such as DEX-COOL® brand with your factory filled coolant can result in degraded corrosion protection.

Maintenance and Specifications

- A large amount of water without engine coolant may be added, in case of emergency, to reach a vehicle service location. In this instance, the cooling system must be drained and refilled with a 50/50 mixture of engine coolant and distilled water as soon as possible. Water alone (without engine coolant) can cause engine damage from corrosion, overheating or freezing.
- **Do not use alcohol, methanol, brine or any engine coolants mixed with alcohol or methanol antifreeze (coolant).** Alcohol and other liquids can cause engine damage from overheating or freezing.
- **Do not add extra inhibitors or additives to the coolant.** These can be harmful and compromise the corrosion protection of the engine coolant.

For vehicles with overflow coolant systems with a non-pressurized cap on the coolant recovery system, add coolant to the coolant recovery reservoir when the engine is cool. Add the proper mixture of coolant and water to the “FULL COLD” level. For all other vehicles which have a coolant degas system with a pressurized cap, or if it is necessary to remove the coolant pressure relief cap on the radiator of a vehicle with an overflow system, follow these steps to add engine coolant.



To reduce the risk of personal injury, make sure the engine is cool before unscrewing the coolant pressure relief cap. The cooling system is under pressure; steam and hot liquid can come out forcefully when the cap is loosened slightly.

Add the proper mixture of coolant and water to the cooling system by following these steps:

1. Before you begin, turn the engine off and let it cool.
2. When the engine is cool, wrap a thick cloth around the coolant pressure relief cap on the coolant reservoir (a translucent plastic bottle). Slowly turn cap counterclockwise (left) until pressure begins to release.
3. Step back while the pressure releases.
4. When you are sure that all the pressure has been released, use the cloth to turn it counterclockwise and remove the cap.
5. Fill the coolant reservoir slowly with the proper coolant mixture (see above), to within the “COLD FILL RANGE” or the “FULL COLD” level on the reservoir. If you removed the radiator cap in an overflow system, fill the radiator until the coolant is visible and radiator is almost full.

Maintenance and Specifications

6. Replace the cap. Turn until tightly installed. Cap must be tightly installed to prevent coolant loss.

After any coolant has been added, check the coolant concentration (refer to *Checking engine coolant*). If the concentration is not 50/50 (protection to $-34^{\circ}\text{F}/-36^{\circ}\text{C}$), drain some coolant and adjust the concentration. It may take several drains and additions to obtain a 50/50 coolant concentration.

Whenever coolant has been added, the coolant level in the coolant reservoir should be checked the next few times you drive the vehicle. If necessary, add enough 50/50 concentration of engine coolant and distilled water to bring the liquid level to the proper level.

If you have to add more than 1.0 quart (1.0 liter) of engine coolant per month, have your authorized dealer check the engine cooling system. Your cooling system may have a leak. Operating an engine with a low level of coolant can result in engine overheating and possible engine damage.

Recycled engine coolant

Ford Motor Company does NOT recommend the use of recycled engine coolant in vehicles originally equipped with Motorcraft Premium Gold Engine Coolant since a Ford-approved recycling process is not yet available.



Used engine coolant should be disposed of in an appropriate manner. Follow your community's regulations and standards for recycling and disposing of automotive fluids.

Coolant refill capacity

To find out how much fluid your vehicle's cooling system can hold, refer to *Maintenance product specifications and capacities* in this chapter.

Fill your engine coolant reservoir as outlined in *Adding engine coolant* in this section.

Severe climates

If you drive in extremely cold climates (less than -34°F [-36°C]):

- **It may be necessary to increase the coolant concentration above 50%.**
- **NEVER increase the coolant concentration above 60%.**
- **Increased engine coolant concentrations above 60% will decrease the overheat protection characteristics of the engine coolant and may cause engine damage.**

Maintenance and Specifications

- **Refer to the chart on the coolant container to ensure the coolant concentration in your vehicle will provide adequate freeze protection at the temperatures in which you drive in the winter months.**

If you drive in extremely hot climates:

- **It is still necessary to maintain the coolant concentration above 40%.**
- **NEVER decrease the coolant concentration below 40%.**
- **Decreased engine coolant concentrations below 40% will decrease the corrosion protection characteristics of the engine coolant and may cause engine damage.**
- **Decreased engine coolant concentrations below 40% will decrease the freeze protection characteristics of the engine coolant and may cause engine damage.**
- **Refer to the chart on the coolant container to ensure the coolant concentration in your vehicle will provide adequate protection at the temperatures in which you drive.**

Vehicles driven year-round in non-extreme climates should use a 50/50 mixture of engine coolant and distilled water for optimum cooling system and engine protection.

What you should know about fail-safe cooling

If the engine coolant supply is depleted, this feature allows the vehicle to be driven temporarily before incremental component damage is incurred. The “fail-safe” distance depends on ambient temperatures, vehicle load and terrain.

How fail-safe cooling works

If the engine begins to overheat:

- The engine coolant temperature gauge will move to the red (hot) area.
- The  symbol will illuminate.

If the engine reaches a preset over-temperature condition, the engine will automatically switch to alternating cylinder operation. Each disabled cylinder acts as an air pump and cools the engine.

When this occurs the vehicle will still operate. However:

- The engine power will be limited.
- The air conditioning system will be disabled.

Maintenance and Specifications

Continued operation will increase the engine temperature:

- The engine will completely shut down.
- Steering and braking effort will increase.

Once the engine temperature cools, the engine can be re-started. Take your vehicle to an authorized dealer as soon as possible to minimize engine damage.

When fail-safe mode is activated

You have limited engine power when in the fail-safe mode, so drive the vehicle with caution. The vehicle will not be able to maintain high speed operation and the engine will run rough. Remember that the engine is capable of completely shutting down automatically to prevent engine damage, therefore:

1. Pull off the road as soon as safely possible and turn off the engine.
2. Arrange for the vehicle to be taken to an authorized dealer.
3. If this is not possible, wait a short period for the engine to cool.
4. Check the coolant level and replenish if low.



Never remove the coolant reservoir cap while the engine is running or hot.

5. Restart the engine and take your vehicle to an authorized dealer.

Driving the vehicle without repairing the engine problem increases the chance of engine damage. Take your vehicle to an authorized dealer as soon as possible.

FUEL FILTER

Your vehicle is equipped with a lifetime fuel filter that is integrated with the fuel tank. Regular maintenance or replacement is not needed.

WHAT YOU SHOULD KNOW ABOUT AUTOMOTIVE FUELS

Important safety precautions



Do not overfill the fuel tank. The pressure in an overfilled tank may cause leakage and lead to fuel spray and fire.

Maintenance and Specifications

 The fuel system may be under pressure. If the fuel filler cap is venting vapor or if you hear a hissing sound, wait until it stops before completely removing the fuel filler cap. Otherwise, fuel may spray out and injure you or others.

 If you do not use the proper fuel filler cap, excessive vacuum in the fuel tank may damage the fuel system or cause the fuel cap to disengage in a collision, which may result in possible personal injury.

 Automotive fuels can cause serious injury or death if misused or mishandled.

 Gasoline may contain benzene, which is a cancer-causing agent.

Observe the following guidelines when handling automotive fuel:

- Extinguish all smoking materials and any open flames before refueling your vehicle.
- Always turn off the vehicle before refueling.
- Automotive fuels can be harmful or fatal if swallowed. Fuel such as gasoline is highly toxic and if swallowed can cause death or permanent injury. If fuel is swallowed, call a physician immediately, even if no symptoms are immediately apparent. The toxic effects of fuel may not be visible for hours.
- Avoid inhaling fuel vapors. Inhaling too much fuel vapor of any kind can lead to eye and respiratory tract irritation. In severe cases, excessive or prolonged breathing of fuel vapor can cause serious illness and permanent injury.
- Avoid getting fuel liquid in your eyes. If fuel is splashed in the eyes, remove contact lenses (if worn), flush with water for 15 minutes and seek medical attention. Failure to seek proper medical attention could lead to permanent injury.
- Fuels can also be harmful if absorbed through the skin. If fuel is splashed on the skin and/or clothing, promptly remove contaminated clothing and wash skin thoroughly with soap and water. Repeated or prolonged skin contact with fuel liquid or vapor causes skin irritation.



Maintenance and Specifications

- Be particularly careful if you are taking “Antabuse” or other forms of disulfiram for the treatment of alcoholism. Breathing gasoline vapors, or skin contact could cause an adverse reaction. In sensitive individuals, serious personal injury or sickness may result. If fuel is splashed on the skin, promptly wash skin thoroughly with soap and water. Consult a physician immediately if you experience an adverse reaction.



When refueling always shut the engine off and never allow sparks or open flames near the filler neck. Never smoke while refueling. Fuel vapor is extremely hazardous under certain conditions. Care should be taken to avoid inhaling excess fumes.



The flow of fuel through a fuel pump nozzle can produce static electricity, which can cause a fire if fuel is pumped into an ungrounded fuel container.

Refueling



Fuel vapor burns violently and a fuel fire can cause severe injuries. To help avoid injuries to you and others:

- Read and follow all the instructions on the pump island;
- Turn off your engine when you are refueling;
- Do not smoke if you are near fuel or refueling your vehicle;
- Keep sparks, flames and smoking materials away from fuel;
- Stay outside your vehicle and do not leave the fuel pump unattended when refueling your vehicle — this is against the law in some places;
- Keep children away from the fuel pump; never let children pump fuel.

Use the following guidelines to avoid electrostatic charge build-up when filling an ungrounded fuel container:

- Place approved fuel container on the ground.
- DO NOT fill a fuel container while it is in the vehicle (including the cargo area).
- Keep the fuel pump nozzle in contact with the fuel container while filling.
- DO NOT use a device that would hold the fuel pump handle in the fill position.

290



Maintenance and Specifications

Fuel Filler Cap

Your fuel tank filler cap has an indexed design with a 1/4 turn on/off feature.

When fueling your vehicle:

1. Turn the engine off.
2. Carefully turn the filler cap counterclockwise 1/4 turn until it stops.
3. Pull to remove the cap from the fuel filler pipe.
4. To install the cap, align the tabs on the cap with the notches on the filler pipe.
5. Turn the filler cap clockwise 1/4 of a turn until at least a few clicks are heard.

If the  symbol comes on and stays on after you start the engine, the fuel filler cap may not be properly installed. Turn off the engine, remove the fuel filler cap, align the cap properly and reinstall it. The  lamp will not reset immediately. Upon restarting the vehicle, it may take a few driving cycles (mileage accumulation) to clear the symbol.

Continued driving with this lamp  illuminated may cause the  lamp to activate.

If you must replace the fuel filler cap, replace it with a fuel filler cap that is designed for your vehicle. The customer warranty may be void for any damage to the fuel tank or fuel system if the correct genuine Ford or Motorcraft fuel filler cap is not used.



The fuel system may be under pressure. If the fuel filler cap is venting vapor or if you hear a hissing sound, wait until it stops before completely removing the fuel filler cap. Otherwise, fuel may spray out and injure you or others.



If you do not use the proper fuel filler cap, excessive vacuum in the fuel tank may damage the fuel system or cause the fuel cap to disengage in a collision, which may result in possible personal injury.

Choosing the right fuel

Use only UNLEADED fuel or UNLEADED fuel blended with a maximum of 10% ethanol. Your vehicle was not designed to run on E85 fuels that are blended with a maximum of 85% ethanol. The use of leaded fuel is

Maintenance and Specifications

prohibited by law and could damage your vehicle. Do not use fuel containing methanol. It can damage critical fuel system components.

Your vehicle was not designed to use fuel or fuel additives with metallic compounds, including manganese-based additives. Studies indicate that these additives can cause your vehicle's emission control system to deteriorate more rapidly.

Repairs to correct the effects of using a fuel for which your vehicle was not designed may not be covered by your warranty.

Octane recommendations

Your vehicle is designed to use "Regular" unleaded gasoline with pump (R+M)/2 octane rating of 87. We do not recommend the use of gasolines labeled as "Regular" that are sold with octane ratings of 86 or lower in high altitude areas.

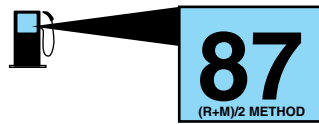

Do not be concerned if your engine sometimes knocks lightly. However, if it knocks heavily under most driving conditions while you are using fuel with the recommended octane rating, see your authorized dealer to prevent any engine damage.

Fuel quality

If you are experiencing starting, rough idle or hesitation driveability problems, try a different brand of unleaded gasoline. "Premium" unleaded gasoline is not recommended for vehicles designed to use "Regular" unleaded gasoline because it may cause these problems to become more pronounced. If the problems persist, see your authorized dealer.

Do not add aftermarket fuel additive products to your fuel tank. It should not be necessary to add any aftermarket products to your fuel tank if you continue to use high quality fuel of the recommended octane rating. These products have not been approved for your engine and could cause damage to the fuel system. Repairs to correct the effects of using an aftermarket product in your fuel may not be covered by your warranty.

Many of the world's automakers approved the World-Wide Fuel Charter that recommends gasoline specifications to provide improved performance and emission control system protection for your vehicle. Gasolines that meet the World-Wide Fuel Charter should be used when available. Ask your fuel supplier about gasolines that meet the World-Wide Fuel Charter.

292

Maintenance and Specifications

Cleaner air

Ford endorses the use of reformulated “cleaner-burning” gasolines to improve air quality, per the recommendations in the *Choosing the Right Fuel* section.

Running out of fuel

Avoid running out of fuel because this situation may have an adverse effect on powertrain components.

If you have run out of fuel:

- You may need to cycle the ignition from OFF to ON several times after refueling to allow the fuel system to pump the fuel from the tank to the engine. On restarting, cranking time will take a few seconds longer than normal.
- Normally, adding 1 gallon (3.8L) of fuel is enough to restart the engine. If the vehicle is out of fuel and on a steep grade, more than 1 gallon (3.8L) may be required.
- The  indicator may come on. For more information on the “check engine” or the “service engine soon” indicator, refer to *Warning lights and chimes* in the *Instrument Cluster* chapter.

ESSENTIALS OF GOOD FUEL ECONOMY

Measuring techniques

Your best source of information about actual fuel economy is you, the driver. You must gather information as accurately and consistently as possible. Fuel expense, frequency of fill-ups or fuel gauge readings are NOT accurate as a measure of fuel economy. We do not recommend taking fuel economy measurements during the first 1,000 miles (1,600 km) of driving (engine break-in period). You will get a more accurate measurement after 2,000 miles–3,000 miles (3,000 km–5,000 km).

Filling the tank

The advertised fuel capacity of the fuel tank on your vehicle is equal to the rated refill capacity of the fuel tank as listed in the *Maintenance product specifications and capacities* section of this chapter.

The advertised capacity is the amount of the indicated capacity and the empty reserve combined. Indicated capacity is the difference in the amount of fuel in a full tank and a tank when the fuel gauge indicates empty. Empty reserve is the small amount of fuel remaining in the fuel tank after the fuel gauge indicates empty.

Maintenance and Specifications

The amount of usable fuel in the empty reserve varies and should not be relied upon to increase driving range. When refueling your vehicle after the fuel gauge indicates empty, you might not be able to refuel the full amount of the advertised capacity of the fuel tank due to the empty reserve still present in the tank.

For consistent results when filling the fuel tank:

- Turn the engine/ignition switch to the off position prior to refueling, an error in the reading will result if the engine is left running.
- Use the same filling rate setting (low — medium — high) each time the tank is filled.
- Allow no more than two automatic click-offs when filling.
- Always use fuel with the recommended octane rating.
- Use a known quality gasoline, preferably a national brand.
- Use the same side of the same pump and have the vehicle facing the same direction each time you fill up.
- Have the vehicle loading and distribution the same every time.

Your results will be most accurate if your filling method is consistent.

Calculating fuel economy

1. Fill the fuel tank completely and record the initial odometer reading (in miles or kilometers).
2. Each time you fill the tank, record the amount of fuel added (in gallons or liters).
3. After at least three to five tank fill-ups, fill the fuel tank and record the current odometer reading.
4. Subtract your initial odometer reading from the current odometer reading.
5. Follow one of the simple calculations in order to determine fuel economy:

Calculation 1: **Divide total miles traveled by total gallons used.**

Calculation 2: **Multiply liters used by 100, then divide by total kilometers traveled.**

Keep a record for at least one month and record the type of driving (city or highway). This will provide an accurate estimate of the vehicle's fuel economy under current driving conditions. Additionally, keeping records during summer and winter will show how temperature impacts fuel economy. In general, lower temperatures give lower fuel economy.

Maintenance and Specifications

Driving style — good driving and fuel economy habits

Give consideration to the lists that follow and you may be able to change a number of variables and improve your fuel economy.

Habits

- Smooth, moderate operation can yield up to 10% savings in fuel.
- Steady speeds without stopping will usually give the best fuel economy.
- Idling for long periods of time (greater than one minute) may waste fuel.
- Anticipate stopping; slowing down may eliminate the need to stop.
- Sudden or hard accelerations may reduce fuel economy.
- Slow down gradually.
- Driving at reasonable speeds (traveling at 55 mph [88 km/h] uses 15% less fuel than traveling at 65 mph [105 km/h]).
- Revving the engine before turning it off may reduce fuel economy.
- Using the air conditioner or defroster may reduce fuel economy.
- You may want to turn off the speed control in hilly terrain if unnecessary shifting between the top gears occurs. Unnecessary shifting of this type could result in reduced fuel economy.
- Warming up a vehicle on cold mornings is not required and may reduce fuel economy.
- Resting your foot on the brake pedal while driving may reduce fuel economy.
- Combine errands and minimize stop-and-go driving.

Maintenance

- Keep tires properly inflated and use only recommended size.
- Operating a vehicle with the wheels out of alignment will reduce fuel economy.
- Use recommended engine oil. Refer to *Maintenance product specifications and capacities* in this chapter.
- Perform all regularly scheduled maintenance items. Follow the recommended maintenance schedule and owner maintenance checks found in *scheduled maintenance information*.

Conditions

- Heavily loading a vehicle may reduce fuel economy at any speed.

Maintenance and Specifications

- Carrying unnecessary weight may reduce fuel economy (approximately 1 mpg [0.4 km/L] is lost for every 400 lb [180 kg] of weight carried).
- Adding certain accessories to your vehicle (for example; bug deflectors, rollbars/light bars, running boards, ski/luggage racks) may reduce fuel economy.
- Using fuel blended with alcohol may lower fuel economy.
- Fuel economy may decrease with lower temperatures during the first 8–10 miles (12–16 km) of driving.
- Driving on flat terrain offers improved fuel economy as compared to driving on hilly terrain.
- Transmissions give their best fuel economy when operated in the top cruise gear and with steady pressure on the gas pedal.
- Close windows for high speed driving.

EPA window sticker

Every new vehicle should have the EPA window sticker. Contact your authorized dealer if the window sticker is not supplied with your vehicle. The EPA window sticker should be your guide for the fuel economy comparisons with other vehicles.

It is important to note the box in the lower left corner of the window sticker. These numbers represent the Range of MPG (L/100 km) expected on the vehicle under optimum conditions. Your fuel economy may vary depending upon the method of operation and conditions.

EMISSION CONTROL SYSTEM

Your vehicle is equipped with various emission control components and a catalytic converter which will enable your vehicle to comply with applicable exhaust emission standards. To make sure that the catalytic converter and other emission control components continue to work properly:

- Use only the specified fuel listed.
- Avoid running out of fuel.
- Do not turn off the ignition while your vehicle is moving, especially at high speeds.
- Have the items listed in *scheduled maintenance information* performed according to the specified schedule.

The scheduled maintenance items listed in *scheduled maintenance information* are essential to the life and performance of your vehicle and to its emissions system.

Maintenance and Specifications

If other than Ford, Motorcraft or Ford-authorized parts are used for maintenance replacements or for service of components affecting emission control, such non-Ford parts should be equivalent to genuine Ford Motor Company parts in performance and durability.



Do not park, idle, or drive your vehicle in dry grass or other dry ground cover. The emission system heats up the engine compartment and exhaust system, which can start a fire.

Illumination of the  indicator, charging system warning light or the temperature warning light, fluid leaks, strange odors, smoke or loss of engine power could indicate that the emission control system is not working properly.

An improperly operating or damaged exhaust system may allow exhaust to enter the vehicle. Have a damaged or improperly operating exhaust system inspected and repaired immediately.





Exhaust leaks may result in entry of harmful and potentially lethal fumes into the passenger compartment.

Do not make any unauthorized changes to your vehicle or engine. By law, vehicle owners and anyone who manufactures, repairs, services, sells, leases, trades vehicles, or supervises a fleet of vehicles are not permitted to intentionally remove an emission control device or prevent it from working. Information about your vehicle's emission system is on the Vehicle Emission Control Information Decal located on or near the engine. This decal identifies engine displacement and gives some tune up specifications.

Please consult your *Warranty Guide* for complete emission warranty information.

On board diagnostics (OBD-II)



Your vehicle is equipped with a computer that monitors the engine's emission control system. This system is commonly known as the On Board Diagnostics System (OBD-II). The OBD-II system protects the environment by ensuring that your vehicle continues to meet government emission standards. The OBD-II system also assists your authorized dealer in properly servicing your vehicle. When the  indicator illuminates, the OBD-II system has detected a malfunction. Temporary malfunctions may cause the  indicator to illuminate. Examples are:

1. The vehicle has run out of fuel—the engine may misfire or run poorly.

Maintenance and Specifications

2. Poor fuel quality or water in the fuel—the engine may misfire or run poorly.
3. The fuel cap may not have been securely tightened. See *Fuel filler cap* in this chapter.
4. Driving through deep water—the electrical system may be wet.



These temporary malfunctions can be corrected by filling the fuel tank with good quality fuel, properly tightening the fuel cap or letting the electrical system dry out. After three driving cycles without these or any other temporary malfunctions present, the  indicator should stay off the next time the engine is started. A driving cycle consists of a cold engine startup followed by mixed city/highway driving. No additional vehicle service is required.

If the  indicator remains on, have your vehicle serviced at the first available opportunity. Although some malfunctions detected by the OBD-II may not have symptoms that are apparent, continued driving with the  indicator on can result in increased emissions, lower fuel economy, reduced engine and transmission smoothness, and lead to more costly repairs.

Readiness for Inspection/Maintenance (I/M) testing

Some state/provincial and local governments may have Inspection/Maintenance (I/M) programs to inspect the emission control equipment on your vehicle. Failure to pass this inspection could prevent you from getting a vehicle registration. Your vehicle may not pass the I/M test if the  indicator is on or not working properly (bulb is burned out), or if the OBD-II system has determined that some of the emission control systems have not been properly checked. In this case, the vehicle is considered not ready for I/M testing.

If the  indicator is on or the bulb does not work, the vehicle may need to be serviced. Refer to the On board diagnostics (OBD-II) description in this chapter.

If the vehicle's engine or transmission has just been serviced, or the battery has recently run down or been replaced, the OBD-II system may indicate that the vehicle is not ready for I/M testing. To determine if the vehicle is ready for I/M testing, turn the ignition key to the ON position for 15 seconds without cranking the engine. If the  indicator blinks eight times, it means that the vehicle is not ready for I/M testing; if the  indicator stays on solid, it means that the vehicle is ready for I/M testing.

Maintenance and Specifications

The OBD-II system is designed to check the emission control system during normal driving. A complete check may take several days. If the vehicle is not ready for I/M testing, the following driving cycle consisting of mixed city and highway driving may be performed:

15 minutes of steady driving on an expressway/highway followed by 20 minutes of stop-and-go driving with at least four 30-second idle periods.

Allow the vehicle to sit for at least eight hours without starting the engine. Then, start the engine and complete the above driving cycle. The engine must warm up to its normal operating temperature. Once started, do not turn off the engine until the above driving cycle is complete. If the vehicle is still not ready for I/M testing, the above driving cycle will have to be repeated.

POWER STEERING FLUID

Check the power steering fluid. Refer to the *scheduled maintenance information* for the service interval schedules.

1. Start the engine and let it run until it reaches normal operating temperature (the engine coolant temperature gauge indicator will be near the center of the normal area between H and C).
2. While the engine idles, turn the steering wheel left and right several times.
3. Turn the engine off.
4. Check the fluid level in the reservoir. It should be between the MIN and MAX lines. Do not add fluid if the level is in this range.
5. If the fluid is low, add fluid in small amounts, continuously checking the level until it reaches the range between the MIN and MAX lines. Be sure to put the cap back on the reservoir. Refer to *Maintenance product specifications and capacities* in this chapter for the proper fluid type.



Maintenance and Specifications

BRAKE FLUID

The fluid level will drop slowly as the brakes wear, and will rise when the brake components are replaced. Fluid levels between the “MIN” and “MAX” lines are within the normal operating range; there is no need to add fluid. If the fluid levels are outside of the normal operating range the performance of the system could be compromised; seek service from your authorized dealer immediately.

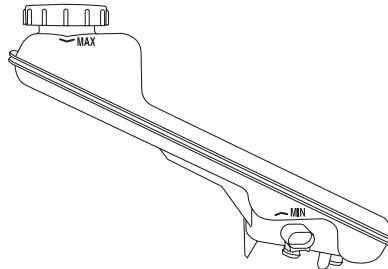

TRANSAXLE FLUID

Checking automatic transaxle fluid

Refer to your *scheduled maintenance information* for scheduled intervals for fluid checks and changes. Your transaxle does not consume fluid. However, the fluid level should be checked if the transaxle is not working properly, i.e., if the transaxle slips or shifts slowly or if you notice some sign of fluid leakage.

Automatic transmission fluid expands when warmed. To obtain an accurate fluid check, drive the vehicle until it is warmed up (approximately 20 miles [30 km]). If your vehicle has been operated for an extended period at high speeds, in city traffic during hot weather or pulling a trailer, the vehicle should be turned off for about 30 minutes to allow fluid to cool before checking.

1. Drive the vehicle 20 miles (30 km) or until it reaches normal operating temperature.
2. Park the vehicle on a level surface and engage the parking brake.
3. With the parking brake engaged and your foot on the brake pedal, start the engine and move the gearshift lever through all of the gear ranges. Allow sufficient time for each gear to engage.
4. Latch the gearshift lever in P (Park) and leave the engine running.
5. Remove the dipstick, wiping it clean with a clean, dry lint free rag. If necessary, refer to *Identifying components in the engine compartment* in this chapter for the location of the dipstick.
6. Install the dipstick making sure it is fully seated in the filler tube.

300

Maintenance and Specifications

7. Remove the dipstick and inspect the fluid level. The fluid should be in the designated areas for normal operating temperature.

Low fluid level

Do not drive the vehicle if the fluid level is in the add range or does not show at all on the dipstick.

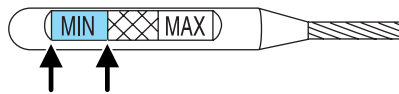

Correct fluid level

The transmission fluid should be checked at normal operating temperature 149°F (65°C) on a level surface. The normal operating temperature can be reached after approximately 20 miles (30 km) of driving.

The transmission fluid should be within the cross-hatch area if at normal operating temperature 149°F (65°C).



High fluid level

Fluid levels above the safe range may result in transaxle failure. An overfill condition of transmission fluid may cause shift and/or engagement concerns and/or possible damage.

High fluid levels can be caused by an overheating condition.

Adjusting automatic transmission fluid levels

Before adding any fluid, make sure the correct type is used. The type of fluid used is normally indicated on the dipstick and also in the *Maintenance product specifications and capacities* section in this chapter.

Use of a non-approved automatic transmission fluid may cause internal transaxle component damage.

If necessary, add fluid in 1/2 pint (250 mL) increments through the filler tube until the level is correct.

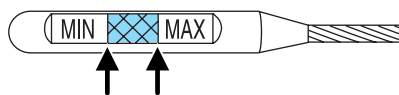

Maintenance and Specifications

If an overfill occurs, excess fluid should be removed by an authorized dealer.

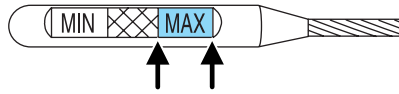

An overfill condition of transmission fluid may cause shift and/or engagement concerns and/or possible damage.

Do not use supplemental transmission fluid additives, treatments or cleaning agents. The use of these materials may affect transmission operation and result in damage to internal transaxle components.

AIR FILTER

Refer to *scheduled maintenance information* for the appropriate intervals for changing the air filter element.

When changing the air filter element, use only the Motorcraft air filter element listed. Refer to *Motorcraft part numbers* in this chapter.



To reduce the risk of vehicle damage and/or personal burn injuries do not start your engine with the air cleaner removed and do not remove it while the engine is running.

Changing the air filter element

1. Release the clamps that secure the air filter housing cover.
2. Carefully separate the two halves of the air filter housing.
3. Remove the air filter element from the air filter housing.
4. Wipe the air filter housing and cover clean to remove any dirt or debris and to ensure good sealing.
5. Install a new air filter element. Be careful not to crimp the filter element edges between the air filter housing and cover. This could cause filter damage and allow unfiltered air to enter the engine if not properly seated.

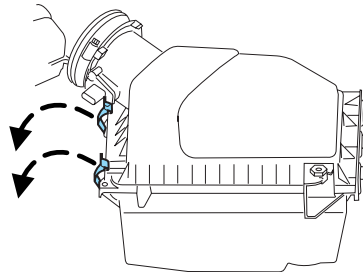

Maintenance and Specifications

6. Replace the air filter housing cover and secure the clamps. Be sure that the air cleaner cover tabs are engaged into the slots of the air cleaner housing.

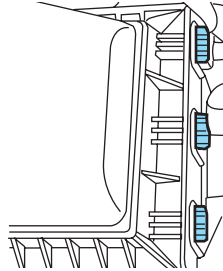

Note: Failure to use the correct air filter element may result in severe engine damage. The customer warranty may be void for any damage to the engine if the correct air filter element is not used.

MOTORCRAFT PART NUMBERS

Component	3.5L V6 Engine
Engine air filter element	FA-1884
Battery	BXT-36R
Oil filter	FL-400-SB12
PCV valve	¹
Spark plugs	²

¹The PCV valve is a critical emission component. It is one of the items listed in *scheduled maintenance information* and is essential to the life and performance of your vehicle and to its emissions system.

For PCV valve replacement, see your authorized dealer. Refer to *scheduled maintenance information* for the appropriate intervals for changing the PCV valve.

Replace the PCV valve with one that meets Ford material and design specifications for your vehicle, such as a Motorcraft or equivalent replacement part. The customer warranty may be void for any damage to the emissions system if such a PCV valve is not used.

²For spark plug replacement, see your authorized dealer. Refer to *scheduled maintenance information* for the appropriate intervals for changing the spark plugs.

Replace the spark plugs with ones that meet Ford material and design specifications for your vehicle, such as Motorcraft or equivalent replacement parts. The customer warranty may be void for any damage to the engine if such spark plugs are not used.

Maintenance and Specifications

MAINTENANCE PRODUCT SPECIFICATIONS AND CAPACITIES

Item	Capacity	Ford part name	Ford part number / Ford specification
Brake fluid	Between MIN and MAX on reservoir	Motorcraft High Performance DOT 3 Motor Vehicle Brake Fluid	PM-1-C / WSS-M6C62-A
Door weatherstrips	—	Silicone Spray Lubricant	XL-6 / ESR-M13P4-A
Door latch, hood latch, auxiliary hood latch, door hinges, striker plates, seat tracks and fuel filler door hinge	—	Multi-Purpose Grease	XG-4 or XL-5 / ESB-M1C93-B
Lock cylinders	—	Motorcraft Penetrating and Lock Lubricant	XL-1 / None
Engine oil ¹	5.5 quarts (5.2L)	Motorcraft SAE 5W-20 Premium Synthetic Blend Motor Oil (US) Motorcraft SAE 5W-20 Super Premium Motor Oil (Canada)	XO-5W20-QSP (US) CXO-5W20-LSP12 (Canada) / WSS-M2C930-A with API Certification Mark

Maintenance and Specifications

Item	Capacity	Ford part name	Ford part number / Ford specification
Engine coolant	11.7 quarts (11.09L)	Motorcraft Premium Gold Engine Coolant with bittering agent (yellow-colored) ²	VC-7-B / WSS-M97B51-A1
Engine coolant—with trailer tow package	12.83 quarts (12.14L)		
Power steering fluid	Between MIN and MAX on reservoir	Motorcraft MERCON [®] V ATF	XT-5-QM / MERCON [®] V
Automatic transmission fluid	10.0 quarts (9.5L) ³	Motorcraft MERCON [®] V ATF ⁴	XT-5-QM / MERCON [®] V
Rear differential (AWD) fluid	2.4 pints (1.15L)	Motorcraft SAE 80W-90 Premium Rear Axle Lubricant	XY-80W90-QL / WSP-M2C197-A
Power Transfer Unit (PTU) fluid (AWD) ⁵	12 ounces (0.35L)	Motorcraft SAE 75W-140 Synthetic Rear Axle Lubricant	XY-75W140-QL / WSL-M2C192-A
Windshield washer fluid	4.75 quarts (4.5L)	Motorcraft Premium Windshield Washer Concentrate	ZC-32-A / WSB-M8B16-A2
Fuel tank (front-wheel drive)	19.2 gallons (72.7L)	—	—
Fuel tank (all-wheel drive)	20.8 gallons (78.7L)	—	—

¹Use of synthetic or synthetic blend motor oil is not mandatory. Engine oil need only meet the requirements of Ford specification WSS-M2C930-A and the API Certification mark.

²Add the coolant type originally equipped in your vehicle.

Maintenance and Specifications

³Indicates only approximate dry-fill capacity. Some applications may vary based on cooler size and if equipped with an in-tank cooler. The amount of transmission fluid and fluid level should be set by the indication on the dipstick's normal operating range.

⁴Automatic transmissions that require MERCON® V should only use MERCON® V fluid or fluid that is specified dual usage MERCON®/MERCON® V. Refer to *scheduled maintenance information* to determine the correct service interval. Use of any fluid other than the recommended fluid may cause transmission damage.

⁵See your authorized dealer for fluid level checking or filling.

Maintenance and Specifications

ENGINE DATA

Engine	3.5L-DOHC V6 engine
Displacement	3.5L
Required fuel	87 octane
Firing order	1-4-2-5-3-6
Spark plug gap	(0.052-0.056 inch) 1.32-1.42 mm
Ignition system	Coil on plug
Compression ratio	10.3:1

Engine drivebelt routing

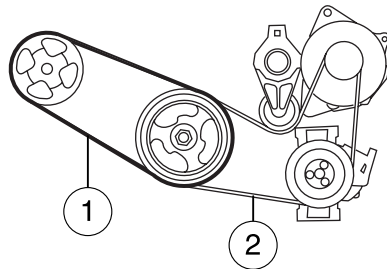

- 3.5L V6 Engine
1. Short drivebelt is on first pulley groove closest to engine.
 2. Long drivebelt is on second pulley groove farthest from engine.

Maintenance and Specifications

IDENTIFYING YOUR VEHICLE

Safety Compliance Certification Label

The National Highway Traffic Safety Administration Regulations require that a Safety Compliance Certification Label be affixed to a vehicle and prescribe where the Safety Compliance Certification Label may be located. The Safety Compliance Certification Label is located on the structure (B-Pillar) by the trailing edge of the driver's door or the edge of the driver's door.

MFD. BY FORD MOTOR CO.			
DATE: XX/XX	GVWR: XXXXLB/ XXXXKG		
FRONT GAWR: XXXXL	REAR GAWR: XXXXLB		
XXXXKG	WITH	XXXXKG	WITH
XXXX/XXXXXXX	TIRES	XXXX/XXXXXXX	TIRES
XXXX.XX	RIMS	XXXX.XX	RIMS
AT XXX kPa/XX	PSI COLD	AT XXX kPa/XX	PSI COLD
THIS VEHICLE CONFORMS TO ALL APPLICABLE FEDERAL MOTOR VEHICLE SAFETY AND THEFT PREVENTION STANDARDS IN EFFECT ON THE DATE OF MANUFACTURE SHOWN ABOVE.			
VIN: XXXXXXXXXXXXXXXXX	XXXXX XXXXX		
TYPE: XXX			
			
EXT PNT: XX	RC: XX	DSO:	
WB ¹ BRK ²	INT TR ³	R ⁴	AXLE ⁵ TR ⁶ SPR ⁷ XXXXX
XXX X	XX	X	XX X XX XXX
XXXXXXXXXXXXXXX XXX XXXX-XXXXXX-XX			

Vehicle identification number (VIN)

The vehicle identification number is located on the driver side instrument panel.

Please note that in the graphic, XXXX is representative of your vehicle identification number.

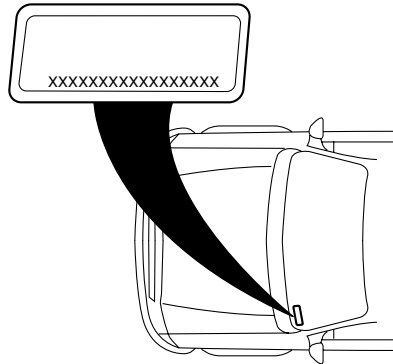

Maintenance and Specifications

The Vehicle Identification Number (VIN) contains the following information:

1. World manufacturer identifier
2. Brake system / Gross Vehicle Weight Rating (GVWR) / Restraint System
3. Vehicle line, series, body type
4. Engine type
5. Check digit
6. Model year
7. Assembly plant
8. Production sequence number

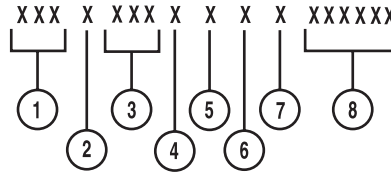

TRANSMISSION/TRANSAXLE CODE DESIGNATIONS

You can find a transmission/transaxle code on the Safety Compliance Certification Label. The following table tells you which transmission or transaxle each code represents.

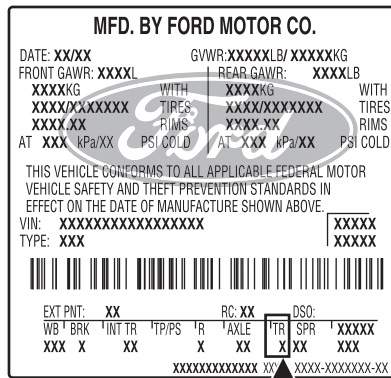

Description	Code
6F50 6-Speed Automatic Transaxle	J

Accessories

GENUINE LINCOLN ACCESSORIES FOR YOUR VEHICLE

A wide selection of Genuine Lincoln Accessories are available for your vehicle through your local Lincoln or Ford of Canada dealer. These quality accessories have been specifically engineered to fulfill your automotive needs; they are custom designed to complement the style and aerodynamic appearance of your vehicle. In addition, each accessory is made from high quality materials and meets or exceeds Lincoln's rigorous engineering and safety specifications. Ford Motor Company will repair or replace any properly dealer-installed Genuine Lincoln Accessories found to be defective in factory-supplied materials or workmanship during the warranty period, as well as any component damaged by the defective accessories. The accessories will be warranted for whichever provides you the greatest benefit:

- 12 months or 12,000 miles (20,000 km) (whichever occurs first), or
- the remainder of your new vehicle limited warranty.

Contact your dealer for details and a copy of the warranty.

Following is a list of several Genuine Lincoln Accessories. Not all accessories are available for all models. To find out what accessories are available for your vehicle, please contact your dealer or visit our online store at: www.lincolnaccessories.com.

Exterior style

Bug shields

Deflectors

Splash guards

Interior style

Electrochromatic compass/temperature interior mirrors

Floor mats

Lifestyle

Ash cup / coin holder

Cargo organization and management

Cross bars

Trailer hitches, wiring harnesses and accessories

Accessories

Peace of mind

Mobile-Ease[™] hands-free communication system

Remote start

Vehicle security systems

Wheel locks

For maximum vehicle performance, keep the following information in mind when adding accessories or equipment to your vehicle:

- When adding accessories, equipment, passengers and luggage to your vehicle, do not exceed the total weight capacity of the vehicle or of the front or rear axle (GVWR or GAWR as indicated on the Safety Compliance Certification label). Consult your authorized dealer for specific weight information.
- The Federal Communications Commission (FCC) and Canadian Radio Telecommunications Commission (CRTC) regulate the use of mobile communications systems — such as two-way radios, telephones and theft alarms - that are equipped with radio transmitters. Any such equipment installed in your vehicle should comply with FCC or CRTC regulations and should be installed only by a qualified service technician.
- Mobile communications systems may harm the operation of your vehicle, particularly if they are not properly designed for automotive use.
- To avoid interference with other vehicle functions, such as anti-lock braking systems, amateur radio users who install radios and antennas onto their vehicle should not locate the Amateur Radio Antennas in the area of the driver's side hood.
- Electrical or electronic accessories or components that are added to the vehicle by the authorized dealer or the owner may adversely affect battery performance and durability.

Index

A

- Accessory delay81
- AdvanceTrac219
- Air cleaner filter302–303
- Air conditioning54, 56, 58
- Airbag supplemental restraint system155, 164, 167
 - and child safety seats157
 - description155, 164, 167
 - disposal170
 - driver airbag157, 165, 168
 - indicator light163, 166, 169
 - operation157, 165, 168
 - passenger airbag157, 165, 168
 - side airbag164
- All Wheel Drive (AWD), driving off road229
- Antifreeze (see Engine coolant)283
- Anti-lock brake system (see Brakes)218
- Anti-theft system123, 127
 - arming the system127
 - disarming a triggered system128
- Audio system (see Radio)16
- Automatic transaxle
 - fluid, adding300
 - fluid, checking300
- Automatic transmission
 - driving an automatic overdrive225
 - fluid, refill capacities304
 - fluid, specification304
- Auxiliary input jack (Line in)22
- Auxiliary power point78

- Axle
 - lubricant specifications304

B

- Battery281
 - acid, treating emergencies281
 - jumping a disabled battery251
 - maintenance-free281
 - replacement, specifications ...303
 - servicing281
- Belt-Minder®151
- Booster seats171
- Brakes217
 - anti-lock218
 - anti-lock brake system (ABS)
 - warning light218
 - fluid, checking and adding ...300
 - fluid, refill capacities304
 - fluid, specifications304
 - lubricant specifications304
 - parking219
 - shift interlock223
- Bulbs68

C

- Capacities for refilling fluids304
- Cargo management system107
- Cell phone use7
- Changing a tire245, 248
- Child safety restraints171
 - child safety belts171
- Child safety seats174
 - attaching with tether straps ..178
 - in front seat175
 - in rear seat175
- Child safety seats - booster seats171

Index

- Cleaning your vehicle
engine compartment268
instrument panel270
interior270–271
plastic parts268
safety belts270
washing266
waxing267
wheels267
wiper blades269
- Climate control
(see Air conditioning or Heating)54, 56, 58
- Compass, electronic
set zone adjustment95
- Console78
overhead77
- Controls
power seat130
steering column85
- Convertible
cleaning269
- Coolant
checking and adding283
refill capacities286, 304
specifications304
- Cruise control
(see Speed control)83
- Cupholder(s)139
- Customer Assistance235
Ford Extended Service Plan263
Getting assistance outside the U.S. and Canada264
Getting roadside assistance ...235
Getting the service you need259
Ordering additional owner's literature264
- Utilizing the Mediation/Arbitration Program262
- D**
- Daytime running lamps
(see Lamps)64
- Dipstick
automatic transmission
fluid300
engine oil277
- Driving under special conditions227, 230, 232
sand231
snow and ice233
through water232, 234
- DVD system27
- E**
- Electronic message center92
- Emergencies, roadside
jump-starting251
- Emission control system296
- Engine307
cleaning268
coolant283
fail-safe cooling287
idle speed control281
lubrication specifications304
refill capacities304
service points275
starting after a collision237
- Engine block heater217
- Engine oil277
change oil soon warning,
message center277
checking and adding277
dipstick277

Index

- filter, specifications280, 303
- recommendations280
- refill capacities304
- specifications304
- Event data recording6
- Exhaust fumes217
- F**
- Fail safe cooling287
- Family entertainment system27
- Floor mats102
- Fluid capacities304
- Foglamps64
- Four-Wheel Drive vehicles
 - driving off road229
- Fuel288
 - calculating fuel
 - economy94, 293
 - cap291
 - capacity304
 - choosing the right fuel291
 - comparisons with EPA fuel
 - economy estimates296
 - detergent in fuel293
 - filling your vehicle with
 - fuel288, 291, 293
 - filter, specifications288, 303
 - fuel pump shut-off switch237
 - improving fuel economy293
 - octane rating292, 307
 - quality292
 - running out of fuel293
 - safety information relating to
 - automotive fuels288
- Fuses237–238
- G**
- Gas cap (see Fuel cap)291
- Gas mileage
 - (see Fuel economy)293
- Gauges14
- H**
- Hazard flashers236
- Head restraints129, 137
- Headlamps63
 - aiming65
 - autolamp system63
 - bulb specifications68
 - daytime running lights64
 - flash to pass64
 - high beam64
 - replacing bulbs69
 - turning on and off63
- Heating
 - heating and air conditioning
 - system54, 56, 58
- Homelink wireless control
- system88
- Hood274
- I**
- Ignition214, 307
- Illuminated visor mirror77
- Infant seats
 - (see Safety seats)174
- Inspection/maintenance (I/M)
- testing298
- Instrument panel
 - cleaning270
 - cluster10
 - lighting up panel and
 - interior65
- J**
- Jack245

Index

- positioning245
- storage245
- Jump-starting your vehicle251
- K**
- Keyless entry system122
 - autolock110
 - keypad122
 - locking and unlocking doors ..123
 - programming entry code122
- Keys108, 125
 - positions of the ignition214
- L**
- Lamps
 - autolamp system63
 - bulb replacement
 - specifications chart68
 - daytime running light64
 - fog lamps64
 - headlamps63
 - headlamps, flash to pass64
 - instrument panel, dimming65
 - interior lamps67, 69
 - replacing bulbs69
- Lane change indicator
(see Turn signal)67
- Liftgate103, 106, 117
- Lights, warning and indicator10
 - anti-lock brakes (ABS)218
- Load limits202
- Locks
 - autolock110
 - childproof114
 - doors110
- Lubricant specifications304
- Lug nuts251
- Lumbar support, seats130, 132
- M**
- Message center92–93
 - english/metric button98
 - system check button97
 - warning messages100
- Mirrors82
 - automatic dimming rearview
 - mirror81
 - fold away82
 - heated82
 - programmable memory118
 - side view mirrors (power)82
- Moon roof87, 116
- Motorcraft parts272, 288, 303
- N**
- Navigation system53
- O**
- Octane rating292
- Oil (see Engine oil)277
- Overdrive224
- P**
- Parking brake219
- Parts (see Motorcraft parts)303
- Passenger Occupant
Classification Sensor142
- Power distribution box
(see Fuses)241
- Power door locks110
- Power liftgate103
- Power mirrors82

Index

- Power point78
- Power steering222
- fluid, checking and adding299
- fluid, refill capacity304
- fluid, specifications304
- Power Windows79
- R**
- Radio16
- Rear seat entertainment system27
- Relays237
- Remote entry system114, 116
- illuminated entry120–121
- locking/unlocking doors116–117
- opening the trunk117
- panic alarm117
- replacement/additional transmitters119
- replacing the batteries118
- Reverse sensing system227
- Roadside assistance235
- S**
- Safety Belt Maintenance150
- Safety belts (see Safety restraints)140, 144–148
- Safety Canopy164, 167
- Safety defects, reporting265
- Safety restraints140, 144–148
- Belt-Minder®151
- extension assembly149
- for adults145–147
- for children170–171
- Occupant Classification Sensor142
- safety belt maintenance150
- warning light and chime150
- Safety seats for children174
- Safety Compliance Certification Label308
- Satellite Radio Information24
- Seats129
- child safety seats174
- climate control134
- easy access/easyout feature ..133
- front seats129, 133–134
- heated54, 56
- memory seat118, 133
- SecuriLock passive anti-theft system123
- Servicing your vehicle273
- Spare tire (see Changing the Tire)248
- Spark plugs, specifications303, 307
- Specification chart, lubricants304
- Speed control83
- Starting your vehicle214–216
- jump starting251
- Steering wheel
- controls85
- tilting76
- T**
- Tilt steering wheel76
- Tire Pressure Monitoring System (TPMS)
- Tires, Wheels and Loading198
- Tires183–184, 245

Index

- alignment192
- care188
- changing245, 248
- checking the pressure188
- inflating185
- label197
- replacing189
- rotating192
- safety practices191
- sidewall information193
- snow tires and chains202
- spare tire245, 248
- terminology185
- tire grades184
- treadwear184, 188
- Towing208
 - recreational towing212
 - trailer towing208
 - wrecker257
- Transaxle
 - fluid, checking and adding (automatic)300
- Transmission223
 - brake-shift interlock (BSI)223
 - fluid, refill capacities304
 - lubricant specifications304
- Trunk117
- Turn signal67
- V**
- Vehicle Identification Number (VIN)308
- Vehicle loading202
- Ventilating your vehicle217
- W**
- Warning lights (see Lights)10
- Washer fluid276
- Water, Driving through234
- Windows116
 - power79
 - rear wiper/washer76
- Windshield washer fluid and wipers75
 - checking and adding fluid276
 - replacing wiper blades ...276–277
- Wrecker towing257

