



lincolnowner.com



lincolncanada.com

April 2014
Second Printing
Owner's Manual
Lincoln MKX
Litho in U.S.A.



EA1J 19A321 AA



2014 MKX

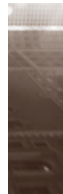
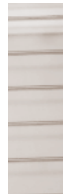

Owner's Manual

2014 MKX



Owner's Manual



Table of Contents	1
<hr/>	
Introduction	9
Child Safety	17
Child seat positioning19
Booster seats21
Installing child seats24
Child safety locks32
Safety Belts	33
Fastening the safety belts35
Safety belt height adjustment38
Safety belt warning light and indicator chime39
Safety belt-minder40
Child restraint and safety belt maintenance42
Personal Safety System	43
Supplementary Restraints System	44
Driver and passenger airbags46
Front passenger sensing system48
Side airbags52
Safety canopy curtain airbags53
Crash sensors and airbag indicator55
Airbag disposal56
Keys and Remote Control	57
General information on radio frequencies57
Remote control58
Replacing a lost key or remote control62

MyKey	63
Settings, MyKey63
Creating64
Clearing65
System status65
Remote start, MyKey66
Troubleshooting, MyKey66
Locks	67
Locking and unlocking67
SecuriCode™ keyless entry keypad75
Security	77
SecuriLock® passive anti-theft system77
Anti-theft alarm79
Steering Wheel	80
Adjusting the steering wheel80
Steering wheel controls82
Wipers and Washers	85
Windshield wipers85
Rain-sensing wipers85
Windshield washers86
Rear-window wiper and washer86
Lighting	87
Lighting control87
Autolamps87
Instrument lighting dimmer88
Headlamp exit delay88
Daytime running lamps89
Front fog lamps90
Adaptive headlamps90
Direction indicators91
Interior lamps92

Table of Contents 3

Windows and Mirrors	94
Power windows94
Exterior mirrors95
Interior mirrors97
Sun visors98
Moonroof99
Instrument Cluster	101
Gauges101
Warning lamps and indicators101
Audible warnings and indicators106
Information Displays	107
Controls107
Information messages113
Climate Control	122
Dual automatic temperature control122
Rear window defroster124
Cabin air filter125
Seats	127
Sitting in the correct position127
Head restraints128
Power seats130
Memory function132
Heated and ventilated seats133
Rear seats135
Universal Garage Door Opener	138
HomeLink® wireless control system138
Auxiliary Power Points	143

Storage Compartments	144
Center console	144
Overhead console	144
Starting and Stopping the Engine	145
Engine block heater	149
Fuel and Refueling	151
Fuel quality	152
Running out of fuel	153
Refueling	155
Fuel consumption	156
Transmission	161
Automatic transmission	161
All-Wheel Drive (If Equipped)	166
All wheel drive	166
Brakes	173
Brakes	173
Hints on driving with anti-lock brakes	174
Parking brake	174
Hill start assist	174
Traction Control	176
Traction Control™	176
Stability Control	177
AdvanceTrac®	178
Parking Aids	179
Sensing system	179
Rear-view camera system	180
Cruise Control	185
Using cruise control	185
Using Adaptive Cruise Control	186

Table of Contents

5

Driving Aids	195
Blind Spot Information System (BLIS) with Cross Traffic Alert (CTA)	195
Collision warning system	200
Steering	203
Load Carrying	205
Cargo net	205
Roof racks and load carriers	207
Utility hooks	208
Vehicle loading	208
Towing	216
Trailer towing	216
Wrecker towing	222
Recreational towing	223
Driving Hints	225
Economical driving	225
Driving through water	226
Floor mats	227
Roadside Emergencies	228
Getting roadside assistance	228
Hazard warning flashers	229
Fuel cut-off switch	229
Jump-starting the vehicle	230
Customer Assistance	234
Reporting safety defects (U.S. only)	241
Reporting safety defects (Canada only)	241
Fuses	242
Changing a fuse	242
Fuse specification chart	243

Maintenance	252
General information252
Opening and closing the hood253
Under hood overview254
Engine oil dipstick255
Engine oil check255
Engine coolant check256
Automatic transmission fluid check260
Brake fluid check262
Fuel filter263
Washer fluid check263
Changing the vehicle battery263
Checking the wiper blades266
Changing the wiper blades266
Air filter(s)267
Adjusting the headlamps268
Changing a bulb270
Bulb specification chart274
Vehicle Care	276
Cleaning products276
Cleaning the exterior276
Waxing278
Repairing minor paint damage278
Cleaning the engine278
Cleaning the windows and wiper blades279
Cleaning the interior280
Cleaning the instrument panel and instrument cluster lens280
Cleaning leather seats281
Cleaning the alloy wheels282
Vehicle storage283

Table of Contents

7

Wheels and Tires	286
Tire care288
Using snow chains303
Tire Pressure Monitoring System (TPMS)304
Changing a road wheel308
Technical specifications314
Wheel lug nut torque314
Capacities and Specifications	316
Engine specifications316
Part numbers320
Vehicle identification number320
Vehicle certification label321
Transmission code designation322
Accessories	323
Accessories323
Extended Service Plan	325
Audio System	328
MyLincoln Touch™ system330
MyLincoln Touch™	332
Infotainment display339
Voice recognition340
Listening to music344
Phone features365
Information Menu373
Settings385
Climate features397
Navigation system400

8 **Table of Contents**

Appendices	412
Scheduled Maintenance	431
Normal scheduled maintenance and log	436
Index	448

The information contained in this publication was correct at the time of going to print. In the interest of continuous development, we reserve the right to change specifications, design or equipment at any time without notice or obligation. No part of this publication may be reproduced, transmitted, stored in a retrieval system or translated into any language in any form by any means without our written permission. Errors and omissions excepted.

© Ford Motor Company 2014

ABOUT THIS MANUAL

Thank you for choosing Ford. We recommend that you take some time to get to know your vehicle by reading this manual. The more that you know about it, the greater the safety and pleasure you will get from driving it.



WARNING: Always drive with due care and attention when using and operating the controls and features on your vehicle.

Note: This manual describes product features and options available throughout the range of available models, sometimes even before they are generally available. It may describe options not fitted to your vehicle.

Note: Some of the illustrations in this manual may be used for different models, so may appear different to you on your vehicle. However, the essential information in the illustrations is always correct.

Note: Always use and operate your vehicle in line with all applicable laws and regulations.

Note: Pass on this manual when selling your vehicle. It is an integral part of the vehicle.

This manual may qualify the location of a component as left-hand side or right-hand side. The side is determined when facing forward in the seat.

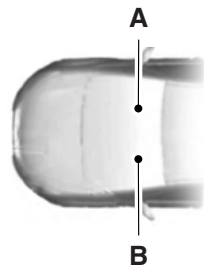

A. Right-hand side

B. Left-hand side















Protecting the Environment





















You must play your part in protecting the environment. Correct vehicle usage and the authorized disposal of waste, cleaning and lubrication materials are significant steps toward this aim.

SYMBOL GLOSSARY

 **WARNING:** You risk death or serious injury to yourself and others if you do not follow the instruction highlighted by the warning symbol.

These are some of the symbols you may see on your vehicle.

Symbol	Description	Symbol	Description	Symbol	Description
	Safety alert		See Owner's Manual		Anti-lock braking system
	Avoid smoking, flames, or sparks		Battery		Battery acid
	Brake fluid – non petroleum base		Brake system		Cabin air filter
	Check fuel cap		Child Safety Door Lock and Unlock		Child seat lower anchor
	Child seat tether anchor		Cruise control		Do not open when hot
	Engine air filter		Engine coolant		Engine coolant temperature
	Engine oil		Explosive gas		Fan warning
	Fasten safety belt		Front airbag		Front fog lamps

Symbol	Description	Symbol	Description	Symbol	Description
	Fuel pump reset		Fuse compartment		Hazard warning flasher
	Heated rear window		Interior luggage compartment release		Jack
	Lighting control		Low tire pressure warning		Maintain correct fluid level
	Panic alarm		Parking aid system		Parking brake system
	Power steering fluid		Power windows front and rear		Power window lockout
	Service engine soon		Side airbag		Stability control
	Windshield defrost and demist		Windshield washer and wiper		

DATA RECORDING

Service Data Recording

Service data recorders in your vehicle are capable of collecting and storing diagnostic information about your vehicle. This potentially includes information about the performance or status of various systems and modules in the vehicle, such as engine, throttle, steering or brake systems. In order to properly diagnose and service your vehicle, Ford Motor Company, Ford of Canada, and service and repair facilities may access or share among them vehicle diagnostic information received through a direct connection to your vehicle when diagnosing or servicing your vehicle. Additionally, when your vehicle is in for service or repair, Ford Motor Company, Ford of Canada, and service and repair facilities

may access or share among them data for vehicle improvement purposes. For U.S. only (if equipped), if you choose to use the SYNC® Vehicle Health Report, you consent that certain diagnostic information may also be accessed electronically by Ford Motor Company and Ford authorized service facilities, and that the diagnostic information may be used for any purpose. See the *SYNC®* chapter for more information.

Event Data Recording

This vehicle is equipped with an event data recorder (EDR). The main purpose of an EDR is to record, in certain crash or near crash-like situations, such as an airbag deployment or hitting a road obstacle; this data will assist in understanding how a vehicle's systems performed. The EDR is designed to record data related to vehicle dynamics and safety systems for a short period of time, typically 30 seconds or less. The EDR in this vehicle is designed to record such data as:

- **How various systems in your vehicle were operating;**
- **Whether or not the driver and passenger safety belts were buckled/fastened;**
- **How far (if at all) the driver was depressing the accelerator and/or the brake pedal;**
- **How fast the vehicle was travelling;**
- **Where the driver was positioning the steering wheel.**

This data can help provide a better understanding of the circumstances in which crashes and injuries occur.

Note: EDR data is recorded by your vehicle only if a non-trivial crash situation occurs; no data is recorded by the EDR under normal driving conditions and no personal data or information (e.g., name, gender, age, and crash location) is recorded (see limitations regarding 911 Assist and Traffic, Directions and Information privacy below). However, parties, such as law enforcement, could combine the EDR data with the type of personally identifying data routinely acquired during a crash investigation.

To read data recorded by an EDR, special equipment is required, and access to the vehicle or the EDR is needed. In addition to the vehicle manufacturer, other parties, such as law enforcement, that have such special equipment, can read the information if they have access to the vehicle or the EDR. Ford Motor Company

and Ford of Canada do not access event data recorder information without obtaining consent, unless pursuant to court order or where required by law enforcement, other government authorities or other third parties acting with lawful authority. Other parties may seek to access the information independently of Ford Motor Company and Ford of Canada.

Note: Including to the extent that any law pertaining to Event Data Recorders applies to SYNC® or its features, please note the following: Once 911 Assist (if equipped) is enabled (set ON), 911 Assist may, through any paired and connected cell phone, disclose to emergency services that the vehicle has been in a crash involving the deployment of an airbag or, in certain vehicles, the activation of the fuel pump shut-off. Certain versions or updates to 911 Assist may also be capable of being used to electronically or verbally provide to 911 operators the vehicle location (such as latitude and longitude), and/or other details about the vehicle or crash or personal information about the occupants to assist 911 operators to provide the most appropriate emergency services. If you do not want to disclose this information, do not activate the 911 Assist feature. See your SYNC® chapter for more information.

Additionally, when you connect to Traffic, Directions and Information (if equipped, U.S. only), the service uses GPS technology and advanced vehicle sensors to collect the vehicle's current location, travel direction, and speed ("vehicle travel information"), only to help provide you with the directions, traffic reports, or business searches that you request. If you do not want Ford or its vendors to receive this information, do not activate the service. For more information, see Traffic, Directions and Information, Terms and Conditions. See your SYNC® chapter for more information.

CALIFORNIA PROPOSITION 65



WARNING: Some constituents of engine exhaust, certain vehicle components, certain fluids contained in vehicles and certain products of component wear contain or emit chemicals known to the State of California to cause cancer and birth defects or other reproductive harm.

PERCHLORATE MATERIAL

Note: Certain components in your vehicle, such as airbag modules, safety belt pretensioners, and remote control batteries, may contain perchlorate material. Special handling may apply for service or vehicle end of life disposal. See www.dtsc.ca.gov/hazardouswaste/perchlorate for more information.

LINCOLN AUTOMOTIVE FINANCIAL SERVICES (U.S. ONLY)

Lincoln Automotive Financial Services offers a full range of financing and lease plans to help you acquire your vehicle. If you have financed or leased your vehicle through Lincoln Automotive Financial Services, thank you for your business.

For your convenience we offer a number of ways to contact us, as well as help manage your account.

Phone: 1-888-498-8801

For more information regarding Lincoln Automotive Financial Services, as well as to access Account Manager, please go to www.LincolnAFS.com.

REPLACEMENT PARTS RECOMMENDATION

Your vehicle has been built to the highest standards using quality parts. We recommend that you demand the use of genuine Ford and Motorcraft parts whenever your vehicle requires scheduled maintenance or repair. You can clearly identify genuine Ford and Motorcraft parts by looking for the Ford, FoMoCo or Motorcraft branding on the parts or their packaging.

Scheduled Maintenance and Mechanical Repairs

One of the best ways for you to make sure that your vehicle provides years of service is to have it maintained in line with our recommendations using parts that conform to the specifications detailed in this owner's manual. Genuine Ford and Motorcraft parts meet or exceed these specifications.

Collision Repairs

We hope that you never experience a collision, but accidents do happen. Genuine Ford replacement collision parts meet our stringent requirements for fit, finish, structural integrity, corrosion protection and dent resistance. During vehicle development, we validate that these parts deliver the intended level of protection as a whole system. A great way to know for sure you are getting this level of protection is to use genuine Ford replacement collision parts.

Warranty on Replacement Parts

Genuine Ford and Motorcraft replacement parts are the only replacement parts that benefit from a Ford Warranty. Damage caused to your vehicle as a result of the failure of non-Ford parts may not be covered by the Ford Warranty. For additional information, see the terms and conditions of the Ford Warranty.

SPECIAL NOTICES**New Vehicle Limited Warranty**

For a detailed description of what is covered and what is not covered by your vehicle's New Vehicle Limited Warranty, see the warranty information that is provided to you along with your owner's manual.

Special Instructions

For your added safety, your vehicle is fitted with sophisticated electronic controls.



WARNING: Please read the *Supplementary Restraints System* chapter. Failure to follow the specific warnings and instructions could result in personal injury.



WARNING: Front seat mounted rear-facing child or infant seats should **NEVER** be placed in front of an active passenger airbag.

MOBILE COMMUNICATIONS EQUIPMENT

Using mobile communications equipment is becoming increasingly important in the conduct of business and personal affairs. However, you must not compromise your own or others' safety when using such equipment. Mobile communications can enhance personal safety and security when appropriately used, particularly in emergency situations. Safety must be paramount when using mobile communications equipment to avoid negating these benefits.

Mobile communication equipment includes, but is not limited to, cellular phones, pagers, portable email devices, text messaging devices and portable two-way radios.



WARNING: Driving while distracted can result in loss of vehicle control, crash and injury. We strongly recommend that you use extreme caution when using any device that may take your focus off the road. Your primary responsibility is the safe operation of your vehicle. We recommend against the use of any handheld device while driving and encourage the use of voice-operated systems when possible. Make sure you are aware of all applicable local laws that may affect the use of electronic devices while driving.

EXPORT UNIQUE (NON-UNITED STATES/CANADA) VEHICLE SPECIFIC INFORMATION

For your particular global region, your vehicle may be equipped with features and options that are different from the features and options that are described in this owner's manual. A market unique supplement may be supplied that complements this book. By referring to the market unique supplement, if provided, you can properly identify those features, recommendations and specifications that are unique to your vehicle. This owner's manual is written primarily for the U.S. and Canadian Markets. Features or equipment listed as standard may be different on units built for Export. **See this owner's manual for all other required information and warnings.**

GENERAL INFORMATION

See the following sections for directions on how to properly use safety restraints for children.



WARNING: Always make sure your child is secured properly in a device that is appropriate for their height, age and weight. Child safety restraints must be bought separately from your vehicle. Failure to follow these instructions and guidelines may result in an increased risk of serious injury or death to your child.



WARNING: All children are shaped differently. The recommendations for safety restraints are based on probable child height, age and weight thresholds from NHTSA and other safety organizations, or are the minimum requirements of law. Ford recommends checking with a NHTSA Certified Child Passenger Safety Technician (CPST) and consulting your pediatrician to make sure your child seat is appropriate for your child, and is compatible with and properly installed in your vehicle. To locate a child seat fitting station and CPST, contact the NHTSA toll free at 1-888-327-4236 or on the internet at <http://www.nhtsa.dot.gov>. In Canada, check with your local St. John Ambulance office for referral to a CPST or for further information, contact your provincial ministry of transportation, or locate your local St. John Ambulance office by searching for St. John Ambulance on the internet, or Transport Canada at 1-800-333-0371 (<http://www.tc.gc.ca>). Failure to properly restrain children in safety seats made especially for their height, age, and weight may result in an increased risk of serious injury or death to your child.

Recommendations for Safety Restraints for Children		
	Child size, height, weight, or age	Recommended restraint type
Infants or toddlers	Children weighing 40 lb (18 kg) or less (generally age four or younger).	Use a child safety seat (sometimes called an infant carrier, convertible seat, or toddler seat).
Small children	Children who have outgrown or no longer properly fit in a child safety seat (generally children who are less than 4 ft. 9 in. (1.45 m) tall, are greater than age four (4) and less than age twelve (12), and between 40 lb (18 kg) and 80 lb (36 kg) and upward to 100 lb (45 kg) if recommended by your child restraint manufacturer).	Use a belt-positioning booster seat.
Larger children	Children who have outgrown or no longer properly fit in a belt-positioning booster seat (generally children who are at least 4 ft. 9 in. (1.45 m) tall or greater than 80 lb (36 kg) or 100 lb (45 kg) if recommended by child restraint manufacturer).	Use a vehicle safety belt having the lap belt snug and low across the hips, shoulder belt centered across the shoulder and chest, and seat back upright.

- You are required by law to properly use safety seats for infants and toddlers in the United States and Canada.
- Many states and provinces require that small children use approved booster seats until they reach age eight, a height of 4 feet 9 inches (1.45 meters) tall, or 80 pounds (36 kilograms). Check your local and state or provincial laws for specific requirements about the safety of children in your vehicle.
- When possible, always properly restrain children twelve (12) years of age and under in a rear seating position of your vehicle. Accident statistics suggest that children are safer when properly restrained in

the rear seating positions than in a front seating position. See *Front Passenger Sensing System* in the *Supplementary Restraints System* chapter for more information.

CHILD SEAT POSITIONING



WARNING: Airbags can kill or injure a child in a child seat.

Never place a rear-facing child seat in front of an active airbag. If you must use a forward-facing child seat in the front seat, move the vehicle seat upon which the child seat is installed all the way back. When possible, all children age 12 and under should be properly restrained in a rear seating position. If all children cannot be seated and restrained properly in a rear seating position, properly restrain the largest child in the front seat.



WARNING: Always carefully follow the instructions and warnings provided by the manufacturer of any child restraint to determine if the restraint device is appropriate for your child's size, height, weight, or age. Follow the child restraint manufacturer's instructions and warnings provided for installation and use in conjunction with the instructions and warnings provided by your vehicle manufacturer. A safety seat that is improperly installed or utilized, is inappropriate for your child's height, age or weight, or does not properly fit the child, may increase the risk of serious injury or death.



WARNING: Never let a passenger hold a child on his or her lap while your vehicle is moving. The passenger cannot protect the child from injury in a crash, which may result in serious injury or death.



WARNING: Never use pillows, books, or towels to boost a child. They can slide around and increase the likelihood of injury or death in a crash.



WARNING: Always restrain an unoccupied child seat or booster seat. These objects may become projectiles in a crash or sudden stop, which may increase the risk of serious injury.

 **WARNING:** Never place, or allow a child to place, the shoulder belt under a child's arm or behind the back because it reduces the protection for the upper part of the body and may increase the risk of injury or death in a crash.

 **WARNING:** To avoid risk of injury, do not leave children or pets unattended in your vehicle.

Recommendations for attaching child safety restraints for children

Restraint Type	Combined weight of child and child seat	Use any attachment method as indicated below by X.				
		LATCH (lower anchors and top tether anchor)	LATCH (lower anchors only)	Safety belt and top tether anchor	Safety belt and LATCH (lower anchors and top tether anchor)	Safety belt only
Rear-facing child seat	Up to 65 lb (29.5 kg)		X			X
Rear-facing child seat	Over 65 lb (29.5 kg)					X
Forward-facing child seat	Up to 65 lb (29.5 kg)	X		X	X	
Forward-facing child seat	Over 65 lb (29.5 kg)			X	X	

Note: The child seat must rest tightly against the vehicle seat upon which it is installed. It may be necessary to lift or remove the head restraint. See the *Seats* chapter for information on head restraints.

BOOSTER SEATS

WARNING: Never place, or allow a child to place, the shoulder belt under a child's arm or behind the back because it reduces the protection for the upper part of the body and may increase the risk of injury or death in a crash.

Use a belt-positioning booster seat for children who have outgrown or no longer properly fit in a child safety seat (generally children who are less than 4 feet 9 inches (1.45 meters) tall, are greater than age four (4) and less than age twelve (12), and between 40 pounds (18 kilograms) and 80 pounds (36 kilograms) and upward to 100 pounds (45 kilograms) if recommended by your child restraint manufacturer). Many state and provincial laws require that children use approved booster seats until they reach age eight (8), a height of 4 feet 9 inches (1.45 meters) tall, or 80 pounds (36 kilograms).

Booster seats should be used until you can answer YES to ALL of these questions when the child is seated without a booster seat.

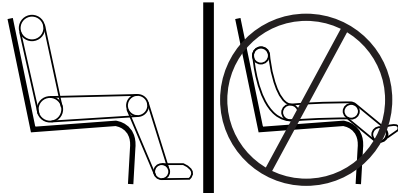

- Can the child sit all the way back against their vehicle seat with knees bent comfortably at the edge of the seat cushion?
- Can the child sit without slouching?
- Does the lap belt rest low across the hips?
- Is the shoulder belt centered on the shoulder and chest?
- Can the child stay seated like this for the whole trip?

Always use booster seats in conjunction with your vehicle lap and shoulder belt.

Types of Booster Seats

- Backless booster seats

If your backless booster seat has a removable shield, remove the shield. If a vehicle seating position has a low seatback or no head restraint, a backless booster seat may place your child's head (as measured at the tops of the ears) above the top of the seat. In this case, move the backless booster to another seating position with a higher seatback or head restraint and lap and shoulder belts, or consider using a high back booster seat.



- High back booster seats

If, with a backless booster seat, you cannot find a seating position that adequately supports your child's head, a high back booster seat would be a better choice.

Children and booster seats vary in size and shape. Choose a booster that keeps the lap belt low and snug across the hips, never up across the stomach, and lets you adjust the shoulder belt to cross the chest and rest snugly near the center of the shoulder. The following drawings compare the ideal fit (center) to a shoulder belt uncomfortably close to the neck and a shoulder belt that could slip off the shoulder. The drawings also show how the lap belt should be low and snug across the child's hips.

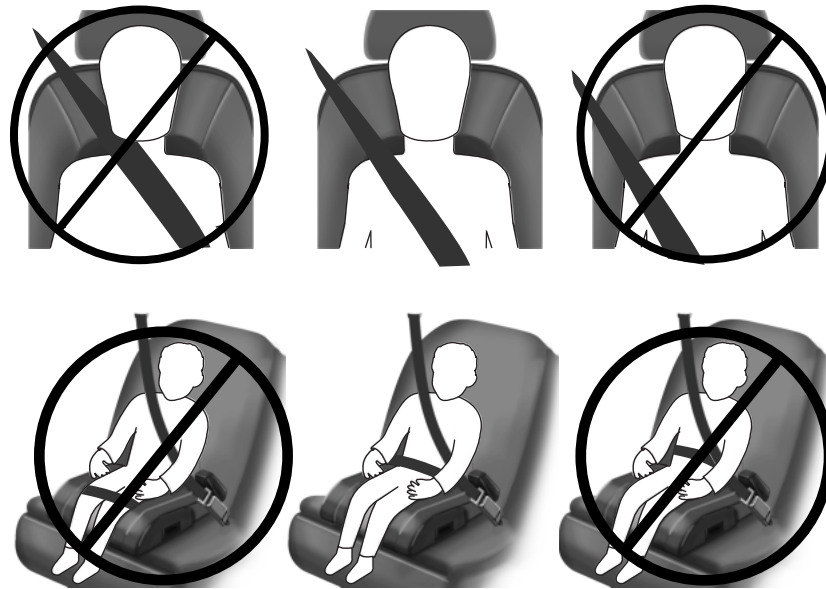

If the booster seat slides on the vehicle seat upon which it is being used, placing a rubberized mesh sold as shelf or carpet liner under the booster seat may improve this condition. Do not introduce any item thicker than this under the booster seat. Check with the booster seat manufacturer's instructions.

INSTALLING CHILD SEATS**Child Seats**

Use a child safety seat (sometimes called an infant carrier, convertible seat, or toddler seat) for infants, toddlers or children weighing 40 pounds (18 kilograms) or less (generally age four or younger).

Using Lap and Shoulder Belts

WARNING: Airbags can kill or injure a child in a child seat.

Never place a rear-facing child seat in front of an active airbag. If you must use a forward-facing child seat in the front seat, move the seat upon which the child seat is installed all the way back.



WARNING: Airbags can kill or injure a child in a child seat.

Children 12 and under should be properly restrained in the rear seat whenever possible.



WARNING: Depending on where you secure a child restraint, and depending on the child restraint design, you may block access to certain safety belt buckle assemblies or LATCH lower anchors, rendering those features potentially unusable. To avoid risk of injury, occupants should only use seating positions where they are able to be properly restrained.

When installing a child safety seat with combination lap and shoulder belts:

- Use the correct safety belt buckle for that seating position.
- Insert the belt tongue into the proper buckle until you hear a snap and feel it latch. Make sure the tongue is securely fastened in the buckle.

- Keep the buckle release button pointing up and away from the safety seat, with the tongue between the child seat and the release button, to prevent accidental unbuckling.
- Place the vehicle seat upon which the child seat will be installed in the upright position.
- Put the safety belt in the automatic locking mode. See Step 5. This vehicle does not require the use of a locking clip.

Perform the following steps when installing the child seat with combination lap and shoulder belts:

Note: Although the child seat illustrated is a forward-facing child seat, the steps are the same for installing a rear-facing child seat.



1. Position the child safety seat in a seat with a combination lap and shoulder belt.

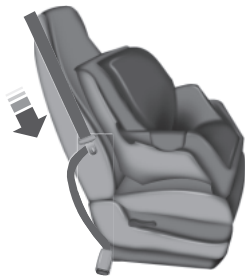

2. Pull down on the shoulder belt and then grasp the shoulder belt and lap belt together.

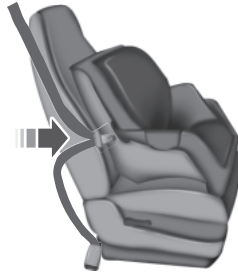

3. While holding the shoulder and lap belt portions together, route the tongue through the child seat according to the child seat manufacturer's instructions. Be sure the belt webbing is not twisted.

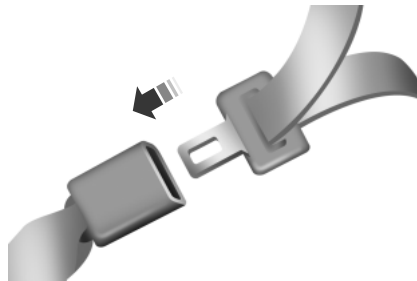

4. Insert the belt tongue into the proper buckle (the buckle closest to the direction the tongue is coming from) for that seating position until you hear a snap and feel the latch engage. Make sure the tongue is latched securely by pulling on it.



5. To put the retractor in the automatic locking mode, grasp the shoulder portion of the belt and pull downward until all of the belt is pulled out.

Note: The automatic locking mode is available on the front passenger and rear seats. This vehicle does not require the use of a locking clip.

6. Allow the belt to retract to remove slack. The belt will click as it retracts to indicate it is in the automatic locking mode.

7. Try to pull the belt out of the retractor to make sure the retractor is in the automatic locking mode. You should not be able to pull more belt out. If the retractor is not locked, unbuckle the belt and repeat Steps 5 and 6.

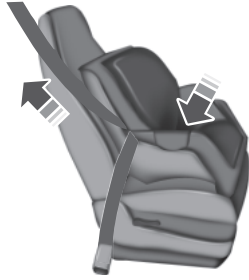

8. Remove remaining slack from the belt. Force the seat down with extra weight, for example, by pressing down or kneeling on the child restraint while pulling up on the shoulder belt in order to force slack from the belt.

This is necessary to remove the remaining slack that will exist once the extra weight of the child is added to the child restraint. It also helps to achieve the proper snugness of the child seat to your vehicle. Sometimes, a slight lean toward the buckle will provide extra help to remove remaining slack from the belt.

9. Attach the tether strap (if the child seat is equipped). See *Using Tether Straps* later in this chapter.

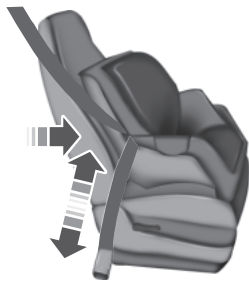



10. Before placing the child in the seat, forcibly move the seat forward and back to make sure the seat is securely held in place.

To check this, grab the seat at the belt path and attempt to move it side to side and forward and back. There should be no more than 1 inch (2.5 centimeters) of movement for proper installation.

Ford recommends checking with a NHTSA Certified Child Passenger Safety Technician to make certain the child restraint is properly installed. In Canada, check with your local St. John Ambulance office for referral to a Child Passenger Safety Technician.

Using Lower Anchors and Tethers for Children (LATCH)

 **WARNING:** Never attach two child safety seats to the same anchor. In a crash, one anchor may not be strong enough to hold two child safety seat attachments and may break, causing serious injury or death.

 **WARNING:** Depending on where you secure a child restraint, and depending on the child restraint design, you may block access to certain safety belt buckle assemblies or LATCH lower anchors, rendering those features potentially unusable. To avoid risk of injury, occupants should only use seating positions where they are able to be properly restrained.

The LATCH system is composed of three vehicle anchor points: two lower anchors located where your vehicle seatback and seat cushion meet (called the seat bight) and one top tether anchor located behind that seating position.

LATCH compatible child safety seats have two rigid or webbing mounted attachments that connect to the two lower anchors at the LATCH equipped seating positions in your vehicle. This type of attachment method eliminates the need to use safety belts to attach the child seat, however the safety belt can still be used to attach the child seat. For forward-facing child seats, the top tether strap must also be attached to the proper top tether anchor, if a top tether strap has been provided with your child seat.

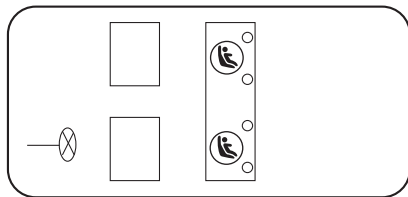

Your vehicle has LATCH lower anchors for child seat installation at the seating positions marked with the child seat symbol.

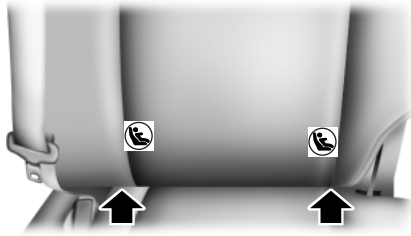

The LATCH anchors are located at the rear section of the rear seat between the cushion and seatback below the symbols as shown. Follow the child seat manufacturer's instructions to properly install a child seat with LATCH attachments.

Follow the instructions on attaching child safety seats with tether straps. See *Using Tether Straps* in this chapter.

Attach LATCH lower attachments of the child seat only to the anchors shown.

Use of Inboard Lower Anchors from the Outboard Seating Positions (Center Seating Use)



WARNING: The standardized spacing for LATCH lower anchors is 11 inches (28 centimeters) center to center. Do not use LATCH lower anchors for the center seating position unless the child seat manufacturer's instructions permit and specify using anchors spaced at least as far apart as those in this vehicle.

The lower anchors at the center of the second row rear seat are spaced 18 inches (46 centimeters) apart. A child seat with rigid LATCH attachments cannot be installed at the center seating position. LATCH compatible child seats (with attachments on belt webbing) can only be used at this seating position provided that the child seat manufacturer's instructions permit use with the anchor spacing stated. Do not attach a child seat to any lower anchor if an adjacent child seat is attached to that anchor.

Each time you use the safety seat, check that the seat is properly attached to the lower anchors and tether anchor, if applicable. Tug the child seat from side to side and forward and back where it is secured to your vehicle. The seat should move less than one inch when you do this for a proper installation.

If the safety seat is not anchored properly, the risk of a child being injured in a crash greatly increases.

Combining Safety Belt and LATCH Lower Anchors for Attaching Child Safety Seats

When used in combination, either the safety belt or the LATCH lower anchors may be attached first, provided a proper installation is achieved. Attach the tether strap afterward, if included with the child seat.

Using Tether Straps



Many forward-facing child safety seats include a tether strap which extends from the back of the child safety seat and hooks to an anchoring point called the top tether anchor. Tether straps are available as an accessory for many older safety seats.

Contact the manufacturer of your child seat for information about ordering a tether strap, or to obtain a longer tether strap if the tether strap on your safety seat does not reach the appropriate top tether anchor in your vehicle.

Once the child safety seat has been installed using either the safety belt, the lower anchors of the LATCH system, or both, you can attach the top tether strap.

The tether strap anchors in your vehicle are in the following positions (shown from top view):

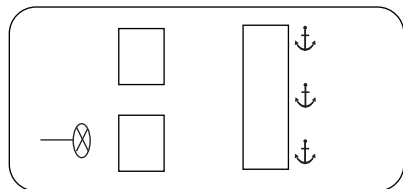

Perform the following steps to install a child safety seat with tether anchors:

Note: If you install a child seat with rigid LATCH attachments, do not tighten the tether strap enough to lift the child seat off your vehicle seat cushion when the child is seated in it. Keep the tether strap just snug without lifting the front of the child seat. Keeping the child seat just touching your vehicle seat gives the best protection in a severe crash.

1. Route the child safety seat tether strap over the back of the seat.

For outboard seating positions, route the tether strap under the head restraint and between the head restraint posts. For the center seating positions, route the tether strap over the top of the head restraint. If needed, the head restraints can also be removed.

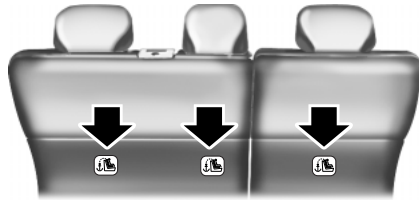

2. Locate the correct anchor behind the gap cover for the selected seating position.



3. Pull the gap cover to expose the anchors. Clip the tether strap to the anchor as shown.

4. Tighten the child safety seat tether strap according to the manufacturer's instructions.

If your child restraint system is equipped with a tether strap, and the child restraint manufacturer recommends its use, Ford also recommends its use.

CHILD SAFETY LOCKS

The childproof locks are located on the rear edge of each rear door and must be set separately for each door.

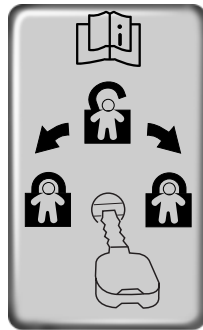

When these locks are set, the rear doors cannot be opened from the inside.

- Insert the key and turn to the lock position (key horizontal) to engage the childproof locks.
- Insert the key and turn to the unlock position (key vertical) to disengage the childproof locks.



PRINCIPLES OF OPERATION



WARNING: Never let a passenger hold a child on his or her lap while your vehicle is moving. The passenger cannot protect the child from injury in a crash, which may result in serious injury or death.



WARNING: Do not allow people to travel in any area of your vehicle that does not have seats and safety belts. Riding in a cargo area, inside or outside of the vehicle, is extremely dangerous. In a crash, people riding in these areas are more likely to be seriously injured or killed. Make sure everyone in your vehicle is in a seat and using a safety belt correctly. Failure to follow this warning could result in serious personal injury or death.



WARNING: Always drive and ride with your seatback upright and the lap belt snug and low across the hips.



WARNING: To reduce the risk of injury, make sure children sit where they can be properly restrained.



WARNING: All occupants of your vehicle, including the driver, should always properly wear their safety belts, even when an airbag supplemental restraint system is provided. Failure to properly wear your safety belt could seriously increase the risk of injury or death.



WARNING: In a rollover crash, an unbelted person is significantly more likely to die than a person wearing a safety belt.



WARNING: Each seating position in your vehicle has a specific safety belt assembly which is made up of one buckle and one tongue that are designed to be used as a pair. 1) Use the shoulder belt on the outside shoulder only. Never wear the shoulder belt under the arm. 2) Never swing the safety belt around your neck over the inside shoulder. 3) Never use a single belt for more than one person.



WARNING: When possible, all children 12 years old and under should be properly restrained in a rear seating position. Failure to follow this could seriously increase the risk of injury or death.





WARNING: Safety belts and seats can become hot in a vehicle that has been closed up in sunny weather; they could burn a small child. Check seat covers and buckles before you place a child anywhere near them.



WARNING: Front and rear seat occupants, including pregnant women, should wear safety belts for optimum protection in an accident.

All seating positions in your vehicle have lap and shoulder safety belts. All occupants of the vehicle should always properly wear their safety belts, even when an airbag supplemental restraint system is provided.

The safety belt system consists of:

- Lap and shoulder safety belts.
- Shoulder safety belt with automatic locking mode (except driver safety belt).
- Height adjuster at the front outboard seating positions.
- Safety belt pretensioner at the front outboard seating positions.
- Belt tension sensor at the front outboard passenger seating position.
-  • Safety belt warning light and chime. See *Safety belt warning light and indicator chime* later in this chapter.
-  • Crash sensors and monitoring system with readiness indicator. See *Crash sensors and airbag indicator* in the *Supplemental Restraint System* chapter.

The safety belt pretensioners are designed to activate in frontal, near-frontal and side crashes, and in rollovers. The safety belt pretensioners at the front seating positions are designed to tighten the safety belts firmly against the occupant's body when activated. This helps increase the effectiveness of the safety belts. In frontal crashes, the safety belt pretensioners can be activated alone or, if the crash is of sufficient severity, together with the front airbags.

FASTENING THE SAFETY BELTS

The front outboard and rear safety restraints in your vehicle are combination lap and shoulder belts.

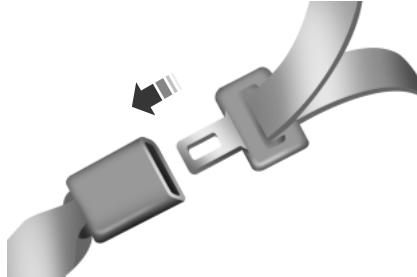

1. Insert the belt tongue into the proper buckle (the buckle closest to the direction the tongue is coming from) until you hear a snap and feel it latch. Make sure the tongue is securely fastened in the buckle.

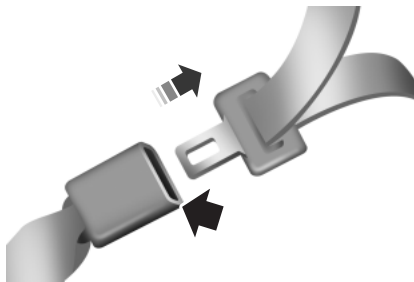

2. To unfasten, press the release button and remove the tongue from the buckle.

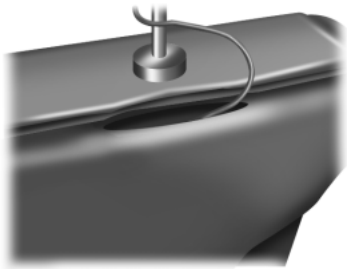

When in use, place the rear outboard safety belts in the comfort guides. These guides are attached to the head restraint and are stored in a pocket in the seat back.

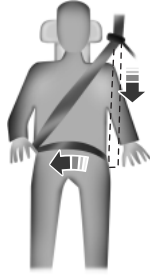

To adjust the comfort guide:

1. Slip the shoulder belt into the belt guide.
2. Slide the guide up or down along the webbing so that the belt is centered on the occupant's shoulder.

Using Safety Belts During Pregnancy

WARNING: Always ride and drive with your seatback upright and the safety belt properly fastened. The lap portion of the safety belt should fit snug and be positioned low across the hips. The shoulder portion of the safety belt should be positioned across the chest. Pregnant women should also follow this practice. See the following figure.

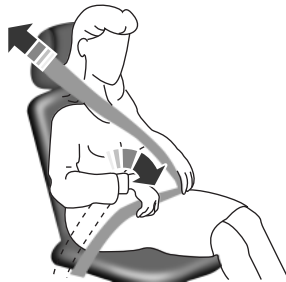

Pregnant women should always wear their safety belts. The lap belt portion of a combination lap and shoulder belt should be positioned low across the hips below the belly and worn as tight as comfort will allow. The shoulder belt should be positioned to cross the middle of the shoulder and the center of the chest.

Safety Belt Locking Modes

WARNING: After any vehicle crash, the safety belt system at all passenger seating positions must be checked by an authorized dealer to verify that the automatic locking retractor feature for child seats is still functioning properly. In addition, all safety belts should be checked for proper function.



WARNING: The belt and retractor assembly must be replaced if the safety belt assembly automatic locking retractor feature or any other safety belt function is not operating properly when checked by an authorized dealer. Failure to replace the belt and retractor assembly could increase the risk of injury in crashes.

All safety restraints in the vehicle are combination lap and shoulder belts. The driver safety belt has the first type of locking mode. The front outboard passenger and rear seat safety belts have both types of locking modes described as follows:

Vehicle Sensitive Mode

This is the normal retractor mode, which allows free shoulder belt length adjustment to your movements and locking in response to vehicle movement. For example, if the driver brakes suddenly or turns a corner sharply, or the vehicle receives an impact of about 5 mph (8 km/h) or more, the combination safety belts will lock to help reduce forward movement of the driver and passengers.

In addition, the retractor is designed to lock if the webbing is pulled out too quickly. If this occurs, let the belt retract slightly and pull webbing out again in a slow and controlled manner.

Automatic Locking Mode

In this mode, the shoulder belt is automatically pre-locked. The belt will still retract to remove any slack in the shoulder belt. The automatic locking mode is not available on the driver safety belt.

When to Use the Automatic Locking Mode

This mode should be used any time a child safety seat, except a booster, is installed in passenger front or rear seating positions. Children 12 years old and under should be properly restrained in a rear seating position whenever possible. See the *Child Safety* chapter.

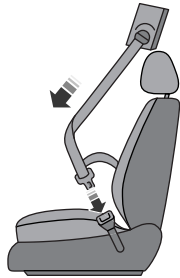
How to Use the Automatic Locking Mode

1. Buckle the combination lap and shoulder belt.
2. Grasp the shoulder portion and pull downward until the entire belt is pulled out.
3. Allow the belt to retract. As the belt retracts, you will hear a clicking sound. This indicates the safety belt is now in the automatic locking mode.

How to Disengage the Automatic Locking Mode

Unbuckle the combination lap and shoulder belt and allow it to retract completely to disengage the automatic locking mode and activate the vehicle sensitive (emergency) locking mode.

Safety Belt Extension Assembly

WARNING: Do not use extensions to change the fit of the shoulder belt across the torso.

If the safety belt is too short when fully extended, you can obtain a safety belt extension assembly from an authorized dealer.

Use only extensions manufactured by the same supplier as the safety belt. Manufacturer identification is on a label located either at the end of the webbing or on the retractor behind the trim. Also, use the safety belt extension only if the safety belt is too short for you when fully extended.

SAFETY BELT HEIGHT ADJUSTMENT

WARNING: Position the safety belt height adjusters so that the belt rests across the middle of your shoulder. Failure to adjust the safety belt properly could reduce the effectiveness of the seat belt and increase the risk of injury in a crash.



Adjust the height of the shoulder belt so the belt rests across the middle of your shoulder.

To adjust the shoulder belt height:

1. Pull on the center button and slide the height adjuster up or down.
2. Release the button and pull down on the height adjuster to make sure it is locked in place.

SAFETY BELT WARNING LIGHT AND INDICATOR CHIME



This lamp illuminates and an audible warning will sound if the driver's safety belt has not been fastened when the vehicle's ignition is turned on.

Conditions of Operation

If...	Then...
The driver safety belt is not buckled before the ignition switch is turned to the on position...	The safety belt warning light illuminates 1-2 minutes and the warning chime sounds 4-8 seconds.
The driver safety belt is buckled while the indicator light is illuminated and the warning chime is sounding...	The safety belt warning light and warning chime turn off.
The driver safety belt is buckled before the ignition switch is turned to the on position...	The safety belt warning light and indicator chime remain off.

SAFETY BELT-MINDER™

This feature supplements the safety belt warning function by providing additional reminders by intermittently sounding a chime and illuminating the safety belt warning light when the driver or front passenger seat is occupied and the safety belt is unbuckled.

The system uses information from the front passenger sensing system to determine if a front seat passenger is present and therefore potentially in need of a warning. To avoid activating the Belt-Minder feature for objects placed in the front passenger seat, warnings will only be given to front seat occupants as determined by the front passenger sensing system.

If the Belt-Minder warnings have expired (warnings for about five minutes) for one occupant (driver or front passenger), the other occupant can still activate the Belt-Minder feature.

If...	Then...
The driver and front passenger safety belts are buckled before the ignition switch is turned to the on position or less than 1-2 minutes have elapsed since the ignition switch has been turned to on...	The Belt-Minder feature will not activate.
The driver or front passenger safety belt is not buckled when the vehicle has reached at least 6 mph (9.7 km/h) and 1-2 minutes have elapsed since the ignition switch has been turned to on...	The Belt-Minder feature is activated - the safety belt warning light illuminates and the warning chime sounds for six seconds every 25 seconds, repeating for about five minutes or until the safety belts are buckled.
The driver or front passenger safety belt becomes unbuckled for about one minute while the vehicle is traveling at least 6 mph (9.7 km/h) and more than 1-2 minutes have elapsed since the ignition switch has been turned to on...	The Belt-Minder feature is activated - the safety belt warning light illuminates and the warning chime sounds for six seconds every 25 seconds, repeating for about five minutes or until the safety belts are buckled.

Deactivating and Activating the Belt-Minder™ Feature

WARNING: While the system allows you to deactivate it, this system is designed to improve your chances of being safely belted and surviving an accident. We recommend you leave the system activated for yourself and others who may use the vehicle. To reduce the risk of injury, do not deactivate or activate the system while driving the vehicle.

Note: The driver and front passenger warning are deactivated and activated independently. When deactivating or activating one seating position, do not buckle the other position as this will terminate the process.

Read Steps 1 - 4 thoroughly before proceeding with the programming procedure.

Before following the procedure, make sure that:

- The parking brake is set.
 - The transmission is in park (P).
 - The ignition is off.
 - The driver and front passenger safety belts are unbuckled.
1. Turn the ignition on. Do not start the engine.
 2. Wait until the safety belt warning light turns off (about 1–2 minutes).
 - Step 3 must be completed within 50 seconds after the safety belt warning light turns off.
 3. For the seating position being disabled, buckle then unbuckle the safety belt three times at a moderate speed, ending in the unbuckled state.
 - After Step 3, the safety belt warning light will be turned on for three seconds.
 4. Within about seven seconds of the light turning off, buckle then unbuckle the safety belt. The safety belt warning light will flash for confirmation.
 - This will disable the feature for that seating position if it is currently enabled.
 - This will enable the feature for that seating position if it is currently disabled.

One-time Belt-Minder™ Disable

If at any time the driver or front passenger quickly buckles then unbuckles the safety belt for that seating position, the system is disabled for the current ignition cycle. The feature will enable during the same ignition cycle if the occupant buckles and remains buckled for about 30 seconds. Confirmation is not given for the one-time disable.

CHILD RESTRAINT AND SAFETY BELT MAINTENANCE

Inspect the vehicle safety belts and child safety seat systems periodically to make sure they work properly and are not damaged. Inspect the vehicle and child seat safety belts to make sure there are no nicks, tears or cuts. Replace if necessary. All vehicle safety belt assemblies, including retractors, buckles, front safety belt buckle assemblies, buckle support assemblies (slide bar-if equipped), shoulder belt height adjusters (if equipped), shoulder belt guide on seat back (if equipped), child safety seat LATCH and tether anchors, and attaching hardware, should be inspected after a crash. Read the child restraint manufacturer's instructions for additional inspection and maintenance information specific to the child restraint.

Ford Motor Company recommends that all safety belt assemblies in use in vehicles involved in a crash be replaced. However, if the crash was minor and an authorized dealer finds that the belts do not show damage and continue to operate properly, they do not need to be replaced. Safety belt assemblies not in use during a crash should also be inspected and replaced if either damage or improper operation is noted.

For proper care of soiled safety belts, see *Cleaning the Interior* in the *Vehicle Care* chapter.

PERSONAL SAFETY SYSTEM™

The Personal Safety System provides an improved overall level of frontal crash protection to front seat occupants and is designed to help further reduce the risk of airbag-related injuries. The system is able to analyze different occupant conditions and crash severity before activating the appropriate safety devices to help better protect a range of occupants in a variety of frontal crash situations.

Your vehicle's Personal Safety System consists of:

- Driver and passenger dual-stage airbag supplemental restraints.
- Front outboard safety belts with pretensioners, energy management retractors (first row only), and safety belt usage sensors.
- Driver seat position sensor.
- Front passenger sensing system.
- Passenger airbag off and on indicator lamp.
- Front crash severity sensors.
- Restraints control module with impact and safing sensors.
- Restraint system warning light and backup tone.
- The electrical wiring for the airbags, crash sensor(s), safety belt pretensioners, front safety belt usage sensors, driver seat position sensor, front passenger sensing system, and indicator lights.

How Does the Personal Safety System Work?

The Personal Safety System can adapt the deployment strategy of your vehicle's safety devices according to crash severity and occupant conditions. A collection of crash and occupant sensors provides information to the restraints control module. During a crash, the restraints control module may activate the safety belt pretensioners and/or either one or both stages of the dual-stage airbag supplemental restraints based on crash severity and occupant conditions.

PRINCIPLES OF OPERATION

WARNING: Airbags do not inflate slowly or gently, and the risk of injury from a deploying airbag is the greatest close to the trim covering the airbag module.



WARNING: All occupants of your vehicle, including the driver, should always properly wear their safety belts, even when an airbag supplemental restraint system is provided. Failure to properly wear your safety belt could seriously increase the risk of injury or death.



WARNING: Airbags can kill or injure a child in a child seat. Always transport children 12 years old and under in the back seat and always properly use appropriate child restraints.



WARNING: Never place your arm over the airbag module, as a deploying airbag can result in serious arm fractures or other injuries.



WARNING: Airbags can kill or injure a child in a child seat. Never place a rear-facing child seat in front of an active airbag. If you must use a forward-facing child seat in the front seat, move the seat upon which the child seat is installed all the way back.



WARNING: Do not attempt to service, repair, or modify the airbag supplemental restraint systems or its fuses as you could be seriously injured or killed. Contact your authorized dealer as soon as possible.



WARNING: Several airbag system components get hot after inflation. Do not touch them after inflation as this may result in serious injury.



WARNING: If the airbag has deployed, the airbag will not function again and must be replaced immediately. If the airbag is not replaced, the unrepaired area will increase the risk of injury in a crash.

The airbags are a supplemental restraint system and are designed to work with the safety belts to help protect the driver and right front passenger from certain upper body injuries. Airbags do not inflate slowly; there is a risk of injury from a deploying airbag.

Note: You will hear a loud bang and see a cloud of harmless powdery residue if an airbag deploys. This is normal.

The airbags inflate and deflate rapidly upon activation. After airbag deployment, it is normal to notice a smoke-like, powdery residue or smell the burnt propellant. This may consist of cornstarch, talcum powder (to lubricate the bag) or sodium compounds (for example, baking soda) that result from the combustion process that inflates the airbag. Small amounts of sodium hydroxide may be present which may irritate the skin and eyes, but none of the residue is toxic.

While the system is designed to help reduce serious injuries, contact with a deploying airbag may also cause abrasions or swelling. Temporary hearing loss is also a possibility as a result of the noise associated with a deploying airbag. Because airbags must inflate rapidly and with considerable force, there is the risk of death or serious injuries, such as fractures, facial and eye injuries or internal injuries, particularly to occupants who are not properly restrained or are otherwise out of position at the time of airbag deployment. Thus, it is extremely important that occupants be properly restrained as far away from the airbag module as possible while maintaining vehicle control.

Routine maintenance of the airbags is not required.

SOS POST-CRASH ALERT SYSTEM™

The system flashes the turn signal lamps and sounds the horn (intermittently) in the event of a serious impact that deploys an airbag equipped on your vehicle, such as front, side, side curtain or Safety Canopy.

The horn and lamps will turn off when:

- You press the hazard control button.
- You press the panic button (if equipped) on the remote entry transmitter.
- Your vehicle runs out of power.

DRIVER AND PASSENGER AIRBAGS

 **WARNING:** Never place your arm or any objects over an airbag module. Placing your arm over a deploying airbag can result in serious arm fractures or other injuries. Objects placed on or over the airbag inflation area may cause those objects to be propelled by the airbag into your face and torso causing serious injury.

 **WARNING:** Airbags can kill or injure a child in a child seat. Never place a rear-facing child seat in front of an active airbag. If you must use a forward-facing child seat in the front seat, move the seat upon which the child seat is installed all the way back.

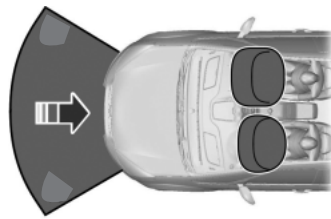

The driver and front passenger airbags will deploy during significant frontal and near-frontal crashes.

The driver and passenger front airbag system consists of:

- Driver and passenger airbag modules.
- Front passenger sensing system.
-  • Crash sensors and monitoring system with readiness indicator. See *Crash Sensors and Airbag Indicator* later in this chapter.

Proper Driver and Front Passenger Seating Adjustment

 **WARNING:** The National Highway Traffic Safety Administration recommends a minimum distance of at least 10 inches (25 centimeters) between an occupant's chest and the driver airbag module. Failure to follow this could seriously increase the risk of injury or death.

To properly position yourself away from the airbag:

- Move your seat to the rear as far as you can while still reaching the pedals comfortably.
- Recline the seat slightly (one or two degrees) from the upright position.

After all occupants have adjusted their seats and put on safety belts, it is very important that they continue to sit properly. Properly seated occupants sit upright, lean against the seat back, and center themselves on the seat cushion, with their feet comfortably extended on the floor. Sitting improperly can increase the chance of injury in a crash event. For example, if an occupant slouches, lies down, turns sideways, sits forward, leans forward or sideways, or puts one or both feet up, the chance of injury during a crash is greatly increased.

Children and Airbags

 **WARNING:** Airbags can kill or injure a child in a child seat. Never place a rear-facing child seat in front of an active airbag. If you must use a forward-facing child seat in the front seat, move the seat upon which the child seat is installed all the way back.





Children must always be properly restrained. Accident statistics suggest that children are safer when properly restrained in the rear seating positions than in the front seating position. Failure to follow these instructions may increase the risk of injury in a crash.

48 **Supplementary Restraints System**

FRONT PASSENGER SENSING SYSTEM

 **WARNING:** Even with Advanced Restraints Systems, children 12 and under should be properly restrained in a rear seating position. Failure to follow this could seriously increase the risk of injury or death.

 **WARNING:** Sitting improperly out of position or with the seat back reclined too far can take off weight from the seat cushion and affect the decision of the front passenger sensing system, resulting in serious injury or death in a crash.
Always sit upright against your seat back, with your feet on the floor.

 **WARNING:** To reduce the risk of possible serious injury:
Do not stow objects in seatback map pocket or hang objects off seatback if a child is in the front passenger seat.
Do not place objects underneath the front passenger seat or between the seat and the center console.
Check the passenger airbag indicator lamp for proper airbag status.
Failure to follow these instructions may interfere with the passenger seat sensing system.

 **WARNING:** Any alteration or modification to the front passenger seat may affect the performance of the front passenger sensing system which could seriously increase the risk of injury or death.

This system works with sensors that are part of the front passenger seat and safety belt to detect the presence of a properly-seated occupant and determine if the front passenger frontal airbag should be enabled (may inflate) or not.

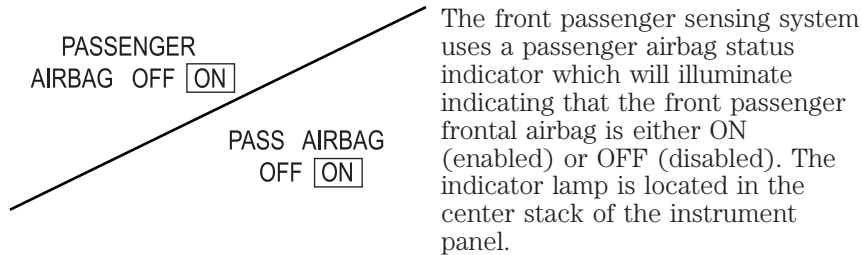

The front passenger sensing system uses a passenger airbag status indicator which will illuminate indicating that the front passenger frontal airbag is either ON (enabled) or OFF (disabled). The indicator lamp is located in the center stack of the instrument panel.

Note: When the ignition is first turned on, the passenger airbag status indicator OFF and ON lamps will illuminate for a short period of time to confirm it is functional.

The front passenger sensing system is designed to disable (will not inflate) the front passenger's frontal airbag when the front passenger seat is unoccupied, or a rear facing infant seat, a forward-facing child restraint, or a booster seat is detected. Even with this technology, parents are **strongly** encouraged to always properly restrain children in the rear seat. The front passenger sensing system also turns off the passenger front airbag and seat-mounted side airbag when the passenger seat is empty.

- When the front passenger sensing system disables (will not inflate) the front passenger frontal airbag, the passenger airbag status indicator will illuminate the OFF lamp and stay lit to remind you that the front passenger frontal airbag is disabled.
- If the child restraint has been installed and the passenger airbag status indicator illuminates the ON lamp, then turn the vehicle off, remove the child restraint from the vehicle and reinstall the restraint following the child restraint manufacturer's instructions.

The front passenger sensing system is designed to enable (may inflate) the front passenger frontal airbag anytime the system senses that a person of adult size is sitting properly in the front passenger seat.

- When the front passenger sensing system enables the front passenger frontal airbag (may inflate), the passenger airbag status indicator will illuminate the ON lamp and remain illuminated.

If a person of adult size is sitting in the front passenger seat, but the passenger airbag status indicator OFF lamp is lit, it is possible that the person is not sitting properly in the seat. If this happens:

- Turn the vehicle off and ask the person to place the seat back in the full upright position.
- Have the person sit upright in the seat, centered on the seat cushion, with the person's legs comfortably extended.

50 Supplementary Restraints System

- Restart the vehicle and have the person remain in this position for about two minutes. This will allow the system to detect that person and enable the passenger's frontal airbag.
- If the indicator OFF lamp remains lit even after this, the person should be advised to ride in the rear seat.

Occupant	Passenger airbag status indicator	Passenger airbag
Empty	OFF: Lit	Disabled
	ON: Unlit	
Child	OFF: Lit	Disabled
	ON: Unlit	
Adult	OFF: Unlit	Enabled
	ON: Lit	

Note: When the passenger airbag status indicator OFF lamp is illuminated, the passenger side airbag (seat mounted) may be disabled to avoid the risk of airbag deployment injuries.

After all occupants have adjusted their seats and put on safety belts, it is very important that they continue to sit properly. A properly seated occupant sits upright, leaning against the seatback, and centered on the seat cushion, with their feet comfortably extended on the floor. Sitting improperly can increase the chance of injury in a crash event. For example, if an occupant slouches, lies down, turns sideways, sits forward, leans forward or sideways, or puts one or both feet up, the chance of injury during a crash is greatly increased.

If you think that the state of the passenger airbag status indicator lamp is incorrect, check for the following:

- Objects lodged underneath the seat.
- Objects between the seat cushion and the center console.
- Objects hanging off the seatback.
- Objects stowed in the seatback map pocket.
- Objects placed on the occupant's lap.
- Cargo interference with the seat.
- Other passengers pushing or pulling on the seat.
- Rear passenger feet and knees resting or pushing on the seat.

The conditions listed above may cause the weight of a properly seated occupant to be incorrectly interpreted by the front passenger sensing system. The person in the front passenger seat may appear heavier or lighter due to the conditions described in the previous list.



Make sure the front passenger sensing system is operating properly. See *Crash Sensors and Airbag Indicator* later in this chapter.

If the airbag readiness light is lit, do the following:

The driver and adult passengers should check for objects lodged underneath the front passenger seat, or cargo interfering with the seat.

If there are lodged objects or cargo interfering with the seat, take the following steps to remove the obstruction:

- Pull the vehicle over.
- Turn the vehicle off.
- Driver and adult passengers should check for any objects lodged underneath the front passenger seat or cargo interfering with the seat.
- Remove the obstruction(s) (if found).
- Restart the vehicle.
- Wait at least two minutes and verify that the airbag readiness light in the instrument cluster is no longer illuminated.
- If the airbag readiness light in the instrument cluster remains illuminated, this may or may not be a problem due to the front passenger sensing system.

Do not attempt to repair or service the system. Take your vehicle immediately to an authorized dealer.

If it is necessary to modify an advanced front airbag system to accommodate a person with disabilities, contact the Ford Customer Relationship Center at the phone number shown in the *Customer Assistance* section of this owner's manual.

52 Supplementary Restraints System

SIDE AIRBAGS

 **WARNING:** Do not place objects or mount equipment on or near the airbag cover, on the side of the seatbacks (of the front seats), or in front seat areas that may come into contact with a deploying airbag. Failure to follow these instructions may increase the risk of personal injury in the event of a crash.

 **WARNING:** Do not use accessory seat covers. The use of accessory seat covers may prevent the deployment of the side airbags and increase the risk of injury in an accident.

 **WARNING:** Do not lean your head on the door. The side airbag could injure you as it deploys from the side of the seatback.

 **WARNING:** Do not attempt to service, repair, or modify the airbag, its fuses or the seat cover on a seat containing an airbag, as you could be seriously injured or killed. Contact your authorized dealer as soon as possible.

 **WARNING:** If the side airbag has deployed, the airbag will not function again. The side airbag system (including the seat) must be inspected and serviced by an authorized dealer. If the airbag is not replaced, the unrepaired area will increase the risk of injury in a crash.

The side airbags are located on the outboard side of the seat backs of the front seats. In certain sideways crashes, the airbag on the side affected by the crash will be inflated. The airbag was designed to inflate between the door panel and occupant to further enhance the protection provided occupants in side impact crashes.



The system consists of the following:

- A fabric tag or embossed letters in the plastic trim on the seat with the word AIRBAG.
- Side airbags located inside the seatback of the driver and front passenger seats.



- Crash sensors and monitoring system with readiness indicator. See *Crash Sensors and Airbag Indicator* later in this chapter.

- Front passenger sensing system.

Note: The passenger sensing system will deactivate the passenger seat-mounted side airbag if it detects an empty passenger seat.

The design and development of the side airbag system included recommended testing procedures that were developed by a group of automotive safety experts known as the Side Airbag Technical Working Group. These recommended testing procedures help reduce the risk of injuries related to the deployment of side airbags.

SAFETY CANOPY™ CURTAIN AIRBAGS



WARNING: Do not place objects or mount equipment on or near the headliner at the siderail that may come into contact with a deploying curtain airbag. Failure to follow these instructions may increase the risk of personal injury in the event of a crash.



WARNING: Do not lean your head on the door. The curtain airbag could injure you as it deploys from the headliner.



WARNING: Do not attempt to service, repair, or modify the curtain airbags, its fuses, the A, B, C or D pillar trim, or the headliner on a vehicle containing curtain airbags, as you could be seriously injured or killed. Contact your authorized dealer as soon as possible.



WARNING: All occupants of your vehicle including the driver should always wear their safety belts even when an airbag supplemental restraint system and curtain airbag is provided. Failure to properly wear your safety belt could seriously increase the risk of injury or death.



WARNING: To reduce risk of injury, do not obstruct or place objects in the deployment path of the curtain airbag.



WARNING: If the curtain airbags have deployed, the curtain airbags will not function again. The curtain airbags (including the A, B, C or D pillar trim and headliner) must be inspected and serviced by an authorized dealer. If the curtain airbag is not replaced, the unrepaired area will increase the risk of injury in a crash.

The Safety Canopy will deploy during significant side crashes or when a certain likelihood of a rollover event is detected by the rollover sensor. The Safety Canopy is mounted to the roof side-rail sheet metal, behind the headliner, above each row of seats. In certain sideways crashes or rollover events, the Safety Canopy will be activated, regardless of which seats are occupied. The Safety Canopy is designed to inflate between the side window area and occupants to further enhance protection provided in side impact crashes and rollover events.

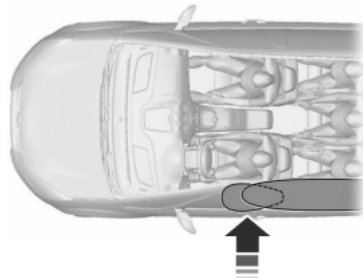

The system consists of:

- Safety canopy curtain airbags fitted above the trim panels over the front and rear side windows identified by a label or wording on the headliner or roof-pillar trim.
- A flexible headliner which opens above the side doors to allow air curtain deployment.
- Crash sensors and monitoring system with readiness indicator. See *Crash Sensors and Airbag Indicator* in this chapter.



Children 12 years old and under should always be properly restrained in the rear seats. The Safety Canopy will not interfere with children restrained using a properly installed child or booster seat because it is designed to inflate downward from the headliner above the doors along the side window opening.

The design and development of the Safety Canopy included recommended testing procedures that were developed by a group of automotive safety experts known as the Side Airbag Technical Working Group. These recommended testing procedures help reduce the risk of injuries related to the deployment of side airbags (including the Safety Canopy).

CRASH SENSORS AND AIRBAG INDICATOR



WARNING: Modifying or adding equipment to the front end of your vehicle (including frame, bumper, front end body structure and tow hooks) may affect the performance of the airbag system, increasing the risk of injury. Do not modify the front end of your vehicle.

Your vehicle has a collection of crash and occupant sensors which provide information to the restraints control module. The restraints control module deploys (activates) the front safety belt pretensioners, driver airbag, passenger airbag, seat mounted side airbags, and the Safety Canopy. Based on the type of accident (frontal impact, side impact or rollover) the restraints control module will deploy the appropriate safety devices.

The restraints control module also monitors the readiness of the above safety devices plus the crash and occupant sensors. The readiness of the safety system is indicated by a warning indicator light in the instrument cluster or by a backup tone if the warning light is not working. See the *Instrument Cluster* chapter. Routine maintenance of the airbag is not required.

A difficulty with the system is indicated by one or more of the following:



- The readiness light will either flash or stay lit.
- The readiness light will not illuminate immediately after the ignition is turned on.
- A series of five beeps will be heard. The tone pattern will repeat periodically until the problem or light are repaired.

56 **Supplementary Restraints System**

If any of these things happen, even intermittently, have the supplemental restraint system serviced at an authorized dealer immediately. Unless serviced, the system may not function properly in the event of a crash.

The safety belt pretensioners and the airbag supplemental restraint system are designed to activate when the vehicle sustains frontal or sideways deceleration sufficient to cause the restraints control module to deploy a safety device or when a certain likelihood of a rollover event is detected by the rollover sensor.

The fact that the safety belt pretensioners or airbags did not activate for both front seat occupants in a crash does not mean that something is wrong with the system. Rather, it means the restraints control module determined the accident conditions (such as crash severity, belt usage) were not appropriate to activate these safety devices.

- The design of the front airbags is to activate only in frontal and near-frontal crashes (not rollovers, side impacts or rear impacts) unless the crash causes sufficient frontal deceleration.
- The design of the safety belt pretensioners is to activate in frontal, near-frontal and side crashes, and in rollovers.
- The design of the side airbags is to inflate in certain side impact crashes. Side airbags may activate in other types of crashes if the vehicle experiences sufficient sideways motion or deformation.
- The design of the Safety Canopy is to inflate in certain side impact crashes or rollover events. The Safety Canopy may activate in other types of crashes if the vehicle experiences sufficient sideways motion or deformation, or a certain likelihood of rollover.

AIRBAG DISPOSAL

Contact your authorized dealer as soon as possible. Airbags must be disposed of by qualified personnel.

GENERAL INFORMATION ON RADIO FREQUENCIES

This device complies with part 15 of the FCC Rules and with Industry Canada license-exempt RSS standard(s). Operation is subject to the following two conditions: (1) This device may not cause harmful interference, and (2) This device must accept any interference received, including interference that may cause undesired operation.

Note: Changes or modifications not expressly approved by the party responsible for compliance could void the user's authority to operate the equipment. The term **IC** before the radio certification number only signifies that Industry Canada technical specifications were met.

The typical operating range for your transmitter is approximately 33 feet (10 meters). Vehicles with the remote start feature will have a greater range. A decrease in operating range could be caused by:

- weather conditions
- nearby radio towers
- structures around your vehicle
- other vehicles parked next to your vehicle.

The radio frequency used by your remote control can also be used by other short-distance radio transmissions, for example amateur radios, medical equipment, wireless headphones, remote controls and alarm systems. If the frequencies are jammed, you will not be able to use your remote control. You can lock and unlock the doors with the key.

Note: Make sure your vehicle is locked before leaving it unattended.

Note: If you are in range, the remote control will operate if you press any button unintentionally.

Intelligent Access

The system uses a radio frequency signal to communicate with your vehicle and authorize your vehicle to unlock when one of the following conditions is met:

- You touch the inside of the front exterior door handle.
- You press the luggage compartment button.
- You press a button on the transmitter.

If excessive radio frequency interference is present in the area or if the transmitter battery is low, it may be necessary to mechanically unlock your door. You can use the mechanical key blade in your intelligent access key to open the driver door in this situation. Refer to *Remote Control* in this chapter for more information on the location and use of the mechanical key blade.

REMOTE CONTROL**Intelligent Access Key**

Your intelligent access keys operate the power locks and the remote start system. The key must be in your vehicle to activate the push-button start system.

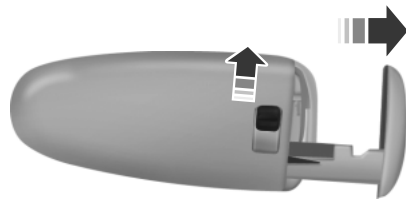

The intelligent access key also contains a removable mechanical key blade that you can use to unlock the driver door. Slide the release on the back of the transmitter to release the mechanical key blade, and then pull the blade out.



Note: Your vehicle's back-up keys came with a security tag that provides important vehicle key cut information. Keep the tag in a safe place for future reference.

Replacing the Battery

Note: Refer to local regulations when disposing of transmitter batteries.

Note: Do not wipe off any grease on the battery terminals or on the back surface of the circuit board.

Note: Replacing the battery will not delete the transmitter from your vehicle. The transmitter should operate normally.

The remote control uses one coin-type three-volt lithium battery CR2032 or equivalent.

Intelligent Access Transmitter

1. Remove the backup key from the transmitter.

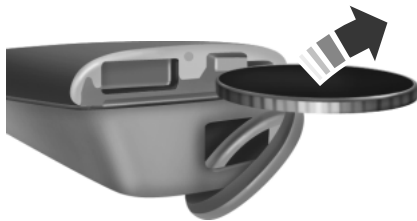

2. Twist a thin coin under the tab hidden behind the backup key head to remove the battery cover. Do not use the backup key to remove the cover or you could damage the intelligent access key.



3. Remove the old battery.

4. Insert a new battery with the **+** facing downward. Press the battery down to make sure it is fully in the housing.

5. Snap the battery cover back onto the transmitter and install the backup key.

Memory Feature

This feature allows you to recall the driver seat, power mirrors and power steering column memory positions.

Press the unlock button on the remote control or activate intelligent access to recall memory. The seat, power mirrors and steering column automatically move to the memory position. The mirrors will move to the programmed position and the seat will move to the easy entry position (if the easy entry feature is enabled). The seat will move to the final position when you switch the ignition on.

Programming to the Remote Control

1. Switch the ignition on.
2. Move the memory features to the desired positions using the associated controls.

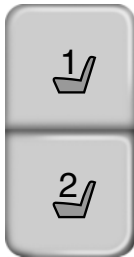

3. Press and hold memory button **1** for about five seconds. A tone will sound after about two seconds. Continue to hold until you hear a second tone.

4. Press the lock button on the remote control within three seconds.

Repeat this procedure with memory button **2** and a second transmitter if desired.

Deactivating from the Remote Control

1. Press and hold the desired memory button for five seconds. A tone will sound after about two seconds. Continue to hold until you hear a second tone.

2. Press the unlock button on the remote control within three seconds.

Repeat this procedure for each additional remote control if desired.

Car Finder



Press the button twice within three seconds. The horn will sound and the turn signals will flash. We recommend you use this method to locate your vehicle, rather than using the panic alarm.

Sounding a Panic Alarm



Press the button to activate the alarm. Press the button again or switch the ignition on to deactivate.

Note: The panic alarm will only operate when the ignition is off.

Remote Start



WARNING: To avoid exhaust fumes, do not use remote start if your vehicle is parked indoors or areas that are not well ventilated.

Note: Do not use remote start if your vehicle is low on fuel.



The remote start button is on the transmitter.

This feature allows you to start your vehicle from outside your vehicle. The transmitter has an extended operating range.

Vehicles with automatic climate control can be configured to operate when the vehicle is remote started. See the *Climate Control* chapter for more information. A manual climate control system will run at the setting it was set to when your vehicle was last turned off.

Many states and provinces have restrictions for the use of remote start. Check your local and state or provincial laws for specific requirements regarding remote start systems.

The remote start system will not work if:

- the ignition is on
- the alarm system is triggered
- you disable the feature
- the hood is open
- the transmission is not in **P**
- the vehicle battery voltage is too low
- the service engine soon light is on.

Remote Starting the Vehicle

Note: You must press each button within three seconds of each other. Your vehicle will not remote start and the horn will not sound if you do not follow this sequence.

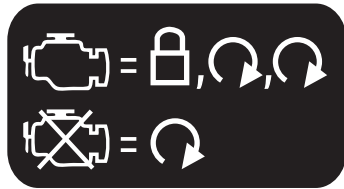

The label on your transmitter details the starting procedure.

To remote start your vehicle:

1. Press the lock button to lock all the doors.
2. Press the remote start button twice. The exterior lamps will flash twice.

The horn will sound if the system fails to start.

Note: If you remote start your vehicle you must have a programmed intelligent access key inside your vehicle and press the **START/STOP** button on the instrument panel once while applying the brake pedal before driving your vehicle.

The power windows will not work during the remote start and the radio will not turn on automatically.

The parking lamps will remain on and your vehicle will run for 5, 10, or 15 minutes, depending on the setting. See the *Information Displays* chapter to select the duration of the remote start system.

Extending the Vehicle Run Time

Repeat Steps 1 and 2 with your vehicle still running to extend the run time for another remote start duration. If the duration is set to last 10 minutes, the duration will extend by another 10 minutes beginning after what is left of the first activation time. For example, if your vehicle had been running from the first remote start for five minutes, your vehicle will continue to run now for a total of 15 minutes.

Wait at least five seconds before remote starting after a vehicle shutdown.

Turning the Vehicle Off After Remote Starting



Press the button once. The parking lamps will turn off.

You may have to be closer to your vehicle than when starting due to ground reflection and the added noise of the running vehicle.

You can disable or enable the remote start system through the information display. Refer to the *Information Display* chapter.

REPLACING A LOST KEY OR REMOTE CONTROL

You can purchase replacement or additional keys or remote controls from an authorized dealer. A dealer can program the transmitters to your vehicle or you may be able to program them yourself. See the *Security* chapter for information on programming your transmitters.

PRINCIPLES OF OPERATION

MyKey allows you to program keys with restricted driving modes to promote good driving habits. All but one of the keys programmed to the vehicle can be activated with these restricted modes.

Any keys that have not been programmed are referred to as administrator keys or admin keys. These can be used to:

- Create a MyKey.
- Program configurable MyKey settings.
- Clear all MyKey features.

When you have programmed a MyKey, you can access the following information using the information display:

- How many admin keys and MyKeys are programmed to your vehicle.
- The total distance your vehicle has traveled using a MyKey.

Note: All MyKeys are programmed to the same settings. You cannot program them individually.

Note: For vehicles with intelligent access (push-button start), when both a MyKey and an admin transmitter are present, the admin transmitter will be recognized to start the vehicle.

Non-configurable Settings

The following settings cannot be changed by an admin key user :

- Belt-minder. You cannot disable this feature. The audio system will mute when the front seat occupants' safety belts are not fastened.
- Early low fuel warning. The low fuel warning is activated earlier, giving the MyKey user more time to refuel.
- Driver assist features, if equipped on your vehicle, are forced on: parking aid, blind spot information system (BLIS) with cross traffic alert, lane departure warning and forward collision warning system.

Configurable Settings

With an admin key, you can configure certain MyKey settings when you first create a MyKey and before you recycle the key or restart the vehicle. You can also change the settings afterward with an admin key.

- A vehicle speed limit can be set. Warnings will be shown in the display followed by an audible tone when your vehicle reaches the set speed. You cannot override the set speed by fully depressing the accelerator pedal or by setting cruise control.

- Vehicle speed minders of 45, 55 or 65 mph (75, 90 or 105 km/h). Once you select a speed, it will be shown in the display, followed by an audible tone when the preselected vehicle speed is exceeded.
- Audio system maximum volume of 45%. A message will be shown in the display when you attempt to exceed the limited volume. Also, the speed-sensitive or compensated automatic volume control will be disabled.
- Always on setting. When this is selected, you will not be able to turn off AdvanceTrac (if your vehicle is equipped with this feature).

CREATING A MYKEY

Use the information display to create a MyKey:

1. Insert the key you want to program into the ignition. If your vehicle is equipped with a push-button start, put the intelligent access key in the backup slot. The location of your backup slot is in another chapter. See *Starting and Stopping the Engine*.
2. Switch the ignition on.
3. Access the main menu on the information display controls, and select **Settings**, then **MyKey** by pressing **OK** or the **>** button.
4. Press **OK** or the **>** button to select **Create MyKey**.
5. When prompted, hold the **OK** button until you see a message informing you to label this key as a MyKey. The key will be restricted at the next start.

MyKey is successfully created. Make sure you label it so you can distinguish it from the admin keys.

You can also program configurable settings for the key(s). See *Programming/Changing Configurable Settings*.

Programming/Changing Configurable Settings

Use the information display to access your configurable MyKey settings:

1. Switch the ignition on using an admin key. If your vehicle has push-button start, place the intelligent access key fob into the backup slot. The location of your backup slot is in another chapter. See *Starting and Stopping the Engine*.
2. Access the main menu and select **Settings**, then **MyKey** by pressing **OK** or the **>** button.
3. Use the arrow buttons to get to a configurable feature.
4. Press **OK** or **>** to scroll through settings.

5. Press **OK** or **>** to make a selection.

Note: You can clear or change your MyKey settings at any time during the same key cycle as you created the MyKey. Once you have switched the engine off, however, you will need an admin key to change or clear your MyKey settings.

CLEARING ALL MYKEYS

You can clear all MyKeys within the same key cycle as you created the MyKey. If you switch your ignition off, however, you will need to use an admin key to clear your MyKeys.

Note: When you clear your MyKeys, you remove all restrictions and return all MyKeys to their original admin key status at once.

To clear all MyKeys of all MyKey settings, use the information display to do the following:

1. Access the main menu and select **Settings**, then **MyKey**.
2. Scroll to **Clear All** and press the **OK** button.
3. Hold the **OK** button until **ALL MYKEYS CLEARED** displays .

CHECKING MYKEY SYSTEM STATUS

You can find information about your programmed MyKeys by using the information display.

MYKEY DISTANCE

Tracks the distance when drivers use a MyKey. The only way to delete the accumulated distance is by using an admin key to clear your MyKey. If the distance does not accumulate as expected, then the intended user is not using the MyKey, or an admin key user recently cleared and then recreated a MyKey.

NUMBER OF MYKEY(S)

Indicates the number of MyKeys programmed to your vehicle. Use this feature to detect how many MyKeys you have for your vehicle and determine when a MyKey has been deleted.

NUMBER OF ADMIN KEY(S)

Indicates how many admin keys are programmed to your vehicle. Use this feature to determine how many unrestricted keys you have for your vehicle, and detect if an additional MyKey has been programmed.

USING MYKEY WITH REMOTE START SYSTEMS

MyKey is not compatible with non-Ford-approved aftermarket remote start systems. If you choose to install a remote start system, please see your Ford authorized dealer for a Ford-approved remote start system.

MYKEY TROUBLESHOOTING

Condition	Potential causes
I cannot create a MyKey.	<ul style="list-style-type: none"> • The key or fob used to start the vehicle does not have admin privileges. • The key or fob used to start the vehicle is the only admin key (there always has to be at least one admin key). • Vehicles with push-button start: The intelligent access key is not in the backup slot. The backup slot location information is in another chapter. See <i>Starting and Stopping the Vehicle</i>. • SecuriLock passive anti-theft system is disabled or in unlimited mode.
I cannot program the configurable settings.	<ul style="list-style-type: none"> • The key or fob used to start the vehicle does not have admin privileges. • No MyKeys are created. See <i>Creating a MyKey</i>.
I cannot clear the MyKeys.	<ul style="list-style-type: none"> • The key or fob used to start the vehicle does not have admin privileges. • No MyKeys are created. Refer to <i>Creating a MyKey</i>.
I lost the only admin key.	<ul style="list-style-type: none"> • Purchase a new key from your authorized dealer.
I lost a key.	<ul style="list-style-type: none"> • Program a spare key. See <i>SecuriLock</i> in the <i>Security</i>.
No MyKey functions with intelligent access key (push- button start).	<ul style="list-style-type: none"> • An admin fob is present at engine start. • No MyKey has been created. See <i>Creating a MyKey</i>.
MyKey distances do not accumulate.	<ul style="list-style-type: none"> • The MyKey user is not using the MyKey. • An admin key holder cleared the MyKeys and created new MyKeys. • The key system has been reset.

LOCKING AND UNLOCKING

You can use the power door lock control or the remote control to lock and unlock your vehicle.

Power Door Locks

The power door lock control is located on the driver and front passenger door panels.

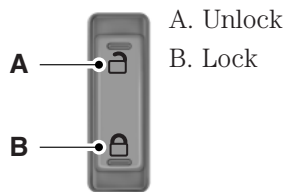

Remote Control

You can use the remote control anytime your vehicle is not running.

Unlocking the Doors (Two-Stage Unlock)



Press the button to unlock the driver doors.

Press the button again within three seconds to unlock all doors. The turn signals will flash.

Press and hold both the lock and unlock buttons on the remote control for four seconds to disable or enable two-stage unlocking. Disabling two-stage unlocking allows all vehicle doors to unlock with one press of the button. The turn signals will flash twice to indicate a change to the unlocking mode. The unlocking mode applies to the remote control, keyless entry keypad and intelligent access.

Intelligent access at the driver door unlocks all doors when two-stage unlocking is disabled.

Locking the Doors



Press the button to lock all the doors. The turn signals will illuminate.

Press the button again within three seconds to confirm that all the doors are closed. The doors will lock again, the horn will sound and the turn signals will illuminate if all the doors and the luggage compartment are closed.

Note: If any door or the luggage compartment is open, or if the hood is open on vehicles with an anti-theft alarm or remote start, the horn sounds twice and the lamps will not flash.

Power Liftgate



WARNING: Make sure all persons are clear of the liftgate area before using power liftgate control.



WARNING: Make sure to close and latch the liftgate to prevent drawing exhaust fumes into your vehicle. This will also prevent passengers and cargo from falling out. If you must drive with the liftgate open, keep the vents or windows open so outside air comes into your vehicle. Failure to follow this warning could result in serious personal injury.

Note: Be careful when opening or closing the liftgate in a garage or other enclosed area to avoid damaging the liftgate.



Press twice within three seconds to open or close the liftgate, or to reverse the movement.

Activating Intelligent Access

You must have the intelligent access key within 3 feet (1 meter) of your vehicle.

At the Front Doors

Pull a front exterior door handle to unlock and open the door. The unlock sensor is on the back of the handle. Make sure not to touch the lock sensor area on the front of the handle.

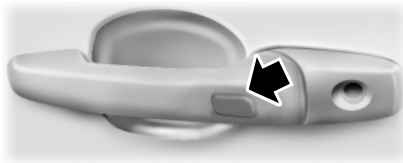

Press and hold the lock sensor area for about a second to lock your vehicle. To avoid unlocking the door inadvertently, make sure to only touch the lock sensor and not other areas of the door handle.

After locking the doors with the lock sensor, there is a brief delay before you can unlock your vehicle. This delay lets you pull the door handle to make sure it locked.

Note: Keep the door handle surface clean to avoid issues with operation.

At the Liftgate

Press the exterior liftgate release button on the top of the liftgate pull-cup handle.

Smart Unlocks

The smart unlock feature is intended to prevent you from unintentionally locking your intelligent access key inside your vehicle's passenger compartment or rear cargo area.

When you lock your vehicle using the driver or passenger power door lock control (with the door open, transmission is in **P** and ignition off), after you close the door your vehicle will search for an intelligent access key in the passenger compartment. If your vehicle finds a key, all of the doors will immediately unlock and the horn will sound, indicating that a key is inside.

You can override the smart unlock feature and intentionally lock the intelligent access key inside your vehicle. To do this, lock your vehicle after you have closed all the doors by:

- using the keyless entry keypad
- pressing the lock button on another intelligent access key
- touching the locking area on the handle with another intelligent access key in your hand.

When you open one of the front doors and lock your vehicle using the power door lock control, all doors will lock then unlock if:

- the ignition is on, or
- the ignition is off and the transmission is not in **P**.

Autolock Feature (If Enabled)

The autolock feature will lock all the doors when:

- all the doors are closed,
- the ignition is on,
- you shift into any gear putting your vehicle in motion, and
- your vehicle reaches a speed greater than 12 mph (20 km/h).

The autolock feature repeats when:

- you open then close any door while the ignition is on and the vehicle speed is 9 mph (15 km/h) or lower, and
- your vehicle then reaches a speed greater than 12 mph (20 km/h).

Autounlock Feature (If Enabled)

The autounlock feature unlocks all the doors when:

- the ignition is on, all the doors are closed, and your vehicle has been in motion at a speed greater than 12 mph (20 km/h);
- your vehicle has then come to a stop and you switch the off ignition or to accessory; and
- you open the driver door within 10 minutes of switching the ignition off or to accessory.

Note: The doors will not autounlock if you electronically lock your vehicle after you switch the ignition off and before you open the driver door.

Enabling or Disabling

Note: You can enable or disable the autolock and autounlock features independently of each other.

You can enable or disable these features:

- through an authorized dealer
- using the information display.

Illuminated Entry

The interior lamps and select exterior lamps illuminate when you use the intelligent access key or the keyless entry keypad to unlock your vehicle.

The system will turn off the lights if:

- you switch the ignition on
- you press the lock button on the remote control
- you lock your vehicle using the keyless entry keypad
- they have been on for 25 seconds.

The lights will not turn off if:

- you have turned them on with the dimmer control
- any door is open.

Illuminated Exit

The interior lamps and select exterior lamps illuminate when all doors are closed and the ignition is turned off.

The lights turn off if all the doors remain closed and:

- 25 seconds elapse
- you press the **START/STOP** button.

Battery Saver

If you leave the courtesy lamps, dome lamps or headlamps on, the battery saver shuts them off 10 minutes after you switch the ignition off.

Accessory Mode Battery Saver for Intelligent Access Keys

If you leave your vehicle in the run ignition state, it will shut off once it detects a certain amount of battery drain or after 45 minutes.

LIFTGATE

WARNING: Do not allow people to travel in any area of your vehicle that does not have seats and safety belts. Riding in a cargo area, inside or outside of the vehicle, is extremely dangerous. In a crash, people riding in these areas are more likely to be seriously injured or killed. Make sure everyone in your vehicle is in a seat and using a safety belt correctly. Failure to follow this warning could result in serious personal injury or death.

Power Liftgate

WARNING: Make sure all persons are clear of the power liftgate area before using the power liftgate control.



WARNING: Keep keys out of the reach of children. Do not allow children to operate the power liftgate, or to play near to an open or moving power liftgate.

Note: Cycling the ignition while the liftgate is power closing and is near the latch may cause the liftgate to reverse to full open position. Make sure you close the liftgate before operating or moving the vehicle, especially in an enclosure, like a garage or a parking structure. You could damage the liftgate or its components.

Note: Do not drive with the liftgate open without first disabling the power function and securing the liftgate to the vehicle.

Note: In case of operation in extreme cold -40°F (-40°C), or on extreme inclines, manual operation of the liftgate is suggested.

You can enable or disable the power liftgate using the information display. The remote control and instrument panel button will still operate the liftgate regardless of the setting.

Opening and Closing the Power Liftgate

Note: You can reverse the liftgate movement direction with a second press of the instrument panel button or the button on the liftgate, or a second double press of the transmitter button.

The liftgate will only operate with the vehicle in **P**.

Three tones will sound as the liftgate begins to power close. A single tone indicates a problem with the close request, caused by any of the following:

- The ignition is on and the transmission is not in **P**
- The battery voltage is below the minimum operating voltage
- The vehicle speed is at or above 3 mph (5 km/h)

If the liftgate reverses and starts to close after an open request, a fast continuous tone indicates excessive load on the gate or a possible strut failure. Have the system checked by an authorized dealer if you still have a fast tone after removing the load.



To open or close from the instrument panel: Press the instrument panel button.



To open or close with the remote control: Press the remote control button twice within three seconds.

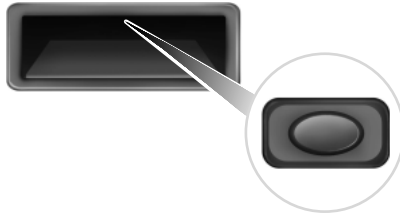

To open with the outside liftgate control button:

1. Unlock the liftgate with the remote control or power door unlock button. If an intelligent access transmitter is within 3 feet (1 meter) of the liftgate, the liftgate will unlock when you press the liftgate release button.
2. Press the control button located in the top of the liftgate pull-cup handle.

Note: Allow the power system to open the liftgate after pressing the control. Manually pushing or pulling the liftgate may activate the system's obstacle detection feature and stops the power operation.



To close with the rear cargo area control: Press and release the button.



WARNING: Keep clear of the liftgate when activating the rear switch.

Obstacle Detection

When closing: The system will reverse to full open when it detects an obstacle. A chime will sound three times as the liftgate begins to reopen. Remove the obstacle to close the liftgate.

Note: Entering your vehicle while the liftgate is closing can cause your vehicle to bounce and activate obstacle detection. To prevent this, let the power liftgate close completely before you enter your vehicle. Before driving off, check the instrument cluster for a liftgate or door ajar message or warning indicator. Failure to do this could result in unintentionally leaving the liftgate open while driving.

When opening: The system stops when it detects an obstacle and a tone will sound three times. Remove the obstacle to operate the liftgate.

Resetting the Power Liftgate

The liftgate may not operate properly and you may need to reset it if any of the following conditions occur:

- A low voltage or dead battery
- Disconnected battery
- The liftgate is manually closed and left ajar (unlatched)

To reset the power liftgate:

1. Disconnect the battery for 20 seconds then, reconnect the battery.
2. Manually close and fully latch the liftgate.
3. Power open the liftgate by using the remote control or the instrument panel button.

Manual Operation

WARNING: Make sure to close and latch the liftgate to prevent drawing exhaust fumes into your vehicle. This will also prevent passengers and cargo from falling out. If you must drive with the liftgate open, keep the vents or windows open so outside air comes into your vehicle. Failure to follow this warning could result in serious personal injury.

Note: Be careful when opening or closing the liftgate in a garage or other enclosed area to avoid damaging the liftgate.

Note: Do not hang anything, for example a bike rack, from the spoiler, glass or liftgate. This could damage the liftgate and its components.

Note: Do not leave the liftgate open while driving. This could damage to the liftgate and its components.

The liftgate area is only intended for cargo, not passengers.

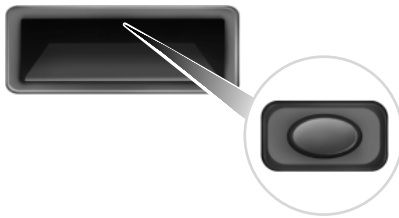

To open the liftgate: Press the button located in the top of the liftgate pull-cup handle to unlatch the liftgate, and then pull on the outside handle.

If the liftgate does not latch, you will receive a message in the information display. Check the liftgate to make sure it is completely closed.

If your vehicle has lost power, you can release the latch from inside your vehicle. Use the access panel on the liftgate trim.

SECURICODE™ KEYLESS ENTRY KEYPAD



You can use the keypad to:

- lock or unlock the doors
- recall memory features
- enable and disable autolock and autounlock
- program and erase user codes
- arm and disarm the anti-theft alarm.

The keypad can be operated with the factory-set 5-digit entry code; this code is located on the owner's wallet card in the glove box and is available from your authorized dealer. You can also create up to five of your own 5-digit personal entry codes.

Programming a Personal Entry Code

To create your own personal entry code:

1. Enter the factory-set code.
2. Press the **1•2** on the keypad within five seconds.
3. Enter your personal 5-digit code. You must enter each number within five seconds of each other.
4. For memory recall feature, enter the sixth digit **1•2** to store driver 1 settings or **3•4** to store driver 2 settings.

Note: Pressing **5•6**, **7•8**, or **9•0** keypad numbers as a sixth digit will not recall a driver memory setting.

Note: The factory-set code cannot be associated with a memory setting.

5. The doors will lock and then unlock to confirm that programming is complete.

You may also program a personal entry code through the MyFord Touch or MyLincoln Touch system. Refer to the *MyFord Touch* or *MyLincoln Touch* chapter.

Tips:

- Do not set a code that uses five of the same number.
- Do not use five numbers in sequential order.
- The factory-set code will work even if you have set your own personal code.

Erasing a Personal Code

1. Enter the factory-set 5-digit code.
2. Press and release **1•2** on the keypad within five seconds.
3. Press and hold **1•2** for two seconds. This must be done within five seconds of completing Step 2.

All personal codes are now erased and only the factory-set 5-digit code will work.

Anti-Scan Feature

The keypad will go into an anti-scan mode if you enter the wrong code seven times (35 consecutive button presses). This mode disables the keypad for one minute and the keypad lamp will flash.

The anti-scan feature will turn off after:

- one minute of keypad inactivity
- pressing the unlock button on the remote control
- switching the ignition on
- unlocking the vehicle using intelligent access.

Unlocking and Locking the Doors

To unlock the driver door: Enter the factory-set 5-digit code or your personal code. You must press each number within five seconds of each other. The interior lamps will illuminate. **Note:** All doors will unlock if the two-stage unlocking feature is disabled. Refer to *Locking and Unlocking* earlier in this chapter.

To unlock all doors: Enter the factory-set code or your personal code, then press **3•4** within five seconds.

To lock all doors: Press and hold **7•8** and **9•0** at the same time with the driver door closed. You do not need to enter the keypad code first.

SECURILOCK® PASSIVE ANTI-THEFT SYSTEM

Note: The system is not compatible with non-Ford aftermarket remote start systems. Use of these systems may result in vehicle starting problems and a loss of security protection.

Note: Metallic objects, electronic devices or a second coded key on the same key chain may cause vehicle starting issues if they are too close to the key when starting your vehicle. Prevent these objects from touching the coded key while starting the engine. Switch the ignition off, move all objects on the key chain away from the coded key and restart your vehicle if a problem occurs.

Note: Do not leave a duplicate coded key in your vehicle. Always take your keys and lock all doors when leaving your vehicle.

The system helps prevent the engine from starting unless you use a coded key programmed to your vehicle. Using the wrong key may prevent your vehicle from starting. A message may appear in the information display.

If you are unable to start your vehicle with a correctly coded key, a malfunction has occurred. A message may appear in the information display.

Automatic Arming

Your vehicle arms immediately after you switch the ignition off.

Automatic Disarming

Your vehicle disarms when you switch the ignition on with a coded key.

Replacement Keys

Note: Your vehicle comes with two intelligent access keys.

The intelligent access key functions as a programmed key that operates the driver door lock and activates the intelligent access with push button start systems, as well as a remote control.

If your intelligent access key is lost or stolen and you do not have an extra coded key, you will need to have your vehicle towed to an authorized dealer. The key codes need to be erased from your vehicle and new coded keys will need to be programmed.

Store an extra programmed key away from your vehicle in a safe place to help prevent any inconveniences. See an authorized dealer to purchase additional spare or replacement keys.

Programming a Spare Intelligent Access Key

Note: A maximum of four intelligent access keys can be programmed to your vehicle. You must take your vehicle and all access keys to your authorized dealer to be erased and reprogrammed if you would like to replace a previously programmed access key with a new access key, or if you already have four access keys programmed to your vehicle.

You must have two previously programmed intelligent access keys inside the vehicle and the new unprogrammed intelligent access keys readily accessible. See your authorized dealer to have the spare key programmed if two previously programmed keys are not available.

Make sure that the vehicle is off before beginning this procedure. Make sure that all doors are closed before beginning and that they remain closed throughout the procedure. Perform all steps within 30 seconds of starting the sequence. Stop and wait for at least one minute before starting again if any steps are performed out of sequence.

Read and understand the entire procedure before you begin.



1. Place the new unprogrammed intelligent access key, with the buttons facing down, in the pocket inside of the center console.
2. Press the driver or passenger power door unlock control three times.
3. Press and release the brake pedal one time.
4. Press the driver or passenger power door lock control three times.
5. Press and release the brake pedal one time. The indicator on the **START/STOP** button should begin to rapidly flash, indicating the programming mode has been entered and two programmed intelligent access keys have been detected in the vehicle.
6. Press the **START/STOP** button within one minute. A message will appear in the information display indicating that the new intelligent access key was programmed.
7. Remove the intelligent access key from the center console pocket and press the unlock button on the newly programmed intelligent access key to exit programming mode.

8. Verify that the remote entry functions operate (press lock then unlock, making sure you end in unlock) and that the vehicle starts with new intelligent access key.

ANTI-THEFT ALARM

The system will warn you of unauthorized entry to your vehicle.

The turn signal lamps will flash and sound the horn up to a total of 10 times when:

- any door, the hood or the luggage compartment is opened without using the keypad, the remote control or the intelligent access transmitter
- the ignition is turned on with an invalid key.

Take all keys and remote controls to an authorized dealer if there is any potential alarm problem with your vehicle.

Arming the Alarm

The system is ready to arm whenever the ignition is off. Lock your vehicle to arm the alarm.

The turn signal lamps will flash once after locking your vehicle to indicate the alarm is in the pre-armed mode. It will become fully armed in 20 seconds.

Disarming the Alarm

To disarm the alarm, do any of the following:

- Press the power door unlock button within the 20-second pre-armed mode will.
- Press the unlock button on the remote control.
- Unlock the doors with the keyless entry pad.
- Enter your vehicle using intelligent access.
- Press the panic button on the remote control. The alarm system will still be armed, but this shuts off the horn and turn lamps when the alarm is sounding.

Note: If the driver door is unlocked with a key, a tone will sound when you open the door and a message will appear in the information display. You will have 12 seconds to disarm the alarm using any of the actions above, otherwise the alarm will trigger.

ADJUSTING THE STEERING WHEEL

WARNING: Do not adjust the steering wheel when your vehicle is moving.

Note: Make sure that you are sitting in the correct position. See *Sitting in the Correct Position* in the *Seats* chapter.

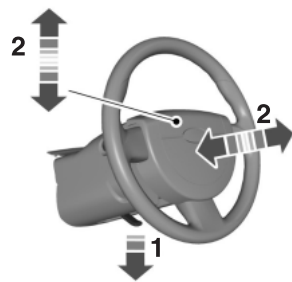

1. Unlock the steering column.
2. Adjust the steering wheel to the desired position.



3. Lock the steering column.

Power Tilt and Telescope Steering Column (If Equipped)

WARNING: Do not adjust the steering wheel when your vehicle is moving.

Note: Make sure that you are sitting in the correct position. Refer to *Sitting in the Correct Position* in the *Seats* chapter.



Use the control on the side of the steering column to adjust the position.

To adjust:

- tilt: press the top or bottom of the control
- telescope: press the front or rear of the control.

Easy Entry and Exit Feature

When you switch the ignition off, the steering column will move to the full up and forward position to allow extra room to exit your vehicle. The column will return to the previous setting when you switch the ignition on. You can enable or disable this feature in the information display. See *General Information* in the *Information Displays* chapter.

Memory Feature

You can save and recall the steering column position with the memory function. Refer to the *Seats* chapter.

Pressing the adjustment control during memory recall cancels the operation. The column responds to the adjustment control.

The steering column sets a stopping position just short of the end of the column position to prevent damage to the steering column. A new stopping position sets if the steering column encounters an object when tilting or telescoping.

To reset the steering column to its normal stopping position:

1. Press the steering column control again after encountering the new stopping position.
2. Continue pressing the control until it reaches the end of the column position.

A new stopping position is set. The next time you tilt or telescope the steering column, it will stop just short of the end of the column position.

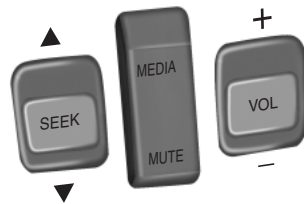
AUDIO CONTROL

SEEK: Press to select the next or previous stored preset or track. Press and hold to select the next or previous frequency or seek through a track.

MEDIA: Press repeatedly to scroll through available audio modes.

MUTE: Press to silence the radio.

VOL (Volume): Press to increase or decrease the volume.

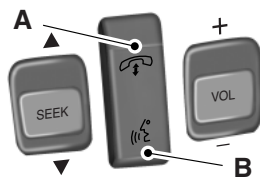
VOICE CONTROL (IF EQUIPPED)

A. Phone mode

B. Voice recognition

See the *MyLincoln Touch* chapter.

CRUISE CONTROL

Type 1

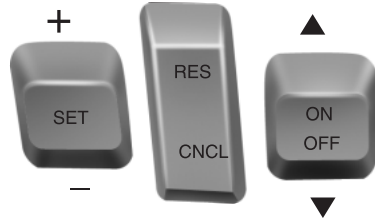

Type 2

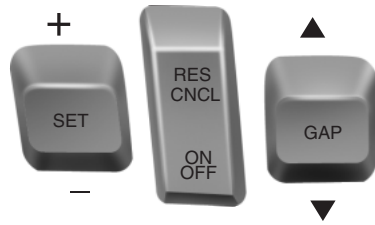

See the *Cruise Control* chapter for information on this feature.

INFORMATION DISPLAY CONTROL



See the *Information Displays* chapter for more information.

Cluster Display Control Features

Use this control to adjust the right side of the cluster display. Navigate through the screen and press **OK** to select. See the *MyLincoln Touch* chapter.

HEATED STEERING WHEEL (IF EQUIPPED)

See the *MyLincoln Touch* chapter.

WINDSHIELD WIPERS

Note: Fully defrost the windshield in icy conditions before turning on the windshield wipers.

Note: Make sure the windshield wipers are switched off before entering a car wash.

Note: Clean the windshield and wiper blades if they begin to leave streaks or smears. If that does not resolve the issue, install new wiper blades.

Note: Do not operate the wipers on a dry windshield. This may scratch the glass, damage the wiper blades or cause the wiper motor to burn out. Always use the windshield washers before wiping a dry windshield.

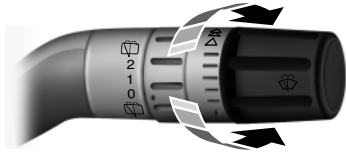

Rotate the end of the control away from you to increase the speed of the wipers. Rotate toward you to decrease the speed of the wipers.

Press the stalk down and release for a single swipe of the wipers.

Speed-dependent Wipers (If Equipped)

When your vehicle speed increases, the interval between wipes will decrease when intermittent wipe is selected.

RAIN-SENSING WIPERS (IF EQUIPPED)

Note: Wet road conditions may result in inconsistent or unexpected wiping or smearing. Lower the sensitivity, switch to normal or high-speed wiping or turn the wipers off to reduce smearing.

Note: Turn off the wipers before entering a car wash.

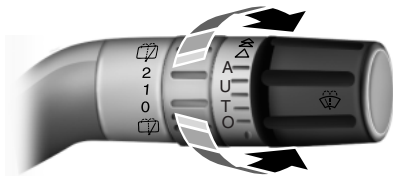

Use the rotary control to adjust the sensitivity to one of the interval moisture settings. The wipers will not cycle until moisture is detected on the windshield. The wiper speed will vary based on the amount of moisture detected on the windshield and the sensitivity setting. The

wipers will continue to wipe as long as moisture is detected.

This feature can be turned on or off using the information display.

Keep the outside of the windshield clean, especially the area around the interior mirror where the sensor is located, or sensor performance may be affected.

WINDSHIELD WASHERS

Note: Do not operate the wipers on a dry windshield. This may scratch the glass, damage the wiper blades or cause the wiper motor to burn out. Always use the windshield washer before wiping a dry windshield.

Note: Do not operate the washer when the washer reservoir is empty. This may cause the washer pump to overheat.



Press the end of the stalk to activate the washer.

- A brief press causes the wipers to swipe three times with washer fluid.
- A long press and hold will activate the wipers and washer fluid for up to 10 seconds.

A wipe will occur a few seconds after washing to clear any remaining washer fluid. This feature can be turned on and off in the information display.

REAR-WINDOW WIPER AND WASHERS



Rotate the control to select:

2 — Intermittent operation (shortest pause between wipes).

1 — Intermittent operation (longest pause between wipes).

0 — Off.

Rotate and hold the control to either the top or bottom position to activate the rear washer. The control will return to the **2** or **0** position when you release it.

LIGHTING CONTROL

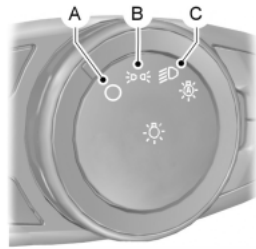

- A. Off
- B. Parking lamps, instrument panel lamps, license plate lamps and tail lamps
- C. Headlamps

High Beams



Push the lever forward to switch the high beams on.

Push the lever forward again or pull the lever toward you to switch the high beams off.

Headlamp Flasher



• Pull toward you slightly to activate and release to deactivate.

AUTOLAMPS



WARNING: In severe weather conditions, it may be necessary to switch your headlamps on manually.

Note: If the vehicle is equipped with autolamps, it will have the *windshield wiper rainlamp feature*. When the windshield wipers are turned to low- or high-speed wiping during daylight, and the headlamp control is in the autolamp position, the exterior lamps will turn on after a brief delay and will remain on until the wipers are turned off.



The autolamp system provides light sensitive automatic on-off control of the exterior lights normally controlled by the headlamp control.

The headlamps will remain on for a period of time after you switch the ignition off. You can adjust the time delay using the message center in the instrument cluster. See *Information displays*.

INSTRUMENT LIGHTING DIMMER

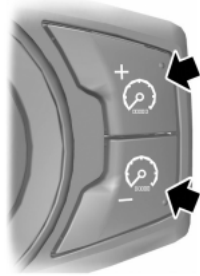

Press repeatedly or press and hold until the desired level is reached.

Note: In the uplevel message center only, a message will pop up that will show incrementally where the dimmer is in relation to the dimming steps. These steps will also vary for daytime and night time dimming.

Note: If the battery is disconnected, discharged, or a new battery is installed, the dimmer will set the illuminated components to the maximum setting automatically.

HEADLAMP EXIT DELAY

You can set the delay time to keep the headlamps on for up to three minutes after the ignition is turned off.

Follow the steps below to change the delay time (Steps 1 through 6 must be done within 10 seconds):

1. Turn the ignition off.
2. Turn the lighting control to the autolamp position.
3. Turn the lighting control to the off position.
4. Turn the ignition on.
5. Turn the ignition off.
6. Turn the lighting control to the autolamp position. The headlamps and parking lamps will turn on.

7. Turn the lighting control to the off position when the desired delay time has been reached. The headlamps and parking lamps will turn off. You can set the headlamp exit delay to one of the following settings:

- Off
- 10 seconds
- 20 seconds
- 120 seconds

Note: You can also adjust the time delay using the display controls in the instrument cluster. See the *Information Displays* chapter.

DAYTIME RUNNING LAMPS (IF EQUIPPED)



WARNING: Always remember to turn on your headlamps at dusk or during inclement weather. The Daytime Running Lamp (DRL) system does not activate the tail lamps and generally may not provide adequate lighting during these conditions. Failure to activate your headlamps under these conditions may result in a collision.

The system switches the headlamps on with a reduced output (vehicles equipped with halogen headlamps) or turns the front fog lamps on (vehicles equipped with HID headlamps).

To switch the system on:

1. Switch the ignition on.
2. Switch the lighting control to the off, autolamp or parking lamp position.
3. Make sure the transmission selector lever is not in position P.
4. Make sure the parking brake is disengaged.

FRONT FOG LAMPS

The fog lamps can be turned on when the lighting control is in the headlamps, parking lamps or autolamps positions and the high beams are not turned on.

ADAPTIVE HEADLAMPS (if equipped)

The headlamp beams move in the same direction as the steering wheel which provides more visibility when driving around curves.

A. Without adaptive headlamps

B. With adaptive headlamps

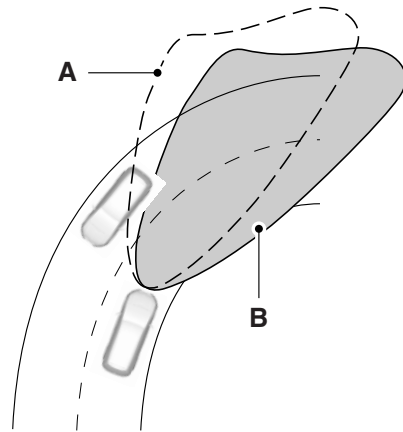

The system will only work with the lighting control switch in the autolamp position.



Note: There is a delay of two to five seconds before the adaptive headlamp system will operate when the vehicle is driven.

Note: The system is only active at speeds above 3 mph (5 km/h).

Note: The system has a power-up movement check feature. When the vehicle is started, the lamps track left to right, then back to center to alert the driver that the system is working properly.

DIRECTION INDICATORS

The turn signal lever does not mechanically lock in the upward or downward position when activated. The turn signal control activation and cancellation is electronic.



- Push down to activate the left turn signal.
- Push up to activate the right turn signal.
- Push the lever again in either direction to manually cancel turn signal operation.

Note: Tap the lever up or down to make the direction indicators flash only three times to indicate a lane change.

INTERIOR LAMPS**Dome Lamp Control****Without fog lamps****With fog lamps**

Use to manually turn the dome lamp on.

- Press the control. This will turn on the interior courtesy lights. The lights will remain on until the control is pressed again.

Front Row Map Lamps (If Equipped)

To turn on the map lamps, press the outer edge of the clear lens. The front row map lamp lights when:

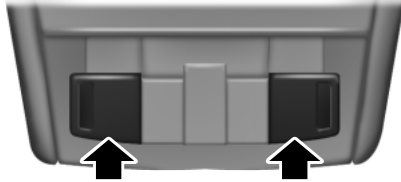

- any door is opened.
- the dome lamp button on the instrument panel is activated.
- the remote entry controls are pressed and the ignition is off.

Map/dome lamp (if equipped)

The dome lamp lights when:

- any door is opened.
- the dome lamp button on the instrument panel is activated.
- any of the remote entry controls are pressed and the ignition is off.

The map lamps are activated by pressing the controls on either side of the lens.

Rear courtesy lamp

Located in the rear cargo area, the courtesy lamp lights when:

- any door is opened.
- any of the remote entry controls are pressed and the ignition is off.

POWER WINDOWS

WARNING: Do not leave children unattended in your vehicle and do not let children play with the power windows. They may seriously injure themselves.



WARNING: When closing the power windows, you should verify they are free of obstructions and make sure that children and pets are not in the proximity of the window openings.

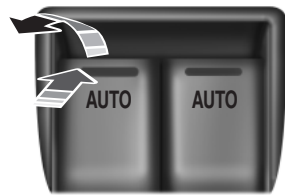

Press or lift the switches to operate the windows.

- Press the switch to the first detent and hold to open the window.
- Lift the switch to the first detent and hold to close the window.

Rear Window Buffeting

You may hear a pulsing noise when one or both of the rear windows are open. This noise can be reduced by lowering a front window approximately 2–3 inches (5–8 centimeters).

One-Touch Up or Down (Front Windows)

This feature automatically opens or closes the window.

Press or lift the switch completely and release. The window will fully open or close. Press or lift it again to stop the window.

Global Opening

Note: The ignition must be off and the accessory delay feature must not be activated to operate this feature.

Press and hold the unlock button on the remote control to begin opening the front windows and venting the moonroof (if equipped). Release the button once motion starts. The windows and moonroof will continue opening.

Press the lock or unlock button on the remote control to stop motion.

Bounce-Back

The window will stop automatically while closing and reverse some distance if there is an obstacle in the way.

Overriding the Bounce-Back Feature

 **WARNING:** When you override the bounce-back feature the window will not reverse if it detects an obstacle. Take care when closing the windows to avoid personal injury or damage to your vehicle.

Pull up the window switch and hold within two seconds of the window reaching the bounce-back position. The window will travel up with no bounce-back protection. The window will stop if you release the switch before the window is fully closed.

Accessory Delay

You can use the window switches for several minutes after you switch the ignition off, or until you open either front door.

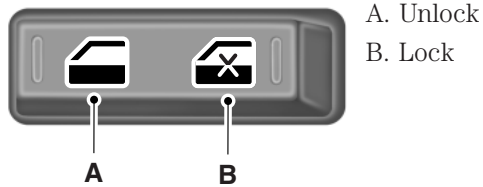
Window Lock

Press the control to lock or unlock the rear window controls.

EXTERIOR MIRRORS**Power Exterior Mirrors**

 **WARNING:** Do not adjust the mirror while your vehicle is in motion.

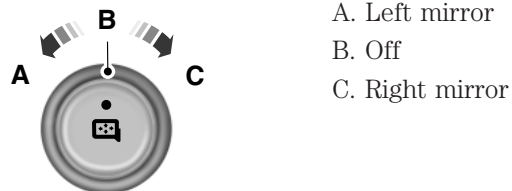

To adjust your mirrors:

1. Select the mirror you want to adjust.

2. Move the control in the direction you want to tilt the mirror.
3. Return the control to the center position to lock mirrors in place.

Foldaway Exterior Mirrors

Push the mirror toward the door window glass. Make sure that you fully engage the mirror in its support when returning it to its original position.

Heated Exterior Mirror

The heated exterior mirrors switch on with the heated rear window. See *Heated Windows and Mirrors* in the *Climate Control* chapter.

Memory Mirrors

You can save and recall the mirror positions through the memory function. See *Memory function* in the *Seats* chapter.

Auto-Dimming Feature

The driver's side exterior mirror will automatically dim when the interior auto-dimming mirror is activated.

Signal Indicator Mirrors (If Equipped)

The outer portion of the appropriate mirror housing blinks when you activate the turn signal.

Integrated Blind Spot Mirrors (If Equipped)

WARNING: Objects in the blind spot mirror are closer than they appear.

Blind spot mirrors have an integrated convex mirror built into the upper outboard corner of the exterior mirrors. They are designed to assist you by increasing visibility along the side of your vehicle.

Check the main mirror first before a lane change, then check the blind spot mirror. If no vehicles are present in the blind spot mirror and the traffic in the adjacent lane is at a safe distance, signal that you are going to change lanes. Glance over your shoulder to verify traffic is clear, and carefully change lanes.

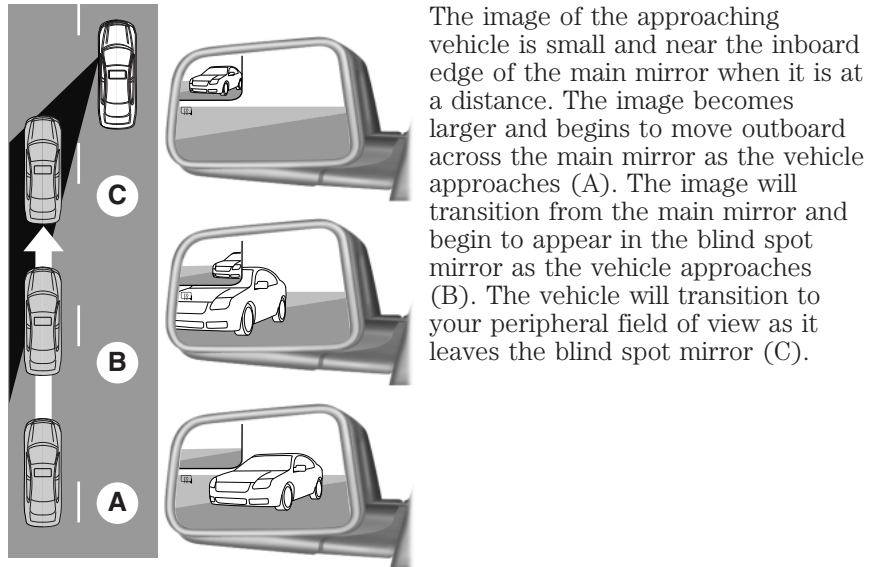

The image of the approaching vehicle is small and near the inboard edge of the main mirror when it is at a distance. The image becomes larger and begins to move outboard across the main mirror as the vehicle approaches (A). The image will transition from the main mirror and begin to appear in the blind spot mirror as the vehicle approaches (B). The vehicle will transition to your peripheral field of view as it leaves the blind spot mirror (C).

Blind Spot Information System (BLIS®) with Cross Traffic Alert (CTA) (If Equipped)

Refer to *Blind Spot Information System (BLIS®) with Cross Traffic Alert (CTA)* in the *Driving Aids* chapter.

INTERIOR MIRROR



WARNING: Do not adjust the mirror when your vehicle is moving.

Note: Do not clean the housing or glass of any mirror with harsh abrasives, fuel or other petroleum or ammonia based cleaning products.

You can adjust the interior mirror to your preference. Some mirrors also have a second pivot point. This lets you move the mirror head up or down and from side to side.

Auto-Dimming Mirror

Note: Do not block the sensors on the front and back of the mirror. Mirror performance may be affected. A rear center passenger or raised rear center head restraint may also block light from reaching the sensor. The mirror will dim automatically to reduce glare when bright lights are detected from behind your vehicle. It will automatically return to normal reflection when you select reverse gear to make sure you have a clear view when backing up.

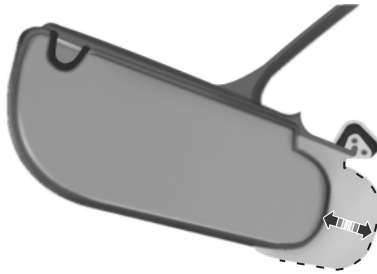
SUN VISORS**Slide-On-Rod**

Rotate the visor toward the side window and extend it rearward for extra sunlight coverage.

Retract the visor before moving it back toward the windshield and storing it.

Illuminated Visor Vanity Mirror

Lift the cover to switch on the lamp.

**PANORAMIC VISTA ROOF® AND POWER SUNSHADES
(IF EQUIPPED)**

 **WARNING:** Do not let children play with the panoramic Vista Roof® and power sunshade or leave children unattended in the vehicle. They may seriously hurt themselves.

 **WARNING:** When closing the panoramic Vista Roof® and power sunshade, you should verify that it is free of obstructions and ensure that children and/or pets are not in the proximity of the panoramic Vista Roof® and power sunshade opening.

Note: Do not attempt to move the sunshades manually or sunshade damage or malfunction may occur. The sunshade track clips are designed to release the sunshade crossbar in order to prevent damage to the system. If this occurs the sunshade crossbar ends may just need to be slid back into position to regain proper function. See your authorized dealer for proper moonroof or sunshade operating, diagnostic or repair instructions.

Note: If the moonroof is excessively operated, the glass and shade motors will go into a fail-safe jog mode (manual intermittent operation) to prevent overheating or damage to the motor. The motors will return to normal operation after a period of idle time.

The moonroof and sunshade controls are located on the overhead console.

The moonroof and sunshade have a one-touch open and close feature. To stop motion during one-touch operation, press the control a second time.

Opening the Sunshade and Moonroof

Note: The moonroof will only open after sunshades are completely open.

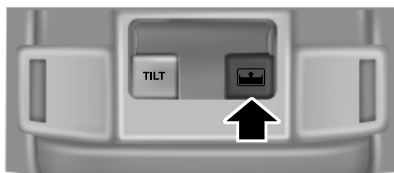

Press and release the control to open the sunshade. The front and rear sunshades open simultaneously.

Press and release the control to open the moonroof. The moonroof will stop short of the fully opened position.

Note: This position helps to reduce rumbling wind noise which may happen with the roof fully opened.

Press and release the control again to fully open.

Closing the Moonroof and Sunshades

Note: The sunshades will only close after the moonroof is completely closed.

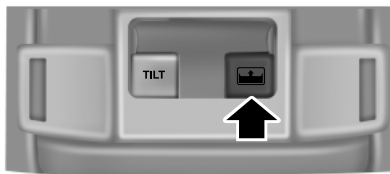

Pull and release the control. The moonroof will stop short of the fully closed position. Pull the control again and hold to fully close the moonroof.

Pull and release the control to close the sunshades. The sunshades will stop short of the fully closed position. Pull the control again and hold to fully close the sunshades.

Venting the Moonroof

Press and release the **TILT** control to vent the moonroof. Pull and hold the **TILT** control to close the moonroof.

GAUGES

Cluster shown in standard measure – metric clusters similar.

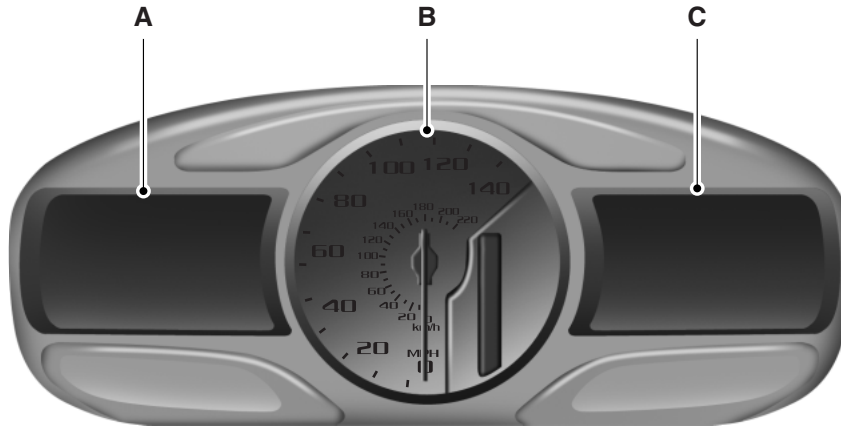

A. Left information display. See *Information displays* for more information.

B. Speedometer

C. Right information display. See *MyLincolnTouch™* for more information.

WARNING LAMPS AND INDICATORS

These lights can alert you to a vehicle condition that may become serious enough to cause expensive repairs. Many lights will illuminate when you start your vehicle to make sure they work. If any light remains on after starting the vehicle, refer to the respective system warning light for additional information.

Note: Some warning indicators are reconfigurable telltales (RTT). These indicators appear in the information display and function the same as a warning light, but do not display on startup.

Adaptive cruise control (if equipped) (RTT)

The speed control system indicator light changes color to indicate what mode the system is in:



- On (gray light): Illuminates when the adaptive cruise control system is turned on. Turns off when the speed control system is turned off.
- Engaged (green light): Illuminates when the adaptive cruise control system is engaged. Turns off when the speed control system is disengaged.

Airbag readiness

If this light fails to illuminate when the ignition is turned on, continues to flash or remains on, contact your authorized dealer as soon as possible. A chime will sound when there is a malfunction in the indicator light.

Anti-lock brake system

If the ABS light stays illuminated or continues to flash, a malfunction has been detected. Contact your authorized dealer as soon as possible. Normal braking is still functional unless the brake warning light also is illuminated.

Brake system warning light

To confirm the brake system warning light is functional, it will momentarily illuminate when the ignition is turned to the on position when the engine is not running, or in a position between on and start, or by applying the parking brake when the ignition is turned to the on position.

If it illuminates when you are driving, check that the parking brake is not engaged. If the parking brake is not engaged, this indicates low brake fluid level or a brake system malfunction. Have the system checked immediately by your authorized dealer.



WARNING: Driving a vehicle with the brake system warning light on is dangerous. A significant decrease in braking performance may occur. It will take you longer to stop the vehicle. Have the vehicle checked by your authorized dealer as soon as possible. Driving extended distances with the parking brake engaged can cause brake failure and the risk of personal injury.

Charging system (RTT)



Illuminates when the battery is not charging properly. If it stays on while the engine is running, there may be a malfunction with the charging system. Contact your authorized dealer as soon as possible. This indicates a problem with the electrical system or a related component.

Direction Indicator



Illuminates when the left or right turn signal or the hazard warning flasher is turned on. If the indicators stay on or flash faster, check for a burned out bulb.

Door ajar (RTT)



Displays when the ignition is on and any door is not completely closed.

Engine oil pressure (RTT)



Illuminates when the oil pressure falls below the normal range.

Engine coolant temperature (RTT)



Illuminates when the engine coolant temperature is high. Stop the vehicle as soon as possible, switch off the engine and let cool.

Grade assist (if equipped) (RTT)



Illuminates when grade assist is turned on.

Heads up display (if equipped)

A red beam of lights will illuminate on the windshield in certain instances when using adaptive cruise control and/or the collision warning system. It will also illuminate momentarily when you start your vehicle to make sure the display works.

High beams

Illuminates when the high-beam headlamps are on.

Low fuel (RTT)

Illuminates when the fuel level in the fuel tank is at or near empty.

Low tire pressure warning

Illuminates when your tire pressure is low. If the light remains on at start up or while driving, the tire pressure should be checked. When the ignition is first turned to on, the light will illuminate for 3 seconds to ensure the bulb is working. If the light does not turn on or begins to flash, contact your authorized dealer as soon as possible.

Low washer fluid (RTT)

Illuminates when the windshield washer fluid is low.

Parking Lamps (RTT)

It will illuminate when you switch the parking lamps on.

Powertrain malfunction/reduced power

Illuminates when a powertrain or an AWD fault has been detected. Contact your authorized dealer as soon as possible.

Safety belt

Reminds you to fasten your safety belt. A Belt-Minder® chime will also sound to remind you to fasten your safety belt.

Service engine soon

The *service engine soon* indicator light illuminates when the ignition is first turned to the on position to check the bulb and to indicate whether the vehicle is ready for

Inspection/Maintenance (I/M) testing. Normally, the “service engine soon” light will stay on until the engine is cranked, then turn itself off if no malfunctions are present. However, if after 15 seconds the “service engine soon” light blinks eight times, it means that the vehicle is not ready for I/M testing. See the *Readiness for inspection/maintenance (I/M) testing* in the *Fuel and Refueling* chapter.

Solid illumination after the engine is started indicates the on-board diagnostics system (OBD-II) has detected a malfunction. Refer to *On-board diagnostics (OBD-II)* in the *Fuel and Refueling* chapter. If the light is blinking, engine misfire is occurring which could damage your catalytic converter. Drive in a moderate fashion (avoid heavy acceleration and deceleration) and have your vehicle serviced immediately by your authorized dealer.



WARNING: Under engine misfire conditions, excessive exhaust temperatures could damage the catalytic converter, the fuel system, interior floor coverings or other vehicle components, possibly causing a fire.

Speed control (if equipped) (RTT)

The speed control system indicator light changes color to indicate what mode the system is in:

- On (gray light–type 1 and type 2): Illuminates when the speed control system is turned on. Turns off when the speed control system is turned off.
- Engaged (grey light-type 1, green light-type 2): Illuminates when the speed control system is engaged. Turns off when the speed control system is disengaged.

Stability Control System

Displays when the AdvanceTrac®/Traction control is active. If the light remains on, have the system serviced immediately.

Stability Control System Off

Illuminates when AdvanceTrac®/Traction control has been disabled by the driver.

AUDIBLE WARNINGS AND INDICATORS**Key In Ignition Warning Chime**

Sounds when the key is left in the ignition in the off or accessory position and the driver's door is opened.

Keyless Warning Alert (If Equipped)

Sounds the horn twice when you exit your vehicle with the intelligent access key, after the last door is closed and your keyless vehicle is in RUN, indicating your vehicle is still on.

Headlamps On Warning Chime

Sounds when the headlamps or parking lamps are on, the ignition is off (the key is not in the ignition) and the driver's door is opened.

Parking Brake On Warning Chime

Sounds when you have left the parking brake on and drive your vehicle. If the warning chime remains on after you have released the parking brake, have the system checked by your authorized dealer immediately.

GENERAL INFORMATION

 **WARNING:** Driving while distracted can result in loss of vehicle control, crash and injury. We strongly recommend that you use extreme caution when using any device that may take your focus off the road. Your primary responsibility is the safe operation of your vehicle. We recommend against the use of any handheld device while driving and encourage the use of voice-operated systems when possible. Make sure you are aware of all applicable local laws that may affect the use of electronic devices while driving..

Various systems on your vehicle can be controlled using the information display controls on the steering wheel. Corresponding information is displayed in the information display.

Information Display Controls

- Press the up and down arrow buttons to scroll through and highlight the options within a menu.
- Press the right arrow button to enter a sub-menu.
- Press the left arrow button to exit a menu.
- Press the OK button to choose and confirm a setting/messages.

The small squares in the upper right corner display the different menu levels and how far in the menu levels you are.

Main menu

From the main menu bar on the left side of the information display, you can choose from the following categories:

- Display Mode
- Trip 1 & 2
- Fuel Economy
- Driver Assist
- Settings

Scroll up/down to highlight one of the categories, then press the right arrow key or OK to enter into that category. Press the left arrow key as needed to exit back to the main menu.

Display Mode

Use the up/down arrow buttons to choose between the following display options.

Display mode				
Display mode	†Option 1	Option 2	Option 3	†Option 4
XXX mi (km) to empty	X			
Bar tachometer	X			X
Round tachometer		X	X	
Engine coolant temp gauge			X	
Intelligent AWD				X
Fuel gauge	Always Present			
Total odometer (lower left corner)	Always Present			
†You can also choose to have only the fuel gauge show in this mode. Refer to <i>Display > Gauge Display</i> found in the table under the <i>Settings</i> section later in this chapter.				
Regardless of display mode chosen, when SelectShift Automatic™ transmission (SST) is activated, the cluster will change to the round tachometer if not already selected. After the round tachometer displays, other display modes with the bar tachometer can also be chosen.				

- XXX mi (km) to empty: Shows approximate fuel level before the fuel tank reaches empty. The value is dynamic and can change (raise or lower) depending on driving style.
- Fuel gauge: Indicates approximately how much fuel is left in the fuel tank. The fuel gauge may vary slightly when the vehicle is in motion or on a grade. When the fuel level becomes low, the level indicator will change to amber. When the fuel level becomes critically low, the level indicator will change to red.
Note: When a MyKey® is in use, low fuel warnings will display earlier. The fuel icon and arrow indicates which side of the vehicle the fuel filler door is located.
- Bar/Round tachometer: Indicates the engine speed in revolutions per minute. Driving with your tachometer pointer continuously at the top of the scale may damage the engine. During SelectShift Automatic™ transmission (SST) use, the currently selected gear will appear in the display.
- Engine coolant temperature gauge: Indicates engine coolant temperature. At normal operating temperature, the level indicator will be in the normal range. If the engine coolant temperature exceeds the normal range, stop the vehicle as soon as safely possible, switch off the engine and let the engine cool.
- Intelligent AWD (if equipped): displays power distribution between the front and rear wheels. More power to either front or rear wheels will be displayed by more area filled in.

Trip 1 & 2

Trip 1 & 2	
Trip 1 & 2	Trip distance
	Average fuel economy
	Elapsed trip time
	Hold OK to Reset
Estimated amount of fuel consumed	
Total odometer (lower left corner)	
Press and hold OK to reset the currently displayed trip information.	

- Trip distance — shows the accumulated trip distance.
- Average fuel economy — shows the average fuel economy for a given trip.
- Elapsed trip time— timer stops when the vehicle is turned off and restarts when the vehicle is restarted.

- Estimated amount of fuel consumed — shows the amount of fuel used for a given trip.
- Elapsed trip time — timer stops when the vehicle is turned off and restarts when the vehicle is restarted.

Fuel Economy

Use the left/right arrow buttons to choose the desired fuel economy display.

Fuel Economy		
Fuel Economy	Inst. Fuel Economy	XX. Min Fuel History
Instantaneous fuel usage	x	
Fuel usage over a 30 minute time span		x
Average MPG	Always Present	
XXX mi (km) to E	Always Present	
Total odometer (lower left corner)		
Press and hold OK to reset the currently displayed fuel usage information.		

- Inst. Fuel Economy: This display shows a visual graph of your instantaneous fuel economy.
- XX. Min Fuel History: This display shows a bar chart of your fuel history.

Driver Assist

In this mode, you can configure different driver assists setting choices.

Note: Some items are optional and may not appear.

Driver Assist		
Traction Control — check enabled (default) / uncheck disabled		
Blind Spot — check enabled (default) / uncheck disabled		
Collision Warning	Sensitivity	High / Normal / Low
Cross Traffic — check enabled (default) / uncheck disabled		
Cruise Control	Adaptive or Normal	
Rear Park Aid — check enabled (default) / uncheck disabled		
Trailer Sway — check enabled (default) / uncheck disabled		

Settings

In this mode, you can configure different driver setting choices.

Note: Some items are optional and may not appear.

Settings				
Vehicle	DTE Calculation	Normal or Towing		
	Easy Entry/Exit — check enabled (default) / uncheck disabled			
	Lighting	Autolamp Delay	Off or number of seconds	
	Locks	Autolock — check enabled (default) / uncheck disabled		
		Autounlock — check enabled (default) / uncheck disabled		
		Remote Unlocking	All doors or Driver's door	
	Menu Control	Standard / Memory On (See <i>Menu control</i> later in this section)		
	Oil Life Reset	Set to XXX % — Hold OK to Reset		
	Power Liftgate	Enable or Disable		
	Remote Start	Climate Control	Auto / Last Settings	
		Seats & Wheel or Front Seats	Auto / Off	
		Duration	5 / 10 /15 minutes	
		System — check enabled (default) / uncheck disabled		
	Windows	Remote Open or Close		
	Wipers	Courtesy Wipe — check enabled (default) / uncheck disabled		
		Rain Sensing — check enabled (default) / uncheck disabled		
Reverse Wiper — check enabled (default) / uncheck disabled				

Settings (cont'd)		
*MyKey	Create MyKey	Press and hold OK to create MyKey
	911 Assist	Always On / User Selectable
	Traction Control	Always On / User Selectable
	Max Speed	Choose desired speed or off
	Speed Warning	Choose desired speed or off
	Volume Limiter	On / Off
	Clear MyKeys	Hold OK to Clear All MyKeys

*Some MyKey items will only appear if a MyKey is set.

Settings (cont'd)		
Display	Distance	Miles & GAL // km/l
		L/100km
		km/L
	Gauge Display	Fuel Gauge or Fuel + Tach
	Language	Select your applicable language — Hold OK to Set
Temperature	Fahrenheit (°F) or Celsius (°C)	

INFORMATION MESSAGES

Note: Depending on the vehicle options equipped with your vehicle, not all of the messages will display or be available. Certain messages may be abbreviated or shortened depending upon which cluster type you have.



Press the OK button to acknowledge and remove some messages from the information display. Other messages will be removed automatically after a short time. Certain messages need to be confirmed before you can access the menus.

Message indicators: Some messages will be supplemented by a system specific symbol.

Adaptive Cruise Control Messages	Action / Description
Adaptive Cruise Malfunction	Displayed when a radar malfunction is preventing the ACC from engaging.
Adaptive Cruise Not Available	Displayed when conditions exist such that the adaptive cruise cannot function properly.
Adaptive Cruise Not Available Sensor Blocked	Displayed when the radar is blocked because of poor radar visibility due to bad weather or ice/mud/water in front of radar. Driver can typically clean the sensor to resolve.
AdvanceTrac® / Traction Control Messages	Action / Description
Service AdvanceTrac	Displayed when the AdvanceTrac® system has detected a condition that requires service. Contact your authorized dealer as soon as possible.
Traction control off	Displayed when the traction control has been disabled by the driver.
Trailer Sway Reduce Speed	Displayed when the trailer sway control has detected trailer sway.

Alarm/Security Messages	Action / Description
To Stop Alarm, Start Vehicle	Displayed when the perimeter alarm system is armed and the vehicle is entered using the key on the driver's side door. In order to prevent the perimeter alarm system from triggering, the ignition must be turned to start or on before the 12 second chime expires.
AWD Messages	Action / Description
AWD Off	Displayed when the AWD system has been automatically disabled to protect itself. This is caused by operating the vehicle with the compact spare tire installed or if the system is overheating. The AWD system will resume normal function and clear this message after driving a short distance with the road tire re-installed or after the system is allowed to cool.
Check AWD	Displayed in conjunction with the Throttle Control/Transmission/AWD light when the AWD system is not operating properly. If the warning stays on or continues to come on, contact your authorized dealer as soon as possible.

Battery and Charging System Messages	Action / Description
Check Charging System	Displayed when the charging system needs servicing. If the warning stays on or continues to come on, contact your authorized dealer as soon as possible.
Turn Power Off to Save Battery	<p>Displayed when the battery management system determines that:</p> <ul style="list-style-type: none"> • the battery is at a low state of charge or, • the ignition has been in accessory position or on position with the engine off for approximately 45 minutes. <p>Turn the ignition off as soon as possible to protect the battery. This message will clear once the vehicle has been started and the battery state of charge has recovered. Turning off unnecessary electrical loads will allow faster battery state-of-charge recovery.</p>
Transport Mode Contact Dealer	Contact your authorized dealer as soon as possible.
Factory Mode Contact Dealer	Contact your authorized dealer as soon as possible.
BLIS® Messages	Action / Description
Blind Spot Not Available Sensor Blocked	Displayed when the blind spot information system/cross traffic alert system sensors are blocked. Driver can typically clean the sensor to resolve.
Blind Spot System Fault	Displayed when a fault with the blind spot information system has occurred. Contact your authorized dealer as soon as possible.
Cross Traffic Not Available Sensor Blocked	Displayed when the blind spot information system/cross traffic alert system sensors are blocked. Driver can typically clean the sensor to resolve.

BLIS® Messages	Action / Description
Cross Traffic System Fault	Displayed when a fault with the cross traffic alert system has occurred. Contact your authorized dealer as soon as possible.
Vehicle Coming From X	Displayed when the blind spot information system with cross traffic alert (CTA) system is operating and senses a vehicle.
Brake System Messages	Action / Description
Brake Fluid Level Low	Indicates the brake fluid level is low and the brake system should be inspected immediately.
Check Brake System	Displayed when the brake system needs servicing. If the warning stays on or continues to come on, contact your authorized dealer as soon as possible.
Park Brake Engaged	Displayed when the parking brake is set, the engine is running and the vehicle is driven more than 3 mph (5 km/h). If the warning stays on after the parking brake is released, contact your authorized dealer as soon as possible.
Collision Warning System Messages	Action / Description
Collision Warn Not Available	Displayed when there is a system malfunction with the collision warning system. The system will be disabled. Contact your authorized dealer as soon as possible.
Collision Warn Not Available Sensor Blocked	Displayed when the collision warning system radar is blocked because of poor radar visibility due to bad weather or ice/mud/water in front of the radar. Driver can typically clean the sensor to resolve. Contact your authorized dealer as soon as possible.

Collision Warning System Messages	Action / Description
Collision Warning Malfunction	Displayed when there is a system malfunction with the collision warning system. The system will be disabled. Contact your authorized dealer as soon as possible.
Collision Warning Display Fault	Displayed when there is a system malfunction with the collision warning system display. Contact your authorized dealer as soon as possible.
Door Messages	Action / Description
X Door Ajar	Displayed when a door is not completely closed.
Liftgate Ajar	Displayed when the liftgate is not completely closed.
Fuel Messages	Action / Description
Check Fuel Fill Inlet	Displayed when the fuel fill inlet may not be properly closed.
Fuel Level Low XXX mi/km to E	Displayed as an early reminder of a low fuel condition.

Keys and Intelligent Access Messages	Action / Description
No Key Detected	<p>Displayed if the intelligent access key is not detected by the system in the following three scenarios:</p> <ul style="list-style-type: none"> •When the start/stop button is pressed in an attempt to either start the engine or cycle through the ignition states. •When the engine is running and a door is opened then closed. •When the vehicle's speed exceeds 10 mph (16 km/h) for the first time after starting.
Key Programmed x Keys Total	Displayed during spare key programming, when an intelligent access key is programmed to the system.
Max Number of Keys Programmed	Displayed during spare key programming when the maximum number of keys have been programmed.
Press Brake to Start	Displayed when the start/stop button is pressed without the brake pedal being applied. This is a reminder that the brake pedal must be applied when the start/stop button is pressed in order to start the engine.
Restart Now or Key is Needed	Displayed when the start/stop button is pressed to shut off the engine and a Intelligent Access Key is not detected inside the vehicle.
Accessory Power Active	Displayed when the vehicle is in the accessory ignition state.
Starting System Fault	This message is displayed when there is a problem with your vehicle's starting system. See your authorized dealer for service.

Maintenance Messages	Action / Description
LOW Engine Oil Pressure	Stop the vehicle as soon as safely possible, turn off the engine. Check the oil level. If the warning stays on or continues to come on with your engine running, contact your authorized dealer as soon as possible.
Change Engine Oil Soon	Displayed when the engine oil life remaining is 10% or less.
Oil Change Required	Displayed when the oil life left reaches 0%.
Engine Coolant Over Temp	Displayed when the engine coolant temperature is excessively high.
Washer Fluid Level Low	Indicates the washer fluid reservoir is less than one quarter full. Check the washer fluid level.
Steering Malfunction Service Now	Displays when the steering system needs service. See your authorized dealer.
Service Power Steering	The power steering system has detected a condition that requires service. See your authorized dealer.
Service Power Steering Now	The power steering system has detected a condition within the power steering system that requires service immediately. See your authorized dealer.
Power Steering Assist Fault	The power steering system has disabled power steering assist due to a system error. See your authorized dealer.
MyKey® Messages	Action / Description
MyKey active Drive Safely	Displayed when MyKey® is active.
MyKey not Created	Displayed during key programming when MyKey® cannot be programmed.
Speed Limited to xx MPH/km/h	Displayed when starting the vehicle and MyKey® is in use and the MyKey speed limit is on.

MyKey® Messages	Action / Description
Vehicle Near MyKey Top Speed	Displayed when a MyKey® is in use and the MyKey speed limit is on and the vehicle speed is 80 mph (130 km/h).
Vehicle Near MyKey Top Speed	Displayed when a MyKey® is in use and the MyKey speed limit is on and the vehicle speed is approaching 80 mph (130 km/h).
Check Speed Drive Safely	Displayed when a MyKey® is in use and the optional setting is on and the vehicle exceeds a preselected speed.
Buckle Up to Unmute Audio	Displayed when a MyKey® is in use and Belt-Minder® is activated.
Could Not Program Key	Displayed when an attempt is made to program a spare key using two existing MyKeys.
Park Aid Messages	Action / Description
Check Park Aid	Displayed when the transmission is in R (Reverse) and the park aid is disabled.
Check Rear Park Aid	Displayed when the transmission is in R (Reverse) and the park aid is disabled.
Rear Park Aid On Off	Displays the rear park aid status.
Passenger Sensing System Message	Action / Description
Remove Objects Near Passenger Seat	Displayed when objects are by the passenger seat. After the objects are moved away from the seat, if the warning stays on or continues to come on contact your authorized dealer as soon as possible.

Reminder Messages	Action / Description
Steering Lock Turn Wheel to Unlock	Displays when you need to turn the steering wheel in order to disengage the steering lock.
Shift to Park	Displayed when the engine is turned off and shift select lever is in any position other than P (Park).
Engine On	Displays when the driver's door is opened, the vehicle is in park and the engine is on.
Remote Start	Action / Description
To Drive: Turn Key to On	Displays as a reminder to turn the key on to drive the vehicle after a remote start.
To Drive: Press Brake and START Button	Displays as a reminder to apply the brake and the start button to drive the vehicle after a remote start.
Tire Messages	Action / Description
Low Tire Pressure	Displays when one or more tires on your vehicle have low tire pressure.
Tire Pressure Monitor Fault	Displays when the tire pressure monitoring system is malfunctioning. If the warning stays on or continues to come on, contact your authorized dealer.
Tire Pressure Sensor Fault	Displayed when a tire pressure sensor is malfunctioning, or your spare tire is in use. For more information on how the system operates under these conditions, refer to <i>Tire Pressure Monitoring System (TPMS)</i> in the <i>Wheels and tires</i> chapter . If the warning stays on or continues to come on, contact your authorized dealer as soon as possible.

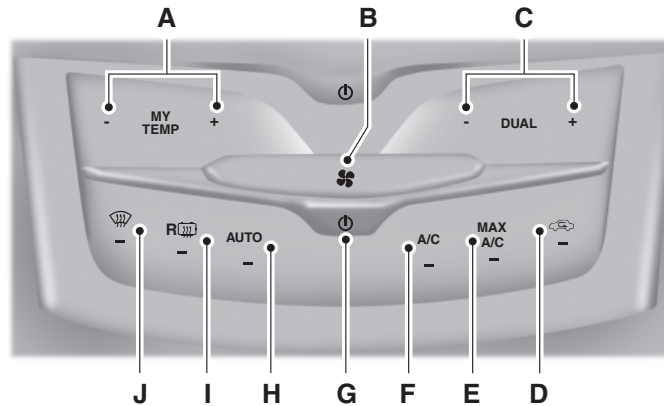
DUAL AUTOMATIC TEMPERATURE CONTROL SYSTEM

Note: You can switch temperature units between Fahrenheit and Celsius. See *Settings* in the *MyLincoln Touch* chapter.

A. **MyTemp:** Allows you to quickly adjust to a frequently used setting with a single touch.

Press + and - to increase and decrease the temperature.

Touch and hold MyTemp to save the current temperature. To access the setting again, touch the MyTemp indicator again.

B. **Fan speed control:** You can press or tap the right or left side of the slider, or slide your finger across the control, to increase or decrease the fan speed.

C. **DUAL:** Allows the passenger to set their temperature independent of the driver temperature.

D. **Recirculated air:** Press this button to switch between outside air and recirculated air. When the LED on the button lights up, this indicates the air currently in the passenger compartment recirculates. This may reduce the time needed to cool the interior (when used with air conditioning) and may reduce unwanted odors from entering your vehicle.

Note: Recirculated air engages automatically when you select MAX A/C. You can turn it on manually in any airflow mode except defrost.

E. **MAX A/C:** Distributes recirculated air through the instrument panel vents to cool the vehicle. This position is more economical and efficient than normal air conditioning.

F. **A/C:** Press to turn air conditioning off and on. Air conditioning cools the vehicle using outside air. To improve air conditioning when starting your vehicle, drive with the windows slightly open for two to three minutes.

Use air conditioning with recirculated air to improve cooling performance and efficiency.

Note: Air conditioning turns on automatically in MAX A/C, Defrost and Floor/Defrost.

G. **Power:** Press to turn the system off and on. When the system is off, outside air cannot enter the vehicle.

H. **AUTO:** Press to turn on fully automatic operation. Select the desired temperature using the temperature control. The system automatically determines fan speed, air distribution, air conditioning operation, and outside or recirculated air, to heat or cool the vehicle to maintain the selected temperature.

I. **Rear defrost:** Turns the heated windows and mirrors off and on. See *Heated windows and mirrors* later in this chapter for more information. If your vehicle is equipped with heated mirrors, this button turns them on also.

J. **Defrost:** Distributes air through the windshield defroster vents and demister vents. You can also use this setting to defog and clear the windshield of a thin covering of ice.

GENERAL OPERATING TIPS

- To reduce fog build-up on the windshield during humid weather, select defrost. Temperature and fan speed can also be increased to improve clearing.
- To reduce humidity build-up inside the vehicle, do not drive with the system off or with recirculated air engaged.
- Do not put objects under the front seats that will interfere with the airflow to the back seats.
- Remove any snow, ice or leaves from the air intake area at the base of the windshield.
- To improve the air conditioning cool down, drive with the windows slightly open for 2-3 minutes after start-up or until the vehicle has been aired out.
- A small amount of air may be felt from the floor vent regardless of the air distribution setting that is selected.

During extreme high ambient temperatures when idling stationary for extended periods of time in gear, it is recommended to run the air conditioning in the MAX A/C mode, adjust the blower fan speed to the lowest setting and put the vehicle's transmission into position **P** to continue to receive cool air from your air conditioning system.

For maximum cooling performance in AUTO, press **MAX A/C**.

For maximum cooling performance in manual override control (using the MyLincoln Touch climate controls):

1. Choose panel, A/C, and recirculation controls.
2. Set the temperature to LO.
3. Set the fan to the highest blower setting.

To aid in side window defogging and demisting in cold or humid weather:

1. Select defrost or floor/defrost (on the MyLincoln Touch climate controls). To maximize performance select defrost.
2. Select **A/C**.
3. Adjust the temperature control to maintain comfort.
4. Set the fan speed to the highest setting.

HEATED WINDOWS AND MIRRORS

Heated Rear Window

Note: The vehicle must be running to use this feature.

Press the control to clear the rear window of thin ice and fog. Press the control again within 15 minutes to switch it off. It turns off automatically after approximately 15 minutes, or when you switch off the ignition.

Do not use razor blades or other sharp objects to clean the inside of the rear window or to remove decals from the inside of the rear window. This may cause damage to the heated grid lines. Your warranty does not cover this damage.

Heated Exterior Mirror

Note: Do not remove ice from the mirrors with a scraper or attempt to readjust the mirror glass that has frozen in place. These actions could cause damage to the glass and mirrors.

Note: Do not clean the housing or glass of any mirror with harsh abrasives, fuel or other petroleum-based cleaning products.

Both mirrors heat to remove ice, mist and fog when you turn the rear window defroster on.

CABIN AIR FILTER

Note: A cabin air filter must be installed at all times to prevent foreign objects from entering the system. Running the system without a filter in place could result in degradation or damage to the system.

Your vehicle is equipped with a filter; the access door is located behind the glove box.

The particulate air filtration system is designed to reduce the concentration of airborne particles, such as dust, spores and pollen, in the air being supplied to the interior of the vehicle. The particulate filtration system gives the following benefits to customers:

- Improves the customer's driving comfort by reducing particle concentration.
- Improves the interior compartment cleanliness.
- Protects the climate control components from particle deposits.

Have the filter replaced at regular intervals. See the *Scheduled Maintenance* chapter.

For additional information, or to replace the filter, see an authorized dealer.

REMOTE START (IF EQUIPPED)

The remote start feature allows you to pre-condition the interior of your vehicle. The climate control system works to achieve comfort according to your previous settings.

Note: You cannot adjust the system during remote start operation.

Turn the ignition on to return the system to its previous settings. You can now make adjustments normally, but you need to turn certain vehicle-dependent features back on, such as:

- Heated seats.
- Cooled seats.
- Heated steering wheel.
- Heated mirrors.
- Heated rear window.

You can adjust the default remote start settings using the information display controls. See the *Information Displays* chapter.

Automatic Climate Systems***Automatic Settings***

You can set the climate control to operate in AUTO mode through the information display setting: Remote Start > Climate Control > Heater – A/C > Auto. The climate control system automatically sets the interior temperature to 72°F (22°C).

In hot weather, the system is set to 72°F (22°C). Cooled seats are set to high (if available, and selected to AUTO in the information display).

In moderate weather, the system either heats or cools (based on previous settings). The rear defroster, heated mirrors and heated/cooled seats are not automatically turned on.

In cold weather, the system is set to 72°F (22°C). The heated seats and heated steering wheel are set to high (if available, and selected to AUTO in the information display). The rear defroster and heated mirrors are automatically turned on.

Last Settings

You can set the climate control to operate using the last climate control settings through the information display setting: Remote Start > Climate Control > Heater – A/C > Last Settings. The climate control system automatically uses the settings last selected before the vehicle was turned off.

Heated and Cooled Devices

The climate control system controls other heated and cooled devices inside the vehicle. These devices (if available, and selected to AUTO in the information displays) may also be switched on during remote start. Heated devices are typically switched on during cold weather, and cooled devices during hot weather.

SITTING IN THE CORRECT POSITION

 **WARNING:** Sitting improperly out of position or with the seat back reclined too far can take off weight from the seat cushion and affect the decision of the passenger sensing system, resulting in serious injury or death in a crash. Always sit upright against your seat back, with your feet on the floor.

 **WARNING:** Do not recline the seat back as this can cause the occupant to slide under the seat's safety belt, resulting in severe personal injury in the event of a crash.

 **WARNING:** Do not place objects higher than the seat backs to reduce the risk of injury in a crash or during heavy braking or when stopping suddenly.

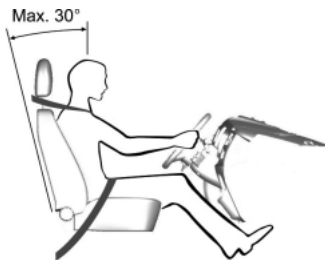

When you use them properly, the seat, head restraint, safety belt and airbags will provide optimum protection in the event of a crash.

We recommend that you follow these guidelines:

- Do not recline the seat back more than 30 degrees from vertical.
- Sit in an upright position with the base of your spine as far back as possible.
- Adjust the head restraint so that the top of it is level with the top of your head and as far forward as possible, remaining comfortable.
- Keep sufficient distance between yourself and the steering wheel. We recommend a minimum of 10 inches (25 centimeters) between your breastbone and the airbag cover.
- Hold the steering wheel with your arms slightly bent.
- Bend your legs slightly so that you can press the pedals fully.

- Position the shoulder strap of the safety belt over the center of your shoulder and position the lap strap tightly across your hips.

Make sure that your driving position is comfortable and that you can maintain full control of your vehicle.

HEAD RESTRAINTS

 **WARNING:** To minimize the risk of neck injury in the event of a crash, the driver and passenger occupants should not sit in or operate the vehicle, until the head restraint is placed in its proper position. The driver should never adjust the head restraint while the vehicle is in motion.

 **WARNING:** The adjustable head restraint is a safety device. Whenever possible it should be installed and properly adjusted when the seat is occupied.

 **WARNING:** Install the head restraint properly to minimize the risk of neck injury in the event of a crash.

Note: Before adjusting any head restraint, adjust the seatback to an upright driving or riding position. Properly adjust the head restraint so that the top of the head restraint is even with the top of your head and positioned as close as possible to the back of your head. For occupants of extremely tall stature, adjust the head restraint to its full up position.

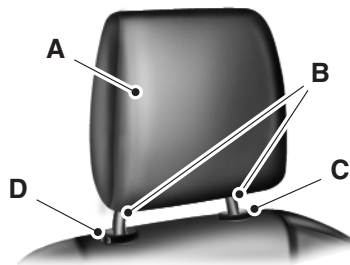

**Front Seat and Rear Seat
Outboard Head Restraints**

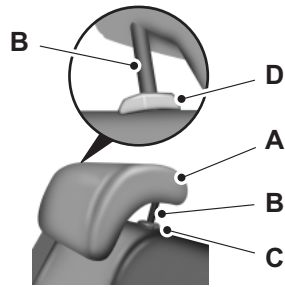
**Rear Seat Center Head Restraint**

The head restraints consist of:

- A. An energy absorbing head restraint.
- B. Two steel stems.
- C. Guide sleeve unlock and remove button.
- D. Guide sleeve adjust and release button.

To adjust the head restraint, do the following:

- Raise: Pull up on the head restraint (A).
- Lower: Press and hold the guide sleeve adjust and release button (D) and push down on the head restraint (A).
- Remove: Pull up the head restraint until it reaches the highest adjustment position and then press and hold both the adjust and release button (D) and the unlock and remove button (C), then pull up on the head restraint.
- Reinstall: Align the steel stems into the guide sleeves and push the head restraint down until it locks.

Tilting Head Restraints (If Equipped)

The front head restraints may tilt for extra comfort. To tilt the head restraint, do the following:



1. Adjust the seatback to an upright driving or riding position.
2. Tilt the head restraint forward by gently pulling the top of the head restraint.

Once it is in its forward-most position, tilt it forward once more to release it to the upright position.

Note: Do not attempt to force the head restraint backward after it is tilted. Instead, continue tilting it forward until the head restraint releases to the upright position.

POWER SEATS

WARNING: Do not adjust the driver seat or seatback when the vehicle is moving. This may result in sudden seat movement, causing loss of control of your vehicle.



WARNING: Before returning the seatback to its original position, make sure that cargo or any objects are not trapped behind the seatback.

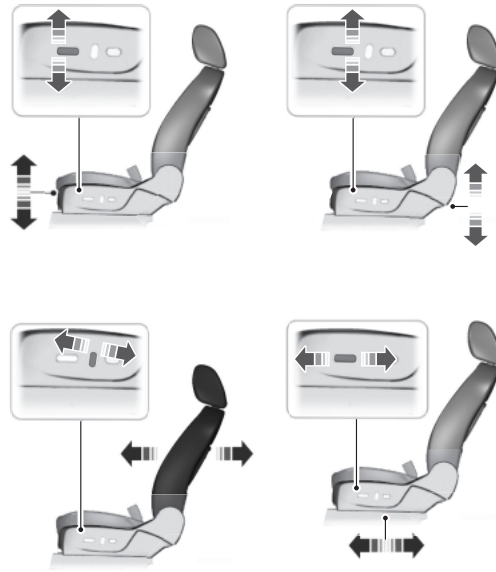

Power Lumbar

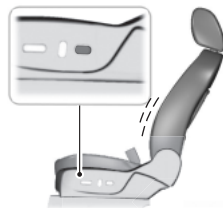

MEMORY FUNCTION

The memory control, located on the instrument panel, allows automatic positioning of the following features to two programmable positions:

- Driver seat.
- Power mirrors.
- Optional power steering column.

Programming a Memory Position

1. Switch the ignition on.
2. Adjust the memory features to your desired positions using the associated controls.
3. Press and hold the desired pre-set button for about two seconds until you hear a single tone.

You can save up to two pre-set memory positions. You can save a pre-set memory position at any time.

Recalling a Memory Position

Press and release the desired memory pre-set button to recall a saved memory position.

You can recall a programmed memory position:

- In any gearshift position if the ignition is not on.
- Only in park (P) or neutral (N) if the ignition is on.

Recalling a Memory Position with the Remote Control

The memory positions are also recalled when you press unlock on your remote control (if the transmitter is programmed to a memory position).

To program the memory feature to a remote control, see *Keys and Remote Control* chapter.

Easy Entry and Exit Feature

This feature can move the seat rearward and the steering column up and forward to allow extra room to exit the vehicle.

This occurs when:

- You place the transmission in park (P) or neutral (N).
- You switch the keyless ignition off.

The seat and steering wheel will move to their original positions when:

- You place the transmission in park (P) or neutral (N).
- You switch the keyless ignition on.

Turn the Easy Entry and Exit feature on or off through the information display settings menu. See the *Information Displays* chapter.

HEATED AND VENTILATED SEATS

Heated Seats



WARNING: Persons who are unable to feel pain to the skin because of advanced age, chronic illness, diabetes, spinal cord injury, medication, alcohol use, exhaustion, or other physical conditions, must exercise care when using the seat heater. The seat heater may cause burns even at low temperatures, especially if used for long periods of time. Do not place anything on the seat that insulates against heat, such as a blanket or cushion, because this may cause the seat heater to overheat. Do not puncture the seat with pins, needles, or other pointed objects because this may damage the heating element which may cause the seat heater to overheat. An overheated seat may cause serious personal injury.

Note: Do not do the following:

- Place heavy objects on the seat
- Operate the seat heater if water or any other liquid is spilled on the seat. Allow the seat to dry thoroughly.

The heated seats will only function when the engine is running.

To operate the heated seats:



Press the heated seat symbol located on the touchscreen to cycle through the various heat settings and off. Warmer settings are indicated by more indicator lights.

If the engine falls below 350 RPM while the heated seats are on, the feature will turn itself off. You will need to reactivate it.

Cooled Seats

The cooled seats will only function when the engine is running.

To operate the cooled seats:



Press the cooled seat symbol located on the touchscreen to cycle through the various cooling settings and off. Cooler settings are indicated by more indicator lights.

If the engine falls below 350 RPM while the cooled seats are on, the feature will turn itself off. You will need to reactivate it.

Heated and Cooled Seat Air Filter Replacement (If Equipped)

The climate controlled seat system includes air filters. You must replace them periodically. See the *scheduled maintenance information*.

Locate the filters under each front seat and access them from the second-row foot-well area. Move the front seats all the way forward and to the full up positions to ease access.

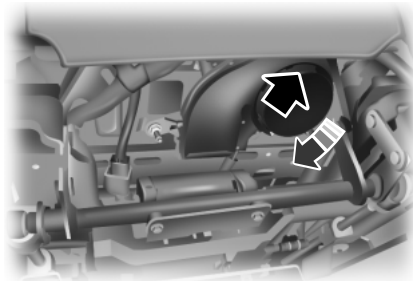

To remove an air filter:

1. Turn the vehicle off.
2. Push up on the outside rigid edge of the filter and rotate counterclockwise once the tabs are released, then remove the filter.

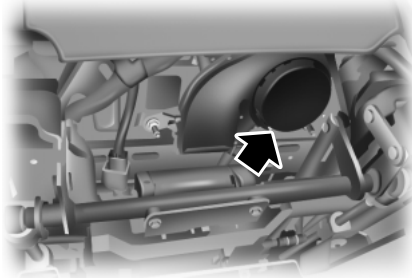

To install a filter:

1. First, position the filter in its housing making sure that the far forward end is all the way up in the housing.
2. Push in on the center of the outside edge of the filter and rotate up into the housing until it clips into position.

REAR SEATS

 **WARNING:** To prevent possible damage to the seat or safety belts, make sure that the safety belts are not buckled when folding the seatback.

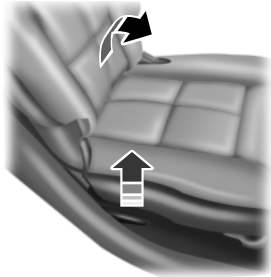

- Reclining the seatback: With the seat occupied, pull the lever up to recline the seatback.
- Folding the seatback: With the seat empty, pull the lever up to fold the seatback forward.
- Unfolding the seatback: Rotate the seatback upward until the seatback latches in the upright position. The seatback will click when it is locked into position.

EasyFold™ Folding Seat

 **WARNING:** Make sure that the seat is unoccupied when folding it down. Folding the seat while occupied could result in damage to the seat or injury.

Note: The power feature is operational when the vehicle is in park (P) and the liftgate has been open for less than 10 minutes.

The control buttons are located on the left-hand rear quarter trim panel (accessible from the liftgate area).



- Folding the seatback: Press and hold the control mechanism to lower the seatback. The top portion lowers the right seatback, and the bottom portion lowers the left seatback.
- Unfolding the seatback: Rotate the seatback upward until the seatback latches in the upright position. The seatback will click when it is locked into position.

REAR SEAT ARMREST



Fold the armrest down to use the armrest and cupholder. To close the armrest, rotate the armrest rearward until the latch clicks.

Rear Heated Seats



WARNING: Persons who are unable to feel pain to the skin because of advanced age, chronic illness, diabetes, spinal cord injury, medication, alcohol use, exhaustion, or other physical conditions, must exercise care when using the seat heater. The seat heater may cause burns even at low temperatures, especially if used for long periods of time. Do not place anything on the seat that insulates against heat, such as a blanket or cushion, because this may cause the seat heater to overheat. Do not puncture the seat with pins, needles, or other pointed objects because this may damage the heating element which may cause the seat heater to overheat. An overheated seat may cause serious personal injury.

Note: Do not do the following:

- Place heavy objects on the seat
- Operate the seat heater if water or any other liquid is spilled on the seat. Allow the seat to dry thoroughly.

The rear seat heat controls are located on the rear door panels.

The heated seats only operate when the ignition is on. To operate the heated seats:



- Press the indicated side of the control for maximum heat.
- Press again to deactivate.





- Press the indicated side of the control for minimum heat.
- Press again to deactivate.

The heated seat module resets at every ignition run cycle. While the ignition is in the on position, activating the high or low heated seat switch enables heating mode. When activated, they will turn off automatically when the engine is turned off.

The indicator light will illuminate when the heated seats have been activated.

HOMELINK® WIRELESS CONTROL SYSTEM (IF EQUIPPED)

 **WARNING:** Make sure that the garage door and security device are free from obstruction when you are programming. Do not program the system with the vehicle in the garage.

 **WARNING:** Do not use the system with any garage door opener that does not have the safety stop and reverse feature as required by U.S. Federal Safety Standards (this includes any garage door opener manufactured before April 1, 1982).

Note: Make sure you keep the original remote control transmitter for use in other vehicles as well as for future system programming.

Note: We recommend that upon the sale or lease termination of your vehicle, you erase the programmed function buttons for security reasons. See *Erasing the function button codes* later in this section.

Note: You can program a maximum of three devices. To change or replace any of the three devices after it has been initially programmed, you must first erase the current settings. See *Erasing the function button codes* later in this section.

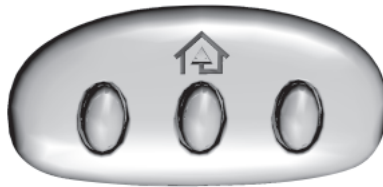

The universal garage door opener replaces the common hand-held garage door opener with a three-button transmitter that is integrated into the driver's sun visor.

The system includes two primary features, a garage door opener and a platform for remote activation of devices with the home. As well as being programmed for garage doors, the system transmitter can be programmed to operate entry gate operators, security systems, entry door locks, and home or office lighting.

Additional system information can be found online at www.homelink.com or by calling the toll-free help line on 1-800-355-3515.

Programming

Note: Put a new battery in the hand-held transmitter. This will ensure quicker training and accurate transmission of the radio-frequency signal.

1. With your vehicle parked outside of the garage and your key in the ignition, turn the key so that the ignition is in the on position.

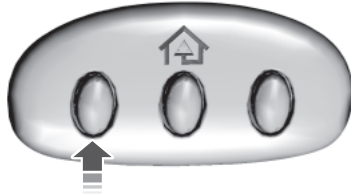

2. Hold your hand-held, garage door transmitter 1-3 inches (2-8 centimeters) away from the HomeLink button you want to program.

3. Using both hands, simultaneously press and hold the desired HomeLink button and the hand-held transmitter button. DO NOT release either one until the HomeLink indicator light flashes slowly and then rapidly. When the indicator light flashes rapidly, both buttons may be released. The rapid flashing indicates successful training.

4. Press and hold the HomeLink button you programmed for five seconds, then release. You may need to do this twice to activate the door. If your garage door does not operate, watch the HomeLink indicator light.

If the indicator light stays on, the programming is complete. Press and release the programmed HomeLink button, and then begin programming your garage door opener. See below for Steps 5 – 7.

If the indicator light flashes rapidly for two seconds and then turns to a constant light, the HomeLink button is not programmed yet. Do the following:

Press and hold the HomeLink button while you press and release the hand-held transmitter button every two seconds. The HomeLink indicator light will flash slowly and then rapidly once the HomeLink function button recognizes and accepts the hand-held transmitter's radio frequency signal.

After programming the HomeLink button, follow Steps 5 – 7 as listed below to program your garage door opener.



Note: You may need a ladder to reach the unit and you may need to remove the cover or lamp lens on your garage door opener.

5. Press the learn button on the garage door opener motor, and then you have 30 seconds to complete the next step.

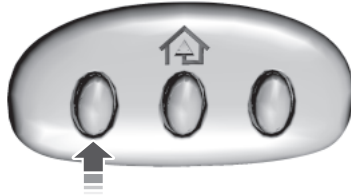

6. Return to your car.

7. Press and hold the function button you want to program for two seconds, then release. Repeat this step. Depending on your brand of garage door opener, you may need to repeat this sequence a third time.

To program additional buttons, repeat Steps 1 – 4 .

For questions or comments, please contact HomeLink® at www.homelink.com or 1-800-355-3515.

Erasing the Function Button Codes

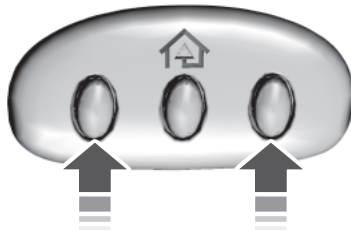

Note: You cannot erase individual buttons.

1. Press and hold the outer two function buttons simultaneously for approximately 20 seconds until the indicator lights above the buttons flash rapidly.

2. When the indicator lights flash, release the buttons. The codes for all buttons are erased.

Reprogramming a single button

To program a device to a previously trained button, follow these steps:

1. Press and hold the desired button. **Do NOT** release the button.
2. The indicator light will begin to flash after 20 seconds. Without releasing the button, follow Step 1 in the *Programming* section.

For questions or comments, contact HomeLink® at www.homelink.com or 1-800-355-3515.

Programming HomeLink to a Genie Intellicode 2 garage door opener

Note: The Genie Intellicode 2 transmitter must already be programmed to operate with the garage door opener.

Programming the transmitters

To program HomeLink to the transmitter you must first put the transmitter into programming mode. To do this:

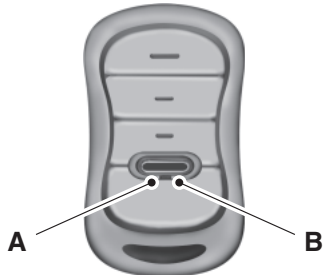

- A. Red LED
- B. Green LED

1. Press and hold one of the buttons on the hand-held transmitter for 10 seconds. The LED light will change from green to green and red.
2. Press the same button twice to confirm the change to Programming mode. If done properly the LED light will appear red.
3. Hold the transmitter within 1–3 inches (2–8 centimeters) of the button on the sun visor you want to program.
4. Press and hold both the programmed Genie button on the hand-held transmitter and the button on the sun visor you want to program. The indicator light on the sun visor will flash rapidly when the programming is successful.

Note: the Genie transmitter will transmit for up to 30 seconds. If HomeLink does not program within 30 seconds the Genie transmitter will need to be pressed again. If the Genie transmitter LED displays green and red, release the button until the LED turns off before pressing the button again.

Once HomeLink has been programmed successfully, the Genie transmitter must be changed out of program mode. To do this:

1. Press and hold the previously programmed Genie button on the hand-held transmitter for 10 seconds. The indicator light will change from red to red and green.
2. Press the same button twice to confirm the change. If done correctly the LED will turn green.

Programming HomeLink to the Genie Intellicode garage door opener motor

Note: You may need a ladder to access the garage door opener motor.

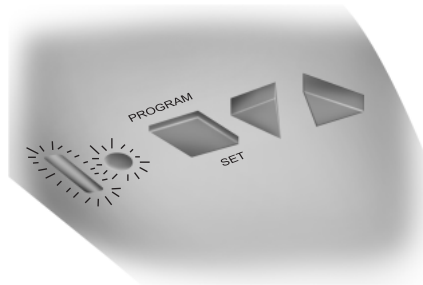

To program HomeLink to the garage door opener motor:

1. Press and hold the PROGRAM button on the garage door opener motor until both blue LED's turn on.
2. Release the PROGRAM button. Only the smaller round LED should be on.
3. Press and release the program button. The larger purple LED will flash

Note: The next two steps must be completed in 30 seconds.

4. Press and release the Genie Intellicode 2 hand-held transmitter's previously programmed button. Both indicator lights on the garage door opener motor unit should now flash purple.
5. Press and hold the previously programmed button on the sun visor for two seconds. Repeat this step up to 3 times until the garage door moves. Programming is now complete.

Clearing a HomeLink device

To erase programming from the three HomeLink buttons, press and hold the two outer HomeLink buttons until the indicator light begins to flash. The LED will begin flashing in 10 to 20 seconds, at which time both buttons should be released. Programming has now been erased, and the LED should blink slowly to indicate the device is in train mode when any one of the three HomeLink buttons is pressed.

FCC and RSS-210 Industry Canada Compliance

This device complies with Part 15 of the FCC Rules and with RSS-210 of Industry Canada. Operation is subject to the following two conditions: (1) this device may not cause harmful interference, and (2) this device must accept any interference received, including interference that may cause undesired operation.

Changes or modifications to your device not expressly approved by the party responsible for compliance can void the user's authority to operate the equipment.

AUXILIARY POWER POINTS

Note: Do not insert objects other than an accessory plug into the power point. This will damage the outlet and blow the fuse.

Note: Do not hang any type of accessory or accessory bracket from the plug.

Note: Improper use of the power outlet can cause damage not covered by your warranty.

Note: Do not plug optional electrical accessories into the cigarette lighter socket (if equipped). Improper use of the lighter can cause damage not covered by your warranty, and can result in fire or serious injury.

Auxiliary power points may be found:

- on the passenger side of the center console near the instrument panel
- in the center console storage compartment
- on the rear of the center console
- on the left rear quarter panel, accessible from the liftgate or behind the rear seat.

Do not use the power point for operating the cigarette lighter element (if equipped).

Do not use the power point(s) over the vehicle capacity of 12 volts DC 180 watts or a fuse may blow.

Run the engine for full capacity use of the power point and to avoid discharge of the battery. To prevent the battery from being discharged:

- Do not use the power point longer than necessary when the engine is not running.
- Do not leave devices plugged in overnight or when the vehicle is parked for extended periods.

Always keep the power point caps closed when not in use.

CENTER CONSOLE

Stow items in the cupholder carefully as items may become loose during hard braking, acceleration or collisions, including hot drinks which may spill.

Available console features include:

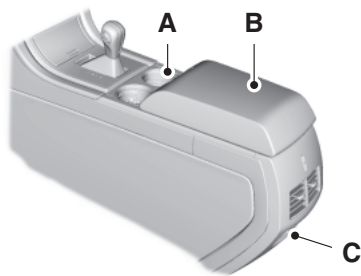

A. Cupholders

B. Cover: Two pen holders, travel tissue pack holder, and business card or paper holder. Utility compartment: in-bin powerpoint, removable coin holder and removable storage tray

C. Rear powerpoint

OVERHEAD CONSOLE

The appearance of the overhead console will vary according to your option package.

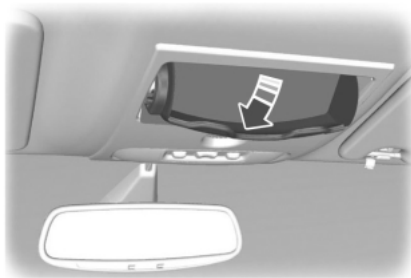



Press near the rear edge of the door to open it.

GENERAL INFORMATION

 **WARNING:** Extended idling at high engine speeds can produce very high temperatures in the engine and exhaust system, creating the risk of fire or other damage.

 **WARNING:** Do not park, idle, or drive your vehicle on dry grass or other dry ground cover. The emission system heats up the engine compartment and exhaust system, which can start a fire.

 **WARNING:** Do not start your vehicle in a closed garage or in other enclosed areas. Exhaust fumes can be toxic. Always open the garage door before you start the engine.

 **WARNING:** If you smell exhaust fumes inside your vehicle, have your vehicle checked by an authorized dealer immediately. Do not drive if you smell exhaust fumes.

If you disconnect the battery, your vehicle may exhibit some unusual driving characteristics for approximately 5 miles (8 kilometers) after you connect it. This is because the engine management system must realign itself with the engine. You may disregard any unusual driving characteristics during this period.

The powertrain control system meets all Canadian interference-causing equipment standard requirements regulating the impulse electrical field or radio noise.

Do not press the accelerator pedal while starting the engine. If you have difficulty starting the engine, see *Failure to start* later in this section.

KEYLESS STARTING

Note: The keyless starting system may not function if the key is close to metal objects or electronic devices such as mobile phones.

Note: A valid key must be located inside your vehicle to switch the ignition on and start the engine.

Note: When locking your vehicle, any remote controls left inside the vehicle may become disabled. A message may appear in the information display indicating that there is no key detected if you try to start the engine. Press the unlock button on the remote control to enable it, then start the engine.

Ignition Modes

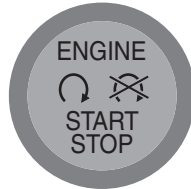

Off: Turns the ignition off.

- Without applying the brake pedal, press and release the button once when the ignition is in the on mode, or when the engine is running but the vehicle is not in motion.

Accessory: Allows some electrical accessories to operate while the engine is not running.

- Without applying the brake pedal, press and release the button once.

On: All electrical circuits are operational. Warning lamps and indicators are illuminated.

- Without applying the brake pedal, press and release the button once from accessory mode.
- Without applying the brake pedal, press and release the button twice from off mode.

Start: Starts the engine.

- Press the brake pedal, and then press the button for any length of time. An indicator light on the button illuminates when then ignition is on and when the engine starts.

Your vehicle may have remote start capability. Refer to *Remote start* in the *Keys and Remote Control* chapter.

STARTING A GASOLINE ENGINE

When you start the engine, the idle speed increases, this helps to warm up the engine. If the engine idle speed does not slow down automatically, have your vehicle checked by an authorized dealer.

Before starting the engine check the following:

- Make sure all occupants have fastened their safety belts.
- Make sure the headlamps and electrical accessories are off.
- Make sure the parking brake is on.
- Make sure the gearshift is in position **P**.

Note: Do not touch the accelerator pedal.

1. Fully press the brake pedal.
2. Press the button.

The system does not function if:

- The key frequencies are jammed.
- The key battery has no charge.

If you are unable to start your vehicle, do the following:



1. Locate the key backup slot at the front of the center console storage compartment.
2. With the buttons facing down, place the key into backup slot.
3. With the key in this position, press the brake pedal, then the button to switch the ignition on and start your vehicle.

Fast Restart

The fast restart feature allows you to restart the engine within 20 seconds of switching it off, even if a valid key is not present.

Within 20 seconds of switching the engine off, press the brake pedal and press the button. After 20 seconds have expired, you can no longer start the engine without the key present inside your vehicle.

Once the engine has started, it remains running until you press the button, even if the system does not detect a valid key. If you open and close a door while the engine is running, the system searches for a valid key. You cannot start the engine if the system does not detect a valid key within 20 seconds.

Failure to Start

If you cannot start the engine after three attempts, wait 10 seconds and follow this procedure:

1. Fully press the brake pedal.
2. Fully press the accelerator pedal and hold it there.
3. Start the engine.

148 Starting and Stopping the Engine

Stopping the Engine When Your Vehicle Is Stationary

1. Move the transmission selector lever to position **P**.
2. Press the button once.
3. Apply the parking brake.

Note: This switches off the ignition, all electrical circuits, warning lamps and indicators.

Note: If the engine is idling for 30 minutes, the ignition and engine automatically shut down.

Stopping the Engine When Your Vehicle Is Moving



WARNING: Switching off the engine when the vehicle is still moving will result in a loss of brake and steering assistance. The steering will not lock, but higher effort will be required. When the ignition is switched off, some electrical circuits, warning lamps and indicators may also be off.

1. Press and hold the button for one second, or press it three times within two seconds.
2. Move the transmission selector lever to position **N** and use the brakes to bring your vehicle to a safe stop. When your vehicle has stopped, move the transmission selector lever to position **P** and switch the ignition off.
3. Apply the parking brake.

Guarding Against Exhaust Fumes



WARNING: If you smell exhaust fumes inside your vehicle, have this checked immediately. Do not drive your vehicle if you smell exhaust fumes. Carbon monoxide is present in exhaust fumes. Take precautions to avoid its dangerous effects.

Important Ventilating Information

If you stop your vehicle and leave the engine idling for long periods, we recommend that you do one of the following:

- Open the windows at least 1 inch (2.5 centimeters).
- Set your climate control to outside air.

ENGINE BLOCK HEATER (IF EQUIPPED)

WARNING: Failure to follow engine block heater instructions could result in property damage or personal injury.



WARNING: Do not use your heater with ungrounded electrical systems or two-pronged (cheater) adapters. There is a risk of electrical shock.

Note: The heater is most effective when outdoor temperatures are below 0°F (-18°C).

The heater acts as a starting aid by warming the engine coolant. This allows the climate control system to respond quickly. The equipment includes a heater element (installed in the engine block) and a wire harness. You can connect the system to a grounded 120-volt A/C electrical source.

We recommend that you do the following for safe and correct operation:

- Use a 16-gauge outdoor extension cord that is product certified by Underwriter's Laboratory or Canadian Standards Association. This extension cord must be suitable for use outdoors, in cold temperatures, and be clearly marked *Suitable for Use with Outdoor Appliances*. Never use an indoor extension cord outdoors; it could result in an electric shock or become a fire hazard.
- Use as short an extension cord as possible.
- Do not use multiple extension cords.
- Make sure that when in operation, the extension cord plug and the heater cord plug connections are free and clear of water. This could cause an electric shock or fire.
- Make sure your vehicle is parked in a clean area, clear of combustibles.
- Make sure the heater, heater cord and extension cord are firmly connected.
- Check for heat anywhere in the electrical hookup once the system has been operating for approximately 30 minutes.
- Make sure the system is unplugged and properly stowed before driving your vehicle. Make sure the protective cover seals the prongs of the block heater cord plug when not in use.

150 **Starting and Stopping the Engine**

- Keep plug terminals clean and free of dirt and corrosion.
- Make sure the heater system is checked for proper operation before winter.

Using the Engine Block Heater

Make sure the receptacle terminals are clean and dry before use. To clean them, use a dry cloth.

The heater uses 0.4 to 1.0 kilowatt-hours of energy per hour of use. The system does not have a thermostat. It achieves maximum temperature after approximately three hours of operation. Using the heater longer than three hours does not improve system performance and unnecessarily uses electricity.

SAFETY PRECAUTIONS

WARNING: Do not overfill the fuel tank. The pressure in an overfilled tank may cause leakage and lead to fuel spray and fire.



WARNING: The fuel system may be under pressure. If you hear a hissing sound near the fuel filler inlet, do not refuel until the sound stops. Otherwise, fuel may spray out, which could cause serious personal injury.



WARNING: Automotive fuels can cause serious injury or death if misused or mishandled.



WARNING: The flow of fuel through a fuel pump nozzle can produce static electricity, which can cause a fire if fuel is pumped into an ungrounded fuel container.



WARNING: Fuel ethanol and gasoline may contain benzene, which is a cancer-causing agent.



WARNING: When refueling always shut the engine off and never allow sparks or open flames near the filler neck. Never smoke while refueling. Fuel vapor is extremely hazardous under certain conditions. Care should be taken to avoid inhaling excess fumes.

Observe the following guidelines when handling automotive fuel:

- Extinguish all smoking materials and any open flames before refueling your vehicle.
- Always turn off the vehicle before refueling.
- Automotive fuels can be harmful or fatal if swallowed. Fuel, such as gasoline, is highly toxic and if swallowed can cause death or permanent injury. If fuel is swallowed, call a physician immediately, even if no symptoms are immediately apparent. The toxic effects of fuel may not be visible for hours.
- Avoid inhaling fuel vapors. Inhaling too much fuel vapor of any kind can lead to eye and respiratory tract irritation. In severe cases, excessive or prolonged breathing of fuel vapor can cause serious illness and permanent injury.

- Avoid getting fuel liquid in your eyes. If fuel is splashed in the eyes, remove contact lenses (if worn), flush with water for 15 minutes and seek medical attention. Failure to seek proper medical attention could lead to permanent injury.
- Fuels can also be harmful if absorbed through the skin. If fuel is splashed on the skin or clothing, promptly remove contaminated clothing and wash skin thoroughly with soap and water. Repeated or prolonged skin contact with fuel liquid or vapor causes skin irritation.
- Be particularly careful if you are taking Antabuse or other forms of disulfiram for the treatment of alcoholism. Breathing gasoline vapors, or skin contact could cause an adverse reaction. In sensitive individuals, serious personal injury or sickness may result. If fuel is splashed on the skin, promptly wash skin thoroughly with soap and water. Consult a physician immediately if you experience an adverse reaction.

FUEL QUALITY

Note: Use of any fuel other than those recommended may cause powertrain damage and a loss of vehicle performance; repairs may not be covered under warranty.

Choosing the Right Fuel (Gasoline Engines)

Use only UNLEADED gasoline or UNLEADED gasoline blended with a maximum of 15% ethanol in your gasoline vehicle. If your vehicle is a Flex Fuel Vehicle (FFV), it will have a yellow bezel placed over the fuel fill inlet.

Do not use:

- Fuels containing more than 15% ethanol or E-85 fuel.
- Fuels containing methanol.
- Fuels containing metallic based additives, including manganese-based compounds.
- Fuels containing the octane booster additive, methylcyclopentadienyl manganese tricarbonyl (MMT).
- Leaded-fuel (The use of leaded fuel is prohibited by law).

Note: Use of any fuel other than recommended fuel can cause powertrain damage, impair the emission control system or cause loss of vehicle performance. Any damage to vehicle that is caused by use of fuel not recommended will not be covered under warranty.

Choosing the Right Fuel With a Flex Fuel Vehicle (If Equipped)

Use only UNLEADED gasoline or UNLEADED gasoline blended with a maximum of 85% ethanol (E-85) in your Flex Fuel Vehicle (FFV). If your vehicle is flex fuel capable, it will have a yellow bezel placed over the fuel fill inlet.

Do not use:

- Fuels containing more than 85% ethanol or E-100 fuel.
- Fuels containing methanol.
- Fuels containing metallic based additives, including manganese-based compounds.
- Fuels containing the octane booster additive, methylcyclopentadienyl manganese tricarbonyl (MMT).
- Leaded-fuel (The use of leaded fuel is prohibited by law).

Use of any fuel other than recommended fuel can cause powertrain damage, impair the emission control system or cause loss of vehicle performance. Any damage to a vehicle that is caused by use of fuel not recommended will not be covered under warranty.

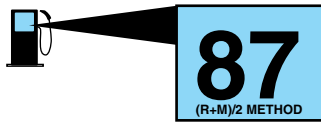
Octane Recommendations

Regular unleaded gasoline with a pump (R+M)/2 octane rating of 87 is recommended. Some stations offer fuels posted as “Regular” with an octane rating below 87,

particularly in high altitude areas. Fuels with octane levels below 87 are not recommended.

Do not be concerned if your engine sometimes knocks lightly. However, if it knocks heavily under most driving conditions while you are using fuel with the recommended octane rating, see your authorized dealer to prevent any engine damage.

RUNNING OUT OF FUEL

Avoid running out of fuel because this situation may have an adverse effect on powertrain components.

If you have run out of fuel:

- You may need to cycle the ignition from off to on several times after refueling to allow the fuel system to pump the fuel from the tank to the engine. On restarting, crank time will be a few seconds longer than normal. With keyless ignition, just start the engine. Crank time will be longer than usual.

- Normally, adding 1 gallon (3.8 liters) of fuel is enough to restart the engine. If the vehicle is out of fuel and on a steep grade, more than 1 gallon (3.8 liters) may be required.
- The service engine soon indicator may come on. For more information on the service engine soon indicator, see *Warning Lamps and Indicators* in the *Instrument Cluster* chapter.

Refilling with a Portable Fuel Container



WARNING: Do not insert the nozzle of a portable fuel container or aftermarket funnel into the capless fuel system. This could damage the fuel system and its seal, and may cause fuel to run onto the ground instead of filling the tank, which could result in serious personal injury.



WARNING: Do not try to pry open or push open the capless fuel system with foreign objects. This could damage the fuel system and its seal and cause injury to you or others.

Note: Do not use aftermarket funnels; they will not work with the capless fuel system and can damage it. The included funnel has been specially designed to work safely with your vehicle.

When filling the vehicle's fuel tank from a portable fuel container, use the funnel included with the vehicle.

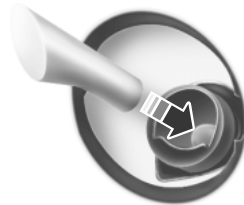

1. Locate the white plastic funnel in the spare tire compartment.
2. Slowly insert the funnel into the capless fuel system.
3. Fill the vehicle with fuel from the portable fuel container.
4. When done, clean the funnel or properly dispose of it. Extra funnels can be purchased from your authorized dealer if you choose to dispose of the funnel.

REFUELING

WARNING: Fuel vapor burns violently and a fuel fire can cause severe injuries. To help avoid injuries to you and others:

- Read and follow all the instructions on the pump island.
- Turn off your engine when you are refueling.
- Do not smoke if you are near fuel or refueling your vehicle.
- Keep sparks, flames and smoking materials away from fuel.
- Stay outside your vehicle and do not leave the fuel pump unattended when refueling your vehicle - this is against the law in some places.
- Keep children away from the fuel pump; never let children pump fuel.
- Do not use personal electronic devices while refueling.

Use the following guidelines to avoid electrostatic charge build-up when filling an ungrounded fuel container:

- Place approved fuel container on the ground.
- DO NOT fill a fuel container while it is in the vehicle (including the cargo area).
- Keep the fuel pump nozzle in contact with the fuel container while filling.
- DO NOT use a device that would hold the fuel pump handle in the fill position.

Easy Fuel® “No Cap” Fuel System

WARNING: The fuel system may be under pressure. If you hear a hissing sound near the fuel filler door, do not refuel until the sound stops. Otherwise, fuel may spray out, which could cause serious personal injury.

When fueling your vehicle:

1. Turn the engine off.
2. Open the fuel filler door.
3. Slowly insert the fuel filler nozzle fully into the fuel system and leave the nozzle fully inserted until you are done pumping. Pump fuel as normal.

4. After you are done pumping fuel, wait about five seconds before slowly removing the fuel filler nozzle. This allows residual fuel to drain back into the fuel tank and not spill onto the vehicle.

Note: A fuel spillage concern may occur if overfilling the fuel tank. Do not overfill the tank to the point that the fuel is able to bypass the fuel filler nozzle. The overfilled fuel may run down the drain located within the fuel filler housing and to the ground.

If the fuel fill inlet was not properly closed, a Check Fuel Fill Inlet message may appear on the instrument cluster.

At the next opportunity, do the following:

1. Safely pull off the road.
2. Turn off the engine.
3. Open the fuel filler door and remove any visible debris from the fuel fill opening.
4. Insert either the fuel fill nozzle or the fuel fill funnel provided with the vehicle several times to dislodge any debris and/or allow the inlet to close properly.

If this action corrects the problem, the message may not reset immediately. It may take several driving cycles for the message to turn off. A driving cycle consists of an engine start-up (after four or more hours with the engine off) followed by city/highway driving. Continuing to drive with the message on may cause the service engine soon lamp to turn on as well.

FUEL CONSUMPTION

Filling the Tank

The advertised capacity is the indicated capacity and the empty reserve combined. Indicated capacity is the difference in the amount of fuel in a full tank and a tank when the fuel gauge indicates empty. Empty reserve is the amount of fuel in the tank after the fuel gauge indicates empty.

Note: The amount of usable fuel in the empty reserve varies and should not be relied upon to increase driving range. When refueling your vehicle after the fuel gauge indicates empty, you might not be able to refuel the full amount of the advertised capacity of the fuel tank due to the empty reserve still present in the tank.

For consistent results when filling the fuel tank:

- Turn the ignition off before fueling; an inaccurate reading results if the engine is left running.

- Use the same fill rate (low–medium–high) each time the tank is filled.
- Allow no more than two automatic click–offs when filling.

Results are most accurate when the filling method is consistent.

Calculating Fuel Economy

Do not measure fuel economy during the first 1000 miles (1600 kilometers) of driving (this is your engine's break-in period); a more accurate measurement is obtained after 2000 miles–3000 miles (3200 kilometers–4800 kilometers). Also, fuel expense, frequency of fill-ups or fuel gauge readings are not accurate ways to measure fuel economy.

1. Fill the fuel tank completely and record the initial odometer reading.
2. Each time you fill the tank, record the amount of fuel added.
3. After at least three to five tank fill-ups, fill the fuel tank and record the current odometer reading.
4. Subtract your initial odometer reading from the current odometer reading.
5. Calculate fuel economy as follows:

Standard: Divide miles traveled by gallons used.

Metric: Multiply liters used by 100, then divide by kilometers traveled.

Keep a record for at least one month and record the type of driving (city or highway). This provides an accurate estimate of the vehicle's fuel economy under current driving conditions. Additionally, keeping records during summer and winter show how temperature impacts fuel economy. In general, lower temperatures mean lower fuel economy.

EMISSION CONTROL SYSTEM



WARNING: Do not park, idle, or drive your vehicle in dry grass or other dry ground cover. The emission system heats up the engine compartment and exhaust system, which can start a fire.



WARNING: Exhaust leaks may result in entry of harmful and potentially lethal fumes into the passenger compartment. If you smell exhaust fumes inside your vehicle, have your dealer inspect your vehicle immediately. Do not drive if you smell exhaust fumes.

Your vehicle is equipped with various emission control components and a catalytic converter which will enable your vehicle to comply with applicable exhaust emission standards. To make sure that the catalytic converter and other emission control components continue to work properly:

- Use only the specified fuel listed.
- Avoid running out of fuel.
- Do not turn off the ignition while your vehicle is moving, especially at high speeds.
- Have the items listed in *Scheduled Maintenance Information* performed according to the specified schedule.

The scheduled maintenance items listed in *Scheduled Maintenance Information* are essential to the life and performance of your vehicle and to its emissions system.

If other than Ford, Motorcraft® or Ford-authorized parts are used for maintenance replacements or for service of components affecting emission control, such non-Ford parts should be equivalent to genuine Ford Motor Company parts in performance and durability.

Illumination of the service engine soon indicator, charging system warning light or the temperature warning light, fluid leaks, strange odors, smoke or loss of engine power could indicate that the emission control system is not working properly.

An improperly operating or damaged exhaust system may allow exhaust to enter the vehicle. Have a damaged or improperly operating exhaust system inspected and repaired immediately.

Do not make any unauthorized changes to your vehicle or engine. By law, vehicle owners and anyone who manufactures, repairs, services, sells, leases, trades vehicles, or supervises a fleet of vehicles are not permitted to intentionally remove an emission control device or prevent it from working. Information about your vehicle's emission system is on the Vehicle Emission Control Information Decal located on or near the engine. This decal also lists engine displacement.

Please consult your warranty information for complete emission warranty information.

On-board Diagnostics (OBD-II)

Your vehicle is equipped with a computer that monitors the engine's emission control system. This system is commonly known as the on-board diagnostics system (OBD-II). The OBD-II system protects the environment by ensuring that your vehicle continues to meet government emission standards. The OBD-II system also assists your authorized dealer in properly servicing your vehicle.



When the service engine soon indicator illuminates, the OBD-II system has detected a malfunction. Temporary malfunctions may cause the service engine soon indicator to illuminate.

Examples are:

1. The vehicle has run out of fuel—the engine may misfire or run poorly.
2. Poor fuel quality or water in the fuel—the engine may misfire or run poorly.
3. The fuel fill inlet may not have been properly closed. See *Easy Fuel® No Cap Fuel System* in this chapter.
4. Driving through deep water—the electrical system may be wet.

These temporary malfunctions can be corrected by filling the fuel tank with good quality fuel, properly closing the fuel fill inlet or letting the electrical system dry out. After three driving cycles without these or any other temporary malfunctions present, the service engine soon indicator should stay off the next time the engine is started. A driving cycle consists of a cold engine start-up followed by mixed city or highway driving. No additional vehicle service is required.

If the service engine soon indicator remains on, have your vehicle serviced at the first available opportunity. Although some malfunctions detected by the OBD-II may not have symptoms that are apparent, continued driving with the service engine soon indicator on can result in increased emissions, lower fuel economy, reduced engine and transmission smoothness, and can lead to more costly repairs.

Readiness for Inspection/Maintenance (I/M) Testing

Some state, provincial and local governments may have Inspection/Maintenance (I/M) programs to inspect the emission control equipment on your vehicle. Failure to pass this inspection could prevent you from getting a vehicle registration.



If the service engine soon indicator is on or the bulb does not work, the vehicle may need to be serviced. See *On-board Diagnostics (OBD-II)* in this chapter.

Your vehicle may not pass the I/M test if the service engine soon indicator is on or not working properly (bulb is burned out), or if the OBD-II system has determined that some of the emission control systems have not been properly checked. In this case, the vehicle is considered not ready for I/M testing.

If the vehicle's engine or transmission has just been serviced, or the battery has recently run down or been replaced, the OBD-II system may indicate that the vehicle is not ready for I/M testing. To determine if the vehicle is ready for I/M testing, turn the ignition key to the on position for 15 seconds without cranking the engine. If the service engine soon indicator blinks eight times, it means that the vehicle is not ready for I/M testing; if the service engine soon indicator stays on solid, it means that the vehicle is ready for I/M testing.

The OBD-II system is designed to check the emission control system during normal driving. A complete check may take several days. If the vehicle is not ready for I/M testing, the following driving cycle consisting of mixed city and highway driving may be performed:

15 minutes of steady driving on an expressway or highway followed by 20 minutes of stop-and-go driving with at least four 30-second idle periods.

Allow the vehicle to sit for at least eight hours without starting the engine. Then, start the engine and complete the above driving cycle. The engine must warm up to its normal operating temperature. Once the engine is started, do not turn off the engine until the above driving cycle is complete. If the vehicle is still not ready for I/M testing, the above driving cycle will have to be repeated.

AUTOMATIC TRANSMISSION

WARNING: Always set the parking brake fully and make sure the gearshift is latched in P (Park). Turn the ignition to the off position and remove the key whenever you leave your vehicle.

Your vehicle has been designed to improve fuel economy by reducing fuel usage while coasting or decelerating. When you take your foot off the accelerator pedal and the vehicle begins to slow down, the torque converter clutch locks up and aggressively shuts off fuel flow to the engine while decelerating. This fuel economy benefit may be perceived as a light to medium braking sensation when removing your foot from the accelerator pedal.

**P (Park)**

This position locks the transmission and prevents the front wheels from turning.

To put your vehicle in gear:

- Press the brake pedal
- Move the gearshift lever into the desired gear

To put your vehicle in P (Park):

- Come to a complete stop
- Move the gearshift lever and securely latch it in P (Park)

R (Reverse)

With the gearshift lever in R (Reverse), the vehicle will move backward. Always come to a complete stop before shifting into and out of R (Reverse).

N (Neutral)

With the gearshift lever in N (Neutral), the vehicle can be started and is free to roll. Hold the brake pedal down while in this position.

D (Drive) with overdrive

The normal driving position for the best fuel economy. Transmission operates in gears one through six. The automatic transmission shift strategy has the ability to detect hilly terrain or mountainous areas and will provide a limited amount of grade assist features automatically.

S (Sport)

Moving the gearshift lever to S (Sport):

- Provides additional grade (engine) braking and extends lower gear operation to enhance performance for uphill climbs, hilly terrain or mountainous areas. This will increase engine RPM during engine braking.
- Provides additional lower gear operation through the automatic transmission shift strategy which reacts to vehicle inputs (vehicle acceleration, accelerator pedal, brake pedal and vehicle speed).
- Gears are selected more quickly and at higher engine speeds.

SelectShift Automatic® Transmission

Note: Your transmission must be in S (Sport) for SelectShift to operate properly.

Your SelectShift Automatic transmission gives you the ability to change gears manually. To use SelectShift, move the gearshift lever into S (Sport). Now you can use the paddles on your steering wheel to manually select gears.

**Paddle Shifters**

With your vehicle in D (Drive), the paddle shifters provide temporary manual control. They allow you the ability to shift gears quickly without taking your hands off the steering wheel.

You can achieve extensive manual control by moving the gearshift lever into S (Sport).

When using the paddles for manual shifting:

- Pull the right paddle (+) to upshift.
- Pull the left paddle (–) to downshift.



Upshift to the recommended shift speeds according to the following chart:

Upshifts when accelerating (recommended for best fuel economy)	
Shift from:	
1 - 2	15 mph (24 km/h)
2 - 3	25 mph (40 km/h)
3 - 4	40 mph (64 km/h)
4 - 5	45 mph (72 km/h)
5 - 6	50 mph (80 km/h)

The instrument cluster will display your currently selected gear.

SelectShift will automatically make some downshifts for you if it has determined that you have not downshifted in time. Although SelectShift will make some downshifts for you, it will still allow you to downshift at any time as long as SelectShift determines that the engine will not be damaged from over-revving.

Note: If manual control is no longer desired, return the gear shift lever from S (Sport) to D (Drive).

Note: Engine damage may occur if excessive engine revving is held without shifting.

Automatic Transmission Adaptive Learning

This feature is designed to increase durability and provide consistent shift feel over the life of the vehicle. A new vehicle or transmission may have firm shifts, soft shifts or both. This operation is considered normal and will not affect function or durability of the transmission. Over time, the adaptive learning process will fully update transmission operation. Additionally, whenever the battery is disconnected or a new battery installed, the strategy must be relearned.

Brake-shift interlock

WARNING: Do not drive your vehicle until you verify that the brakelamps are working.



WARNING: When doing this procedure, you will be taking the vehicle out of park which means the vehicle can roll freely. To avoid unwanted vehicle movement, always fully set the parking brake prior to doing this procedure. Use wheel chocks if appropriate.



WARNING: If the parking brake is fully released, but the brake warning lamp remains illuminated, the brakes may not be working properly. See your authorized dealer.

Use the BSI lever to move the gearshift lever from the park position in the event of an electrical malfunction or if your vehicle has a dead battery.

Apply the parking brake, turn the ignition key to the off position, and remove the key.



1. Using a screwdriver (or similar tool), carefully pry off and remove the Brake shift interlock access panel.

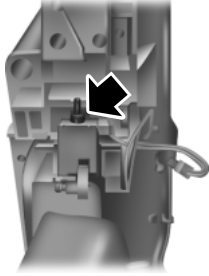

2. Locate the brake shift interlock lever in front of the shifter assembly.

3. Apply the brake pedal. Gently push and hold the brake shift interlock lever while pulling the gearshift lever out of the P (Park) position and into the N (Neutral) position.

4. Install the trim panel.

5. Apply the brake pedal, start the vehicle, and release the parking brake.

Note: See your authorized dealer as soon as possible if this procedure is used.

If Your Vehicle Gets Stuck in Mud or Snow

Note: Do not rock the vehicle if the engine is not at normal operating temperature or damage to the transmission may occur.

Note: Do not rock the vehicle for more than a minute or damage to the transmission and tires may occur, or the engine may overheat.

If your vehicle gets stuck in mud or snow, it may be rocked out by shifting between forward and reverse gears, stopping between shifts in a steady pattern. Press lightly on the accelerator in each gear.

USING YOUR ALL-WHEEL DRIVE (AWD) SYSTEM (IF EQUIPPED)

AWD uses all four wheels to power the vehicle. This increases traction, enabling you to drive over terrain and road conditions that a conventional two-wheel drive vehicles cannot. The AWD system is active all the time and requires no input from the operator.

Note: Your AWD vehicle is not intended for off-road use. The AWD feature gives your vehicle some limited off-road capabilities in which driving surfaces are relatively level, obstruction-free and otherwise similar to normal on-road driving conditions. Operating your vehicle under other than those conditions could subject the vehicle to excessive stress which might result in damage which is not covered under your warranty.

Note: When an AWD system fault is present, the warning Check AWD will display in the information display. The AWD system is not functioning correctly and defaulted to front-wheel drive. When this warning is displayed, have your vehicle serviced at an authorized dealer.

Note: The AWD Off message may also be displayed in the information display if the AWD system has overheated and defaulted to front-wheel drive. This condition may occur if the vehicle was operated in extreme conditions with excessive wheel slip, such as deep sand. To resume normal AWD function as soon as possible, stop the vehicle in a safe location and stop the engine for at least 10 minutes. After the engine has been restarted and the AWD system has adequately cooled, the AWD Off message will turn off and normal AWD function will return. In the event the engine is not stopped, the AWD Off message will turn off when the system cools and normal AWD function returns.

Do not use a spare tire of a different size other than the tire provided. If the mini-spare tire is installed, the AWD system may disable automatically and enter front-wheel drive only mode to protect driveline components. This condition may be indicated by an AWD Off message in the information display. If there is an AWD Off message in the message center from using the spare tire, this indicator should turn off after reinstalling the repaired or replaced normal road tire and cycling the ignition off and on. It is recommended to reinstall the repaired or replaced road tire as soon as possible. Major dissimilar tire sizes between the front and rear axles could cause the AWD system to stop functioning and default to front-wheel drive or damage the AWD system.

Driving In Special Conditions With All-Wheel Drive (AWD)

AWD vehicles are equipped for driving on sand, snow, mud and rough roads and have operating characteristics that are somewhat different from conventional vehicles, both on and off the highway.

When driving at slow speeds in deep sand under high outside temperatures, use a low gear when possible. Lower gear operation will maximize the engine and transmission cooling capability.

Under severe operating conditions, the A/C may cycle on and off to protect overheating of the engine.

Basic operating principles in special conditions

- Drive slower in strong crosswinds which can affect the normal steering characteristics of your vehicle.
- Be extremely careful when driving on pavement made slippery by loose sand, water, gravel, snow or ice.

If Your Vehicle Goes Off the Edge of the Pavement

- If your vehicle goes off the edge of the pavement, slow down, but avoid severe brake application, ease the vehicle back onto the pavement only after reducing your speed. Do not turn the steering wheel too sharply while returning to the road surface.
- It may be safer to stay on the apron or shoulder of the road and slow down gradually before returning to the pavement. You may lose control if you do not slow down or if you turn the steering wheel too sharply or abruptly.
- It often may be less risky to strike small objects, such as highway reflectors, with minor damage to your vehicle rather than attempt a sudden return to the pavement which could cause the vehicle to slide sideways out of control or rollover. Remember, your safety and the safety of others should be your primary concern.

If Your Vehicle Gets Stuck

WARNING: Always set the parking brake fully and make sure the gearshift is latched in P (Park). Turn the ignition to the lock position and remove the key whenever you leave your vehicle.



WARNING: If the parking brake is fully released, but the brake warning lamp remains illuminated, the brakes may not be working properly. See your authorized dealer.



WARNING: Do not spin the wheels at over 35 mph (56 km/h). The tires may fail and injure a passenger or bystander.

Note: Do not rock the vehicle if the engine is not at normal operating temperature or damage to the transmission may occur.

Note: Do not rock the vehicle for more than a few minutes or damage to the transmission and tires may occur or the engine may overheat.

If your vehicle gets stuck in mud or snow it may be rocked out by shifting between forward and reverse gears, stopping between shifts, in a steady pattern. Press lightly on the accelerator in each gear.

If your vehicle is equipped with AdvanceTrac® with Roll Stability Control™, it may be beneficial to disengage the AdvanceTrac® with Roll Stability Control™ system while attempting to rock the vehicle.

Emergency Maneuvers

- In an unavoidable emergency situation where a sudden sharp turn must be made, remember to avoid “over-driving” your vehicle (i.e., turn the steering wheel only as rapidly and as far as required to avoid the emergency). Excessive steering will result in less vehicle control, not more. Additionally, smooth variations of the accelerator and/or brake pedal pressure should be utilized if changes in vehicle speed are called for. Avoid abrupt steering, acceleration or braking which could result in an increased risk of loss of vehicle control, vehicle rollover and/or personal injury. Use all available road surface to return the vehicle to a safe direction of travel.
- In the event of an emergency stop, avoid skidding the tires and do not attempt any sharp steering wheel movements.
- If the vehicle goes from one type of surface to another (i.e., from concrete to gravel) there will be a change in the way the vehicle responds to a maneuver (steering, acceleration or braking). Again, avoid these abrupt inputs.

Sand

When driving over sand, try to keep all four wheels on the most solid area of the trail. Avoid reducing the tire pressures but shift to a lower gear and drive steadily through the terrain. Apply the accelerator slowly and avoid excessive wheel slip.

Do not drive your vehicle in deep sand for an extended period of time. This could cause the AWD system to overheat and default to front-wheel drive. If this occurs AWD Off will be displayed in the Information Display.

To resume normal AWD function as soon as possible, stop the vehicle in a safe location and stop the engine for at least 10 minutes. After the engine has been restarted and the AWD system has adequately cooled,

the AWD Off message will turn off and normal AWD function will return. In the event the engine is not stopped, the AWD Off message will turn off when the system cools and normal AWD function returns.

When driving at slow speeds in deep sand under high outside temperatures, use L (Low) gear when possible. L (Low) gear operation will maximize the engine and transmission cooling capability.

Under severe operating conditions, the A/C may cycle on and off to protect overheating of the engine.

Avoid driving at excessive speeds, this causes vehicle momentum to work against you and your vehicle could become stuck to the point that assistance may be required from another vehicle. Remember, you may be able to back out the way you came if you proceed with caution.

Mud and Water

If you must drive through high water, drive slowly. Traction or brake capability may be limited.

When driving through water, determine the depth; avoid water higher than the bottom of the wheel rims (for cars) or the bottom of the hubs (for trucks) (if possible) and proceed slowly. If the ignition system gets wet, the vehicle may stall.

Once through water, always try the brakes. Wet brakes do not stop the vehicle as effectively as dry brakes. Drying can be improved by moving your vehicle slowly while applying light pressure on the brake pedal.

Be cautious of sudden changes in vehicle speed or direction when you are driving in mud. Even AWD vehicles can lose traction in slick mud. As when you are driving over sand, apply the accelerator slowly and avoid spinning your wheels. If the vehicle does slide, steer in the direction of the slide until you regain control of the vehicle.

After driving through mud, clean off residue stuck to rotating driveshafts and tires. Excess mud stuck on tires and rotating driveshafts causes an imbalance that could damage drive components.

Note: Driving through deep water may damage the transmission.

If the front or rear axle is submerged in water, the axle lubricant and PTU (power transfer unit) lubricant should be checked and changed if necessary.



“Tread Lightly” is an educational program designed to increase public awareness of land-use regulations and responsibilities in our nations wilderness areas. Ford Motor Company joins the U.S. Forest

Service and the Bureau of Land Management in encouraging you to help preserve our national forest and other public and private lands by “treading lightly.”

Driving on Hilly or Sloping Terrain

Note: Avoid driving crosswise or turning on steep slopes or hills. A danger lies in losing traction, slipping sideways and possibly rolling over. Whenever driving on a hill, determine beforehand the route you will use. Do not drive over the crest of a hill without seeing what conditions are on the other side. Do not drive in reverse over a hill without the aid of an observer.

Although natural obstacles may make it necessary to travel diagonally up or down a hill or steep incline, you should always try to drive straight up or straight down.

When climbing a steep slope or hill, start in a lower gear rather than downshifting to a lower gear from a higher gear once the ascent has started. This reduces strain on the engine and the possibility of stalling.

If you do stall out, do not try to turnaround because you might roll over. It is better to back down to a safe location.

Apply just enough power to the wheels to climb the hill. Too much power will cause the tires to slip, spin or lose traction, resulting in loss of vehicle control.



Descend a hill in the same gear you would use to climb up the hill to avoid excessive brake application and brake overheating. Do not descend in neutral; instead, disengage overdrive or manually shift to a lower gear. When descending a steep hill, avoid sudden hard braking as you could lose control. The front wheels have to be turning in order to steer the vehicle.

Your vehicle has anti-lock brakes, therefore apply the brakes steadily. Do not “pump” the brakes.

Driving on Snow and Ice



WARNING: If you are driving in slippery conditions that require tire chains or cables, then it is critical that you drive cautiously. Keep speeds down, allow for longer stopping distances and avoid aggressive steering to reduce the chances of a loss of vehicle control which can lead to serious injury or death. If the rear end of the vehicle slides while cornering, steer in the direction of the slide until you regain control of the vehicle.

Note: Excessive tire slippage can cause transmission damage.

AWD vehicles have advantages over 2WD vehicles in snow and ice but can skid like any other vehicle.

Should you start to slide while driving on snowy or icy roads, turn the steering wheel in the direction of the slide until you regain control.

Avoid sudden applications of power and quick changes of direction on snow and ice. Apply the accelerator slowly and steadily when starting from a full stop.

Avoid sudden braking as well. Although an AWD vehicle may accelerate better than a two-wheel drive vehicle in snow and ice, it won't stop any faster, because as in other vehicles, braking occurs at all four wheels. Do not become overconfident as to road conditions.

Make sure you allow sufficient distance between you and other vehicles for stopping. Drive slower than usual and consider using one of the lower gears. In emergency stopping situations, apply the brake steadily. Since your vehicle is equipped with a four wheel anti-lock brake system (ABS), do not “pump” the brakes. Refer to the *Brakes* chapter for additional information on the operation of the anti-lock brake system.

Maintenance and Modifications

The suspension and steering systems on your vehicle have been designed and tested to provide predictable performance whether loaded or empty and durable load carrying capability. For this reason, Ford Motor Company strongly recommends that you do not make modifications such as adding or removing parts (such as lift kits or stabilizer bars) or by using replacement parts not equivalent to the original factory equipment.

Any modifications to a vehicle that raise the center of gravity can make it more likely the vehicle will rollover as a result of a loss of control. Ford Motor Company recommends that caution be used with any vehicle equipped with a high load or device (such as ladder or luggage racks).

Failure to maintain your vehicle properly may void the warranty, increase your repair cost, reduce vehicle performance and operational capabilities and adversely affect driver and passenger safety. Frequent inspection of vehicle chassis components is recommended if the vehicle is subjected to off-highway usage.

GENERAL INFORMATION

Note: Occasional brake noise is normal. If a metal-to-metal, continuous grinding or continuous squeal sound is present, the brake linings may be worn out. Have them inspected by an authorized dealer. If your vehicle has continuous vibration or shudder in the steering wheel while braking, have your vehicle inspected by an authorized dealer.

Note: Brake dust may accumulate on the wheels, even under normal driving conditions. Some dust is inevitable as the brakes wear and does not contribute to brake noise. See the *Vehicle Care* chapter for wheel cleaning instructions.



See the *Instrument Cluster* chapter for information on the brake system warning light.

Wet brakes result in reduced braking efficiency. Gently press the brake pedal a few times when driving from a car wash or standing water to dry the brakes.

Brake Over Accelerator

In the event the accelerator pedal becomes stuck or entrapped, apply steady and firm pressure to the brake pedal to slow your vehicle and reduce engine power. If you experience this condition, apply the brakes and bring your vehicle to a safe stop. Turn the engine off, shift to park (P) and apply the parking brake. Inspect the accelerator pedal and the area around it for any items or debris that may be obstructing its movement. If none are found and the condition persists, have your vehicle towed to the nearest authorized dealer.

Brake Assist

Brake assist detects when you brake heavily by measuring the rate at which you press the brake pedal. It provides maximum braking efficiency as long as you press the pedal. Brake assist can reduce stopping distances in critical situations.

Anti-Lock Brake System

This system helps you maintain steering control during emergency stops by keeping the brakes from locking.



This lamp momentarily illuminates when you turn the ignition on. If the light does not illuminate during start-up, remains on or flashes, the anti-lock brake system may be disabled and may need to be serviced.



If the anti-lock brake system is disabled, normal braking is still effective. If the brake warning lamp illuminates with the parking brake released, have your brake system serviced immediately.

HINTS ON DRIVING WITH ANTI-LOCK BRAKES

When the system is operating, the brake pedal will pulse and may travel further. Maintain pressure on the brake pedal. You may also hear a noise from the system. This is normal.

The anti-lock braking system will not eliminate the dangers inherent when:

- You drive too closely to the vehicle in front of you.
- Your vehicle is hydroplaning.
- You take corners too fast.
- The road surface is poor.

PARKING BRAKE



WARNING: If the parking brake is fully released, but the brake warning lamp remains illuminated, then driving your vehicle could result in reduced braking ability, increased stopping distances and potential loss of brakes. See your authorized dealer as soon as possible.



WARNING: Always set the parking brake fully and make sure that the transmission is securely latched in park (P). Failure to set the parking brake and engage park could result in vehicle roll-away, property damage or bodily injury.

To set the parking brake, press the parking brake pedal down to its fullest extent.

To release the parking brake, press the parking brake pedal down again.

HILL START ASSIST



WARNING: The hill start assist feature does not replace the parking brake. When you leave the vehicle, always apply the parking brake and shift the transmission into park (P).



WARNING: You must remain in the vehicle once you have activated the hill start assist feature.



WARNING: During all times, you are responsible for controlling the vehicle, supervising the hill start assist system and intervening, if required.



WARNING: If the engine is revved excessively, or if a malfunction is detected when the hill start assist feature is active, the hill start assist feature will be deactivated.

Hill start assist keeps your vehicle stationary long enough to move your foot from the brake pedal to the accelerator pedal when your vehicle is on a slope.

The brakes are released automatically once the engine has developed sufficient drive to prevent the vehicle from rolling down the slope. This is an advantage when pulling away on a slope, (for example from a car park ramp, traffic lights or when reversing uphill into a parking space).

Using Hill Start Assist

1. Press the brake pedal to bring the vehicle to a complete standstill. Keep the brake pedal pressed.
2. If the sensors detect that the vehicle is on a slope, the hill start assist feature will be activated automatically.
3. When you remove your foot from the brake pedal, the vehicle will remain on the slope without rolling away for approximately two or three seconds. This hold time will automatically be extended if you are in the process of driving off.
4. Drive off in the normal manner. The brakes will be released automatically.

PRINCIPLES OF OPERATION

The traction control system helps avoid drive wheel spin and loss of traction.

If your vehicle begins to slide, the system applies the brakes to individual wheels and, when needed, reduces engine power at the same time. If the wheels spin when accelerating on slippery or loose surfaces, the system reduces engine power in order to increase traction.

USING TRACTION CONTROL

In certain situations (for example, stuck in snow or mud), turning the traction control off may be beneficial as this allows the wheels to spin with full engine power. Turn the traction control system off through the information display. See the *Information Displays* chapter.

System Indicator Lights and Messages

WARNING: If a failure has been detected within the Traction Control System, the stability control light will illuminate steadily. Verify that the Traction Control System was not manually disabled using the information display control. If the stability control light still illuminates steadily, have the system serviced by an authorized dealer immediately. Operating your vehicle with Traction Control disabled could lead to an increased risk of loss of vehicle control, vehicle rollover, personal injury and death.



The stability control light temporarily illuminates on engine start-up and flashes when a driving condition activates the stability system.



The stability control off light temporarily illuminates on engine start-up and stays on when the traction control system is turned off or if a problem occurs in the stability system.

When the traction control system is turned off or on, a message appears in the information display showing system status.

PRINCIPLES OF OPERATION

WARNING: Vehicle modifications involving braking system, aftermarket roof racks, suspension, steering system, tire construction or wheel and tire size may change the handling characteristics of the vehicle and may adversely affect the performance of the AdvanceTrac® system. In addition, installing any stereo loudspeakers may interfere with and adversely affect the AdvanceTrac® system. Install any aftermarket stereo loudspeaker as far as possible from the front center console, the tunnel, and the front seats in order to minimize the risk of interfering with the AdvanceTrac® sensors. Reducing the effectiveness of the AdvanceTrac® system could lead to an increased risk of loss of vehicle control, vehicle rollover, personal injury and death.



WARNING: Remember that even advanced technology cannot defy the laws of physics. It's always possible to lose control of a vehicle due to inappropriate driver input for the conditions. Aggressive driving on any road condition can cause you to lose control of your vehicle increasing the risk of personal injury or property damage. Activation of the AdvanceTrac® system is an indication that at least some of the tires have exceeded their ability to grip the road; this could reduce the operator's ability to control the vehicle potentially resulting in a loss of vehicle control, vehicle rollover, personal injury and death. If your AdvanceTrac® system activates, SLOW DOWN.

The AdvanceTrac® with Roll Stability Control™ system helps you keep control of your vehicle when on a slippery surface. The electronic stability control portion of the system helps avoid skids and lateral slides and roll stability control helps avoid a vehicle rollover. The traction control system helps avoid drive wheel spin and loss of traction. See the *Traction Control* chapter for details on traction control system operation.

A Vehicle without AdvanceTrac with RSC skidding off its intended route.

B Vehicle with AdvanceTrac with RSC maintaining control on a slippery surface.

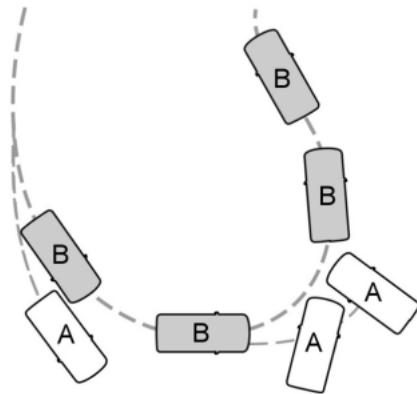

USING ADVANCETRAC® WITH RSC®

The system automatically activates when you start your engine. The AdvanceTrac® with RSC® system cannot be completely turned off, but the electronic stability control and roll stability control portions of the system are disabled when the transmission is in reverse (R). You can turn the traction control portion of the system off independently. See the *Traction Control* chapter.

SENSING SYSTEM

WARNING: To help avoid personal injury, please read and understand the limitations of the system as contained in this section. Sensing is only an aid for some (generally large and fixed) objects when moving in reverse on a flat surface at parking speeds. Traffic control systems, inclement weather, air brakes, and external motors and fans may also affect the function of the sensing system; this may include reduced performance or a false activation.



WARNING: To help avoid personal injury, always use caution when in R (Reverse) and when using the sensing system.



WARNING: This system is not designed to prevent contact with small or moving objects. The system is designed to provide a warning to assist the driver in detecting large stationary objects to avoid damaging the vehicle. The system may not detect smaller objects, particularly those close to the ground.



WARNING: Certain add-on devices such as large trailer hitches, bike or surfboard racks and any device that may block the normal detection zone of the system, may create false beeps.

Note: Keep the sensors (located on the bumper/fascia) free from snow, ice and large accumulations of dirt. If the sensors are covered, the system's accuracy can be affected. Do not clean the sensors with sharp objects.

Note: If your vehicle sustains damage to the bumper/fascia, leaving it misaligned or bent, the sensing zone may be altered causing inaccurate measurement of obstacles or false alarms.

The sensing system warns the driver of obstacles within a certain range of the bumper area. The system turns on automatically whenever the ignition is switched on.

When receiving a detection warning, the radio volume is reduced to a predetermined level. After the warning goes away, the radio volume returns to the previous level.

The system can be turned off using the information display control. Refer to the *Information Display* chapter.

If a fault is present in the system, a warning message appears in the information display and does not allow the driver to switch the faulted system on.

Note: If your vehicle is equipped with MyKey®, it is possible to prevent turning the sensing system off. Refer to the *MyKey®* chapter.

Using the Rear Sensing System

The rear sensors are only active when the transmission is in **R**. As the vehicle moves closer to the obstacle, the rate of the audible warning increases. When the obstacle is fewer than 12 inches (30 centimeters) away, the warning sounds continuously. If a stationary or receding object is detected farther than 12 inches (30 centimeters) from the side of the vehicle, the tone sounds for only three seconds. Once the system detects an object approaching, the warning sounds again.

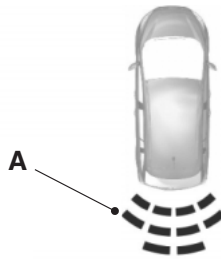

A. Coverage area of up to 6 feet (2 meters) from the rear bumper (with a decreased coverage area at the outer corners of the bumper).

The system detects certain objects while the transmission is in **R**:

- and moving toward a stationary object at a speed of 3 mph (5 km/h) or less.
- but not moving, and a moving object is approaching the rear of the vehicle at a speed of 3 mph (5 km/h) or less.

REAR VIEW CAMERA SYSTEM





WARNING: The rear view camera system is a reverse aid supplement device that still requires the driver to use it in conjunction with the interior and exterior mirrors for maximum coverage.



WARNING: Objects that are close to either corner of the bumper or under the bumper, might not be seen on the screen due to the limited coverage of the camera system.

 **WARNING:** Back up as slow as possible since higher speeds might limit your reaction time to stop the vehicle.

 **WARNING:** Use caution when using the rear video camera and the liftgate is ajar. If the liftgate is ajar, the camera will be out of position and the video image may be incorrect. All guidelines have been removed when the liftgate is ajar.

 **WARNING:** Use caution when turning camera features on or off while in R (Reverse). Make sure the vehicle is not moving.

The rear view camera system provides a video image of the area behind the vehicle.

During operation, lines appear in the display which represent your vehicle's path and proximity to objects behind the vehicle.

The camera is located on the liftgate.

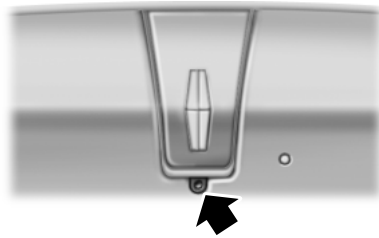

Using the Rear View Camera System

The rear view camera system displays what is behind your vehicle when you place the transmission in R (Reverse). The system uses two types of guides to help you see what is behind your vehicle:

1. Fixed guidelines: Show the actual path the vehicle is moving in while reversing in a straight line, which can be helpful when backing into a parking space or aligning the vehicle with another object behind the vehicle.
2. Centerline: Helps align the center of the vehicle with an object (i.e. a trailer).

Note: If the transmission is in R (Reverse) and the liftgate is ajar, no rear view camera features are displayed.

Note: If the image comes on while the transmission is not in R (Reverse), have the system inspected by your authorized dealer.

Note: When towing, the camera only sees what is being towed behind the vehicle. This might not provide adequate coverage as it usually provides in normal operation and some objects might not be seen. In some vehicles, the guidelines may disappear once the trailer tow connector is engaged.

Note: The camera may not operate correctly under the following conditions:

- Nighttime or dark areas if one or both reverse lamps are not operating.
- The camera's view is obstructed by mud, water or debris. Clean the lens with a soft, lint-free cloth and non-abrasive cleaner.
- The rear of the vehicle is hit or damaged, causing the camera to become misaligned.

Adjusting the Rear View Camera Settings

To access any of the rear view camera system settings, make the following selections in the touch screen when the transmission is not in R (Reverse):

1. Menu
2. Vehicle
3. Camera Settings

After changing a system setting, the touch screen shows a preview of the feature(s) selected.

Guidelines and the Centerline

Note: Fixed guidelines are only available when the transmission is in R (Reverse).

Note: The centerline is only available if Fixed guidelines are on.

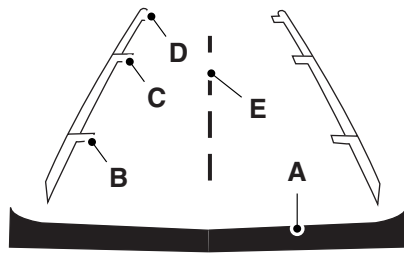

- A. Rear bumper
- B. Fixed guideline: Red zone
- C. Fixed guideline: Yellow zone
- D. Fixed guideline: Green zone
- E. Centerline

The fixed guidelines fade in and out depending on the steering wheel position.

Always use caution while reversing. Objects in the red zone are closest to your vehicle and objects in the green zone are further away. Objects are getting closer to your vehicle as they move from the green zone to the yellow or red zones. Use the side view mirrors and rear view mirror to get better coverage on both sides and rear of the vehicle.

Enhanced Park Aids

Note: Enhanced park aids is only available when the transmission is in R (Reverse).

Note: The reverse sensing system is not effective at speeds above 3 mph (5 km/h) and may not detect certain angular or moving objects.

The enhanced park aids allows the driver to view the area that is being detected by the reverse sensing system. The system uses red, yellow and green highlights which appear on top of the video image when an object is detected by the reverse sensing system. The alert highlights the closest object detected. The reverse sensing alert can be disabled and if enhanced park aids is enabled, highlighted areas are still displayed.

Selectable settings for this feature are ON and OFF.

Manual Zoom

 **WARNING:** When manual zoom is on, the full area behind the vehicle is not shown. Be aware of your surroundings when using the manual zoom feature.

Note: Manual zoom is only available when the transmission is in R (Reverse).

Note: When manual zoom is enabled, only the centerline is shown.

Allows the driver to get a closer view of an object behind the vehicle. The zoomed image keeps the bumper in the image to provide a reference. The zoom is only active while the transmission is in R (Reverse). When the transmission is shifted out of R (Reverse), the feature automatically turns off and must be reset when it is used again.

Selectable settings for this feature are OFF and ON. Press the zoom button to change the view. The default setting for the manual zoom is OFF.

Rear Camera Delay

When shifting the transmission out of R (Reverse) and into any gear other than P (Park), the camera image remains in the display until the vehicle speed reaches 6 mph (10 km/h). This occurs when the rear camera delay feature is on, or until a radio button is selected.

Selectable settings for this feature are ON and OFF. The default setting for the rear camera delay is OFF.

PRINCIPLES OF OPERATION

Cruise control lets you maintain a set speed without keeping your foot on the accelerator pedal.

USING CRUISE CONTROL

 **WARNING:** Do not use cruise control in heavy traffic, on winding roads or when the road surface is slippery. This could result in loss of vehicle control, serious injury or death.

 **WARNING:** When you are going downhill, your vehicle speed may increase above the set speed. The system will not apply the brakes. Change down a gear to assist the system in maintaining the set speed. Failure to do so could result in loss of vehicle control, serious injury or death.

Note: Cruise control will disengage if your vehicle speed decreases more than 10 mph (16 km/h) below your set speed while driving uphill.

The cruise controls are located on the steering wheel.

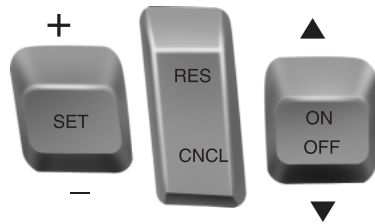
**Switching Cruise Control On**

Press the **ON** control up and release.



The indicator will appear in the instrument cluster.

Setting a Speed

1. Accelerate to the desired speed.
2. Press the **SET** control upward and release.
3. Take your foot off the accelerator pedal.

The indicator will change colors in the instrument cluster.

Changing the Set Speed

Note: If you accelerate by pressing the accelerator pedal, the set speed will not change. When you release the accelerator pedal, you will return to the speed that you previously set.

- Press **SET** up or down and hold to increase or decrease the set speed. Release the control when you reach the desired speed.
- Press **SET** up or down and release. The set speed will change in approximately 1 mph (2 km/h) increments.
- Press the accelerator pedal or brake pedal until you reach the desired speed. Press **SET** up and release.

Canceling the Set Speed

Press **CNCL** or tap the brake pedal. The set speed will not be erased.

Resuming the Set Speed

Press and release **RES**.

Switching Cruise Control Off

Note: The set speed is erased when you switch off cruise control.

Press the **OFF** control down and release or turn off the ignition.

USING ADAPTIVE CRUISE CONTROL (IF EQUIPPED)

WARNING: Always pay close attention to changing road conditions, especially when using adaptive cruise control. Adaptive cruise control cannot replace attentive driving. Failing to follow any of the warnings below or failing to pay attention to the road may result in a collision, serious injury or death.

 **WARNING:** Adaptive cruise control is not a collision warning or avoidance system. Additionally, adaptive cruise control will not detect:

- stationary or slow moving vehicles below 6 mph (10 km/h)
- pedestrians or objects in the roadway
- oncoming vehicles in the same lane.

 **WARNING:** Do not use the adaptive cruise control when entering or leaving a highway, in heavy traffic or on roads that are winding, slippery or unpaved.

 **WARNING:** Do not use in poor visibility, specifically fog, rain, spray or snow.

Note: It is your responsibility to stay alert, drive safely and be in control of your vehicle at all times.

The system adjusts your speed to maintain a proper distance between you and the vehicle in front of you in the same lane. You can select from one of four GAP settings. The controls are located on the steering wheel.

At startup, the system sets the gap to the last selected setting. Once activated, you can deactivate the system at any time by pressing the brake pedal, pressing the steering wheel **OFF** control or pressing the **CNCL** control. In addition, you can temporarily increase the vehicle speed above the current speed by manually pressing on the accelerator pedal.

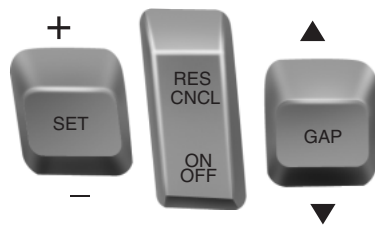

The controls for using your cruise control are located on the steering wheel.

Setting Adaptive Cruise Control



1. Press and release **ON**.

The information display will show the gray indicator light, current gap setting and **SET**. The system is set to standby mode.

2. Accelerate to the desired speed.
3. Press **SET** upward and release. The vehicle speed is stored in the memory.



The information display will show a green indicator light, current gap setting and desired set speed.

4. Take your foot off the accelerator pedal.



5. A lead vehicle graphic will illuminate if there is a vehicle detected in front of you.

Note: When adaptive cruise control is active, the set speed displayed in the information display may vary slightly from the speedometer.

Following a Vehicle



WARNING: When following a vehicle in front of you, your vehicle will not decelerate automatically to a stop, nor will your vehicle always decelerate quickly enough to avoid a collision without driver intervention. Always apply the brakes when necessary. Failing to do so may result in a collision, serious injury or death.



WARNING: Adaptive cruise control only warns of vehicles detected by the radar sensor. In some cases there may be no warning or the warning may be delayed. The driver should always apply the brakes when necessary. Failing to do so may result in a collision, serious injury or death.

Note: The brakes may emit a sound when they are being modulated by the adaptive cruise control system.

When a vehicle ahead of you enters the same lane or a slower vehicle is ahead in the same lane, the vehicle speed adjusts to maintain a preset gap distance. The distance setting is adjustable.

The lead vehicle graphic will be illuminated.

Your vehicle will maintain a constant distance between the vehicle ahead until:

- the vehicle in front of you accelerates to a speed above the set speed
- the vehicle in front of you moves out of your lane or out of view
- the vehicle speed falls below 16 mph (26 km/h)
- a new gap distance is set.

The vehicle brakes will be automatically applied to slow your vehicle to maintain a safe distance from the vehicle in front. The maximum braking which is applied by the system is limited and can be overridden by the driver applying the brakes.

If the system predicts that its maximum braking level will not be sufficient, an audible warning will sound while the system continues to brake. This is accompanied by a heads-up display; a red warning bar illuminating on the windshield. You should take immediate action.

Setting the Gap Distance

Note: It is your responsibility to select a gap appropriate to the driving conditions.



You can decrease or increase the distance between your vehicle and the vehicle in front of you by pressing the **GAP** control up or down. The selected gap will display

in the information display as shown by the bars in the graphic. Four gap distance settings are available.

Graphic display (bars between vehicles)	Following distance	Following distance at 60 mph (100 km/h)	Dynamic behavior
1 bar	1 second	31 yards (28 m)	Sporty
2 bars	1.4 seconds	43 yards (39 m)	Normal
3 bars	1.8 seconds	55 yards (50 m)	Normal
4 bars	2.2 seconds	67 yards (61 m)	Comfort

Each time you restart your vehicle, the system will select the last chosen gap for the current driver.

Disengaging Adaptive Cruise Control

Press the brake pedal or press **CNCL** to disengage the system. Disengaging the system will not erase your previous set speed.

Overriding Adaptive Cruise Control



WARNING: Whenever the driver is overriding the ACC by pressing the accelerator pedal, the ACC will not automatically apply the brakes to maintain separation from any vehicle ahead.

You can override the set speed and gap distance by pressing the accelerator pedal.



When you are overriding the system, the green indicator light illuminates and the follow vehicle does not show in the information display. The system will resume operation when you release the accelerator pedal. The vehicle speed will decrease to the set speed, or a lower speed if following a slower vehicle.

Changing the Set Speed

There are three ways to change the set speed:

- Accelerate or brake to the desired speed and press **SET** upward and release.
- Increase or decrease the speed by holding **SET** upward or downward until the desired set speed is shown on the information display. The vehicle speed will gradually change to the selected speed.
- Increase or decrease the speed in increments of 1 mph (2 km/h) by briefly pressing **SET** upward or downward.

The system may apply the brakes to slow your vehicle down to the new set speed. The set speed will display continuously in the information display while the system is active.

Resuming the Set Speed

Note: Resume should only be used if you are aware of the set speed and intend to return to it.

Press and release **RES**. Your vehicle will return to the previously set speed. The set speed will display continuously in the information display while the system is active.

Low Speed Automatic Cancellation

The system is not functional at vehicle speeds below 16 mph (26 km/h). An audible alarm sounds and the automatic braking released if your vehicle drops below this speed.

Hilly Condition Usage

Note: An audible alarm sounds and the system shuts down if it is applying brakes for an extended period of time. This allows the brakes to cool down. The system will function normally again when the brakes have cooled down.

You should select a lower gear position when the system is active in situations such as prolonged downhill driving on steep grades, for example driving in mountainous areas. Your vehicle needs additional engine braking in these situations to reduce the load on the vehicle's regular brake system to prevent them from overheating.

Switching Off Adaptive Cruise Control

Note: The set speed memory will erase when you switch the system off. Press and release **OFF** or turn off the ignition.

Detection Issues

The radar sensor has a limited field of vision. It may not detect vehicles at all or detect a vehicle later than expected in some situations. The lead vehicle graphic will not illuminate if the system does not detect a vehicle in front of you.

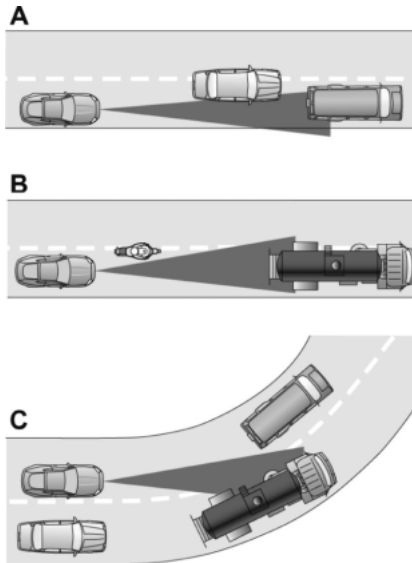

Detection issues can occur:

A. When driving on a different line than the vehicle in front.

B. With vehicles that edge into your lane. The system can only detect these vehicles once they move fully into your lane.

C. There may be issues with the detection of vehicles in front when driving into and coming out of a bend or curve in the road.

In these cases the system may brake late or unexpectedly. You should stay alert and intervene when necessary.

If the front end of your vehicle is hit or damaged, the radar sensing zone may be altered causing missed or false vehicle detections. See your authorized dealer to have the radar checked for proper coverage and operation.

Adaptive Cruise Control Not Available

Several conditions exist which can cause the system to deactivate or prevent the system from activating when requested. These conditions include:

- a blocked sensor
- high brake temperature
- a failure in the system or a related system.

Blocked Sensor

 **WARNING:** Do not use ACC when towing a trailer with brake controls. Aftermarket trailer brakes will not function properly when ACC is activated because the brakes are electronically controlled. Failing to do so may result in loss of vehicle control, which could result in serious injury.

 **WARNING:** Do not use tires sizes other than those recommended because this can affect the normal operation of ACC. Failing to do so may result in a loss of vehicle control, which could result in serious injury.

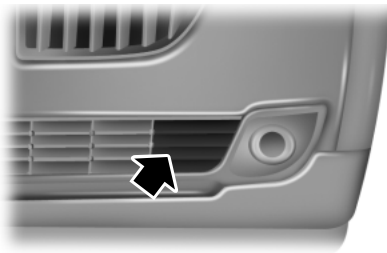

A message regarding a blocked sensor is displayed if the radar signals from the sensor have been obstructed. The sensor is located behind a fascia cover near the driver side of the lower grille. A vehicle ahead cannot be detected and the system will not function when the radar signals are obstructed. The following table lists possible causes and actions for this message being displayed.

Cause	Action
The surface of the radar in the grille is dirty or obstructed in some way.	Clean the grille surface in front of the radar or remove the object causing the obstruction.
The surface of the radar in the grille is clean but the message remains in the display.	Wait a short time. It may take several minutes for the radar to detect that it is no longer obstructed.
Heavy rain or snow is interfering with the radar signals.	Do not use the system in these conditions because it may not detect any vehicle ahead.

Cause	Action
Swirling water, or snow or ice on the surface of the road may interfere with the radar signals.	Do not use system in these conditions because it may not detect any vehicle ahead.
You are in a desert or remote area with no other vehicles and no roadside objects.	Wait a short time or switch to normal cruise control.

Due to the nature of radar technology, it is possible to get a blockage warning and not be blocked. This can happen, for example, when driving in sparse rural or desert environments. A false blocked condition will either self-clear or clear after a key cycle.

Switching to Normal Cruise Control



WARNING: Normal cruise control will not brake due to slower vehicles. Always be aware of which mode is selected and apply the brakes when necessary.

You can manually change from adaptive cruise control to normal cruise control through the information display.



The cruise control indicator light will replace the adaptive cruise control indicator light if normal cruise control is selected. The gap setting will not be displayed, the system will not automatically respond to lead vehicles and automatic braking will not be activated. The system will default to adaptive cruise control when the engine is started.

BLIND SPOT INFORMATION SYSTEM (BLIS®) WITH CROSS TRAFFIC ALERT (CTA) (IF EQUIPPED)

WARNING: To help avoid injuries, NEVER use the BLIS® as a replacement for using the interior and exterior mirrors and looking over your shoulder before changing lanes. BLIS® is not a replacement for careful driving.

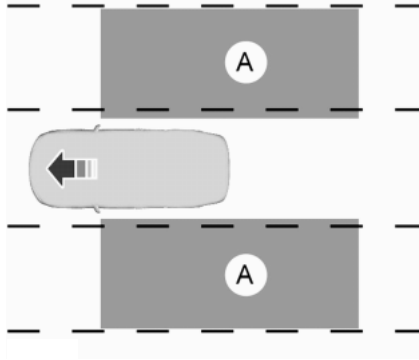

BLIS® aids the driver in detecting vehicles that may have entered the blind spot zone (A). The detection area is on both sides of the vehicle, extending rearward from the exterior mirrors to approximately 10 feet (3 meters) beyond the bumper. The system alerts you if certain vehicles enter the blind spot zone while driving.

CTA warns the driver of vehicles approaching from the sides when the transmission is in R (Reverse).

Note: BLIS® is not designed to prevent contact with other vehicles or objects; or to detect parked vehicles, people, animals or infrastructure (fences, guardrails, trees, etc.). It is designed to alert the driver to vehicles in the blind zones.

Note: When a vehicle passes quickly through the blind zone (typically fewer than two seconds), the system does not trigger.

Using the Systems

BLIS® turns on when the engine is started and the vehicle is driven forward above 3 mph (5 km/h); it remains on while the transmission is in D (Drive) or N (Neutral). If shifted out of D (Drive) or N (Neutral), the system enters CTA mode. Once shifted back into D (Drive), BLIS® turns back on when the vehicle is driven above 3 mph (5 km/h).

Note: BLIS® does not function in R (Reverse) or P (Park) or provide any additional warning when a turn signal is on.

CTA detects approaching vehicles from up to 45 feet (14 meters) away though coverage decreases when the sensors are blocked. Reversing slowly helps increase the coverage area and effectiveness.

! **WARNING:** To help avoid personal injury, NEVER use the CTA system as a replacement for using the interior and exterior mirrors and looking over your shoulder before backing out of a parking space. CTA is not a replacement for careful driving.

In this first example, the left sensor is only partially obstructed; zone coverage is nearly maximized.

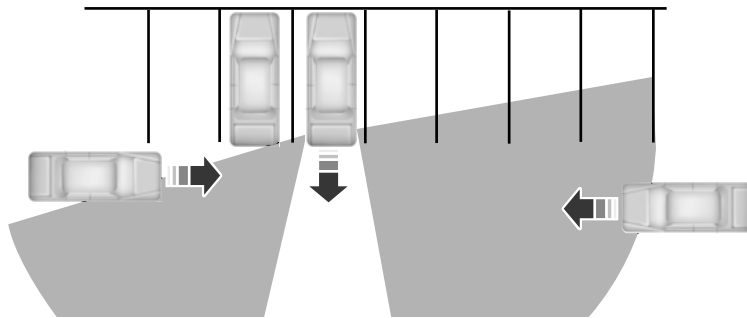

Zone coverage also decreases when parking at shallow angles. Here, the left sensor is mostly obstructed; zone coverage on that side is severely limited.

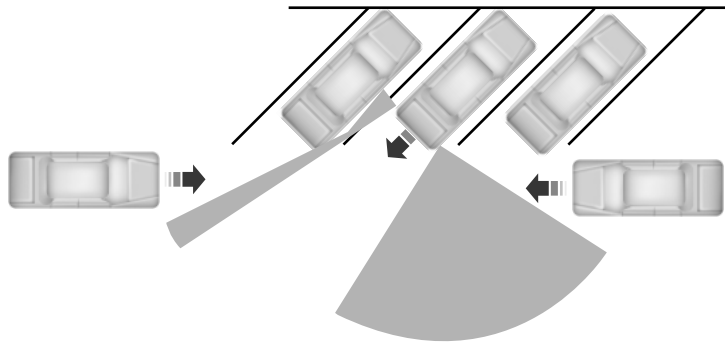

System Lights and Messages



The BLIS® and CTA systems illuminate a yellow alert indicator in the outside mirror on the side of the vehicle the approaching vehicle is coming from.

Note: The alert indicator dims when nighttime darkness is detected.

CTA also sounds an audible alarm and a message appears in the information display indicating a vehicle is coming from the right or left. CTA works with the reverse sensing system which sounds its own audible alarm; see the *Parking Aids* chapter.

System Sensors



WARNING: Just prior to the system recognizing a blocked condition and alerting the driver, the number of missed objects will increase. To help avoid injuries, NEVER use the BLIS® as a replacement for using the side and rear view mirrors and looking over your shoulder before changing lanes. BLIS® is not a replacement for careful driving.

Note: It is possible to get a blockage warning with no blockage present; this is rare and known as a false blockage warning. A false blocked condition either self-corrects or clears after a key cycle.

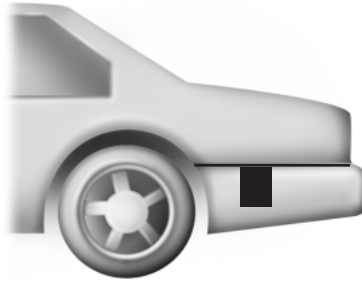

The system uses radar sensors which are located behind the bumper fascia on each side of the vehicle. Do not allow these areas to become obstructed by mud, snow or bumper stickers, as this can cause degraded system performance.

If the system detects a degraded performance condition, a blocked sensor warning or low visibility warning will appear in the information display and the alert indicator illuminates in the appropriate mirror(s). The information display warning can be cleared but the alert indicator remains illuminated.

When the blockage is removed, the system can be reset in two ways: 1) when at least two objects are detected while driving, or 2) turn the ignition key from on to off, then back on. If the blockage is still present after the key cycle, the system senses again that it is blocked after driving in traffic.

Reasons for messages being displayed	
The radar surface is dirty or obstructed	Clean the fascia area in front of the radar or remove the obstruction.
The radar surface is not dirty or obstructed	Drive normally in traffic for a few minutes to allow the radar to detect passing vehicles so it can clear the blocked state.

Reasons for messages being displayed	
Heavy rainfall/snowfall interferes with the radar signals	No action required. The system automatically resets to an unblocked state once the rainfall/snowfall rate decreases or stops. Do not use BLIS® and/or CTA in these conditions.

System Limitations

The BLIS® and CTA systems do have their limitations; situations such as severe weather conditions or debris build-up on the sensor area may limit vehicle detection.

The following are other situations that may limit the BLIS®:

- Certain maneuvering of vehicles entering and exiting the blind zone.
- Vehicles passing through the blind zone at very fast rates.
- When several vehicles forming a convoy pass through the blind zone.

The following are other situations that may limit the CTA system:

- Adjacently parked vehicles or objects obstructing the sensors.
- Approaching vehicles passing at speeds greater than 15 mph (24 km/h).
- Driving in reverse faster than 3 mph (5 km/h).
- Backing out of an angled parking spot.

False Alerts

Note: If you connected a trailer to your vehicle the BLIS® system may detect the trailer causing a false alert. To avoid false alerts you may want to turn the BLIS off manually.

There may be certain instances when either the BLIS® or CTA systems illuminate the alert indicator with no vehicle in the coverage zone; this is known as a false alert. Some amount of false alerts are normal; they are temporary and self-correct.

System Errors

If either system senses a problem with the left or right sensor, the BLIS® indicator in the information display will illuminate and remain on. Also, **BLIND SPOT SYSTEM FAULT** or **CROSS TRAFFIC SYSTEM FAULT** message will appear. When problems that may cause the left or right indicator not to illuminate, only the information display message faults appear.

Switching the Systems Off and On

One or both systems can be switched off temporarily by using the information display control; refer to the *Information Display* chapter. When the BLIS® is switched off, the driver does not receive alerts and the information display shows BLIND SPOT SYS OFF and/or CTA SYSTEM OFF. The system switches back on whenever the ignition is switched on.

One or both systems can also be switched off permanently at your authorized dealer. Once switched off, switching it back on must also be done at the dealership.

COLLISION WARNING SYSTEM (IF EQUIPPED)



WARNING: This system is designed to be a supplementary driving aid. It is not intended to replace the driver's attention, and judgment, or the need to apply the brakes. This system does NOT activate the brakes automatically. Failure to press the brake pedal to activate the brakes may result in a collision.



WARNING: The collision warning system with brake support cannot help prevent all collisions. Do not rely on this system to replace driver judgment and the need to maintain distance and speed.

Note: The system does not detect, warn or respond to potential collisions with vehicles to the rear or sides of the vehicle.

Note: The collision warning system is active at speeds above approximately 5 mph (8 km/h).



This system is designed to alert the driver of certain collision risks. A radar detects if your vehicle is rapidly approaching another vehicle traveling in the same direction as yours.

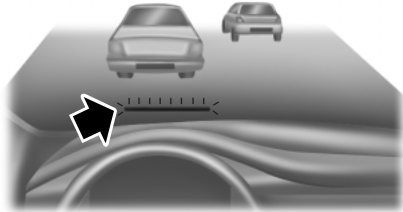

If it is, a red warning light illuminates and an audible warning chime sounds.

The brake support system assists the driver in reducing the collision speed by charging the brakes. If the risk of collision further increases after the warning light illuminates, the brake support prepares the brake system for rapid braking. This may be apparent to the driver. The system does not automatically activate the brakes but, if the brake pedal is pressed, full force braking is applied even if the brake pedal is lightly pressed.

Using the Collision Warning System



WARNING: The collision warning system's brake support can only help reduce the speed at which a collision occurs if the driver applies the vehicle's brakes. The brake pedal must be pressed just like any typical braking situation.

The warning system sensitivity can be adjusted to one of three possible settings by using the information display control. Refer to the *Information Displays* chapter.

Note: If collision warnings are perceived as being too frequent or disturbing then the warning sensitivity can be reduced, though the manufacturer recommends using the highest sensitivity setting where possible. Setting lower sensitivity would lead to fewer and later system warnings. Refer to the *Information Displays* chapter for instructions on reducing the sensitivity.

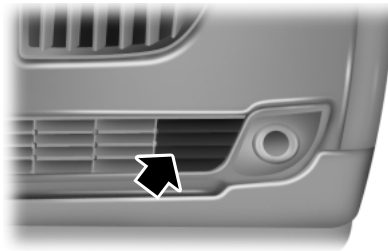
Blocked Sensors

If a message regarding a blocked sensor appears in the information display, the radar signals from the sensor have been obstructed. The sensors are located behind a fascia cover near the driver side of the lower grille. When the sensors are obstructed, a vehicle ahead cannot be detected and the collision warning system does not function. The

following table lists possible causes and actions for this message being displayed.

Cause	Action
The surface of the radar in the grille is dirty or obstructed in some way	Clean the grille surface in front of the radar or remove the object causing the obstruction
The surface of the radar in the grille is clean but the message remains in the display	Wait a short time. It may take several minutes for the radar to detect that it is no longer obstructed
Heavy rain, spray, snow, or fog is interfering with the radar signals	The collision warning system is temporarily disabled. Collision warning should automatically reactivate a short time after the weather conditions improve.
Swirling water, or snow or ice on the surface of the road may interfere with the radar signals	The collision warning system is temporarily disabled. Collision warning should automatically reactivate a short time after the weather conditions improve.

System Limitations

 **WARNING:** The collision warning system's brake support can only help reduce the speed at which a collision occurs if the driver applies the vehicle's brakes. The brake pedal must be pressed just like any typical braking situation.

Due to the nature of radar technology, there may be certain instances where vehicles do not provide a collision warning. These include:

- Stationary vehicles or vehicles moving below 6 mph (10 km/h).
- Pedestrians or objects in the roadway.
- Oncoming vehicles in the same lane.
- Severe weather conditions (see blocked sensor section).
- Debris build-up on the grille near the headlamps (see blocked sensor section).
- Small distance to vehicle ahead.
- Steering wheel and pedal movements are large (very active driving style).
- High interior temperatures, which may deactivate the illumination or the warning lamps until the interior temperature reduces (audible warning still sounds).

Certain conditions may reduce the visibility of the warning lamp; therefore, it is recommended to keep the audible warning on.

If the front end of the vehicle is hit or damaged, the radar sensing zone may be altered causing missed or false collision warnings. See your authorized dealer to have your collision warning radar checked for proper coverage and operation.

STEERING

To help prevent damage to the power steering system:

- Never hold the steering wheel at its furthest turning points (until it stops) for more than three to five seconds while the engine is running.
- Do not operate the vehicle with a low power steering pump fluid reservoir level (below the MIN mark on the reservoir).
- Some noise is normal during operation. If the noise is excessive, check for low power steering pump fluid level before seeking service by your authorized dealer.
- Heavy or uneven, steering efforts may be caused by low power steering pump fluid level. Check for a low power steering pump fluid level before seeking service by your authorized dealer.
- Do not fill the power steering reservoir above the MAX mark, as this may result in leaks from the reservoir.

If the power steering system breaks down (or if the engine is turned off), you can steer the vehicle manually, but it takes more effort.

If the steering wanders or pulls, check for:

- an improperly inflated tire.
- uneven tire wear.
- loose or worn suspension components.
- loose or worn steering components.
- improper steering alignment.

A high crown in the road or high crosswinds may also make the steering seem to wander/pull.

CARGO NETS

 **WARNING:** This net is not designed to restrain objects during a collision or heavy braking.

The cargo net secures lightweight objects in the cargo area.

Attach the net to the anchors provided in one of the two configurations. Repeat the attachment on both sides of the vehicle.

Type 1

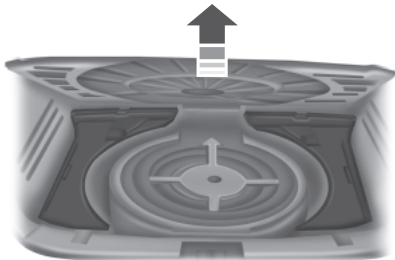

Type 2**CARGO MANAGEMENT SYSTEM**

The system is located in the floor of the cargo area. Lift the release handle to open.

ROOF RACKS AND LOAD CARRIERS (IF EQUIPPED)



WARNING: When loading the roof racks, we recommend you evenly distribute the load, as well as maintain a low center of gravity. Loaded vehicles, with higher centers of gravity, may handle differently than unloaded vehicles. Take extra precautions, such as slower speeds and increased stopping distance, when driving a heavily loaded vehicle.

Note: The maximum recommended load, evenly distributed on the crossbars, is 100 pounds (45 kilograms).

Note: Never place loads directly on the roof panel. The roof panel is not designed to directly carry a load.

For correct roof rack system function, you must place loads directly on crossbars affixed to the roof rack side rails. We recommend you use Ford Genuine Accessory crossbars designed specifically for your vehicle.

Make sure that you securely fasten the load. Check the tightness of the load before driving and at each fuel stop.

UTILITY HOOK

You can use the utility hook to hang small items such as grocery bags. Do not hang more than 10 pounds (4.5 kilograms) on the hook.

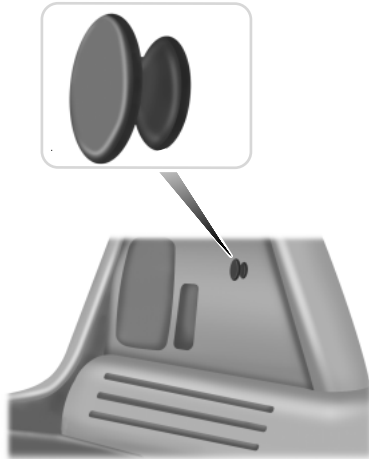
**LOAD LIMIT****Vehicle Loading – With and Without a Trailer**

This section will guide you in the proper loading of your vehicle and/or trailer, to keep your loaded vehicle weight within its design rating capability, with or without a trailer. Properly loading your vehicle will provide maximum return of vehicle design performance. Before loading your vehicle, familiarize yourself with the following terms for determining your vehicle's weight ratings, with or without a trailer, from the vehicle's Tire Label or Safety Compliance Certification Label:

Base Curb Weight – is the weight of the vehicle including a full tank of fuel and all standard equipment. It does not include passengers, cargo, or optional equipment.

Vehicle Curb Weight – is the weight of your new vehicle when you picked it up from your authorized dealer plus any aftermarket equipment.

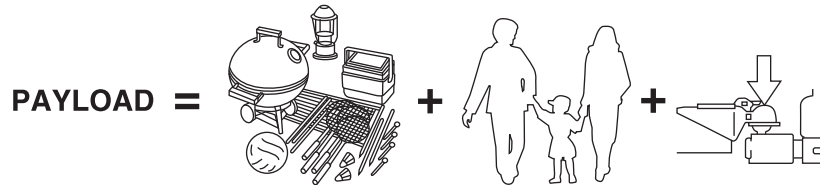

Payload – is the combined weight of cargo and passengers that the vehicle is carrying. The maximum payload for your vehicle can be found on the Tire Label on the B-Pillar or the edge of the driver's door (vehicles exported outside the US and Canada may not have a Tire Label). Look for **“THE COMBINED WEIGHT OF OCCUPANTS AND CARGO SHOULD NEVER EXCEED XXX kg OR XXX lb.”** for maximum payload. The payload listed on the Tire Label is the maximum payload for the vehicle as built by the assembly plant. If any aftermarket or authorized-dealer installed equipment has been installed on the vehicle, the weight of the equipment must be subtracted from the payload listed on the Tire Label in order to determine the new payload.

 **WARNING:** The appropriate loading capacity of your vehicle can be limited either by volume capacity (how much space is available) or by payload capacity (how much weight the vehicle should carry). Once you have reached the maximum payload of your vehicle, do not add more cargo, even if there is space available. Overloading or improperly loading your vehicle can contribute to loss of vehicle control and vehicle rollover.

Example only:

TIRE AND LOADING INFORMATION

SEATING CAPACITY | TOTAL 5 | FRONT 2 | REAR 3

The combined weight of occupants and cargo should never exceed : **XXX kg or XXX lbs.**

TIRE	SIZE	COLD TIRE PRESSURE	SEE OWNERS MANUAL FOR ADDITIONAL INFORMATION
FRONT	LT225/75R 16.5E	200 KPA, 29 PSI	
REAR	LT225/75R 16.5E	200 KPA, 29 PSI	
SPARE	T145/80D16 P225/60R17	420 KPA, 60 PSI 200 KPA, 29 PSI	

XXXXXXXXXXXXXXXXXXXX

TIRE AND LOADING INFORMATION
RENSEIGNEMENTS SUR LES PNEUS ET LE CHARGEMENT

SEATING CAPACITY | TOTAL 5 | FRONT 2 | REAR 3
NOMBRE DE PLACES | TOTAL 5 | AVANT 2 | ARRIERE 3

The combined weight of occupants and cargo should never exceed 492 kg or 1085 lbs.
Le poids total des occupants et du chargement ne doit jamais dépasser 492 kg ou 1085 lb.

TIRE PNEU	SIZE DIMENSIONS	COLD TIRE PRESSURE PRESSION DES PNEUS A FROID	SEE OWNER'S MANUAL FOR ADDITIONAL INFORMATION VOIR LE MANUEL DE L'USAGER POUR PLUS DE RENSEIGNEMENTS
FRONT AVANT	P235/70R16	240 KPA, 35 PSI	
REAR ARRIERE	P235/70R16	240 KPA, 35 PSI	
SPARE DE SECOURS	T145/90R17	415 KPA, 60 PSI	

XXXXXXXXXXXXXXXXXXXX



Cargo Weight – includes all weight added to the Base Curb Weight, including cargo and optional equipment. When towing, trailer tongue load weight is also part of cargo weight.

GAW (Gross Axle Weight) – is the total weight placed on each axle (front and rear) – including vehicle curb weight and all payload.

GAWR (Gross Axle Weight Rating) – is the maximum allowable weight that can be carried by a single axle (front or rear). **These numbers are shown on the Safety Compliance Certification Label. The label shall be affixed to either the door hinge pillar, door-latch post, or the door edge that meets the door-latch post, next to the driver’s seating position. The total load on each axle must never exceed its GAWR.**

Note: For trailer towing information refer to *Trailer towing* found in this chapter or the *RV and Trailer Towing Guide* provided by your authorized dealer.

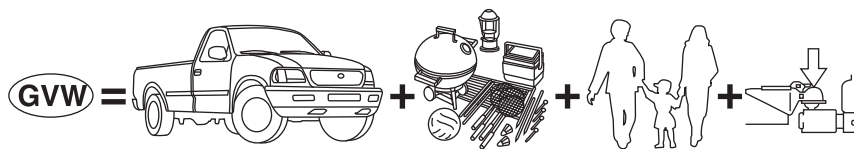

GVW (Gross Vehicle Weight) – is the Vehicle Curb Weight + cargo + passengers.

GVWR (Gross Vehicle Weight Rating) – is the maximum allowable weight of the fully loaded vehicle (including all options, equipment, passengers and cargo). **The GVWR is shown on the Safety Compliance Certification Label. The label shall be affixed to either the door hinge pillar, door-latch post, or the door edge that meets the door-latch post, next to the driver’s seating position. The GVW must never exceed the GVWR.**

- Example only:

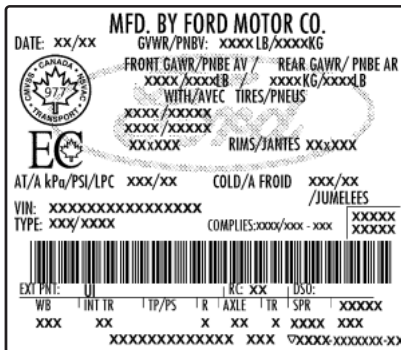
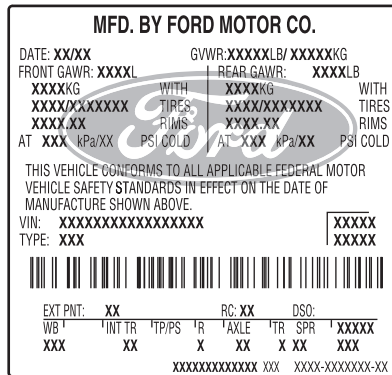

 **WARNING:** Exceeding the Safety Compliance Certification Label vehicle weight rating limits could result in substandard vehicle handling or performance, engine, transmission and/or structural damage, serious damage to the vehicle, loss of control and personal injury.



GCW (Gross Combined Weight) – is the weight of the loaded vehicle (GVW) plus the weight of the fully loaded trailer.

GCWR (Gross Combined Weight Rating) – is the maximum allowable weight of the vehicle and the loaded trailer – including all cargo and passengers – that the vehicle can handle without risking damage. (Important: The towing vehicle's braking system is rated for operation at GVWR, not at GCWR. Separate functional brakes should be used for safe control of towed vehicles and for trailers where the GCW of the towing vehicle plus the trailer exceed the GVWR of the towing vehicle. **The GCW must never exceed the GCWR.**

Maximum Loaded Trailer Weight – is the highest possible weight of a fully loaded trailer the vehicle can tow. It assumes a vehicle with only mandatory options, no cargo (internal or external), a tongue load of 10–15% (conventional trailer), and driver only (150 lb. [68 kg]). **Consult your authorized dealer (or the *RV and Trailer Towing Guide* provided by your authorized dealer) for more detailed information.**

 **WARNING:** Do not exceed the GVWR or the GAWR specified on the Safety Compliance Certification Label.

 **WARNING:** Do not use replacement tires with lower load carrying capacities than the original tires because they may lower the vehicle's GVWR and GAWR limitations. Replacement tires with a higher limit than the original tires do not increase the GVWR and GAWR limitations.



WARNING: Exceeding any vehicle weight rating limitation could result in serious damage to the vehicle and/or personal injury.

Steps for determining the correct load limit:

1. Locate the statement “The combined weight of occupants and cargo should never exceed XXX kg or XXX lbs.” on your vehicle’s placard.
2. Determine the combined weight of the driver and passengers that will be riding in your vehicle.
3. Subtract the combined weight of the driver and passengers from XXX kg or XXX lbs.
4. The resulting figure equals the available amount of cargo and luggage load capacity. For example, if the “XXX” amount equals 1,400 lbs. and there will be five 150 lb. passengers in your vehicle, the amount of available cargo and luggage load capacity is 650 lbs. ($1400 - 750 (5 \times 150) = 650 \text{ lb.}$).
5. Determine the combined weight of luggage and cargo being loaded on the vehicle. That weight may not safely exceed the available cargo and luggage load capacity calculated in Step 4.
6. If your vehicle will be towing a trailer, load from your trailer will be transferred to your vehicle. Consult this manual to determine how this reduces the available cargo and luggage load capacity of your vehicle.

The following gives you a few examples on how to calculate the available amount of cargo and luggage load capacity:

- Suppose your vehicle has a 1400 lb. (635 kg) cargo and luggage capacity. You decide to go golfing. Is there enough load capacity to carry you, 4 of your friends and all the golf bags? You and four friends average 220 lb. (99 kg) each and the golf bags weigh approximately 30 lb. (13.5 kg) each. The calculation would be: $1,400 - (5 \times 220) - (5 \times 30) = 1,400 - 1,100 - 150 = 150 \text{ lb.}$ Yes, you have enough load capacity in your vehicle to transport four friends and your golf bags. In metric units, the calculation would be: $635 \text{ kg} - (5 \times 99 \text{ kg}) - (5 \times 13.5 \text{ kg}) = 635 - 495 - 67.5 = 72.5 \text{ kg.}$

- Suppose your vehicle has a 1400 lb. (635 kg) cargo and luggage capacity. You and one of your friends decide to pick up cement from the local home improvement store to finish that patio you have been planning for the past 2 years. Measuring the inside of the vehicle with the rear seat folded down, you have room for 12-100 lb. (45 kg) bags of cement. Do you have enough load capacity to transport the cement to your home? If you and your friend each weigh 220 lb. (99 kg), the calculation would be: $1,400 - (2 \times 220) - (12 \times 100) = 1,400 - 440 - 1,200 = -240$ lb. No, you do not have enough cargo capacity to carry that much weight. In metric units, the calculation would be: $635 \text{ kg} - (2 \times 99 \text{ kg}) - (12 \times 45 \text{ kg}) = 635 - 198 - 540 = -103$ kg. You will need to reduce the load weight by at least 240 lb. (104 kg). If you remove 3-100 lb. (45 kg) cement bags, then the load calculation would be:
 $1,400 - (2 \times 220) - (9 \times 100) = 1,400 - 440 - 900 = 60$ lb. Now you have the load capacity to transport the cement and your friend home. In metric units, the calculation would be: $635 \text{ kg} - (2 \times 99 \text{ kg}) - (9 \times 45 \text{ kg}) = 635 - 198 - 405 = 32$ kg.

The above calculations also assume that the loads are positioned in your vehicle in a manner that does not overload the Front or the Rear Gross Axle Weight Rating specified for your vehicle on the Safety Compliance Certification Label. The label shall be affixed to either the door hinge pillar, door-latch post, or the door edge that meets the door-latch post, next to the driver's seating position.

TOWING A TRAILER

WARNING: Do not exceed the GVWR or the GAWR specified on the certification label.



WARNING: Towing trailers beyond the maximum recommended gross trailer weight exceeds the limit of your vehicle and could result in engine damage, transmission damage, structural damage, loss of vehicle control, vehicle rollover and personal injury.

Note: For information on electrical items such as fuses or relays, see the *Fuses* chapter.

The load capacity of your vehicle is designated by weight not volume. You may not necessarily be able to use all available space when loading your vehicle or trailer.

Towing a trailer places extra load on the engine, transmission, axle, brakes, tires, and suspension. Inspect these components before, during and after towing.

Load Placement

To help minimize how trailer movement affects your vehicle when driving:

- Load the heaviest items closest to the trailer floor.
- Load the heaviest items centered between the left and right side trailer tires.
- Load the heaviest items above the trailer axles or just slightly forward toward the trailer tongue. Do not allow the final trailer tongue weight to go above or below 10–15% of the loaded trailer weight.
- Select a tow bar with the correct rise or drop. When both the loaded vehicle and trailer are connected, the trailer frame should be level, or slightly angled down toward your vehicle, when viewed from the side.

When driving with a trailer or payload, a slight takeoff vibration or shudder may be present due to the increased payload weight. You can find more information about proper trailer loading and setting your vehicle up for towing under *Load limit* in the *Load Carrying* chapter.

You can also find information in the *RV and Trailer Towing Guide* available at your authorized dealer.

TRAILER SWAY CONTROL

WARNING: Turning off trailer sway control increases the risk of loss of vehicle control, serious injury or death. Ford does not recommend disabling this feature except in situations where speed reduction may be detrimental (such as hill climbing), the driver has significant trailer towing experience, and can control trailer sway and maintain safe operation.

Note: This feature does not prevent trailer sway, but reduces it once it begins.

Note: This feature cannot stop all trailers from swaying.

Note: In some cases, if vehicle speed is too high, the system may turn on multiple times, gradually reducing vehicle speed.

This feature applies your vehicle brakes at individual wheels and, if necessary, reduces engine power. If the trailer begins to sway, the stability control light flashes and the message **TRAILER SWAY REDUCE SPEED** appears in the information display. The first thing to do is slow your vehicle down, then pull safely to the side of the road and check for proper tongue load and trailer load distribution. See the *Load Carrying* chapter for specific loading information.

RECOMMENDED TOWING WEIGHTS

Note: Do not exceed the trailer weight for your vehicle configuration listed in the chart below.

Note: Make sure to take into consideration trailer frontal area. Do not exceed:

- 20 feet² (1.86 meters²) trailer frontal area if your vehicle can tow a Class I trailer.
- 30 feet² (2.79 meters²) trailer frontal area if your vehicle can tow a Class II trailer.

Note: For high altitude operation, reduce the gross combined weight by 2% per 1000 feet (300 meters) starting at the 1000 foot (300 meter) elevation point.

Note: Certain states require electric trailer brakes for trailers over a specified weight. Be sure to check state regulations for this specified weight. The maximum trailer weights listed may be limited to this specified weight, as your vehicle's electrical system may not include the wiring connector needed to use electric trailer brakes.

Your vehicle may tow a trailer provided the maximum trailer weight is less than or equal to the maximum trailer weight listed for your vehicle configuration on the following chart.

Powertrain	Maximum GCWR	Maximum trailer weight
3.7L TiVCT front-wheel drive*	6770 lb (3071 kg)	2000 lb (907 kg)
3.7L TiVCT front-wheel drive**	8270 lb (3751 kg)	3500 lb (1588 kg)
3.7L TiVCT all-wheel drive*	6940 lb (3148 kg)	2000 lb (907 kg)
3.7L TiVCT all-wheel drive**	8440 lb (3828 kg)	3500 lb (1588 kg)

*Vehicles not equipped with a trailer-towing package and vehicles equipped with 22-inch wheels are limited to a 2000-pound (907 kilogram) trailer weight.

**Vehicles equipped with a trailer-towing package.

ESSENTIAL TOWING CHECKS

Follow these guidelines for safe towing:

- Do not tow a trailer until you drive your vehicle at least 1000 miles (1600 kilometers).
- Consult your local motor vehicle laws for towing a trailer.
- See the instructions included with towing accessories for the proper installation and adjustment specifications.
- Service your vehicle more frequently if you tow a trailer. See your scheduled maintenance information.
- If you use a rental trailer, follow the instructions the rental agency gives you.

For load specification terms found on the tire label and Safety Compliance label and for instructions on calculating your vehicle's load, refer to *Load limit* in the *Load Carrying* chapter.

Remember to account for the trailer tongue weight as part of your vehicle load when calculating the total vehicle weight.

Trailer Towing Connector (Vehicles Equipped with a Trailer-towing or Prep Package)

The trailer towing connector is located under the rear bumper, on the left side of your vehicle.



You must use a four-pin trailer wiring connector for your vehicle and the trailer lighting equipment.

Color	Function
1. Dark Green	Right turn signal, brake lamp and hazard flasher
2. Yellow	Left turn signal, brake lamp and hazard flasher
3. Brown	Tail lamps and parking lamps
4. White	Ground

Hitches

Do not use a hitch that clamps onto your vehicle's bumper. Use a load-carrying hitch.

Distribute the trailer load so 10-15% of the total trailer weight is on the tongue.

Safety Chains

Note: Never attach safety chains to the bumper.

Always connect the safety chains to the hook retainers of your vehicle hitch.

To connect the safety chains, cross them under the trailer tongue and allow enough slack for turning tight corners. Do not allow the chains to drag on the ground.

Trailer Brakes



WARNING: Do not connect a trailer's hydraulic brake system directly to your vehicle's brake system. Your vehicle may not have enough braking power and your chances of having a collision greatly increase.

Electric brakes and manual, automatic or surge-type trailer brakes are safe if you install them properly and adjust them to the manufacturer's specifications. The trailer brakes must meet local and federal regulations.

The rating for the tow vehicle's braking system operation is at the gross vehicle weight rating, not the gross combined weight rating.

Separate functioning brake systems are required for safe control of towed vehicles and trailers weighing more than 1500 pounds (680 kilograms) when loaded.

Trailer Lamps



WARNING: Never connect any trailer lamp wiring to the vehicle's tail lamp wiring; this may damage the electrical system resulting in a fire. Contact an authorized dealer as soon as possible for assistance in proper trailer tow wiring installation. Additional electrical equipment may be required.

Trailer lamps are required on most towed vehicles. Make sure all running lights, brake lights, turn signals and hazard lights are working.

Before Towing a Trailer

Practice turning, stopping and backing up to get the feel of your vehicle-trailer combination before starting on a trip. When turning, make wider turns so the trailer wheels clear curbs and other obstacles.

When Towing a Trailer

- Do not drive faster than 70 mph (113 km/h) during the first 500 miles (800 kilometers).
- Do not make full-throttle starts.
- Check your hitch, electrical connections and trailer wheel lug nuts thoroughly after you have traveled 50 miles (80 kilometers).
- When stopped in congested or heavy traffic during hot weather, place the gearshift in position **P** to aid engine and transmission cooling and to help air conditioning performance.
- Turn off the speed control with heavy loads or in hilly terrain. The speed control may turn off automatically when you are towing on long, steep grades.
- Shift to a lower gear when driving down a long or steep hill. Do not apply the brakes continuously, as they may overheat and become less effective.
- If your transmission is equipped with a Grade Assist or Tow/Haul feature, use this feature when towing. This provides engine braking and helps eliminate excessive transmission shifting for optimum fuel economy and transmission cooling.

- Allow more distance for stopping with a trailer attached. Anticipate stops and brake gradually.
- Avoid parking on a grade. However, if you must park on a grade:
 1. Turn the steering wheel to point your vehicle tires away from traffic flow.
 2. Set your vehicle parking brake.
 3. Place the automatic transmission in position **P**.
 4. Place wheel chocks in front and back of the trailer wheels.
(Chocks not included with vehicle.)

Launching or Retrieving a Boat or Personal Watercraft (PWC)

Note: Disconnect the wiring to the trailer **before** backing the trailer into the water.

Note: Reconnect the wiring to the trailer **after** removing the trailer from the water.

When backing down a ramp during boat launching or retrieval:

- Do not allow the static water level to rise above the bottom edge of the rear bumper.
- Do not allow waves to break higher than 6 inches (15 centimeters) above the bottom edge of the rear bumper.

Exceeding these limits may allow water to enter vehicle components:

- Causing internal damage to the components.
- Affecting driveability, emissions, and reliability.

Replace the rear axle lubricant anytime the rear axle submerges in water. Water may have contaminated the rear axle lubricant, which does not normally require checking or changing unless it is leaking or other axle repair is required.

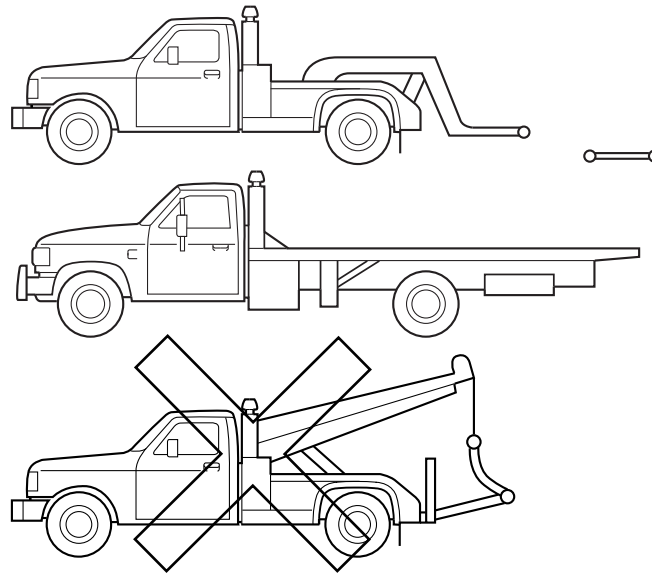
TRANSPORTING THE VEHICLE

If you need to have your vehicle towed, contact a professional towing service or, if you are a member of a roadside assistance program, your roadside assistance service provider.

We recommend the use of a wheel lift and dollies or flatbed equipment to tow your vehicle. Do not tow with a slingbelt. Ford Motor Company has not approved a slingbelt towing procedure. Vehicle damage may occur if towed incorrectly, or by any other means.

Ford Motor Company produces a towing manual for all authorized tow truck operators. Have your tow truck operator refer to this manual for proper hook-up and towing procedures for your vehicle.

It is acceptable to have your front-wheel drive vehicle towed from the front if using proper wheel lift equipment to raise the front wheels off the ground. When towing in this manner, the rear wheels can remain on the ground.

Front-wheel drive vehicles must have the front wheels placed on a tow dolly when towing your vehicle from the rear using wheel lift equipment. This prevents damage to the transmission.

Towing an all-wheel drive vehicle requires that all wheels be off the ground, such as using a wheel lift and dollies or flatbed equipment. This prevents damage to the transmission, all-wheel drive system and vehicle.

TOWING THE VEHICLE ON FOUR WHEELS

Emergency Towing

If your vehicle becomes inoperable (without access to wheel dollies, car-hauling trailer, or flatbed transport vehicle), it can be flat-towed (all wheels on the ground, regardless of the powertrain and transmission configuration) under the following conditions:

- Your vehicle is facing forward for towing in a forward direction.
- Place the transmission in position **N**. See *Automatic transmission* in the *Transmission* chapter if you cannot move the transmission into **N**.
- Maximum speed is 35 mph (56 km/h).
- Maximum distance is 50 miles (80 kilometers).

Recreational Towing

Note: Put your climate control system in recirculated air mode to prevent exhaust fumes from entering your vehicle. See the *Climate Control* chapter.

Follow these guidelines if you need to tow your vehicle behind another vehicle, such as a motorhome. We designed these guidelines to prevent damage to your vehicle and its transmission after it is hooked-up to the recreational vehicle or tow dolly.

You can tow your front-wheel drive vehicle with all four wheels on the ground or with the front wheels off the ground by using a tow dolly. If you are using a tow dolly, follow the instructions specified by the equipment provider. If you are towing with all four wheels on the ground, see the following instructions.

You can tow your all-wheel drive vehicle with all four wheels on the ground or with all four wheels off the ground using a vehicle transport trailer. Do not tow your all-wheel drive vehicle with the front wheels off the ground (by using a tow dolly) and the rear wheels on the ground. This causes damage to your all-wheel drive system. If you are using a vehicle transport trailer, follow the instruction specified by the equipment provider. If you are towing with all four wheels on the ground, see the following instructions.

If you tow your vehicle with all four wheels on the ground:

- Tow only in the forward direction.
- Release the parking brake.
- Place the transmission in position **N**.
- Place the ignition in the accessory mode. See *Ignition* in the *Starting and Stopping the Engine* chapter.
- Do not exceed 65 mph (105 km/h).
- Start the engine and allow it to run for five minutes at the beginning of each day and every six hours thereafter. With the engine running and your foot on the brake, shift into position **D** and then into position **R** before shifting back into position **N**.

BREAKING-IN

You need to break in new tires for approximately 300 miles (480 kilometers). During this time, your vehicle may exhibit some unique driving characteristics. Avoid driving too fast during the first 1000 miles (1600 kilometers). Vary your speed frequently and change up through the gears early. Do not labor the engine. Do not tow during the first 1000 miles (1600 kilometers).

ECONOMICAL DRIVING

Fuel economy is affected by several things, such as how you drive, the conditions you drive under and how you maintain your vehicle.

There are some things to keep in mind that may improve your fuel economy:

- Accelerate and slow down in a smooth, moderate fashion.
- Drive at steady speeds without stopping.
- Anticipate stops; slowing down may eliminate the need to stop.
- Combine errands and minimize stop-and-go driving.
- Close the windows for high-speed driving.
- Drive at reasonable speeds (traveling at 55 mph [88 km/h] uses 15% less fuel than traveling at 65 mph [105 km/h]).
- Keep the tires properly inflated and use only the recommended size.
- Use the recommended engine oil.
- Perform all regularly scheduled maintenance.

There are also some things you may not want to do because they may reduce your fuel economy:

- Sudden or hard accelerations.
- Rev the engine before turning it off.
- Idle for periods longer than one minute.
- Warm up your vehicle on cold mornings.
- Use the air conditioner or front defroster.
- Use the speed control in hilly terrain.
- Rest your foot on the brake pedal while driving.
- Drive a heavily loaded vehicle or tow a trailer.
- Carry unnecessary weight (approximately 1 mpg [0.4 km/L] is lost for every 400 pounds [180 kilograms] of weight carried).

- Add particular accessories to your vehicle (e.g.; bug deflectors, rollbars or light bars, running boards, ski racks).
- Drive with the wheels out of alignment.

DRIVING THROUGH WATER



WARNING: Drive through water in an emergency only, and not as part of normal driving.



WARNING: Engine damage can occur if water enters the air filter.

Note: Driving through deep water may allow water into the transmission or air intake and can cause internal vehicle damage or cause it to stall.

Note: Once through the water, always dry the brakes by moving your vehicle slowly while applying light pressure on the brake pedal.

If driving through deep or standing water is unavoidable, proceed very slowly. Never drive through water that is higher than the bottom of the wheel rims (for cars) or the bottom of the hubs (for trucks).

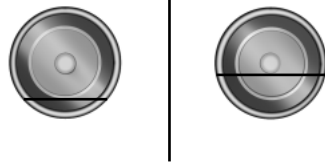

When driving through water, traction or brake capability may be limited. Also, water may enter your engine's air intake and severely damage your engine or your vehicle may stall.

Wet brakes do not stop the vehicle as quickly as dry brakes.

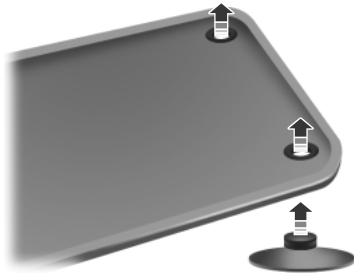
FLOOR MATS

! **WARNING:** Always use floor mats that are designed to fit the foot well of your vehicle, leaving the pedal area unobstructed, and which can be firmly secured to retention posts so that they cannot slip out of position and interfere with the pedals or impair safe operation of your vehicle in other ways.

- Incorrectly fitted floor mats can cause the accelerator pedal to become stuck in the open position. This can cause loss of vehicle control.
- Always correctly install the floor mats to the retention posts so that they cannot slip out of position or obstruct pedal operation.
- Do not place unsecured floor mats or any other covering in the foot well.
- Do not place additional floor mats or any other covering on top of the original floor mats. This will reduce the pedal clearance and interfere with the pedal operation.
- Do not allow objects to fall or become trapped under the pedals of your vehicle. This can cause loss of vehicle control.
- Carry out regular inspections to make sure the floor mats are secure.

To install the floor mats, position the floor mat eyelet over the retention post and press down to lock in position.

Remove in reverse order.

ROADSIDE ASSISTANCE**Vehicles Sold in the United States: Getting Roadside Assistance**

To fully assist, if you have a vehicle concern, Ford Motor Company offers a complimentary Roadside Assistance program. This program is separate from the New Vehicle Limited Warranty. The service is available:

- 24 hours a day, seven days a week.
- Throughout the life of the vehicle for original owners.
- For six years or 70000 miles (112655 kilometers) (whichever comes first) within the extended powertrain warranty coverage period for subsequent owners.
- For the coverage period listed on the Roadside Assistance Card included in your Owner's Manual portfolio.

Roadside assistance will cover:

- A flat tire change with a good spare (except vehicles supplied with a temporary mobility kit).
- Battery jump start.
- Lock-out assistance (key replacement cost is the customer's responsibility).
- Fuel delivery – independent service contractors, if not prohibited by state, local or municipal law, shall deliver up to 2.0 gallons (7.5 liters) of gasoline or 5.0 gallons (18.9 liters) of diesel fuel to a disabled vehicle. Fuel delivery service is limited to two no-charge occurrences within a 12-month period.
- Winch out – available within 100 feet (30.5 meters) of a paved or county maintained road, no recoveries.
- Towing – Lincoln eligible vehicles to the client's selling or preferred dealer within 100 miles (161 kilometers) of the disablement location or to the nearest Lincoln dealer. If a client requests a tow to a selling or preferred dealer that is more than 100 miles (161 kilometers) from the disablement location, the client shall be responsible for any mileage costs in excess of 100 miles (161 kilometers).

Roadside Assistance will include up to \$200 coverage for a towed trailer if the disabled eligible vehicle requires service at the nearest authorized dealer. If the towing vehicle is operational but the trailer is not, then the trailer does not qualify for any roadside services.

Vehicles sold in the United States: Using roadside assistance

United States Lincoln vehicle clients who require Roadside Assistance, call 1-800-521-4140. If you need to arrange roadside assistance for yourself, Ford Motor Company will reimburse a reasonable amount for towing to the nearest Lincoln dealership within 100 miles (161 kilometers). To obtain reimbursement information, United States Lincoln vehicle clients, call 1-800-521-4140. Clients will be asked to submit their original receipts.

Vehicles Sold in Canada: Getting Roadside Assistance

Canadian clients who require roadside assistance, call 1-800-387-9333.

Vehicles Sold in Canada: Using Roadside Assistance

For your convenience, you may complete the roadside assistance identification card found in the centerfold of this warranty guide and retain for future reference.

Canadian roadside coverage and benefits may differ from the U.S. coverage. If you require more information, please refer to the coverage section of your warranty guide, call us in Canada at 1-800-387-9333 or visit our website at www.lincolncanada.com.

HAZARD WARNING FLASHERS

The hazard flasher control is located on the instrument panel by the radio. Use it when your vehicle is disabled and is creating a safety hazard for other motorists.

- Press the flasher control and all front and rear direction signals will flash.
- Press the flasher control again to turn them off.

Note: With extended use, the flashers may run down your 12-volt battery.

FUEL SHUTOFF

WARNING: Failure to inspect and if necessary repair fuel leaks after a collision may increase the risk of fire and serious injury.

Ford Motor Company recommends that the fuel system be inspected by an authorized dealer after any collision.

In the event of a moderate to severe collision, this vehicle includes a fuel pump shutoff feature that stops the flow of fuel to the engine. Not every impact will cause a shutoff.

Should your vehicle shut off after a collision, you may restart your vehicle. For vehicles equipped with a key system:

1. Switch off the ignition.
2. Switch on the ignition.
3. Repeat Steps 1 and 2 to re-enable fuel pump.

For vehicles equipped with a push button start system:

1. Press the **START/STOP** button to switch off the ignition.
2. Press the brake pedal and press the **START/STOP** button to start the vehicle.
3. Remove your foot from the brake pedal and press the **START/STOP** button to switch off the ignition.
4. You can either attempt to start the engine by pressing the brake pedal and the **START/STOP** button, or switch on the ignition only by pressing the **START/STOP** button without pressing the brake pedal. Both ways re-enable the fuel system.

Note: When you try to restart your vehicle after a fuel shutoff, the vehicle makes sure that various systems are safe to restart. Once your vehicle determines that the systems are safe, then the vehicle will allow you to restart.

Note: In the event that your vehicle does not restart after your third attempt, contact an authorized dealer.

JUMP-STARTING THE VEHICLE



WARNING: The gases around the battery can explode if exposed to flames, sparks, or lit cigarettes. An explosion could result in injury or vehicle damage.



WARNING: Batteries contain sulfuric acid which can burn skin, eyes and clothing, if contacted.

Do not attempt to push-start your automatic transmission vehicle. Automatic transmissions do not have push-start capability. Attempting to push-start a vehicle with an automatic transmission may cause transmission damage.

When the battery is disconnected or a new battery is installed, the automatic transmission must relearn its shift strategy. As a result, the transmission may exhibit a combination of firm and soft shifts. This operation is considered normal and will not affect function or durability of the transmission. Over time, the adaptive learning process will fully update transmission operation.

Preparing Your Vehicle

Note: Use only a 12-volt supply to start your vehicle.

Note: Do not disconnect the battery of the disabled vehicle as this could damage the vehicle's electrical system.

1. Park the booster vehicle close to the hood of the disabled vehicle making sure the two vehicles do not touch. Set the parking brake on both vehicles and stay clear of the engine cooling fan and other moving parts.
2. Check all battery terminals. Remove the positive terminal cover (if equipped) and any excessive corrosion before you attach the battery cables. Ensure that vent caps are tight and level.
3. Turn the heater fan on in both vehicles to protect from any electrical surges. Turn all other accessories off.

Connecting the Jumper Cables



WARNING: Do not connect the end of the second cable to the negative (-) terminal of the battery to be jumped. A spark may cause an explosion of the gases that surround the battery.

Note: Do not attach the negative (-) cable to fuel lines, engine rocker covers, the intake manifold or electrical components as grounding points.

Note: In the illustration, the vehicle on the bottom is used to designate the assisting (boosting) battery.

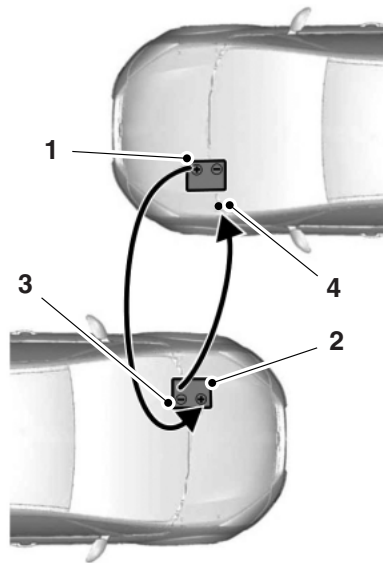

1. Connect the positive (+) jumper cable to the positive (+) terminal of the discharged battery.

2. Connect the other end of the positive (+) cable to the positive (+) terminal of the assisting battery.

3. Connect the negative (-) cable to the negative (-) terminal of the assisting battery.

4. Make the final connection of the negative (-) cable to an exposed metal part of the stalled vehicle's engine, away from the battery and the carburetor or fuel injection system.

Ensure that the cables are clear of fan blades, belts, moving parts of both engines, or any fuel delivery system parts.

Jump Starting

1. Start the engine of the booster vehicle and run the engine at a moderately increased speed.

2. Start the engine of the disabled vehicle.

3. Once the disabled vehicle has been started, run both engines for an additional three minutes before disconnecting the jumper cables.

Removing the Jumper Cables

Note: In the illustration, the vehicle on the bottom is used to designate the assisting (boosting) battery.

Remove the jumper cables in the reverse order that they were connected.

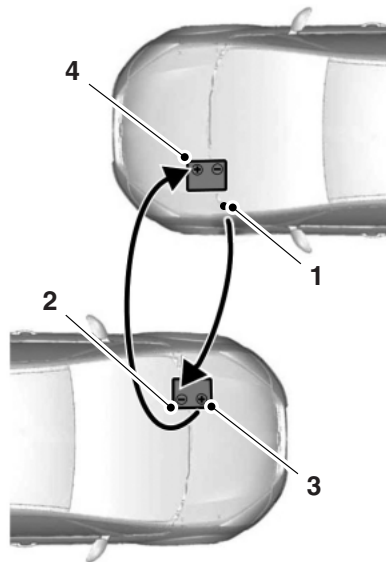

1. Remove the jumper cable from the ground metal surface.
2. Remove the jumper cable on the negative (-) terminal of the booster vehicle's battery.
3. Remove the jumper cable from the positive (+) terminal of the booster vehicle's battery.
4. Remove the jumper cable from the positive (+) terminal of the disabled vehicle's battery.

After the disabled vehicle has been started and the jumper cables removed, allow it to idle for several minutes so the engine computer can relearn its idle conditions.

GETTING THE SERVICES YOU NEED

Warranty repairs to your vehicle must be performed by an authorized dealer. While any authorized dealer handling your vehicle line will provide warranty service, we recommend you return to your selling authorized dealer who wants to ensure your continued satisfaction.

Please note that certain warranty repairs require special training, equipment or both, so not all authorized dealers are authorized to perform all warranty repairs. This means that, depending on the warranty repair needed, you may have to take your vehicle to another authorized dealer.

A reasonable time must be allowed to perform a repair after taking your vehicle to the authorized dealer. Repairs will be made using Ford or Motorcraft parts, or remanufactured or other parts that are authorized by Ford.

Away from home

If you are away from home when your vehicle needs service, contact the Ford Customer Relationship Center or use the online resources listed below to find the nearest authorized dealer.

In the United States:

Mailing address

Ford Motor Company
Customer Relationship Center
P.O. Box 6248
Dearborn, MI 48121

Telephone

1-800-521-4140
(TDD for the hearing impaired: 1-800-232-5952)

Online

Additional information and resources are available online at www.lincolnowner.com

- U.S. dealer locator by Dealer Name, City/State, or Zip Code
- Owner Guides
- Maintenance Schedules
- Recalls
- Ford Extended Service Plans
- Ford Genuine Accessories
- Service specials and promotions.

In Canada:

Mailing address

Lincoln Customer Relationship Centre
Ford Motor Company of Canada, Limited
P.O. Box 2000
Oakville, Ontario L6K 1C8

Telephone

1-800-387-9333

Online

www.lincolncanada.com

Additional assistance

If you have questions or concerns, or are unsatisfied with the service you are receiving, follow these steps:

1. Contact your Sales Representative or Service Advisor at your selling/servicing authorized dealer.
2. If your inquiry or concern remains unresolved, contact the Sales Manager, Service Manager or Customer Relations Manager.
3. If you require assistance or clarification on Ford Motor Company policies, please contact the Ford Customer Relationship Center

In order to help you serve you better, please have the following information available when contacting a Customer Relationship Center:

- Vehicle Identification Number (VIN)
- Your telephone number (home and business)
- The name of the authorized dealer and city where located
- The vehicle's current odometer reading

In some states, you must directly notify Ford in writing before pursuing remedies under your state's warranty laws. Ford is also allowed a final repair attempt in some states.

In the United States, a warranty dispute must be submitted to the BBB AUTO LINE before taking action under the Magnuson-Moss Warranty Act, or to the extent allowed by state law, before pursuing replacement or repurchase remedies provided by certain state laws. This dispute handling procedure is not required prior to enforcing state created rights or other rights which are independent of the Magnuson-Moss Warranty Act or state replacement or repurchase laws.

IN CALIFORNIA (U.S. ONLY)

California Civil Code Section 1793.2(d) requires that, if a manufacturer or its representative is unable to repair a motor vehicle to conform to the vehicle's applicable express warranty after a reasonable number of attempts, the manufacturer shall be required to either replace the vehicle with one substantially identical or repurchase the vehicle and reimburse the buyer in an amount equal to the actual price paid or payable by the consumer (less a reasonable allowance for consumer use). The consumer has the right to choose whether to receive a refund or replacement vehicle.

California Civil Code Section 1793.22(b) presumes that the manufacturer has had a reasonable number of attempts to conform the vehicle to its applicable express warranties if, within the first 18 months of ownership of a new vehicle or the first 18000 mi (29 000 km), whichever occurs first:

1. Two or more repair attempts are made on the same nonconformity likely to cause death or serious bodily injury OR
2. Four or more repair attempts are made on the same nonconformity (a defect or condition that substantially impairs the use, value or safety of the vehicle) OR
3. The vehicle is out of service for repair of nonconformities for a total of more than 30 calendar days (not necessarily all at one time).

In the case of 1 or 2 above, the consumer must also notify the manufacturer of the need for the repair of the nonconformity at the following address:

Ford Motor Company
16800 Executive Plaza Drive
Mail Drop 3NE-B
Dearborn, MI 48126

You are required to submit your warranty dispute to BBB AUTO LINE before asserting in court any rights or remedies conferred by California Civil Code Section 1793.22(b). You are also required to use BBB AUTO LINE before exercising rights or seeking remedies created by the Federal Magnuson-Moss Warranty Act, 15 U.S.C. sec. 2301 et seq. If you choose to seek redress by pursuing rights and remedies not created by California Civil Code Section 1793.22(b) or the Magnuson-Moss Warranty Act, resorting to BBB AUTO LINE is not required by those statutes.

**THE BETTER BUSINESS BUREAU (BBB) AUTO LINE PROGRAM
(U.S. ONLY)**

Your satisfaction is important to Ford Motor Company and to your dealer. If a warranty concern has not been resolved using the three-step procedure outlined earlier in this chapter in the *Getting the Services You Need* section, you may be eligible to participate in the BBB AUTO LINE program.

The BBB AUTO LINE program consists of two parts – mediation and arbitration. During mediation, a representative of the BBB will contact both you and Ford Motor Company to explore options for settlement of the claim. If an agreement is not reached during mediation or you do not want to participate in mediation, and if your claim is eligible, you may participate in the arbitration process. An arbitration hearing will be scheduled so that you can present your case in an informal setting before an impartial person. The arbitrator will consider the testimony provided and make a decision after the hearing.

Disputes submitted to the BBB AUTO LINE program are usually decided within 40 days after you file your claim with the BBB. You are not bound by the decision, and may reject the decision and proceed to court where all findings of the BBB Auto Line dispute, and decision, are admissible in the court action. Should you choose to accept the BBB AUTO LINE decision, Ford is then bound by the decision, and must comply with the decision within 30 days of receipt of your acceptance letter.

BBB AUTO LINE Application: Using the information provided below, please call or write to request a program application. You will be asked for your name and address, general information about your new vehicle, information about your warranty concerns, and any steps you have already taken to try to resolve them. A Customer Claim Form will be mailed that will need to be completed, signed and returned to the BBB along with proof of ownership. Upon receipt, the BBB will review the claim for eligibility under the Program Summary Guidelines.

You can get more information by calling BBB AUTO LINE at 1-800-955-5100, or writing to:

**BBB AUTO LINE
3033 Wilson Boulevard, Suite 600
Arlington, Virginia 22201**

BBB AUTO LINE applications can also be requested by calling the Ford Motor Company Customer Relationship Center at 1-800-392-3673.

Note: Ford Motor Company reserves the right to change eligibility limitations, modify procedures, or to discontinue this process at any time without notice and without obligation.

UTILIZING THE MEDIATION or ARBITRATION PROGRAM (CANADA ONLY)

This pertains to vehicles delivered to authorized Canadian dealers. In those cases, where you continue to feel that the efforts by Ford of Canada and the authorized dealer to resolve a factory-related vehicle service concern have been unsatisfactory, Ford of Canada participates in an impartial third party mediation or arbitration program administered by the Canadian Motor Vehicle Arbitration Plan (CAMVAP).

The CAMVAP program is a straightforward and relatively speedy alternative to resolve a disagreement when all other efforts to produce a settlement have failed. This procedure is without cost to you and is designed to eliminate the need for lengthy and expensive legal proceedings.

In the CAMVAP program, impartial third-party arbitrators conduct hearings at mutually convenient times and places in an informal environment. These impartial arbitrators review the positions of the parties, make decisions and, when appropriate, render awards to resolve disputes. CAMVAP decisions are fast, fair, and final as the arbitrator's award is binding on both you and Ford of Canada.

CAMVAP services are available in all Canadian territories and provinces. For more information, without charge or obligation, call your CAMVAP Provincial Administrator directly at 1-800-207-0685 or visit www.camvap.ca.

GETTING ASSISTANCE OUTSIDE THE U.S. AND CANADA

Before exporting your vehicle to a foreign country, contact the appropriate foreign embassy or consulate. These officials can inform you of local vehicle registration regulations and where to find unleaded fuel.

If you cannot find unleaded fuel or can only get fuel with an anti-knock index lower than is recommended for your vehicle, contact our Customer Relationship Center.

The use of leaded fuel in your vehicle without proper conversion may damage the effectiveness of your emission control system and may cause engine knocking or serious engine damage. Ford Motor Company or Ford of Canada is not responsible for any damage caused by use of improper fuel. Using leaded fuel may also result in difficulty importing your vehicle back into the United States.

If your vehicle must be serviced while you are traveling or living in Asia-Pacific Region, Sub-Saharan Africa, U.S. Virgin Islands, Central America, the Caribbean, and Israel, contact the nearest authorized dealer. If the authorized dealer cannot help you, contact:

FORD MOTOR COMPANY
Customer Relationship Center
1555 Fairlane Drive
Fairlane Business Park #3
Allen Park, Michigan 48101
U.S.A.
Telephone: (313) 594-4857
FAX: (313) 390-0804
Email: expcac@ford.com

For customers in Guam, the Commonwealth of the Northern Mariana Islands (CNMI), American Samoa, and the U.S. Virgin Islands, please feel free to call our Toll-Free Number:
(800) 841-FORD (3673)

If your vehicle must be serviced while you are traveling or living in Puerto Rico, contact the nearest authorized dealer. If the authorized dealer cannot help you, contact:

FORD MOTOR COMPANY
Customer Relationship Center
1555 Fairlane Drive
Fairlane Business Park #3
Allen Park, Michigan 48101
Telephone: (800) 841-FORD (3673)
FAX: (313) 390-0804
Email: prcac@ford.com
www.ford.com.pr

If your vehicle must be serviced while you are traveling or living in the Middle East, contact the nearest authorized dealer. If the authorized dealer cannot help you, contact:

FORD MOTOR COMPANY

Customer Relationship Center

1555 Fairlane Drive

Fairlane Business Park #3

Allen Park, Michigan 48101

Telephone: +971 4 3326084

Toll-Free Number of the Kingdom of Saudi Arabia: 800 8971409

Local Telephone Number of Kuwait: 24810575

FAX: +971 4 3327299

Email: menacac@ford.com

www.me.ford.com

If you buy your vehicle in North America and then relocate to any of the above locations, register your vehicle identification number (VIN) and new address with Ford Motor Company Export Operations & Global Growth Initiatives by emailing expcac@ford.com.

If you are in another foreign country, contact the nearest authorized dealer. In the event your inquiry is unresolved, communicate your concern with the dealership's Sales Manager, Service Manager or Customer Relations Manager. If you require additional assistance or clarification, please contact the respective Customer Relationship Center as previously listed.

Customers in the U.S. should call 1-800-392-3673.

ORDERING ADDITIONAL OWNER'S LITERATURE

To order the publications in this portfolio, contact Helm, Incorporated at:

HELM, INCORPORATED

47911 Halyard Drive

Plymouth, Michigan 48170

Attention: Customer Service

Or to order a free publication catalog, call toll free: 1-800-782-4356

Monday-Friday 8:00 a.m. - 6:00 p.m. EST

Helm, Incorporated can also be reached by their website:

www.helminc.com.

(Items in this catalog may be purchased by credit card, check or money order.)

Obtaining a French Owner's Manual

A French owner's manual can be obtained from your authorized dealer or by contacting Helm, Incorporated using the contact information listed previously in this section.

REPORTING SAFETY DEFECTS (U.S. ONLY)

If you believe that your vehicle has a defect which could cause a crash or could cause injury or death, you should immediately inform the National Highway Traffic Safety Administration (NHTSA) in addition to notifying Ford Motor Company.

If NHTSA receives similar complaints, it may open an investigation, and if it finds that a safety defect exists in a group of vehicles, it may order a recall and remedy campaign. However, NHTSA cannot become involved in individual problems between you, your dealer, or Ford Motor Company.

To contact NHTSA, you may call the Vehicle Safety Hotline toll-free at 1-888-327-4236 (TTY: 1-800-424-9153); go to <http://www.safercar.gov>; or write to:

Administrator
1200 New Jersey Avenue, Southeast
Washington, D.C. 20590

You can also obtain other information about motor vehicle safety from <http://www.safercar.gov>.

REPORTING SAFETY DEFECTS (CANADA ONLY)

If you believe that your vehicle has a defect which could cause a crash or could cause injury or death, you should immediately inform Transport Canada, using their toll-free number: 1-800-333-0510, or online at: <http://www.tc.gc.ca/eng/roadsafety/menu.htm>

CHANGING A FUSE**Fuses**

WARNING: Always replace a fuse with one that has the specified amperage rating. Using a fuse with a higher amperage rating can cause severe wire damage and could start a fire.

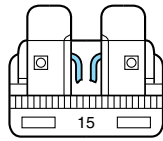

If electrical components in your vehicle are not working, a fuse may have blown. Blown fuses are identified by a broken wire within the fuse. Check the appropriate fuses before replacing any electrical components.

Standard Fuse Amperage Rating and Color

COLOR					
Fuse rating	Mini fuses	Standard fuses	Maxi fuses	Cartridge maxi fuses	Fuse link cartridge
2A	Grey	Grey	—	—	—
3A	Violet	Violet	—	—	—
4A	Pink	Pink	—	—	—
5A	Tan	Tan	—	—	—
7.5A	Brown	Brown	—	—	—
10A	Red	Red	—	—	—
15A	Blue	Blue	—	—	—
20A	Yellow	Yellow	Yellow	Blue	Blue
25A	Natural	Natural	—	Natural	Natural
30A	Green	Green	Green	Pink	Pink
40A	—	—	Orange	Green	Green
50A	—	—	Red	Red	Red
60A	—	—	Blue	Yellow	Yellow
70A	—	—	Tan	—	Brown
80A	—	—	Natural	Black	Black

FUSE SPECIFICATION CHART

Power Distribution Box



WARNING: Always disconnect the battery before servicing high current fuses.



WARNING: To reduce risk of electrical shock, always replace the cover to the power distribution box before reconnecting the battery or refilling fluid reservoirs.

The power distribution box is located in the engine compartment. It has high-current fuses that protect your vehicle's main electrical systems from overloads.

If the battery has been disconnected and reconnected, see *Changing the Vehicle Battery* in the *Maintenance* chapter.

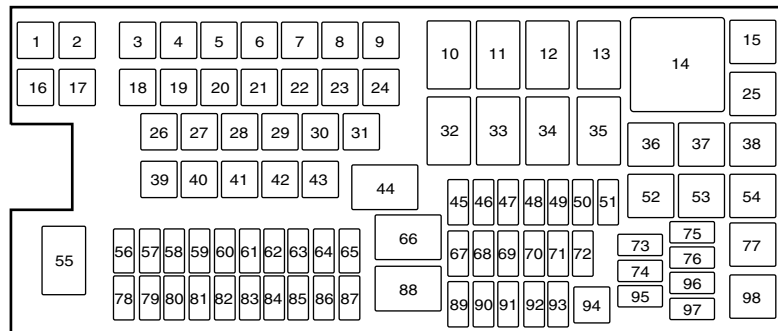

Fuse or relay number	Fuse amp rating	Protected components
1	—	Not used
2	—	Not used
3	—	Not used
4	30A**	Wipers

Fuse or relay number	Fuse amp rating	Protected components
5	40A**	Anti-lock brake system pump
6	—	Not used
7	30A**	Power liftgate
8	20A**	Moonroof
9	20A**	Power point #2 (console rear)
10	—	Not used
11	—	Rear window defroster and heated mirror relay
12	—	Not used
13	—	Starter relay
14	—	Not used
15	—	Fuel pump relay
16	—	Not used
17	—	Not used
18	40A**	Blower motor
19	30A**	Starter motor
20	20A**	Power point #1 (console bin)
21	20A**	Cargo area power point
22	—	Not used
23	30A**	Driver seat module
24	—	Not used
25	—	Not used
26	40A**	Rear window defroster
27	20A**	Front power point or lighter
28	30A**	Climate controlled seats
29	—	Not used
30	30A**	Rear heated seats
31	—	Not used
32	—	Not used
33	—	Not used
34	—	Blower motor relay

Fuse or relay number	Fuse amp rating	Protected components
35	—	Not used
36	—	Rear seat relay
37	—	Right trailer tow stop/turn lamps relay
38	—	Not used
39	40A**	Cooling fan (vehicles with trailer tow)
	60A**	Cooling fan (vehicles without trailer tow)
40	40A**	Cooling fan (trailer tow only)
41	—	Not used
42	30A**	Passenger seat
43	25A**	Anti-lock brake system valves
44	—	Rear washer relay
45	5A*	Rain sensor
46	—	Not used
47	—	Not used
48	—	Not used
49	—	Not used
50	15A*	Heated mirror
51	—	Not used
52	—	Not used
53	—	Left trailer tow stop/turn lamps relay
54	—	Not used
55	—	Wiper relay
56	—	Not used
57	20A*	Left high-intensity discharge headlamps
58	10A*	Alternator sensor
59	10A*	Brake on/off switch
60	—	Not used
61	10A*	Rear seat release

Fuse or relay number	Fuse amp rating	Protected components
62	10A*	Air conditioner clutch
63	15A*	Trailer tow stop/turn lamps relay
64	20A*	Rear wiper motor
65	15A*	Fuel pump
66	—	Powertrain control module relay
67	20A*	Vehicle power #2
68	15A*	Vehicle power #4
69	15A*	Vehicle power #1
70	10A*	Air conditioner relay, All-wheel drive module
71	—	Not used
72	—	Not used
73	—	Not used
74	—	Not used
75	—	Air conditioner clutch diode
76	—	Not used
77	—	Trailer tow park lamps relay
78	20A*	Right high-intensity discharge headlamps
79	5A*	Adaptive cruise control
80	—	Not used
81	—	Not used
82	15A*	Rear washer
83	—	Not used
84	20A*	Trailer tow park lamps
85	—	Not used
86	7.5A*	Powertrain control module keep-alive, Powertrain control module relay
87	5A*	Run/start relay
88	—	Run/start relay
89	5A*	Adaptive lighting

Fuse or relay number	Fuse amp rating	Protected components
90	10A*	Powertrain control module
91	10A*	Adaptive cruise control
92	10A*	Anti-lock brake system module
93	5A*	Blower motor/rear defroster relay
94	30A**	Passenger compartment fuse panel run/start
95	—	Not used
96	—	Not used
97	—	Not used
98	—	Air conditioner clutch relay
* Mini Fuses ** Cartridge Fuses		

Passenger Compartment Fuse Panel

The fuse panel is located behind a trim panel on the left side of the driver's footwell near the parking brake. To remove the trim panel, slide the release lever to the right then pull the trim panel out.

To remove the fuse panel cover, press in the tabs on both sides of the cover, then pull the cover off.

To reinstall the fuse panel cover, place the top part of the cover on the fuse panel, then push the bottom part of the cover until it clicks into place. Gently pull on the cover to make sure it is secure.

To reinstall the trim panel, align the tabs on the bottom of the panel with the grooves, push the panel shut and slide the release lever to the left to secure the panel.

To remove a fuse, use the fuse puller tool provided on the fuse panel cover.

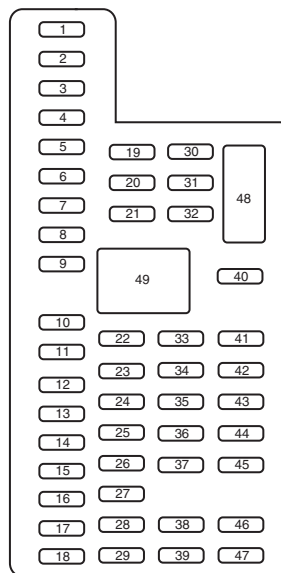

Fuse or relay number	Fuse amp rating	Protected components
1	30A	Driver front smart window
2	15A	Not used (spare)
3	30A	Passenger front smart window
4	10A	Demand lamps relay
5	20A	Subwoofer
6	5A	Radio frequency module
7	7.5A	Power mirror switch, Memory seat switch, Driver seat module
8	10A	Not used (spare)
9	10A	Power liftgate
10	10A	Run/accessory relay
11	10A	Instrument panel cluster, Heads-up display
12	15A	Interior lighting, Puddle lamps, Backlighting
13	15A	Right turn/stop lamps and turn signals
14	15A	Left turn/stop lamps and turn signals
15	15A	Reverse lamps, High-mounted stop lamps
16	10A	Low beam headlamps (right)
17	10A	Low beam headlamps (left)
18	10A	Keypad illumination, Brake shift interlock, Start button LED, Passive anti-theft system, Powertrain control module wake-up, Second row power enable
19	20A	Audio amplifier
20	20A	Lock/unlock relays – vehicles without intelligent access
21	10A	Not used (spare)
22	20A	Horn relay

Fuse or relay number	Fuse amp rating	Protected components
23	15A	Steering wheel control, Intelligent access, Headlamp switch
24	15A	Power tilt/telescope steering column, On-board diagnostics
25	15A	Liftgate release
26	5A	Global positioning system module
27	20A	Intelligent access
28	15A	Ignition switch (without intelligent access), Key inhibit solenoid, Push button start (with intelligent access)
29	20A	Radio, Electronic finish panel, SYNC module
30	15A	Front park lamps
31	5A	Not used (spare)
32	15A	Moonroof, Power windows (front), Compass/auto-dimming rear view mirror
33	10A	Not used (spare)
34	10A	Reverse sensing system, Rearview camera, Blind spot monitor, Rear heated seat module
35	5A	Heads-up display
36	10A	Heated steering wheel
37	10A	Climate control
38	10A	Not used (spare)
39	15A	High beam headlamps
40	10A	Rear park lamps, License plate lamps
41	7.5A	Occupant classification sensor, Restraints control module
42	5A	Not used (spare)
43	10A	Not used (spare)
44	10A	Not used (spare)

Fuses

251

Fuse or relay number	Fuse amp rating	Protected components
45	5A	Not used (spare)
46	10A	Climate control
47	15A	Fog lamps relay, LED signal mirrors
48	30A Circuit Breaker	Rear power windows
49	—	Delayed accessory relay

GENERAL INFORMATION

Have your vehicle serviced regularly to help maintain its roadworthiness and resale value. There is a large network of Ford authorized dealers who are there to help you with their professional servicing expertise. We believe that their specially trained technicians are best qualified to service your vehicle properly and expertly. They are supported by a wide range of highly specialized tools developed specifically for servicing your vehicle.

To help you service your vehicle, we provide *Scheduled Maintenance Information* which makes tracking routine service easy.

If your vehicle requires professional service, your authorized dealer can provide the necessary parts and service. Check your warranty information to find out which parts and services are covered.

Use only recommended fuels, lubricants, fluids and service parts conforming to specifications. Motorcraft® parts are designed and built to provide the best performance in your vehicle.

Precautions

- Do not work on a hot engine.
- Make sure that nothing gets caught in moving parts.
- Do not work on a vehicle with the engine running in an enclosed space, unless you are sure you have enough ventilation.
- Keep all open flames and other burning material (such as cigarettes) away from the battery and all fuel related parts.

Working with the Engine Off

1. Set the parking brake and shift to **P** (Park).
2. Turn off the engine and remove the key (if equipped).
3. Block the wheels.

Working with the Engine On

WARNING: To reduce the risk of vehicle damage or personal burn injuries, do not start your engine with the air cleaner removed and do not remove it while the engine is running.

1. Set the parking brake and shift to position **P** (Park) .
2. Block the wheels.

OPENING AND CLOSING THE HOOD

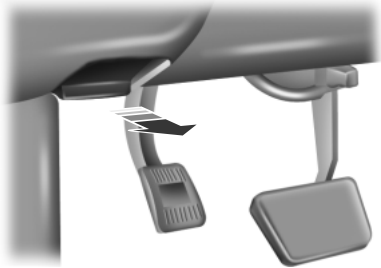

1. Inside the vehicle, pull the hood release handle located under the bottom of the instrument panel near the steering column.



2. Go to the front of the vehicle and release the secondary hood latch located under the front passenger side of the hood.

3. Lift the hood and support it with the prop rod.

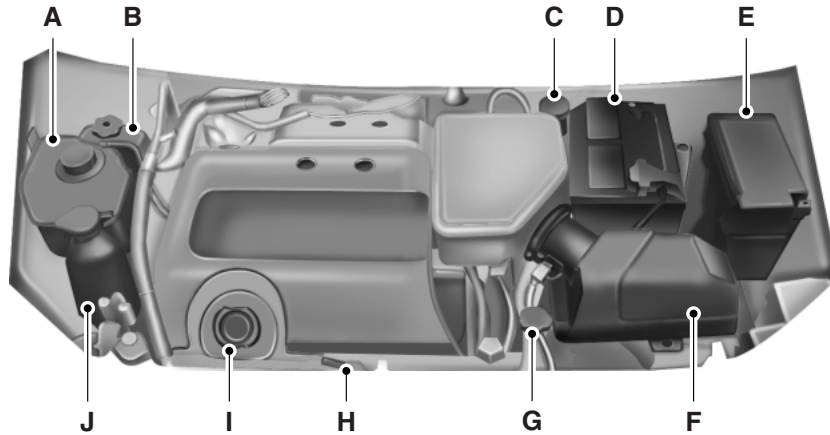
UNDER HOOD OVERVIEW

- A. Engine coolant reservoir
- B. Power steering fluid reservoir
- C. Brake fluid reservoir
- D. Battery
- E. Power distribution box
- F. Air filter assembly
- G. Transmission fluid dipstick
- H. Engine oil dipstick
- I. Engine oil filler cap
- J. Windshield washer fluid reservoir

ENGINE OIL DIPSTICK

- A. – MIN
- B. – MAX

**ENGINE OIL CHECK**

Note: Check the level before starting the engine.

Note: Make sure that the level is between the MIN and MAX marks.

1. Make sure that your vehicle is on level ground.
2. Turn the engine off and wait 10 minutes for the oil to drain into the oil pan.
3. Remove the dipstick and wipe it with a clean, lint-free cloth. Replace the dipstick and remove it again to check the oil level.

If the level is at the MIN mark, add oil immediately.

Adding Engine Oil

Note: Do not remove the filler cap when the engine is running.

Note: Do not add engine oil further than the MAX mark. Oil levels above the MAX mark may cause engine damage.



Only use oils certified for gasoline engines by the American Petroleum Institute (API). An oil with this trademark symbol conforms to the current engine and emission system protection standards and fuel economy requirements of the International Lubricants Specification Advisory Council (ILSAC), comprised of U.S. and Japanese automobile manufacturers.

1. Remove the filler cap.
2. Add engine oil that meets Ford specifications. See *Capacities and Specifications* for more information.
3. Replace the filler cap. Turn it until you feel a strong resistance.

ENGINE COOLANT CHECK**Checking the Engine Coolant**

The concentration and level of engine coolant should be checked at the intervals listed in *Scheduled Maintenance Information*.

Note: Make sure that the level is between the COLD FILL RANGE marks on the coolant reservoir.

Note: Coolant expands when it is hot. The level may extend beyond the upper COLD FILL RANGE mark.

Note: If the level is at the lower COLD FILL RANGE mark, below the lower COLD FILL RANGE mark, or empty, add coolant immediately. See *Adding Engine Coolant* in this chapter.

The coolant concentration should be maintained within 48% to 50% which equates to a freeze point between -30 °F (-34 °C) and -34 °F (-37 °C).

Note: For best results, coolant concentration should be tested with a refractometer such as Rotunda tool ROB75240 available from your dealer. Ford does not recommend the use of hydrometers or coolant test strips for measuring coolant concentrations.

Note: Automotive fluids are not interchangeable; do not use engine coolant/antifreeze or windshield washer fluid outside of its specified function and vehicle location.

Adding Engine Coolant

WARNING: Do not add engine coolant when the engine is hot. Steam and scalding liquids released from a hot cooling system can burn you badly. Also, you can be burned if you spill coolant on hot engine parts.



WARNING: Do not put engine coolant in the windshield washer fluid container. If sprayed on the windshield, engine coolant could make it difficult to see through the windshield.



WARNING: To reduce the risk of personal injury, make sure the engine is cool before unscrewing the coolant pressure relief cap. The cooling system is under pressure; steam and hot liquid can come out forcefully when the cap is loosened slightly.



WARNING: Do not add coolant further than the MAX mark.

Note: Do not use stop leak pellets, cooling system sealants or additives as they can cause damage to the engine cooling or heating systems. This damage would not be covered under your vehicle's warranty.

Note: During normal vehicle operation, the engine coolant may change color from orange to pink or light red. As long as the engine coolant is clear and uncontaminated, this color change does not indicate the engine coolant has degraded nor does it require the engine coolant to be drained, the system to be flushed, or the engine coolant to be replaced.

- DO NOT MIX different colors or types of coolant in your vehicle. Make sure the correct coolant is used. Mixing of engine coolants may harm your engine's cooling system. The use of an improper coolant may harm engine and cooling system components and may void the warranty.
- In case of emergency, a large amount of water without engine coolant may be added in order to reach a vehicle service location. In this instance, the cooling system must be drained, chemically cleaned with Motorcraft Premium Cooling System Flush, and refilled with engine coolant as soon as possible. Water alone (without engine coolant) can cause engine damage from corrosion, overheating or freezing.
- Do not use alcohol, methanol, brine or any engine coolants mixed with alcohol or methanol antifreeze (coolant). Alcohol and other liquids can cause engine damage from overheating or freezing.
- Do not add extra inhibitors or additives to the coolant. These can be harmful and compromise the corrosion protection of the engine coolant.

Unscrew the cap slowly. Any pressure will escape as you unscrew the cap.

Add prediluted engine coolant meeting the Ford specification. See *Capacities and Specifications* for more information.

Whenever coolant has been added, the coolant level in the coolant reservoir should be checked the next few times you drive the vehicle. If necessary, add enough prediluted engine coolant to bring the coolant level to the proper level.

Recycled Engine Coolant

Ford Motor Company does NOT recommend the use of recycled engine coolant since a Ford-approved recycling process is not yet available.



Used engine coolant should be disposed of in an appropriate manner. Follow your community's regulations and standards for recycling and disposing of automotive fluids.

Severe Climates

If you drive in extremely cold climates:

- It may be necessary to have a Ford authorized dealer increase the coolant concentration above 50%.
- A coolant concentration of 60% will provide improved freeze point protection. Engine coolant concentrations above 60% will decrease the overheat protection characteristics of the engine coolant and may cause engine damage.

If you drive in extremely hot climates:

- It may be necessary to have a Ford authorized dealer decrease the coolant concentration to 40%.
- A coolant concentration of 40% will provide improved overheat protection. Engine coolant concentrations below 40% will decrease the corrosion/freeze protection characteristics of the engine coolant and may cause engine damage.

Vehicles driven year-round in non-extreme climates should use prediluted engine coolant for optimum cooling system and engine protection.

What You Should Know About Fail-Safe Cooling

If the engine coolant supply is depleted, this feature allows the vehicle to be driven temporarily before incremental component damage is incurred. The fail-safe distance depends on ambient temperatures, vehicle load and terrain.

How Fail-Safe Cooling Works

If the engine begins to overheat, the engine coolant temperature gauge will move to the red (hot) area and:



The coolant temperature warning light will illuminate.



The service engine soon indicator will illuminate.

If the engine reaches a preset over-temperature condition, the engine will automatically switch to alternating cylinder operation. Each disabled cylinder acts as an air pump and cools the engine.

When this occurs the vehicle will still operate. However:

- The engine power will be limited.
- The air conditioning system will be disabled.

Continued operation will increase the engine temperature and the engine will completely shut down, causing steering and braking effort to increase.

Once the engine temperature cools, the engine can be restarted. Take your vehicle to an authorized dealer as soon as possible to minimize engine damage.

When Fail-Safe Mode is Activated

WARNING: Fail-safe mode is for use during emergencies only.

Operate the vehicle in fail-safe mode only as long as necessary to bring the vehicle to rest in a safe location and seek immediate repairs. When in fail-safe mode, the vehicle will have limited power, will not be able to maintain high-speed operation, and may completely shut down without warning, potentially losing engine power, power steering assist, and power brake assist, which may increase the possibility of a crash resulting in serious injury.



WARNING: Never remove the coolant reservoir cap while the engine is running or hot.

You have limited engine power when in the fail-safe mode, so drive the vehicle with caution. The vehicle will not be able to maintain high-speed operation and the engine will run rough. Remember that the engine is capable of completely shutting down automatically to prevent engine damage, therefore:

1. Pull off the road as soon as safely possible and turn off the engine.
2. Arrange for the vehicle to be taken to an authorized dealer.
3. If this is not possible, wait a short period for the engine to cool.
4. Check the coolant level and replenish if low.
5. Restart the engine and take your vehicle to an authorized dealer.

Note: Driving the vehicle without repairing the engine problem increases the chance of engine damage. Take your vehicle to an authorized dealer as soon as possible.

TRANSMISSION FLUID CHECK

Note: Automatic transmission fluid expands when warmed. To obtain an accurate fluid check, drive the vehicle until it is warmed up (approximately 20 miles [30 km]). If your vehicle has been operated for an extended period at high speeds, in city traffic during hot weather or pulling a trailer, the vehicle should be turned off until normal operating temperatures are reached to allow the fluid to cool before checking. Depending on vehicle use, cooling times could take up to 30 minutes or longer.

Refer to your *scheduled maintenance information* for scheduled intervals for fluid checks and changes. Your transmission does not consume fluid. However, the fluid level should be checked if the transmission is not working properly, i.e., if the transmission slips or shifts slowly or if you notice some sign of fluid leakage.



WARNING: The dipstick cap and surrounding components may be hot; gloves are recommended.

1. Drive the vehicle 20 miles (30 km) or until it reaches normal operating temperature.
2. Park the vehicle on a level surface and engage the parking brake.
3. With the parking brake engaged and your foot on the brake pedal, start the engine and move the gearshift lever through all of the gear ranges. Allow a minimum of 10 seconds for each gear to engage.
4. Latch the gearshift lever in P (Park) and leave the engine running.

5. Remove the dipstick, wiping it clean with a clean, dry lint free rag. If necessary, refer to *Under hood overview* in this chapter for the location of the dipstick.
6. Install the dipstick making sure it is fully seated in the filler tube by turning it to the locked position.
7. Remove the dipstick and inspect the fluid level. The fluid should be in the designated areas for normal operating temperature.

Low fluid level



If the fluid level is below the MIN range of the dipstick, add fluid to reach the hash mark level. **Note:** If the fluid level is below the MIN level,

do not drive the vehicle. An underfill condition may cause shift and/or engagement concerns and/or possible damage.

Correct fluid level

The transmission fluid should be checked at normal operating temperature 180°F-200°F (82°C-93°C) on a level surface. The normal operating temperature can be reached after approximately 20 miles (30 km) of driving.

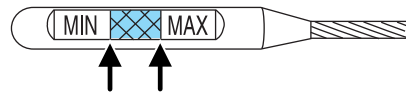

The transmission fluid level should be targeted within the cross-hatch area if at normal operating temperature 180°F-200°F (82°C-93°C) .

High fluid level

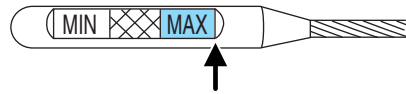

If the fluid level is above the MAX range of the dipstick, remove fluid to reach the hashmark level. **Note:** Fluid level above the MAX level may cause shift and/or engagement concerns and/or possible damage.

High fluid levels can be caused by an overheating condition. If your vehicle has been operated for an extended period at high speeds, in city traffic during hot weather or pulling a trailer, the vehicle should be turned off until normal operating temperatures are reached. Depending on vehicle use, cooling times could take up to 30 minutes or longer.

Adjusting automatic transmission fluid levels

Before adding any fluid, make sure the correct type is used. The type of fluid used is normally indicated on the dipstick and also in the *Technical specifications* section in this chapter.

Note: Use of a non-approved automatic transmission fluid may cause internal transmission component damage.

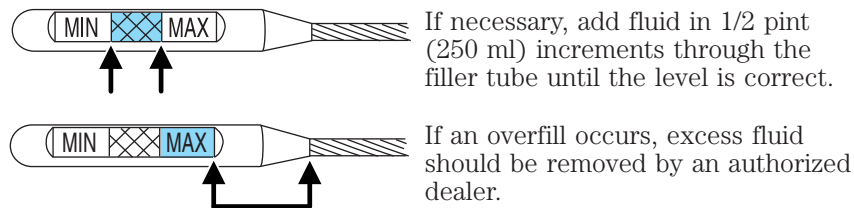

If necessary, add fluid in 1/2 pint (250 ml) increments through the filler tube until the level is correct.

If an overfill occurs, excess fluid should be removed by an authorized dealer.

Note: An overfill condition of transmission fluid may cause shift and/or engagement concerns and/or possible damage.

Do not use supplemental transmission fluid additives, treatments or cleaning agents. The use of these materials may affect transmission operation and result in damage to internal transmission components.

BRAKE FLUID CHECK

Fluid levels between the MIN and MAX lines are within the normal operating range; there is no need to add fluid. If the fluid levels are outside of the normal operating range, the performance of the system could be compromised; seek service from your authorized dealer immediately.

POWER STEERING FLUID CHECK

Check the power steering fluid. Refer to *scheduled maintenance information*.

1. Start the engine and let it run until it reaches normal operating temperature (the engine coolant temperature gauge indicator will be near the center of the normal area between H and C).
2. While the engine idles, turn the steering wheel left and right several times.
3. Turn the engine off.
4. Check the fluid level in the reservoir. It should be between the MIN and MAX lines. Do not add fluid if the level is in this range.
5. If the fluid is low, add fluid in small amounts, continuously checking the level until it reaches the range between the MIN and MAX lines. Be

sure to put the cap back on the reservoir. Refer to the *Capacities and Specifications* chapter for the proper fluid type.

FUEL FILTER

Your vehicle is equipped with a lifetime fuel filter that is integrated with the fuel tank. Regular maintenance or replacement is not needed.

WASHER FLUID CHECK



WARNING: If you operate your vehicle in temperatures below 40°F (5°C), use washer fluid with antifreeze protection. Failure to use washer fluid with antifreeze protection in cold weather could result in impaired windshield vision and increase the risk of injury or accident.

Add fluid to fill the reservoir if the level is low. Only use a washer fluid that meets Ford specifications. See the technical specifications chart in the *Capacities and Specifications* chapter.

Note: The front and rear washer systems are supplied from the same reservoir.

State or local regulations on volatile organic compounds may restrict the use of methanol, a common windshield washer antifreeze additive. Washer fluids containing non-methanol antifreeze agents should be used only if they provide cold weather protection without damaging the vehicle's paint finish, wiper blades or washer system.

CHANGING THE VEHICLE BATTERY



WARNING: Batteries normally produce explosive gases which can cause personal injury. Therefore, do not allow flames, sparks or lighted substances to come near the battery. When working near the battery, always shield your face and protect your eyes. Always provide proper ventilation.



WARNING: When lifting a plastic-cased battery, excessive pressure on the end walls could cause acid to flow through the vent caps, resulting in personal injury and/or damage to the vehicle or battery. Lift the battery with a battery carrier or with your hands on opposite corners.



WARNING: Keep batteries out of reach of children. Batteries contain sulfuric acid. Avoid contact with skin, eyes or clothing. Shield your eyes when working near the battery to protect against possible splashing of acid solution. In case of acid contact with skin or eyes, flush immediately with water for a minimum of 15 minutes and get prompt medical attention. If acid is swallowed, call a physician immediately.



WARNING: Battery posts, terminals and related accessories contain lead and lead compounds. Wash hands after handling.

Your vehicle is equipped with a Motorcraft® maintenance-free battery which normally does not require additional water during its life of service.

Note: If your battery has a cover/shield, make sure it is reinstalled after the battery has been cleaned or replaced.

For longer, trouble-free operation, keep the top of the battery clean and dry. Also, make certain the battery cables are always tightly fastened to the battery terminals.

If you see any corrosion on the battery or terminals, remove the cables from the terminals and clean with a wire brush. You can neutralize the acid with a solution of baking soda and water.

It is recommended that the negative battery cable terminal be disconnected from the battery if you plan to store your vehicle for an extended period of time.

To ensure proper operation of the battery management system (BMS), any electrical devices that are added to the vehicle should not have their ground connection made directly at the negative battery post. A connection at the negative battery post can cause inaccurate measurements of the battery condition and potential incorrect system operation.

Note: Electrical or electronic accessories or components added to the vehicle by the dealer or the owner may adversely affect battery performance and durability and may also affect the performance of other electrical systems in the vehicle.

When a battery replacement is required, the battery should only be replaced with a Ford recommended replacement battery that matches the electrical requirements of the vehicle.

When the battery is disconnected or a new battery installed, the automatic transmission must relearn its adaptive strategy. As a result of

this, the transmission may shift firmly when first driven. This operation is considered normal and will fully update transmission operation to its optimum shift feel.

If the battery has been disconnected or a new battery has been installed, the clock and the preset radio stations must be reset once the battery is reconnected.

Note: Always dispose of automotive batteries in a responsible manner. Follow your local authorized standards for disposal. Call your local authorized recycling center to find out more about recycling automotive batteries.

Because your vehicle's engine is electronically controlled by a computer, some control conditions are maintained by power from the battery. When the battery is disconnected or a new battery is installed, the engine must relearn its idle and fuel trim strategy for optimum driveability and performance. To begin this process:

1. With the vehicle at a complete stop, set the parking brake.
2. Put the gearshift in P (Park), turn off all accessories and start the engine.
3. Run the engine until it reaches normal operating temperature.
4. Allow the engine to idle for at least one minute.
5. Turn the A/C on and allow the engine to idle for at least one minute.
6. Drive the vehicle to complete the relearning process.
 - The vehicle may need to be driven 10 miles (16 km) or more to relearn the idle and fuel trim strategy.
 - **Note:** If you do not allow the engine to relearn its idle trim, the idle quality of your vehicle may be adversely affected until the idle trim is eventually relearned.

If the battery has been disconnected or a new battery has been installed, the clock and radio settings must be reset once the battery is reconnected.

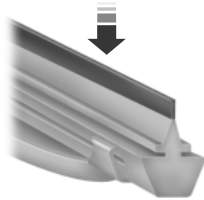
CHECKING THE WIPER BLADES

Run the tip of your fingers over the edge of the blade to check for roughness.

Clean the wiper blades with washer fluid or water applied with a soft sponge or cloth.

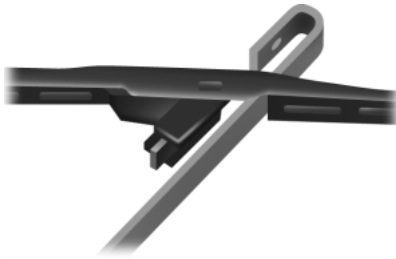
CHANGING THE WIPER BLADES

1. Pull the wiper arm away from the vehicle. Turn the blade at an angle from the wiper arm. Press the lock tab to release the blade and pull the wiper blade down toward the windshield to remove it from the arm.
2. Attach the new wiper to the wiper arm and press it into place until a click is heard.

Replace wiper blades at least once per year for optimum performance.

Poor wiper quality can be improved by cleaning the wiper blades and the windshield.

To prolong the life of the wiper blades, it is highly recommended to scrape off the ice on the windshield before turning on the wipers. The layer of ice has many sharp edges and can damage the micro edge of the wiper rubber element.

Changing rear window wiper blade

The rear wiper arm is designed without a service position. This reduces the risk of damage to the blade in an automatic car wash.

To replace the wiper blade:

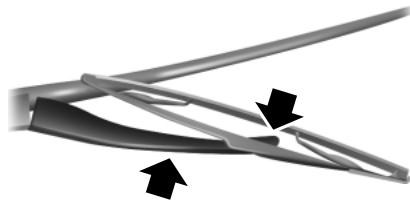

1. Grab the wiper arm with one hand close to the arm/blade joint and pull it as far away from the glass as possible. Do not use excessive force because it can break the wiper arm at the heel. Hold it there until the next step.

2. Grab the primary structure of the blade with the other hand close to the arm/blade joint.

3. Grip tightly and press on the arm/blade joint from beneath and separate the blade from the arm.

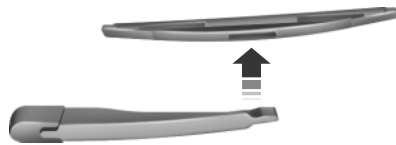

4. Attach the new wiper to the wiper arm and press it into place until a click is heard.

If you find this procedure too difficult, please see your dealer.

AIR FILTER CHECK



WARNING: To reduce the risk of vehicle damage and or personal burn injuries, do not start your engine with the air cleaner removed and do not remove it while the engine is running.

Note: Failure to use the correct air filter element may result in severe engine damage. The customer warranty may be void for any damage to the engine if the correct air filter element is not used.

When changing the air filter element, use only the air filter element listed. See *Motorcraft® Part Numbers* in the *Capacities and Specifications* chapter.

See *Scheduled Maintenance Information* for the appropriate intervals for changing the air filter element.

Note: Failure to use the correct air filter element may result in severe engine damage. The customer warranty may be void for any damage to the engine if the correct air filter element is not used.

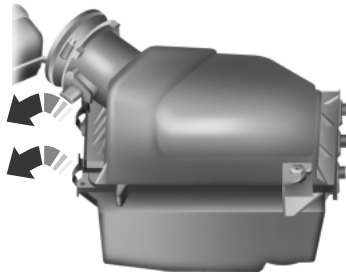
Changing the air filter element

1. Release the clamps that secure the air filter housing cover.
2. Carefully separate the two halves of the air filter housing.
3. Remove the air filter element from the air filter housing.
4. Wipe the air filter housing and cover clean to remove any dirt or debris and to ensure good sealing.
5. Install a new air filter element. Be careful not to crimp the filter element edges between the air filter housing and cover. This could cause filter damage and allow unfiltered air to enter the engine if not properly seated.

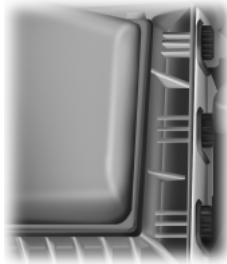

6. Replace the air filter housing cover and secure the clamps. Be sure that the air cleaner cover tabs are engaged into the slots of the air cleaner housing.

ADJUSTING THE HEADLAMPS

The headlamps on your vehicle are properly aimed at the assembly plant. If your vehicle has been in an accident, an authorized dealer should check the alignment of your headlamps.

Vertical Aim Adjustment

1. Park the vehicle directly in front of a wall or screen on a level surface, approximately 25 feet (7.6 meters) away.

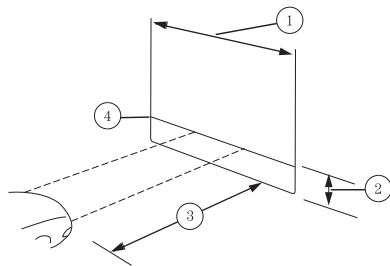

- (1) 8 feet (2.4 meters)
- (2) Center height of lamp to ground
- (3) 25 feet (7.6 meters)
- (4) Horizontal reference line

2. Measure the height of the headlamp bulb center from the ground and mark an 8 foot (2.4 meter) horizontal reference line on the vertical wall or screen at this height.

3. Turn on the low beam headlamps to illuminate the wall or screen and open the hood.

To see a clearer light pattern for adjusting, you may want to block the light from one headlamp while adjusting the other.

For Vehicles with Halogen Headlamps:

On the wall or screen you will observe a flat zone of high intensity light located at the top of the right hand portion of the beam pattern. If the top edge of the high intensity light zone is not at the horizontal reference line, the headlamp will need to be adjusted.

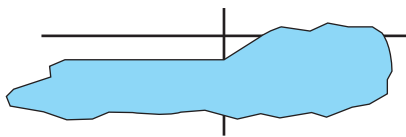
For Vehicles with HID Headlamps:

There is a distinct cut-off (change from light to dark) in the left portion of the beam pattern. The top edge of this cut-off should be positioned 2 inches (5 centimeters) below the horizontal reference line.

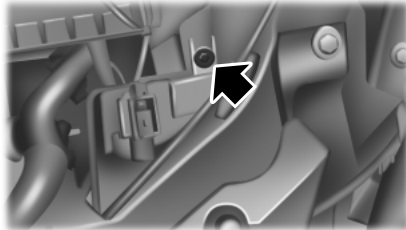

4. Locate the vertical adjuster on each headlamp. Using a Hex head driver, turn the adjuster either clockwise or counterclockwise in order to adjust the vertical aim of the headlamp.

5. Close the hood and turn off the lamps.
HORIZONTAL AIM IS NOT REQUIRED FOR THIS VEHICLE AND IS NON-ADJUSTABLE.

CHANGING A BULB

Lamp Assembly Condensation

Exterior lamps are vented to accommodate normal changes in pressure. Condensation can be a natural by-product of this design. When moist air enters the lamp assembly through the vents, there is a possibility that condensation can occur when the temperature is cold. When normal condensation occurs, a thin film of mist can form on the interior of the lens. The thin mist eventually clears and exits through the vents during normal operation. Clearing time may take as long as 48 hours under dry weather conditions.

These are examples of acceptable condensation:

- Presence of thin mist (no streaks, drip marks or droplets).
- Fine mist covers less than 50% of the lens.

These are examples of unacceptable moisture (usually caused by a lamp water leak):

- Water puddle inside the lamp.
- Large water droplets, drip marks or streaks present on the interior of the lens.

Take your vehicle to a dealer for service if any of the above conditions of unacceptable moisture are present.

Replacing headlamp bulbs



WARNING: Handle a halogen headlamp bulb carefully and keep out of children's reach. Grasp the bulb only by its plastic base and do not touch the glass. The oil from your hand could cause the bulb to break the next time the headlamps are operated.

Note: If the bulb is accidentally touched, it should be cleaned with rubbing alcohol before being used.

1. Make sure that the headlamp control is in the off position.
2. Open the hood.
3. Remove the bulb cover.

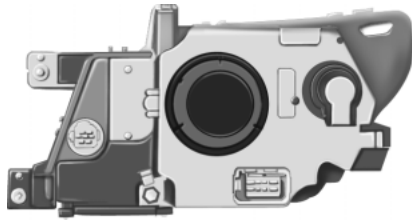

4. Turn the bulb holder counterclockwise and remove it.

5. Disconnect the electrical connector.
6. Reverse the procedure to install the new bulb.

Replacing HID headlamp bulbs (if equipped)

The low beam headlamps on your vehicle use a “high intensity discharge” source. These lamps operate at a high voltage. When the bulb is burned out, the bulb and starter capsule assembly must be replaced by your authorized dealer.

Replacing front parking lamp/turn signal bulbs

1. Make sure that the headlamp control is in the off position.
2. Open the hood.

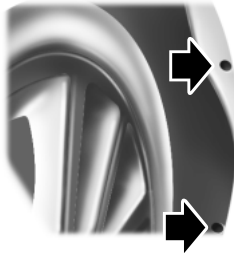

3. At the wheel well, remove the fasteners from the splash shield, then pull the splash shield back to gain access to the bulbs.

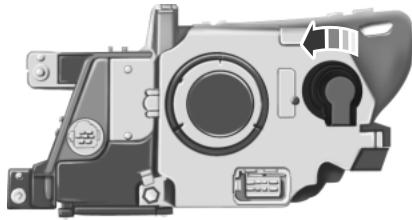

4. Rotate the bulb socket counterclockwise and remove from the lamp assembly.

5. Carefully pull the bulb out of the socket and push in the new bulb.

6. Install the bulb socket into the lamp assembly and rotate clockwise.

Replacing side marker bulbs

Your vehicle is equipped with LED side marker bulbs. It is designed to last the life of the vehicle. If replacement is required, see your authorized dealer.

Replacing fog lamp bulbs

1. Make sure that the fog lamp switch is in the off position.

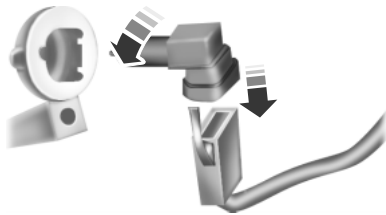

2. From underneath the vehicle, remove the splash shield and rotate the harness/bulb assembly counterclockwise, to remove from the fog lamp.

3. Carefully disconnect the bulb from the harness assembly via the two snap clips.

4. Reverse the procedure to install the new bulb.

Replacing backup lamp bulbs

1. Make sure the headlamp switch is in the off position, then open the liftgate to expose the lamp assembly bolts.

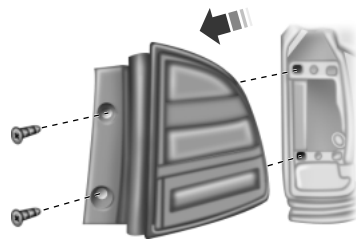

2. Remove the two bolts from the lamp assembly.

3. Carefully remove the lamp assembly away from the vehicle by pulling the assembly straight out to expose the bulb socket.

4. Rotate the bulb socket counterclockwise and remove from lamp assembly.

5. Pull bulb straight out of socket and snap in the new bulb.

6. Install the bulb socket into the lamp assembly and rotate clockwise.

7. Carefully install the tail lamp assembly on the vehicle by securing the lamp assembly with two bolts.

Replacing tail/stop/turn/side marker lamp bulbs

Your vehicle is equipped with a tail/stop/turn/sidemarker lamp assembly containing integral multiple light emitting diodes (LED). See your authorized dealer for the replacement LED module.

Replacing supplemental liftgate lamp assembly

Your vehicle is equipped with a liftgate lamp assembly containing integral multiple light emitting diodes (LED). If one or more LEDs burn out, the complete lamp module has to be replaced. See your authorized dealer for the replacement LED module.

Replacing high-mount brake lamp bulbs

Your vehicle is equipped with an LED center high-mount stop lamp. It is designed to last the life of the vehicle. If replacement is required, see your authorized dealer.

Replacing license plate lamp bulbs

1. Make sure the headlamp switch is in the off position.



2. Remove the two screws and the license plate lamp assembly from the bumper.

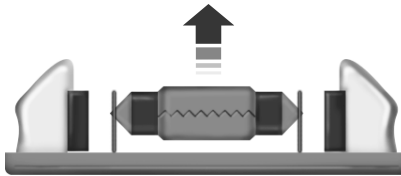

3. Carefully pull the bulb straight out from the lamp assembly.

4. Install new bulb(s) in reverse order.

BULB SPECIFICATION CHART

Replacement bulbs are specified in the chart below. Headlamp bulbs must be marked with an authorized "D.O.T." for North America and an "E" for Europe to ensure lamp performance, light brightness and pattern and safe visibility. The correct bulbs will not damage the lamp assembly or void the lamp assembly warranty and will provide quality bulb burn time.

Function	Number of Bulbs	Trade Number
Headlamp low/high beam (halogen)	2	HIR2
* Headlamp low/high beam (HID)	2	D3S
* Front sidemarker lamp	N/A	LED
Front park/turn signal lamp	2	3457NAK (amber)
* Rear sidemarker lamp	N/A	LED
* Stop/tail/turn lamp	N/A	LED
Backup lamp	2	921
License plate lamp	2	C5W
* High-mount brake lamp	N/A	LED
Fog lamp (if equipped)	2	H11

Function	Number of Bulbs	Trade Number
Front row map lamp	2	1600XB
Second row dome/reading lamp	3	211-2XB
Rear courtesy lamp	1	211-2XB
Visor vanity lamp	2	37
All replacement bulbs are clear in color except where noted.		
To replace all instrument panel lights - see your authorized dealer.		
* To replace these lamps - see your authorized dealer.		

GENERAL INFORMATION

Your Ford or Lincoln authorized dealer has many quality products available to clean your vehicle and protect its finishes.

CLEANING PRODUCTS

For best results, use the following products or products of equivalent quality:

- Motorcraft Bug and Tar Remover (ZC-42)
- Motorcraft Custom Bright Metal Cleaner (ZC-15)
- Motorcraft Detail Wash (ZC-3-A)
- Motorcraft Dusting Cloth (ZC-24)
- Motorcraft Engine Shampoo and Degreaser (United States only) (ZC-20)
- Motorcraft Engine Shampoo (Canada only) (CXC-66-A)
- Motorcraft Multi-Purpose Cleaner (Canada only) (CXC-101)
- Motorcraft Premium Glass Cleaner (Canada only) (CXC-100)
- Motorcraft Premium Quality Windshield Washer Fluid (Canada only) [CXC-37-(A, B, D or F)]
- Motorcraft Premium Windshield Wash Concentrate with Bitterant (United States only) (ZC-32-B2)
- Motorcraft Professional Strength Carpet & Upholstery Cleaner (ZC-54)
- Motorcraft Premium Leather and Vinyl Cleaner (ZC-56)
- Motorcraft Spot and Stain Remover (United States only) (ZC-14)
- Motorcraft Ultra-Clear Spray Glass Cleaner (ZC-23)
- Motorcraft Wheel and Tire Cleaner (ZC-37-A)

CLEANING THE EXTERIOR

Wash your vehicle regularly with cool or lukewarm water and a neutral pH shampoo, such as Motorcraft® Detail Wash.

- Never use strong household detergents or soap, such as dish washing or laundry liquid. These products can discolor and spot painted surfaces.
- Never wash a vehicle that is hot to the touch or during exposure to strong, direct sunlight.
- Dry the vehicle with a chamois or soft terry cloth towel in order to eliminate water spotting.

- Immediately remove items such as gasoline, diesel fuel, bird droppings and insect deposits because they can cause damage to the vehicle's paintwork and trim over time. Use Motorcraft Bug and Tar Remover.
- **Note:** Suntan lotions and insect repellents can damage any painted surface; if these substances come in contact with your vehicle, wash it off as soon as possible.
- Remove any exterior accessories before entering a car wash.

Stripes or Graphics (if equipped)

Do not use a commercial or high-pressure wand on the surface or edge of stripes and graphics. This can cause damage to the film and cause the edge of the film to peel away from the vehicle surface.

Exterior Chrome

Note: Never use abrasive materials such as steel wool or plastic pads as they can scratch the chrome surface.

Note: Do not use chrome cleaner, metal cleaner or polish on wheels and wheel covers.

- Wash the vehicle first, using cool or lukewarm water and a neutral pH shampoo, such as Motorcraft Detail Wash.
- Use Motorcraft Custom Bright Metal Cleaner. Apply the product as you would a wax to clean bumpers and other chrome parts; allow the cleaner to dry for a few minutes, then wipe off the haze with a clean, dry rag.
- Do not apply cleaning product to hot surfaces and do not leave cleaning product on chrome surfaces for a period of time exceeding that which is recommended.
- **Note:** Using other non-recommended cleaners can result in severe and permanent cosmetic damage.

Underbody

Flush the complete underside of your vehicle frequently. Keep body and door drain holes free from packed dirt.

Cleaning Plastic Exterior Parts

Use only approved products to clean plastic parts.

- For routine cleaning, use Motorcraft Detail Wash.
- If tar or grease spots are present, use Motorcraft Bug and Tar Remover.

WAXING

Regular waxing is necessary to protect the paint on your car from the elements. We recommend that you wash and wax the painted surface once or twice a year.

When washing and waxing, park your vehicle in a shaded area out of direct sunlight. Always wash your vehicle before applying wax.

- Use a quality wax that does not contain abrasives.
- Follow the manufacturer's instructions to apply and remove the wax.
- Apply a small amount of wax in a back-and-forth motion, not in circles.
- Do not allow wax to come in contact with any non-body (low-gloss black) colored trim. The wax discolors or stains the parts over time, such as:
 - Bumpers
 - Grained door handles
 - Side mouldings
 - Mirror housings
 - Windshield cowl area.
- Do not apply wax to glass areas.
- After waxing, your car's paint should feel smooth, and be free of streaks and smudges.

REPAIRING MINOR PAINT DAMAGE

Your authorized dealer has touch-up paint to match your vehicle's color. Take your color code (printed on a sticker in the driver's door jamb) to an authorized dealer to make sure you get the correct color.

- Remove particles, such as bird droppings, tree sap, insect deposits, tar spots, road salt and industrial fallout, before repairing paint chips.
- Always read the instructions before using the products.

CLEANING THE ENGINE

Engines are more efficient when they are clean because grease and dirt buildup keep the engine warmer than normal.

When washing:

- Take care when using a power washer to clean the engine. The high-pressure fluid could penetrate the sealed parts and cause damage.
- Do not spray a hot engine with cold water to avoid cracking the engine block or other engine components.

- Spray Motorcraft Engine Shampoo and Degreaser on all parts that require cleaning and pressure rinse clean. In Canada, use Motorcraft Engine Shampoo.
- Never wash or rinse the engine while it is hot or running; water in the running engine may cause internal damage.
- Never wash or rinse any ignition coil, spark plug wire or spark plug well, or the area in and around these locations.
- Cover the battery, power distribution box, and air filter assembly to prevent water damage when cleaning the engine.

CLEANING THE WINDOWS AND WIPER BLADES

The windows and wiper blades should be cleaned regularly. If the wipers do not wipe properly, substances on the vehicle's glass or the wiper blades may cause squeaking or chatter noise from the blades, and streaking and smearing of the windshield. To clean these items, follow these tips:

- The windows may be cleaned with a non-abrasive cleaner such as Motorcraft® Ultra-Clear Spray Glass Cleaner.
- The wiper blades can be cleaned with isopropyl (rubbing) alcohol or Motorcraft Premium Windshield Washer Concentrates in the U.S., or Motorcraft Premium Quality Windshield Washer Fluid in Canada. Replace your wiper blades when they appear worn or do not function properly.
- Do not use abrasive materials, as they may cause scratches.
- Do not use fuel, kerosene, or paint thinner to clean any parts.

If you cannot remove those streaks after cleaning with the glass cleaner or if the wipers chatter and move in a jerky motion, clean the outer surface of the windshield and the wiper blades using a sponge or soft cloth with a neutral detergent or mild-abrasive cleaning solution. After cleaning, rinse the windshield and wiper blades with clean water. The windshield is clean if beads do not form when you rinse the windshield with water.

Note: Do not use sharp objects, such as a razor blade, to clean the inside of the rear window or to remove decals, as it may cause damage to the rear window defroster's heated grid lines.

CLEANING THE INTERIOR

WARNING: Do not use cleaning solvents, bleach or dye on the vehicle's safety belts, as these actions may weaken the belt webbing.



WARNING: On vehicles equipped with seat-mounted airbags, do not use chemical solvents or strong detergents. Such products could contaminate the side airbag system and affect performance of the side airbag in a collision.

For fabric, carpets, cloth seats, safety belts and seats equipped with side airbags:

- Remove dust and loose dirt with a vacuum cleaner.
- Apply a layer of high quality foam cleaner, designed for automotive interiors, to the dry stained area (s) of the item you are cleaning and allow soaking for one minute.
- If grease or tar is present on the material, spot-clean the area first with Motorcraft Spot and Stain Remover. In Canada, use Motorcraft Multi-Purpose Cleaner.
- If a ring forms on the fabric after spot cleaning, clean the entire area immediately (but do not oversaturate) or the ring can set.
- Do not use household cleaning products or glass cleaners, which can stain and discolor the fabric and affect the flame retardant abilities of the seat materials.

CLEANING THE INSTRUMENT PANEL AND INSTRUMENT CLUSTER LENS

WARNING: Do not use chemical solvents or strong detergents when cleaning the steering wheel or instrument panel to avoid contamination of the airbag system.

Note: Follow the same procedure as cleaning leather seats for cleaning leather instrument panels and leather interior trim surfaces. See *Cleaning Leather Seats* in this chapter.

Clean the instrument panel and cluster lens with a clean, damp, white, cotton cloth, then use a clean and dry, white, cotton cloth to dry these areas.

- Avoid cleaners or polishes that increase the gloss of the upper portion of the instrument panel. The dull finish in this area helps protect the driver from undesirable windshield reflection.
- Be certain to wash or wipe your hands clean if you have been in contact with certain products, such as insect repellent and suntan lotion, in order to avoid possible damage to the interior painted surfaces.
- Do not use household or glass cleaners as these may damage the finish of the instrument panel, interior trim and cluster lens.
- Do not allow air fresheners and hand sanitizers to spill on interior surfaces. If a spill occurs, wipe off immediately. Damage may not be covered by your warranty.

If a staining liquid like coffee or juice has been spilled on the instrument panel or on interior trim surfaces, clean as follows:

1. Wipe up spilled liquid using a clean, white, cotton cloth.
2. Use Motorcraft Premium Leather and Vinyl Cleaner or a commercially available leather cleaning product for automotive interiors. Test any cleaner or stain remover on an inconspicuous area.
3. Alternatively, wipe the surface with a damp, clean, white, cotton cloth and a mild soap and water solution. Dry the area with a clean, soft cloth.
4. If necessary, apply more soap and water solution or cleaning product to a clean, white, cotton cloth and press the cloth onto the soiled area. Allow this to set at room temperature for 30 minutes.
5. Remove the soaked cloth, then with a clean, damp cloth, use a rubbing motion for 60 seconds on the soiled area.
6. Following this, wipe area dry with a clean, white, cotton cloth.

CLEANING LEATHER SEATS (IF EQUIPPED)

Note: Follow the same procedure as cleaning leather seats for cleaning leather instrument panels and leather interior trim surfaces.

For routine cleaning, wipe the surface with a soft, damp cloth and a mild soap and water solution. Dry the area with a clean, soft cloth.

For cleaning and removing spots and stains such as dye transfer, use Motorcraft Premium Leather and Vinyl Cleaner or a commercially available leather cleaning product for automotive interiors.

Note: Test any cleaner or stain remover on an inconspicuous area.

You should:

- Remove dust and loose dirt with a vacuum cleaner.
- Clean and treat spills and stains as soon as possible.

Do not use the following products as these may damage the leather:

- Oil and petroleum or silicone-based leather conditioners.
- Household cleaners.
- Alcohol solutions.
- Solvents or cleaners intended specifically for rubber, vinyl and plastics.

CLEANING THE ALLOY WHEELS

Note: Do not use chrome cleaner, metal cleaner or polish on wheels and wheel covers.

A clearcoat paint finish coats aluminum wheels and wheel covers. In order to maintain their condition:

- Clean weekly with Motorcraft Wheel and Tire Cleaner. Use a sponge to remove heavy deposits of dirt and brake dust accumulation. Rinse thoroughly with a strong stream of water when you have completed the cleaning process.
- To remove tar and grease, use Motorcraft Bug and Tar Remover.
- Never apply any cleaning chemical to hot or warm wheel rims or covers.
- Some automatic car washes may cause damage to the finish on your wheel rims or covers.
- Industrial-strength (heavy-duty) cleaners, or cleaning chemicals, in combination with brush agitation to remove brake dust and dirt, could wear away the clearcoat finish over time.
- Do not use hydrofluoric acid-based or high caustic-based wheel cleaners, steel wool, fuels or strong household detergent.
- If you intend on parking your vehicle for an extended period after cleaning the wheels with a wheel cleaner, drive your vehicle for a few minutes before doing so. This reduces the risk of increased corrosion of the brake discs.

VEHICLE STORAGE

If you plan on storing your vehicle for an extended period of time (30 days or more), read the following maintenance recommendations to make sure your vehicle stays in good operating condition.

All motor vehicles and their components were engineered and tested for reliable, regular driving. Long-term storage under various conditions may lead to component degradation or failure unless specific precautions are taken to preserve the components.

General

- Store all vehicles in a dry, ventilated place.
- Protect from sunlight, if possible.
- If vehicles are stored outside, they require regular maintenance to protect against rust and damage.

Body

- Wash vehicle thoroughly to remove dirt, grease, oil, tar or mud from exterior surfaces, rear-wheel housing and underside of front fenders.
- Periodically wash vehicles stored in exposed locations.
- Touch up raw or primed metal to prevent rust.
- Cover chrome and stainless steel parts with a thick coat of auto wax to prevent discoloration. Re-wax as necessary when the vehicle is washed.
- Lubricate hood latch, all door latches and trunk lid hinges with a light grade oil.
- Cover interior trim to prevent fading.
- Keep all rubber parts free from oil and solvents.

Engine

- The engine oil and filter should be changed prior to storage, as used engine oil contains contaminants that may cause engine damage.
- Start the engine every 15 days. Run at fast idle until it reaches normal operating temperature.
- With your foot on the brake, shift through all the gears while the engine is running.

Fuel system

- Fill the fuel tank with high-quality fuel until the first automatic shutoff of the fuel pump nozzle.

Cooling system

- Protect against freezing temperatures.
- When removing vehicle from storage, check coolant fluid level. Confirm there are no cooling system leaks, and fluid is at the recommended level.

Battery

- Check and recharge as necessary. Keep connections clean.
- If storing your vehicle for more than 30 days without recharging the battery, it may be advisable to disconnect the battery cables to ensure battery charge is maintained for quick starting.

Note: If battery cables are disconnected, it will be necessary to reset memory features.

Brakes

- Make sure brakes and parking brake are fully released.

Tires

- Maintain recommended air pressure.

Miscellaneous

- Make sure all linkages, cables, levers and pins under vehicle are covered with grease to prevent rust.
- Move vehicles at least 25 feet (8 meters) every 15 days to lubricate working parts and prevent corrosion.

Removing Vehicle from Storage

When your vehicle is ready to come out of storage, do the following:

- Wash your vehicle to remove any dirt or grease film build-up on window surfaces.
- Check windshield wipers for any deterioration.
- Check under the hood for any foreign material that may have collected during storage (mice/squirrel nests).
- Check the exhaust for any foreign material that may have collected during storage.
- Check tire pressures and set tire inflation per the Tire Label.
- Check brake pedal operation. Drive the vehicle 15 feet (4.5 meters) back and forth to remove rust build-up.
- Check fluid levels (including coolant, oil and gas) to make sure there are no leaks and fluids are at recommended levels.
- If the battery was removed, clean the battery cable ends and inspect.

Contact your authorized dealer if you have any concerns or issues.

GENERAL INFORMATION**Important Information for P265/40R22 Low-profile Tires and Wheels**

If your vehicle is equipped with P265/40R22 tires, they are low-profile tires. These tires and wheels are designed to give your vehicle a sport appearance. With low-profile tires, you may notice an increase in road noise and faster tire wear, depending on road conditions and driving styles. Due to their design, low-profile tires and wheels are more prone to road damage from potholes, rough or unpaved roads, car wash rails and curb contact than standard tires and wheels.

Note: Your vehicle's warranty does not cover these types of damage. Tires should always be kept at the correct inflation pressures and extra caution should be taken when operating on rough roads to avoid impacts that could cause wheel and tire damage.

Notice to Crossover Vehicle Owners

Crossover vehicles handle differently than passenger cars in the various driving conditions that are encountered on streets, highways and off-road. Crossover vehicles are not designed for cornering at speeds as high as passenger cars any more than low-slung sports cars are designed to perform satisfactorily under off-road conditions.



WARNING: Crossover vehicles have a significantly higher rollover rate than other types of vehicles. To reduce the risk of serious injury or death from a rollover or other crash you must:

- Avoid sharp turns and abrupt maneuvers.
- Drive at safe speeds for the conditions.
- Keep tires properly inflated.
- Never overload or improperly load your vehicle.
- Make sure every passenger is properly restrained.



WARNING: In a rollover crash, an unbelted person is significantly more likely to die than a person wearing a safety belt. All occupants must wear safety belts. Children and infants must use appropriate restraints to minimize the risk of injury or ejection.

Study your owner's manual for specific information about equipment features, instructions for safe driving and additional precautions to reduce the risk of an accident or serious injury.

All-Wheel Drive System (If Equipped)



WARNING: Do not become overconfident in the ability of all-wheel drive vehicles. Although an all-wheel drive vehicle may accelerate better than a two-wheel drive vehicle in low-traction situations, it will not stop any faster than two-wheel drive vehicles. Always drive at a safe speed.

Note: Your all-wheel drive vehicle is not intended for off-road use. This feature gives your vehicle some limited off-road capabilities in which driving surfaces are relatively level, obstruction-free and otherwise similar to normal on-road driving conditions. Operating your vehicle under other than those conditions could subject the vehicle to excessive stress which might result in damage which is not covered under your warranty.

With the all-wheel drive option, power will be delivered to the front wheels and distributed to the rear wheels as needed. This increases traction which may enable you to safely drive over terrain and road conditions that a conventional two-wheel drive vehicle cannot. The system is active all the time and requires no input from the operator.

For all-wheel drive vehicles, a spare tire of a different size other than the tire provided should never be used. A dissimilar spare tire size (other than the spare tire provided) or major dissimilar tire sized between the front and rear axles could cause the system to stop functioning and default to front-wheel drive.

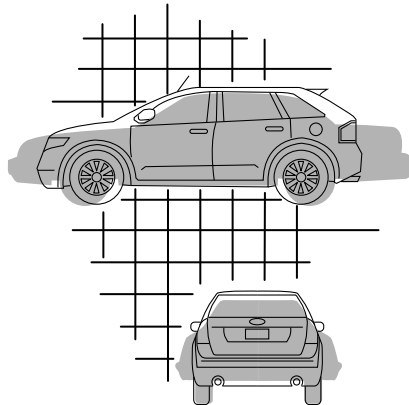
How Your Vehicle Differs from Other Vehicles

Crossover vehicles can differ from some other vehicles in a few noticeable ways. Your vehicle may be:

- Higher – to allow higher load carrying capacity.
- Shorter – to give it the capability to approach inclines. All other things held equal, a shorter wheelbase may make your vehicle quicker to respond to steering inputs than a vehicle with a longer wheelbase.
- Narrower – to provide greater maneuverability in tight spaces.

As a result of the above dimensional differences, crossover vehicles often will have a higher center of gravity and a greater difference in center of gravity between the loaded and unloaded condition.

These differences that make your vehicle so versatile also make it handle differently than an ordinary passenger car.

TIRE CARE**Information About Uniform Tire Quality Grading**

Tire Quality Grades apply to new pneumatic passenger car tires. The Tire Quality Grades can be found where applicable on the tire sidewall between tread shoulder and maximum section width. For example:

- **Treadwear 200 Traction AA Temperature A**

These Tire Quality Grades are determined by standards that the United States Department of Transportation has set.

Tire Quality Grades apply to new pneumatic passenger car tires. They do not apply to deep tread, winter-type snow tires, space-saver or temporary use spare tires, light truck or LT type tires, tires with nominal rim diameters of 10 to 12 inches or limited production tires as defined in Title 49 Code of Federal Regulations Part 575.104(c)(2).

U.S. Department of Transportation-Tire quality grades: The U.S. Department of Transportation requires Ford Motor Company to give you the following information about tire grades exactly as the government has written it.

Treadwear

The treadwear grade is a comparative rating based on the wear rate of the tire when tested under controlled conditions on a specified government test course. For example, a tire graded 150 would wear 1½ times as well on the government course as a tire graded 100. The relative performance of tires depends upon the actual conditions of their use, however, and may depart significantly from the norm due to variations in driving habits, service practices, and differences in road characteristics and climate.

Traction AA A B C



WARNING: The traction grade assigned to this tire is based on straight-ahead braking traction tests, and does not include acceleration, cornering, hydroplaning or peak traction characteristics.

The traction grades, from highest to lowest are AA, A, B, and C. The grades represent the tire's ability to stop on wet pavement as measured under controlled conditions on specified government test surfaces of asphalt and concrete. A tire marked C may have poor traction performance.

Temperature A B C



WARNING: The temperature grade for this tire is established for a tire that is properly inflated and not overloaded. Excessive speed, underinflation, or excessive loading, either separately or in combination, can cause heat buildup and possible tire failure.

The temperature grades are A (the highest), B and C, representing the tire's resistance to the generation of heat and its ability to dissipate heat when tested under controlled conditions on a specified indoor laboratory test wheel. Sustained high temperature can cause the material of the tire

to degenerate and reduce tire life, and excessive temperature can lead to sudden tire failure. The grade C corresponds to a level of performance which all passenger car tires must meet under the Federal Motor Vehicle Safety Standard No. 139. Grades B and A represent higher levels of performance on the laboratory test wheel than the minimum required by law.

Glossary of Tire Terminology

- **Tire label:** A label showing the OE (Original Equipment) tire sizes, recommended inflation pressure and the maximum weight the vehicle can carry.
- **Tire Identification Number (TIN):** A number on the sidewall of each tire providing information about the tire brand and manufacturing plant, tire size and date of manufacture. Also referred to as DOT code.
- **Inflation pressure:** A measure of the amount of air in a tire.
- **Standard load:** A class of P-metric or Metric tires designed to carry a maximum load at set pressure. For example: For P-metric tires 35 psi (2.4 bar) or 36 (2.5 bar) depending on tire size and for Metric tires 36 psi (2.5 bar). Increasing the inflation pressure beyond this pressure will not increase the tire capability.
- **Extra load:** A class of P-metric or Metric tires designed to carry a heavier maximum load at 42 psi (2.9 bar). Increasing the inflation pressure beyond this pressure will not increase the tire's load-carrying capability.
- **kPa:** KiloPascal, a metric unit of air pressure.
- **PSI:** Pounds per square inch, a standard unit of air pressure.
- **Cold tire pressure:** The tire pressure when the vehicle has been stationary and out of direct sunlight for an hour or more and prior to the vehicle being driven for 1 mile (1.6 kilometers).
- **Recommended inflation pressure:** The cold inflation pressure found on the Safety Compliance Certification Label (affixed to either the door hinge pillar, door-latch post, or the door edge that meets the door-latch post, next to the driver's seating position) or Tire Label located on the B-Pillar or the edge of the driver's door.
- **B-pillar:** The structural member at the side of the vehicle behind the front door.
- **Bead area of the tire:** Area of the tire next to the rim.
- **Sidewall of the tire:** Area between the bead area and the tread.

D. **R:** Indicates a radial type tire.

E. **15:** Indicates the wheel or rim diameter in inches. If you change your wheel size, you will have to purchase new tires to match the new wheel diameter.

F. **95:** Indicates the tire's load index. It is an index that relates to how much weight a tire can carry. You may find this information in your owner's manual. If not, contact a local tire dealer.

Note: You may not find this information on all tires because it is not required by federal law.

G. **H:** Indicates the tire's speed rating. The speed rating denotes the speed at which a tire is designed to be driven for extended periods of time under a standard condition of load and inflation pressure. The tires on your vehicle may operate at different conditions for load and inflation pressure. These speed ratings may need to be adjusted for the difference in conditions. The ratings range from 81 mph (130 km/h) to 186 mph (299 km/h). These ratings are listed in the following chart.

Note: You may not find this information on all tires because it is not required by federal law.

Letter rating	Speed rating - mph (km/h)
M	81 (130)
N	87 (140)
Q	99 (159)
R	106 (171)
S	112 (180)
T	118 (190)
U	124 (200)
H	130 (210)
V	149 (240)
W	168 (270)
Y	186 (299)

Note: For tires with a maximum speed capability over 149 mph (240 km/h), tire manufacturers sometimes use the letters ZR. For those with a maximum speed capability over 186 mph (299 km/h), tire manufacturers always use the letters ZR.

H. U.S. DOT Tire Identification Number (TIN): This begins with the letters DOT and indicates that the tire meets all federal standards. The next two numbers or letters are the plant code designating where it was manufactured, the next two are the tire size code and the last four numbers represent the week and year the tire was built. For example, the numbers 317 mean the 31st week of 1997. After 2000 the numbers go to four digits. For example, 2501 means the 25th week of 2001. The numbers in between are identification codes used for traceability. This information is used to contact customers if a tire defect requires a recall.

I. M+S or M/S: Mud and Snow, or

AT: All Terrain, or

AS: All Season.

J. Tire Ply Composition and Material Used: Indicates the number of plies or the number of layers of rubber-coated fabric in the tire tread and sidewall. Tire manufacturers also must indicate the ply materials in the tire and the sidewall, which include steel, nylon, polyester, and others.

K. Maximum Load: Indicates the maximum load in kilograms and pounds that can be carried by the tire. See the Safety Compliance Certification Label (affixed to either the door hinge pillar, door-latch post, or the door edge that meets the door-latch post, next to the driver's seating position), for the correct tire pressure for your vehicle.

L. Treadwear, Traction and Temperature Grades

- **Treadwear:** The treadwear grade is a comparative rating based on the wear rate of the tire when tested under controlled conditions on a specified government test course. For example, a tire graded 150 would wear one and one-half (1½) times as well on the government course as a tire graded 100.
- **Traction:** The traction grades, from highest to lowest, are AA, A, B, and C. The grades represent the tire's ability to stop on wet pavement as measured under controlled conditions on specified government test surfaces of asphalt and concrete. A tire marked C may have poor traction performance.
- **Temperature:** The temperature grades are A (the highest), B and C, representing the tire's resistance to the generation of heat and its ability to dissipate heat when tested under controlled conditions on a specified indoor laboratory test wheel.

M. Maximum Inflation Pressure: Indicates the tire manufacturer's maximum permissible pressure or the pressure at which the maximum load can be carried by the tire. This pressure is normally higher than the vehicle manufacturer's recommended cold inflation pressure, which can be found on the Safety Compliance Certification Label (affixed to either the door hinge pillar, door-latch post, or the door edge that meets the door-latch post, next to the driver's seating position), or Tire Label which is located on the B-Pillar or the edge of the driver's door. The cold inflation pressure should never be set lower than the recommended pressure on the vehicle label.

The tire suppliers may have additional markings, notes or warnings, such as standard load or radial tubeless.

Additional Information Contained on the Tire Sidewall for LT Type Tires

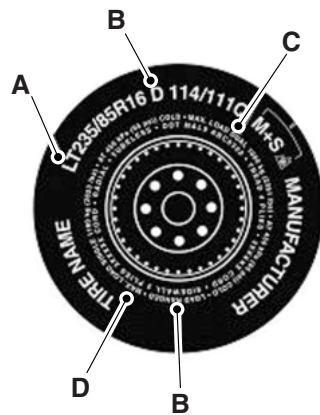

LT type tires have some additional information beyond those of P type tires. These differences are described below.

Note: Tire Quality Grades do not apply to this type of tire.

A. **LT:** Indicates a tire, designated by the Tire and Rim Association, that is intended for service on light trucks.

B. **Load Range/Load Inflation Limits:** Indicates the tire's load-carrying capabilities and its inflation limits.

C. **Maximum Load Dual lb (kg) at psi (kPa) cold:** Indicates the maximum load and tire pressure when the tire is used as a dual, defined as four tires on the rear axle (a total of six or more tires on the vehicle).

D. **Maximum Load Single lb (kg) at psi (kPa) cold:** Indicates the maximum load and tire pressure when the tire is used as a single, defined as two tires (total) on the rear axle.

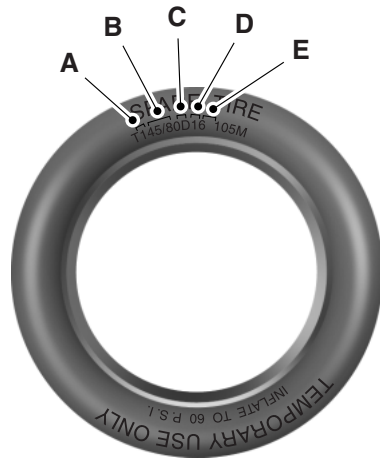
Information on T Type Tires

T type tires have some additional information beyond those of P type tires. These differences are described below.

T145/80D16 is an example of a tire size.

Note: The temporary tire size for your vehicle may be different from this example. Tire Quality Grades do not apply to this type of tire.

A. **T:** Indicates a type of tire, designated by the Tire and Rim Association, that is intended for temporary service on cars, sport-utility vehicles, minivans and light trucks.

B. **145:** Indicates the nominal width of the tire in millimeters from sidewall edge to sidewall edge. In general, the larger the number, the wider the tire.

C. **80:** Indicates the aspect ratio, which gives the tire's ratio of height to width. Numbers of 70 or lower indicate a short sidewall.

D. **D:** Indicates a diagonal type tire. **R:** Indicates a radial type tire.

E. **16:** Indicates the wheel or rim diameter in inches. If you change your wheel size, you will have to purchase new tires to match the new wheel diameter.

Location of the Tire Label

You will find a Tire Label containing tire inflation pressure by tire size and other important information located on the B-Pillar or the edge of the driver's door. See the payload description and graphic in the *Load Carrying* chapter.

INFLATING YOUR TIRES

Safe operation of your vehicle requires that your tires are properly inflated. Remember that a tire can lose up to half of its air pressure without appearing flat.

Every day before you drive, check your tires. If one looks lower than the others, use a tire gauge to check pressure of all tires and adjust if required.

At least once a month and before long trips, inspect each tire and check the tire pressure with a tire gauge (including spare, if equipped). Inflate all tires to the inflation pressure recommended by Ford Motor Company.



WARNING: Under-inflation is the most common cause of tire failures and may result in severe tire cracking, tread separation or blowout, with unexpected loss of vehicle control and increased risk of injury. Under-inflation increases sidewall flexing and rolling resistance, resulting in heat build-up and internal damage to the tire. It also may result in unnecessary tire stress, irregular wear, loss of vehicle control and accidents. A tire can lose up to half of its air pressure and not appear to be flat!

You are strongly urged to buy a reliable tire pressure gauge, as automatic service station gauges may be inaccurate. Ford recommends the use of a digital or dial-type tire pressure gauge rather than a stick-type tire pressure gauge.

Use the recommended cold inflation pressure for optimum tire performance and wear. Under-inflation or over-inflation may cause uneven treadwear patterns.

Always inflate your tires to the Ford recommended inflation pressure even if it is less than the maximum inflation pressure information found on the tire. The Ford recommended tire inflation pressure is found on the Safety Compliance Certification Label (affixed to either the door hinge pillar, door-latch post, or the door edge that meets the door-latch post, next to the driver's seating position), or Tire Label which is located on the B-Pillar or the edge of the driver's door. Failure to follow the tire pressure recommendations can cause uneven treadwear patterns and adversely affect the way your vehicle handles.

Maximum Inflation Pressure is the tire manufacturer's maximum permissible pressure or the pressure at which the maximum load can be carried by the tire. This pressure is normally higher than the manufacturer's recommended cold inflation pressure, which can be found

on the Safety Compliance Certification Label (affixed to either the door hinge pillar, door-latch post, or the door edge that meets the door-latch post, next to the driver's seating position), or Tire Label which is located on the B-Pillar or the edge of the driver's door. The cold inflation pressure should never be set lower than the recommended pressure on the Safety Compliance Certification Label or Tire Label.

When weather temperature changes occur, tire inflation pressures also change. A 10°F (6°C) temperature drop can cause a corresponding drop of 1 psi (7 kPa) in inflation pressure. Check your tire pressures frequently and adjust them to the proper pressure which can be found on the Safety Compliance Certification Label or Tire Label.

To check the pressure in your tire(s):

1. Make sure the tires are cool, meaning they are not hot from driving even a mile.

Note: If you are checking tire pressure when the tire is hot (for example, driven more than 1 mile [1.6 kilometers]), never bleed or reduce air pressure. The tires are hot from driving and it is normal for pressures to increase above recommended cold pressures. A hot tire at or below recommended cold inflation pressure could be significantly under-inflated.

Note: If you have to drive a distance to get air for your tire(s), check and record the tire pressure first and add the appropriate air pressure when you get to the pump. It is normal for tires to heat up and the air pressure inside to go up as you drive.

2. Remove the cap from the valve on one tire, then firmly press the tire gauge onto the valve and measure the pressure.

3. Add enough air to reach the recommended air pressure.

Note: If you overfill the tire, release air by pressing on the metal stem in the center of the valve. Then recheck the pressure with your tire gauge.

4. Replace the valve cap.

5. Repeat this procedure for each tire, including the spare.

Note: Some spare tires operate at a higher inflation pressure than the other tires. For T-type mini-spare tires, see the *Dissimilar Spare Tire and Wheel Assembly Information* section. Store and maintain at 60 psi (4.15 bar). For full-size and dissimilar spare tires, see *Dissimilar Spare Tire and Wheel Assembly Information* under *Changing a Road Wheel* in this chapter. Store and maintain at the higher of the front and rear inflation pressure as shown on the Tire Label.

6. Visually inspect the tires to make sure there are no nails or other objects embedded that could poke a hole in the tire and cause an air leak.
7. Check the sidewalls to make sure there are no gouges, cuts or bulges.

Inspecting Your Tires and Wheel Valve Stems

Periodically inspect the tire treads for uneven or excessive wear and remove objects such as stones, nails or glass that may be wedged in the tread grooves. Check the tire and valve stems for holes, cracks, or cuts that may permit air leakage and repair or replace the tire and replace the valve stem. Inspect the tire sidewalls for cracking, cuts, bruises and other signs of damage or excessive wear. If internal damage to the tire is suspected, have the tire demounted and inspected in case it needs to be repaired or replaced. For your safety, tires that are damaged or show signs of excessive wear should not be used because they are more likely to blow out or fail.

Improper or inadequate vehicle maintenance can cause tires to wear abnormally. Inspect all your tires, including the spare, frequently, and replace them if one or more of the following conditions exist:

Tire Wear

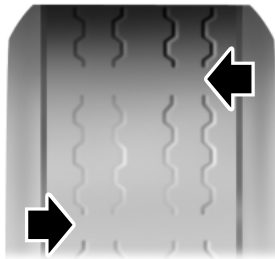

When the tread is worn down to 1/16th of an inch (2 millimeters), tires must be replaced to help prevent your vehicle from skidding and hydroplaning. Built-in treadwear indicators, or wear bars, which look like narrow strips of smooth rubber across the tread will appear on the tire when the tread is worn down to 1/16th of an inch (2 millimeters).

When the tire tread wears down to the same height as these wear bars, the tire is worn out and must be replaced.

Damage

Periodically inspect the tire treads and sidewalls for damage (such as bulges in the tread or sidewalls, cracks in the tread groove and separation in the tread or sidewall). If damage is observed or suspected, have the tire inspected by a tire professional. Tires can be damaged during off-road use, so inspection after off-road use is also recommended.

**WARNING: Age**

Tires degrade over time depending on many factors such as weather, storage conditions, and conditions of use (such as load, speed, inflation pressure) the tires experience throughout their lives.

In general, tires should be replaced after six years regardless of tread wear. However, heat caused by hot climates or frequent high loading conditions can accelerate the aging process and may require tires to be replaced more frequently.

You should replace your spare tire when you replace the road tires or after six years due to aging even if it has not been used.

U.S. DOT Tire Identification Number

Both U.S. and Canada Federal regulations require tire manufacturers to place standardized information on the sidewall of all tires. This information identifies and describes the fundamental characteristics of the tire and also provides a U.S. DOT Tire Identification Number for safety standard certification and in case of a recall.

This begins with the letters DOT and indicates that the tire meets all federal standards. The next two numbers or letters are the plant code designating where it was manufactured, the next two are the tire size code and the last four numbers represent the week and year the tire was built. For example, the numbers 317 mean the 31st week of 1997. After 2000 the numbers go to four digits. For example, 2501 means the 25th week of 2001. The numbers in between are identification codes used for traceability. This information is used to contact customers if a tire defect requires a recall.

Tire Replacement Requirements

WARNING: Only use replacement tires and wheels that are the same size, load index, speed rating and type (such as P-metric versus LT-metric or all-season versus all-terrain) as those originally provided by Ford. The recommended tire and wheel size may be found on either the Safety Compliance Certification Label (affixed to either the door hinge pillar, door-latch post, or the door edge that meets the door-latch post, next to the driver's seating position), or the Tire Label which is located on the B-Pillar or edge of the driver's door. If this information is not found on these labels, then you should contact your authorized dealer as soon as possible. Use of any tire or wheel not recommended by Ford can affect the safety and performance of your vehicle, which could result in an increased risk of loss of vehicle control, vehicle rollover, personal injury and death. Additionally the use of non-recommended tires and wheels could cause steering, suspension, axle, transfer case or power transfer unit failure. If you have questions regarding tire replacement, contact your authorized dealer as soon as possible.



WARNING: To reduce the risk of serious injury, when mounting replacement tires and wheels, you should not exceed the maximum pressure indicated on the sidewall of the tire to set the beads without additional precautions listed below. If the beads do not seat at the maximum pressure indicated, re-lubricate and try again. When inflating the tire for mounting pressures up to 20 psi (1.38 bar) greater than the maximum pressure on the tire sidewall, the following precautions must be taken to protect the person mounting the tire:

1. Make sure that you have the correct tire and wheel size.
2. Lubricate the tire bead and wheel bead seat area again.
3. Stand at a minimum of 12 feet (3.66 meters) away from the tire wheel assembly.
4. Use both eye and ear protection.

For a mounting pressure more than 20 psi (1.38 bar) greater than the maximum pressure, a Ford dealer or other tire service professional should do the mounting.

Always inflate steel carcass tires with a remote air fill with the person inflating standing at a minimum of 12 feet (3.66 meters) away from the tire wheel assembly.

Your vehicle is equipped with tires designed to provide a safe ride and handling capability.

Important: Remember to replace the wheel valve stems when the road tires are replaced on your vehicle.

The two front tires or two rear tires should generally be replaced as a pair.

The tire pressure sensors mounted in the wheels (originally installed on your vehicle) are not designed to be used in aftermarket wheels.

The use of wheels or tires not recommended by Ford Motor Company may affect the operation of your tire pressure monitoring system.

If the tire pressure monitoring system indicator is flashing, the system is malfunctioning. Your replacement tire might be incompatible with your tire pressure monitoring system, or some component of the system may be damaged.

Safety Practices

WARNING: If your vehicle is stuck in snow, mud, or sand, do not rapidly spin the tires. Spinning the tires can tear the tire and cause an explosion. A tire can explode in as little as three to five seconds.



WARNING: Do not spin the wheels at over 35 mph (56 km/h). The tires may fail and injure a passenger or bystander.

Driving habits have a great deal to do with your tire mileage and safety.

- Observe posted speed limits.
- Avoid fast starts, stops and turns.
- Avoid potholes and objects on the road.
- Do not run over curbs or hit the tire against a curb when parking.

Highway Hazards

No matter how carefully you drive, there is always the possibility that you may eventually have a flat tire on the highway. Drive slowly to the closest safe area out of traffic. This may further damage the flat tire, but your safety is more important.

If you feel a sudden vibration or ride disturbance while driving, or you suspect your tire or vehicle has been damaged, immediately reduce your speed. Drive with caution until you can safely pull off the road. Stop and inspect the tires for damage. If a tire is under-inflated or damaged, deflate it, remove the wheel and replace it with your spare tire and wheel. If you cannot detect a cause, have the vehicle towed to the nearest repair facility or tire dealer to have the vehicle inspected.

Tire and Wheel Alignment

A bad jolt from hitting a curb or pothole can cause the front end of your vehicle to become misaligned or cause damage to your tires. If your vehicle seems to pull to one side when you are driving, the wheels may be out of alignment. Have an authorized dealer check the wheel alignment periodically.

Wheel misalignment in the front or the rear can cause uneven and rapid treadwear of your tires and should be corrected by an authorized dealer. Front-wheel drive vehicles and those with an independent rear suspension may require alignment of all four wheels.

The tires should also be balanced periodically. An unbalanced tire and wheel assembly may result in irregular tire wear.

Tire Rotation

Note: If your tires show uneven wear ask an authorized dealer to check for and correct any wheel misalignment, tire imbalance or mechanical problem involved before tire rotation.

Note: Your vehicle may be equipped with a dissimilar spare tire and wheel assembly. A dissimilar spare tire and wheel assembly is defined as a spare tire or wheel that is different in brand, size or appearance from the road tires and wheels. If you have a dissimilar spare tire and wheel assembly, it is intended for temporary use only and should not be used in a tire rotation.

Note: After having your tires rotated, inflation pressure must be checked and adjusted to the vehicle requirements.

Rotating your tires at the recommended interval (as indicated in the scheduled maintenance information) will help your tires wear more evenly, providing better tire performance and longer tire life.

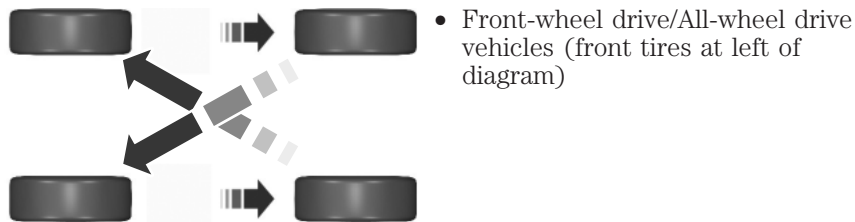

Sometimes irregular tire wear can be corrected by rotating the tires.

USING SNOW CHAINS



WARNING: Snow tires must be the same size, load index, speed rating as those originally provided by Ford. Use of any tire or wheel not recommended by Ford can affect the safety and performance of your vehicle, which could result in an increased risk of loss of vehicle control, vehicle rollover, personal injury and death. Additionally, the use of non-recommended tires and wheels could cause steering, suspension, axle, transfer case or power transfer unit failure.

Note: The suspension insulation and bumpers will help prevent vehicle damage. Do not remove these components from your vehicle when using snow tires and chains.

The tires on your vehicle have all-weather treads to provide traction in rain and snow. However, in some climates, you may need to use snow tires and chains.

Follow these guidelines when using snow tires and cable chains:

- If possible, avoid fully loading your vehicle.
- Use only SAE Class S cables or equivalent.
- Use SAE Class S cables only on the front axle on vehicles equipped with P245/60R18 tires.
- Do not use tire cables or optional traction devices with P245/50R20 or P265/40R22 tires.
- Install cables securely, verifying that the cables do not touch any wiring, brake lines or fuel lines.
- Drive cautiously. If you hear the cable chains rub or bang against your vehicle, stop and retighten the cables. If this does not work, remove the cables to prevent damage to your vehicle.
- Do not exceed 30 mph (48 km/h) with tire cables on your vehicle.
- Remove the tire cables when they are no longer needed. Do not use tire cables on dry roads.

TIRE PRESSURE MONITORING SYSTEM



WARNING: The tire pressure monitoring system is NOT a substitute for manually checking tire pressure. The tire pressure should be checked periodically (at least monthly) using a tire gauge. See *Inflating Your Tires* in this chapter. Failure to properly maintain your tire pressure could increase the risk of tire failure, loss of control, vehicle rollover and personal injury.



Each tire, including the spare (if provided), should be checked monthly when cold and inflated to the inflation pressure recommended by the vehicle manufacturer on the vehicle placard or tire inflation pressure label. (If your vehicle has tires of a different size than the size indicated on the vehicle placard or tire inflation pressure label, you should determine the proper tire inflation pressure for those tires.)

As an added safety feature, your vehicle has been equipped with a tire pressure monitoring system (TPMS) that illuminates a low tire pressure telltale when one or more of your tires is significantly under-inflated. Accordingly, when the low tire pressure telltale illuminates, you should stop and check your tires as soon as possible, and inflate them to the proper pressure. Driving on a significantly under-inflated tire causes the tire to overheat and can lead to tire failure. Under-inflation also reduces fuel efficiency and tire tread life, and may affect the vehicle's handling and stopping ability.

Please note that the TPMS is not a substitute for proper tire maintenance, and it is the driver's responsibility to maintain correct tire pressure, even if under-inflation has not reached the level to trigger illumination of the TPMS low tire pressure telltale.

Your vehicle has also been equipped with a TPMS malfunction indicator to indicate when the system is not operating properly. The TPMS malfunction indicator is combined with the low tire pressure telltale. When the system detects a malfunction, the telltale will flash for approximately one minute and then remain continuously illuminated. This sequence will continue upon subsequent vehicle start-ups as long as the malfunction exists.

When the malfunction indicator is illuminated, the system may not be able to detect or signal low tire pressure as intended. TPMS malfunctions may occur for a variety of reasons, including the installation of replacement or alternate tires or wheels on the vehicle that prevent the TPMS from functioning properly. Always check the TPMS malfunction telltale after replacing one or more tires or wheels on your vehicle to ensure that the replacement or alternate tires and wheels allow the TPMS to continue to function properly.

The tire pressure monitoring system complies with part 15 of the FCC rules and with RSS-210 of Industry Canada. Operation is subject to the following two conditions: (1) This device may not cause harmful interference, and (2) This device must accept any interference received, including interference that may cause undesired operation.

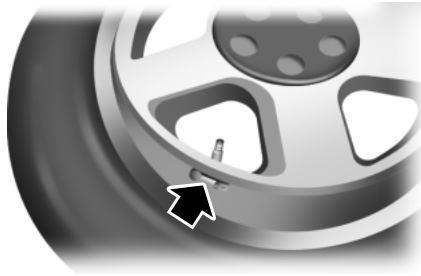
Changing Tires with a Tire Pressure Monitoring System

Note: Each road tire is equipped with a tire pressure sensor located inside the tire and wheel assembly cavity. The pressure sensor is attached to the valve stem. The pressure sensor is covered by the tire and is not visible unless the tire is removed. Take care when changing the tire to avoid damaging the sensor.

You should always have your tires serviced by an authorized dealer.

Check the tire pressure periodically (at least monthly) using an accurate tire gauge. See *Inflating Your Tires* in this chapter.

Understanding Your Tire Pressure Monitoring System

The tire pressure monitoring system measures pressure in your four road tires and sends the tire pressure readings to your vehicle. The low tire pressure warning light will turn on if the tire pressure is significantly low. Once the light is illuminated, your tires are under-inflated and need to be inflated to the manufacturer's recommended tire pressure. Even if the light turns on and a short time later turns off, your tire pressure still needs to be checked.

When Your Temporary Spare Tire Is Installed

When one of your road tires needs to be replaced with the temporary spare, the system will continue to identify an issue to remind you that the damaged road wheel and tire assembly needs to be repaired and put back on your vehicle.

To restore the full function of the tire pressure monitoring system, have the damaged road wheel and tire assembly repaired and remounted on your vehicle.

When You Believe Your System Is Not Operating Properly

The main function of the tire pressure monitoring system is to warn you when your tires need air. It can also warn you in the event the system is no longer capable of functioning as intended. See the following chart for information concerning your tire pressure monitoring system:

Low tire pressure warning light	Possible cause	Customer action required
Solid warning light	Tire(s) under-inflated	1. Make sure tires are at the proper pressure. See <i>Inflating Your Tires</i> in this chapter. 2. After inflating your tires to the manufacturer's recommended pressure as shown on the Tire Label (located on the edge of driver's door or the B-Pillar), the vehicle must be driven for at least two minutes over 20 mph (32 km/h) before the light turns off.
	Spare tire in use	Repair the damaged road wheel and tire and reinstall it on the vehicle to restore system function. For a description on how the system functions, see <i>When Your Temporary Spare Tire is Installed</i> in this section.
	TPMS malfunction	If the tires are properly inflated and the spare tire is not in use but the light remains on, contact your authorized dealer as soon as possible.
Flashing warning light	Spare tire in use	Repair the damaged road wheel and tire assembly and reinstall it on the vehicle to restore system function. For a description on how the system functions, see <i>When Your Temporary Spare Tire is Installed</i> in this section.
	TPMS malfunction	If the tires are properly inflated and the spare tire is not in use but the light remains on, contact your authorized dealer as soon as possible.

When Inflating Your Tires

When putting air into your tires (such as at a gas station or in your garage), the tire pressure monitoring system may not respond immediately to the air added to your tires.

It may take up to two minutes of driving over 20 mph (32 km/h) for the light to turn off after you have filled your tires to the recommended inflation pressure.

How Temperature Affects Your Tire Pressure

The tire pressure monitoring system monitors tire pressure in each pneumatic tire. While driving in a normal manner, a typical passenger tire inflation pressure may increase about 2 to 4 psi (14 to 28 kPa) from a cold start situation. If the vehicle is stationary overnight with the outside temperature significantly lower than the daytime temperature, the tire pressure may decrease approximately 3 psi (21 kPa) for a drop of 30°F (17°C) in ambient temperature. This lower pressure value may be detected by the tire pressure monitoring system as being significantly lower than the recommended inflation pressure and activate the system warning light for low tire pressure. If the low tire pressure warning light is on, visually check each tire to verify that no tire is flat. If one or more tires are flat, repair as necessary. Check the air pressure in the road tires. If any tire is under-inflated, carefully drive the vehicle to the nearest location where air can be added to the tires. Inflate all the tires to the recommended inflation pressure.

CHANGING A ROAD WHEEL

WARNING: The use of tire sealant may damage your tire pressure monitoring system and should only be used in roadside emergencies. If you must use a sealant, the Ford Tire Mobility Kit sealant should be used. The tire pressure monitoring system sensor and valve stem on the wheel must be replaced by an authorized dealer after use of the sealant.



WARNING: See *Tire Pressure Monitoring System* in this chapter for important information. If the tire pressure monitoring sensor becomes damaged, it will no longer function.

Note: The tire pressure monitoring system indicator light will illuminate when the spare tire is in use. To restore the full function of the monitoring system, all road wheels equipped with tire pressure monitoring sensors must be mounted on this vehicle.

If you get a flat tire while driving, do not apply the brake heavily. Instead, gradually decrease your speed. Hold the steering wheel firmly and slowly move to a safe place on the side of the road.

Have a flat serviced by an authorized dealer in order to prevent damage to the system sensors. See *Tire Pressure Monitoring System* earlier in this chapter. Replace the spare tire with a road tire as soon as possible. During repairing or replacing of the flat tire, have the authorized dealer inspect the tire pressure monitoring system sensor for damage.

Dissimilar Spare Tire and Wheel Assembly Information



WARNING: Failure to follow these guidelines could result in an increased risk of loss of vehicle control, injury or death.

If you have a dissimilar spare tire and wheel assembly, then it is intended for temporary use only. This means that if you need to use it, you should replace it as soon as possible with a road tire and wheel assembly that is the same size and type as the road tires and wheels that were originally provided by Ford. If the dissimilar spare tire or wheel is damaged, it should be replaced rather than repaired.

A dissimilar spare tire and wheel assembly is defined as a spare tire or wheel that is different in brand, size or appearance from the road tires and wheels and can be one of three types:

1. **T-type mini-spare:** This spare tire begins with the letter T for tire size and may have Temporary Use Only molded in the sidewall.
2. **Full-size dissimilar spare with label on wheel:** This spare tire has a label on the wheel that states: THIS TIRE AND WHEEL FOR TEMPORARY USE ONLY

When driving with one of the dissimilar spare tires listed above, do not:

- exceed 50 mph (80 km/h).
- load the vehicle beyond maximum vehicle load rating listed on the Safety Compliance Label.
- tow a trailer.
- use snow chains on the end of the vehicle with the dissimilar spare tire.
- use more than one dissimilar spare tire at a time.
- use commercial car washing equipment.
- try to repair the dissimilar spare tire.

Use of one of the dissimilar spare tires listed above at any one wheel location can lead to impairment of the following:

- Handling, stability and braking performance
- Comfort and noise
- Ground clearance and parking at curbs
- Winter weather driving capability
- Wet weather driving capability
- All-wheel driving capability

3. **Full-size dissimilar spare without label on wheel**

When driving with the full-size dissimilar spare tire and wheel assembly, do not:

- exceed 70 mph (113 km/h).
- use more than one dissimilar spare tire and wheel at a time.
- use commercial car washing equipment.
- use snow chains on the end of the vehicle with the dissimilar spare tire and wheel.

The usage of a full-size dissimilar spare tire and wheel assembly can lead to impairment of the following:

- Handling, stability and braking performance
- Comfort and noise
- Ground clearance and parking at curbs
- Winter weather driving capability
- Wet weather driving capability
- All-wheel driving capability (if applicable)
- Load leveling adjustment (if applicable)

When driving with the full-size dissimilar spare tire and wheel assembly, additional caution should be given to:

- towing a trailer.
- driving vehicles equipped with a camper body.
- driving vehicles with a load on the cargo rack.

Drive cautiously when using a full-size dissimilar spare tire and wheel, and seek service as soon as possible.

Tire Change Procedure

 **WARNING:** When one of the front wheels is off the ground, the transmission alone will not prevent the vehicle from moving or slipping off the jack, even if the transmission is in park (P).

 **WARNING:** To help prevent the vehicle from moving when you change a tire, be sure to place the transmission in park (P), set the parking brake and block (in both directions) the wheel that is diagonally opposite (other side and end of the vehicle) to the tire being changed.

 **WARNING:** Never get underneath a vehicle that is supported only by a jack. If the vehicle slips off the jack, you or someone else could be seriously injured.

 **WARNING:** Do not attempt to change a tire on the side of the vehicle close to moving traffic. Pull far enough off the road to avoid the danger of being hit when operating the jack or changing the wheel.

 **WARNING:** Always use the jack provided as original equipment with your vehicle. If using a jack other than the one provided as original equipment with your vehicle, make sure the jack capacity is adequate for the vehicle weight, including any vehicle cargo or modifications.

Note: Passengers should not remain in the vehicle when the vehicle is being jacked.

1. Park on a level surface, set the parking brake and activate the hazard flashers.
2. Place the transmission in park (P) and turn the engine off.



3. Lift the carpeted load floor panel located in the rear of the vehicle.

4. Remove the spare tire cover and foam spacer (if equipped).

5. Remove the wing nut securing the spare tire by turning it counterclockwise.

6. Remove the washer, temporary spare and jack assembly from the cargo area

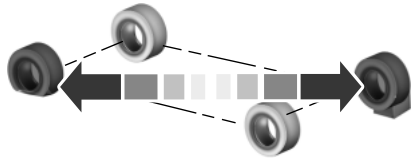

7. Block the diagonally opposite wheel.

8. Loosen each wheel lug nut one-half turn counterclockwise but do not remove them until the wheel is raised off the ground.

9. The vehicle jacking points are shown here, and are depicted on the yellow warning label on the jack.

Note: Jack at the specified locations to avoid damage to the vehicle.



10. Small arrow-shaped marks on the sills show the location of the jacking points.

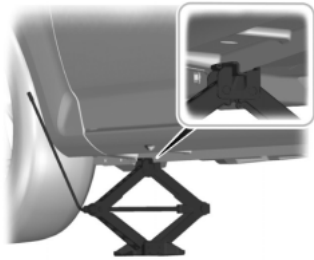

11. Remove the lug nuts with the lug wrench.
12. Replace the flat tire with the spare tire, making sure the valve stem is facing outward. Reinstall the lug nuts until the wheel is snug against the hub. Do not fully tighten the lug nuts until the wheel has been lowered.
13. Lower the wheel by turning the jack handle counterclockwise.

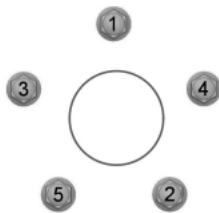

14. Remove the jack and fully tighten the lug nuts in the order shown. See *Wheel Lug Nut Torque Specifications* later in this chapter for the proper lug nut torque specification.

Stowing the Flat/Spare Tire and Jack

Note: If you are stowing a flat 22 inch tire and wheel assembly, temporarily remove the load floor, plastic stowage bins, and the foam load floor supports to make space. Place the 22 inch tire and wheel assembly in the spare tire well with the valve stem facing down. Rotate the tire until the jack assembly is able to protrude through a wheel opening. Replace the plastic stowage bins and foam load floor supports around the 22 inch tire and wheel assembly.

Note: If you are stowing a flat tire, place the tire in the spare tire well with the valve stem facing down. Rotate the tire until the jack assembly is able to protrude through a wheel opening.

Note: If you are stowing the spare tire, place the spare in the spare tire well in its original position.

1. Put the flat tire, jack and lug wrench away. Make sure the jack kit is secured in its original location and orientation in the jack kit recess under the flat or spare tire. Unblock the wheels.
2. Secure the wheel by replacing the washer and the wing nut and turning the wing nut clockwise.

TECHNICAL SPECIFICATIONS

Wheel Lug Nut Torque Specifications



WARNING: When a wheel is installed, always remove any corrosion, dirt or foreign materials present on the mounting surfaces of the wheel or the surface of the wheel hub, brake drum or brake disc that contacts the wheel. Make sure that any fasteners that attach the rotor to the hub are secured so they do not interfere with the mounting surfaces of the wheel. Installing wheels without correct metal-to-metal contact at the wheel mounting surfaces can cause the wheel nuts to loosen and the wheel to come off while your vehicle is in motion, resulting in loss of control.

Retighten the lug nuts to the specified torque within 100 miles (160 kilometers) after any wheel disturbance (such as rotation, flat tire, wheel removal).

Lug nut socket size/Bolt size	Wheel lug nut torque*	
	ft-lb	N•m
½ x 20	100	135

* Torque specifications are for nut and bolt threads free of dirt and rust. Use only Ford recommended replacement fasteners.



Note: Inspect the wheel pilot hole and mounting surface prior to installation. Remove any visible corrosion or loose particles.

ENGINE SPECIFICATIONS

Engine	3.7L V6 engine
Cubic inches	227
Required fuel	Minimum 87 octane
Firing order	1-4-2-5-3-6
Ignition system	Coil on plug
Compression ratio	10.5:1
Spark plug gap	0.049-0.053 inch (1.25-1.35 mm)

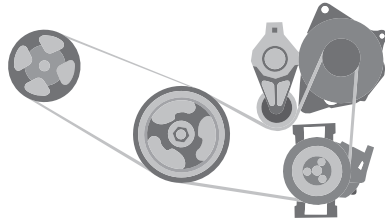
Engine drivebelt routing

1. Short drivebelt is on first pulley groove closest to engine.
2. Long drivebelt is on second pulley groove farthest from engine.

TECHNICAL SPECIFICATIONS

Item	Capacity	Ford part name	Ford part number / Ford specification
Brake fluid ¹	Between MIN and MAX on reservoir	Motorcraft High Performance DOT 4 LV Motor Vehicle Brake Fluid	PM-20 / WSS-M6C65-A2
Door weatherstrips	—	Silicone Spray Lubricant	XL-6 / ESR-M13P4-A
Hinges, latches, striker plates and rotors, seat tracks, fuel filler door hinge and spring	—	Multi-Purpose Grease (Lithium grease)	Motorcraft XL-5 (aerosol) or CRC SL3151ESB / ESB-M1C93-B
Lock cylinders	—	Motorcraft Penetrating and Lock Lubricant	XL-1 / None
Engine oil ^{2,3}	3.7L engine 6.0 quarts (5.7L)	Motorcraft SAE 5W-20 Motor Oil	WSS-M2C945-A
Engine coolant ^{4,5,6}	3.7L engine 11.7 quarts (11.1L) ^{4,5}	Motorcraft Orange Antifreeze/Coolant Prediluted	VC-3DIL-B (US) CVC-3DIL-B (Canada) / WSS-M97B44-D2
Power steering fluid	Between MIN and MAX on reservoir	Motorcraft MERCON LV ATF	XT-10-QLV / MERCON LV
Automatic transmission fluid ^{7,8}	11.0 quarts (10.4L) (6F50)	Motorcraft MERCON LV ATF	XT-10-QLV / MERCON LV
Rear differential (All-Wheel Drive) fluid	2.4 pints (1.15L)	Motorcraft SAE 80W-90 Premium Rear Axle Lubricant	XY-80W90-QL / WSP-M2C197-A

Item	Capacity	Ford part name	Ford part number / Ford specification
Power Transfer Unit (PTU) fluid (All-Wheel Drive) ⁹	12 ounces (0.35L)	Motorcraft SAE 75W-140 Synthetic Rear Axle Lubricant	XY-75W140-QL / WSL-M2C192-A
Windshield washer fluid	Fill as required	Motorcraft Premium Windshield Washer Concentrates (US) Premium Quality Windshield Washer Fluid (Canada)	ZC-32-A (US); CXC-37-(A, B, D, and F) (Canada) / WSB-M8B16-A2/-
Fuel tank (front-wheel drive)	18.3 gallons (69.3L)	—	—
Fuel tank (all-wheel drive)	19.2 gallons (72.7L)	—	—
Air conditioning refrigerant ¹⁰	1.27 lb (0.58kg)	Motorcraft R-134a Refrigerant	YN-19 (US) / CYN-16- R (Canada) / WSH-M17B19-A
Air conditioning compressor oil ¹⁰	4.0 fl oz (118.3ml)	Motorcraft PAG Refrigerant Compressor Oil	YN-12-D / WSH-M1C231-B

¹Ford recommends using Motorcraft (Ford) DOT 4 LV High Performance Brake Fluid or equivalent meeting WSS-M6C65-A2 . Use of any fluid other than the recommended fluid may cause degraded brake performance and not meet the Ford performance standards. Keep brake fluid clean and dry. Contamination with dirt, water, petroleum products or other materials may result in brake system damage and possible failure.

Item	Capacity	Ford part name	Ford part number / Ford specification
<p>²We have designed your engine to use Motorcraft motor oils or equivalent oil brands that meet our specifications. Motor oils of the recommended viscosity grade that meet API SN requirements and display the API Certification Mark for gasoline engines are also acceptable. Do not use API S category oils labeled as SN, SM, SL or lower category unless the label also display the API certification mark. These oils do not meet all of the requirements of your vehicles engine and emission system.</p>			
<p>³Do not use supplemental engine oil additives in your engine. They are unnecessary and could lead to engine damage that is not covered by your Ford warranty.</p>			
<p>⁴Add the coolant type originally equipped in your vehicle.</p>			
<p>⁵Indicates only approximate dry fill capacity. Some applications may vary.</p>			
<p>⁶Engine coolant with trailer tow package - 11.9 quarts (11.3L)</p>			
<p>⁷Indicates only approximate dry-fill capacity. Some applications may vary based on cooler size and if equipped with an in-tank cooler. The amount of transmission fluid and fluid level should be set by the indication on the dipstick's normal operating range.</p>			
<p>⁸Use of any fluid other than the recommended fluid may cause transmission damage. Refer to <i>scheduled maintenance information</i> to determine the correct service interval.</p>			
<p>⁹See your authorized dealer for fluid level checking or filling.</p>			
<p>¹⁰Warning: The air conditioning refrigerant system contains refrigerant R-134a under high pressure. Opening the air conditioning refrigerant system can cause personal injury. Only qualified personnel should service the air conditioning refrigerant system.</p>			

Motorcraft part numbers

Component	3.7L V6 engine
Air filter element	FA-1884
Battery	BXT-65-650
Oil filter	FL-500-S
Spark plugs	SP-520 ¹
Cabin air filter	FP65
Seat air filter	FS-104
Windshield wiper blade	WW-2601-PF (driver side) WW-2001-PF (passenger side) WW-1401-PF (rear)

¹ Refer to *scheduled maintenance information* for the appropriate intervals for changing the spark plugs.

Note: Replace the spark plugs with ones that meet Ford material and design specifications for your vehicle, such as Motorcraft® or equivalent replacement parts. The customer warranty may be void for any damage to the engine if such spark plugs are not used.

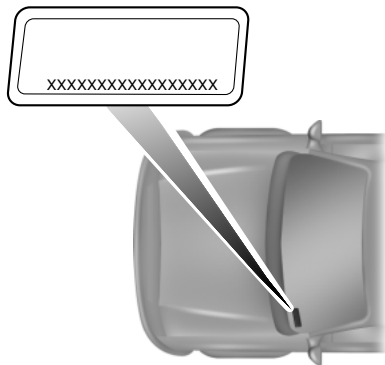
VEHICLE IDENTIFICATION NUMBER

The vehicle identification number is located on the driver's side instrument panel.

Please note that in the graphic, XXXX is representative of your vehicle identification number.

The Vehicle Identification Number (VIN) contains the following information:

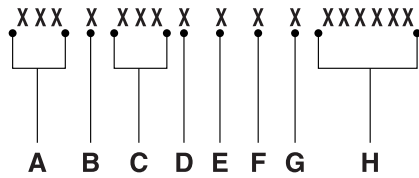

- A. World manufacturer identifier
- B. Brake system / Gross Vehicle Weight Rating (GVWR) / Restraint Devices and their location
- C. Make, vehicle line, series, body type
- D. Engine type
- E. Check digit
- F. Model year

- G. Assembly plant
- H. Production sequence number.

VEHICLE CERTIFICATION LABEL

MFD. BY FORD MOTOR CO.

DATE: XX/XX GVWR: XXXX KG (XXXX LB)

FRONT GAWR: REAR GAWR:

XXXX KG (XXXX LB) WITH XXXX KG (XXXX LB) WITH

XXXXXXXXXXXXXXXXX TIRES XXXXXXXXXXXXXXXXXXXX TIRES

XXXXXXX RIMS XXXXXXXX RIMS

AT XXXX kPa/ XXX PSI COLD AT XXXX kPa/ XXX PSI COLD

THIS VEHICLE CONFORMS TO ALL APPLICABLE FEDERAL MOTOR
VEHICLE SAFETY AND THEFT PREVENTION STANDARDS IN
EFFECT ON THE DATE OF MANUFACTURE SHOWN ABOVE.

VIN: XXXXXXXXXXXXXXXXXXXX XXXXX
TYPE: XXXX XXXXX

EXT PNT: XX XXXXXX IRC: XX DSO: XXXX

WB INT TR TP/PS R AXLE TR SPR XXXX

XXX XX XXX X XX X XXXX XXXX

XXXXXXXXXXXXXXXXX XXX XXXX-XXXXXX-XX

The National Highway Traffic Safety Administration Regulations require that a Safety Compliance Certification Label be affixed to a vehicle and prescribe where the Safety Compliance Certification Label may be located. The Safety Compliance Certification Label shall be affixed to either the door hinge pillar, the door latch post, or the edge of the door near the door latch, next to the driver's seating position.

TRANSMISSION CODE DESIGNATION

MFD. BY FORD MOTOR CO.

DATE: XX/XX GVWR: XXXX KG (XXXX LB)
 FRONT GVWR: XXXX KG (XXXX LB) WITH REAR GVWR: XXXX KG (XXXX LB) WITH
 XXXXXXXXXXXXXXXXXX TIRES XXXXXXXXXXXXXXXXXX TIRES
 XXXXXXX RIMS XXXXXXX RIMS
 AT XXXX kPa/ XXX PSI COLD AT XXXX kPa/ XXX PSI COLD

THIS VEHICLE CONFORMS TO ALL APPLICABLE FEDERAL MOTOR VEHICLE SAFETY AND THEFT PREVENTION STANDARDS IN EFFECT ON THE DATE OF MANUFACTURE SHOWN ABOVE.

VIN: XXXXXXXXXXXXXXXXXX XXXXX
 TYPE: XXXX XXXXX



EXT PNT: XX XXXXXX I RC: XX DSO: XXXX
 WB INT TR TP/PS R AXLE TR SPR XXXX
 XXX XX XXX X XX X XXXX XXXX
 XXXXXXXXXXXXXXXXXX XX XXXX-XXXXXXXX-XX

You can find a transmission code on the Safety Compliance Certification Label. The following table tells you which transmission each code represents.

Description	Code
6-speed automatic transmission (6F50)	J

ACCESSORIES

For a complete listing of the accessories that are available for your vehicle, please contact an authorized dealer or visit our online store at: www.Accessories.Lincoln.com (United States only).

Lincoln Motor Company will repair or replace any properly authorized dealer-installed Lincoln Genuine Accessory found to be defective in factory-supplied materials or workmanship during the warranty period, as well as any component damaged by the defective accessories.

Lincoln Motor Company will warrant your accessory through the warranty that provides the greatest benefit:

- 24 months, unlimited mileage.
- The remainder of your new vehicle limited warranty.

Contact an authorized dealer for details and a copy of the warranty.

Exterior style

- Side window deflectors
- Splash guards

Interior style

- Ambient lighting
- Sport pedals
- Floor mats
- Rear seat entertainment*

Lifestyle

- Ash cup / coin holder
- Cross bars and roof rails
- Trailer hitches, wiring harnesses and accessories
- Cargo organization and management
- Roof rack and carriers*
- SUV camping tent*

Peace of mind

- Vehicle security
- Locking fuel plug
- Cargo security shade

- Cargo area protector
- Bumper protector
- Wheel locks
- Hitch-mounted parking sensors*
- Car cover*

*The accessory manufacturer designs, develops and therefore warrants Lincoln Licensed Accessories, and does not design or test these accessories to Lincoln Motor Company engineering requirements. Contact an authorized Lincoln dealer for the manufacturer's limited warranty details, and request a copy of the Lincoln Licensed Accessories product limited warranty from the accessory manufacturer.

For maximum vehicle performance, keep the following information in mind when adding accessories or equipment to your vehicle:

- When adding accessories, equipment, passengers and luggage to your vehicle, do not exceed the total weight capacity of the vehicle or of the front or rear axle (GVWR or GAWR as indicated on the Safety Compliance Certification label). Ask an authorized dealer for specific weight information.
- The Federal Communications Commission (FCC) and Canadian Radio Telecommunications Commission (CRTC) regulate the use of mobile communications systems that are equipped with radio transmitters, for example, two-way radios, telephones and theft alarms. Any such equipment installed in your vehicle should comply with Federal Communications Commission (FCC) and Canadian Radio Telecommunications Commission (CRTC) regulations and should be installed only by an authorized dealer.
- An authorized dealer needs to install mobile communications systems. Improper installation may harm the operation of your vehicle, particularly if their manufacturer did not design the mobile communication device specifically for automotive use.
- If you or an authorized Lincoln dealer add any non-Lincoln electrical or electronic accessories or components to the vehicle, you may adversely affect battery performance and durability. In addition, you may adversely affect the performance of other electrical systems in the vehicle.

Extended Service Plan (ESP)

PROTECT YOURSELF FROM THE RISING COST OF VEHICLE REPAIRS WITH A LINCOLN EXTENDED SERVICE PLAN.

SERVICE PLANS (U.S. Only)

Lincoln owners have discovered the powerful protection of Lincoln Extended Service Plan. It is the only extended service plan backed by Lincoln Motor Company, and provides peace of mind protection beyond the New Vehicle Limited Warranty coverage.

Lincoln ESP Can Quickly Pay for Itself

One service bill – the cost of parts and labor – can easily exceed the price of your Lincoln Extended Service Plan. With Lincoln ESP, you minimize your risk for unexpected repair bills and rising repair costs.

Up to 1000+ Covered Vehicle Components

There are four Extended Service Plans with different levels of coverage. Ask your authorized dealer for details.

1. PremiumCARE - Our most comprehensive coverage. With over 1000 covered components, this plan is so complete that we generally only discuss what's not covered.
2. ExtraCARE - Covers 113 components, and includes many high-tech items.
3. BaseCARE - Covers 84 components.
4. PowertrainCARE - Covers 29 critical components.

Lincoln Extended Service Plan is honored by all authorized Lincoln and Ford dealers in the U.S. and Canada. It is the only extended service plan authorized and backed by Lincoln Motor Company.

That means you get:

- Reliable, quality service at any Lincoln or Ford dealership.
- Repairs performed by factory trained technicians, using genuine parts.

Rental Car Reimbursement*1st Day Rental Benefit*

You take advantage of replacement transportation if your vehicle is at your authorized dealer for same day covered repairs.

Extended Rental Benefits

If your vehicle is kept overnight for covered repairs, you are eligible for rental car coverage, including bumper to bumper warranty repairs, and Field Service Actions.

Roadside Assistance

Exclusive 24/7 roadside assistance, including:

- Towing, flat-tire change and battery jump starts.
- Out of fuel and lock-out assistance.
- Travel expense reimbursement for lodging, meals and rental car.
- Destination assistance for taxi, shuttle, rental car coverage and emergency transportation.

Transferable Coverage

If you sell your vehicle before your Lincoln Extended Service Plan coverage expires, you can transfer any remaining coverage to the new owner. Whenever you sell your vehicle, prospective buyers may have a higher degree of confidence that vehicle was properly maintained with Lincoln ESP, thereby improving resale value.

Avoid the Rising Cost of Properly Maintaining Your Vehicle!

Lincoln Extended Service Plan also offers a Premium Maintenance Plan that covers all scheduled maintenance, and select items that routinely wear out. The coverage is prepaid, so you never have to worry about affording your vehicle maintenance. It covers regular checkups, routine inspections, preventive care and replacement of select items that require periodic attention for normal wear:

- Windshield wiper blades.
- Spark plugs (except in California).
- The clutch disc.
- Brake pads and linings.
- Shock absorbers.
- Belts and hoses.
- Diesel exhaust fluid replenishment.

Interest Free Finance Options Available

Take advantage of our interest free installment payment plan. Just a 10% down payment will provide you with an affordable, no interest, no fee payment program allowing you all the security and benefits Lincoln ESP has to offer while paying over time. You are pre-approved with no credit checks, no hassles! To learn more, call our Lincoln ESP specialists at 800-367-3377.

Lincoln ESP
P.O. Box 8072
Royal Oak, MI 48068-0039

SERVICE PLANS (CANADA ONLY)

You can get more protection for your vehicle by purchasing a Lincoln Extended Service Plan. Lincoln Extended Service Plan is the only service contract backed by Lincoln Motor Company of Canada, Limited.

Depending on the plan you purchase, Lincoln Extended Service Plan provides benefits such as:

- Rental reimbursement.
- Coverage for certain maintenance and wear items.
- Protection against repair costs after your New Vehicle Limited Warranty Coverage expires.
- Roadside Assistance benefits.

There are several Lincoln Extended Service Plans available in various time, distance and deductible combinations. Each plan is tailored to fit your own driving needs, including reimbursement for towing and rental. When you purchase Lincoln Extended Service Plan, you receive added peace-of-mind protection throughout Canada and the United States, provided by a network of participating authorized Lincoln Motor Company dealers.

Note: *Repairs performed outside of Canada and the United States are not eligible for Lincoln Extended Service Plan coverage.*

This information is subject to change. For more information, visit your local Lincoln of Canada dealer or www.lincoln.ca to find the Lincoln Extended Service Plan that is right for you.

GENERAL INFORMATION**Radio Frequencies and Reception Factors**

AM and FM frequencies are established by the Federal Communications Commission (FCC) and the Canadian Radio and Telecommunications Commission (CRTC). Those frequencies are:

AM: 530, 540–1700, 1710 kHz

FM: 87.9–107.7, 107.9 MHz

Radio reception factors	
Distance and strength	The further you travel from an FM station, the weaker the signal and the weaker the reception.
Terrain	Hills, mountains, tall buildings, bridges, tunnels, freeway overpasses, parking garages, dense tree foliage and thunderstorms can interfere with the reception.
Station overload	When you pass a ground-based broadcast repeating tower, a stronger signal may overtake a weaker one and result in the audio system muting.

CD and CD Player Information

Note: CD units play commercially pressed 4.75-inch (12 centimeter) audio compact discs only. Due to technical incompatibility, certain recordable and re-recordable compact discs may not function correctly when used in Ford CD players.

Note: Do not insert CDs with homemade paper (adhesive) labels into the CD player as the label may peel and cause the CD to become jammed. You should use a permanent felt tip marker rather than adhesive labels on your homemade CDs. Ballpoint pens may damage CDs. Please contact your authorized dealer for further information.

Note: Do not use any irregularly shaped discs or discs with a scratch protection film attached.

Always handle discs by their edges only. Clean the disc with an approved CD cleaner only. Wipe it from the center of the disc toward the edge. Do not clean in a circular motion.

Do not expose discs to direct sunlight or heat sources for extended periods.

MP3 Track and Folder Structure

Audio systems capable of recognizing and playing MP3 individual tracks and folder structures work as follows:

- There are two different modes for MP3 disc playback: MP3 track mode (system default) and MP3 folder mode.
- MP3 track mode ignores any folder structure on the MP3 disc. The player numbers each MP3 track on the disc (noted by the .mp3 file extension) from T001 to a maximum of T255. **Note:** The maximum number of playable MP3 files may be less depending on the structure of the CD and exact model of radio present.
- MP3 folder mode represents a folder structure consisting of one level of folders. The CD player numbers all MP3 tracks on the disc (noted by the .mp3 file extension) and all folders containing MP3 files, from F001 (folder) T001 (track) to F253 T255.
- Creating discs with only one level of folders helps with navigation through the disc files.

If you are burning your own MP3 discs, it is important to understand how the system reads the structures you create. While various files may be present, (files with extensions other than mp3), only files with the .mp3 extension are played; other files are ignored by the system. This enables you to use the same MP3 disc for a variety of tasks on your work computer, home computer and your in-vehicle system.

In track mode, the system displays and plays the structure as if it were only one level deep (all .mp3 files play, regardless of being in a specific folder). In folder mode, the system only plays the .mp3 files in the current folder.

AM/FM/CD PREMIUM AUDIO SYSTEM

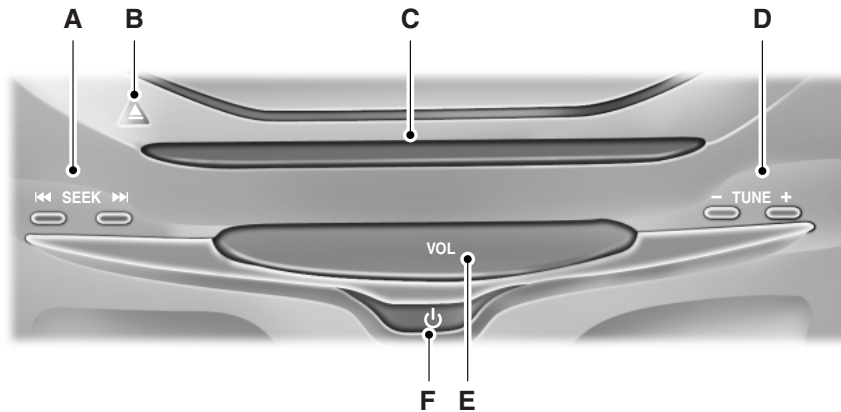

WARNING: Driving while distracted can result in loss of vehicle control, crash and injury. We strongly recommend that you use extreme caution when using any device that may take your focus off the road. Your primary responsibility is the safe operation of your vehicle. We recommend against the use of any hand-held device while driving and encourage the use of voice-operated systems when possible. Make sure you are aware of all applicable local laws that may affect the use of electronic devices while driving.

Note: The MyLincoln Touch system controls most of the audio features. See the *MyLincoln Touch* chapter for more information.

A. SEEK, Reverse and Fast Forward:

- In radio mode, select a frequency band and press one of these buttons. The system stops at the first station it finds in that direction.
- In Sirius mode, press these buttons to select the previous or next channel. If a specific category is selected (such as Jazz, Rock or News), use these buttons to find the previous or next channel in the selected category.
- In CD mode, press these buttons to select the previous or next track.

B. Eject: Press this button to eject a CD.

C. CD Slot: Insert a CD.

D. TUNE + and TUNE - :

- In radio mode, press these buttons to manually search through the radio frequency band.
- In Sirius mode, press these buttons to find the next or previous available satellite radio station.

E. Volume: You can either press or tap the right or left side of the slider, or slide your finger across the control, to adjust the volume.

F. Power: Press this button to switch the system off and on.

MEDIA HUB

The media hub is located behind a small access door in the instrument panel and has the following features:

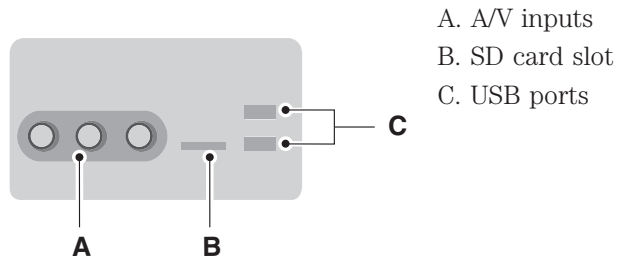

For more information, see the *MyLincoln Touch* chapter.

GENERAL INFORMATION

WARNING: Driving while distracted can result in loss of vehicle control, crash and injury. We strongly recommend that you use extreme caution when using any device that may take your focus off the road. Your primary responsibility is the safe operation of your vehicle. We recommend against the use of any hand-held device while driving and encourage the use of voice-operated systems when possible. Make sure you are aware of all applicable local laws that may affect the use of electronic devices while driving.

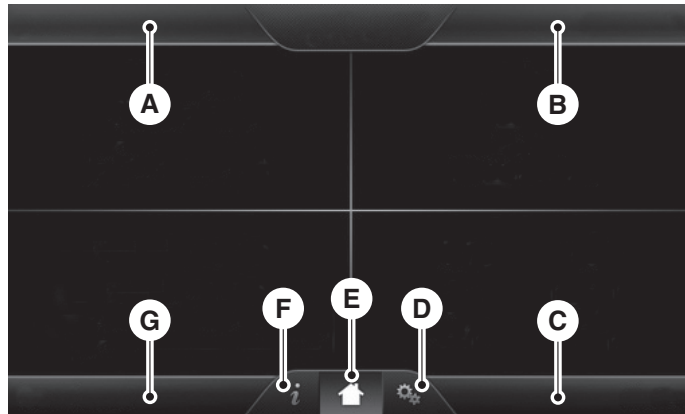

- A. Phone
- B. Navigation (or Information if your vehicle is not equipped with Navigation)
- C. Climate
- D. Settings
- E. Home
- F. Information
- G. Entertainment

This system uses a four-corner strategy to provide quick access several vehicle features and settings. The touchscreen provides easy interaction with your cellular phone, multimedia, climate control and navigation system. The corners display any active modes within those menus, such as phone status or the climate temperature.

Note: Some features are not available while your vehicle is moving.

Note: Your system is equipped with a feature that allows you to access and control audio features for 30 minutes after you switch the ignition off (and no doors open).

PHONE

Press to select any of the following:

- Making and Receiving Calls
- Quick Dial
- Phonebook
- Call History
- Text Messaging
- Settings

NAVIGATION

Press to select any of the following:

- My Home
- Favorites
- Previous Destinations
- Point of Interest
- Emergency
- Street Address
- Intersection
- City Center
- Map
- Edit Route
- Cancel Route

CLIMATE

Press to select any of the following:

- Driver Settings
- Recirculated Air
- Auto
- Dual
- Passenger Settings
- A/C
- Defrost

**SETTINGS**

Press to select any of the following:

- Clock
- Display
- Sound
- Vehicle
- Settings
- Help

**HOME**

Press to access your home screen. Depending on your vehicle's option package and software, your screens may vary in appearance from the descriptions in this section. Your features may also be limited depending on your market. Check with your authorized dealer for availability.

**INFORMATION**

Press to select any of the following:

- SYNC Services
- Sirius Travel Link
- Alerts
- Calendar
- SYNC Apps

If the icon is yellow, see *Alerts* in the *Information* section of this chapter.

ENTERTAINMENT

Press to select any of the following:

- AM
- FM
- SIRIUS
- CD
- USB
- BT Stereo
- SD Card
- A/V In

Using the Touch-sensitive Controls on Your System

To turn a feature on and off, just touch the graphic with your finger. To get the best performance from the touch-sensitive controls, keep in mind:

- Do not press hard on the controls. They are sensitive to light touch.
- Use your bare finger to touch the center of a touch-control graphic. Touching off-center of the graphic may affect operation of a nearby control.
- Make sure your hands are clean and dry.
- Keep metal and other conductive material away from the surface of the touchscreen as this may cause electronic interference (for example, inadvertently turning on a feature other than the one you meant to turn on).

Depending on your vehicle and option package, you may also have these controls on your bezel:

- **Power:** Switch the media or climate features off and on.
- **VOL** and fan slider bars: Slide your finger over the rear slider area to control the volume of playing media or the climate system fan.
- **Seek and Tune buttons:** Use as you normally would in media modes.
- **Eject:** Eject a CD from the entertainment system.
- **SOURCE:** Touch the word repeatedly to see all available media modes. The screen does not change, but you see the media change in the lower left status bar.
- **SOUND:** Touch the word to access the Sound menu where you can adjust settings such as: Bass, Treble, Midrange, Balance and Fade, THX Deep note Demo, DSP (Digital Signal Processing), Occupancy Mode and Speed Compensated Volume. (Your vehicle may not have all of these sound options.)
- **Hazard flasher:** Switch the hazard flashers off and on.

Cleaning the Touchscreen Display

Use a clean, soft cloth such as one used for cleaning glasses. If dirt or fingerprints are still visible, apply a small amount of alcohol to the cloth. Do not pour or spray alcohol onto the display. Do not use detergent or any type of solvent to clean the display.

Support

The SYNC support team is available to help you with any questions you cannot answer on your own.

Monday-Saturday, 8:30am-9:00pm EST.

Sunday, 10:30am-7:30pm EST.

In the United States, call: 1-800-392-3673.

In Canada, call: 1-800-565-3673.

Times are subject to change due to holidays.

Safety Information

WARNING: Driving while distracted can result in loss of vehicle control, crash and injury. We strongly recommend that you use extreme caution when using any device that may take your focus off the road. Your primary responsibility is the safe operation of your vehicle. We recommend against the use of any handheld device while driving and encourage the use of voice-operated systems when possible. Make sure you are aware of all applicable local laws that may affect the use of electronic devices while driving.

When using SYNC:

- Do not operate playing devices if the power cords or cables are broken, split or damaged. Place cords and cables out of the way, so they do not interfere with the operation of pedals, seats, compartments or safe driving abilities.
- Do not leave playing devices in your vehicle during extreme conditions as it could cause them damage. See your device's manual for further information.
- Do not attempt to service or repair the system. See your authorized dealer.

For your safety, some SYNC functions are speed-dependent. Their use is limited to when your vehicle is traveling at speeds under 3 mph (5 km/h).

Make sure that you review your device's manual before using it with SYNC.

Speed-restricted Features

Some features of this system may be too difficult to use while your vehicle is moving so they are restricted from use unless your vehicle is stationary.

- Screens that are too crowded with information, such as Point of Interest reviews and ratings, Sirius Travel Link sports scores, movie times and ski conditions.
- Any action that requires you to use a keyboard is restricted, such as entering a navigation destination or editing information.
- All lists are limited so the user can view fewer entries (such as phone contacts or recent phone call entries).

See the following chart for more specific examples:

Restricted Features	
Cellular Phone	Pairing a Bluetooth phone
	Adding phonebook contacts or uploading phonebook contacts (from a USB)
	List entries are limited for phone contacts and recent phone call entries
System Functionality	Editing the keypad code
	Enabling Valet Mode
	Editing settings while the rear view camera or Active Park Assist are active
Wi-Fi and Wireless	Editing wireless settings
	Editing the list of wireless networks
Videos, Photos and Graphics	Playing video
	Editing the screen's wallpaper or adding new wallpaper
Text Messages	Composing text messages
	Viewing received text messages
	Editing preset text messages
Navigation	Using the keyboard to enter a destination
	Demo navigation route
	Adding or Editing Address Book entries or Avoid Areas

Privacy Information

When a cellular phone is connected to SYNC, the system creates a profile within your vehicle that is linked to that cellular phone. This profile is created in order to offer you more cellular features and to operate more efficiently. Among other things, this profile may contain data about your cellular phone book, text messages (read and unread), and call history, including history of calls when your cell phone was not connected to the system. In addition, if you connect a media device, the system creates and retains an index of supported media content. The system also records a short development log of approximately 10 minutes of all recent system activity. The log profile and other system data may be used to improve the system and help diagnose any problems that may occur.

The cellular profile, media device index, and development log remain in the vehicle unless you delete them and are generally accessible only in the vehicle when the cellular phone or media player is connected. If you no longer plan to use the system or the vehicle, we recommend you perform a Master Reset to erase all stored information.

System data cannot be accessed without special equipment and access to the vehicle's SYNC module. Ford Motor Company and Ford of Canada do not access the system data for any purpose other than as described absent consent, a court order, or where required by law enforcement, other government authorities, or other third parties acting with lawful authority. Other parties may seek to access the information independently of Ford Motor Company and Ford of Canada. For further privacy information, see the sections on 911 Assist, Vehicle Health Report, and Traffic, Directions and Information.

ACCESSING AND ADJUSTING MODES THROUGH YOUR RIGHT VEHICLE INFORMATION DISPLAY

The display is located on the right side of your instrument cluster. You can use your steering wheel controls to view and make minor adjustments to active modes without taking your hands off the wheel. For example:

- In Entertainment mode, you can view what is now playing, change the audio source (such as AM, FM and CD) and scroll through memory presets.
- In Phone mode, you can accept or reject an incoming call, or make a call by choosing from select menus within the Phone menu.
- If your vehicle is equipped with Navigation, you can view the current route or cancel a route.

Note: If your vehicle is not equipped with Navigation, Compass appears in the display instead of Navigation. If you press the right arrow to go into the Compass menu, you can see the compass graphic. The compass displays the direction in which the vehicle is traveling, not true direction. (For example, if the vehicle is traveling west, the middle of the compass graphic displays west; north displays to the left of west though its true direction is to the right of west).

Audio Sources and Memory Presets

Use the **OK** and arrow buttons on the right side of your steering wheel to scroll through the available modes.

You can make selections from the menu by using the **OK** button. The selection menu expands and different options appear.

- Press **OK** to enter the mode.
- Press the left or right arrows to make adjustments within the chosen mode. Small white arrows appear in the menu you are in which indicate that you can scroll in those directions to enter more menus.
- Press **OK** to confirm your selection.

Pressing the up and down arrow buttons in the current source screen allows you to move through that source's presets.

USING VOICE RECOGNITION

This system helps you control many features using voice commands. This allows you to keep your hands on the wheel and focus on what is in front of you. The system provides feedback through audible tones, prompts, questions and spoken confirmations depending on the situation and the chosen level of interaction (voice settings).

The system also asks short questions (confirmation prompts) when it is not sure of your request or when there are multiple possible responses to your request.

When using voice commands, words and icons may appear in the lower left status bar indicating the status of the voice session (such as Listening, Success, Failed, Paused or Try Again).

How to Use Voice Commands with Your System

Press the voice icon. After the tone, speak your command clearly.

These commands can be said at any time.
“Cancel”
“Exit”
“Go back”
“List of commands”
“Main menu”
“Next page”
“Previous page”
“What can I say?”
“Help”

What Can I Say?

To access the available voice commands for the current session, do one of the following:

- During a voice session, press the Help icon (?) in the lower left status bar of the screen.
- Say, “What can I say?” for an on-screen listing of the possible voice commands associated with your current voice session.
- Press the voice icon. After the tone, say, “Help” to hear a list of possible voice commands.

Helpful Hints

- Make sure the interior of your vehicle is as quiet as possible. Wind noise from open windows and road vibrations may prevent the system from correctly recognizing spoken commands.
- After pressing the voice icon, wait until after the tone sounds and Listening appears before saying a command. Any command spoken prior to this does not register with the system.
- Speak naturally, without long pauses between words.
- At any time, you can interrupt the system while it is speaking by pressing the voice icon.

Accessing a List of Available Commands

- If you use the touchscreen, press the Settings icon > **Help** > **Voice Command List**.
- If you use the steering wheel control, press the voice icon. After the tone, speak your command clearly.

Voice command list
“Audio list of commands”
“Bluetooth audio list of commands”
“Browse list of commands”
“CD list of commands”
“Climate control list of commands”
“List of commands”
“Navigation list of commands”*
“Phone list of commands”
“Radio list of commands”
“SD card list of commands”
“Sirius satellite list of commands”**
“Travel link list of commands”*
“USB list of commands”
“Voice instructions list of commands”
“Voice settings list of commands”
“Help”

*This command is only available when your vehicle is equipped with the navigation system, and the navigation system SD card is in the card slot.

**This command is only available when you have an active Sirius satellite radio subscription.

Voice Settings

Voice settings allow you to customize the level of system interaction, help and feedback. The system defaults to standard interaction that uses candidate lists and confirmation prompts as these provide the highest level of guidance and feedback.

Interaction Mode: Novice mode provides detailed interaction and guidance while the advanced mode has less audible interaction and more tone prompts.

Confirmation Prompts: The system uses these short questions to confirm your voice request. If turned off, the system simply makes a best guess as to what you requested. The system may still occasionally ask you to confirm settings.

Phone/Media Candidate Lists: Candidate lists are lists of possible results from your voice commands. The system creates these lists when it has the same confidence level of several options based on your voice command.

To access these settings using the touchscreen:

1. Press the Settings icon > **Settings** > **Voice Control**.
2. Select from:
 - Interaction Mode
 - Confirmation Prompts
 - Media Candidate Lists
 - Phone Candidate Lists
 - Voice Control Volume.

To access these settings using voice commands:



Press the voice icon. Wait for the prompt “Please say a command”. Another tone sounds to let you know the system is listening.

Voice settings using voice commands
“Interaction Mode Novice”
“Interaction Mode Advanced”
“Confirmation Prompts On”
“Confirmation Prompts Off”
“Phone Candidate Lists On”
“Phone Candidate Lists Off”
“Media Candidate Lists On”
“Media Candidate Lists Off”
“Help”

Using Voice Commands with the Touchscreen Options

Your voice system has a dual mode feature which allows you to switch between using voice commands and making on-screen selections. This is available only when the system displays a list of candidates generated during a voice session. For example, when entering in a street address or trying to call a contact from the phone you paired to the system.

ENTERTAINMENT



A. AM 1 and AM AST

B. FM 1, FM 2 and FM AST

C. SIRIUS

D. CD

E. USB

F. Touch this button to scroll down for more options, such as:

- SD Card
- BT Stereo
- A/V In

G. These buttons change with the media mode you are in.

H. Radio memory presets and CD controls.

Note: Some features may not be available in your area. Contact an authorized dealer for more information.

You can access these options using the touchscreen or voice commands.

Browsing Device Content

When listening to audio on a device, you can browse through other devices without having to change sources. For example, if you are currently listening to audio on an SD card, you can browse all the artists that are stored on your USB device.



Press the voice icon on the steering wheel. When prompted, you can say:

“BROWSE” within devices
“Browse”*
“Browse <league> games”**
“Browse <Sirius category> channels”**
“Browse Sirius channel guide”**
“Browse SD card”
“Browse USB”
“Help”

*If you have said “Browse”, you can then say any commands in the following chart.

**This command is only usable if you have an active subscription to Sirius satellite radio.

“BROWSE”
“<League> games”*
“<Sirius category> channels”*
“SD card”**
“Sirius channel guide”*
“USB”**
“Help”

*This command is only usable if you have an active subscription to Sirius satellite radio.

**For more commands in SD card or USB mode, see the “SD card and USB Port” section of this chapter.

For a complete list of “Browse” voice commands, see *USB and SD card voice commands* and *Bluetooth audio voice commands* in the following sections.

Your voice system allows you to change audio sources with a simple voice command. For example, if you are listening to music on a USB device, then want to switch to a satellite radio channel, simply press the voice button on the steering wheel controls and say the name of the Sirius station (such as, “the Highway”). The following voice commands are available at the top level of the voice session no matter which current audio source you are listening to (such as a USB device or Sirius

satellite radio). **Note:** This is only available when your MyFord Touch system language is set to North American English.

“AM <530 - 1710>”	“FM <87.9 – 107.9>”
“<530 - 1710>”	“<87.9 – 107.9>”
“Sirius <0-223>”*	“<Channel name>”**
“Play [genre] <name>”**	“Play [playlist] <name>”**
“Play [artist] <name>”**	“Play [song] <name>”**
“Play [album] <name>”**	“Play <name (song or album)> by <artist name>”
“Play <name>”	“Sports games”*

*This command is only usable if you have an active subscription to Sirius satellite radio.

**The commands that have [] around the word means that the word is optional. For example, if you say, “Play Metallica”, this is the same as the voice command, “Play [artist] <name>”.

AM and FM



Touch the **AM** or **FM** tab to listen to the radio.

To change between AM and FM presets, just touch the **AM** or **FM** tab.

Memory Presets

Save a station by pressing and holding one of the memory preset areas. There is a brief mute while the radio saves the station. Sound returns when finished.

HD Radio

Touch this button to turn HD Radio on. The light on the button illuminates when the feature is on. HD Radio allows you to receive radio broadcasts digitally, where available, providing free, crystal-clear sound. See *HD Radio information* later in this chapter.

Scan

Touch this button to go to the next strong AM or FM radio station. The light on the button illuminates when the feature is on.

Options

Sound Settings allows you to adjust settings for:

- Bass
- Midrange
- Treble
- Balance and Fade
- DSP (Digital Signal Processing)
- Occupancy Mode
- Speed Compensated Volume.

Note: Your vehicle may not have all these sound settings.

Set PTY for Seek/Scan allows you to select a category of music you would like to search for. You can then choose to either seek or scan for the stations playing that category.

RDS Text Display allows you to view the information broadcast by FM stations.

AST allows you to have the system automatically store the six strongest stations in your current location.

TAG Button is available when HD Radio is on, and allows you to tag a song to download later. When you select **On**, TAG appears on-screen when HD Radio is active. You can touch **TAG** to save the information of the song that is playing. When you plug in your portable music player, the information transfers, if supported by your device. When you are connected to iTunes, the tags appear to remind you of the songs you would like to download. See *HD Radio information* later in this chapter.

Direct Tune

Touch this button to manually enter the desired station number. Touch **Enter** when you are done.

HD Radio™ Information (If Available)

Note: HD Radio broadcasts are not available in all markets.

HD Radio technology is the digital evolution of analog AM/FM radio. Your system has a special receiver that allows it to receive digital broadcasts (where available) in addition to the analog broadcasts, it already receives. Digital broadcasts provide a better sound quality than analog broadcasts with free, crystal-clear audio and no static or distortion. For more information, and a guide to available stations and programming, please visit www.hdradio.com.

When HD Radio is on and you tune to a station broadcasting HD Radio technology, you may notice the following indicators on your screen:



HD) logo is grey when acquiring a digital station, and then changes to orange when digital audio is playing. When this logo is available, you may also see Title and Artist fields on-screen.

Multicast indicator appears in FM mode (only) if the current station is broadcasting multiple digital broadcasts. The highlighted numbers signify available digital channels where new or different content is available. HD1 signifies the main programming status and is available in analog and digital broadcasts. Other multicast stations (HD2 through HD7) are only available digitally.

TAG allows you to save a song to download later when you are on an acquired HD Radio station and the feature is on. To turn the feature on and use it:

1. Press **AM** or **FM** > **Options** > **TAG** button > **On**.
2. When you hear a song you like, touch **TAG**.
3. The system automatically saves the song's information and transfers it to your portable music player (if supported) when you connect it to the system. The system automatically transfers the tag to your player (if already connected) and a pop-up confirms the transfer.
4. When you access iTunes with your portable music player, the tags appear to you as a reminder. The system allows you to tag up to approximately 100 songs. For a list of devices that support tagging, see www.SYNCMYride.com, www.SYNCMYride.ca or www.syncmaroute.ca.

When HD Radio broadcasts are active, you can access the following functions:

- **Scan** allows you to hear a brief sampling of all available stations. This feature still works when HD Radio reception is on, although it does not scan for HD2-HD7 channels. You may see the HD logo appear if the station has a digital broadcast.
- **Memory presets** allow you to save an active channel as a memory preset. Touch and hold a memory preset slot until the sound returns. There is a brief mute while the radio saves the station. Sound returns when finished. When switching to an HD2 or HD3 memory preset, the sound mutes before the digital audio plays, because the system has to reacquire the digital signal.
 - **Note:** As with any saved radio station, you cannot access the saved station if your vehicle is outside the station's reception area.

HD Radio Reception and Station Troubleshooting

Potential Reception Issues	
Reception area	<p>If you are listening to a multicast station and you are on the fringe of the reception area, the station may mute due to weak signal strength.</p> <p>If you are listening to HD1, the system switches back to the analog broadcast until the digital broadcast is available again. However, if you are listening to any of the possible HD2 through HD7 multicast channels, the station mutes and stays muted unless it is able to connect to the digital signal again.</p>
Station blending	<p>When the system first receives a station (aside from HD2-HD7 multicast stations), it first plays the station in the analog version. Once the receiver verifies the station is an HD Radio station, it shifts to the digital version. Depending on the station quality, you may hear a slight sound change when the station changes from analog to digital. Blending is the shift from analog to digital sound or digital back to analog sound.</p>

In order to provide the best possible experience, use the contact form to report any station issues found while listening to a station broadcasting with HD Radio technology. Independent entities own and operate each station. These stations are responsible for making sure all audio streams and data fields are accurate.

Potential station issues		
Issue	Cause	Action
Echo, stutter, skip or repeat in audio. Increase or decrease in audio volume.	This is poor time alignment by the radio broadcaster.	No action required. This is a broadcast issue.

Potential station issues		
Issue	Cause	Action
Sound fading or blending in and out.	The radio is shifting between analog and digital audio.	No action required. The reception issue may clear up as you continue to drive.
There is an audio mute delay when selecting HD2 or HD3, multicast preset or Direct Tune .	The digital multicast is not available until the HD Radio broadcast is decoded. Once decoded, the audio is available.	No action required. This is normal behavior. Wait until the audio is available.
Cannot access HD2 or HD3 multicast channel when recalling a preset or from a direct tune.	The previously stored multicast preset or direct tune is not available in your current reception area.	No action required. The station is not available in your current location.
Text information does not match currently playing audio.	Data service issue by the radio broadcaster.	Fill out the station issue form at website listed below.*
There is no text information shown for currently selected frequency.	Data service issue by the radio broadcaster.	Fill out the station issue form at website listed below.*
HD2-HD7 stations not found when Scan is pressed.	Pressing Scan disables HD2-HD7 channel search.	No action required. This is normal behavior.

*http://www.ibequity.com/automotive/report_radio_station_experiences

HD Radio Technology manufactured under license from iBiquity Digital Corp. U.S. and foreign patents. HD Radio and the HD and HD Radio logos are proprietary trademarks of iBiquity Digital Corp. Ford Motor Company and iBiquity Digital Corp. are not responsible for the content sent using HD Radio technology. Content may be changed, added or deleted at any time at the station owner's discretion.

Radio Voice Commands

If you are listening to the radio, press the voice button on the steering wheel control. When prompted, say any of the commands in the following chart.

If you are not listening to the radio, press the voice button and, after the tone, say “Radio”, then any of the commands in the following chart.

“RADIO”	
“<87.9–107.9>”	“FM preset <#>”
“<87.9–107.9> HD”*	“FM1”
“<530–1710>”	“FM 1 preset <#>”
“AM”	“FM2”
“AM <530–1710>”	“FM 2 preset <#>”
“AM autosest”	“HD <#>”*
“AM autosest preset <#>”	“Preset <#>”
“AM preset <#>”	“Radio off”
“FM”	“Radio on”
“FM <87.9–107.9>”	“Set PTY”
“FM <87.9–107.9> HD <#>”*	“Tune”**
“FM autosest”	“Help”
“FM autosest preset <#>”	

*If available.

**If you have said, “Tune”, see the following “Tune” chart.

“TUNE”	
“<87.9–107.9>”	“FM autosest”
“<87.9-107.9> HD <#>”*	“FM autosest preset <#>”
“<530–1710>”	“FM preset <#>”
“AM”	“FM1”
“AM <530–1710>”	“FM 1 preset <#>”
“AM autosest”	“FM2”
“AM autosest preset <#>”	“FM 2 preset <#>”
“AM preset <#>”	“HD <#>”*
“FM”	“Preset <#>”
“FM <87.9–107.9>”	“Help”
“FM <87.9-107.9> HD <#>”*	

*If available.

Sirius Satellite Radio (If Activated)



Press the lower left corner of the touchscreen, then select the **SIRIUS** tab.

Presets

Save a channel by pressing and holding one of the memory preset areas. There is a brief mute while the radio saves the channel. Sound returns when finished.

ALERT

Save the current song, artist, or team as a favorite. The system alerts you when it plays again on any channel.

Replay

Replay audio on the current channel. You can replay approximately 45 minutes of audio as long as you have remained tuned to the current station. Changing stations erases the previous audio.

While in replay mode:

- Press and release the seek buttons to hear the previous or next song.
- Press and hold the seek buttons to reverse or fast forward in the current track.
- Press play or pause to play or pause the audio.
- Press **Replay** to return to live audio if you have been using the feature to replay audio.

Scan

Touch this button to hear a brief sampling of channels.

Options

Sound Settings allows you to adjust settings for:

- Bass
- Midrange
- Treble
- Balance and Fade
- DSP (Digital Signal Processing)
- Occupancy Mode
- Speed Compensated Volume.

Note: Your vehicle may not have all these sound settings.

Set Category for Seek/Scan allows you to select a category of music you would like to search for. You can then choose to either seek or scan for the stations playing that category.

Parental Lockout allows you to lock and unlock channels, change or reset your PIN or unlock all channels. To use this feature, you need your initial PIN, which is 1234.

Artist/Title/Team Alerts allows you to select Artists, Titles and Teams that you would like the system to alert you to when they are playing on other channels. Press **Edit Alerts** to delete or turn off alerts. You can also set all alerts to on or off. When an alert appears on the screen, you can choose to Tune to the channel, to Cancel the alert or to Disable Alerts. If you are listening to a sporting event, you can save your favorite teams so that the system can alert you when they are playing on a satellite radio channel.

Note: Sirius does not support the Alert feature on all channels. Ford Motor Company shall not be responsible for Alert feature variation.

Electronic Serial Number (ESN) is required when you need to activate, modify or track your satellite radio account. The ESN is on the System Information Screen (SR ESN: XXXXXXXXXXXX). To access your ESN, press the bottom left corner of the touchscreen, then **SIRIUS >**

Options.**Direct Tune**

Touch this button to manually enter the desired satellite channel number. Touch **Enter** when you are done.

Browse

Touch this button to view a list of all available stations. Scroll to see more categories. Touch the station you want to listen to.

Touch **Skip** if you want to skip this channel.

Touch **Lock** if you do not want anyone to listen to this channel.

Touch **Title** or **Artist** to see song and artists on other stations.

Satellite Radio Voice Commands

If you are listening to Sirius satellite radio, press the voice button on the steering wheel control. When prompted, say any of the commands in the following chart.

If you are not listening to Sirius satellite radio, press the voice button and, after the tone, say “Sirius”, then any of the commands in the following chart.

“SIRIUS”	
“Sirius <0–223>”	“SAT 3”
“<Channel name>”	“SAT 3 preset <#>”
“Preset <#>”	“SAT preset <#>”
“SAT”	“Sirius off”
“SAT 1”	“Sirius on”
“SAT 1 preset <#>”	“Sports game”*
“SAT 2”	“Tune”**
“SAT 2 preset <#>”	“Help”

*If you have said, “Sports game”, see the following “Sports game” chart.

**If you have said, “Tune”, see the following “Tune” chart.

“SPORTS GAME”
“Tune to the <college name> game”
“Tune to the <team city> game”
“Tune to the <team city> <team name> game”
“Tune to the <team name> game”
“Help”

“TUNE”
“Sirius <0–223>”
“<Channel name>”
“Preset <#>”
“SAT”
“SAT 1”
“SAT 1 preset <#>”
“SAT 2”
“SAT 2 preset <#>”
“SAT 3”
“SAT 3 preset <#>”
“Help”

Sirius Satellite Radio Information

Note: Sirius reserves the unrestricted right to change, rearrange, add or delete programming including canceling, moving or adding particular channels, and its prices, at any time, with or without notice to you. Ford Motor Company shall not be responsible for any such programming changes.

Note: This receiver includes the eCos real-time operating system. eCos is published under the eCos License.



Sirius satellite radio is a subscription-based satellite radio service that broadcasts a variety of music, sports, news, weather, traffic and entertainment programming. Your factory-installed Sirius satellite radio system includes hardware and

a limited subscription term that begins on the date of sale or lease of your vehicle. See your authorized dealer for availability.

For more information on extended subscription terms (a service fee is required), the online media player and a list of Sirius satellite radio channels, and other features, please visit www.siriusxm.com in the United States, www.sirius.ca in Canada, or call Sirius at 1-888-539-7474.

Potential satellite radio reception issues	
Antenna obstructions	For optimal reception performance, keep the antenna clear of snow and ice build-up and keep luggage and other materials as far away from the antenna as possible.
Terrain	Hills, mountains, tall buildings, bridges, tunnels, freeway overpasses, parking garages, dense tree foliage and thunderstorms can interfere with your reception.
Station overload	When you pass a ground-based broadcast-repeating tower, a stronger signal may overtake a weaker one and the audio system may mute.
Satellite radio signal interference	Your display may show ACQUIRING . . . to indicate the interference and the audio system may mute.

Sirius troubleshooting tips		
Radio display	Condition	Possible action
Acquiring...	Radio requires more than two seconds to produce audio for the selected channel.	No action required. This message should disappear shortly.
Sat Fault/SIRIUS system failure.	There is an internal module or system failure present.	If this message does not clear shortly, or with an ignition key cycle, your receiver may have a fault. See your authorized dealer for service.
Invalid Channel.	The channel is no longer available.	Tune to another channel or choose another preset.

Sirius troubleshooting tips		
Radio display	Condition	Possible action
Unsubscribed Channel.	Your subscription does not include this channel.	Contact Sirius at 1-888-539-7474 to subscribe to the channel, or tune to another channel.
No Signal.	The signal is lost from the Sirius satellite or Sirius tower to your vehicle antenna.	The signal is blocked. When you move into an open area, the signal should return.
Updating.	Update of channel programming in progress.	No action required. The process may take up to three minutes.
Call SIRIUS 1-888-539-7474.	Your satellite service is no longer available.	Contact Sirius at 1-888-539-7474 to resolve subscription issues.
None Found. Check Channel Guide.	All the channels in the selected channels are either skipped or locked.	Use the channel guide to turn off the Lock or Skip function on that station.
Subscription Updated.	Sirius has updated the channels available for your vehicle.	No action required.

CD

Press the lower left corner of the touchscreen, and then select the **CD** tab.

You can also advance and reverse the current track or current folder, if applicable.

Repeat

Touch this button to repeat the currently playing track, all tracks on the disc or turn the feature off if already on.

Shuffle

Touch this button to play the tracks or entire albums in random order, or turn the feature off if already on.

Scan

Touch this button to hear a brief sampling of all available tracks.

More Info

Touch this button to see disc information.

Options

Sound Settings allows you to adjust settings for:

- Bass
- Midrange
- Treble
- Balance and Fade
- DSP (Digital Signal Processing)
- Occupancy Mode
- Speed Compensated Volume.

Note: Your vehicle may not have all these sound settings.

Compression allows you to turn the compression feature on and off.

Browse

Touch this button to look through all available CD tracks.

CD Voice Commands

If you are listening to a CD, press the voice button on the steering wheel control. When prompted, say any of the commands in the following chart.

If you are not listening to a CD, press the voice button and, after the tone, say “CD”, then any of the commands in the following chart.

“CD”	
“Pause”	“Repeat off”
“Play”	“Repeat track”
“Play next track”	“Shuffle”
“Play previous track”	“Shuffle CD”*
“Play track <1-512>”	“Shuffle folder”*
“Repeat”	“Shuffle off”
“Repeat folder”*	“Help”

*This applies to WMA or MP3 files only.

SD Card Slot and USB Port

SD Card Slot

Note: Your SD card slot is spring-loaded. To remove the SD card, press the card in and the system ejects it. Do not attempt to pull the card to remove it as this could cause damage.

Note: The navigation system also uses this card slot. See *Navigation system* later in this chapter for more information.

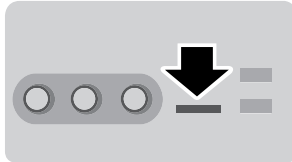

The slot is located either in the center console or behind a small access door in the instrument panel. To access and play music from your card, press the lower left corner of the touchscreen, and then select **SD Card** from the list on the left side of the screen.

SD logo is a trademark of SD-3C, LLC.

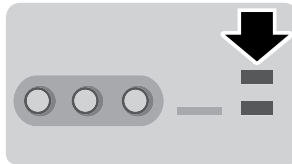

USB Port

The ports are located either in the center console or behind a small access door in the instrument panel. To access and play music from your device, press the lower left corner of the touchscreen, and then select the **USB** tab.

This feature allows you to plug in media playing devices, memory sticks, flash drives or thumb drives, and charge devices if they support this feature.

In order to playback video from your iPod or iPhone, if compatible, you must have a special combination USB/RCA composite video cable, which you can buy from Apple. When you connect the cable to your iPod or iPhone, plug the other end into both the RCA jacks and the USB port.

Playing Music from Your Device

Note: The system is capable of indexing up to 30,000 songs.

Insert your device and select the **SD Card** or **USB** tab once the system recognizes it. You can then select from the following options:

Repeat replays the currently playing song or album.

Shuffle plays music on the selected album or folder in random order.

Similar Music allows you to choose music similar to what is currently playing.

More Info displays information such as current track, artist name, album and genre.

Options allows you to view and adjust various media settings.

- **Sound Settings** allows you to adjust settings for:
 - Bass
 - Midrange
 - Treble
 - Balance and Fade
 - DSP (Digital Signal Processing)
 - Occupancy Mode
 - Speed Compensated Volume.

Note: Your vehicle may not have all these sound settings.

- **Media Player Settings** allows you to select more settings, which is under **Media Player**. See *Settings*.

- **Device Information** displays software and firmware information about the currently connected media device.
- **Update Media Index** indexes your device each time you connect it to make sure you have the latest voice commands available for all media on the device.

Browse allows you to view the contents of the device. It also allows you to search by categories, such as genre, artist or album.

If you want to view song information such as Title, Artist, File, Folder, Album, and Genre, touch the on-screen album art.

You can also touch **What's Playing** to hear how the system pronounces the current band and song. This can be helpful when using voice commands to make sure the system correctly plays your request.

SD Card and USB Voice Commands



If you are listening to a USB device or an SD card, press the voice button on the steering wheel control. When prompted, say any of the commands in the following chart.

If you are not listening to a USB device or an SD card, press the voice button and, after the tone, say “USB” or “SD card”, then any of the commands in the following chart.

“USB” or “SD CARD”	
“Browse”*	“Play previous song”
“Next”	“Play similar music”
“Pause”	“Play song <name>”
“Play”	“Play TV show <name>”**
“Play album <name>”	“Play TV show episode <name>”**
“Play all”	“Play video <name>”**
“Play artist <name>”	“Play video podcast <name>”**
“Play audiobook <name>”	“Play video podcast episode <name>”**
“Play author <name>”	“Play video playlist <name>”**
“Play composer <name>”	“Previous”
“Play folder <name>”	“Repeat all”
“Play genre <name>”	“Repeat off”
“Play movie <name>”**	“Repeat one”
“Play music video <name>”**	“Shuffle”
“Play next song”	“Shuffle off”

“USB” or “SD CARD”	
“Play playlist <name>”	“What’s this?”
“Play podcast <name>”	“Help”
“Play podcast episode <name>”	

*If you have said you would like to browse your USB or SD card, the system prompts you to specify what you would like to browse. When prompted, see the following “Browse” chart.

**This command is only available in USB mode and are device-dependent.

“BROWSE”	
“Album <name>”	“All video podcasts”*
“All albums”	“All videos”*
“All artists”	“Artist <name>”
“All audiobooks”	“Audiobook <name>”
“All authors”	“Author <name>”
“All composers”	“Composer <name>”
“All folders”	“Folder <name>”
“All genres”	“Genre <name>”
“All movies” *	“Playlist <name>”
“All music videos”*	“Podcast <name>”
“All playlists”	“TV show <name>”*
“All podcasts”	“Video <name>”*
“All songs”	“Video playlist <name>”*
“All TV shows”*	“Video podcast <name>”*
“All video playlists”*	“Help”

*This command is only available in USB mode and are device-dependent.

Supported Media Players, Formats and Metadata Information

SYNC is capable of hosting nearly any digital media player, including iPod®, Zune™, plays from device players, and most USB drives. Supported audio formats include MP3, WMA, WAV and AAC.

It is also able to organize your indexed media from your playing device by metadata tags. Metadata tags, which are descriptive software identifiers embedded in the media files, provide information about the file.

If your indexed media files contain no information embedded in these metadata tags, SYNC may classify the empty metadata tags as

Unknown.

In order to playback video from your iPod® or iPhone®, (if compatible), you **MUST** have a special combination USB/RCA composite video cable (which you can buy from Apple®). When the cable is connected to your iPod® or iPhone®, plug the other end into both the RCA jacks and the USB port.

Bluetooth Audio

Your system allows you to stream audio over your vehicle's speakers from your connected, Bluetooth-enabled cellular phone.



To access, press the lower left corner on the touchscreen, then select the **BT Stereo** tab.

Bluetooth Audio Voice Commands



If you are listening to a Bluetooth audio device, press the voice button on the steering wheel control. When prompted, say "Next song", "Pause", "Play" or "Previous song".

If you are not listening to a Bluetooth audio device, press the voice button and, after the tone, say "Bluetooth Audio", then "Next song", "Pause", "Play" or "Previous song".

A/V Inputs



WARNING: Driving while distracted can result in loss of vehicle control, crash and injury. We strongly recommend that you use extreme caution when using any device that may take your focus off the road. Your primary responsibility is the safe operation of your vehicle. We recommend against the use of any hand-held device while driving and encourage the use of voice-operated systems when possible. Make sure you are aware of all applicable local laws that may affect the use of electronic devices while driving.



WARNING: For safety reasons, do not connect or adjust the settings on your portable music player while your vehicle is moving.



WARNING: Store the portable music player in a secure location, such as the center console or the glove box, when your vehicle is in motion. Hard objects may become projectiles in a crash or sudden stop, which may increase the risk of serious injury. The audio extension cable must be long enough to allow the portable music player to be safely stored while your vehicle is moving.

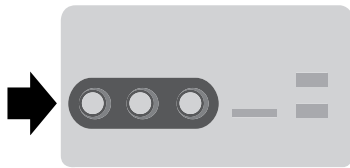

Your A/V inputs allow you to connect an auxiliary audio/video source (such as a gaming systems or a personal camcorder) by connecting RCA cords (not included) to these input jacks. The jacks are yellow, red and white and are located either behind a small access door on the

instrument panel or in your center console.

You can also use the A/V inputs as an auxiliary input jack to play music from your portable music player over your vehicle's speakers. Plug in your 1/8 inch (3.5 millimeter) RCA adapter into the two left A/V input jacks (red and white).

Press the lower left corner of the touchscreen, and then select **A/V In**.

To use the auxiliary input jack feature, make sure that your portable music player is designed for use with headphones and that it is fully charged. You also need an audio extension cable with stereo male 1/8th-inch (3.5 millimeter) connectors at one end and a RCA jack at the other.

1. Switch off the engine, radio and portable music player. Set the parking brake and put the transmission in position **P**.
2. Attach one end of the audio extension cable to the headphone output of your player and the other end into the adapter in one of the two left A/V input jacks (white or red) inside the center console.
3. Press the lower left corner on the touchscreen. Select either a tuned FM station or a CD (if there is a CD already loaded into the system).
4. Adjust the volume as desired.
5. Turn the portable music player on and adjust the volume to ½ the maximum.
6. Press the lower left corner on the touchscreen. Select the A/V In tab. (You should hear audio from your portable music player although it may be low.)
7. Adjust the sound on your portable music player until it reaches the level of the FM station or CD by switching back and forth between the controls.

In order to playback video from your iPod® or iPhone® (if compatible), you must have a special combination USB/RCA composite video cable (which you can buy from Apple®). When the cable is connected to your iPod® or iPhone®, plug the other end into both the RCA jacks and the USB port.

Troubleshooting

- Do not connect the audio input jack to a line level output. The jack only works correctly with devices that have a headphone output with a volume control.
- Do not set the portable music player's volume level higher than is necessary to match the volume of the CD or FM radio as this causes distortion and reduces sound quality.
- If the music sounds distorted at lower listening levels, turn the portable music player volume down. If the problem persists, replace or recharge the batteries in the portable media player.
- Control the portable media player in the same manner when used with headphones, as the auxiliary input jack does not provide control (such as Play or Pause) over the attached portable media player.

PHONE



- A. Phone
- B. Quick Dial
- C. Phonebook

D. History

E. Messaging

F. Settings

Hands-free calling is one of the main features of SYNC. Once you pair your phone, you can access many options using the touchscreen or voice commands. While the system supports a variety of features, many are dependent on your cellular phone's functionality. At a minimum, most cellular phones with Bluetooth wireless technology support the following functions:

- Answering an incoming call
- Ending a call
- Using privacy mode
- Dialing a number
- Redialing
- Call waiting notification
- Caller ID.

Other features, such as text messaging using Bluetooth and automatic phonebook download, are phone-dependent features. To check your phone's compatibility, see your phone's user manual and visit www.SYNCMYRide.com, www.SYNCMYRide.ca or www.syncmaroute.ca.

Pairing Your Phone for the First Time



WARNING: Driving while distracted can result in loss of vehicle control, crash and injury. We strongly recommend that you use extreme caution when using any device that may take your focus off the road. Your primary responsibility is the safe operation of your vehicle. We recommend against the use of any hand-held device while driving and encourage the use of voice-operated systems when possible. Make sure you are aware of all applicable local laws that may affect the use of electronic devices while driving.

The first thing you must do to use the phone features of SYNC is to pair your Bluetooth-enabled cellular phone with SYNC. This allows you to use your phone in a hands-free manner.

Note: Put the transmission in position **P**. Turn on your vehicle ignition and the radio.

1. Touch **Add Phone** in the upper left corner of the touchscreen. **Find SYNC** appears on the screen and instructs you to begin the pairing process from your device.

2. Make sure that Bluetooth is set to **On** and that your cellular phone is in the proper mode. See your phone's manual if necessary.
 - Select **SYNC**, and a six-digit PIN appears on your device.
3. If you are prompted to enter a PIN on your device, it does not support Secure Simple Pairing. To pair, enter the PIN displayed on the touchscreen. Skip the next step.
4. When prompted on your phone's display, confirm that the PIN provided by SYNC matches the PIN displayed on your cellular phone.
5. The display indicates when the pairing is successful.

SYNC may prompt you with more phone options. For more information on your phone's capability, see your phone's manual and visit the website.

Pairing Subsequent Phones

Note: Put the transmission in position **P**. Turn on your vehicle ignition and the radio.

1. Press the **Phone** corner of the touchscreen > **Settings** > **BT Devices** > **Add Device**.
2. Make sure that Bluetooth is set to **On** and that your cellular phone is in the proper mode. See your phone's manual if necessary.
 - Select **SYNC**, and a six-digit PIN appears on your device.
3. If you are prompted to enter a PIN on your device, it does not support Secure Simple Pairing. To pair, enter the PIN displayed on the touchscreen. Skip the next step.
4. When prompted on your phone's display, confirm that the PIN provided by SYNC matches the PIN displayed on your cellular phone.
5. The display indicates when the pairing is successful.

SYNC may prompt you with more phone options. For more information on your phone's capability, see your phone's user guide and visit the website.

Making Calls



Press the voice button on your steering wheel controls. When prompted, say, "Call <name>" or say "Dial", then the desired number.



To end the call or exit phone mode, press this phone button.

Receiving Calls

During an incoming call, an audible tone sounds. Call information appears in the display if it is available.



Accept the call by pressing **Accept** on the touchscreen or by pressing this phone button on your steering wheel controls.

Reject the call by pressing **Reject** on the touchscreen or by pressing this phone button on your steering wheel controls.

Ignore the call by doing nothing. SYNC logs it as a missed call.

Phone Menu Options

Press the top left corner on your touchscreen to select from the following options:

Phone

Touch this button to access the on-screen numerical pad to enter a number and place a call. During an active call, you can also choose to:

- Mute the call
- Put it on hold
- Turn on privacy (returns the call to your cellular phone)
- Join two calls
- End the call.

Quick Dial

Set up favorite contacts from you phonebook or history folder.

Phonebook

Touch this button to access and call any contacts in your previously downloaded phone book. The system places the entries in alphabetical categories summarized at the top of the screen.

To turn on contact picture settings, if your device supports this feature, press **Phone > Settings > Manage Phonebook > Download photos from Phonebook > On.**

History

After you connect your Bluetooth-enabled phone to SYNC, you can access any previously dialed, received or missed calls. You can also choose to save these to your **Favorites** or to **Quick Dial**.

Note: This is a phone-dependent feature. If your phone does not support downloading call history using Bluetooth, SYNC keeps track of calls made with the SYNC system.

Messaging

Send text messages using your touchscreen. See *Text messaging* later in this section.

Settings

Touch this button to access various phone settings, such as turning Bluetooth on and off, managing your phonebook and more. See *Phone settings* later in this section.

Text Messaging

Note: Downloading and sending text messages using Bluetooth are phone-dependent features.

Note: Certain features in text messaging are speed-dependent and not available when your vehicle is traveling at speeds over 3 mph (5 km/h).

Note: SYNC does not download read text messages from your phone.

You can send and receive text messages using Bluetooth, read them aloud and translate text messaging acronyms, such as LOL.

1. Touch the top left corner of the display to access the **Phone** menu.
2. Select **Messaging**.
3. Choose from the following:
 - **Listen** (speaker icon)
 - **Dial**
 - **Send Text**
 - **View**
 - **Delete**.

Composing a Text Message

Note: This is a speed-dependent feature. It is unavailable when your vehicle is traveling at speeds over 3 mph (5 km/h).

Note: Downloading and sending text messages using Bluetooth are phone-dependent features.

1. Touch the top left corner of the display to access the **Phone** menu.
2. Touch **Messaging > Send Text**.
3. Enter a phone number or choose from your phone book.
4. You can select from the following options:
 - **Send** which sends the message as it is.
 - **Edit Text** allows you to customize the pre-defined message or create a message on your own.

You can then preview the message, verify the recipient as well as update the message list.

Pre-defined text message options
I'll call you back in a few minutes.
I just left, I'll be there soon.

Pre-defined text message options
Can you give me a call?
I'm on my way.
I'm running a few minutes late.
I'm ahead of schedule, so I'll be there early.
I'm outside.
I'll call you when I get there.
OK
Yes
No
Thanks
Stuck in traffic.
Call me later.
LOL

Receiving a Text Message

When a new message arrives, an audible tone sounds and the screen displays a pop-up with the caller name and ID, if supported by your phone. You can press:

- **View** to view the text message.
- **Listen** for SYNC to read the message to you.
- **Dial** to call the contact.
- **Ignore** to exit the screen.

Note: If you select **View** and your vehicle is traveling over 3 mph (5 km/h), the system offers to read the message to you instead of allowing you to view it while driving.

Phone Settings

Press **Phone > Settings**.

Bluetooth Devices

Touch this tab to connect, disconnect, add or delete a device, as well as save it as a favorite.

Bluetooth

Touch this tab to turn Bluetooth off or on.

Do Not Disturb

Touch this tab if you want all calls to go directly to your voice mail and not ring in the vehicle. When this feature is on, text message notifications do not ring inside the cabin either.

911 Assist

Turn on or turn off the 911 Assist feature. See *911 Assist* in the *SYNC Services and Applications* section.

Phone Ringer

Select the ring tone you want to hear when you receive a call. Choose from possible system ring tones, your currently paired phone's ring tone, a beep, text-to-speech or a silent notification.

Text Message Notification

Select a text message notification, if supported by your phone. Choose from possible system alert tones, text-to-speech or silent.

Internet Data Connection

If your phone is compatible, use this screen to adjust your internet data connection. Select to make your connection profile with the personal area network or to turn off your connection. You can also choose to adjust your settings or have the system always connect, never connect when roaming or query on connect. Press ? for more information.

Manage Phonebook

Touch this button to access features such as automatic phonebook download, re-download your phonebook, add contacts from your phone as well as delete or upload your phonebook.

Roaming Warning

Touch this button to have the system alert you when your phone is in roaming mode.

Phone Voice Commands

Press the voice button on the steering wheel control. After the tone, say any of the following commands:

“PHONE”	
“Call”	“Join calls”*
“Call <name>”	“Listen to text message <#>”
“Call <name> at home”	“Listen to text messages”
“Call <name> at work”	“Messages”**
“Call <name> on cell”	“Mute call”*
“Call <name> on other”	“Pair phone”
“Call voicemail”	“Privacy on”*
“Dial”	“Read text message”
“Do not disturb off”	“Reply to text messages”
“Do not disturb on”	“Turn ringer off”
“Forward text messages”	“Turn ringer on”
“Go to hands free”*	“Unmute call”*
“Hold call off”*	“Help”
“Hold on”*	

*This command is only available during an active call.

**If you have said “Messages”, see the following “Messages” chart.

“MESSAGES”
“Call”
“Forward text messages”
“Listen to text message <#>”
“Listen to text messages”
“Reply to text messages”
“Help”

INFORMATION

 If your vehicle is equipped with Navigation, touch the i (Information) button to access these features. If your vehicle is not equipped with Navigation, touch the corner of the touchscreen with the green tab.



Under the Information menu, you can access features, such as:

- A. SYNC Services
- B. Sirius Travel Link
- C. Alerts
- D. Calendar
- E. SYNC Applications.

SYNC Services (If Equipped, United States Only)

Note: SYNC Services varies by trim level and model year and may require a subscription. Traffic alerts and turn-by-turn directions available in select markets. Message and data rates may apply. Ford Motor Company reserves the right to change or discontinue this product service at any time without prior notification or incurring any future obligation.

Note: SYNC Services requires activation before use. Visit www.SYNCMYride.com to register and check your eligibility for complimentary services. Standard phone and message rates may apply. Subscription may be required. You must also have the active SYNC Services Bluetooth-enabled cellular phone paired and connected to the

system in order to connect to, and use, SYNC Services. See *Phone* earlier in this chapter for pairing instructions.

Note: This feature does not function properly if you have enabled caller ID blocking on your mobile phone. Make sure your mobile phone is not blocking caller ID before using SYNC Services.

Note: The driver is ultimately responsible for the safe operation of the vehicle, and therefore, must evaluate whether it is safe to follow the suggested directions. Any navigation features are provided only as an aid. Make your driving decisions based on your observations of local conditions and existing traffic regulations. Do not follow the route suggestions if doing so would result in an unsafe or illegal maneuver, if you would be placed in an unsafe situation, or if you would be directed into an area that you consider unsafe. Maps used by this system may be inaccurate because of errors, changes in roads, traffic conditions or driving conditions.

Note: When you connect, the service uses GPS technology and advanced vehicle sensors to collect your vehicle's current location, travel direction and speed to help provide you with the directions, traffic reports, or business searches you request. Further, to provide the services you request, for continuous improvement, the service may collect and record call details and voice communications. For more information, see SYNC Services Terms and Conditions at www.SYNCMYride.com. If you do not want Ford or its service providers to collect your vehicle travel information or other information identified in the Terms and Conditions, do not subscribe or use the service.

SYNC Services uses advanced vehicle sensors, integrated GPS technology and comprehensive map and traffic data, to give you personalized traffic reports, precise turn-by-turn directions, business search, news, sports, weather and more. For a complete list of services, or to learn more, please visit www.SYNCMYride.com.

Connecting to SYNC Services Using Voice Commands



Press the voice button on the steering wheel controls.

1. When prompted, say "Services". This initiates an outgoing call to SYNC Services using your paired and connected Bluetooth-enabled cellular phone.
2. Once you connect to the service, follow the voice prompts to request the desired service, such as "Traffic" or "Directions". You can also say, "What are my choices?" to receive a list of available services from which to choose.
3. Say, "Services" to return to the Services main menu or for help, say, "Help".

Connecting to SYNC Services Using the Touchscreen

 If your vehicle is equipped with Navigation, touch the **i** (Information) button to access these features. If your vehicle is not equipped with Navigation, touch the corner of the touchscreen with the green tab.

Press **Services**.

1. Select **Connect to Services** to initiate an outgoing call to SYNC Services using your paired and connected Bluetooth-enabled cellular phone.
2. Once you connect to the service, follow the voice prompts to request the desired service, such as “Traffic” or “Directions”. You can also say, “What are my choices?” to receive a list of available services from which to choose.
3. Say, “Services” to return to the Services main menu or for help, say, “Help”.

Receiving Turn-by-Turn Directions

1. When connected to SYNC Services, say “Directions” or “Business Search”. To find the closest business or type of business to your current location, just say “Business Search” and then “Search Near Me”. If you need further assistance in finding a location, you can say “Operator” at any time within a Directions or Business search to speak with a live operator. The system may prompt you to speak with an operator when it has difficulty matching your voice request. The live operator can assist you by searching for businesses by name or by category, residential addresses by street address or by name or specific street intersections. Operator Assist is a feature of your SYNC Services subscription. For more information on Operator Assist, visit www.SYNCMYride.com/support.
2. Follow the voice prompts to select your Destination. After the route download is finished, the phone call automatically ends.

If your vehicle is not equipped with Navigation:

- Turn-by-turn directions appear in the information display, in the status bar of your touchscreen system and on the SYNC Services screen. You also receive driving instructions from audible prompts.
- When on an active route, you can select **Route Summary** or **Route Status** using the touchscreen controls or voice commands to view the **Route Summary Turn List** or the **Route Status ETA**. You can also turn voice guidance on or off, cancel the route or update the route.

If you miss a turn, SYNC automatically asks if you want the route updated. Just say, “Yes” when prompted and the system delivers a new route to your vehicle.

If your vehicle is equipped with Navigation, SYNC Services downloads your requested destination to the navigation system. The navigation system then calculates the route and provides driving instructions. See the *Navigation system* section for more information.

Disconnecting from SYNC Services

1. Press and hold the phone button on the steering wheel.
2. Say “Good-bye” from the SYNC Services main menu.

SYNC Services quick tips	
Personalizing	You can personalize your Services feature to provide quicker access to your most used or favorite information. You can save address points, such as work or home. You can also save favorite information like sports teams, such as Detroit Lions, or a news category. You can learn more about personalization by logging onto www.SYNCMyRide.com .
Push to interrupt	Press the voice button at any time (while connected to SYNC Services) to interrupt a voice prompt or an audio clip (such as a sports report) and say your voice command.
Portable	Your subscription is associated with your Bluetooth-enabled cellular phone number, not your VIN (Vehicle Identification Number). You can pair and connect your phone to any vehicle equipped with SYNC Services and continue enjoying your personalized services.

SYNC Services Voice Commands



When a route has been downloaded (non-navigation systems), press the voice button on the steering wheel control. When prompted, say any of the following commands:

“SERVICES”
“Cancel route”
“Navigation voice off”
“Navigation voice on”
“Next turn”

“SERVICES”
“Route status”
“Route summary”
“Services”
“Update route”
“Help”

Sirius Travel Link (If Equipped and If Activated)



WARNING: Driving while distracted can result in loss of vehicle control, crash and injury. We strongly recommend that you use extreme caution when using any device that may take your focus off the road. Your primary responsibility is the safe operation of your vehicle. We recommend against the use of any hand-held device while driving and encourage the use of voice-operated systems when possible. Make sure you are aware of all applicable local laws that may affect the use of electronic devices while driving.

Note: In order to use Sirius Travel Link, your vehicle must be equipped with navigation and your navigation SD card must be in the SD card slot.

Note: A paid subscription is required to access and use these features. Go to www.siriusxm.com/travellink for more information.

Note: Visit www.siriusxm.com/traffic# and click on Coverage map and details for a complete listing of all traffic areas covered by Sirius Travel Link.

Note: Neither Sirius nor Ford is responsible for any errors or inaccuracies in the Sirius Travel Link services or its use in vehicles.

When you subscribe to Sirius Travel Link, it can help you locate the best gas prices, find movie listings, get current traffic alerts, view the current weather map, get accurate ski conditions and see scores to current sports games.



If your vehicle is equipped with Navigation, touch the i (Information) button to access these features. If your vehicle is not equipped with Navigation, touch the corner of the touchscreen with the green tab.

Traffic On Route and Traffic Nearby

Touch these buttons to identify traffic incidents on your route, nearby your vehicle's current location or near any of your favorite places, if programmed.

Fuel Prices

Touch this button to view fuel prices at stations close to your vehicle's location or on an active navigation route.

Movie Listings

Touch this button to view nearby movie theaters and their show times, if available.

Weather

Touch this button to view the nearby weather, current weather, or the five day forecast for the chosen area. Select **Map** to see the weather map, which can show storms, radar information, charts and winds. Select **Area** to select from a listing of weather locations.

Sports Info

Touch this button to view scores and schedules from a variety of sports. You can also save up to 10 favorite teams for easier access. The score automatically refreshes when a game is in progress.

Ski Conditions

Touch this button to view ski conditions for a specific area.

Sirius Travel Link Voice Commands

Note: In order to use Sirius Travel Link, your vehicle must be equipped with navigation and your navigation SD card must be in the SD card slot.



Press the voice button on the steering wheel controls and, when prompted, say any of the following:

Travel Link voice commands	
"5-day weather forecast"	"Sports scores"*
"Fuel prices"	"Traffic"
"Movie listings"	"Travel Link"**
"Sports headlines"*	"Weather"
"Sports schedule"*	"Weather map"

*If you have said, "Sports headlines", "Sports schedule" or "Sports scores", you may say any of the commands in the "Sports headlines, Sports schedules and Sports scores" commands chart:

**If you have said, "Travel Link", you may say any of the commands in the "Travel Link" chart:

Sports headlines, sports schedules and sports scores voice commands		
“Baseball”	“My teams”	
“College basketball”	“NBA”	
“College football”	“NFL”	
“Golf”	“NHL”	
“MLS”	“WNBA”	
“Motor sports”		
“TRAVEL LINK”		
“5–day weather forecast”	“Golf schedule”	“NBA scores”
“Baseball headlines”	“MLS headlines”	“NFL headlines”
“Baseball schedule”	“MLS schedule”	“NFL schedule”
“Baseball scores”	“MLS scores”	“NFL scores”
“College basketball headlines”	“Motor sports”	“NHL headlines”
“College basketball schedule”	“Motor sports order”	“NHL schedule”
“College basketball scores”	“Motor sports schedule”	“NHL scores”
“College football headlines”	“Movie listings”	“Traffic”
“College football schedule”	“My team headlines”	“Weather”
“College football scores”	“My teams schedule”	“Weather map”
“Fuel prices”	“My teams scores”	“WNBA headlines”
“Golf headlines”	“NBA headlines”	“WNBA schedule”
“Golf leaderboard”	“NBA schedule”	“WNBA scores”

Alerts

 If your vehicle is equipped with Navigation, touch the **i** (Information) button to access these features. If your vehicle is not equipped with Navigation, touch the corner of the touchscreen with the green tab.

Press **Alerts**, and then choose from any of the following services:

- **View** the message.
- **Delete** the message.
- **Delete All** messages.

This screen displays any system messages (such as an SD card fault).

Note: The system alerts you to any messages by turning the information icon yellow. After you read or delete the messages, the icon returns to white.

Calendar

 If your vehicle is equipped with Navigation, touch the **i** (Information) button to access these features. If your vehicle is not equipped with Navigation, touch the corner of the touchscreen with the green tab.

Press **Calendar**. You can view the current calendar by day, week or month.

911 Assist® (If Equipped)



WARNING: Unless the 911 Assist setting is set on before a crash, the system will not dial for help, which could delay response time, potentially increasing the risk of serious injury or death after a crash.



WARNING: Do not wait for 911 Assist to make an emergency call if you can do it yourself. Dial emergency services immediately to avoid delayed response time, which could increase the risk of serious injury or death after a crash. If you do not hear 911 Assist within five seconds of the crash, the system or phone may be damaged or non-functional.



WARNING: Always place your phone in a secure location in your vehicle so it does not become a projectile or damaged in a crash. Failure to do so may cause serious injury to someone or damage the phone, which could prevent 911 Assist from working properly.

Note: The SYNC 911 Assist feature must be set on prior to the incident.

Note: Before setting this feature on, make sure that you read the 911 Assist privacy notice later in this section for important information.

Note: If any user turns 911 Assist on or off, that setting applies for all paired phones. If 911 Assist is turned off, either a voice message plays or a display message (or icon) comes on (or both) when your vehicle is started after a previously paired phone connects.

Note: Every phone operates differently. While SYNC 911 Assist works with most cellular phones, some may have trouble using this feature.

If a crash deploys an airbag (excludes knee airbags and rear inflatable safety belts [if equipped]) or activates the fuel pump shut-off, your SYNC-equipped vehicle may be able to contact emergency services by dialing 911 through a paired and connected Bluetooth-enabled phone. You can learn more about the 911 Assist feature, visit

www.SYNCMYRide.com, www.SYNCMYRide.ca or www.syncmaroute.ca.

- For information on airbag deployment, see the *Supplementary Restraints System* chapter.
- For information on the fuel pump shut-off, see the *Roadside Emergencies* chapter.

Setting 911 Assist On

 If your vehicle is equipped with Navigation, touch the i (Information) button to access these features. If your vehicle is not equipped with Navigation, touch the corner of the touchscreen with the green tab.

Press **Apps > 911 Assist, > On.**

You can also access 911 Assist by:

-  Pressing the Settings icon > **Settings > Phone > 911 Assist**, or
- Pressing the Settings icon > **Help > 911 Assist.**

To Make Sure that 911 Assist Works Properly

- SYNC must be powered and working properly at the time of the incident and throughout feature activation and use.
- The 911 Assist feature must be set on before the incident.
- You must pair and connect a Bluetooth-enabled and compatible phone to SYNC.
- A connected Bluetooth-enabled phone must have the ability to make and maintain an outgoing call at the time of the incident.

- A connected Bluetooth-enabled phone must have adequate network coverage, battery power and signal strength.
- The vehicle must have battery power and be located in the United States, Canada or in a territory in which 911 is the emergency number.

In the Event of a Crash

Not all crashes deploy an airbag or activate the fuel pump shut-off (which would trigger 911 Assist); however, SYNC tries to contact emergency services if 911 Assist triggers. If a connected phone sustains damage or loses connection to SYNC, SYNC searches for, and tries to connect to, any available previously paired phone and tries to make the call to 911.

Before making the call:

- SYNC provides a short window of time (about 10 seconds) to cancel the call. If you fail to cancel the call, SYNC attempts to dial 911.
- SYNC says the following, or a similar message: “SYNC will attempt to call 911, to cancel the call, press Cancel on your screen or press and hold the phone button on your steering wheel.”

If you do not cancel the call, and SYNC makes a successful call, a pre-recorded message plays for the 911 operator, and then the occupant(s) in your vehicle is able to talk with the operator. Be prepared to provide your name, phone number and location immediately, because not all 911 systems are capable of receiving this information electronically.

911 Assist May Not Work If

- Your cellular phone or 911 Assist hardware sustains damage in a crash.
- The vehicle's battery or SYNC system has no power.
- The phone(s) thrown from your vehicle are the ones paired and connected to the system.

911 Assist Privacy Notice

When you turn on 911 Assist, it may disclose to emergency services that your vehicle has been in a crash involving the deployment of an airbag or activation of the fuel pump shut-off. Certain versions or updates to 911 Assist may also be capable of electronically or verbally disclosing to 911 operators your vehicle location or other details about your vehicle or crash to assist 911 operators to provide the most appropriate emergency services. If you do not want to disclose this information, do not turn the feature on.

Vehicle Health Report (If Equipped, United States Only)

WARNING: Always follow scheduled maintenance instructions, regularly inspect your vehicle, and seek repair for any damage or problem you suspect. Vehicle Health Report supplements, but cannot replace, normal maintenance and vehicle inspection. Vehicle Health Report only monitors certain systems electronically monitored by your vehicle and will not monitor or report the status of any other system, (such as brake lining wear). Failure to perform scheduled maintenance and regularly inspect your vehicle may result in vehicle damage and serious injury.

Note: Your Vehicle Health Report feature requires activation prior to use. Visit www.SYNCMYRIDE.com to register. There is no fee or subscription associated with Vehicle Health Report, but you must register to use this feature.

Note: This feature may not function properly if you have enabled caller ID blocking on your mobile phone. Before running a report, review the *Vehicle Health Report Privacy Notice*.

Note: In order to allow a break-in period for your vehicle, you may not be able to create a Vehicle Health Report until your vehicle odometer has reached 200 miles.

Note: Cellular phone and SMS charges may apply when making a report.

Register for Vehicle Health Report and set your report preferences at www.SYNCMYRIDE.com. After registering, you can request a Vehicle Health Report (inside your vehicle). Return to your account at www.SYNCMYRIDE.com to view your report. You can also choose for SYNC to remind you automatically to run reports at specific mileage intervals. Cellular phone airtime usage may apply when reporting.

The system allows you to check your vehicle's overall health in the form of a diagnostic report card. The Vehicle Health Report contains valuable information, such as:

- Vehicle Diagnostic Information
- Scheduled maintenance
- Open Recalls and Field Service Actions
- Items noted during vehicle inspections by your authorized dealer that still need servicing.

Making a Report

If your vehicle is equipped with Navigation, touch the i (Information) button to access these features. If your vehicle is not equipped with Navigation, touch the corner of the touchscreen with the green tab.

If you want to run a report by using the touchscreen, touch **Apps > Vehicle Health Report**.



To run a report by voice command, press the voice button on the steering wheel and, when prompted, say “Vehicle health report”.

Vehicle Health Report Privacy Notice

When you create a Vehicle Health Report, Ford Motor Company may collect your cellular phone number (to process your report request) and diagnostic information about your vehicle. Certain versions or updates to Vehicle Health Report may also collect more vehicle information. Ford may use your vehicle information it collects for any purpose. If you do not want to disclose your cellular phone number or vehicle information, do not run the feature or set up your Vehicle Health Report profile at www.SYNCMYRide.com. See www.SYNCMYRide.com (Vehicle Health Report Terms and Conditions, and Privacy Statement) for more information.

SETTINGS



- A. Clock
- B. Display
- C. Sound
- D. Vehicle
- E. Settings
- F. Help



Under this menu, you can set your clock, access and adjust the display, sound and vehicle settings as well as access settings for specific modes or the help feature.

Clock

Note: You cannot manually set the date. Your vehicle's GPS does this for you.

Note: If the battery has been disconnected, your vehicle needs to acquire a GPS signal to update the clock. Once your vehicle acquires the signal, it may take a few minutes for the update to display the correct time.

1. Press the Settings icon > **Clock**.
2. Press + and - to adjust the time.

From this screen, you can also make other adjustments, such as 12- or 24-hour mode, activate GPS time synchronization and have the system automatically update for new time zones.

You can also turn the outside air temperature display on and off. It appears at the top center of the touchscreen, next to the time and date. The system automatically saves any updates you make to the settings.

Display

You can adjust the touchscreen display through the touchscreen or by pressing the voice button on your steering wheel controls and when prompted, say, “Display settings”.



Press the Settings icon > **Display**, to access and make adjustments using the touchscreen.

- **Brightness** allows you to make the screen display brighter or dimmer.
- **Auto DIM**, when set to **On**, lets you use the Auto Dim Manual Offset feature. When set to **Off**, screen brightness does not change.
- **Mode** allows you to set the screen to a certain brightness or have the system automatically change based on the outside light level, or turn the display off.
 - If you select **AUTO** or **NIGHT**, you have the options of turning the display's Auto Dim feature on or off and changing the Auto Dim Manual Offset feature.
- **Auto Dim Manual Offset** allows you to adjust screen dimming as the outside lighting conditions change from day to night. This feature also allows you to adjust screen brightness using the instrument panel dimming control.

Edit Wallpaper

- You can have your touchscreen display the default photo or upload your own.

Uploading Photos for Your Home Screen Wallpaper

Note: You cannot load photos directly from your camera. You must access the photos either from your USB mass storage device or from an SD card.

Note: Photographs with extremely large dimensions (such as 2048 x 1536) may not be compatible and appear as a blank (black) image on the display.

Your system allows you to upload and view up to 32 photos.

To access, press the Settings icon > **Display** > **Edit Wallpaper**, and then follow the system prompts to upload your photographs.

Only the photograph(s), which meets the following conditions, display:

- Compatible file formats are as follows: .jpg, .gif, .png, .bmp.
- Each file must be 1.5 MB or less.
- Recommended dimensions: 800 x 384.

Sound



Press the Settings icon > **Sound**, then select from the following:

Sound Settings	
Bass	DSP*
Midrange	Occupancy Mode*
Treble	Speed Compensated Volume
Set Balance and Fade	

*If equipped.

Vehicle



Press the Settings icon > **Vehicle**, then select from the following:

- Ambient Lighting
- Vehicle Health Report
- Door Keypad Code
- Rear View Camera
- Enable Valet Mode.

Ambient Lighting (If Equipped)

When activated, ambient lighting illuminates footwells and cupholders with a choice of colors. To access and make adjustments:

1. Press the Settings icon > **Vehicle** > **Ambient Lighting**.
2. Touch the desired color.
3. Use the scroll bar to increase or decrease the intensity.

To turn the feature on or off, press the power button.

Vehicle Health Report

Turn Automatic Reminders on and off and set the mileage interval at which you would like to receive the reports. Press ? for more information on these selections.

When done making your selections, press **Run Vehicle Health Report Now** if you want your report.

Door Keypad Code

To change the keypad code for your keyless entry keypad system:

1. Press the Settings icon > **Vehicle** > **Door Keypad Code**.
2. Enter your current factory code, then, when prompted, enter your new code.

Rear View Camera

This menu allows you to access settings for your rear view camera.

Press the Settings icon > **Vehicle** > **Rear View Camera**, then select from the following settings:

- Rear Camera Delay
- Visual Park Aid Alert
- Guidelines.

Enable Valet Mode

Valet mode allows you to lock the system. No information is accessible until the system is unlocked with the correct PIN.

1. Press the Settings icon > **Vehicle** > **Enable Valet Mode**.
2. When prompted, enter a four-digit PIN.

After you press Continue, the system locks until you enter the PIN again.

Note: If the system locks, and you need to reset the PIN, enter 3681 and the system unlocks.

Settings

Access and adjust system settings, voice features, as well as phone, navigation and wireless settings.

System

Press the Settings icon > **Settings** > **System**, then select from the following:

System	
Language	Select to have the touchscreen display in English, Spanish or French.
Distance	Select to display units in kilometers or miles.
Temperature	Select to display units in Celsius or Fahrenheit.
System Prompt Volume	Adjust the volume of voice prompts from the system.

System	
Touch Screen Button Beep	Select to have the system beep to confirm choices made through the touchscreen.
Touch Panel Button Beep	Select to have the system beep to confirm button choices made through the climate or audio system.
Keyboard Layout	Have the touchscreen keyboard display in QWERTY or ABC format.
Install Applications	Install any downloaded applications or view the current software licenses.
Master Reset	Select to restore factory defaults. This erases all personal settings and personal data.

Voice Control

Press the Settings icon > **Settings** > **Voice Control**, then select from the following:

Voice control	
Interaction Mode	Standard interaction mode provides more detailed interaction and guidance. Advanced mode has less audible interaction and more tone prompts.
Confirmation Prompts	Have the system ask you short questions if it has not clearly heard or understood your request. Note: Even with confirmation prompts turned off, the system may occasionally ask you to confirm settings.
Media Candidate Lists	Candidate lists are possible results from your voice commands. The system simply makes a best guess at your request with these turned off.
Phone Candidate Lists	Candidate lists are possible results from your voice commands. The system simply makes a best guess at your request with these turned off.
Voice Control Volume	This allows you to adjust the system's voice volume level.

Media Player

Press the Settings icon > **Settings** > **Media Player**, then select from the following:

Media player	
Autoplay	When this feature is on, the system automatically switches to the media source upon initial connection. This allows you to listen to music during the indexing process. When this feature is off, the system does not automatically switch to the inserted media source.
Bluetooth Devices	Select to connect, disconnect, add or delete a device. You can also set a device as your favorite so that the system automatically attempts to connect to that device at every ignition cycle.
Gracenote Database Info	This allows you to view the version level of the Gracenote Database.
Gracenote Management	With this feature on, the Gracenote Database supplies metadata information for your music files. This overrides information from your device. This feature defaults to off.
Cover Art Priority	With this feature on, the Gracenote Database supplied cover art for your music files. This overrides any art from your device. This feature defaults to Media Player.

Navigation

Press the Settings icon > **Settings** > **Navigation**, then select from the following:

Navigation	
Map Preferences	Turn breadcrumbs on and off.
	Have the system display your turn list top to bottom or bottom to top.
	Turn the Parking POI notification on and off.
Route Preferences	Preferred Route allows you to choose to have the system display the Shortest , Fastest or most Ecological route first. If you set Always Use Preferred Route to Yes , the system uses the selected route type to calculate only one route to the desired destination. Always Use Preferred Route bypasses route selection in destination programming. The system only calculates one route based on the preferred route setting.
	Eco Time Penalty allows you to select a low, medium or high cost for the calculated Eco Route. The higher the setting, the longer the time allotment is for the route.
	Have the system avoid freeways.
	Have the system avoid tollroads.
	Have the system avoid ferries or car trains.
	Have the system use high-occupancy vehicle lanes.
Navigation Preferences	Have the system use guidance prompts.
	Have the system automatically fill-in State/Province information.

Navigation	
Traffic Preferences	Have the system display areas where roadwork occurs.
	Have the system display incident icons.
	Have the system display areas where difficult driving conditions may occur.
	Have the system display areas where snow and ice on the road may occur.
	Have the system display any smog alerts.
	Have the system display weather warnings.
	Have the system display where there may be reduced visibility.
	Have the system turn on your radio for traffic announcements.
Avoid Areas	Enter specific areas that you would like to avoid on planned navigation routes.

Phone Settings



Press the Settings icon > **Settings** > **Phone**, then select from the following:

Phone	
Bluetooth Devices	Connect, disconnect, add or delete a device, as well as save it as a favorite.
Bluetooth	Turn Bluetooth on and off.
Do Not Disturb	Have all calls go directly to your voice mail and not ring inside your vehicle. With this feature turned on, text message notifications are also suppressed and do not ring inside your vehicle.
911 Assist	Turn on or turn off the 911 Assist feature. See <i>911 Assist</i> in the <i>SYNC applications and services</i> section.

Phone	
Phone Ringer	Select the type of notification for phone calls - ring tone, beep, text to speech, or have it be silent.
Text Message Notification	Select the type of notification for text messages - alert tone, beep, text to speech, or have it be silent.
Internet Data Connection	If compatible with your phone, you can adjust your internet data connection. Select to make your connection profile with the personal area network or to turn off your connection. You can also choose to adjust your settings or have the system always connect, never connect when roaming or query on connect. Press ? for more information.
Manage Phonebook	Access features, such as automatic phonebook download, re-download your phonebook, add contacts from your phone as well as delete or upload your phonebook.
Roaming Warning	Have the system alert you when in Roaming mode.

Wireless & Internet

Your system has a Wi-Fi feature that creates a wireless network within your vehicle, thereby allowing other devices (such as personal computers or phones) in your vehicle to speak to each other, share files or play games. Using this Wi-Fi feature, everyone in your vehicle can also gain access the internet if you have a USB mobile broadband connection inside your vehicle, your phone supports personal area networking and if you park outside a wireless hotspot.



Press the Settings icon > **Settings** > **Wireless & Internet**, then select from the following:

Wireless & Internet	
Wi-Fi Settings	Wi-Fi Network (Client) Mode turns the Wi-Fi feature on and off in your vehicle. Make sure you turn it on for connectivity purposes.
	Choose a Wireless Network allows you to use a previously stored wireless network. You can categorize by alphabetical listing, priority and signal strength. You can also choose to search for a network, connect to a network, disconnect from a network, receive more information, prioritize a network or delete a network.
	Gateway (Access Point) Mode makes SYNC an access point for a phone or a computer when turned on. This forms the local area network within your vehicle for things, such as game playing, file transfer and internet browsing. Press ? for more information.
	Gateway (Access Point) Settings allows you to view and change settings for using SYNC as the internet gateway.
	Gateway (Access Point) Device List allows you to view recent connections to your Wi-Fi system.

Wireless & Internet	
USB Mobile Broadband	Instead of using Wi-Fi, your system can also use a USB mobile broadband connection to access the internet. (You must turn on your mobile broadband device on your personal computer before connecting it to the system.) This screen allows you to set up what is your typical area for your USB mobile broadband connection. (USB mobile broadband settings may not display if the device is already on.) You can select the following: Country, Carrier, Phone Number, User Name and Password.
Bluetooth Settings	Shows you the currently paired devices as well as giving you your typical Bluetooth options to connect, disconnect, set as favorite, delete and add device. Bluetooth is a registered trademark of the Bluetooth SIG.
Prioritize Connection Methods	Choose your connection methods and change them as needed. You can select to Change Order and have the system either always attempt to connect using a USB mobile broadband or using Wi-Fi.

The Wi-Fi CERTIFIED Logo is a certification mark of the Wi-Fi Alliance.



Help

Press the Settings icon > **Help**, then select from the following:

Help	
Where Am I?	View your vehicle's current location, if your vehicle is equipped with navigation. If your vehicle is not equipped with navigation, nothing displays.
System Information	Touchscreen system serial number.
	Your vehicle identification number (VIN).
	Touchscreen system software version.
	Navigation system version.
	Map database version.
	Sirius satellite radio electronic serial number (ESN).
	Gracenote Database Information and Library version.
Software Licenses	View the licenses for any software and applications installed on your system.
Driving Restrictions	Certain features are not accessible when your vehicle is moving.
911 Assist	Turn on and turn off the 911 Assist feature. See <i>911 Assist</i> in the <i>SYNC applications and services</i> section. In Case of Emergency (ICE) Speed Dial allows you to save up to two numbers as ICE contacts for quick access if there is an emergency. Select Edit to access your phonebook and then select the desired contacts. The numbers then appear as options on this screen for the ICE 1 and ICE 2 buttons. The ICE contacts you select appear at the end of the 911 Assist call process.
Voice Command List	View categorized lists of voice commands.

To access Help using the voice commands, press the voice button, then, after the tone, say “Help”. The system provides allowable voice commands for the current mode.

CLIMATE

Press the lower right corner on the touchscreen to access your climate control features. Depending on your vehicle line and option package, your climate screen may look different from the screen shown here.

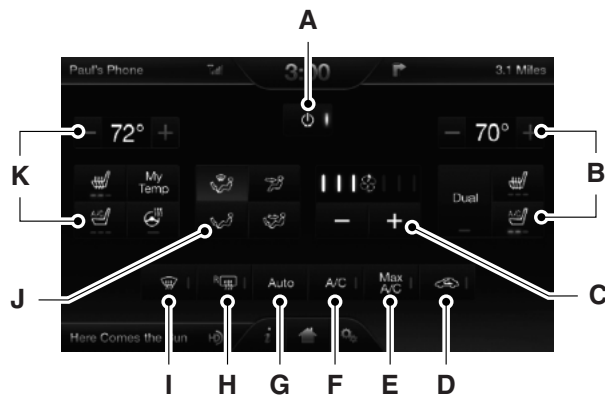

A. **Power:** Touch to switch the system off and on. Switching off the climate control system prevents outside air from entering the vehicle.

B. **Passenger settings:**

- Touch **DUAL** to switch on the passenger temperature control.
- Touch **+** or **-** to adjust the temperature.
- Touch the heated seat icon to control the heated seat.
- Touch the cooled seat icon to control the cooled seat.

C. **Fan speed:** Touch **+** or **-** to adjust fan speed.

D. **Recirculated air:** Touch to turn the recirculated air on or off which:

- May reduce the amount of time needed to cool down the interior.
- May help reduce odors from reaching the interior.
- Engages automatically when MAX A/C is selected.
- May be engaged manually in any airflow mode except defrost.
- May turn off in all airflow modes except MAX A/C to reduce fog potential.

E. **MAX A/C:** Touch to cool your vehicle with recirculated air. Touch again for normal A/C operation. MAX A/C:

- Distributes air through instrument panel vents.
- Is more economical and efficient than normal A/C mode.
- May help reduce odors from entering your vehicle.

F. **A/C:** Touch to turn the air conditioning on or off.

- Use with recirculated air to improve cooling performance and efficiency.
- Engages automatically in MAX A/C, defrost and floor/defrost.

G. **AUTO:** Touch to engage automatic operation, then set the temperature using the temperature control. The system automatically controls:

- Fan speed
- Airflow distribution
- A/C on or off
- Outside or recirculated air.

H. **Rear defroster:** Touch to turn the rear window defroster and heated mirrors.

I. **Defrost:** Touch to clear the windshield of fog and thin ice. Touch again to return to the previous airflow selection. When on, defrost:

- Provides outside air to reduce window fogging.
- Distributes air through the windshield defroster vents and demister vents.

J. **Manual controls:** Select any of the following airflow distribution modes:

- **Floor and Defrost:** Distributes air through the windshield defroster vents, demister vents, floor vents and rear seat floor vents, and provides outside air to reduce window fogging.
- **Panel:** Distributes air through the instrument panel vents.
- **Panel and Floor:** Distributes air through the instrument panel vents, demister vents, floor vents and rear seat floor vents.
- **Floor:** Distributes air through the demister vents, floor vents and rear seat floor vents.

K. **Driver settings:** Depending on your vehicle and option package, you may have the following features:

- Touch **+** or **-** to adjust the temperature.
- If your vehicle is equipped with heated seats, touch the heated seat icon to control the heated seat. See the *Seats* chapter.
- If your vehicle is equipped with cooled seats, touch the cooled seat icon to control the cooled seat. See the *Seats* chapter.

- Touch and hold **MyTemp** to select a temperature you would like your vehicle to remember and maintain for you.
- If your vehicle is equipped with a heated steering wheel, touch the heated steering wheel icon to warm the steering wheel.

Note: If your vehicle is equipped with a wood-trimmed steering wheel, it does not heat between the 10 o'clock and 2 o'clock positions.

Climate Control Voice Commands



The following voice commands are available at the main menu level of a voice session. For example, press the voice button and after the prompt, “Say a command”; say any of the following commands:

Climate control voice commands
“Climate automatic”
“Climate my temperature”
“Climate off”
“Climate on”
“Climate temperature <15.5–29.5> degrees”
“Climate temperature <60–85> degrees”
“Help”

There are additional climate control commands but in order to access them, you have to say “Climate” first, then when the system is ready to listen, you may say any of the following commands:

Additional climate control voice commands	
“Automatic”	“Panel on”
“A/C off”	“Rear defrost off”
“A/C on”	“Rear defrost on”
“Defrost off”	“Recirc off”
“Defrost on”	“Recirc on”
“Dual off”	“Temperature”*
“Fan decrease”	“Temperature <15.5–29.5> degrees”
“Fan increase”	“Temperature <60–85> degrees”
“Floor on”	“Temperature decrease”
“Max A/C off”	“Temperature high”

Additional climate control voice commands	
“Max A/C on”	“Temperature increase”
“My temp”	“Temperature low”
“Off”	“Windshield floor on”
“On”	“Help”
“Panel floor on”	

*If you have said “Temperature”, you can say any of the commands in the following “Temperature” chart.

“TEMPERATURE”
“High”
“Low”
“<15.5–29.5> degrees”
“<60–85> degrees”
“Help”

NAVIGATION SYSTEM (IF EQUIPPED)

Note: The navigation SD card must be in the SD card slot to operate the navigation system. If you need a replacement SD card, see your authorized dealer.

Note: The SD card slot is spring-loaded. To remove the SD card, just push the card in and release it. Do not attempt to pull the card out to remove it; this could cause damage.

Your navigation system is comprised of two main features, destination mode and map mode.

To set a destination, press the green corner of your touchscreen, then **Dest** when it appears. See *Setting a destination* later in this chapter.

To view the navigation map and your vehicle’s current location, touch the green bar in the upper right hand corner of the touchscreen, or, press **Dest > Map**. See *Map mode* later in this chapter.

Setting a Destination

Press the green corner of your touchscreen, then **Dest** when it appears. Choose any of the following:

Destination selections	
My Home	Street Address
Favorites	Intersection
Previous Destinations	City Center
Point of Interest	Map
Emergency	Edit Route Cancel Route

1. Enter the necessary information into the highlighted text fields (in any order). For address destination entry, **Go!** appears once you enter all the necessary information. Pressing **Go!** makes the address location appear on the map. If you choose **Previous Destination**, the last 20 destinations you have selected appear.
2. Select **Set as Dest** to make this your destination. You can also choose to set this as a waypoint (have the system route to this point on the way to your current destination) or save it as a favorite. The system considers any **Avoid Areas** selections in its route calculation.
3. Choose from up to three different types of routes, and then select **Start Route**.
 - **Fastest Route:** Uses the fastest moving roads possible.
 - **Shortest Route:** Uses the shortest distance possible.
 - **Eco Route:** Uses the most fuel-efficient route.

You can cancel the route or have the system demo the route for you. Select **Route Prefs** to set route preferences like avoiding freeways, tollroads, ferries and car trains as well as to use or not use high-occupancy vehicle lanes. (High-occupancy vehicle lanes are also known as carpool or diamond lanes. People who ride in buses, vanpools or carpools use these lanes.)

Note: If your vehicle is on a recognized road and you do not press the **Start Route** button, the system defaults to the **Fastest Route** option and begins guidance.

During route guidance, you can press the talking bubble icon that appears in the upper right navigation corner (green bar) if you want the system to repeat route guidance information. When the system repeats the last guidance instruction, it updates the distance to the next guidance instruction, since it detects when the vehicle is moving.

Point of Interest (POI) Categories

Your system offers a variety of points of interest categories.

Main categories	
Food/Drink & Dining	Automotive
Travel & Transportation	Shopping
Financial	Entertainment & Arts
Emergency	Recreation & Sports
Community	Government
Health & Medicine	Domestic Services

Within these main categories, there are subcategories which contain more listings:

Subcategories
Restaurant
Golf
Parking
Home & Garden
Personal Care Services
Automobile Dealership
Government Office
Public Transit
Education

To expand these listings, press the **+** in front of the point of interest listing.

When programming a point of interest destination, the system allows you to sort the resulting lists alphabetically, by distance or by cityseekr listings (if available).

Pressing the **Search Areas** button allows you to search for points of interest nearby, near a city or state or near a destination, if a route is active.

Pressing the **Search By Name** button allows you to directly enter the point of interest name into the system by using the keyboard.

cityseekr (If Available)

Note: cityseekr point of interest information is limited to approximately 912 cities (881 in the United States, 20 in Canada and 11 in Mexico).



cityseekr, when available, is a service that provides more information about certain points of interest such as restaurants, hotels and attractions.

When you have selected a point of interest, the location and information appear, such as address and phone number. If cityseekr lists the point of

interest, more information is available, such as a brief description, hotel check-in and checkout times or restaurant hours.

Press **More Information** for a longer review, a list of services and facilities, the average room or meal price as well as the website link.

This screen displays either a facility photo (if available) or point of interest icons, such as:



Hotel



Coffeehouse



Food & Drink



Nightlife













Attraction



This icon appears when your selection exists in multiple categories within the system.

When you are viewing more information for hotels, cityseekr also tells you if the hotel has certain services and facilities using icons.

Hotel services and facilities	
 Restaurant	 24 Hr Room Service
 Business Center	 Fitness Center
 Handicap Facilities	 Internet Access
 Laundry	 Pool
 Refrigerator	 Wi-Fi

For restaurants, cityseekr can provide information, such as star rating, average cost, review, handicap access, hours of operation, and website address.

For hotels, cityseekr can provide information, such as star rating, price category, review, check-in and check-out times, hotel service icons and website address.

Setting Your Navigation Preferences

Select settings for the system to take into account when planning your route.



Press the Settings icon > **Settings** > **Navigation**.

Map Preferences

Breadcrumbs displays your vehicle's previously traveled route with white dots. Turn this feature **ON** or **OFF**.

Turn List Format allows you to choose to have the system display your turn list **Top to Bottom** or **Bottom to Top**.

Parking POI Notification sets the automatic parking points of interest notification. Turn this feature **ON** or **OFF**. When parking points of interest notification is on, the icons display on the map when you get close to your destination. This may not be very useful in dense areas, and may clutter the map when other points of interest display.

Route Preferences

Preferred Route allows you to choose to have the system display the **Shortest, Fastest** or most **Ecological** route first. If you set **Always Use Preferred Route** to **Yes**, the system uses the selected route type to calculate only one route to the desired destination.

Always Use Preferred Route bypasses route selection in destination programming. The system only calculates one route based on the preferred route setting.

Eco Time Penalty allows you to select a low, medium or high cost for the calculated Eco Route. The higher the setting, the longer the time allotment is for the route.

Avoid features allows you to choose to have the system avoid freeways, toll roads, ferries and car trains when planning your route. Turn these features **ON** or **OFF**.

Use HOV Lanes allows you to choose to have the system use high-occupancy vehicle lanes, if available, when planning your route.

Navigation Preferences

Guidance Prompts allows you to choose to have the system use **Voice & Tones** or **Tone Only** on your programmed route.

Auto - Fill State/Province allows you have the system automatically fill in the state and province based on the information already entered into the system. Turn this feature **ON** or **OFF**.

Traffic Preferences

Avoid Traffic Problems allows you to choose how you want the system to handle traffic problems along your route.

- **Automatic:** Have the system reroute you to avoid traffic incidents that develop and impact the current route. The system does not provide a traffic alert notification.
- **Manual:** Have the system always provide a traffic alert notification for traffic incidents along the planned route. You have a choice to accept or ignore the notification before making the route deviation.

Traffic Alert Notification allows you to choose have the system display traffic alert notifications.

Other traffic alert features allows you to turn on certain, or all, traffic icons on the map such as road work, incident, accidents and closed roads. Scroll down to view all the different types of alerts. Turn these features **ON** or **OFF**.

Avoid Areas

Avoid Areas allows you to choose areas which you want the system to avoid when calculating a route for you.

Press **Add** to program an entry. Once you make a selection, the system tries to avoid the area(s) if possible for all routes. To delete a selection, choose the listing on the screen. When the screen changes to **Avoid Areas Edit**, you can press **Delete** at the bottom right of the screen.

Map Mode

Press the green bar in the upper right area of the touchscreen to view map mode. Map mode shows advanced viewing comprised of both 2D city maps as well as 3D landmarks (when available).

2D city maps show detailed outlines of buildings, visible land use and land elements and detailed railway infrastructure for the most essential cities around the globe. These maps also contain features, such as town blocks, building footprints, and railways.

3D landmarks appear as clear, visible objects that are typically recognizable and have a certain tourist value. The 3D landmarks appear in 3D map mode only. Coverage varies, and improves with updated map releases.

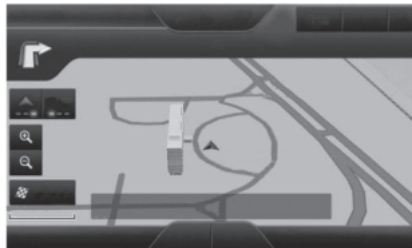

Change the appearance of the map display by repeatedly pressing the arrow button in the upper left corner of the screen. It toggles between three different map modes: Heading up, North up, and 3D.



Heading up (2D map) always shows the direction of forward travel to be upward on the screen. This view is available for map scales up to 2.5 miles (4 kilometers). The system remembers this setting for larger map scales, but shows the map in North up only. If the scale returns below this level, the system restores Heading up.



North up (2D map) always shows the northern direction to be upward on the screen.



3D map mode provides an elevated perspective of the map. This viewing angle can be adjusted and the map can be rotated 180 degrees by touching the map twice, and then dragging your finger along the shaded bar with arrows at the bottom of the map.

View switches between full map, street list and exit view in route guidance.

Menu displays a pop-up box that allows direct access to navigation settings, View/Edit Route, Sirius Travel Link, Guidance Mute and Cancel Route.



Re-center the map by pressing this icon whenever you scroll the map away from your vehicle's current location.

Auto Zoom

Press the green bar to access map mode, then select the + or - zoom button to bring up the zoom level and Auto buttons on the touchscreen. When you press **Auto**, Auto Zoom turns on and **Auto** displays in the bottom left corner of the screen in the map scale. The map zoom level then synchronizes with vehicle speed. The slower your vehicle is traveling, the farther in the map zooms in; the faster your vehicle is traveling, the farther the map zooms out. To turn the feature off, just press the + or - button again.

In 3D mode, rotate the map view by swiping your finger across the shaded bar with the arrows.

Map Icons



Vehicle mark shows the current location of your vehicle. It stays in the center of the map display, except when in scroll mode.



Scroll cursor allows you to scroll the map; the fixed icon is in the center of the screen. The map position closest to the cursor is in a window on the top center part of the screen.



Address book entry default icon(s) indicates the location on the map of an address book entry. This is the default symbol shown after the entry has been stored to the Address Book by any method other than the map. You can select from any of the 22 icons available. You can use each icon more than once.



Home indicates the location on the map currently stored as the home position. You can only save one address from the Address Book as your Home entry. You cannot change this icon.



POI (Point Of Interest) icons indicate locations of any point of interest categories you choose to display on the map. You can choose to display three point of interest categories on the map at one time.



Starting point indicates the starting point of a planned route.



Waypoints indicates the location of a waypoint on the map. The number inside the circle is different for each waypoint and represents the position of the waypoint in the route list.



Destination symbol indicates the ending point of a planned route.



Next maneuver point indicates the location of the next turn on the planned route.



No GPS symbol indicates that insufficient GPS satellite signals are available for accurate map positioning. This icon may display under normal operation in an area with poor GPS access.

Quick-touch Buttons

When in map mode, touch anywhere on the map display to access more features.

Set as Dest

Touch this button to select a scrolled location on the map as your destination. You may scroll the map by pressing your index finger on the map display. When you reach the desired location, simply let go and then touch **Set as Dest**.

Set as Waypoint

Touch this button to set the current location as a waypoint.

Save to Favorites

Touch this button to save the current location to your favorites.

POI Icons

Touch this button to select icons to display on the map. You can select up to three icons to display on the map at the same time. Turn these **ON** or **OFF**.

Cancel Route

Touch this button to cancel the active route.

View/Edit Route

Access these features when a route is active:

- View Route
- Edit Destination/Waypoints
- Edit Turn List
- Detour
- Edit Route Preferences
- Edit Traffic Preferences
- Cancel Route.

Nokia is the digital map provider for the navigation application. If you find map data errors, you may report them directly to Nokia by going to <http://mapreporter.navteq.com>. Nokia evaluates all reported map errors and responds with the result of their investigation by e-mail.

Navigation Map Updates

Annual navigation map updates are available for purchase through your dealership, by calling 1-800-NAVMAPS (in Mexico, call 01-800-557-5539) or going to www.navigation.com/ford. You need to specify the make and model of your vehicle to determine if there is an update available.

Navigation Voice Commands

When in navigation mode, press the voice button on the steering wheel control. After the tone, say any of the following commands:

Navigation system voice commands	
“Cancel next waypoint” ¹	“Navigation” ³
“Cancel route” ¹	“Navigation voice volume decrease” ¹
“Destination” ²	“Navigation voice volume increase” ¹
“Destination <nametag>”	“Repeat instruction”
“Destination <POI category>”	“Show 3D”
“Destination favorites”	“Show heading up”
“Destination home”	“Show map”
“Destination intersection”	“Show north up”
“Destination nearest <POI category>”	“Show route” ¹
“Destination nearest POI”	“Show turn list” ¹
“Destination play nametags”	“Voice guidance off”
“Destination POI”	“Voice guidance on”
“Destination POI category”	“Where am I?”
“Destination previous destination”	“Zoom in”
“Destination street address”	“Zoom out”
“Detour” ¹	“Help”

¹This command is only available when a navigation route is active.

²If you have said the command, “Destination”, you may say any of the above commands or commands in the following Destination chart.

³If you have said the command, “Navigation”, you may say any of the above commands or commands in the following Navigation chart.

“DESTINATION”
“<nametag>”
“<POI category>”
“Favorites”
“Home”
“Intersection”
“Nearest <POI category>”
“Nearest POI”
“Play nametags”
“POI category”
“Previous destination”
“Street address”
“Help”
“NAVIGATION”
“Destination”*
“Zoom city”
“Zoom country”
“Zoom in minimum”
“Zoom out maximum”
“Zoom province”
“Zoom state”
“Zoom street”
“Zoom to <distance>”
“Help”

*If you have said, “Destination”, you may say any of the commands in the Destination chart.

One-shot Destination Street Address

When you say either “Navigation destination street address” or “Destination street address”, the system asks you to say the full address. The system displays an example on-screen. You can then speak the address naturally, such as “One two three four Main Street, Anytown”.

GENERAL INFORMATION**SYNC® End User License Agreement (EULA)**

- You have acquired a device (“DEVICE”) that includes software licensed by FORD MOTOR COMPANY from an affiliate of Microsoft Corporation (“MS”). Those installed software products of MS origin, as well as associated media, printed materials, and “online” or electronic documentation (“MS SOFTWARE”) are protected by international intellectual property laws and treaties. The MS SOFTWARE is licensed, not sold. All rights reserved.
- The MS SOFTWARE may interface with and/or communicate with, or may be later upgraded to interface with and/or communicate with additional software and/or systems provided by FORD MOTOR COMPANY. The additional software and systems of FORD MOTOR COMPANY origin, as well as associated media, printed materials, and “online” or electronic documentation (“FORD SOFTWARE”) are protected by international intellectual property laws and treaties. The FORD SOFTWARE is licensed, not sold. All rights reserved.
- The MS SOFTWARE and/or FORD SOFTWARE may interface with and/or communicate with, or may be later upgraded to interface with and/or communicate with additional software and/or systems provided by third party software and service suppliers. The additional software and services of third party origin, as well as associated media, printed materials, and “online” or electronic documentation (“THIRD PARTY SOFTWARE”) are protected by international intellectual property laws and treaties. The THIRD PARTY SOFTWARE is licensed, not sold. All rights reserved.
- The MS SOFTWARE, FORD SOFTWARE and THIRD PARTY SOFTWARE hereinafter collectively and individually will be referred to as “SOFTWARE.”

IF YOU DO NOT AGREE TO THIS END USER LICENSE AGREEMENT (“EULA”), DO NOT USE THE DEVICE OR COPY THE SOFTWARE. ANY USE OF THE SOFTWARE, INCLUDING BUT NOT LIMITED TO USE ON THE DEVICE, WILL CONSTITUTE YOUR AGREEMENT TO THIS EULA (OR RATIFICATION OF ANY PREVIOUS CONSENT).

GRANT OF SOFTWARE LICENSE: This EULA grants you the following license:

- You may use the SOFTWARE as installed on the DEVICE and as otherwise interfacing with systems and/or services provide by or through FORD MOTOR COMPANY or its third party software and service providers.

DESCRIPTION OF OTHER RIGHTS AND LIMITATIONS:

- **Speech Recognition:** If the SOFTWARE includes speech recognition component(s), you should understand that speech recognition is an inherently statistical process and that recognition errors are inherent in the process. Neither FORD MOTOR COMPANY nor its suppliers shall be liable for any damages arising out of errors in the speech recognition process.
- **Limitations on Reverse Engineering, Decompilation and Disassembly:** You may not reverse engineer, decompile, or disassemble nor permit others to reverse engineer, decompile or disassemble the SOFTWARE, except and only to the extent that such activity is expressly permitted by applicable law notwithstanding this limitation.
- **Limitations on Distributing, Copying, Modifying and Creating Derivative Works:** You may not distribute, copy, make modifications to or create derivative works based on the SOFTWARE, except and only to the extent that such activity is expressly permitted by applicable law notwithstanding this limitation.
- **Single EULA:** The end user documentation for the DEVICE and related systems and services may contain multiple EULAs, such as multiple translations and/or multiple media versions (e.g., in the user documentation and in the software). Even if you receive multiple EULAs, you are licensed to use only one (1) copy of the SOFTWARE.
- **SOFTWARE Transfer:** You may permanently transfer your rights under this EULA only as part of a sale or transfer of the DEVICE, provided you retain no copies, you transfer all of the SOFTWARE (including all component parts, the media and printed materials, any upgrades, and, if applicable, the Certificate(s) of Authenticity), and the recipient agrees to the terms of this EULA. If the SOFTWARE is an upgrade, any transfer must include all prior versions of the SOFTWARE.
- **Termination:** Without prejudice to any other rights, FORD MOTOR COMPANY or MS may terminate this EULA if you fail to comply with the terms and conditions of this EULA.
- **Security Updates/Digital Rights Management:** Content owners use the WMDRM technology included in your DEVICE to protect their intellectual property, included copyrighted content. Portions of the SOFTWARE on your DEVICE use WMDRM software to access WMDRM-protected content. If the WMDRM software fails to protect the content, content owners may ask Microsoft to revoke the

SOFTWARE's ability to use WMDRM to play or copy protected content. This action does not affect unprotected content. When your DEVICE downloads licenses for protected content, you agree that Microsoft may include a revocation list with the licenses. Content owners may require you to upgrade the SOFTWARE on your DEVICE to access their content. If you decline an upgrade, you will not be able to access content that requires the upgrade.

- **Consent to Use of Data:** You agree that MS, Microsoft Corporation, FORD MOTOR COMPANY, third party software and systems suppliers, their affiliates and/or their designated agent may collect and use technical information gathered in any manner as part of product support services related to the SOFTWARE or related services. MS, Microsoft Corporation, FORD MOTOR COMPANY, third party software and services suppliers, their affiliates and/or their designated agent may use this information solely to improve their products or to provide customized services or technologies to you. MS, Microsoft Corporation, FORD MOTOR COMPANY, third party software and systems suppliers, their affiliates and/or their designated agent may disclose this information to others, but not in a form that personally identifies you.
- **Internet-Based Services Components:** The SOFTWARE may contain components that enable and facilitate the use of certain Internet-based services. You acknowledge and agree that MS, Microsoft Corporation, FORD MOTOR COMPANY, third party software and service suppliers, their affiliates and/or their designated agent may automatically check the version of the SOFTWARE and/or its components that you are utilizing and may provide upgrades or supplements to the SOFTWARE that may be automatically downloaded to your DEVICE.
- **Additional Software/Services:** The SOFTWARE may permit FORD MOTOR COMPANY, third party software and service suppliers, MS, Microsoft Corporation, their affiliates and/or their designated agent to provide or make available to you SOFTWARE updates, supplements, add-on components, or Internet-based services components of the SOFTWARE after the date you obtain your initial copy of the SOFTWARE ("Supplemental Components").

If FORD MOTOR COMPANY or third party software and services suppliers provide or make available to you Supplemental Components and no other EULA terms are provided along with the Supplemental Components, then the terms of this EULA shall apply.

If MS, Microsoft Corporation, their affiliates and/or their designated agent make available Supplemental Components, and no other EULA terms are provided, then the terms of this EULA shall apply, except that the MS, Microsoft Corporation or affiliate entity providing the Supplemental Component(s) shall be the licensor of the Supplemental Component(s).

FORD MOTOR COMPANY, MS, Microsoft Corporation, their affiliates and/or their designated agent reserve the right to discontinue without liability any Internet-based services provided to you or made available to you through the use of the SOFTWARE.

- **Links to Third Party Sites:** The MS SOFTWARE may provide you with the ability to link to third party sites through the use of the SOFTWARE. The third party sites are not under the control of MS, Microsoft Corporation, their affiliates and/or their designated agent. Neither MS nor Microsoft Corporation nor their affiliates nor their designated agent are responsible for (i) the contents of any third party sites, any links contained in third party sites, or any changes or updates to third party sites, or (ii) webcasting or any other form of transmission received from any third party sites. If the SOFTWARE provides links to third party sites, those links are provided to you only as a convenience, and the inclusion of any link does not imply an endorsement of the third party site by MS, Microsoft Corporation, their affiliates and/or their designated agent.
- **Obligation to Drive Responsibly:** You recognize your obligation to drive responsibly and keep attention on the road. You will read and abide with the DEVICE operating instructions particularly as they pertain to safety and assumes any risk associated with the use of the DEVICE.

UPGRADES AND RECOVERY MEDIA: If the SOFTWARE is provided by FORD MOTOR COMPANY separate from the DEVICE on media such as a ROM chip, CD ROM disk(s) or via web download or other means, and is labeled "For Upgrade Purposes Only" or "For Recovery Purposes Only" you may install one (1) copy of such SOFTWARE onto the DEVICE as a replacement copy for the existing SOFTWARE, and use it in accordance with this EULA, including any additional EULA terms accompanying the upgrade SOFTWARE.

INTELLECTUAL PROPERTY RIGHTS: All title and intellectual property rights in and to the SOFTWARE (including but not limited to any images, photographs, animations, video, audio, music, text and "applets," incorporated into the SOFTWARE), the accompanying printed materials, and any copies of the SOFTWARE, are owned by MS, Microsoft Corporation, FORD MOTOR COMPANY, or their affiliates or

suppliers. The SOFTWARE is licensed, not sold. You may not copy the printed materials accompanying the SOFTWARE. All title and intellectual property rights in and to the content which may be accessed through use of the SOFTWARE is the property of the respective content owner and may be protected by applicable copyright or other intellectual property laws and treaties. This EULA grants you no rights to use such content. All rights not specifically granted under this EULA are reserved by MS, Microsoft Corporation, FORD MOTOR COMPANY, third party software and service providers, their affiliates and suppliers. Use of any on-line services which may be accessed through the SOFTWARE may be governed by the respective terms of use relating to such services. If this SOFTWARE contains documentation that is provided only in electronic form, you may print one copy of such electronic documentation.

EXPORT RESTRICTIONS: You acknowledge that the SOFTWARE is subject to U.S. and European Union export jurisdiction. You agree to comply with all applicable international and national laws that apply to the SOFTWARE, including the U.S. Export Administration Regulations, as well as end-user, end-use and destination restrictions issued by U.S. and other governments. For additional information, see <http://www.microsoft.com/exporting/>.

TRADEMARKS: This EULA does not grant you any rights in connection with any trademarks or service marks of FORD MOTOR COMPANY, MS, Microsoft Corporation, third party software or service providers, their affiliates or suppliers.

PRODUCT SUPPORT: Product support for the SOFTWARE is not provided by MS, its parent corporation Microsoft Corporation, or their affiliates or subsidiaries. For product support, please refer to FORD MOTOR COMPANY instructions provided in the documentation for the DEVICE. Should you have any questions concerning this EULA, or if you desire to contact FORD MOTOR COMPANY for any other reason, please refer to the address provided in the documentation for the DEVICE.

No Liability for Certain Damages: EXCEPT AS PROHIBITED BY LAW, FORD MOTOR COMPANY, ANY THRID PARTY SOFTWARE OR SERVICES SUPPLIERS, MS, MICROSOFT CORPORATION AND THEIR AFFILIATES SHALL HAVE NO LIABILITY FOR ANY INDIRECT, SPECIAL, CONSEQUENTIAL OR INCIDENTAL DAMAGES ARISING FROM OR IN CONNECTION WITH THE USE OR PERFORMANCE OF THE SOFTWARE. THIS LIMITATION SHALL APPLY EVEN IF ANY REMEDY FAILS OF ITS ESSENTIAL PURPOSE. IN NO EVENT SHALL MS, MICROSOFT CORPORATION AND/OR THEIR AFFILIATES BE LIABLE FOR ANY AMOUNT IN EXCESS OF U.S. TWO HUNDRED FIFTY DOLLARS (U.S.\$250.00).

- THERE ARE NO WARRANTIES OTHER THAN THOSE THAT MAY EXPRESSLY BE PROVIDED FOR YOUR NEW VEHICLE.

End user notice***Microsoft® Windows® Mobile for Automotive Important Safety Information***

This system Ford SYNC™ contains software that is licensed to Manufacturer FORD MOTOR COMPANY by an affiliate of Microsoft Corporation pursuant to a license agreement. Any removal, reproduction, reverse engineering or other unauthorized use of the software from this system in violation of the license agreement is strictly prohibited and may subject you to legal action.

Read and follow instructions

Before using your Windows Automotive-based system, read and follow all instructions and safety information provided in this end user manual (“User’s Guide”). Not following precautions found in this User’s Guide can lead to an accident or other serious consequences.

Keep User’s Guide in Vehicle

When kept in the vehicle, the User’s Guide will be a ready reference for you and other users unfamiliar with the Windows Automotive-based system. Please make certain that before using the system for the first time, all persons have access to the User’s Guide and read its instructions and safety information carefully.



WARNING: Operating certain parts of this system while driving can distract your attention away from the road, and possibly cause an accident or other serious consequences. Do not change system settings or enter data non-verbally (using your hands) while driving. Stop the vehicle in a safe and legal manner before attempting these operations. This is important since while setting up or changing some functions you might be required to distract your attention away from the road and remove your hands from the wheel.

General operation**Voice Command Control**

Functions within the Windows Automotive-based system may be accomplished using only voice commands. Using voice commands while driving allows you to operate the system without removing your hands from the wheel.

Prolonged Views of Screen

Do not access any function requiring a prolonged view of the screen while you are driving. Pull over in a safe and legal manner before attempting to access a function of the system requiring prolonged attention. Even occasional short scans to the screen may be hazardous if your attention has been diverted away from your driving task at a critical time.

Volume Setting

Do not raise the volume excessively. Keep the volume at a level where you can still hear outside traffic and emergency signals while driving. Driving while unable to hear these sounds could cause an accident.

Use of Speech Recognition Functions

Speech recognition software is inherently a statistical process which is subject to errors. It is your responsibility to monitor any speech recognition functions included in the system and address any errors.

Navigation Features

Any navigation features included in the system are intended to provide turn by turn instructions to get you to a desired destination. Please make certain all persons using this system carefully read and follow instructions and safety information fully.

Distraction Hazard

Any navigation features may require manual (non-verbal) setup. Attempting to perform such set-up or insert data while driving can seriously distract your attention and could cause an accident or other serious consequences. Stop the vehicle in a safe and legal manner before attempting these operations.

Let Your Judgment Prevail

Any navigation features are provided only as an aid. Make your driving decisions based on your observations of local conditions and existing traffic regulations. Any such feature is not a substitute for your personal judgment. Any route suggestions made by this system should never replace any local traffic regulations or your personal judgment or knowledge of safe driving practices.

Route Safety

Do not follow the route suggestions if doing so would result in an unsafe or illegal maneuver, if you would be placed in an unsafe situation, or if you would be directed into an area that you consider unsafe. The driver is ultimately responsible for the safe operation of the vehicle and therefore, must evaluate whether it is safe to follow the suggested directions.

Potential Map Inaccuracy

Maps used by this system may be inaccurate because of changes in roads, traffic controls or driving conditions. Always use good judgment and common sense when following the suggested routes.

Emergency Services

Do not rely on any navigation features included in the system to route you to emergency services. Ask local authorities or an emergency services operator for these locations. Not all emergency services such as police, fire stations, hospitals and clinics are likely to be contained in the map database for such navigation features.

TeleNav Software End User License Agreement

Please read these terms and conditions carefully before you use the Telenav Software. Your use of the Telenav Software indicates that you accept these terms and conditions. If you do not accept these terms and conditions, do not break the seal of the package, launch, or otherwise use the Telenav Software.

These terms and conditions represent the agreement (“Agreement”) between you and Telenav, Inc. (“Telenav”) with respect to the Telenav Software (including upgrades, modifications, or additions thereto) (collectively “Telenav Software”). All references herein to “you” and “your” means you, your employees, agents, and contractors, and any other entity on whose behalf you accept these terms and conditions, all of whom shall also be bound by this Agreement. Additionally, all of your account information, as well as other payment and personal information provided by you to Telenav (directly or through the use of the Telenav Software, is subject to Telenav’s privacy policy located at <http://www.telenav.com>.

Telenav may revise this Agreement and the privacy policy at any time, with or without notice to you. You agree to visit <http://www.telenav.com> from time to time to review the then current version of this Agreement and of the privacy policy.

1. Safe and Lawful Use

You acknowledge that devoting attention to the Telenav Software may pose a risk of injury or death to you and others in situations that otherwise require your undivided attention, and you therefore agree to comply with the following when using the Telenav Software: (a) observe all traffic laws and otherwise drive safely; (b) use your own personal judgment while driving. If you feel that a route suggested by the Telenav Software instructs you to perform an unsafe or illegal maneuver, places

you in an unsafe situation, or directs you into an area that you consider to be unsafe, do not follow such instructions; (c) do not input destinations, or otherwise manipulate the Telenav Software, unless your vehicle is stationary and parked; (d) do not use the Telenav Software for any illegal, unauthorized, unintended, unsafe, hazardous, or unlawful purposes, or in any manner inconsistent with this Agreement; (e) arrange all GPS and wireless devices and cables necessary for use of the Telenav Software in a secure manner in your vehicle so that they will not interfere with your driving and will not prevent the operation of any safety device (such as an airbag).

You agree to indemnify and hold Telenav harmless against all claims resulting from any dangerous or otherwise inappropriate use of the Telenav Software in any moving vehicle, including as a result of your failure to comply with the directions above.

2. Account Information

You agree: (a) when registering the Telenav Software, to provide Telenav with true, accurate, current, and complete information about yourself, and (b) to inform Telenav promptly of any changes to such information, and to keep it true, accurate, current and complete.

3. Software License

Subject to your compliance with the terms of this Agreement, Telenav hereby grants to you a personal, non-exclusive, non-transferable license (except as expressly permitted below in connection with your permanent transfer of the Telenav Software license), without the right to sublicense, to use the Telenav Software (in object code form only) in order to access and use the Telenav Software. This license shall terminate upon any termination or expiration of this Agreement. You agree that you will use the Telenav Software only for your personal business or leisure purposes, and not to provide commercial navigation services to other parties.

3.1 License limitations

You agree not to do any of the following: (a) reverse engineer, decompile, disassemble, translate, modify, alter or otherwise change the Telenav Software or any part thereof; (b) attempt to derive the source code, audio library or structure of the Telenav Software without the prior express written consent of Telenav; (c) remove from the Telenav Software, or alter, any of Telenav's or its suppliers' trademarks, trade names, logos, patent or copyright notices, or other notices or markings; (d) distribute, sublicense or otherwise transfer the Telenav Software to others, except as part of your permanent transfer of the Telenav Software; or (e) use the Telenav Software in any manner that (i) infringes the intellectual property or proprietary rights, rights of publicity

or privacy or other rights of any party, (ii) violates any law, statute, ordinance or regulation, including but not limited to laws and regulations related to spamming, privacy, consumer and child protection, obscenity or defamation, or (iii) is harmful, threatening, abusive, harassing, tortuous, defamatory, vulgar, obscene, libelous, or otherwise objectionable; and (f) lease, rent out, or otherwise permit unauthorized access by third parties to the Telenav Software without advanced written permission of Telenav.

4. Disclaimers

To the fullest extent permissible pursuant to applicable law, in no event will Telenav, its licensors and suppliers, or agents or employees of any of the foregoing, be liable for any decision made or action taken by you or anyone else in reliance on the information provided by the Telenav Software. Telenav also does not warrant the accuracy of the map or other data used for the Telenav Software. Such data may not always reflect reality due to, among other things, road closures, construction, weather, new roads and other changing conditions. You are responsible for the entire risk arising out of your use of the Telenav Software. For example but without limitation, you agree not to rely on the Telenav Software for critical navigation in areas where the well-being or survival of you or others is dependent on the accuracy of navigation, as the maps or functionality of the Telenav Software are not intended to support such high risk applications, especially in more remote geographical areas. TELENAV EXPRESSLY DISCLAIMS AND EXCLUDES ALL WARRANTIES IN CONNECTION WITH THE TELENAV SOFTWARE, WHETHER STATUTORY, EXPRESS OR IMPLIED, INCLUDING ALL WARRANTIES WHICH MAY ARISE FROM COURSE OF DEALING, CUSTOM OR TRADE AND INCLUDING, BUT NOT LIMITED TO, THE IMPLIED WARRANTIES OF MERCHANTABILITY, FITNESS FOR A PARTICULAR PURPOSE AND NON-INFRINGEMENT OF THIRD PARTY RIGHTS WITH RESPECT TO THE TELENAV SOFTWARE. Certain jurisdictions do not permit the disclaimer of certain warranties, so this limitation may not apply to you.

5. Limitation of Liability

TO THE EXTENT PERMITTED UNDER APPLICABLE LAW, UNDER NO CIRCUMSTANCES SHALL TELENAV OR ITS LICENSORS AND SUPPLIERS BE LIABLE TO YOU OR TO ANY THIRD PARTY FOR ANY INDIRECT, INCIDENTAL, CONSEQUENTIAL, SPECIAL OR EXEMPLARY DAMAGES (INCLUDING IN EACH CASE, BUT NOT LIMITED TO, DAMAGES FOR THE INABILITY TO USE THE EQUIPMENT OR ACCESS DATA, LOSS OF DATA, LOSS OF BUSINESS, LOSS OF PROFITS, BUSINESS INTERRUPTION OR THE LIKE) ARISING OUT OF THE USE OF OR INABILITY TO USE THE TELENAV SOFTWARE,

EVEN IF TELENAV HAS BEEN ADVISED OF THE POSSIBILITY OF SUCH DAMAGES.

NOTWITHSTANDING ANY DAMAGES THAT YOU MIGHT INCUR FOR ANY REASON WHATSOEVER (INCLUDING, WITHOUT LIMITATION, ALL DAMAGES REFERENCED HEREIN AND ALL DIRECT OR GENERAL DAMAGES IN CONTRACT, TORT (INCLUDING NEGLIGENCE) OR OTHERWISE), THE ENTIRE LIABILITY OF TELENAV AND OF ALL OF TELENAV'S SUPPLIERS SHALL BE LIMITED TO THE AMOUNT ACTUALLY PAID BY YOU FOR THE TELENAV SOFTWARE. SOME STATES AND/OR JURISDICTIONS DO NOT ALLOW THE EXCLUSION OR LIMITATION OF INCIDENTAL OR CONSEQUENTIAL DAMAGES, SO THE ABOVE LIMITATIONS OR EXCLUSIONS MAY NOT APPLY TO YOU.

6. Arbitration and Governing Law

You agree that any dispute, claim or controversy arising out of or relating to this Agreement or the Telenav Software shall be settled by independent arbitration involving a neutral arbitrator and administered by the American Arbitration Association in the County of Santa Clara, California. The arbitrator shall apply the Commercial Arbitration Rules of the American Arbitration Association, and the judgment upon the award rendered by the arbitrator may be entered by any court having jurisdiction. Note that there is no judge or jury in an arbitration proceeding and the decision of the arbitrator shall be binding upon both parties. You expressly agree to waive your right to a jury trial.

This Agreement and performance hereunder will be governed by and construed in accordance with the laws of the State of California, without giving effect to its conflict of laws provisions. To the extent judicial action is necessary in connection with the binding arbitration, both Telenav and you agree to submit to the exclusive jurisdiction of the courts of the County of Santa Clara, California. The United Nations Convention on Contracts for the International Sale of Goods shall not apply.

7. Assignment

You may not resell, assign, or transfer this Agreement or any of your rights or obligations, except in totality, in connection with your permanent transfer of the Telenav Software, and expressly conditioned upon the new user of the Telenav Software agreeing to be bound by the terms and conditions of this Agreement. Any such sale, assignment or transfer that is not expressly permitted under this paragraph will result in immediate termination of this Agreement, without liability to Telenav, in which case you and all other parties shall immediately cease all use of the Telenav Software. Notwithstanding the foregoing, Telenav may assign

this Agreement to any other party at any time without notice, provided the assignee remains bound by this Agreement.

8. Miscellaneous

8.1 This Agreement constitutes the entire agreement between Telenav and you with respect to the subject matter hereof.

8.2 Except for the limited licenses expressly granted in this Agreement, Telenav retains all right, title and interest in and to the Telenav Software, including without limitation all related intellectual property rights. No licenses or other rights which are not expressly granted in this Agreement are intended to, or shall be, granted or conferred by implication, statute, inducement, estoppel or otherwise, and Telenav and its suppliers and licensors hereby reserve all of their respective rights other than the licenses explicitly granted in this Agreement.

8.3 By using the Telenav Software, you consent to receive from Telenav all communications, including notices, agreements, legally required disclosures or other information in connection with the Telenav Software (collectively, "Notices") electronically. Telenav may provide such Notices by posting them on Telenav's Website or by downloading such Notices to your wireless device. If you desire to withdraw your consent to receive Notices electronically, you must discontinue your use of the Telenav Software.

8.4 Telenav's or your failure to require performance of any provision shall not affect that party's right to require performance at any time thereafter, nor shall a waiver of any breach or default of this Agreement constitute a waiver of any subsequent breach or default or a waiver of the provision itself.

8.5 If any provision herein is held unenforceable, then such provision will be modified to reflect the intention of the parties, and the remaining provisions of this Agreement will remain in full force and effect.

8.6 The headings in this Agreement are for convenience of reference only, will not be deemed to be a part of this Agreement, and will not be referred to in connection with the construction or interpretation of this Agreement. As used in this Agreement, the words "include" and "including," and variations thereof, will not be deemed to be terms of limitation, but rather will be deemed to be followed by the words "without limitation".

9. Other Vendors Terms and Conditions

The Telenav Software utilizes map and other data licensed to Telenav by third party vendors for the benefit of you and other end users. This Agreement includes end-user terms applicable to these companies (included at the end of this Agreement), and thus your use of the Telenav Software is also subject to such terms. You agree to comply with the following additional terms and conditions, which are applicable to Telenav's third party vendor licensors:

End User License Agreement For Distribution By HERE For North America/APAC**END USER TERMS**

The content provided ("Data") is licensed, not sold. By opening this package, or installing, copying, or otherwise using the Data, you agree to be bound by the terms of this agreement. If you do not agree to the terms of this agreement, you are not permitted to install, copy, use, resell or transfer the Data. If you wish to reject the terms of this agreement, and have not installed, copied, or used the Data, you must contact your retailer or HERE North America, LLC (as defined below) within thirty (30) days of purchase for a refund of your purchase price. To contact HERE, please visit www.here.com.

The Data is provided for your personal, internal use only and may not be resold. It is protected by copyright, and is subject to the following terms (this "End User License Agreement") and conditions which are agreed to by you, on the one hand, and HERE and its licensors (including their licensors and suppliers) on the other hand. For purposes of these terms, "HERE" shall mean (a) HERE North America, LLC with respect to Data for the Americas and/or the Asia Pacific region and (b) HERE Europe B.V. for Data for Europe, the Middle East and/or Africa.

The Data includes certain information and related content provided under license to HERE from third parties and is subject to the applicable supplier terms and copyright notices set forth at the following URL: http://corporate.navteq.com/supplier_terms.html.

TERMS AND CONDITIONS

License Limitations on Use: You agree that your license to use this Data is limited to and conditioned on use for solely personal, noncommercial purposes, and not for service bureau, timesharing or other similar purposes. Except as otherwise set forth herein, you agree not to otherwise reproduce, copy, modify, decompile, disassemble or reverse engineer any portion of this Data, and may not transfer or distribute it in any form, for any purpose, except to the extent permitted by mandatory laws.

License Limitations on Transfer: Your limited license does not allow transfer or resale of the Data, except on the condition that you may transfer the Data and all accompanying materials on a permanent basis if: (a) you retain no copies of the Data; (b) the recipient agrees to the terms of this End-User License Agreement; and (c) you transfer the Data in the exact same form as you purchased it by physically transferring the original media (e.g., the CD-ROM or DVD you purchased), all original packaging, all Manuals and other documentation. Specifically, Multi-disc sets may only be transferred or sold as a complete set as provided to you and not as a subset thereof.

Additional License Limitations: Except where you have been specifically licensed to do so by HERE in a separate written agreement, and without limiting the preceding paragraph, your license is conditioned on use of the Data as prescribed in this agreement, and you may not (a) use this Data with any products, systems, or applications installed or otherwise connected to or in communication with vehicles capable of vehicle navigation, positioning, dispatch, real time route guidance, fleet management or similar applications; or (b) with, or in communication with, including without limitation, cellular phones, palmtop and handheld computers, pagers, and personal digital -assistants or PDAs. This Data may contain inaccurate or incomplete information due to the passage of time, changing circum-stances, sources used and the nature of collecting comprehensive geographic Data, any of which may lead to incorrect results.

No Warranty: This Data is provided to you “as is”, and you agree to use it at your own risk. HERE and its licensors (and their licensors and suppliers) make no guarantees, representations or warranties of any kind, express or implied, arising by law or otherwise, including but not limited to, content, quality, accuracy, completeness, effectiveness, reliability, fitness for a particular purpose, usefulness, use or results to be obtained from this Data, or that the Data or server will be uninterrupted or error free.

Disclaimer of Warranty: HERE AND ITS LICENSORS (INCLUDING THEIR LICENSORS AND SUPPLIERS) DISCLAIM ANY WARRANTIES, EXPRESS OR IMPLIED, OF QUALITY, PERFORMANCE, MERCHANTABILITY, FITNESS FOR A PARTICULAR PURPOSE OR NON-INFRINGEMENT. Some States, Territories and Countries do not allow certain warranty exclusions, so to that extent the above exclusion may not apply to you.

Disclaimer of Liability: HERE AND ITS LICENSORS (INCLUDING THEIR LICENSORS AND SUPPLIERS) SHALL NOT BE LIABLE TO YOU IN RESPECT OF ANY CLAIM, DEMAND OR ACTION, IRRESPECTIVE OF THE NATURE OF THE CAUSE OF THE CLAIM, DEMAND OR ACTION ALLEGING ANY LOSS, INJURY OR DAMAGES, DIRECT OR INDIRECT, WHICH MAY RESULT FROM THE USE OR POSSESSION OF THIS DATA; OR FOR ANY LOSS OF PROFIT, REVENUE, CONTRACTS OR SAVINGS, OR ANY OTHER DIRECT, INDIRECT, INCIDENTAL, SPECIAL OR CONSEQUENTIAL DAMAGES ARISING OUT OF YOUR USE OF OR INABILITY TO USE THIS DATA, ANY DEFECT IN THIS DATA, OR THE BREACH OF THESE TERMS OR CONDITIONS, WHETHER IN AN ACTION IN CONTRACT OR TORT OR BASED ON A WARRANTY, EVEN IF HERE OR ITS LICENSORS HAVE BEEN ADVISED OF THE POSSIBILITY OF SUCH DAMAGES. Some States, Territories and Countries do not allow certain liability exclusions or damages limitations, so to that extent the above may not apply to you.

Export Control: You agree not to export from anywhere any part of the Data or any direct product thereof except in compliance with, and with all licenses and approvals required under, applicable export laws, rules and regulations, including but not limited to the laws, rules and regulations administered by the Office of Foreign Assets Control of the U.S. Department of Commerce and the Bureau of Industry and Security of the U.S. Department of Commerce. To the extent that any such export laws, rules or regulations prohibit HERE from complying with any of its obligations hereunder to deliver or distribute Data, such failure shall be excused and shall not constitute a breach of this Agreement.

Entire Agreement: These terms and conditions constitute the entire agreement between HERE (and its licensors, including their licensors and suppliers) and you pertaining to the subject matter hereof, and supersedes in their entirety any and all written or oral agreements previously existing between us with respect to such subject matter.

Severability: You and HERE agree that if any portion of this agreement is found illegal or unenforceable, that portion shall be severed and the remainder of the Agreement shall be given full force and effect.

Governing Law: The above terms and conditions shall be governed by the laws of the State of Illinois (for Data for the Americas and/or the Asia Pacific region) or The Netherlands (for Data for Europe, the Middle East and Africa), without giving effect to (i) its conflict of laws provisions, or (ii) the United Nations Convention for Contracts for the International Sale of Goods, which is explicitly excluded. For any and all disputes, claims and actions arising from or in connection with the Data

(“Claims”), you agree to submit to the personal jurisdiction of (a) the State of Illinois for Claims related to Data for the Americas and/or the Asia Pacific region provided to you hereunder, and (b) The Netherlands for Data for Europe, the Middle East and/or Africa provided to you hereunder.

Government End Users: If the Data is being acquired by or on behalf of the United States government or any other entity seeking or applying rights similar to those customarily claimed by the United States government, this Data is a “commercial item” as that term is defined at 48 C.F.R. (“FAR”) 2.101, is licensed in accordance with this End[not] User License Agreement, and each copy of Data delivered or otherwise furnished shall be marked and embedded as appropriate with the following “Notice of Use”, and be treated in accordance with such Notice:

NOTICE OF USE

CONTRACTOR (MANUFACTURER/ SUPPLIER)

NAME:

HERE

CONTRACTOR (MANUFACTURER/SUPPLIER)

ADDRESS:

425 West Randolph Street, Chicago, IL 60606.

This Data is a commercial item as defined in FAR 2.101 and is subject to the End User License Agreement under which this Data was provided.

© 1987-2013 HERE. All rights reserved.

If the Contracting Officer, federal government agency, or any federal official refuses to use the legend provided herein, the Contracting Officer, federal government agency, or any federal official must notify HERE prior to seeking additional or alternative rights in the Data.

Wi-Fi hotspot data provided by JiWire ©2013 JiWire.

Gracenote® Copyright

CD and music — related data from Gracenote, Inc., copyright © 2000–2007 Gracenote. Gracenote Software, copyright © 2000–2007 Gracenote. This product and service may practice one or more of the following U.S. Patents #5,987,525; #6,061,680; #6,154,773, #6,161,132, #6,230,192, #6,230,207, #6,240,459, #6,330,593, and other patents issued or pending. Some services supplied under license from Open Globe, Inc. for U.S. Patent: #6,304,523.

Gracenote and CDDB are registered trademarks of Gracenote. The Gracenote logo and logotype, and the "Powered by Gracenote™" logo are trademarks of Gracenote.

Gracenote® End User License Agreement (EULA)

This device contains software from Gracenote, Inc. of 2000 Powell Street Emeryville, California 94608 ("Gracenote").

The software from Gracenote (the "Gracenote Software") enables this device to do disc and music file identification and obtain music-related information, including name, artist, track, and title information ("Gracenote Data") from online servers ("Gracenote Servers"), and to perform other functions. You may use Gracenote Data only by means of the intended End User functions of this device

This device may contain content belonging to Gracenote's providers. If so, all of the restrictions set forth herein with respect to Gracenote Data shall also apply to such content and such content providers shall be entitled to all of the benefits and protections set forth herein that are available to Gracenote.

You agree that you will use the content from Gracenote ("Gracenote Content"), Gracenote Data, the Gracenote Software, and Gracenote Servers for your own personal, non-commercial use only. You agree not to assign, copy, transfer or transmit the Gracenote Content, Gracenote Software or any Gracenote Data (except in a Tag associated with a music file) to any third party. YOU AGREE NOT TO USE OR EXPLOIT GRACENOTE CONTENT, GRACENOTE DATA, THE GRACENOTE SOFTWARE, OR GRACENOTE SERVERS, EXCEPT AS EXPRESSLY PERMITTED HEREIN.

You agree that your non-exclusive licenses to use the Gracenote Content, Gracenote Data, the Gracenote Software, and Gracenote Servers will terminate if you violate these restrictions. If your licenses terminate, you agree to cease any and all use of the Gracenote Content, Gracenote Data, the Gracenote Software, and Gracenote Servers. Gracenote, respectively, reserve all rights in Gracenote Data, the Gracenote Software, and the Gracenote Servers and Gracenote Content, including all ownership rights. Under no circumstances will either Gracenote become liable for any payment to you for any information that you provide, including any copyrighted material or music file information. You agree that Gracenote may enforce its respective rights, collectively or separately, under this agreement against you, directly in each company's own name.

Gracenote uses a unique identifier to track queries for statistical purposes. The purpose of a randomly assigned numeric identifier is to

allow Gracenote to count queries without knowing anything about who you are. For more information, see the web page at www.gracenote.com for the Gracenote Privacy Policy

THE GRACENOTE SOFTWARE, EACH ITEM OF GRACENOTE DATA AND THE GRACENOTE CONTENT ARE LICENSED TO YOU "AS IS." NEITHER GRACENOTE MAKES ANY REPRESENTATIONS OR WARRANTIES, EXPRESS OR IMPLIED, REGARDING THE ACCURACY OF ANY GRACENOTE DATA FROM THE GRACENOTE SERVERS OR GRACENOTE CONTENT. GRACENOTE COLLECTIVELY AND SEPARATELY RESERVE THE RIGHT TO DELETE DATA AND/OR CONTENT FROM THE COMPANIES' RESPECTIVE SERVERS OR, IN THE CASE OF GRACENOTE, CHANGE DATA CATEGORIES FOR ANY CAUSE THAT GRACENOTE DEEMS SUFFICIENT. NO WARRANTY IS MADE THAT EITHER GRACENOTE CONTENT OR THE GRACENOTE SOFTWARE OR GRACENOTE SERVERS ARE ERROR-FREE OR THAT THE FUNCTIONING OF THE GRACENOTE SOFTWARE OR GRACENOTE SERVERS WILL BE UNINTERRUPTED. GRACENOTE IS NOT OBLIGATED TO PROVIDE YOU WITH ANY ENHANCED OR ADDITIONAL DATA TYPES THAT GRACENOTE MAY CHOOSE TO PROVIDE IN THE FUTURE AND IS FREE TO DISCONTINUE ITS ONLINE SERVICES AT ANY TIME. GRACENOTE DISCLAIM ALL WARRANTIES EXPRESS OR IMPLIED, INCLUDING, BUT NOT LIMITED TO, IMPLIED WARRANTIES OF MERCHANTABILITY, FITNESS FOR A PARTICULAR PURPOSE, TITLE, AND NON-INFRINGEMENT. NEITHER GRACENOTE WARRANTS THE RESULTS THAT WILL BE OBTAINED BY YOUR USE OF THE GRACENOTE SOFTWARE OR ANY GRACENOTE SERVER. IN NO CASE WILL GRACENOTE BE LIABLE FOR ANY CONSEQUENTIAL OR INCIDENTAL DAMAGES OR FOR ANY LOST PROFITS OR LOST REVENUES FOR ANY REASON WHATSOEVER.

© Gracenote 2007

Vehicle with SYNC only

FCC ID: KMHSG1G1 IC: 1422A-SG1G1

Vehicle with SYNC and MyFord Touch or MyLincoln Touch

FCC ID: KMHSYNG2-L IC: 1422A-SYNG2-L

This device complies with Part 15 of the FCC Rules and with RSS-210 of Industry Canada. Operation is subject to the following two conditions: (1) This device may not cause harmful interference, and (2) this device must accept any interference received, including interference that may cause undesired operation.



WARNING: Changes or modifications not expressly approved by the party responsible for compliance could void the user's authority to operate the equipment. The term "IC:" before the radio certification number only signifies that Industry Canada technical specifications were met.

The antenna used for this transmitter must not be co-located or operating in conjunction with any other antenna or transmitter.

GENERAL MAINTENANCE INFORMATION**Why Maintain Your Vehicle?**

Carefully following the maintenance schedule helps protect against major repair expenses resulting from neglect or inadequate maintenance and may help to increase the value of your vehicle when you sell or trade it. Keep all receipts for completed maintenance with your vehicle.

We have established regular maintenance intervals for your vehicle based upon rigorous testing. It is important that you have your vehicle serviced at the proper times. These intervals serve two purposes; one is to maintain the reliability of your vehicle and the second is to keep your cost of owning your vehicle down.

It is your responsibility to have all scheduled maintenance performed and to make sure that the materials used meet the specifications identified in the *Capacities and Specifications* chapter of this owner's manual.

Failure to perform scheduled maintenance invalidates warranty coverage on parts affected by the lack of maintenance.

Why Maintain Your Vehicle at Your Dealership?***Factory-Trained Technicians***

Service technicians participate in extensive factory-sponsored certification training to help them become experts on the operation of your vehicle. Ask your dealership about the training and certification their technicians have received.

Genuine Ford and Motorcraft® Replacement Parts

Dealerships stock Ford, Motorcraft and Ford-authorized branded re-manufactured replacement parts. These parts meet or exceed our specifications. Parts installed at your dealership carry a nationwide 24-month or unlimited miles (kilometers) parts and labor limited warranty.

If you do not use Ford authorized parts they may not meet our specifications and depending on the part, it could affect emissions compliance.

Convenience

Many dealerships have extended evening and Saturday hours to make your service visit more convenient and they offer one stop shopping. They can perform any services that are required on your vehicle, from general maintenance to collision repairs.

Note: Not all dealers have extended hours or body shops. Please contact your dealer for details.

Protecting Your Investment

Maintenance is an investment that will pay dividends in the form of improved reliability, durability and resale value. To maintain the proper performance of your vehicle and its emission control systems, it is imperative that scheduled maintenance be completed at the designated intervals.

Your vehicle is equipped with the Intelligent Oil-Life Monitor (IOLM) system which displays a message in the information display at the proper oil change service interval; this interval may be up to one year or 10000 miles (16000 kilometers). When ENGINE OIL CHANGE DUE or OIL CHANGE REQUIRED appears in the information display, it is time for an oil change; the oil change must be done within two weeks or 500 miles (800 kilometers) of the ENGINE OIL CHANGE DUE or OIL CHANGE REQUIRED message appearing. The Intelligent Oil-Life Monitor must be reset after each oil change; see the *Information Displays* chapter.

If your information display is prematurely reset or becomes inoperative, you should perform the oil change interval at six months or 5000 miles (8000 kilometers) from your last oil change. Never exceed one year or 10000 miles (16000 kilometers) between oil change intervals.

Your vehicle is very sophisticated and built with multiple, complex, performance systems. Every manufacturer develops these systems using different specifications and performance features. That is why it is important to rely upon your dealership to properly diagnose and repair your vehicle.

Ford Motor Company has recommended maintenance intervals for various parts and component systems based upon engineering testing. Ford Motor Company relies upon this testing to determine the most appropriate mileage for replacement of oils and fluids to protect your vehicle at the lowest overall cost to you and recommends against maintenance schedules that deviate from the scheduled maintenance information.

Ford strongly recommends the use of only genuine Ford, Motorcraft or Ford-authorized remanufactured replacement parts because they are engineered for your vehicle.

Additives and Chemicals

Ford Motor Company recommended additives and chemicals are listed in the owner manual and in the Ford Workshop Manual. Additional chemicals or additives not approved by Ford Motor Company are not recommended as part of normal maintenance. Please consult your warranty information.

Oils, Fluids and Flushing

In many cases, fluid discoloration is a normal operating characteristic and, by itself, does not necessarily indicate a concern or that the fluid needs to be changed. However, discolored fluids that also show signs of overheating and foreign material contamination should be inspected immediately by a qualified expert, such as the factory-trained technicians at your dealership. Your vehicle's oils and fluids should be changed at the specified intervals or in conjunction with a repair. Flushing is a viable way to change fluid for many vehicle sub-systems during scheduled maintenance. It is critical that systems are flushed only with new fluid that is the same as that required to fill and operate the system, or using a Ford-approved flushing chemical.

Owner Checks and Services

Certain basic maintenance checks and inspections should be performed every month or at six month intervals.

Check every month
Engine oil level.
Function of all interior and exterior lights.
Tires (including spare) for wear and proper pressure.
Windshield washer fluid level.
Check every six months
Battery connections. Clean if necessary.
Body and door drain holes for obstructions. Clean if necessary.
Cooling system fluid level and coolant strength.
Door weatherstrips for wear. Lubricate if necessary.
Hinges, latches and outside locks for proper operation. Lubricate if necessary.
Parking brake for proper operation.
Safety belts and seat latches for wear and function.

Check every six months
Safety warning lamps (brake, ABS, airbag, safety belt) for operation.
Washer spray and wiper operation. Clean or replace blades as necessary.

Multi-point Inspection

In order to keep your vehicle running right, it is important to have the systems on your vehicle checked regularly. This can help identify potential issues and prevent major problems. Ford Motor Company recommends the following multi-point inspection be performed at every scheduled maintenance interval to help make sure your vehicle keeps running great.

Multi-point Inspection	
Accessory drive belt(s)	Half-shaft dust boots (if equipped)
Battery performance	Horn operation
Clutch operation (if equipped)	Radiator, cooler, heater and A/C hoses
Engine air filter	Suspension component for leaks or damage
Exhaust system	Steering and linkage
Exterior lamps and hazard warning system operation	Tires (including spare) for wear and proper pressure**
Fluid levels*; fill if necessary	Windshield for cracks, chips or pits
For oil and fluid leaks	Washer spray and wiper operation

*Brake, coolant recovery reservoir, manual and automatic transmission (with an underhood dipstick), power steering (if equipped) and window washer

**If your vehicle is equipped with a temporary mobility kit, check the tire sealant expiration Use By date on the canister. Replace as needed.

Be sure to ask your dealership service advisor or technician about the multi-point vehicle inspection. It's a comprehensive way to perform a thorough inspection of your vehicle. It's your checklist that gives you immediate feedback on the overall condition of your vehicle. You'll know what's been checked, what's okay, as well as those things that may require future or immediate attention. The multi-point vehicle inspection is one more way to keep your vehicle running great!

GENUINE
PARTS & SERVICE

Member's Member #:
Member's Serial # Balance

Multi-Point Inspection Report Card as Recommended by Ford Motor Company

Name: _____

Today's Date: _____

State Inspection Month: _____

E-Mail Address: _____

Make/Model/Year: _____

mileage: _____

SCHEDULED MAINTENANCE / INSPECTION CHECKS FOR SERVICE ON THIS MODEL

<input type="checkbox"/> Engine Air Filter	<input type="checkbox"/> Oil Filter
<input type="checkbox"/> Engine Air Filter	<input type="checkbox"/> Spark Plugs
<input type="checkbox"/> Engine Coolant	<input type="checkbox"/> Tire Rotation
<input type="checkbox"/> Fuel Filter	<input type="checkbox"/> Transmission Fluid
<input type="checkbox"/> Oil Change	

CHECK FLUID LEVELS AND FILL

Oil and/or fluid leaks

<input type="checkbox"/> Coolant	<input type="checkbox"/> Power Steering	<input type="checkbox"/> Windshield Washer
<input type="checkbox"/> Brake Fluid	<input type="checkbox"/> Windshield Washer	<input type="checkbox"/> Central Locking Reservoir

BATTERY

State of Health: _____ Condition of _____

Factory spec cold cranking amps _____

EXTERIOR BODY

Note any existing exterior body damage or defects:

SYNC VEHICLE HEALTH REPORT (VHR)

VHR Addressed Yes No

Checked and OK Not Checked Not OK

CHECK FOLLOWING SYSTEMS

BRAKE SYSTEM

Brake system (braking lines, hoses, parking brake)

EXHAUST SYSTEM

Exhaust system (leaks, damage, loose parts)

STEERING AND DRIVE AXLE

Steering system (leaks, damage, loose parts)

Drive axle (leaks, damage, loose parts)

WHEELS AND TIRE

Tire tread (minimum 1/8" remaining)

Tire pressure (set to factory recommended PSI)

Wheel alignment (steering, handling, tire wear)

LIGHTS AND SIGNALS

Operation of front, interior lights, exterior lamps, turn signals, hazard and brake lamps

WASHERS AND WIPERS

Windshield washer spray, upper wiper blades

Windshield for cracks, chips and pitting

BELT AND BUSHINGS

WMC system and hoses (leaks or loose connections)

Engine Cooling system, radiator, hoses and clamps

Accessory drive belts

BRAKE LINES

Tire Size at A/C: _____ (Check on 1/2" below driver or 1/2" to 3/4" on front wheel or 1/2" on back wheel)

LEFT FRONT		RIGHT FRONT	
<input type="checkbox"/> Tire Tread	<input type="checkbox"/> Tire Tread Depth _____ PSI	<input type="checkbox"/> Tire Tread	<input type="checkbox"/> Tire Tread Depth _____ PSI
<input type="checkbox"/> Tire Wear Patterns/Damage	<input type="checkbox"/> Tire Pressure - set to factory recommended PSI	<input type="checkbox"/> Tire Wear Patterns/Damage	<input type="checkbox"/> Tire Pressure - set to factory recommended PSI
<input type="checkbox"/> Brake Lining	<input type="checkbox"/> Brake Lining _____ PSI	<input type="checkbox"/> Brake Lining	<input type="checkbox"/> Brake Lining _____ PSI

LEFT REAR		RIGHT REAR	
<input type="checkbox"/> Tire Tread	<input type="checkbox"/> Tire Tread Depth _____ PSI	<input type="checkbox"/> Tire Tread	<input type="checkbox"/> Tire Tread Depth _____ PSI
<input type="checkbox"/> Tire Wear Patterns/Damage	<input type="checkbox"/> Tire Pressure - set to factory recommended PSI	<input type="checkbox"/> Tire Wear Patterns/Damage	<input type="checkbox"/> Tire Pressure - set to factory recommended PSI
<input type="checkbox"/> Brake Lining	<input type="checkbox"/> Brake Lining _____ PSI	<input type="checkbox"/> Brake Lining	<input type="checkbox"/> Brake Lining _____ PSI

Comments: _____

Service Advisor: _____ Customer Signature: _____

Technician: _____

12-XXXXXXXX

NORMAL SCHEDULED MAINTENANCE AND LOG**Intelligent Oil-Life Monitor®**

Your vehicle is equipped with an Intelligent Oil-Life Monitor that determines when the engine oil needs to be changed based on how your vehicle is used. By using several important factors in its calculations, the monitor helps reduce the cost of owning your vehicle and reduce environmental waste at the same time. This means you won't have to remember to change the oil on a mileage-based schedule; the vehicle lets you know when an oil change is due by displaying ENGINE OIL CHANGE DUE or OIL CHANGE REQUIRED in the information display. The following table is intended to provide examples of vehicle use and its impact on engine oil change intervals; it is provided as a guideline only. Actual engine oil change intervals depend on several factors and generally decrease with severity of use.

When to expect the OIL CHANGE REQUIRED message	
Interval	Vehicle use and examples
7500-10000 miles (12000-16000 km)	Normal
	<ul style="list-style-type: none"> - Normal commuting with highway driving - No, or moderate, load or towing - Flat to moderately hilly roads - No extended idling
5000-7499 miles (8000-11999 km)	Severe
	<ul style="list-style-type: none"> - Moderate to heavy load or towing - Mountainous or off-road conditions - Extended idling - Extended hot or cold operation
3000-4999 miles (4800-7999 km)	Extreme
	<ul style="list-style-type: none"> - Maximum load or towing - Extreme hot or cold operation

Normal scheduled maintenance*	
At every oil change interval as indicated by the information display	Change engine oil and filter.**
	Rotate tires, inspect tire wear and measure tread depth.
	Perform multi-point inspection (recommended).
	Inspect automatic transmission fluid level (if equipped with dipstick). Consult dealer for requirements.
	Inspect brake pads, shoes, rotors, drums, brake linings, hoses and parking brake.
	Inspect engine cooling system strength and hoses.
	Inspect exhaust system and heat shields.
	Inspect rear axle and U-joints. Lubricate if equipped with grease fittings (All-wheel drive vehicles).
	Inspect half-shaft boots.
	Inspect steering linkage, ball joints, suspension, tie-rod ends, driveshaft and U-joints. Lubricate if equipped with grease fittings.
	Inspect wheels and related components for abnormal noise, wear, looseness or drag.

*Do not exceed one year or 10000 miles (16000 kilometers) between service intervals.

**Reset your Intelligent Oil-Life Monitor after each engine oil and filter change. See the *Instrument Cluster* chapter.

Other maintenance items¹	
Every 20000 miles (32000 km)	Replace cabin air filter, or clean screen.
Every 30000 miles (48000 km)	Replace engine air filter.
At 100000 miles (160000 km)	Change engine coolant. ²
Every 100000 miles (160000 km)	Replace spark plugs.
	Inspect accessory drive belt(s). ³
Every 150000 miles (240000 km)	Change automatic transmission fluid
	Replace accessory drive belt(s) if not replaced within the last 100000 miles (160000 km).

¹These maintenance items can be performed within 3000 miles (4800 kilometers) of the last oil change. Do not exceed the designated distance for the interval.

²Initial replacement at six years or 100000 miles (160000 kilometers), then every three years or 50000 miles (80000 kilometers).

³After initial inspection, inspect every other oil change until replaced.

Scheduled Maintenance

439

Maintenance Schedule Log

<p style="text-align: center;">DEALER VALIDATION:</p> <p style="text-align: center;">P&A CODE:</p> <p>RO#: HOURS:</p> <p>DATE: MILEAGE:</p>	<p style="text-align: center;">DEALER VALIDATION:</p> <p style="text-align: center;">P&A CODE:</p> <p>RO#: HOURS:</p> <p>DATE: MILEAGE:</p>
<p style="text-align: center;">DEALER VALIDATION:</p> <p style="text-align: center;">P&A CODE:</p> <p>RO#: HOURS:</p> <p>DATE: MILEAGE:</p>	<p style="text-align: center;">DEALER VALIDATION:</p> <p style="text-align: center;">P&A CODE:</p> <p>RO#: HOURS:</p> <p>DATE: MILEAGE:</p>
<p style="text-align: center;">DEALER VALIDATION:</p> <p style="text-align: center;">P&A CODE:</p> <p>RO#: HOURS:</p> <p>DATE: MILEAGE:</p>	<p style="text-align: center;">DEALER VALIDATION:</p> <p style="text-align: center;">P&A CODE:</p> <p>RO#: HOURS:</p> <p>DATE: MILEAGE:</p>
<p style="text-align: center;">DEALER VALIDATION:</p> <p style="text-align: center;">P&A CODE:</p> <p>RO#: HOURS:</p> <p>DATE: MILEAGE:</p>	<p style="text-align: center;">DEALER VALIDATION:</p> <p style="text-align: center;">P&A CODE:</p> <p>RO#: HOURS:</p> <p>DATE: MILEAGE:</p>
<p style="text-align: center;">DEALER VALIDATION:</p> <p style="text-align: center;">P&A CODE:</p> <p>RO#: HOURS:</p> <p>DATE: MILEAGE:</p>	<p style="text-align: center;">DEALER VALIDATION:</p> <p style="text-align: center;">P&A CODE:</p> <p>RO#: HOURS:</p> <p>DATE: MILEAGE:</p>

Scheduled Maintenance

<p style="text-align: center;">DEALER VALIDATION:</p> <p style="text-align: center;">P&A CODE:</p> <p>RO#: HOURS:</p> <p>DATE: MILEAGE:</p>	<p style="text-align: center;">DEALER VALIDATION:</p> <p style="text-align: center;">P&A CODE:</p> <p>RO#: HOURS:</p> <p>DATE: MILEAGE:</p>
<p style="text-align: center;">DEALER VALIDATION:</p> <p style="text-align: center;">P&A CODE:</p> <p>RO#: HOURS:</p> <p>DATE: MILEAGE:</p>	<p style="text-align: center;">DEALER VALIDATION:</p> <p style="text-align: center;">P&A CODE:</p> <p>RO#: HOURS:</p> <p>DATE: MILEAGE:</p>
<p style="text-align: center;">DEALER VALIDATION:</p> <p style="text-align: center;">P&A CODE:</p> <p>RO#: HOURS:</p> <p>DATE: MILEAGE:</p>	<p style="text-align: center;">DEALER VALIDATION:</p> <p style="text-align: center;">P&A CODE:</p> <p>RO#: HOURS:</p> <p>DATE: MILEAGE:</p>
<p style="text-align: center;">DEALER VALIDATION:</p> <p style="text-align: center;">P&A CODE:</p> <p>RO#: HOURS:</p> <p>DATE: MILEAGE:</p>	<p style="text-align: center;">DEALER VALIDATION:</p> <p style="text-align: center;">P&A CODE:</p> <p>RO#: HOURS:</p> <p>DATE: MILEAGE:</p>
<p style="text-align: center;">DEALER VALIDATION:</p> <p style="text-align: center;">P&A CODE:</p> <p>RO#: HOURS:</p> <p>DATE: MILEAGE:</p>	<p style="text-align: center;">DEALER VALIDATION:</p> <p style="text-align: center;">P&A CODE:</p> <p>RO#: HOURS:</p> <p>DATE: MILEAGE:</p>

Scheduled Maintenance

441

<p style="text-align: center;">DEALER VALIDATION:</p> <p style="text-align: center;">P&A CODE:</p> <p>RO#: HOURS:</p> <p>DATE: MILEAGE:</p>	<p style="text-align: center;">DEALER VALIDATION:</p> <p style="text-align: center;">P&A CODE:</p> <p>RO#: HOURS:</p> <p>DATE: MILEAGE:</p>
<p style="text-align: center;">DEALER VALIDATION:</p> <p style="text-align: center;">P&A CODE:</p> <p>RO#: HOURS:</p> <p>DATE: MILEAGE:</p>	<p style="text-align: center;">DEALER VALIDATION:</p> <p style="text-align: center;">P&A CODE:</p> <p>RO#: HOURS:</p> <p>DATE: MILEAGE:</p>
<p style="text-align: center;">DEALER VALIDATION:</p> <p style="text-align: center;">P&A CODE:</p> <p>RO#: HOURS:</p> <p>DATE: MILEAGE:</p>	<p style="text-align: center;">DEALER VALIDATION:</p> <p style="text-align: center;">P&A CODE:</p> <p>RO#: HOURS:</p> <p>DATE: MILEAGE:</p>
<p style="text-align: center;">DEALER VALIDATION:</p> <p style="text-align: center;">P&A CODE:</p> <p>RO#: HOURS:</p> <p>DATE: MILEAGE:</p>	<p style="text-align: center;">DEALER VALIDATION:</p> <p style="text-align: center;">P&A CODE:</p> <p>RO#: HOURS:</p> <p>DATE: MILEAGE:</p>
<p style="text-align: center;">DEALER VALIDATION:</p> <p style="text-align: center;">P&A CODE:</p> <p>RO#: HOURS:</p> <p>DATE: MILEAGE:</p>	<p style="text-align: center;">DEALER VALIDATION:</p> <p style="text-align: center;">P&A CODE:</p> <p>RO#: HOURS:</p> <p>DATE: MILEAGE:</p>

SPECIAL OPERATING CONDITIONS

If you operate your vehicle **primarily** in any of the following conditions, you need to perform additional maintenance as indicated. If you **occasionally** operate your vehicle under any of these conditions, it is not necessary to perform the additional maintenance. For specific recommendations, see your dealership service advisor or technician.

Perform the services shown in the following tables when specified or within 3000 miles (4800 kilometers) of the OIL CHANGE REQUIRED message appearing in the information display.

Example #1: The OIL CHANGE REQUIRED message comes on at 28751 miles (46270 kilometers); perform the 30000 mile (48000 kilometer) automatic transmission fluid replacement.

Example #2: The OIL CHANGE REQUIRED message has **not** come on, but the odometer reads 30000 miles (48000 kilometers); perform the engine air filter replacement. (For example, the Intelligent Oil-Life Monitor was reset at 25000 miles [40000 kilometers].)

Towing a trailer or using a camper or car-top carrier	
As required	Change engine oil and filter as indicated by the information display and perform services listed in the Normal Scheduled Maintenance chart.
Inspect frequently, service as required	Inspect and lubricate U-joints.
	See axle maintenance items under <i>Exceptions</i> .
Every 30000 miles (48000 km)	Change automatic transmission fluid.

Extensive idling or low-speed driving for long distances as in heavy commercial use (such as delivery, taxi, patrol car or livery)	
As required	Change engine oil and filter as indicated by the information display and perform services listed in the Normal Scheduled Maintenance chart.
Inspect frequently, service as required	Replace cabin air filter (if equipped).
	Replace engine air filter.
Every 30000 miles (48000 km)	Change automatic transmission fluid.
Every 60000 miles (96000 km)	Replace spark plugs.
Operating in dusty or sandy conditions such as unpaved or dusty roads	
Inspect frequently, service as required	Replace cabin air filter (if equipped).
	Replace engine air filter.
Every 5000 miles (8000 km)	Inspect the wheels and related components for abnormal noise, wear, looseness or drag.
	Rotate tires, inspect tires for wear and measure tread depth.
Every 5000 miles (8000 km) or six months	Change engine oil and filter.*
	Perform multi-point inspection.
Every 30000 miles (48000 km)	Change automatic transmission fluid.

*Reset your Intelligent Oil-Life Monitor after each engine oil and filter change. See the *Instrument Cluster* chapter.

Special Operating Condition Log

<p>DEALER VALIDATION:</p> <p>RO#: P&A CODE: HOURS: DATE: MILEAGE:</p>	<p>DEALER VALIDATION:</p> <p>RO#: P&A CODE: HOURS: DATE: MILEAGE:</p>
<p>DEALER VALIDATION:</p> <p>RO#: P&A CODE: HOURS: DATE: MILEAGE:</p>	<p>DEALER VALIDATION:</p> <p>RO#: P&A CODE: HOURS: DATE: MILEAGE:</p>
<p>DEALER VALIDATION:</p> <p>RO#: P&A CODE: HOURS: DATE: MILEAGE:</p>	<p>DEALER VALIDATION:</p> <p>RO#: P&A CODE: HOURS: DATE: MILEAGE:</p>
<p>DEALER VALIDATION:</p> <p>RO#: P&A CODE: HOURS: DATE: MILEAGE:</p>	<p>DEALER VALIDATION:</p> <p>RO#: P&A CODE: HOURS: DATE: MILEAGE:</p>
<p>DEALER VALIDATION:</p> <p>RO#: P&A CODE: HOURS: DATE: MILEAGE:</p>	<p>DEALER VALIDATION:</p> <p>RO#: P&A CODE: HOURS: DATE: MILEAGE:</p>

Scheduled Maintenance

445

<p style="text-align: center;">DEALER VALIDATION:</p> <p style="text-align: center;">P&A CODE:</p> <p>RO#: HOURS:</p> <p>DATE: MILEAGE:</p>	<p style="text-align: center;">DEALER VALIDATION:</p> <p style="text-align: center;">P&A CODE:</p> <p>RO#: HOURS:</p> <p>DATE: MILEAGE:</p>
<p style="text-align: center;">DEALER VALIDATION:</p> <p style="text-align: center;">P&A CODE:</p> <p>RO#: HOURS:</p> <p>DATE: MILEAGE:</p>	<p style="text-align: center;">DEALER VALIDATION:</p> <p style="text-align: center;">P&A CODE:</p> <p>RO#: HOURS:</p> <p>DATE: MILEAGE:</p>
<p style="text-align: center;">DEALER VALIDATION:</p> <p style="text-align: center;">P&A CODE:</p> <p>RO#: HOURS:</p> <p>DATE: MILEAGE:</p>	<p style="text-align: center;">DEALER VALIDATION:</p> <p style="text-align: center;">P&A CODE:</p> <p>RO#: HOURS:</p> <p>DATE: MILEAGE:</p>
<p style="text-align: center;">DEALER VALIDATION:</p> <p style="text-align: center;">P&A CODE:</p> <p>RO#: HOURS:</p> <p>DATE: MILEAGE:</p>	<p style="text-align: center;">DEALER VALIDATION:</p> <p style="text-align: center;">P&A CODE:</p> <p>RO#: HOURS:</p> <p>DATE: MILEAGE:</p>
<p style="text-align: center;">DEALER VALIDATION:</p> <p style="text-align: center;">P&A CODE:</p> <p>RO#: HOURS:</p> <p>DATE: MILEAGE:</p>	<p style="text-align: center;">DEALER VALIDATION:</p> <p style="text-align: center;">P&A CODE:</p> <p>RO#: HOURS:</p> <p>DATE: MILEAGE:</p>

EXCEPTIONS

There are several exceptions to the Normal Schedule. They are listed below:

Normal vehicle axle maintenance: Rear axles and power take-off units with synthetic fluid and light-duty trucks equipped with Ford-design axles are lubricated for life; do not check or change fluid unless a leak is suspected, service is required or the assembly has been submerged in water. During long periods of trailer towing with outside temperatures above 70°F (21°C) and at wide-open throttle for long periods above 45 mph (72 km/h), non-synthetic rear axle fluids should be changed every 3000 miles (4800 kilometers) or three months, whichever comes first. This interval can be waived if the axle is filled with 75W140 synthetic gear fluid meeting Ford specification WSL-M2C192-A, part number FITZ-19580-B or equivalent. Add friction modifier XL-3 (EST-M2C118-A) or equivalent for complete refill of Traction-Lok rear axles (see *Technical specifications* in the *Capacities and Specifications* chapter for details).

Police/Taxi/Livery vehicle axle maintenance: Change rear axle fluid every 100000 miles (160000 kilometers). Rear axle fluid change may be waived if the axle was filled with 75W140 synthetic gear fluid meeting Ford specification WSL-M2C192-A, part number FITZ-19580-B or equivalent. Add four ounces (118 mL) of additive friction modifier XL-3 (EST-M2C118-A) or equivalent for complete refill of Traction-Lok rear axles. The axle fluid should be changed anytime the axle has been submerged in water.

California fuel filter replacement: If the vehicle is registered in California, the California Air Resources Board has determined that the failure to perform this maintenance item will not nullify the emission warranty or limit recall liability prior to the completion of the vehicle's useful life. Ford Motor Company, however, urges you to have all recommended maintenance services performed at the specified intervals and to record all vehicle service.

Hot climate oil change intervals: Vehicles operating in the Middle East, North Africa, Sub-Saharan Africa or locations with similar climates using an American Petroleum Institute (API) Certified for Gasoline Engines (Certification mark) oil of SM or SN quality, the normal oil change interval is 5000 miles (8000 kilometers). If the available API SM or SN oils are not available, then the oil change service interval is 3000 miles (4800 kilometers).

Engine air filter & cabin air filter replacement: Engine air filter and cabin air filter life is dependent on exposure to dusty and dirty conditions. Vehicles operated in these conditions require frequent inspection and replacement of the engine air filter and cabin air filter.

ENGINE COOLANT CHANGE RECORD

Initial change	Six years or 100000 miles (160000 km) (whichever comes first)
After initial change	Every three years or 50000 miles (80000 km)

Engine Coolant Change Log

<p>DEALER VALIDATION:</p> <p>P&A CODE:</p> <p>RO#: HOURS:</p> <p>DATE: MILEAGE:</p>	<p>DEALER VALIDATION:</p> <p>P&A CODE:</p> <p>RO#: HOURS:</p> <p>DATE: MILEAGE:</p>
<p>DEALER VALIDATION:</p> <p>P&A CODE:</p> <p>RO#: HOURS:</p> <p>DATE: MILEAGE:</p>	<p>DEALER VALIDATION:</p> <p>P&A CODE:</p> <p>RO#: HOURS:</p> <p>DATE: MILEAGE:</p>
<p>DEALER VALIDATION:</p> <p>P&A CODE:</p> <p>RO#: HOURS:</p> <p>DATE: MILEAGE:</p>	<p>DEALER VALIDATION:</p> <p>P&A CODE:</p> <p>RO#: HOURS:</p> <p>DATE: MILEAGE:</p>

-
- 911 Assist™380
- A**
- ABS (see Brakes)173
- Accessing and using your USB
port359
- Accessing your calendar380
- Accessory delay95
- Adaptive Cruise Control186
- Adding (pairing) a phone367
- Airbag supplemental restraint
system46
and child safety seats47
description46
disposal56
driver airbag46
passenger airbag46
side airbag46, 52
- Air cleaner filter267–268, 320
- Air filter, cabin125
- All Wheel Drive (AWD),
driving off road166
- Ambient mood/lighting387
- AM/FM346
- Antifreeze (see Engine
coolant)256
- Anti-lock brake system (see
Brakes)173
- Anti-theft system77, 79
arming the system77, 79
disarming a triggered system ..79
- Armrests136
- Audio system
Single CD330
- Audio system (see Radio)330
- Automatic transmission
driving an automatic
overdrive161
fluid, adding261
fluid, checking261
fluid, refill capacities317
fluid, specification317
Selectshift (SST)162
- Auxiliary Input Jack355
- Auxiliary powerpoint143
- A/V inputs331, 363
- Axle
lubricant specifications317
- B**
- Battery263
acid, treating emergencies263
jumping a disabled battery230
maintenance-free263
replacement, specifications ...320
servicing263
- Blind Spot Information
System195
- Booster seats22
- Brakes173
anti-lock173
anti-lock brake system (ABS)
warning light173
brake warning light173
fluid, checking and adding262
fluid, refill capacities317
fluid, specifications317
lubricant specifications317
parking174
shift interlock164
trailer219
- C**
- Capacities for refilling fluids317

-
- Engine316
 cleaning278
 coolant256
 fail-safe cooling258
 idle speed control263
 lubrication specifications317
 refill capacities317
 service points255
 Engine block heater149
 Engine oil
 checking and adding255
 dipstick255
 filter, specifications320
 refill capacities317
 specifications317
 Event data recording12
 Exhaust fumes148
- F**
- Fail safe cooling258
 Fleet MyKey programming63
 Floor mats227
 Fluid capacities317
 Four-Wheel Drive vehicles
 driving off road166
 Fuel
 cap155
 capacity317
 choosing the right fuel ...152–153
 filler funnel153
 filling your vehicle with fuel ..155
 filter, specifications263
 fuel pump shut-off229
 octane rating153, 316
 quality152
 running out of fuel153
 safety information relating to
 automotive fuels151
- Fuel - flex fuel vehicle
 (FFV)153
 Fuses242–243, 248
- G**
- Garage door opener138
 Gas cap (see Fuel cap)155
 Gauges101
- H**
- Hazard flashers229
 HD Radio™347
 Headlamps
 aiming268–269
 bulb specifications274
 flash to pass87
 high beam87
 replacing bulbs270
 Head restraints128
 Heated steering wheel397
 Heating122
 Help396
 Hill start assist174
 Homelink wireless control
 system138
 Hood253
 How to use voice commands ...340
- I**
- Ignition316
 Illuminated visor mirror98
 Information displays107
 Inspection/maintenance (I/M)
 testing159

Instrument panel		Lug nuts	314
cleaning	280	M	
cluster	101	Making and receiving calls	367
Intelligent Access Key	58	MAP DVD - Loading and Unloading	367
J		Map icons	407
Jack	308	Map mode	406
positioning	308	Map preferences	404
storage	308	Map updates	409
Jump-starting your vehicle	230	Message center	107
K		warning messages	113
Keyless entry system		Mirrors	95, 97
autolock	69	fold away	96
keypad	75	programmable memory	59
locking and unlocking doors	76	side view mirrors (power)	95
programming entry code	75	Moon roof	99
Keys	77	Motorcraft® parts	276, 320
L		MyFord Touch™ system	332
Lamps		MyKey	63
bulb replacement		MyLincoln Touch™ system	330
specifications chart	274	N	
headlamps, flash to pass	87	Navigation features	400
interior lamps	92–93	Navigation voice commands	410
replacing bulbs	270	Notifications	380
LATCH anchors	28	O	
Liftgate	68, 71, 208	Octane rating	153
Lights, warning and indicator	101	P	
Listening to music	344	Pairing other phones	367
Load limits	208	Pairing your phone	366
Locks			
autolock	69		
childproof	32		
doors	67		
Lubricant specifications	317		

-
- Pairing your phone for the first time366
 - Parental MyKey programming ...63
 - Parking brake174
 - Parts (see Motorcraft® parts)320
 - Passenger Occupant Classification Sensor48
 - Phone settings370, 392
 - Phone voice commands372
 - POI categories402
 - Point of Interest (POI)402
 - Power distribution box (see Fuses)243
 - Power door locks67
 - Power liftgate71
 - Power mirrors95
 - Powerpoint143
 - Power steering203
 - fluid, checking and adding262
 - fluid, refill capacity317
 - fluid, specifications317
 - Power Windows94
 - Privacy information338
 - Push button start system145
- Q**
- Quick touch buttons408
- R**
- Radio330
 - AM/FM346
 - Single CD330
 - Radio reception328
 - Radio voice commands351
 - Rear heated seats136
 - Rear view camera display180, 388
 - Rear window defroster122
 - Receiving a text message370
 - Recommendations for attaching safety restraints for children24
 - Relays242–243
 - Remote entry system
 - illuminated entry70–71
 - locking/unlocking doors67
 - opening the trunk68
 - replacing the batteries58
 - Reverse sensing system180
 - Roadside assistance228
 - Roll stability control178
 - Roof rack207
 - Route preferences404
- S**
- Safety Belt Maintenance42
 - Safety belts (see Safety restraints)35, 38
 - Safety defects, reporting241
 - Safety information336
 - Safety restraints35–36, 38
 - Belt-Minder®39
 - Belt-Minder®, deactivating/activating41
 - extension assembly38
 - for adults35–36
 - for children24
 - Occupant Classification Sensor48

safety belt maintenance	42	SIRIUS® satellite radio	352
seat belt maintenance	42	SIRIUS satellite radio voice	
warning light and chime	39	commands	354
Safety restraints - LATCH		SIRIUS Travel Link	377
anchors	28	SIRIUS Travel Link voice	
Safety seats for children	24	commands	378
Safety Compliance		SOS Post Crash Alert	45
Certification Label	321	Spark plugs,	
Satellite Radio	330, 352	specifications	316, 320
Scheduled Maintenance Guide		Specification chart,	
Normal Scheduled		lubricants	317
Maintenance and Log	436	Stability system	178
SD card	331, 359, 400	Starting your vehicle	146
Seat belts (see Safety		jump starting	230
restraints)	35	push button start system	145
Seats	135	Steering wheel	80
child safety seats	24	controls	82
climate control	134	tilting	80
easy access/easyout feature ..	133	Supplemental Restraint System	
front seats	130, 133	(SRS) (see airbags)	46
heated	136	Supported media file types	362
memory seat	59, 132	Supported player, media	
second row seats	135	formats and metadata	
Second-row power fold seat	135	information	362
SecuriCode keyless entry		SYNC® customer support	336
system	75	SYNC® Services	373
SecuriLock passive anti-theft		System settings	388
system	77	T	
Sending new text messages	369	Temperature control (see	
Setting a destination	400	Climate control)	122, 397
Setting a destination by		Text messaging	369
voice	401	Tilt steering wheel	80
Settings	385	Tires	288–289, 308
Setting the clock	330, 385	alignment	302
Side air curtain	53		
Side-curtain airbags system	53		

-
- care288
 - changing308, 311
 - checking the pressure298
 - inflating296
 - label295
 - replacing300
 - rotating303
 - safety practices302
 - sidewall information291
 - snow tires and chains303
 - spare tire309
 - terminology290
 - tire grades289
 - treadwear289, 298
 - Touchscreen features
(climate)397
 - Towing216, 222–223
 - recreational towing223
 - trailer towing216
 - wrecker222
 - Traction control176
 - Traffic preferences404
 - Trailer sway control217
 - Transmission
 - brake-shift interlock (BSI)164
 - fluid, checking and adding
(automatic)261
 - fluid, refill capacities317
 - lubricant specifications317
 - Turn signal91
 - U**
 - USB port331, 359
 - V**
 - Vehicle health report383
 - Vehicle Identification Number
(VIN)320
 - Vehicle loading208
 - Ventilating your vehicle148
 - Voice recognition340
 - W**
 - Warning lights (see Lights)101
 - Washer fluid263
 - Water, Driving through226
 - Windows
 - power94
 - rear wiper/washer86
 - Windshield washer fluid and
wipers85
 - checking and adding fluid263
 - replacing wiper blades ...266–267
 - Wrecker towing222