

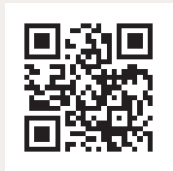

THE LINCOLN MOTOR COMPANY



lincolnowner.com



lincolncanada.com

March 2014  
Second Printing  
Owner's Manual  
Lincoln Navigator  
Litho in U.S.A.



EL7J 19A321 AA



2014  
NAVIGATOR

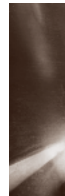

Owner's Manual

2014 NAVIGATOR



Owner's Manual



THE LINCOLN MOTOR COMPANY

<b>Table of Contents</b>	<b>1</b>
<hr/>	
<b>Introduction</b>	<b>9</b>
<b>Child Safety</b>	<b>17</b>
Child seat positioning . . . . .	.19
Booster seats . . . . .	.21
Installing child seats . . . . .	.24
Child safety locks . . . . .	.35
<b>Safety Belts</b>	<b>36</b>
Fastening the safety belts . . . . .	.38
Safety belt height adjustment . . . . .	.41
Safety belt warning light and indicator chime . . . . .	.42
Safety belt-minder . . . . .	.43
Child restraint and safety belt maintenance . . . . .	.45
<b>Supplementary Restraints System</b>	<b>46</b>
Driver and passenger airbags . . . . .	.49
Side airbags . . . . .	.51
Safety canopy curtain airbags . . . . .	.52
Crash sensors and airbag indicator . . . . .	.54
Airbag disposal . . . . .	.55
<b>Keys and Remote Control</b>	<b>56</b>
General information on radio frequencies . . . . .	.56
Remote control . . . . .	.57
Keys . . . . .	.57
Replacing a lost key or remote control . . . . .	.59
<b>MyKey</b>	<b>60</b>
Settings, MyKey . . . . .	.60
Creating . . . . .	.61
Clearing . . . . .	.62
System status . . . . .	.62
Remote start, MyKey . . . . .	.63
Troubleshooting, MyKey . . . . .	.65

<b>Locks</b>	<b>67</b>
Locking and unlocking . . . . .	.67
SecuriCode™ keyless entry keypad . . . . .	.75
<b>Security</b>	<b>77</b>
SecuriLock® passive anti-theft system . . . . .	.77
Anti-theft alarm . . . . .	.79
<b>Steering Wheel</b>	<b>81</b>
Adjusting the steering wheel . . . . .	.81
Steering wheel controls . . . . .	.82
<b>Pedals</b>	<b>84</b>
Adjustable pedals . . . . .	.84
<b>Wipers and Washers</b>	<b>85</b>
Windshield wipers . . . . .	.85
Rain-sensing wipers . . . . .	.85
Windshield washers . . . . .	.86
Rear-window wiper and washer . . . . .	.86
<b>Lighting</b>	<b>87</b>
Lighting control . . . . .	.87
Autolamps . . . . .	.88
Daytime running lamps . . . . .	.89
Front fog lamps . . . . .	.89
Direction indicators . . . . .	.89
Interior lamps . . . . .	.90
<b>Windows and Mirrors</b>	<b>92</b>
Power windows . . . . .	.92
Exterior mirrors . . . . .	.93
Interior mirrors . . . . .	.96
Sun visors . . . . .	.97
Moonroof . . . . .	.98

## Table of Contents 3

---

<b>Instrument Cluster</b>	<b>100</b>
Gauges . . . . .	100
Warning lamps and indicators . . . . .	101
Audible warnings and indicators . . . . .	106
<b>Information Displays</b>	<b>107</b>
Controls . . . . .	107
Information messages . . . . .	113
<b>Climate Control</b>	<b>118</b>
Dual automatic temperature control . . . . .	118
Rear window defroster . . . . .	124
<b>Seats</b>	<b>125</b>
Sitting in the correct position . . . . .	125
Head restraints . . . . .	126
Power seats . . . . .	128
Memory function . . . . .	129
Rear seats . . . . .	133
<b>Universal Garage Door Opener (If Equipped)</b>	<b>143</b>
Car2U® home automation system . . . . .	143
HomeLink® wireless control system . . . . .	148
<b>Auxiliary Power Points</b>	<b>153</b>
<b>Storage Compartments</b>	<b>156</b>
Center console . . . . .	156
Overhead console . . . . .	156
<b>Starting and Stopping the Engine</b>	<b>157</b>
Ignition switch . . . . .	158
Engine block heater . . . . .	161

<b>Fuel and Refueling</b>	<b>163</b>
Fuel quality . . . . .	.164
Refueling . . . . .	.167
Fuel consumption . . . . .	.169
<b>Transmission</b>	<b>174</b>
<b>Four-Wheel Drive (If Equipped)</b>	<b>179</b>
Four wheel drive . . . . .	.179
<b>Brakes</b>	<b>187</b>
Brakes . . . . .	.187
Hints on driving with anti-lock brakes . . . . .	.188
Parking brake . . . . .	.188
<b>Traction Control</b>	<b>189</b>
Traction Control™ . . . . .	.189
<b>Stability Control</b>	<b>190</b>
AdvanceTrac® . . . . .	.191
<b>Parking Aids</b>	<b>192</b>
Sensing system . . . . .	.192
Rear-view camera system . . . . .	.195
<b>Cruise Control</b>	<b>198</b>
Using cruise control . . . . .	.198
<b>Driving Aids</b>	<b>200</b>
Steering . . . . .	.200
Auto leveling suspension . . . . .	.201

## Table of Contents

5

---

<b>Load Carrying</b>	<b>202</b>
Roof racks and load carriers . . . . .	.202
Vehicle loading . . . . .	.203
Cargo management system . . . . .	.210
<b>Towing</b>	<b>213</b>
Trailer towing . . . . .	.213
Wrecker towing . . . . .	.223
Recreational towing . . . . .	.224
<b>Driving Hints</b>	<b>224</b>
Economical driving . . . . .	.225
Floor mats . . . . .	.227
<b>Roadside Emergencies</b>	<b>228</b>
Getting roadside assistance . . . . .	.228
Hazard warning flashers . . . . .	.229
Fuel pump shut-off switch . . . . .	.230
Jump-starting the vehicle . . . . .	.231
<b>Customer Assistance</b>	<b>234</b>
Reporting safety defects (U.S. only) . . . . .	.241
Reporting safety defects (Canada only) . . . . .	.241
<b>Fuses</b>	<b>242</b>
Changing a fuse . . . . .	.242
Fuse specification chart . . . . .	.243

<b>Maintenance</b>	<b>251</b>
General information . . . . .	.251
Opening and closing the hood . . . . .	.252
Under hood overview . . . . .	.253
Engine oil dipstick . . . . .	.254
Engine oil check . . . . .	.254
Engine coolant check . . . . .	.255
Automatic transmission fluid check . . . . .	.260
Brake fluid check . . . . .	.260
Fuel filter . . . . .	.261
Washer fluid check . . . . .	.261
Battery . . . . .	.261
Checking the wiper blades . . . . .	.263
Changing the wiper blades . . . . .	.264
Air filter(s) . . . . .	.265
Adjusting the headlamps . . . . .	.268
Changing a bulb . . . . .	.269
Removing a headlamp . . . . .	.270
<b>Vehicle Care</b>	<b>275</b>
Cleaning products . . . . .	.275
Cleaning the exterior . . . . .	.275
Waxing . . . . .	.277
Repairing minor paint damage . . . . .	.277
Cleaning the engine . . . . .	.277
Cleaning the windows and wiper blades . . . . .	.278
Cleaning the interior . . . . .	.279
Cleaning the instrument panel and instrument cluster lens . . . . .	.280
Cleaning leather seats . . . . .	.281
Cleaning the alloy wheels . . . . .	.281
Vehicle storage . . . . .	.282

## Table of Contents

7

---

<b>Wheels and Tires</b>	<b>284</b>
Tire care . . . . .	.286
Tire Pressure Monitoring System (TPMS) . . . . .	.302
Changing a road wheel . . . . .	.307
Technical specifications . . . . .	.315
Wheel lug nut torque . . . . .	.315
<b>Capacities and Specifications</b>	<b>316</b>
Engine specifications . . . . .	.316
Part numbers . . . . .	.321
Vehicle identification number . . . . .	.321
Vehicle certification label . . . . .	.322
Transmission code designation . . . . .	.323
<b>Accessories</b>	<b>324</b>
Accessories . . . . .	.324
<b>Extended Service Plan</b>	<b>326</b>
<b>Audio System</b>	<b>329</b>
AM/FM/CD with SYNC . . . . .	.331
Rear seat controls . . . . .	.334
Satellite radio information . . . . .	.337
Auxiliary input jack . . . . .	.340
USB port . . . . .	.341
Rear seat entertainment system . . . . .	.342
<b>SYNC®</b>	<b>361</b>
Pairing your phone for the first time . . . . .	.366
911 Assist™ . . . . .	.381
Vehicle Health Report . . . . .	.384

<b>Navigation System (If Equipped)</b>	<b>410</b>
Status bars . . . . .	.413
Loading pictures . . . . .	.414
Voice recognition . . . . .	.415
Accessing media features . . . . .	.420
Jukebox features . . . . .	.438
Recording (saving) music to your jukebox . . . . .	.438
Accessing the music in your jukebox . . . . .	.438
Creating a playlist . . . . .	.440
Where am I? . . . . .	.441
Accessing the help screen . . . . .	.444
Navigation features . . . . .	.445
<b>Appendices</b>	<b>466</b>
Navigation end user license agreement . . . . .	.473
<b>Scheduled Maintenance</b>	<b>478</b>
Normal scheduled maintenance and log . . . . .	.483
<b>Index</b>	<b>495</b>

The information contained in this publication was correct at the time of going to print. In the interest of continuous development, we reserve the right to change specifications, design or equipment at any time without notice or obligation. No part of this publication may be reproduced, transmitted, stored in a retrieval system or translated into any language in any form by any means without our written permission. Errors and omissions excepted.

© Ford Motor Company 2014

**ABOUT THIS MANUAL**

Thank you for choosing Ford. We recommend that you take some time to get to know your vehicle by reading this manual. The more that you know about it, the greater the safety and pleasure you will get from driving it.



**WARNING:** Always drive with due care and attention when using and operating the controls and features on your vehicle.

**Note:** This manual describes product features and options available throughout the range of available models, sometimes even before they are generally available. It may describe options not fitted to your vehicle.

**Note:** Some of the illustrations in this manual may be used for different models, so may appear different to you on your vehicle. However, the essential information in the illustrations is always correct.

**Note:** Always use and operate your vehicle in line with all applicable laws and regulations.

**Note:** Pass on this manual when selling your vehicle. It is an integral part of the vehicle.

This manual may qualify the location of a component as left-hand side or right-hand side. The side is determined when facing forward in the seat.

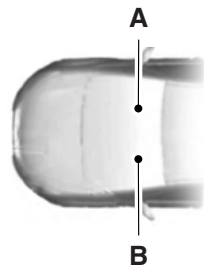

A. Right-hand side

B. Left-hand side

























**Protecting the Environment**





















You must play your part in protecting the environment. Correct vehicle usage and the authorized disposal of waste, cleaning and lubrication materials are significant steps toward this aim.

## SYMBOL GLOSSARY

 **WARNING:** You risk death or serious injury to yourself and others if you do not follow the instruction highlighted by the warning symbol.

These are some of the symbols you may see on your vehicle.

Symbol	Description	Symbol	Description	Symbol	Description
	Safety alert		See Owner's Manual		Anti-lock braking system
	Avoid smoking, flames, or sparks		Battery		Battery acid
	Brake fluid – non petroleum base		Brake system		Cabin air filter
	Check fuel cap		Child Safety Door Lock and Unlock		Child seat lower anchor
	Child seat tether anchor		Cruise control		Do not open when hot
	Engine air filter		Engine coolant		Engine coolant temperature
	Engine oil		Explosive gas		Fan warning
	Fasten safety belt		Front airbag		Front fog lamps

Symbol	Description	Symbol	Description	Symbol	Description
	Fuel pump reset		Fuse compartment		Hazard warning flasher
	Heated rear window		Interior luggage compartment release		Jack
	Lighting control		Low tire pressure warning		Maintain correct fluid level
	Panic alarm		Parking aid system		Parking brake system
	Power steering fluid		Power windows front and rear		Power window lockout
	Service engine soon		Side airbag		Stability control
	Windshield defrost and demist		Windshield washer and wiper		

**DATA RECORDING****Service Data Recording**

Service data recorders in your vehicle are capable of collecting and storing diagnostic information about your vehicle. This potentially includes information about the performance or status of various systems and modules in the vehicle, such as engine, throttle, steering or brake systems. In order to properly diagnose and service your vehicle, Ford Motor Company, Ford of Canada, and service and repair facilities may access or share among them vehicle diagnostic information received through a direct connection to your vehicle when diagnosing or servicing your vehicle. Additionally, when your vehicle is in for service or repair, Ford Motor Company, Ford of Canada, and service and repair facilities may access or share among them data for vehicle improvement purposes. For U.S. only (if equipped), if you choose to use the SYNC® Vehicle Health Report, you consent that certain diagnostic information may also be accessed electronically by Ford Motor Company and Ford authorized service facilities, and that the diagnostic information may be used for any purpose. See the *SYNC®* chapter for more information.

**Event Data Recording**

**This vehicle is equipped with an event data recorder (EDR). The main purpose of an EDR is to record, in certain crash or near crash-like situations, such as an airbag deployment or hitting a road obstacle; this data will assist in understanding how a vehicle's systems performed. The EDR is designed to record data related to vehicle dynamics and safety systems for a short period of time, typically 30 seconds or less. The EDR in this vehicle is designed to record such data as:**

- **How various systems in your vehicle were operating;**
- **Whether or not the driver and passenger safety belts were buckled/fastened;**
- **How far (if at all) the driver was depressing the accelerator and/or the brake pedal;**
- **How fast the vehicle was travelling;**
- **Where the driver was positioning the steering wheel.**

**This data can help provide a better understanding of the circumstances in which crashes and injuries occur.**

**Note:** EDR data is recorded by your vehicle only if a non-trivial crash situation occurs; no data is recorded by the EDR under normal driving conditions and no personal data or information (e.g., name, gender, age, and crash location) is recorded (see limitations regarding 911 Assist and Traffic, Directions and Information privacy below). However, parties, such as law enforcement, could combine the EDR data with the type of personally identifying data routinely acquired during a crash investigation.

To read data recorded by an EDR, special equipment is required, and access to the vehicle or the EDR is needed. In addition to the vehicle manufacturer, other parties, such as law enforcement, that have such special equipment, can read the information if they have access to the vehicle or the EDR. Ford Motor Company and Ford of Canada do not access event data recorder information without obtaining consent, unless pursuant to court order or where required by law enforcement, other government authorities or other third parties acting with lawful authority. Other parties may seek to access the information independently of Ford Motor Company and Ford of Canada.

**Note:** Including to the extent that any law pertaining to Event Data Recorders applies to SYNC® or its features, please note the following: Once 911 Assist (if equipped) is enabled (set ON), 911 Assist may, through any paired and connected cell phone, disclose to emergency services that the vehicle has been in a crash involving the deployment of an airbag or, in certain vehicles, the activation of the fuel pump shut-off. Certain versions or updates to 911 Assist may also be capable of being used to electronically or verbally provide to 911 operators the vehicle location (such as latitude and longitude), and/or other details about the vehicle or crash or personal information about the occupants to assist 911 operators to provide the most appropriate emergency services. If you do not want to disclose this information, do not activate the 911 Assist feature. See your SYNC® chapter for more information.

Additionally, when you connect to Traffic, Directions and Information (if equipped, U.S. only), the service uses GPS technology and advanced vehicle sensors to collect the vehicle's current location, travel direction, and speed ("vehicle travel information"), only to help provide you with the directions, traffic reports, or business searches that you request. If you do not want Ford or its vendors to receive this information, do not activate the service. For more information, see Traffic, Directions and Information, Terms and Conditions. See your SYNC® chapter for more information.

**CALIFORNIA PROPOSITION 65**

**WARNING:** Some constituents of engine exhaust, certain vehicle components, certain fluids contained in vehicles and certain products of component wear contain or emit chemicals known to the State of California to cause cancer and birth defects or other reproductive harm.

**PERCHLORATE MATERIAL**

**Note:** Certain components in your vehicle, such as airbag modules, safety belt pretensioners, and remote control batteries, may contain perchlorate material. Special handling may apply for service or vehicle end of life disposal. See [www.dtsc.ca.gov/hazardouswaste/perchlorate](http://www.dtsc.ca.gov/hazardouswaste/perchlorate) for more information.

**FORD CREDIT (U.S. ONLY)**

Ford Credit offers a full range of financing and lease plans to help you acquire your vehicle. If you have financed or leased your vehicle through Ford Credit, thank you for your business.

For your convenience, we offer a number of ways to contact us, as well as help manage your account.

Phone: 1-800-727-7000

For more information regarding Ford Credit, as well as access to Account Manager, please go to [www.fordcredit.com](http://www.fordcredit.com).

**REPLACEMENT PARTS RECOMMENDATION**

Your vehicle has been built to the highest standards using quality parts. We recommend that you demand the use of genuine Ford and Motorcraft parts whenever your vehicle requires scheduled maintenance or repair. You can clearly identify genuine Ford and Motorcraft parts by looking for the Ford, FoMoCo or Motorcraft branding on the parts or their packaging.

**Scheduled Maintenance and Mechanical Repairs**

One of the best ways for you to make sure that your vehicle provides years of service is to have it maintained in line with our recommendations using parts that conform to the specifications detailed in this owner's manual. Genuine Ford and Motorcraft parts meet or exceed these specifications.

**Collision Repairs**

We hope that you never experience a collision, but accidents do happen. Genuine Ford replacement collision parts meet our stringent requirements for fit, finish, structural integrity, corrosion protection and dent resistance. During vehicle development, we validate that these parts deliver the intended level of protection as a whole system. A great way to know for sure you are getting this level of protection is to use genuine Ford replacement collision parts.

**Warranty on Replacement Parts**

Genuine Ford and Motorcraft replacement parts are the only replacement parts that benefit from a Ford Warranty. Damage caused to your vehicle as a result of the failure of non-Ford parts may not be covered by the Ford Warranty. For additional information, see the terms and conditions of the Ford Warranty.

**SPECIAL NOTICES****New Vehicle Limited Warranty**

For a detailed description of what is covered and what is not covered by your vehicle's New Vehicle Limited Warranty, see the warranty information that is provided to you along with your owner's manual.

**Special Instructions**

For your added safety, your vehicle is fitted with sophisticated electronic controls.



**WARNING:** Please read the *Supplementary Restraints System* chapter. Failure to follow the specific warnings and instructions could result in personal injury.



**WARNING:** Front seat mounted rear-facing child or infant seats should **NEVER** be placed in front of an active passenger airbag.

**Using your vehicle with a snowplow****Do not use this vehicle for snowplowing.**

Your vehicle is not equipped with a snowplowing package.

**Using your vehicle as an ambulance****Do not use this vehicle as an ambulance.**

Your vehicle is not equipped with the Ford Ambulance Preparation Package.

**MOBILE COMMUNICATIONS EQUIPMENT**

Using mobile communications equipment is becoming increasingly important in the conduct of business and personal affairs. However, you must not compromise your own or others' safety when using such equipment. Mobile communications can enhance personal safety and security when appropriately used, particularly in emergency situations. Safety must be paramount when using mobile communications equipment to avoid negating these benefits.

Mobile communication equipment includes, but is not limited to, cellular phones, pagers, portable email devices, text messaging devices and portable two-way radios.



**WARNING:** Driving while distracted can result in loss of vehicle control, crash and injury. We strongly recommend that you use extreme caution when using any device that may take your focus off the road. Your primary responsibility is the safe operation of your vehicle. We recommend against the use of any handheld device while driving and encourage the use of voice-operated systems when possible. Make sure you are aware of all applicable local laws that may affect the use of electronic devices while driving.

**EXPORT UNIQUE (NON-UNITED STATES/CANADA) VEHICLE SPECIFIC INFORMATION**

For your particular global region, your vehicle may be equipped with features and options that are different from the features and options that are described in this owner's manual. A market unique supplement may be supplied that complements this book. By referring to the market unique supplement, if provided, you can properly identify those features, recommendations and specifications that are unique to your vehicle. This owner's manual is written primarily for the U.S. and Canadian Markets. Features or equipment listed as standard may be different on units built for Export. **See this owner's manual for all other required information and warnings.**

**GENERAL INFORMATION**

See the following sections for directions on how to properly use safety restraints for children.



**WARNING:** Always make sure your child is secured properly in a device that is appropriate for their height, age and weight. Child safety restraints must be bought separately from your vehicle. Failure to follow these instructions and guidelines may result in an increased risk of serious injury or death to your child.



**WARNING:** All children are shaped differently. The recommendations for safety restraints are based on probable child height, age and weight thresholds from NHTSA and other safety organizations, or are the minimum requirements of law. Ford recommends checking with a NHTSA Certified Child Passenger Safety Technician (CPST) and consulting your pediatrician to make sure your child seat is appropriate for your child, and is compatible with and properly installed in your vehicle. To locate a child seat fitting station and CPST, contact the NHTSA toll free at 1-888-327-4236 or on the internet at <http://www.nhtsa.dot.gov>. In Canada, check with your local St. John Ambulance office for referral to a CPST or for further information, contact your provincial ministry of transportation, or locate your local St. John Ambulance office by searching for St. John Ambulance on the internet, or Transport Canada at 1-800-333-0371 (<http://www.tc.gc.ca>). Failure to properly restrain children in safety seats made especially for their height, age, and weight may result in an increased risk of serious injury or death to your child.

<b>Recommendations for Safety Restraints for Children</b>		
	<b>Child size, height, weight, or age</b>	<b>Recommended restraint type</b>
Infants or toddlers	Children weighing 40 lb (18 kg) or less (generally age four or younger).	Use a child safety seat (sometimes called an infant carrier, convertible seat, or toddler seat).
Small children	Children who have outgrown or no longer properly fit in a child safety seat (generally children who are less than 4 ft. 9 in. (1.45 m) tall, are greater than age four (4) and less than age twelve (12), and between 40 lb (18 kg) and 80 lb (36 kg) and upward to 100 lb (45 kg) if recommended by your child restraint manufacturer).	Use a belt-positioning booster seat.
Larger children	Children who have outgrown or no longer properly fit in a belt-positioning booster seat (generally children who are at least 4 ft. 9 in. (1.45 m) tall or greater than 80 lb (36 kg) or 100 lb (45 kg) if recommended by child restraint manufacturer).	Use a vehicle safety belt having the lap belt snug and low across the hips, shoulder belt centered across the shoulder and chest, and seat back upright.

- You are required by law to properly use safety seats for infants and toddlers in the U.S. and Canada.
- Many states and provinces require that small children use approved booster seats until they reach age eight, a height of 4 feet 9 inches (1.45 meters) tall, or 80 pounds (36 kilograms). Check your local and state or provincial laws for specific requirements about the safety of children in your vehicle.
- When possible, always properly restrain children twelve (12) years of age and under in a rear seating position of your vehicle. Accident statistics suggest that children are safer when properly restrained in the rear seating positions than in a front seating position.

**CHILD SEAT POSITIONING**

**WARNING:** Airbags can kill or injure a child in a child seat.

Never place a rear-facing child seat in front of an active airbag. If you must use a forward-facing child seat in the front seat, move the vehicle seat upon which the child seat is installed all the way back. When possible, all children age 12 and under should be properly restrained in a rear seating position. If all children cannot be seated and restrained properly in a rear seating position, properly restrain the largest child in the front seat.



**WARNING:** Always carefully follow the instructions and warnings provided by the manufacturer of any child restraint to determine if the restraint device is appropriate for your child's size, height, weight, or age. Follow the child restraint manufacturer's instructions and warnings provided for installation and use in conjunction with the instructions and warnings provided by your vehicle manufacturer. A safety seat that is improperly installed or utilized, is inappropriate for your child's height, age or weight, or does not properly fit the child, may increase the risk of serious injury or death.



**WARNING:** Never let a passenger hold a child on his or her lap while your vehicle is moving. The passenger cannot protect the child from injury in a crash, which may result in serious injury or death.



**WARNING:** Never use pillows, books, or towels to boost a child. They can slide around and increase the likelihood of injury or death in a crash.



**WARNING:** Always restrain an unoccupied child seat or booster seat. These objects may become projectiles in a crash or sudden stop, which may increase the risk of serious injury.



**WARNING:** Never place, or allow a child to place, the shoulder belt under a child's arm or behind the back because it reduces the protection for the upper part of the body and may increase the risk of injury or death in a crash.



**WARNING:** To avoid risk of injury, do not leave children or pets unattended in your vehicle.

### Recommendations for attaching child safety restraints for children

Restraint Type	Combined weight of child and child seat	Use any attachment method as indicated below by X.				
		LATCH (lower anchors and top tether anchor)	LATCH (lower anchors only)	Safety belt and top tether anchor	Safety belt and LATCH (lower anchors and top tether anchor)	Safety belt only
Rear-facing child seat	Up to 65 lb (29.5 kg)		X			X
Rear-facing child seat	Over 65 lb (29.5 kg)					X
Forward-facing child seat	Up to 65 lb (29.5 kg)	X		X	X	
Forward-facing child seat	Over 65 lb (29.5 kg)			X	X	

**Note:** The child seat must rest tightly against the vehicle seat upon which it is installed. It may be necessary to lift or remove the head restraint. See the *Seats* chapter for information on head restraints.

**BOOSTER SEATS**

**WARNING:** Never place, or allow a child to place, the shoulder belt under a child's arm or behind the back because it reduces the protection for the upper part of the body and may increase the risk of injury or death in a crash.

Use a belt-positioning booster seat for children who have outgrown or no longer properly fit in a child safety seat (generally children who are less than 4 feet 9 inches (1.45 meters) tall, are greater than age four (4) and less than age twelve (12), and between 40 pounds (18 kilograms) and 80 pounds (36 kilograms) and upward to 100 pounds (45 kilograms) if recommended by your child restraint manufacturer). Many state and provincial laws require that children use approved booster seats until they reach age eight (8), a height of 4 feet 9 inches (1.45 meters) tall, or 80 pounds (36 kilograms).

Booster seats should be used until you can answer YES to ALL of these questions when the child is seated without a booster seat.

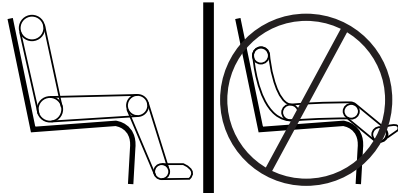

- Can the child sit all the way back against their vehicle seat with knees bent comfortably at the edge of the seat cushion?
- Can the child sit without slouching?

- Does the lap belt rest low across the hips?
- Is the shoulder belt centered on the shoulder and chest?
- Can the child stay seated like this for the whole trip?

Always use booster seats in conjunction with your vehicle lap and shoulder belt.

**Types of Booster Seats**

- Backless booster seats

If your backless booster seat has a removable shield, remove the shield. If a vehicle seating position has a low seat back or no head restraint, a backless booster seat may place your child's head (as measured at the tops of the ears) above the top of the seat. In this case, move the backless booster to another seating position with a higher seat back or head restraint and lap and shoulder belts, or consider using a high back booster seat.



- High back booster seats

If, with a backless booster seat, you cannot find a seating position that adequately supports your child's head, a high back booster seat would be a better choice.

Children and booster seats vary in size and shape. Choose a booster that keeps the lap belt low and snug across the hips, never up across the stomach, and lets you adjust the shoulder belt to cross the chest and rest snugly near the center of the shoulder. The following drawings compare the ideal fit (center) to a shoulder belt uncomfortably close to the neck and a shoulder belt that could slip off the shoulder. The drawings also show how the lap belt should be low and snug across the child's hips.

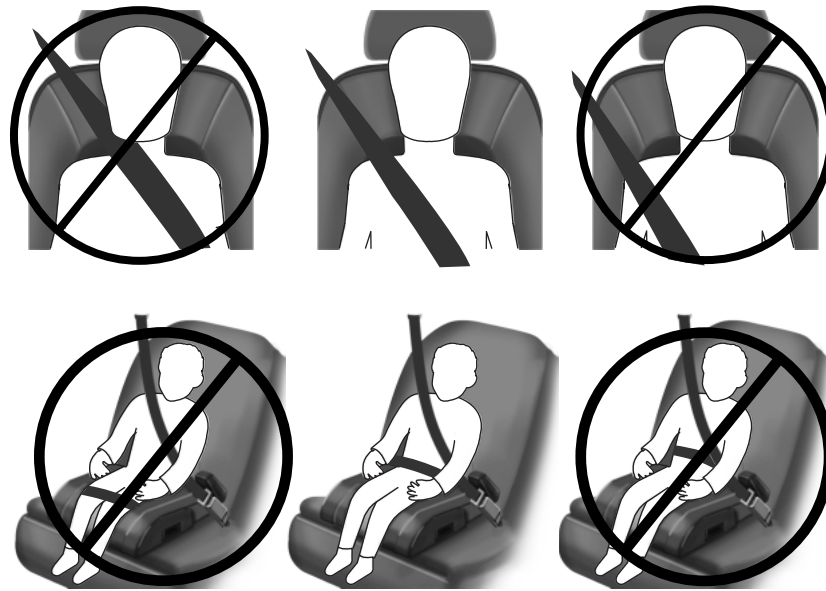

If the booster seat slides on the vehicle seat upon which it is being used, placing a rubberized mesh sold as shelf or carpet liner under the booster seat may improve this condition. Do not introduce any item thicker than this under the booster seat. Check with the booster seat manufacturer's instructions.

## INSTALLING CHILD SEATS

### Child Seats



Use a child safety seat (sometimes called an infant carrier, convertible seat, or toddler seat) for infants, toddlers or children weighing 40 pounds (18 kilograms) or less (generally age four or younger).

### Using Lap and Shoulder Belts



**WARNING:** Airbags can kill or injure a child in a child seat.

Never place a rear-facing child seat in front of an active airbag.

If you must use a forward-facing child seat in the front seat, move the seat upon which the child seat is installed all the way back.



**WARNING:** Airbags can kill or injure a child in a child seat.

Children 12 and under should be properly restrained in the rear seat whenever possible.



**WARNING:** Depending on where you secure a child restraint, and depending on the child restraint design, you may block access to certain safety belt buckle assemblies or LATCH lower anchors, rendering those features potentially unusable. To avoid risk of injury, occupants should only use seating positions where they are able to be properly restrained.

When installing a child safety seat with combination lap/shoulder belts:

- Use the correct safety belt buckle for that seating position.
- Insert the belt tongue into the proper buckle until you hear a snap and feel it latch. Make sure the tongue is securely fastened in the buckle.
- Keep the buckle release button pointing up and away from the safety seat, with the tongue between the child seat and the release button, to prevent accidental unbuckling.

- Place the vehicle seat upon which the child seat will be installed in the upright position.
- Put the safety belt in the automatic locking mode. See Step 5. This vehicle does not require the use of a locking clip.

Perform the following steps when installing the child seat with combination lap and shoulder belts:

**Note:** Although the child seat illustrated is a forward facing child seat, the steps are the same for installing a rear facing child seat.



1. Position the child safety seat in a seat with a combination lap and shoulder belt.

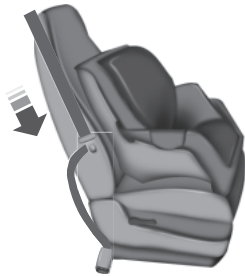

2. Pull down on the shoulder belt and then grasp the shoulder belt and lap belt together.

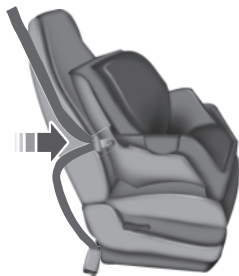

3. While holding the shoulder and lap belt portions together, route the tongue through the child seat according to the child seat manufacturer's instructions. Be sure the belt webbing is not twisted.



4. Insert the belt tongue into the proper buckle (the buckle closest to the direction the tongue is coming from) for that seating position until you hear a snap and feel the latch engage. Make sure the tongue is latched securely by pulling on it.



5. To put the retractor in the automatic locking mode, grasp the shoulder portion of the belt and pull downward until all of the belt is pulled out.

**Note:** The automatic locking mode is available on the front passenger and rear seats. This vehicle does not require the use of a locking clip.

6. Allow the belt to retract to remove slack. The belt will click as it retracts to indicate it is in the automatic locking mode.

7. Try to pull the belt out of the retractor to make sure the retractor is in the automatic locking mode (you should not be able to pull more belt out). If the retractor is not locked, unbuckle the belt and repeat Steps 5 and 6.

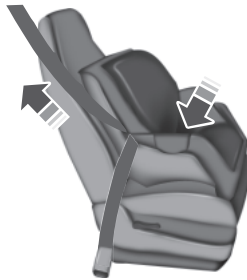

8. Remove remaining slack from the belt. Force the seat down with extra weight, for example, by pressing down or kneeling on the child restraint while pulling up on the shoulder belt in order to force slack from the belt.

This is necessary to remove the remaining slack that will exist once the extra weight of the child is added to the child restraint. It also helps to achieve the proper snugness of the child seat to your vehicle. Sometimes, a slight lean toward the buckle will provide extra help to remove remaining slack from the belt.

9. Attach the tether strap (if the child seat is equipped). See *Using Tether Straps* in this chapter.

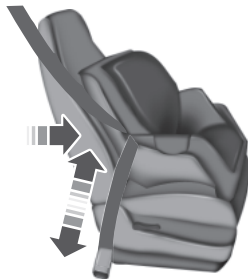

10. Before placing the child in the seat, forcibly move the seat forward and back to make sure the seat is securely held in place.

To check this, grab the seat at the belt path and attempt to move it side to side and forward and back. There should be no more than 1 inch (2.5 centimeters) of movement for proper installation.

Ford recommends checking with a NHTSA Certified Child Passenger Safety Technician to make certain the child restraint is properly installed. In Canada, check with your local St. John Ambulance office for referral to a Child Passenger Safety Technician.

**Using Lower Anchors and Tethers for Children (LATCH)**

**!** **WARNING:** Never attach two child safety seats to the same anchor. In a crash, one anchor may not be strong enough to hold two child safety seat attachments and may break, causing serious injury or death.

The LATCH system is composed of three vehicle anchor points: two lower anchors located where the vehicle seat back and seat cushion meet (called the seat bight) and one top tether anchor located behind that seating position.

LATCH compatible child safety seats have two rigid or webbing mounted attachments that connect to the two lower anchors at the LATCH equipped seating positions in your vehicle. This type of attachment method eliminates the need to use safety belts to attach the child seat, however the safety belt can still be used to attach the child seat. For forward-facing child seats, the top tether strap must also be attached to the proper top tether anchor, if a top tether strap has been provided with your child seat. Ford Motor Company recommends the use of a child safety seat having a top tether strap. See *Using Tether Straps* in this chapter.

Your vehicle has LATCH lower anchors for child seat installation at the seating positions marked with the child seat symbol.

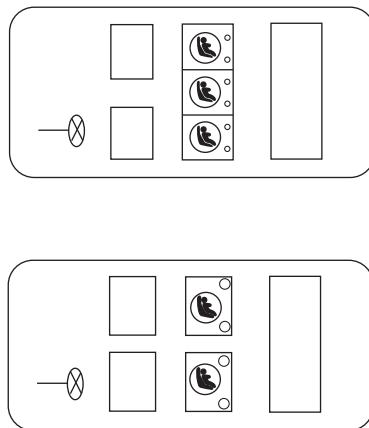

The LATCH anchors are located at the rear section of the rear seat between the cushion and seat back, below the locator symbols on the seat back. Follow the child seat manufacturer's instructions to properly install a child seat with LATCH attachments.



The locator symbols are on round plastic buttons for the center seat and on rectangular tags for the outboard seats.

Follow the instructions on attaching child safety seats with tether straps. See *Using Tether Straps* in this chapter.

Attach LATCH lower attachments of the child seat only to the anchors shown.

Each time you use the safety seat, check that the seat is properly attached to the lower anchors and tether anchor, if applicable. Tug the child seat from side to side and forward and back where it is secured to the vehicle. The seat should move less than one inch when you do this for a proper installation.

If the safety seat is not anchored properly, the risk of a child being injured in a crash greatly increases.

### ***Combining Safety Belt and LATCH Lower Anchors for Attaching Child Safety Seats***

When used in combination, either the safety belt or the LATCH lower anchors may be attached first, provided a proper installation is achieved. Attach the tether strap afterward, if included with the child seat.

### **Using Tether Straps**



Many forward-facing child safety seats include a tether strap which extends from the back of the child safety seat and hooks to an anchoring point called the top tether anchor.

Tether straps are available as an accessory for many older safety seats. Contact the manufacturer of your child seat for information about ordering a tether strap, or to obtain a longer tether strap if the tether strap on your safety seat does not reach the appropriate top tether anchor in the vehicle.

Some of the rear seats of your vehicle are equipped with built-in tether strap anchors located behind the seats as described below.

In the third row center seating position, the tether anchor is a loop at the bottom of the seat back.

The tether strap anchors in your vehicle are in the following positions (shown from top view).

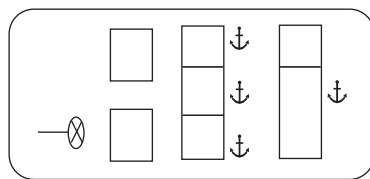

- Second row bench seat

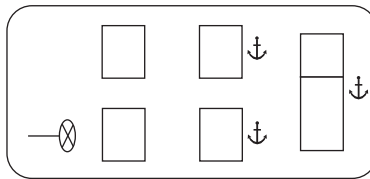

- Second row bucket seats

Attach the tether strap only to the appropriate tether anchor as shown. The tether strap may not work properly if attached somewhere other than the correct tether anchor.

Once the child safety seat has been installed using either the safety belt, the lower anchors of the LATCH system, or both, you can attach the top tether strap.

If you install a child seat with rigid LATCH attachments, and have attached the top tether strap to the proper top tether anchor, do not tighten the tether strap enough to lift the child seat off the vehicle seat cushion when the child is seated in it. Keep the tether strap just snug without lifting the front of the child seat. Keeping the child seat just touching the vehicle seat gives the best protection in a severe crash.

Perform the following steps to install a child safety seat with tether anchors:

### Second row seating positions

1. For center seating positions, route the child safety seat tether strap over the back of the seat.

For outboard seating positions, route the tether strap under the head restraint and between the head restraint posts. If the top of the safety seat hits the head restraint, recline the seat back slightly to obtain proper fit.

2. Locate the correct anchor for the selected seating position.

- Second row outboard seating positions

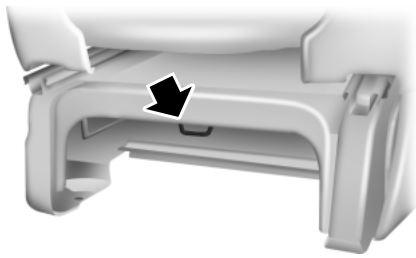

- Second row center seating position (if equipped)



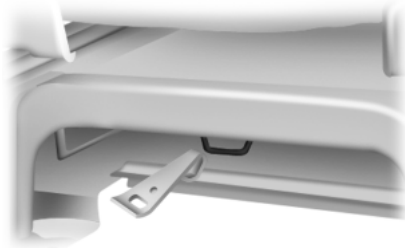

3. Grasp the tether strap and position it to the seat frame.

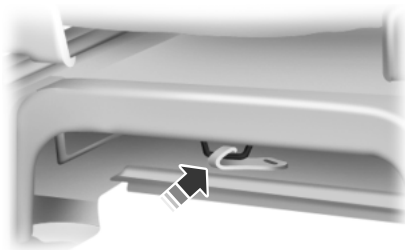

4. Rotate the tether strap, and clip the tether strap to the anchor on the seat frame.

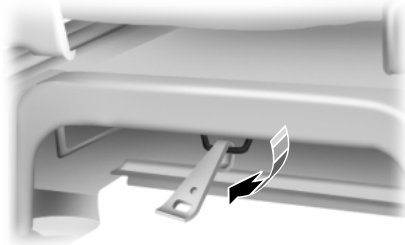

5. Rotate the tether strap clip.

6. Tighten the child safety seat tether strap according to the manufacturer's instructions.

### Third row center seating position

1. Route the child safety seat tether strap over the back of the seat.



2. Locate the anchor webbing loop for the seating position.



- You may need to pull back the top of the hinged panel along the bottom of the seat back to access the tether anchor.

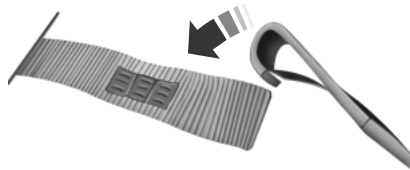

3. Clip the tether strap through the anchor loop as shown. If the tether strap is clipped incorrectly, the child safety seat may not be retained properly in the event of a crash.

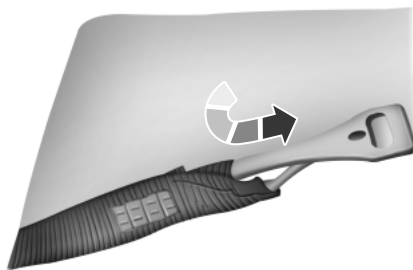

4. Tighten the child safety seat tether strap according to the manufacturer's instructions. If the safety seat is not anchored properly, the risk of a child being injured in a crash greatly increases.

If your child restraint system is equipped with a tether strap, and the child restraint manufacturer recommends its use, Ford also recommends its use.

### CHILD SAFETY LOCKS

When these locks are set, the rear doors cannot be opened from the inside.



The childproof locks are located on the rear edge of each rear door and must be set separately for each door.

Move the lock control up to engage the childproof lock.

Move it down to disengage the lock.

---

**PRINCIPLES OF OPERATION**

**WARNING:** Always drive and ride with your seat back upright and the lap belt snug and low across the hips.



**WARNING:** To reduce the risk of injury, make sure children sit where they can be properly restrained.



**WARNING:** Never let a passenger hold a child on his or her lap while the vehicle is moving. The passenger cannot protect the child from injury in a crash.



**WARNING:** All occupants of the vehicle, including the driver, should always properly wear their safety belts, even when an airbag supplemental restraint system is provided. Failure to properly wear your safety belt could seriously increase the risk of injury or death.



**WARNING:** It is extremely dangerous to ride in a cargo area, inside or outside of a vehicle. In a crash, people riding in these areas are more likely to be seriously injured or killed. Do not allow people to ride in any area of your vehicle that is not equipped with seats and safety belts. Be sure everyone in your vehicle is in a seat and using a safety belt properly.





**WARNING:** In a rollover crash, an unbelted person is significantly more likely to die than a person wearing a safety belt.



**WARNING:** Each seating position in your vehicle has a specific safety belt assembly which is made up of one buckle and one tongue that are designed to be used as a pair. 1) Use the shoulder belt on the outside shoulder only. Never wear the shoulder belt under the arm. 2) Never swing the safety belt around your neck over the inside shoulder. 3) Never use a single belt for more than one person.



 **WARNING:** When possible, all children 12 years old and under should be properly restrained in a rear seating position. Failure to follow this could seriously increase the risk of injury or death.

 **WARNING:** Safety belts and seats can become hot in a vehicle that has been closed up in sunny weather; they could burn a small child. Check seat covers and buckles before you place a child anywhere near them.

 **WARNING:** Front and rear seat occupants, including pregnant women, should wear safety belts for optimum protection in an accident.

All seating positions in this vehicle have lap and shoulder safety belts. All occupants of the vehicle should always properly wear their safety belts, even when an airbag supplemental restraint system is provided.

The safety belt system consists of:

- Lap and shoulder safety belts.
- Shoulder safety belt with automatic locking mode, (except driver safety belt).
- Height adjuster at the front outboard seating positions.
- Safety belt pretensioner at the front outboard seating positions.
-  • Safety belt warning light and chime. See *Safety Belt Warning Light and Indicator Chime* later in this chapter.
-  • Crash sensors and monitoring system with readiness indicator. See *Crash Sensors and Airbag Indicator* in the *Supplemental Restraints System* chapter.

The safety belt pretensioners are designed to activate in frontal, near-frontal and side crashes, and in rollovers. The safety belt pretensioners at the front seating positions are designed to tighten the safety belts firmly against the occupant's body when activated. This helps increase the effectiveness of the safety belts. In frontal crashes, the safety belt pretensioners can be activated alone or, if the crash is of sufficient severity, together with the front airbags.

**FASTENING THE SAFETY BELTS**

The front outboard and rear safety restraints in your vehicle are combination lap and shoulder belts.

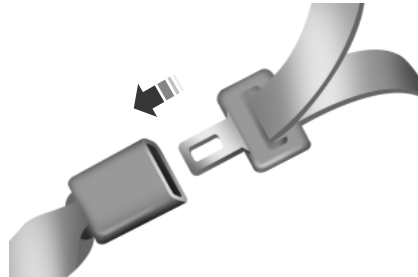

1. Insert the belt tongue into the proper buckle (the buckle closest to the direction the tongue is coming from) until you hear a snap and feel it latch. Make sure the tongue is securely fastened in the buckle.

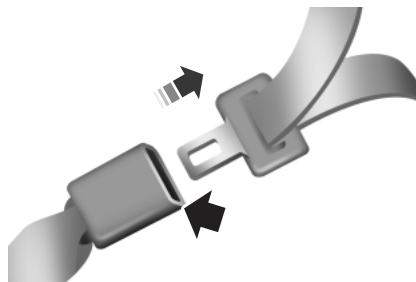

2. To unfasten, press the release button and remove the tongue from the buckle.

**Using Safety Belts During Pregnancy**

**WARNING:** Always ride and drive with your seatback upright and the safety belt properly fastened. The lap portion of the safety belt should fit snug and be positioned low across the hips. The shoulder portion of the safety belt should be positioned across the chest. Pregnant women should also follow this practice. See the following figure.

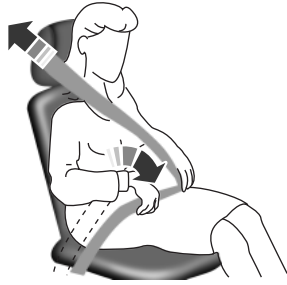

Pregnant women should always wear their safety belts. The lap belt portion of a combination lap and shoulder belt should be positioned low across the hips below the belly and worn as tight as comfort will allow. The shoulder belt should be positioned to cross the middle of the shoulder and the center of the chest.

### Safety Belt Locking Modes



**WARNING:** After any vehicle crash, the safety belt system at all passenger seating positions must be checked by an authorized dealer to verify that the automatic locking retractor feature for child seats is still functioning properly. In addition, all safety belts should be checked for proper function.



**WARNING:** The belt and retractor assembly must be replaced if the safety belt assembly automatic locking retractor feature or any other safety belt function is not operating properly when checked by an authorized dealer. Failure to replace the belt and retractor assembly could increase the risk of injury in crashes.

All safety restraints in the vehicle are combination lap and shoulder belts. The driver safety belt has the first type of locking mode. The front outboard passenger and rear seat safety belts have both types of locking modes described as follows:

#### **Vehicle Sensitive Mode**

This is the normal retractor mode, which allows free shoulder belt length adjustment to your movements and locking in response to vehicle movement. For example, if the driver brakes suddenly or turns a corner sharply, or the vehicle receives an impact of about 5 mph (8 km/h) or more, the combination safety belts will lock to help reduce forward movement of the driver and passengers.

In addition, the retractor is designed to lock if the webbing is pulled out too quickly. If this occurs, let the belt retract slightly and pull webbing out again in a slow and controlled manner.

**Automatic Locking Mode**

In this mode, the shoulder belt is automatically pre-locked. The belt will still retract to remove any slack in the shoulder belt. The automatic locking mode is not available on the driver safety belt.

**When to Use the Automatic Locking Mode**

This mode should be used any time a child safety seat, except a booster, is installed in passenger front or rear seating positions. Children 12 years old and under should be properly restrained in a rear seating position whenever possible. See the *Child Safety* chapter.

**How to Use the Automatic Locking Mode**

1. Buckle the combination lap and shoulder belt.
2. Grasp the shoulder portion and pull downward until the entire belt is pulled out.
3. Allow the belt to retract. As the belt retracts, you will hear a clicking sound. This indicates the safety belt is now in the automatic locking mode.

**How to Disengage the Automatic Locking Mode**

Unbuckle the combination lap and shoulder belt and allow it to retract completely to disengage the automatic locking mode and activate the vehicle sensitive (emergency) locking mode.

**Safety Belt Extension Assembly**

**WARNING:** Do not use extensions to change the fit of the shoulder belt across the torso.

If the safety belt is too short when fully extended, you can obtain a safety belt extension assembly from an authorized dealer.

Use only extensions manufactured by the same supplier as the safety belt. Manufacturer identification is located at the end of the webbing on the label or on the retractor behind the trim. Also, use the safety belt extension only if the safety belt is too short for you when fully extended.

### SAFETY BELT HEIGHT ADJUSTMENT

 **WARNING:** Position the safety belt height adjusters so that the belt rests across the middle of your shoulder. Failure to adjust the safety belt properly could reduce the effectiveness of the seat belt and increase the risk of injury in a crash.

Adjust the height of the shoulder belt so the belt rests across the middle of your shoulder.

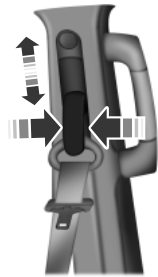

To adjust the shoulder belt height:

1. Squeeze the side release buttons and slide the height adjuster up or down.
2. Pull down on the height adjuster to make sure it is locked in place.

### Second Row Comfort Guide

 **WARNING:** Position the safety belt comfort guide so that the belt rests across the middle of your shoulder. Failure to adjust the safety belt properly could reduce the effectiveness of the safety belt and increase the risk of injury in a crash.

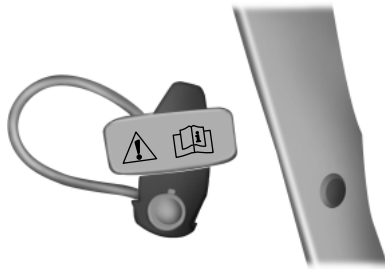

The second row outboard lap and shoulder belt is equipped with a belt comfort guide. This guide is attached to the quarter trim panel. Use it to adjust the comfort of the shoulder belt for smaller occupants in the outboard second row seats.

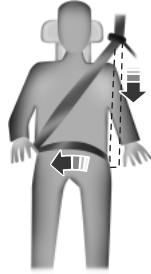

To adjust the comfort guide:

1. Slip the shoulder belt into the belt guide (the portion of the belt between the latch tongue and the D-ring, not the portion where the belt exits from the quarter trim panel).

2. Slide the guide up or down along the webbing so that the belt is centered on the occupant's shoulder.

#### SAFETY BELT WARNING LIGHT AND INDICATOR CHIME



This lamp illuminates and an audible warning will sound if the driver's safety belt has not been fastened when the vehicle's ignition is turned on.

#### Conditions of Operation

If...	Then...
The driver safety belt is not buckled before the ignition switch is turned to the on position...	The safety belt warning light illuminates 1-2 minutes and the warning chime sounds 4-8 seconds.
The driver safety belt is buckled while the indicator light is illuminated and the warning chime is sounding...	The safety belt warning light and warning chime turn off.
The driver safety belt is buckled before the ignition switch is turned to the on position...	The safety belt warning light and indicator chime remain off.

**SAFETY BELT-MINDER™**

This feature supplements the safety belt warning function by providing additional reminders by intermittently sounding a chime and illuminating the safety belt warning light when the driver seat is occupied and the safety belt is unbuckled.

If...	Then...
The driver safety belt is buckled before the ignition switch is turned to the on position or less than 1-2 minutes have elapsed since the ignition switch has been turned to on...	The Belt-Minder feature will not activate.
The driver safety belt is not buckled when the vehicle has reached at least 6 mph (9.7 km/h) and 1-2 minutes have elapsed since the ignition switch has been turned to on...	The Belt-Minder feature is activated - the safety belt warning light illuminates and the warning chime sounds for six seconds every 25 seconds, repeating for about five minutes or until the safety belts are buckled.
The driver safety belt becomes unbuckled for about one minute while the vehicle is traveling at least 6 mph (9.7 km/h) and more than 1-2 minutes have elapsed since the ignition switch has been turned to on...	The Belt-Minder feature is activated - the safety belt warning light illuminates and the warning chime sounds for six seconds every 25 seconds, repeating for about five minutes or until the safety belts are buckled.

---

***Deactivating and Activating the Belt-Minder™ Feature***

**WARNING:** While the design allows you to deactivate your Belt-Minder, this system is designed to improve your chances of being safely belted and surviving an accident. We recommend you leave the Belt-Minder system activated for yourself and others who may use the vehicle. To reduce the risk of injury, do not deactivate or activate the Belt-Minder feature while driving the vehicle.

*Read Steps 1 - 4 thoroughly before proceeding with the programming procedure.*

The Belt-Minder feature can be deactivated or activated by performing the following procedure.

Before following the procedure, make sure that:

- The parking brake is set.
  - The transmission is in park (**P**).
  - The ignition is off.
  - All vehicle doors are closed.
  - The driver's safety belt is unbuckled.
1. Switch the ignition on. Do not start the engine.
  2. Wait until the safety belt warning light turns off (about 1 to 2 minutes).
    - Steps 3 and 4 must be completed within 60 seconds or the procedure will have to be repeated.
  3. Buckle then unbuckle the safety belt three times, ending with the safety belt unbuckled. The safety belt warning light will come on for about three seconds.
  4. Within seven seconds of the safety belt warning light turning off, buckle then unbuckle the safety belt. The safety warning light will flash.
- This will disable Belt-Minder if it is currently enabled, or enable Belt-Minder if it is currently disabled.

**CHILD RESTRAINT AND SAFETY BELT MAINTENANCE**

Inspect the vehicle safety belts and child safety seat systems periodically to make sure they work properly and are not damaged. Inspect the vehicle and child seat safety belts to make sure there are no nicks, tears or cuts. Replace if necessary. All vehicle safety belt assemblies, including retractors, buckles, front safety belt buckle assemblies, buckle support assemblies (slide bar-if equipped), shoulder belt height adjusters (if equipped), shoulder belt guide on seat back (if equipped), child safety seat LATCH and tether anchors, and attaching hardware, should be inspected after a crash. Read the child restraint manufacturer's instructions for additional inspection and maintenance information specific to the child restraint.

Ford Motor Company recommends that all safety belt assemblies in use in vehicles involved in a crash be replaced. However, if the crash was minor and an authorized dealer finds that the belts do not show damage and continue to operate properly, they do not need to be replaced. Safety belt assemblies not in use during a crash should also be inspected and replaced if either damage or improper operation is noted.

For proper care of soiled safety belts, see *Cleaning the Interior* in the *Vehicle Care* chapter.

**PRINCIPLES OF OPERATION**

**WARNING:** Airbags do not inflate slowly or gently, and the risk of injury from a deploying airbag is the greatest close to the trim covering the airbag module.



**WARNING:** All occupants of your vehicle, including the driver, should always properly wear their safety belts, even when an airbag supplemental restraint system is provided. Failure to properly wear your safety belt could seriously increase the risk of injury or death.



**WARNING:** Airbags can kill or injure a child in a child seat. Always transport children 12 years old and under in the back seat and always properly use appropriate child restraints.



**WARNING:** Never place your arm over the airbag module, as a deploying airbag can result in serious arm fractures or other injuries.



**WARNING:** Airbags can kill or injure a child in a child seat. Never place a rear-facing child seat in front of an active airbag. If you must use a forward-facing child seat in the front seat, move the seat upon which the child seat is installed all the way back.



**WARNING:** Do not attempt to service, repair, or modify the airbag supplemental restraint systems or its fuses as you could be seriously injured or killed. Contact your authorized dealer as soon as possible.



**WARNING:** Several airbag system components get hot after inflation. Do not touch them after inflation as this may result in serious injury.



**WARNING:** If the airbag has deployed, the airbag will not function again and must be replaced immediately. If the airbag is not replaced, the unrepaired area will increase the risk of injury in a crash.

The airbags are a supplemental restraint system and are designed to work with the safety belts to help protect the driver and right front passenger from certain upper body injuries. Airbags do not inflate slowly; there is a risk of injury from a deploying airbag.

**Note:** You will hear a loud bang and see a cloud of harmless powdery residue if an airbag deploys. This is normal.

The airbags inflate and deflate rapidly upon activation. After airbag deployment, it is normal to notice a smoke-like, powdery residue or smell the burnt propellant. This may consist of cornstarch, talcum powder (to lubricate the bag) or sodium compounds (for example, baking soda) that result from the combustion process that inflates the airbag. Small amounts of sodium hydroxide may be present which may irritate the skin and eyes, but none of the residue is toxic.

While the system is designed to help reduce serious injuries, contact with a deploying airbag may also cause abrasions or swelling. Temporary hearing loss is also a possibility as a result of the noise associated with a deploying airbag. Because airbags must inflate rapidly and with considerable force, there is the risk of death or serious injuries, such as fractures, facial and eye injuries or internal injuries, particularly to occupants who are not properly restrained or are otherwise out of position at the time of airbag deployment. Thus, it is extremely important that occupants be properly restrained as far away from the airbag module as possible while maintaining vehicle control.

Routine maintenance of the airbags is not required.

### **RESTRAINT SAFETY SYSTEM**

The Restraint Safety System provides an improved overall level of frontal crash protection to front seat occupants and is designed to help further reduce the risk of airbag-related injuries. The system is able to analyze different occupant conditions and crash severity before activating the appropriate safety devices to help better protect a range of occupants in a variety of frontal crash situations.

## 48      **Supplementary Restraints System**

---

Your vehicle's Restraint Safety System consists of:

- Driver and passenger dual-stage airbag supplemental restraints.
- Front outboard safety belts with pretensioners, energy management retractors (first row only), and safety belt usage sensors.
- Driver's seat position sensor.
- Front crash severity sensors.
- Restraints control module with impact and safing sensors.
- Restraint system warning light and backup tone.
- The electrical wiring for the airbags, crash sensor(s), safety belt pretensioners, front safety belt usage sensors, driver seat position sensor, and indicator lights.

### ***How does the Restraint Safety System work?***

The Restraint Safety System can adapt the deployment strategy of your vehicle's safety devices according to crash severity and occupant conditions. A collection of crash and occupant sensors provides information to the restraints control module. During a crash, the restraints control module may activate the safety belt pretensioners and/or either one or both stages of the dual-stage airbag supplemental restraints based on crash severity and occupant conditions.

### **SOS POST-CRASH ALERT SYSTEM™**

The system flashes the turn signal lamps and sounds the horn (intermittently) in the event of a serious impact that deploys an airbag equipped on your vehicle, such as front, side, side curtain or Safety Canopy.

The horn and lamps will turn off when:

- You press the hazard control button.
- You press the panic button (if equipped) on the remote entry transmitter.
- Your vehicle runs out of power.

**DRIVER AND PASSENGER AIRBAGS**

 **WARNING:** Never place your arm or any objects over an airbag module. Placing your arm over a deploying airbag can result in serious arm fractures or other injuries. Objects placed on or over the airbag inflation area may cause those objects to be propelled by the airbag into your face and torso causing serious injury.

 **WARNING:** Airbags can kill or injure a child in a child seat. Never place a rear-facing child seat in front of an active airbag. If you must use a forward-facing child seat in the front seat, move the seat upon which the child seat is installed all the way back.

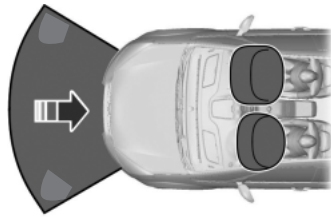

The driver and front passenger airbags will deploy during significant frontal and near frontal crashes.

The driver and passenger front airbag system consists of:

- Driver and passenger airbag modules.



- Crash sensors and monitoring system with readiness indicator. See *Crash Sensors and Airbag Indicator* later in this chapter.

## 50 Supplementary Restraints System

### Proper Driver and Front Passenger Seating Adjustment

 **WARNING:** The National Highway Traffic Safety Administration recommends a minimum distance of at least 10 inches (25 centimeters) between an occupant's chest and the driver airbag module. Failure to follow this could seriously increase the risk of injury or death.

To properly position yourself away from the airbag:

- Move your seat to the rear as far as you can while still reaching the pedals comfortably.
- Recline the seat slightly (one or two degrees) from the upright position.

After all occupants have adjusted their seats and put on safety belts, it is very important that they continue to sit properly. Properly seated occupants sit upright, lean against the seat back, and center themselves on the seat cushion, with their feet comfortably extended on the floor. Sitting improperly can increase the chance of injury in a crash event. For example, if an occupant slouches, lies down, turns sideways, sits forward, leans forward or sideways, or puts one or both feet up, the chance of injury during a crash is greatly increased.

### Children and Airbags

 **WARNING:** Airbags can kill or injure a child in a child seat. Never place a rear-facing child seat in front of an active airbag. If you must use a forward-facing child seat in the front seat, move the seat upon which the child seat is installed all the way back.



Children must always be properly restrained. Accident statistics suggest that children are safer when properly restrained in the rear seating positions than in the front seating position. Failure to follow these instructions may increase the risk of injury in a crash.

**SIDE AIRBAGS**

**WARNING:** Do not place objects or mount equipment on or near the airbag cover, on the side of the seat backs (of the front seats), or in front seat areas that may come into contact with a deploying airbag. Failure to follow these instructions may increase the risk of personal injury in the event of a crash.



**WARNING:** Do not use accessory seat covers. The use of accessory seat covers may prevent the deployment of the side airbags and increase the risk of injury in an accident.



**WARNING:** Do not lean your head on the door. The side airbag could injure you as it deploys from the side of the seat back.



**WARNING:** Do not attempt to service, repair, or modify the airbag, its fuses or the seat cover on a seat containing an airbag, as you could be seriously injured or killed. Contact your authorized dealer as soon as possible.



**WARNING:** If the side airbag has deployed, the airbag will not function again. The side airbag system (including the seat) must be inspected and serviced by an authorized dealer. If the airbag is not replaced, the unrepaired area will increase the risk of injury in a crash.

The side airbags are located on the outboard side of the seat backs of the front seats. In certain sideways crashes, the airbag on the side affected by the crash will be inflated. The airbag was designed to inflate between the door panel and occupant to further enhance the protection provided occupants in side impact crashes.



The system consists of the following:

- A label or embossed side panel indicating that side airbags are found on your vehicle.
- Side airbags located inside the seat back of the driver and front passenger seats.



- Crash sensors and monitoring system with readiness indicator. See *Crash Sensors and Airbag Indicator* later in this chapter.

The design and development of the side airbag system included recommended testing procedures that were developed by a group of automotive safety experts known as the Side Airbag Technical Working Group. These recommended testing procedures help reduce the risk of injuries related to the deployment of side airbags.

#### SAFETY CANOPY® CURTAIN AIRBAGS



**WARNING:** Do not place objects or mount equipment on or near the headliner at the siderail that may come into contact with a deploying curtain airbag. Failure to follow these instructions may increase the risk of personal injury in the event of a crash.





**WARNING:** Do not lean your head on the door. The curtain airbag could injure you as it deploys from the headliner.



**WARNING:** Do not attempt to service, repair, or modify the curtain airbags, its fuses, the A, B, or C pillar trim, or the headliner on a vehicle containing curtain airbags, as you could be seriously injured or killed. Contact your authorized dealer as soon as possible.

 **WARNING:** All occupants of your vehicle including the driver should always wear their safety belts even when an airbag supplemental restraint system and curtain airbag is provided. Failure to properly wear your safety belt could seriously increase the risk of injury or death.

 **WARNING:** To reduce risk of injury, do not obstruct or place objects in the deployment path of the curtain airbag.

 **WARNING:** If the curtain airbags have deployed, the curtain airbags will not function again. The curtain airbags (including the A, B and C pillar trim and headliner) must be inspected and serviced by an authorized dealer. If the curtain airbag is not replaced, the unrepaired area will increase the risk of injury in a crash.

The Safety Canopy will deploy during significant side crashes or when a certain likelihood of a rollover event is detected by the rollover sensor. The Safety Canopy is mounted to the roof side-rail sheet metal, behind the headliner, above each row of seats. In certain sideways crashes or rollover events, the Safety Canopy will be activated, regardless of which seats are occupied. The Safety Canopy is designed to inflate between the side window area and occupants to further enhance protection provided in side impact crashes and rollover events.

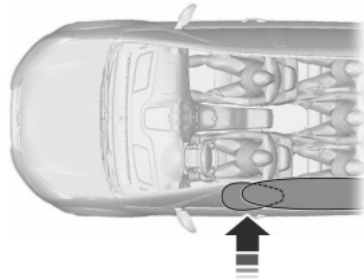

The system consists of:

- Safety canopy curtain airbags located above the trim panels over the front and rear side windows identified by wording on the B-pillar trim.
- A flexible headliner which opens above the side doors to allow air curtain deployment.
-  Crash sensors and monitoring system with readiness indicator. See *Crash Sensors and Airbag Indicator* in this chapter.

## 54 Supplementary Restraints System

---

Children 12 years old and under should always be properly restrained in the rear seats. The Safety Canopy will not interfere with children restrained using a properly installed child or booster seat because it is designed to inflate downward from the headliner above the doors along the side window opening.

The design and development of the Safety Canopy included recommended testing procedures that were developed by a group of automotive safety experts known as the Side Airbag Technical Working Group. These recommended testing procedures help reduce the risk of injuries related to the deployment of side airbags (including the Safety Canopy).

### CRASH SENSORS AND AIRBAG INDICATOR



**WARNING:** Modifying or adding equipment to the front end of your vehicle (including frame, bumper, front end body structure and tow hooks) may affect the performance of the airbag system, increasing the risk of injury. Do not modify the front end of your vehicle.

Your vehicle has a collection of crash and occupant sensors which provide information to the restraints control module. The restraints control module deploys (activates) the front safety belt pretensioners, driver airbag, passenger airbag, seat mounted side airbags, and the Safety Canopy. Based on the type of accident (frontal impact, side impact or rollover) the restraints control module will deploy the appropriate safety devices.

The restraints control module also monitors the readiness of the above safety devices plus the crash and occupant sensors. The readiness of the safety system is indicated by a warning indicator light in the instrument cluster or by a backup tone if the warning light is not working. See the *Instrument Cluster* chapter. Routine maintenance of the airbag is not required.

A difficulty with the system is indicated by one or more of the following:



- The readiness light will either flash or stay lit.
- The readiness light will not illuminate immediately after the ignition is turned on.
- A series of five beeps will be heard. The tone pattern will repeat periodically until the problem or light are repaired.

If any of these things happen, even intermittently, have the supplemental restraint system serviced at an authorized dealer immediately. Unless serviced, the system may not function properly in the event of a crash.

The safety belt pretensioners and the airbag supplemental restraint system are designed to activate when the vehicle sustains frontal or sideways deceleration sufficient to cause the restraints control module to deploy a safety device or when a certain likelihood of a rollover event is detected by the rollover sensor.

The fact that the safety belt pretensioners or airbags did not activate for both front seat occupants in a crash does not mean that something is wrong with the system. Rather, it means the restraints control module determined the accident conditions (for example, crash severity, belt usage) were not appropriate to activate these safety devices.

- The design of the front airbags is to activate only in frontal and near-frontal crashes (not rollovers, side impacts or rear impacts) unless the crash causes sufficient frontal deceleration.
- The design of the safety belt pretensioners is to activate in frontal, near-frontal and side crashes, and in rollovers.
- The design of the side airbags is to inflate in certain side impact crashes. Side airbags may activate in other types of crashes if the vehicle experiences sufficient sideways motion or deformation.
- The design of the Safety Canopy is to inflate in certain side impact crashes or rollover events. The Safety Canopy may activate in other types of crashes if the vehicle experiences sufficient sideways motion or deformation, or a certain likelihood of rollover.

**AIRBAG DISPOSAL**

Contact your authorized dealer as soon as possible. Airbags must be disposed of by qualified personnel.

**GENERAL INFORMATION ON RADIO FREQUENCIES**

This device complies with part 15 of the FCC Rules and with Industry Canada license-exempt RSS standard(s). Operation is subject to the following two conditions: (1) This device may not cause harmful interference, and (2) This device must accept any interference received, including interference that may cause undesired operation.

**Note:** Changes or modifications not expressly approved by the party responsible for compliance could void the user's authority to operate the equipment. The term **IC** before the radio certification number only signifies that Industry Canada technical specifications were met.

The typical operating range for your transmitter is approximately 33 feet (10 meters). Vehicles with the remote start feature will have a greater range. A decrease in operating range could be caused by:

- weather conditions
- nearby radio towers
- structures around your vehicle
- other vehicles parked next to your vehicle.

The radio frequency used by your remote control can also be used by other short-distance radio transmissions, for example amateur radios, medical equipment, wireless headphones, remote controls and alarm systems. If the frequencies are jammed, you will not be able to use your remote control. You can lock and unlock the doors with the key.

**Note:** Make sure your vehicle is locked before leaving it unattended.

**Note:** If you are in range, the remote control will operate if you press any button unintentionally.

### REMOTE CONTROL

#### Integrated Keyhead Transmitters

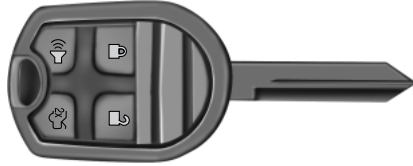

Your vehicle may be equipped with two integrated keyhead transmitters. The key blade is used to start the vehicle and unlock or lock the driver's door from outside the vehicle. The transmitter portion functions as the remote control.

**Note:** Your vehicle's keys were issued with a security label that provides important vehicle key cut information. Keep the label in a safe place for future reference.



#### Replacing the Battery

**Note:** Refer to local regulations when disposing of transmitter batteries.

**Note:** Do not wipe off any grease on the battery terminals or on the back surface of the circuit board.

**Note:** Replacing the battery will not delete the transmitter from your vehicle. The transmitter should operate normally.

The remote control uses one coin-type three-volt lithium battery CR2032 or equivalent.

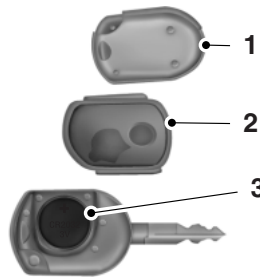
**Integrated Keyhead Transmitter**

1. Twist a thin coin in the slot near the key ring to remove the battery cover (1).

2. Carefully peel up the rubber gasket (2) from the transmitter if it does not come off with the battery cover.

3. Remove the old battery (3).

4. Insert the new battery. Refer to the instructions inside the integrated keyhead transmitter for the correct orientation of the battery. Press the battery down to ensure that the battery is fully seated in the battery housing cavity.

5. Reinstall the rubber gasket.

6. Snap the battery cover back onto the key.

**Memory Feature**

The feature allows the remote control to recall the driver seat, power mirrors, steering column and power adjustable foot pedals memory positions.

Press the unlock button on the remote control to recall the memory positions. If the easy entry and exit feature is enabled, the seat will move to the easy entry position. The seat will move to the driver memory position when the key is put in the ignition.

**Programming Memory to the Remote Control**

1. Switch on the ignition.

2. Move the memory features to the desired positions using the associated controls.



3. Press and hold memory button **1** on the side of the driver seat for five seconds. You will hear two tones.

4. Within three seconds press the lock button on the remote control.

Repeat this procedure for memory button **2** and a second remote control if desired.

### ***Deactivating Memory from the Remote Control***

1. Switch on the ignition.
  2. Press and hold the desired memory button for five seconds. You will hear two tones.
  3. Within three seconds press the unlock button on the remote control.
- Repeat this procedure for each additional remote control if desired.

### **Car Finder**



Press the button twice within three seconds. The horn will sound and the turn signals will flash. We recommend you use this method to locate your vehicle, rather than using the panic alarm.

### **Sounding a Panic Alarm**



Press the button to activate the alarm. Press the button again or switch the ignition on to deactivate.

**Note:** The panic alarm will only operate when the ignition is off.

### **REPLACING A LOST KEY OR REMOTE CONTROL**

You can purchase replacement or additional keys or remote controls from an authorized dealer. A dealer can program the transmitters to your vehicle or you may be able to program them yourself. See the *Security* chapter for information on programming your transmitters.

**PRINCIPLES OF OPERATION**

MyKey allows you to program keys with restricted driving modes to promote good driving habits. You can use all but one of the keys programmed to your vehicle with these restricted modes.

Any keys that have not been programmed are referred to as administrator keys or admin keys. These can be used to:

- create a restricted key
- program optional MyKey settings
- clear all MyKey features.

When you have programmed a MyKey, you can access the following information using the information display:

- The number of admin keys and MyKeys are programmed to your vehicle.
- The total distance your vehicle has traveled using a MyKey.

**Note:** Switch the ignition on to use the system.

**Note:** All MyKeys are programmed to the same settings. You cannot program them individually.

**Non-configurable Settings**

The following settings cannot be changed by an admin key user:

- Belt-Minder. You cannot disable this feature. The audio system will mute when the front seat occupants' safety belts are not fastened.
- Early low fuel. The low-fuel warning activates earlier, giving the MyKey user more time to refuel.
- Driver assist features, if equipped on your vehicle, are forced on: parking aid, blind spot information system (BLIS) with cross traffic alert, lane departure warning and the forward collision warning system.

**Configurable Settings**

With an admin key, you can configure certain MyKey settings when you first create a MyKey and before you recycle the key or restart the vehicle. You can also change the settings afterward with an admin key.

- A vehicle speed limit can be set. Warnings will be shown in the display followed by an audible tone when your vehicle reaches the set speed. You cannot override the set speed by fully depressing the accelerator pedal or by setting cruise control.
- Vehicle speed minders of 45, 55 or 65 mph (75, 90 or 105 km/h). Once you select a speed, it will be shown in the display, followed by an audible tone when the preselected vehicle speed is exceeded.

- Audio system maximum volume of 45%. A message will be shown in the display when you attempt to exceed the limited volume. Also, the speed-sensitive or compensated automatic volume control will be disabled.
- Always on setting. When this is selected, you will not be able to turn off AdvanceTrac (if your vehicle is equipped with this feature).

### CREATING A MYKEY

Use the information display to create a MyKey.

1. Insert the key you want to program into the ignition.
2. Switch the ignition on.
3. Access the main menu on the information display. Press **SETUP** using the information display buttons until **PRESS RESET TO CREATE MYKEY** is displayed.
4. Press and release the **RESET** button. **HOLD RESET TO CONFIRM MYKEY** will be displayed.
5. Press and hold the **RESET** button for two seconds until **MARK THIS AS RESTRICTED** is displayed. Wait until **KEY RESTRICTED AT NEXT START** is displayed.

MyKey is successfully created. Make sure you label it so you can distinguish it from the admin keys.

You can also program configurable settings for the key(s). Refer to *Programming/Changing Configurable Settings*.

### Programming/Changing Configurable Settings

Use the Information display to access your configurable MyKey settings:

1. Switch the ignition on with an admin key.
2. Access the main menu on the information display controls and press **SETUP** until you see **RESET FOR MYKEY SETTINGS** in the display.
3. Press and release the **RESET** button to display the MyKey setup menus.
4. Press the **SETUP** button to display the next menu and scroll through your choices.
5. Within any of the menus, press **RESET** to highlight your choice. Use the arrow buttons to make a selection.
6. Press **SETUP** to enter your choice. The next configurable setting will be displayed.
7. Repeat Steps 4 and 5 until you are done changing the configurable settings.

**CLEARING ALL MYKEYS**

You can clear all MyKeys within the same key cycle as you created the MyKey. If you switch your ignition off, however, you will need to use an admin key to clear your MyKeys.

**Note:** When you clear your MyKeys, you remove all restrictions and return all MyKeys to their original admin key status at once.

To clear all MyKeys of all MyKey settings, use the information display to do the following:

1. Press **SETUP** until you see **PRESS RESET TO CLEAR MYKEY** in the display.
2. Press and release the **RESET** button. You will see **HOLD RESET TO CONFIRM CLEAR** in the display.
3. Press and hold the **RESET** button for two seconds until you see **ALL MYKEYS CLEARED** in the display.

**CHECKING MYKEY SYSTEM STATUS**

You can find information about your programmed MyKeys by using the information display.

**MYKEY DISTANCE**

Tracks the distance when drivers use a MyKey. The only way to delete the accumulated distance is by using an admin key to clear your MyKey. If the distance does not accumulate as expected, then the intended user is not using the MyKey, or an admin key user recently cleared and then recreated a MyKey.

**NUMBER OF MYKEY(S)**

Indicates the number of MyKeys programmed to your vehicle. Use this feature to detect how many MyKeys you have for your vehicle and determine when a MyKey has been deleted.

**NUMBER OF ADMIN KEY(S)**

Indicates how many admin keys are programmed to your vehicle. Use this feature to determine how many unrestricted keys you have for your vehicle, and detect if an additional MyKey has been programmed.

---

**USING MYKEY WITH REMOTE START SYSTEMS**

MyKey is not compatible with non-Ford-approved aftermarket remote start systems. If you choose to install a remote start system, please see your Ford authorized dealer for a Ford-approved remote start system.

**Vehicles With Ford-approved Aftermarket Remote Start Systems**

When using a Ford-approved aftermarket remote start system, the vehicle recognizes the remote start system as an additional admin key. It is the vehicle's default setting. You can also program the remote start as a MyKey. As a result, the MyKey system status menu display includes the remote start system as an additional key in the total count of **MYKEY(S) PROGRAMMED** or **ADMIN KEYS PROGRAMMED**. See *Checking MyKey System Status*.

When you start your vehicle with a Ford-approved aftermarket remote start system, the system stalls the vehicle after you open the door or shift the vehicle into gear. This is intentional. When you restart your vehicle, it reads your real key's status instead of the remote start system's status.

As an added precaution, owners may want to program the remote start system as a MyKey, if the MyKey driver uses the remote start fob. That way, when the MyKey driver starts the vehicle with the remote start system, the MyKey restrictions remain active.

With a Ford-approved aftermarket remote start system, it is possible to program all real keys as MyKeys unintentionally. If this happens, then the remote start fob is the admin key. If you want to have only one real key as a MyKey, or do not want to have any MyKeys, then you need to use your remote start to clear all MyKeys. In that case, follow these steps:

- Enter the vehicle and close all doors.
- Remote start the vehicle using your remote start fob.
- See *Clearing All MyKeys*. Follow Steps 1-3.

After clearing your MyKeys, you can create a new MyKey. See *Creating a MyKey*.

**Vehicles With Non-Ford-approved Aftermarket Remote Start Systems**

MyKey is not compatible with non-Ford-approved aftermarket remote start systems. If you choose to install a remote start system, please see a Ford authorized dealer for a Ford-approved system.

The following information **may** help customers who choose to install a non-Ford-approved remote start system. The actions provided below do not make MyKey compatible with non-Ford-approved remote start systems, but may help you retain some MyKey functions.

When using a non-Ford-approved remote start system, the vehicle may recognize the remote start system as an additional admin key with its associated privileges. If you restart the vehicle by inserting a key into the ignition cylinder and recycling the ignition completely, then you may retain some MyKey functions. This action forces your vehicle to read the traditional key instead of the remote start fob and then uses the key's associated privileges.

**Note:** The MyKey system status menu display may include the remote start system as an additional key in the total count of **MYKEY(S) PROGRAMMED** or **ADMIN KEYS PROGRAMMED**. See *Checking MyKey System Status*.

As an added precaution, owners may want to program the remote start system as a MyKey, if the MyKey driver uses the remote start fob. That way, when the MyKey driver starts the vehicle with the remote start system, the MyKey restrictions will remain active.

With a non-Ford-approved aftermarket remote start system, it is possible to program all real keys as MyKeys unintentionally. If this happens, then the remote start fob is the admin key. If you want to have only one real key as a MyKey, or do not want to have any MyKeys, then you need to use your remote start to clear all MyKeys. In that case, follow these steps:

- Enter the vehicle and close all doors.
- Remote start the vehicle using your remote start fob.
- See *Clearing All MyKeys*. Follow Steps 1-3.

After clearing your MyKeys, you can create a new MyKey. See *Creating a MyKey*.

**MYKEY TROUBLESHOOTING**

<b>Condition</b>	<b>Potential causes</b>
I cannot create a MyKey.	<ul style="list-style-type: none"> <li>• The key to start the vehicle does not have admin privileges.</li> <li>• The key used to start the vehicle is the only admin key (there always has to be at least one admin key).</li> <li>• SecuriLock passive anti-theft system is disabled or in unlimited mode.</li> <li>• The vehicle has been started using a remote start system that is not programmed with admin privileges. See <i>Using MyKey With Remote Start Systems</i>.</li> </ul>
I cannot program the configurable settings.	<ul style="list-style-type: none"> <li>• The key used to start the vehicle does not have admin privileges.</li> <li>• No MyKeys are created. See <i>Creating a MyKey</i>.</li> <li>• The vehicle has been started using a remote start system that is not programmed with admin privileges. See <i>Using MyKey With Remote Start Systems</i>.</li> </ul>
I cannot clear the MyKeys.	<ul style="list-style-type: none"> <li>• The key used to start the vehicle does not have admin privileges.</li> <li>• No MyKeys are created. See <i>Creating a MyKey</i>.</li> <li>• The vehicle has been started using a remote start system that is not programmed with admin privileges. See <i>Using MyKey With Remote Start Systems</i>.</li> </ul>
I lost the only admin key.	<ul style="list-style-type: none"> <li>• Purchase a new key from your authorized dealer.</li> </ul>
I lost a key.	<ul style="list-style-type: none"> <li>• Program a spare key. See <i>SecuriLock</i> in the <i>Security</i>.</li> </ul>

Condition	Potential causes
I accidentally programmed all keys as MyKeys.	<ul style="list-style-type: none"> <li>• The vehicle has a remote start system that is recognized as an admin key. Clear all MyKeys by using remote start. See <i>Using MyKey With Remote Start Systems</i>.</li> <li>• Your vehicle's system does not recognize any MyKeys. See <i>Creating a MyKey</i>.</li> </ul>
MyKey total includes one additional key.	<ul style="list-style-type: none"> <li>• An unknown key has been created as a MyKey.</li> <li>• The vehicle has a remote start system. See <i>Using MyKey With Remote Start Systems</i>.</li> </ul>
Admin key total includes one additional key.	<ul style="list-style-type: none"> <li>• An unknown key has been programmed to the vehicle as an admin key.</li> <li>• The vehicle has a remote start system. See <i>Using MyKey With Remote Start Systems</i>.</li> </ul>
MyKey distances do not accumulate.	<ul style="list-style-type: none"> <li>• The MyKey user is not using the programmed MyKey.</li> <li>• An admin key holder cleared the MyKeys and created new MyKeys.</li> <li>• The key system has been reset.</li> </ul>

**LOCKING AND UNLOCKING**

You can use the power door lock control or the remote control to lock and unlock your vehicle.

**Power Door Locks**

The power door lock control is located on the driver and front passenger door panels.



A. Unlock

B. Lock

**Remote Control**

You can use the remote control anytime your vehicle is not running.

***Unlocking the Doors (Two-Stage Unlock)***

Press the button to unlock the driver's door.

Press the button again within three seconds to unlock all doors. The turn signals will flash.

Press and hold both the lock and unlock buttons on the remote control for four seconds to disable or enable two-stage unlocking. Disabling two-stage unlocking allows all vehicle doors to unlock with one press of the button. The turn signals will flash twice to indicate the unlocking mode was changed. The unlocking mode will be applied to the remote control and keyless entry keypad.

***Locking the Doors***

Press the button to lock all the doors. The turn signals will illuminate.

Press the button again within three seconds to confirm that all the doors are closed. The doors will lock again, the horn will sound and the turn signals will illuminate if all the doors and the luggage compartment are closed.

**Note:** If any door or the luggage compartment is open, or if the hood is open on vehicles with an anti-theft alarm or remote start, the horn sounds twice and the lamps will not flash.

**Power Liftgate**

**WARNING:** Make sure all persons are clear of the liftgate area before using power liftgate control.



**WARNING:** Make sure to close and latch the liftgate to prevent drawing exhaust fumes into your vehicle. This will also prevent passengers and cargo from falling out. If you must drive with the liftgate open, keep the vents or windows open so outside air comes into your vehicle. Failure to follow this warning could result in serious personal injury.

**Note:** Be careful when opening or closing the liftgate in a garage or other enclosed area to avoid damaging the liftgate.



Press twice within three seconds to open or close the liftgate, or to reverse the movement.

**Smart Unlocks**

This feature helps to prevent you from locking yourself out of your vehicle if your key is still in the ignition.

When you open one of the front doors or the liftgate and lock your vehicle with the power door lock control, all the doors will lock then unlock if your key is still in the ignition.

Your vehicle can still be locked with the key in the ignition by:

- locking the driver door with a key
- using the lock control on the remote control
- using the keyless entry keypad.

If both front doors and the liftgate are closed, your vehicle can be locked from any method, regardless of whether the key is in the ignition or not.

**Autolock and Unlock**

The autolock feature will lock all the doors, the liftgate and the liftgate window when:

- all doors are closed,
- the ignition is on,

- you shift into any gear putting the vehicle in motion, and
- the vehicle attains a speed greater than 12 mph (20 km/h).

If the vehicle was autolocked, the autounlock feature will unlock all doors when the driver's door is opened within 10 minutes of switching the ignition off.

### ***Enabling or Disabling Autolock and Autounlock***

These features can be enabled or disabled:

- by your authorized dealer
- through the information display
- using the power door lock procedure.

To enable or disable using the power door locks, do the following:

**Note:** You will have 30 seconds to complete the procedure.

1. Switch the ignition on.
2. Press the power door unlock button three times.
3. Switch the ignition off.
4. Press the power door unlock button three times.
5. Switch the ignition on. The horn will chirp indicating the programming mode has been entered.

**Autolock:** Once in programming mode, press the power door unlock button then the lock button. The horn will chirp once if autolock was deactivated or twice (one short and one long chirp) if autolock was activated.

**Autounlock:** Once in programming mode, press the power door lock button then the unlock button. The horn will chirp once if autounlock was deactivated or twice (one short and one long chirp) if autounlock was activated.

6. Turn the ignition off. The horn will chirp once to confirm the procedure is complete.

**Note:** The autounlock feature can be enabled or disabled independently of the autolock feature.

**Illuminated Entry**

The interior lamps and parking lamps illuminate when the remote entry system is used to unlock the door(s).

The system will turn off the lights if:

- the ignition is turned on
- the lock button on the remote control is pressed
- the vehicle is locked using the keyless entry keypad
- after 25 seconds of illumination.

The dome lamp control (if equipped) must not be set to the off position for the illuminated entry system to operate.

The lights will not turn off if:

- they have been turned on with the dimmer control
- any door is open.

**Illuminated Exit**

The interior lamps and parking lamps illuminate when doors are closed and the key is removed from the ignition.

The lamps will turn off if all the doors remain closed and:

- 25 seconds elapse
- the key is inserted in the ignition.

**Battery Saver**

If you leave the courtesy lamps, dome lamps or headlamps on, the battery saver shuts them off 10 minutes after you switch the ignition off.

**LIFTGATE**

**WARNING:** It is extremely dangerous to ride in a cargo area, inside or outside of a vehicle. In a crash, people riding in these areas are more likely to be seriously injured or killed. Do not allow people to ride in any area of your vehicle that is not equipped with seats and safety belts. Be sure everyone in your vehicle is in a seat and using a safety belt properly.

**Power Liftgate**

**WARNING:** Make sure to close and latch the liftgate to prevent drawing exhaust fumes into your vehicle. This will also prevent passengers and cargo from falling out. If you must drive with the liftgate open, keep the vents or windows open so outside air comes into your vehicle. Failure to follow this warning could result in serious personal injury.



**WARNING:** Make sure all persons are clear of the power liftgate area before using the power liftgate control.



**WARNING:** Keep keys out of the reach of children. Do not allow children to operate the power liftgate, or to play near to an open or moving power liftgate.

**Note:** Cycling the ignition prior to completely latching the liftgate could result in damage to the liftgate or its power components. Make sure the liftgate is fully latched before operating the vehicle.

If the ignition is cycled during a liftgate power close cycle and the liftgate is 6-10 inches (15-24 centimeters) from being latched, the liftgate may reverse to the full open position. Verify that the liftgate is closed before operating or moving the vehicle, especially in an enclosure, like a garage or a parking structure. The liftgate or its components could be damaged in an enclosure, if the liftgate is open.

When power operating the liftgate at temperatures below 32°F (0°C), the liftgate may stop about 5 inches (13 centimeters) from the full open position. The liftgate can be fully opened by pushing it upward to the maximum open position.

**Opening and Closing the Power Liftgate**

**Note:** The liftgate can be reversed with a second press on a control button or transmitter and can be manually closed at any time.

The liftgate will only operate with your vehicle in **P**. The chime will beep once if conditions are not correct to start an operation. These conditions include:

- The ignition is in on and the transmission is not in **P**.
- The battery voltage is below the minimum operating voltage.
- The vehicle speed is at or above 3 mph (5 km/h).

If the liftgate reverses and starts to close after a open request, a fast continuous chime indicates excessive load on the liftgate or a possible strut failure. If any excessive load is removed and you still have a faster chime, have the system serviced immediately by your authorized dealer.

Do not attempt to manually force the liftgate to travel faster than the power system will permit. This will activate the obstacle detection feature.



**To open or close from the instrument panel:**

Press the instrument panel button.



**To open or close with the remote control:**

Press the remote control button twice within three seconds.

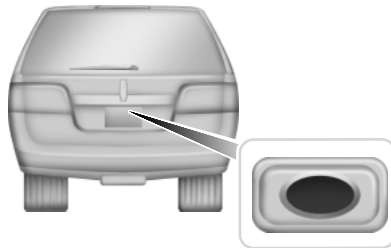

**To open with the outside liftgate button (manual actuation):**

1. Unlock the liftgate with the remote entry transmitter or power door unlock control.
2. Press the control button located in the top of the liftgate pull cup handle.

**Note:** Let the power system open the liftgate after releasing the control button. Continued upward force after unlatching may activate the obstacle detection feature and stop the power operation.

**Note:** If weight is added to the liftgate (bike rack, snow, etc.) it may start a power close event immediately after a power open. If this happens, a unique continuous chime will sound.

**To close with the rear cargo area button:**



**WARNING:** Keep clear of the liftgate when activating the rear switch.

**Note:** The rear cargo area control button is disabled when the liftgate is latched.



Press and release the control on the left rear quarter panel. A chime will beep once if conditions are not correct to start an operation (i.e., the vehicle is out of park). In a normal close, the chime will begin just before the gate starts to move and continue for a total of three seconds.

#### To manually operate the liftgate:

**Note:** Manual operation is suggested on extreme inclines or in extreme cold -40°F (-40°C).

**Note:** In the event of a power failure, the latch can be accessed and released from the inside using the access panel on the liftgate trim.

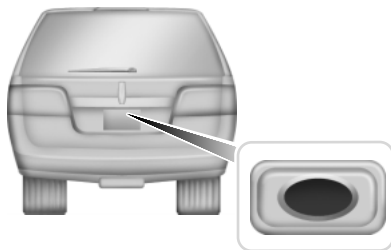

1. Disable the liftgate power function in the information display. See the *Information Displays* chapter.
2. Push the control button located in the top of the liftgate pull cup to unlatch the liftgate, then pull on the outside handle.

#### Obstacle Detection

**Note:** Entering your vehicle while the liftgate is closing can cause it to bounce and activate obstacle detection. To prevent this, let the power liftgate fully close before entering the vehicle.

The power liftgate system is equipped with an obstacle detection feature.

If the power liftgate is closing, the system is designed to reverse to full open when it encounters a solid obstacle. A three second chime is also sounded when an obstacle is detected. Once the obstacle is removed, the liftgate can be closed under power.

If the power liftgate is opening, the system is designed to stop when it encounters a solid obstacle. A chime will sound for three seconds while the obstacle is present.

**Resetting the Power Liftgate**

If any of these conditions occur, the power liftgate may not operate and must be reset:

- A low voltage or dead battery
- Disconnected battery
- The liftgate is manually closed and left ajar (unlatched)

To reset the power liftgate:

1. Disconnect the battery for 20 seconds then, reconnect the battery.
2. Manually close and fully latch the liftgate.
3. Power open the liftgate by using the remote entry transmitter or instrument panel button.

**Note:** If the power liftgate system is turned off in the message center, the system cannot be activated with the outside release handle or rear cargo area control button. The system will need to be turned on to resume operation with the outside release handle or rear cargo area control button. The power liftgate is still operational through the use of the remote entry transmitter and instrument panel button when the power liftgate is turned off in the message center.

**Liftgate Ajar Signal**

If the liftgate or liftgate glass are not fully latched, you will receive a message on the instrument panel. If you see this message, check both the liftgate glass and liftgate door to ensure they are fully latched.

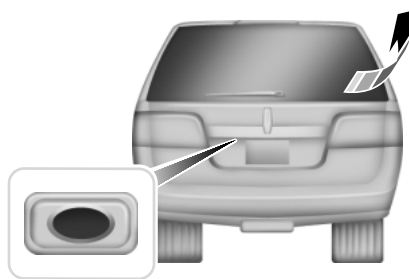
**Liftgate Window**

To open the liftgate window, press the button in the center of the liftgate above the license plate.

**SECURICODE™ KEYLESS ENTRY KEYPAD**

You can use the keyless entry keypad to lock or unlock the doors or release the liftgate glass without using a key.

The keypad can be operated with the factory-set 5-digit entry code; this code is located on the owner's wallet card in the glove box and is available from your authorized dealer. You can also create up to five of your own 5-digit personal entry codes.

**Programming a Personal Entry Code**

You can store up to three personal entry codes.

To create your own personal entry code:

1. Enter the factory-set code.
2. Press the **1•2** on the keypad within five seconds. The doors will lock and then unlock to confirm that the system is in programming mode.
3. Enter your personal 5-digit code. You must enter each number within five seconds of each other.
4. Press **1•2** on the keypad to save personal entry code 1.

The doors will lock and then unlock to confirm that programming is complete.

To program additional personal entry codes, repeat Steps 1–3, then for Step 4:

- press **3•4** to save personal entry code 2, or
- press **5•6**, **7•8**, or **9•0** to save personal entry code 3.

**Tips:**

- Do not set a code that uses five of the same number.
- Do not use five numbers in sequential order.
- The factory-set code will work even if you have set your own personal code.

**Programming Memory to a Personal Entry Code**

To program a personal entry code to recall a driver memory setting, repeat Steps 1–4 above.

- Pressing **1•2** on the keypad in Step 4 will program the code to driver memory setting 1.
- Pressing **3•4** in Step 4 will program the code to driver memory setting 2.

**Note:** Pressing **5•6**, **7•8**, or **9•0** keypad numbers in Step 4 will not program the code to recall a driver memory setting.

**Note:** The factory-set code cannot be associated with a memory setting.

**Erasing a Personal Code**

1. Enter the factory-set 5-digit code.
2. Press and release the **1•2** on the keypad within five seconds. The doors will lock and then unlock to confirm that the system is in programming mode.
3. Press and hold the **1•2** for two seconds. You must do this within five seconds of completing Step 2.

All personal codes are now erased and only the factory-set 5-digit code will work.

**Anti-Scan Feature**

The keypad will go into an anti-scan mode if you enter the wrong code seven times (35 consecutive button presses). This mode disables the keypad for one minute and the keypad lamp will flash.

The anti-scan feature will turn off after:

- one minute of keypad inactivity
- pressing the unlock button on the remote control
- the ignition is turned on.

**Unlocking and Locking the Doors and Liftgate**

**To unlock the driver door:** Enter the factory-set 5-digit code or your personal code. You must press each number within five seconds of each other. The interior lamps will illuminate.

**To unlock all doors and liftgate:** Enter the factory-set 5-digit code or your personal code, then press **3•4** within five seconds.

**To lock all doors and liftgate:** Press and hold **7 •8** and **9•0** at the same time with the driver door closed. You do not need to enter the keypad code first.

**To open the liftgate glass:** Enter the factory-set 5-digit code or your personal code, then press **5•6**.

**SECURILOCK® PASSIVE ANTI-THEFT SYSTEM**

**Note:** The system is not compatible with non-Ford aftermarket remote start systems. Use of these systems may result in vehicle starting problems and a loss of security protection.

**Note:** Metallic objects, electronic devices or a second coded key on the same key chain may cause vehicle starting issues if they are too close to the key when starting your vehicle. Prevent these objects from touching the coded key while starting the engine. Switch the ignition off, move all objects on the key chain away from the coded key and restart your vehicle if a problem occurs.

**Note:** Do not leave a duplicate coded key in your vehicle. Always take your keys and lock all doors when leaving your vehicle.

The system helps prevent the engine from starting unless you use a coded key programmed to your vehicle. Using the wrong key may prevent your vehicle from starting. A message may appear in the information display.

If you are unable to start your vehicle with a correctly coded key, a malfunction has occurred. A message may appear in the information display.

**Automatic Arming**

Your vehicle arms immediately after you switch the ignition off.

**Anti-Theft Indicator**

The anti-theft indicator is located in the instrument cluster.



- When the ignition is off, the indicator will flash once every two seconds to indicate the SecuriLock system is functioning as a theft deterrent.
- When the ignition is on, the indicator will glow for three seconds, then turn off to indicate normal system functionality.

If a problem occurs with the SecuriLock system, the indicator will flash rapidly or glow steadily when the ignition is on. If this occurs, switch the ignition off then back on to make sure there was no electronic interference with the programmed key. If your vehicle does not start, try to start it with the second programmed key and if successful contact your authorized dealership for key replacement. If the indicator still flashes rapidly or glows steadily, your vehicle will not start. Contact your authorized dealer as soon as possible for service.

**Automatic Disarming**

Your vehicle disarms when you switch the ignition on with a coded key.

**Replacement Keys**

**Note:** Your vehicle may come with two integrated keyhead transmitters.

The integrated keyhead transmitter functions as a programmed ignition key that operates all the locks and starts the vehicle, as well as a remote control.

If your programmed transmitters or standard SecuriLock coded keys are lost or stolen and you do not have an extra coded key, you will need to have your vehicle towed to an authorized dealer. The key codes need to be erased from your vehicle and new coded keys will need to be programmed.

Store an extra programmed key away from the vehicle in a safe place to help prevent any inconveniences. See an authorized dealer to purchase additional spare or replacement keys.

**Programming a Spare Key**

**Note:** A maximum of eight coded keys can be programmed to your vehicle. Only four of these eight can be integrated keyhead transmitters.

You can program your own integrated keyhead transmitters or standard SecuriLock coded keys to your vehicle. This procedure will program both the engine immobilizer key code and the remote entry portion of the remote control to your vehicle.

Only use integrated keyhead transmitters or standard SecuriLock keys.

You must have two previously programmed coded keys and the new unprogrammed key readily accessible. See your authorized dealer to have the spare key programmed if two previously programmed coded keys are not available.

Read and understand the entire procedure before you begin.

1. Insert the first previously programmed coded key into the ignition.
2. Turn the ignition from off to on. Keep the ignition on for at least three seconds, but no more than 10 seconds.
3. Turn the ignition off and remove the first coded key from the ignition.
4. After three seconds but within 10 seconds of turning the ignition off, insert the second previously coded key into the ignition.

5. Turn the ignition from off to on. Keep the ignition on for at least three seconds, but no more than 10 seconds.
6. Turn the ignition off and remove the second previously programmed coded key from the ignition.
7. After three seconds but within 20 seconds of turning the ignition off and removing the previously programmed coded key, insert the new unprogrammed key into the ignition.
8. Turn the ignition from off to on. Keep the ignition on for at least six seconds.
9. Remove the newly programmed coded key from the ignition.

The key will start the vehicle's engine and will operate the remote entry system (if the new key is an integrated keyhead transmitter) if it has been successfully programmed. The theft indicator light will illuminate for three seconds and then go out to indicate successful programming.

If the key was not successfully programmed, the theft indicator light may flash on and off. Wait 20 seconds and repeat Steps 1 through 8. Take your vehicle to your authorized dealer to have the new key programmed if you are still unsuccessful.

Wait 20 seconds and then repeat this procedure from Step 1 to program an additional key.

### **ANTI-THEFT ALARM**

The system will warn you of unauthorized entry to your vehicle.

The turn signal lamps will flash and the horn will sound when:

- any door or the hood is opened without using the key or the remote control
- the ignition is turned on with an invalid key.

Take all keys and remote controls to your authorized dealer if there is any potential alarm problem with your vehicle.

### **Arming the Alarm**

The system is ready to arm whenever the ignition is off. Lock the vehicle to arm the alarm.

The turn signal lamps will flash once after locking the vehicle to indicate the alarm is in the pre-armed mode and will become fully armed in 20 seconds.

**Disarming the Alarm**

To disarm the alarm, do any of the following:

- Press the power door unlock button within the 20-second pre-armed mode.
- Press the unlock button on the remote control.
- Unlock the doors with the keyless entry pad.
- Turn the ignition on with a valid key.
- Press the panic button on the remote control. The alarm system will still be armed, but this shuts off the horn and turn lamps when the alarm is sounding.

**Note:** If the driver's door is unlocked with a key, a chime will sound when you open the door. You will have 12 seconds to disarm the alarm using any of the actions above, otherwise the alarm will trigger.

**ADJUSTING THE STEERING WHEEL**

**WARNING:** Do not adjust the steering wheel when your vehicle is moving.

**Note:** Make sure that you are sitting in the correct position. Refer to *Sitting in the Correct Position* in the *Seats* chapter.

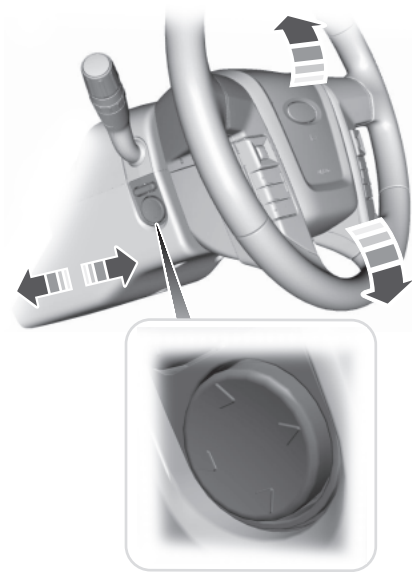

Use the control on the side of the steering column to tilt the position.

**Memory Feature**

The steering column positions are saved and recalled with the memory feature. Refer to the *Seats* chapter.

Pressing the adjustment control during memory recall will cancel the operation. The column will respond to the adjustment control.

**Easy Entry and Exit Feature**

The column will move to the full up position when the ignition is switched off. It will return to the previous position when the ignition is switched on. This feature can be switched on or off in the information display.

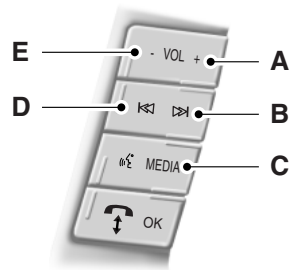
**AUDIO CONTROL**

- A. Volume up
- B. Seek up or next
- C. Media
- D. Seek down or previous
- E. Volume down

**Media**

Press the media button repeatedly to scroll through available audio modes.

**Seek, Next or Previous**

Press the seek button to:

- tune the radio to the next or previous stored preset
- play the next or previous track.

Press and hold the seek button to:

- tune the radio to the next station up or down the frequency band
- seek through a track.

### VOICE CONTROL (IF EQUIPPED)

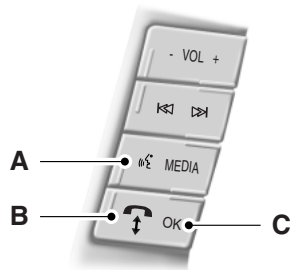

A. Voice recognition

B. Phone mode

C. Confirm selection

See the *SYNC* or *Navigation System* chapter.

### CRUISE CONTROL



See the *Cruise Control* chapter.

**ADJUSTABLE PEDALS (IF EQUIPPED)**

**WARNING:** Never adjust the accelerator and brake pedal with feet on the pedals while the vehicle is moving.

The control is located to the left of the steering column. Press and hold the appropriate control to move the pedals.

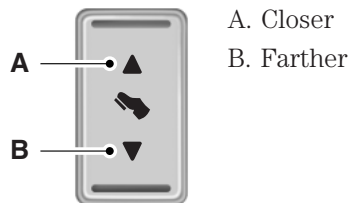

The pedal positions are saved and recalled with the memory feature (if equipped). Refer to the *Seats* chapter.

The pedals should only be adjusted when the vehicle is parked.

**WINDSHIELD WIPERS**

**Note:** Fully defrost the windshield before turning on the windshield wipers.

**Note:** Make sure the windshield wipers are turned off before entering a car wash.

**Note:** Clean the windshield and wiper blades if they begin to leave streaks or smears. If that does not resolve the issue, install new wiper blades.

**Note:** Do not operate the wipers on a dry windshield. This may scratch the glass, damage the wiper blades or cause the wiper motor to burn out. Always use the windshield washers before wiping a dry windshield.

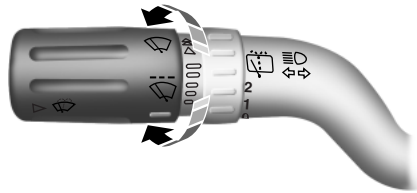

Rotate the end of the control:

- away from you to increase the wiper speed
- toward you to decrease the wiper speed.

**Speed Dependent Wipers**

When your vehicle speed increases, the interval between wipes will decrease when intermittent wipe is selected.

**RAIN-SENSING WIPERS**

**Note:** Wet road conditions may result in inconsistent or unexpected wiping or smearing. Lower the sensitivity, switch to normal or high-speed wiping or turn the wipers off to reduce smearing.

**Note:** Turn off the wipers before entering a car wash.



Use the rotary control to adjust the sensitivity to one of the interval moisture settings. The wipers will not cycle until moisture is detected on the windshield. The wiper speed will vary based on the amount of moisture detected on the windshield and the sensitivity setting.

The wipers will continue to wipe as long as moisture is detected.

Keep the outside of the windshield clean, especially the area around the interior mirror where the sensor is located, or sensor performance may be affected.

### WINDSHIELD WASHERS

**Note:** Do not operate the wipers on a dry windshield. This may scratch the glass, damage the wiper blades or cause the wiper motor to burn out. Always use the windshield washer before wiping a dry windshield.

**Note:** Do not operate the washer when the washer reservoir is empty. This may cause the washer pump to overheat.



Press the end of the stalk to activate the washer.

- A brief press causes a single wipe without washer fluid.
- A quick press and hold causes the wipers to swipe three times with washer fluid.
- A long press and hold will activate the wipers and washer fluid for up to 10 seconds.

A wipe will occur a few seconds after washing to clear any remaining washer fluid.

### REAR-WINDOW WIPER AND WASHERS

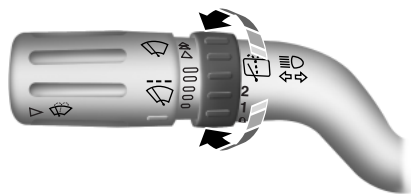

Rotate the control to select:

- 2** — Intermittent operation (shortest pause between wipes).
- 1** — Intermittent operation (longest pause between wipes).
- 0** — Off.

Rotate and hold the control to either the top or bottom position to activate the rear washer. The control will return to the **2** or **0** position when you release it.

**LIGHTING CONTROL**



Rotate the control clockwise to the first position to turn on the parking lamps.

Rotate the control clockwise to the second position to turn on the headlamps.

Rotate the control to the vertical position to turn the headlamps off.

**High Beams**



- Push the lever toward the instrument panel to switch on the high beams.
- Pull the lever toward you to switch of the high beams.

**Headlamp Flasher**

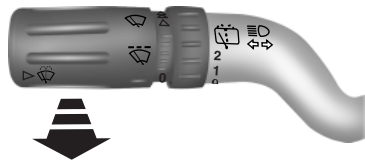

Pull the lever toward you slightly and release it to flash the headlamps.

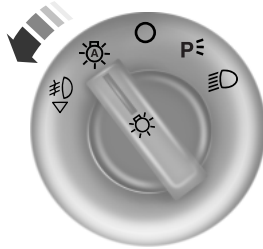
**AUTOLAMPS**

The autolamp system provides light sensitive automatic on/off control of the exterior lights normally controlled by the headlamp control.

The autolamp system also keeps the lights on for approximately 20 seconds or, if equipped with a message center, you can select a delay from 0–180 seconds after the ignition switch is turned off. See *Message center* in the *Instrument Cluster* chapter.

- To turn autolamps on, rotate the control counterclockwise one position.
- To turn autolamps off, rotate the control to the off position.

**INSTRUMENT LIGHTING DIMMER**

Use to adjust the brightness of the instrument panel when exterior lights are on.

- Rotate the control from left to right to brighten the instrument panel.
- Rotate the control from right to left to dim the instrument panel.
- Rotate the control fully to the right (past detent) to turn on interior lamps.
- Rotate the control to the left position (past detent) to turn off the interior lamps and to disable the illuminated entry feature. When the control is in the far left position, it acts as a dome lamp defeat/override.

**Note:** If the battery is disconnected, discharged, or a new battery is installed, the instrument lighting dimmer requires re-calibration. Rotate the control from the full dim position to the full dome/on position to reset. This will ensure that your displays are visible under all lighting conditions.

**DAYTIME RUNNING LAMPS (DRL) (IF EQUIPPED)**

 **WARNING:** Always remember to turn on your headlamps at dusk or during inclement weather. The Daytime Running Lamp (DRL) system does not activate the tail lamps and generally may not provide adequate lighting during these conditions. Failure to activate your headlamps under these conditions may result in a collision.

Turns the fog lamps on at full intensity output. To activate:

- the ignition must be in the on position and
- the headlamp control must be in the off, parking lamps or autolamp position.

**FRONT FOG LAMPS**

The control also operates the fog lamps. The fog lamps can be turned on when the control is in the parking lamps on, headlamps on, or autolamps positions and the high beams are not turned on.

Pull the control towards you to turn the fog lamps on. The fog lamp indicator light will illuminate.

**DIRECTION INDICATORS**

- Push down to activate the left turn signal.
- Push up to activate the right turn signal.

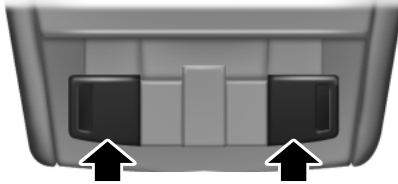
**INTERIOR LAMPS****Front Row Map Lamps**

To turn on the map lamps, press the outer edge of the clear lens. The front row map lamp lights when:

- any door is opened.
- the instrument panel dimmer switch is rotated until the courtesy lamps come on.
- the remote entry controls are pressed and the ignition is off.

**Second Row Map Lamps**

The second row map lamps are located in the headliner above the second row seats.

The second row map lamp lights when:

- any door is opened,
  - the instrument panel dimmer switch is rotated until the courtesy lamps come on, and
  - any of the remote entry controls are pressed and the ignition is off.
- Press the controls to activate the lamps.

**Rear Cargo Lamp**

The rear cargo lamp lights when:



- any door is opened, and the switch is in the middle position.
- the instrument panel dimmer switch is rotated until the courtesy lamps come on.
- any of the remote entry controls are pressed and ignition is off (and switch is in the middle position).

With the ignition key in the accessory or on position, the rear cargo lamp can be turned on or off by sliding the control.

**Battery saver**

The battery saver will shut off the exterior lamps and interior lamps, except the hazard warning lamps if activated, 10 minutes after the ignition control has been turned off. The system will not turn off the parking lamps if the lighting control is in the parking lamps on position.

**POWER WINDOWS**

**WARNING:** Do not leave children unattended in your vehicle and do not let them play with the power windows. They may seriously injure themselves.



**WARNING:** When closing the power windows, you should verify they are free of obstructions and make sure that children and pets are not in the proximity of the window openings.

**Note:** You may hear a pulsing noise when just one of the windows is open. Lower the opposite window slightly to reduce this noise.

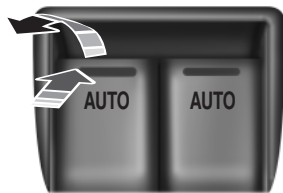

Press the switch to open the window.

Lift the switch to close the window.

**One-Touch Down (If Equipped)**

Press the switch fully and release it. Press again or lift it to stop the window.

**One-Touch Up (If Equipped)**

Lift the switch fully and release it. Press or lift it again to stop the window.

**Bounce-Back (If Equipped)**

The window will stop automatically while closing and reverse some distance if there is an obstacle in the way.

**Overriding the Bounce-Back Feature**

**WARNING:** When you override the bounce-back feature the window will not reverse if it detects an obstacle. Take care when closing the windows to avoid personal injury or damage to your vehicle.

Pull up the window switch and hold within two seconds of the window reaching the bounce-back position. The window will travel up with no bounce-back protection. The window will stop if you release the switch before the window is fully closed.

### Window Lock

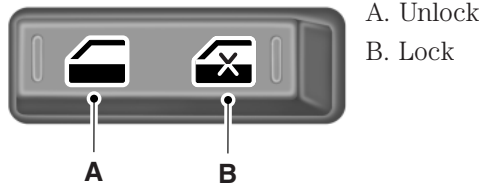

Press the control to lock or unlock the rear window controls.

### Accessory Delay

You can use the window switches for several minutes after you switch the ignition off, or until you open either front door.

## EXTERIOR MIRRORS

### Power Exterior Mirrors



**WARNING:** Do not adjust the mirror while your vehicle is in motion.

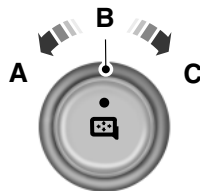

To adjust your mirrors:

1. Select the mirror you want to adjust.
2. Move the control in the direction you want to tilt the mirror.
3. Return the control to the center position to lock mirrors in place.

**Power-Folding Mirrors**

**Note:** Activating the mirrors 10 or more times within one minute, or repeated folding and unfolding of the mirrors while holding the control down during full travel, may disable the system to protect motors from overheating. Wait approximately three minutes with the vehicle running, and up to 10 minutes with the vehicle off, for the system to reset and for function to return to normal.



Pull the control back to fold the mirrors in or out.

**Loose Mirror**

A mirror may also be manually folded by pulling it toward the door window glass. This may cause the mirror to appear loose and it will need to be re-synchronized. Pull and hold the control to fold the mirrors in until movement stops. A click will be heard indicating re-synchronization. If the click is not heard, use the control to fold the mirrors all the way out, then in again. Once the click is heard the mirrors will operate normally until they are again manually folded.

**Heated Exterior Mirror**

The heated exterior mirrors switch on with the heated rear window. See *Heated Windows and Mirrors* in the *Climate Control* chapter.

**Memory Mirrors**

You can save and recall the mirror positions through the memory function. See *Memory function* in the *Seats* chapter.

**Auto-Dimming Feature**

The driver's side exterior mirror will automatically dim when the interior auto-dimming mirror is activated.

**Signal Indicator Mirrors**

The rear-facing portion of the appropriate mirror housing will blink when the turn signal is activated.

**Integrated Blind Spot Mirrors**

**WARNING:** Objects in the blind spot mirror are closer than they appear.

Blind spot mirrors have an integrated convex mirror built into the upper outboard corner of the exterior mirrors. They are designed to assist you by increasing visibility along the side of your vehicle.

Check the main mirror first before a lane change, then check the blind spot mirror. If no vehicles are present in the blind spot mirror and the traffic in the adjacent lane is at a safe distance, signal that you are going to change lanes. Glance over your shoulder to verify traffic is clear, and carefully change lanes.

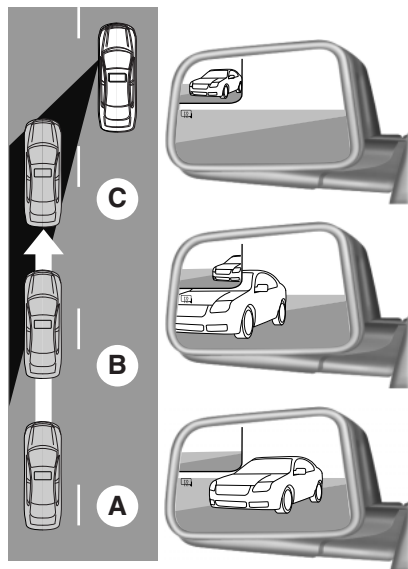

The image of the approaching vehicle is small and near the inboard edge of the main mirror when it is at a distance. The image becomes larger and begins to move outboard across the main mirror as the vehicle approaches (A). The image will transition from the main mirror and begin to appear in the blind spot mirror as the vehicle approaches (B). The vehicle will transition to your peripheral field of view as it leaves the blind spot mirror (C).

**INTERIOR MIRROR**

**WARNING:** Do not adjust the mirror when your vehicle is moving.

**Note:** Do not clean the housing or glass of any mirror with harsh abrasives, fuel or other petroleum or ammonia based cleaning products.

You can adjust the interior mirror to your preference. Some mirrors also have a second pivot point. This lets you move the mirror head up or down and from side to side.

**Auto-Dimming Mirror**

**Note:** Do not block the sensors on the front and back of the mirror. Mirror performance may be affected. A rear center passenger or raised rear center head restraint may also block light from reaching the sensor.

The mirror will dim automatically to reduce glare when bright lights are detected from behind your vehicle. It will automatically return to normal reflection when you select reverse gear to make sure you have a clear view when backing up.

**CHILDMINDER MIRROR (IF EQUIPPED)**

On double bin overhead consoles, the conversation mirror allows the driver to view the rear seating area.



**WARNING:** Do not use the childminder mirror to view rearward traffic, do not allow rear passengers to distract you from the driving task, and make sure the rear view mirror has a clear view of rearward traffic. Failure to do so could increase the risk of a crash from an unseen vehicle, which may result in serious injury.

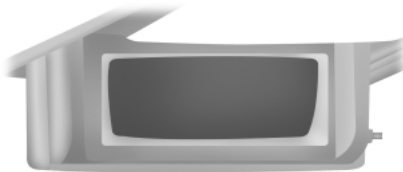

Press the release area on the rear edge of the bin door to open the childminder mirror. The door will open to full open position.

The rear view mirror may have to be adjusted to its lower arm position to prevent interference when the childminder mirror is extended down.

### REAR QUARTER WINDOWS

 **WARNING:** Do not leave children unattended in the vehicle and do not let children play with the power rear quarter windows. They may seriously injure themselves.

 **WARNING:** When closing the power rear quarter windows, you should verify that it is free of obstructions and ensure that children and/or pets are not in the proximity of the window opening.

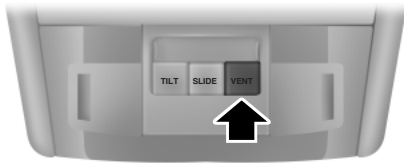

Press and hold the **VENT** control to open the windows.

Pull and hold the **VENT** control to close the windows.

**Note:** Vehicles without a moonroof will only have the **VENT** button.

### SUN VISORS

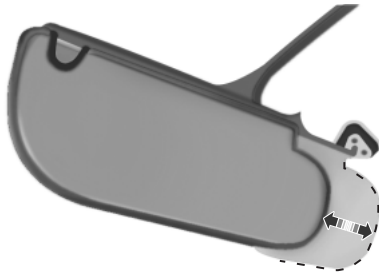

Rotate the visor toward the side window and extend it rearward for extra sunlight coverage.

**Illuminated Visor Vanity Mirror**

Lift the cover to switch on the lamp.

**MOONROOF (IF EQUIPPED)**

**WARNING:** Do not let children play with the moonroof or leave children unattended in the vehicle. They may seriously hurt themselves.



**WARNING:** When closing the moonroof, you should verify that it is free of obstructions and ensure that children and/or pets are not in the proximity of the moonroof opening.

The sliding shade can be manually opened or closed when the moonroof is closed. Pull the shade toward the front of the vehicle to close it.

The moonroof control is located on the overhead console.

The moonroof has a one-touch open and close feature. To stop its motion during the one-touch operation, press the control a second time.

---

**Opening and Closing the Moonroof**

Press and release the **SLIDE** control to open the moonroof. The moonroof will stop short of the fully opened position.

**Note:** This position helps to reduce rumbling wind noise which may happen with the moonroof fully open. Press and release the control again to fully open the moonroof.

Pull and release the **SLIDE** control to close the moonroof.

**Bounce-Back**

The moonroof will stop automatically while closing and reverse some distance if there is an obstacle detected.

Pull and hold the **SLIDE** control within two seconds of a bounce-back event to override the function. While bounce-back is active, the closing force increases for each of the next three times the moonroof is closed.

**Venting the Moonroof**

Press and release the **TILT** control to move the moonroof to the vent position. Pull and hold the **TILT** control to close the moonroof.

## GAUGES

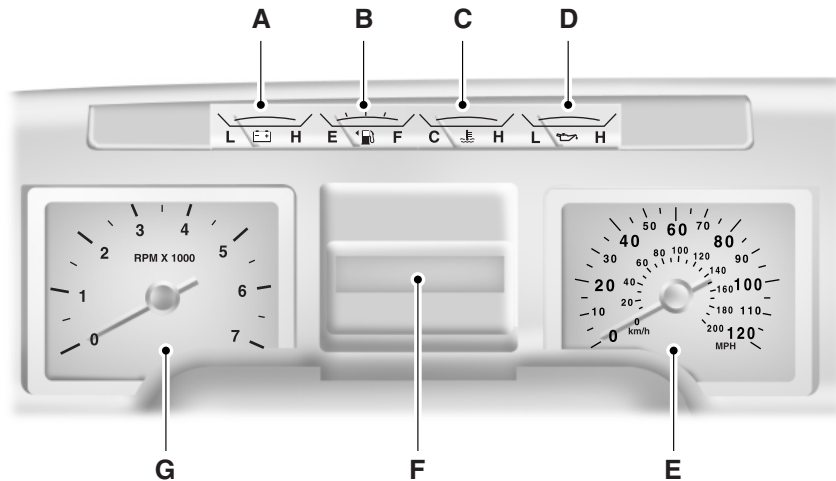

Cluster shown in standard measure. Metric similar.

- A. Battery voltage gauge
- B. Fuel gauge
- C. Engine coolant temperature gauge
- D. Engine oil pressure gauge
- E. Speedometer
- F. Information display. See *Information displays* for more information.
- G. Tachometer

### Battery Voltage Gauge

Indicates the battery voltage when the ignition is in the on position. If the pointer moves and stays outside the normal operating range, have the vehicle's electrical system checked by your authorized dealer as soon as possible.

**Fuel Gauge**

Indicates approximately how much fuel is left in the fuel tank (when the ignition is on). The fuel gauge may vary slightly when the vehicle is in motion or on a grade. The fuel icon and arrow indicates which side of the vehicle the fuel filler door is located.

**Engine Coolant Temperature Gauge**

Indicates engine coolant temperature. At normal operating temperature, the level indicator will be in the normal range. If the engine coolant temperature exceeds the normal range, stop the vehicle as soon as safely possible, switch off the engine and let the engine cool.



**WARNING:** Never remove the coolant reservoir cap while the engine is running or hot.

**Engine Oil Pressure Gauge**

Indicates engine oil pressure. The needle should stay in the normal operating range. If the needle falls below the normal range, stop the vehicle, turn off the engine and check the engine oil level. Add oil if needed. If the oil level is correct, have your vehicle checked at your authorized dealer.

**Information Display****Odometer**

Located in the bottom of the information display Registers the accumulated distance your vehicle has travelled.

**Trip Computer**

See *Trip A/B* in *Information Displays*.

**Vehicle Settings and Personalization**

See *Information Displays*.

**WARNING LAMPS AND INDICATORS**

The following warning lamps and indicators will alert you to a vehicle condition that may become serious. Some lamps will illuminate when you start your vehicle to make sure they work. If any lamps remain on after starting your vehicle, refer to the respective system warning lamp for further information.

**Note:** Some warning indicators appear in the information display and function the same as a warning lamp but do not display when you start your vehicle.

**Airbag – Front**

If it fails to illuminate on startup, continues to flash or remains on, it indicates a malfunction. Have the system checked by your authorized dealer. A chime will sound when there is a malfunction in the indicator light.

**Anti-Lock Braking System**

If it illuminates when you are driving, this indicates a malfunction. You will continue to have the normal braking system (without ABS) unless the brake warning lamp is also illuminated. Have the system checked by your authorized dealer.

**Battery**

If it illuminates while driving, it indicates a malfunction. Switch off all unnecessary electrical equipment and have the system checked by your authorized dealer.

**Brake System**

It will illuminate when the parking brake is engaged and the ignition is on.

If it illuminates when you are driving, check that the parking brake is not engaged. If the parking brake is not engaged, this indicates low brake fluid level or a brake system malfunction. Have the system checked immediately by your authorized dealer.



**WARNING:** Driving a vehicle with the brake system warning light on is dangerous. A significant decrease in braking performance may occur. It will take you longer to stop the vehicle. Have the vehicle checked by your authorized dealer as soon as possible. Driving extended distances with the parking brake engaged can cause brake failure and the risk of personal injury.

**Charging System**

It will illuminate when the 12-volt battery is not charging properly. Contact your authorized dealer as soon as possible. This indicates a problem with the electrical system or a related component.

**Check 4X4**

Displays with the message CHECK 4X4 when a four-wheel drive fault is present. Refer to the *Information Displays* chapter for more information.

**Cruise Control**

It will illuminate when you switch this feature on.

**Direction Indicator**

Illuminates when the left or right turn signal or the hazard warning flasher is switched on. If the indicators stay on or flash faster, check for a burned out bulb.

**Door Ajar**

Displays when the ignition is on and any door is not completely closed.

**Engine Oil**

If it illuminates with the engine running or when you are driving, this indicates a malfunction. Stop your vehicle as soon as it is safe to do so and switch the engine off. Check the engine oil level.

**Note:** Do not resume your journey if it illuminates despite the level being correct. Have the system checked by your authorized dealer.

**Engine Coolant Temperature**

Illuminates when the engine coolant temperature is high. Stop the vehicle as soon as possible, switch off the engine and let cool.

**Fasten Safety belt**

It will illuminate and a chime will sound to remind you to fasten your safety belt.

**High Beam**

It will illuminate when the headlamp high beam is switched on. It will flash when you use the headlamp flasher.

**Low Fuel Level**

It will illuminate when the fuel level is low or near empty. Refuel as soon as possible.

**Low Tire Pressure Warning**

It will illuminate when your tire pressure is low. If the lamp remains on with the engine running or when driving, check your tire pressure as soon as possible.

The lamp also illuminates momentarily when you switch the ignition on to confirm the lamp is functional. If it does not illuminate when you switch the ignition on, or begins to flash at any time, have the system checked by your authorized dealer.

**Low Washer Fluid**

It will illuminate when the windshield washer fluid is low.

**Powertrain Malfunction/Reduced Power**

Illuminates when a powertrain fault has been detected. Contact your authorized dealer as soon as possible.

**Security/Anti-Theft System**

Flashes when the SecuriLock® passive anti-theft system has been activated.

**Service Engine Soon**

The *service engine soon* indicator light illuminates when the ignition is first turned to the on position to check the bulb and to indicate whether the vehicle is ready for Inspection/Maintenance (I/M) testing. Normally, the “service engine soon” light will stay on until the engine is cranked, then turn itself off if no malfunctions are present. However, if after 15 seconds the “service engine soon” light blinks eight times, it means that the vehicle is not ready for I/M testing. See the *Readiness for inspection/maintenance (I/M) testing* in the *Fuel and Refueling* chapter.

Solid illumination after the engine is started indicates the on-board diagnostics system (OBD-II) has detected a malfunction. Refer to *On-board diagnostics (OBD-II)* in the *Fuel and Refueling* chapter. If the light is blinking, engine misfire is occurring which could damage your catalytic converter. Drive in a moderate fashion (avoid heavy acceleration and deceleration) and have your vehicle serviced immediately by your authorized dealer.



**WARNING:** Under engine misfire conditions, excessive exhaust temperatures could damage the catalytic converter, the fuel system, interior floor coverings or other vehicle components, possibly causing a fire.

#### Stability Control System



Displays when the AdvanceTrac®/Traction control is active. If the light remains on, have the system serviced immediately.

#### Stability Control System Off



Illuminates when AdvanceTrac®/Traction control has been disabled by the driver.

#### Transmission Tow/Haul



Illuminates when the Tow/Haul feature has been activated. Refer to the *Transmission* chapter for transmission function and operation. If the light flashes steadily, have the system serviced immediately, damage to the transmission could occur.

#### 4X4



Illuminates when four-wheel drive high is engaged. If the light fails to display when the ignition is turned on, or remains on, have the system serviced immediately by your authorized dealer.

#### 4X4 AUTO



Displays when using the 4x4 system.

**AUDIBLE WARNINGS AND INDICATORS****Key In Ignition Warning Chime**

Sounds when the key is left in the ignition in the off or accessory position and the driver's door is opened.

**Headlamps On Warning Chime**

Sounds when the headlamps or parking lamps are on, the ignition is off (the key is not in the ignition) and the driver's door is opened.

**Parking Brake On Warning Chime**

Sounds when you have left the parking brake on and drive your vehicle. If the warning chime remains on after you have released the parking brake, have the system checked by your authorized dealer immediately.

**Turn Signal Chime**

Sounds when the direction indicator has been activated to signal a turn and not turned off after the vehicle is driven more than 1.5 miles (2.4 km).

**GENERAL INFORMATION**

 **WARNING:** Driving while distracted can result in loss of vehicle control, crash and injury. We strongly recommend that you use extreme caution when using any device that may take your focus off the road. Your primary responsibility is the safe operation of your vehicle. We recommend against the use of any handheld device while driving and encourage the use of voice-operated systems when possible. Make sure you are aware of all applicable local laws that may affect the use of electronic devices while driving..

Various systems on your vehicle can be controlled using the information display controls on the steering wheel. Corresponding information is displayed in the information display.

**Information Display Controls**



- Press the INFO button to scroll through trip, fuel usage, and MyKey® information.
- Press the SETUP button to scroll through various vehicle feature settings.
- Press the RESET button to choose settings, reset information and confirm messages.

**Info**

Press the INFO button repeatedly to cycle through the following features:

**Note:** Some options may appear slightly different or not at all if the items are optional.

INFO
TRIP A/B
MYKEY MILES (km) (if programmed)
MILES (km) TO E
AVG MPG (L/100km)

INFO
MPG (L/km)
TBC GAIN = XX.X (if equipped)
TIMER

- TRIP A/B: Registers the distance of individual journeys. Press and release INFO button until the A or B trip appears in the display (this represents the trip mode). Press the RESET button to reset. Refer to *UNITS* later in this section to switch the display from metric to English.
- MYKEY MILES (km) (if programmed): For more information, refer to the *MyKey*® chapter.
- MILES (km) TO E: This displays an estimate of approximately how far you can drive with the fuel remaining in your tank under normal driving conditions. Remember to turn the ignition off when refueling to allow this feature to correctly detect the added fuel. Distance to empty is calculated using a running average fuel economy, which is based on your recent driving history of 500 miles (800 km). This value is not the same as the average fuel economy display. The running average fuel economy is re-initialized to a factory default value if the battery is disconnected.
- AVG MPG (L/100km): Average fuel economy displays your average fuel economy in miles/gallon or liters/100 km.
- MPG (L/km): This displays instantaneous fuel economy as a bar graph. Your vehicle must be moving to calculate instantaneous fuel economy. Instantaneous fuel economy cannot be reset.
- TBC GAIN (if equipped): Displays the level of trailer brake gain or if the trailer is not connected.
- TIMER: Displays the trip elapsed drive time. Press and release RESET to pause the timer. Press and hold RESET to reset the timer.

**System Check and Vehicle Feature Customization**

Press the SETUP button repeatedly to cycle the message center through the following features:



SETUP		
RESET FOR SYSTEM CHECK	press the RESET button	OIL LIFE
		CHARGING SYSTEM
		WASHER FLUID LEVEL
		DOOR AJAR STATUS
		LIFTGATE/GLASS AJAR STATUS
		BRAKE SYSTEM
		MYKEY MILES (if programmed)
		MYKEY(S) PROGRAMMED
		ADMIN KEYS PROGRAMMED
		MILES TO EMPTY
TBC GAIN = XX.X (if equipped)		
OIL LIFE		

SETUP		
UNITS	press the RESET button	English or Metric
AUTOLAMP (SEC)		0 to 180 seconds
AUTOLOCK		On or Off
AUTOUNLOCK		On or Off
RUNNING BOARDS (if equipped)		Auto / Off / Out
POWER LIFTGATE (if equipped)		On or Off
EASY ENTRY		On or Off
REAR PARK AID (if equipped)		On or Off
FRONT PARK AID (if equipped)		On or Off
TRAILER SWAY (if equipped)		On or Off
TBC MODE (if equipped)		
CREATE MYKEY / MYKEY SETUP / CLEAR MYKEY		
COMPASS		
ENGLISH / FRENCH / SPANISH RESET FOR NEW	press the RESET button	English / Spanish / French (press and hold to set)

- **RESET FOR SYSTEM CHECK:** The message center will begin to cycle through the vehicle systems and provide a status of the item if needed. Some systems show a message only if a condition is present.
- **OIL LIFE:** This displays the remaining oil life. An oil change is required whenever indicated by the message center and according to the recommended maintenance schedule. **USE ONLY RECOMMENDED ENGINE OILS.**

To reset the oil monitoring system to 100% after each oil change, perform the following:

1. Press and release the SETUP button to display “OIL LIFE XXX% HOLD RESET = NEW”.
2. Press and hold the RESET button for two seconds and release to reset the oil life to 100%.

**Note:** To change oil life 100% value (if equipped with this feature) to another value, proceed to Step 3.

3. Once “OIL LIFE SET TO XXX%” is displayed, release and press the RESET button to change the Oil Life Start Value. Each release and press will reduce the value by 10%.

- UNITS: Displays the current units in English or Metric.
- AUTOLAMP (SEC): This feature keeps your headlights on for up to three minutes after the ignition is switched off.
- AUTOLOCK: This feature automatically locks all vehicle doors when the vehicle is shifted into any gear, putting the vehicle in motion.
- AUTOUNLOCK: This feature automatically unlocks all vehicle doors when the driver’s door is opened within 10 minutes of the ignition being turned off.
- RUNNING BOARDS (if equipped): This feature automatically deploys the side running boards for easy entry/exit from the vehicle or for cleaning.

Auto: The running boards will automatically deploy when a door is opened and automatically retract when the door is closed

Out: The running boards will remain deployed regardless of the doors being open/closed. This setting can be used when washing the vehicle, or accessing the roof rack. The running boards will stow and enter AUTO mode when the vehicle speed exceeds 5 mph (8 km/h).

Off: The running boards will remain in regardless of the doors being open/closed.

- POWER LIFTGATE (if equipped): This feature allows users to open/close the rear liftgate at the touch of a button. If disabled, the outside release handle and the rear cargo area control button are off. The instrument panel button will continue to function the liftgate in power mode.

- EASY ENTRY / EXIT: This feature automatically moves the driver's seat rearward and adjusts the steering column for easy exit/entry from the vehicle.
- REAR PARK AID (if equipped): This feature sounds a tone to warn the driver of obstacles near the rear bumper, and functions only when R (Reverse) gear is selected.
- FRONT PARK AID (if equipped): This feature sounds a warning tone to warn the driver of obstacles near the front bumper.
- TRAILER SWAY (if equipped): This feature uses the electronic stability control to mitigate trailer sway.
- TBC MODE (if equipped): Allows you to choose the trailer brake mode.
- CREATE MYKEY / MYKEY SETUP / CLEAR MYKEY: For more information refer to the *MyKey®* chapter.
- COMPASS: Displays the vehicle's heading direction.

The compass reading may be affected when you drive near large buildings, bridges, power lines and powerful broadcast antenna. Magnetic or metallic objects placed in, on or near the vehicle may also affect compass accuracy. If the compass appears to be inaccurate, a manual calibration may be necessary. Refer to *Compass zone adjustment*

#### Compass zone adjustment

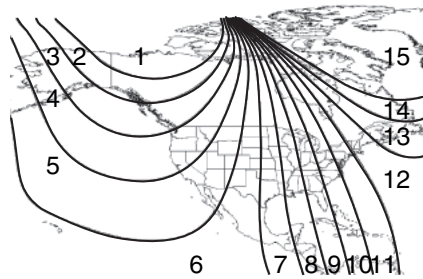

1. Determine which magnetic zone you are in for your geographic location by referring to the zone map.
2. Start the engine.
3. Press SETUP to reach the reset for zone setting screen.
4. Press and hold RESET until the message center display prompts you to reset the current zone setting. Press RESET.
5. Press and release RESET until the message center display changes to show the current zone setting (XX).

6. Press and release the RESET button repeatedly until the correct zone setting for your geographic location is displayed on the message center.
7. Press and release SETUP and allow the setup timer to expire to exit the procedure or press INFO to exit.

**Compass calibration adjustment**

**Note:** For optimum calibration, drive to an open, level location away from large metallic objects or structures. Switch off all non-essential electrical accessories (heated rear window, heater, A/C, map lamps, wiper, etc.) and make sure all the doors are closed

**Note:** If the RESET button is pressed or three minutes has expired, the display will go back to the INFO menu and will show CAL instead of the compass heading until the compass is calibrated.

1. Press RESET to start the compass calibration function.
2. Slowly drive the vehicle in a circle (less than 3 mph [5 km/h]) until the CIRCLE SLOWLY TO CALIBRATE display changes to CALIBRATION COMPLETED. It will take up to five circles to complete calibration.
3. The compass is now calibrated.
  - ENGLISH / FRENCH / SPANISH RESET FOR NEW: Allows you to choose which language the message center will display in.  
Press RESET to cycle through each of the language choices.  
Press and hold RESET for two seconds to set the language choice.

**INFORMATION MESSAGES**

**Note:** Depending on the vehicle options equipped with your vehicle, not all of the messages will display or be available. Certain messages may be abbreviated or shortened depending upon which cluster type you have.

Press the RESET button for Type 1 displays or the OK button for Type 2 displays to acknowledge and remove some messages from the information display. Other messages will be removed automatically after a short time. Certain messages need to be confirmed before you can access the menus.

<b>AdvanceTrac® / Traction Control Messages</b>	<b>Action / Description</b>
<b>SERVICE ADVANCETRAC</b>	Displayed when the AdvanceTrac® system has detected a condition that requires service. Contact your authorized dealer as soon as possible.
<b>Battery and Charging System Messages</b>	<b>Action / Description</b>
<b>CHECK CHARGING SYSTEM</b>	Displayed when the charging system needs servicing. If the warning stays on or continues to come on, contact your authorized dealer as soon as possible.
<b>Brake System Messages</b>	<b>Action / Description</b>
<b>BRAKE FLUID LEVEL LOW</b>	Indicates the brake fluid level is low and the brake system should be inspected immediately. Refer to <i>Brake fluid</i> in the <i>Maintenance</i> chapter.
<b>CHECK BRAKE SYSTEM</b>	Displayed when the brake system needs servicing. If the warning stays on or continues to come on, contact your authorized dealer as soon as possible.
<b>PARK BRAKE ENGAGED</b>	Displayed when the parking brake is set and the vehicle is in motion.
<b>Door Messages</b>	<b>Action / Description</b>
<b>DOOR AJAR</b>	Displayed when a door is not completely closed.
<b>LIFTGATE / GLASS AJAR</b>	Displayed when the liftgate or liftgate glass is not completely closed.

<b>Fuel Messages</b>	<b>Action / Description</b>
<b>CHECK FUEL FILL INLET</b>	Displayed when the fuel fill inlet may not be properly closed.
<b>XXX MILES TO E FUEL LEVEL LOW</b>	Displayed as an early reminder of a low fuel condition.
<b>Maintenance Messages</b>	<b>Action / Description</b>
<b>ENGINE OIL CHANGE SOON</b>	Displayed when the engine oil life is nearing its end.
<b>OIL CHANGE REQUIRED</b>	Displayed when the oil life left reaches 0%.
<b>WASHER FLUID LEVEL LOW</b>	Indicates the washer fluid reservoir is less than one quarter full. Check the washer fluid level.
<b>MyKey® Messages</b>	<b>Action / Description</b>
<b>MYKEY ACTIVE DRIVE SAFELY</b>	Displayed when MyKey® is active.
<b>VEHICLE NEAR TOP SPEED</b>	Displayed when a MyKey® is in use and the MyKey speed limit is on and the vehicle speed is approaching 80 mph (130 km/h).
<b>VEHICLE AT TOP SPEED - MYKEY SETTING</b>	Displayed when a MyKey® is in use and the MyKey speed limit is on and the vehicle speed is 80 mph (130 km/h).
<b>TOP SPEED MYKEY SETTING</b>	Displayed when a MyKey® is in use and the MyKey speed limit is on and the vehicle speed is 80 mph (130 km/h).
<b>SPEED LIMITED TO 80 MPH</b>	Displayed when starting the vehicle and MyKey® is in use and the MyKey speed limit is on.
<b>VEHICLE SPEED 80 MPH MAX</b>	Displayed when a MyKey® is in use and the Admin has enabled the MyKey speed limit and the vehicle speed is 80 mph (130 km/h).

<b>MyKey® Messages</b>	<b>Action / Description</b>
<b>CHECK SPEED DRIVE SAFELY</b>	Displayed when a MyKey® is in use and the optional setting is on and the vehicle exceeds a preselected speed.
<b>BUCKLE UP TO UNMUTE AUDIO</b>	Displayed when a MyKey® is in use and Belt-Minder® is activated.
<b>KEY COULD NOT PROGRAM</b>	Displayed when an attempt is made to program a spare key using two existing MyKeys.
<b>ADVTRAC ON MYKEY SETTING</b>	Displayed when a MyKey® is in use when trying to disable the AdvanceTrac® system and the optional setting is on.
<b>Park Aid Messages</b>	<b>Action / Description</b>
<b>CHECK PARK AID</b>	Displayed when the transmission is in R (Reverse).
<b>Tire Messages</b>	<b>Action / Description</b>
<b>LOW TIRE PRESSURE</b>	Displays when one or more tires on your vehicle have low tire pressure.
<b>TIRE PRESSURE MONITOR FAULT</b>	Displays when the tire pressure monitoring system is malfunctioning. If the warning stays on or continues to come on, contact your authorized dealer.
<b>TIRE PRESSURE SENSOR FAULT</b>	Displayed when a tire pressure sensor is malfunctioning, or your spare tire is in use. For more information on how the system operates under these conditions refer to the <i>Tire Pressure Monitoring System</i> in the <i>Wheels and Tires</i> chapter for more information. If the warning stays on or continues to come on, contact your authorized dealer as soon as possible.

Trailer Messages	Action / Description
<b>TRAILER SWAY REDUCE SPEED</b>	Displayed when the trailer sway control has detected trailer sway.
4WD Messages	Action / Description
<b>4X4 SHIFT IN PROGRESS</b>	Displayed when the 4X4 system is making a shift.

**CLOCK**



Press A to move the time display backwards.

Press B to move the time display forwards.

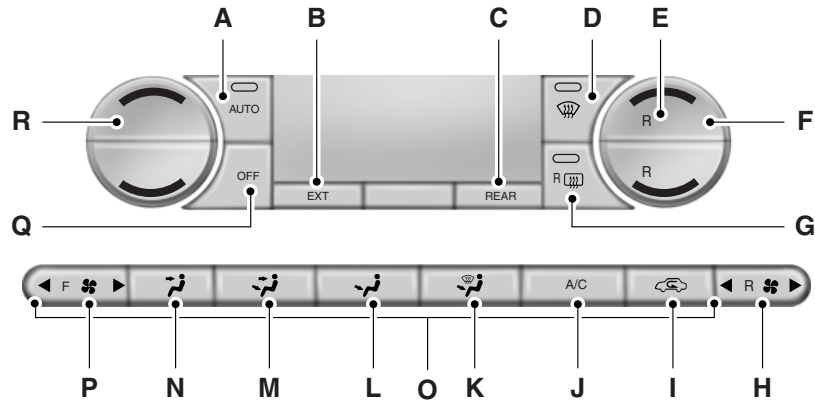
**DUAL AUTOMATIC TEMPERATURE CONTROL SYSTEM WITHOUT HEATED AND COOLED SEATS**

A. **AUTO:** Press to turn on fully automatic operation. Select the desired temperature using the temperature control. The system automatically determines fan speed, air distribution, air conditioning operation, and outside or recirculated air, to heat or cool the vehicle to maintain the selected temperature.

B. **EXT:** Press to display the outside temperature. Press again to display the interior temperature.

**Note:** The exterior temperature reading is more accurate when the vehicle is moving.

C. **REAR (on/off):** Press to turn on the auxiliary climate controls in the rear of the floor console. Press again to turn the auxiliary system off. When this button is pressed, the display only shows the rear temperature setting. After the rear setting changes are completed on the front control, the display automatically shows both climate settings.

D. **Defrost:** Distributes air through the windshield defroster vents and demister vents. This setting can also be used to defog and clear the windshield of a thin covering of ice.

E. **REAR (temperature control):** Press to turn on the auxiliary climate control system and to set the desired rear temperature with the front control. The rear temperature is the same as the front temperature when only the center rear temperature bar is lit. The rear temperature is different from the front temperature when more than one rear temperature bar is lit.

When this button is pressed, the display only shows the rear temperature setting. After the rear setting changes are completed on the front control, the display automatically shows both climate settings.

**F. Passenger temperature control:** Press and turn to increase or decrease the air temperature on the passenger side of the vehicle.

**G. Rear defrost:** Press to turn the heated windows and mirrors off and on. See *Heated windows and mirrors* later in this chapter for more information.

**H. Auxiliary climate control fan speed:** Press to turn on the auxiliary climate control system or to adjust the rear fan speed from the front control.

**I. Recirculated air:** Press to switch between outside air and recirculated air. Using recirculated air can reduce the time needed to cool the interior and reduce unwanted odors from entering your vehicle.

**J. A/C:** Press to turn air conditioning off and on. Air conditioning cools the vehicle using outside air. To improve air conditioning when starting your vehicle, drive with the windows slightly open for two to three minutes.

**K. Floor/Defrost:** Distributes air through the windshield defroster vents, demister vents and floor vents.

**L. Floor:** Distributes air through the floor vents.

**M. Instrument panel/Floor:** Distributes air through the instrument panel vents, floor vents, and demister vents.

**N. Instrument panel:** Distributes air through the instrument panel vents.

**O. Manual override controls:** Press buttons I through P to override automatic control (AUTO). To return to automatic operation, press AUTO.

**P. Front fan speed control:** Controls the volume of air circulated in your vehicle. Press to increase or decrease fan speed.

**Q. OFF:** Turn the climate control system off. When the system is off, outside air cannot enter the vehicle.

**R. Driver temperature control:** Press to turn the climate control system off and on. Turn to increase or decrease the air temperature for the driver side of the vehicle.

This control also adjusts the passenger side temperature when dual zone operation is disengaged.

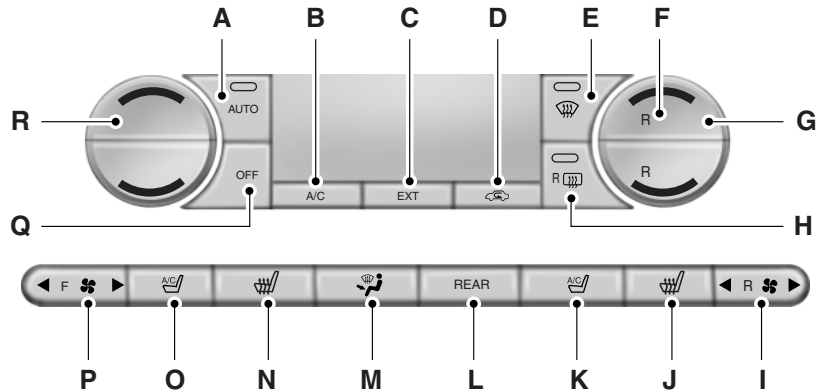
**DUAL AUTOMATIC TEMPERATURE CONTROL SYSTEM WITH HEATED AND COOLED SEATS**

A. **AUTO:** Press to turn on fully automatic operation. Select the desired temperature using the temperature control. The system automatically determines fan speed, air distribution, air conditioning operation, and outside or recirculated air, to heat or cool the vehicle to maintain the selected temperature.

B. **A/C:** Press to turn air conditioning off and on. Air conditioning cools the vehicle using outside air. To improve air conditioning when starting your vehicle, drive with the windows slightly open for two to three minutes.

C. **EXT:** Press to display the outside temperature. Press again to display the interior temperature.

**Note:** The exterior temperature reading is more accurate when the vehicle is moving.

D. **Recirculated air:** Press to switch between outside air and recirculated air. Using recirculated air can reduce the time needed to cool the interior and reduce unwanted odors from entering your vehicle.

E. **Defrost:** Distributes air through the windshield defroster vents and demister vents. This setting can also be used to defog and clear the windshield of a thin covering of ice.

F. **REAR (temperature control):** Press to turn on the auxiliary climate control system and to set the desired rear temperature with the front control. The rear temperature is the same as the front temperature when

only the center rear temperature bar is lit. The rear temperature is different from the front temperature when more than one rear temperature bar is lit.

When this button is pressed, the display only shows the rear temperature setting. After the rear setting changes are completed on the front control, the display automatically shows both climate settings.

**G. Passenger temperature control:** Press and turn to increase or decrease the air temperature on the passenger side of the vehicle.

**H. Rear defrost:** Press to turn the heated windows and mirrors off and on. See *Heated windows and mirrors* later in this chapter for more information.

**I. Auxiliary climate control fan speed:** Press to turn on the auxiliary climate control system or to adjust the rear fan speed from the front control.

**J. Passenger heated seat control:** Press to switch the passenger heated seat off and on. See *Heated seats* in the *Seats* chapter for more information.

**K. Passenger cooled seat control:** Press to switch the passenger cooled seat off and on. See *Heated and cooled seats* in the *Seats* chapter for more information.

**L. REAR (on/off):** Press to turn on the auxiliary climate controls in the rear of the floor console. Press again to turn the auxiliary system off. When this button is pressed, the display only shows the rear temperature setting. After the rear setting changes are completed on the front control, the display automatically shows both climate settings.

**M. Air distribution control:** Turn to set the air distribution to a position listed below:



Distributes air through the instrument panel vents.



Distributes air through the instrument panel vents, floor vents, and demister vents.



Distributes air through the floor vents.



Distributes air through the windshield defroster vents, demister vents and floor vents.

N. **Driver heated seat control:** Press to switch the driver heated seat off and on. See *Heated seats* in the *Seats* chapter for more information.

O. **Driver cooled seat control:** Press to switch the driver cooled seat off and on. See *Heated and cooled seats* in the *Seats* chapter for more information.

P. **Front fan speed control:** Controls the volume of air circulated in your vehicle. Press to increase or decrease fan speed.

Q. **OFF:** Turn the climate control system off. When the system is off, outside air cannot enter the vehicle.

R. **Driver temperature control:** Press to turn the climate control system off and on. Turn to increase or decrease the air temperature for the driver side of the vehicle.

This control also adjusts the passenger side temperature when dual zone operation is disengaged.

#### AUXILIARY CLIMATE CONTROL (IF EQUIPPED)

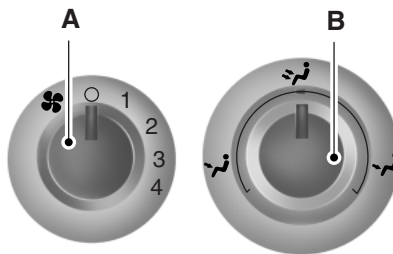

Your auxiliary climate controls are located on the rear of the center console and can be used when REAR has been pressed on the front climate control system. The temperature is set by the front controls. Use the rear control to adjust the fan speed or turn the auxiliary controls off (O).

A. **Fan speed control:** Turn to select the desired fan speed.

B. **Temperature and air distribution control:** The distribution of air is based on the temperature selected. Adjust for comfort.

**GENERAL OPERATING TIPS**

- To reduce fog build-up on the windshield during humid weather, select Defrost. Temperature and fan speed can also be increased to improve clearing.
- To reduce humidity build-up inside the vehicle, do not drive with the system off or with recirculated air engaged.
- Do not put objects under the front seats that will interfere with the airflow to the back seats.
- Remove any snow, ice or leaves from the air intake area at the base of the windshield.

Cooling the interior quickly:

1. Adjust the fan speed to the highest speed setting initially and then adjust it to suit the desired comfort level.
2. Adjust the temperature control to the lowest temperature setting.
3. Adjust the air distribution control to **MAX A/C**.

Recommended settings for cooling:

- Adjust the air distribution control to **A/C**.

If your vehicle stationary for extended periods during extreme high ambient temperatures

- Select **MAX A/C**.

For maximum cooling performance in manual override control:

1. Choose Panel, A/C, and recirc controls.
2. Set the temperature to LO.
3. Set the fan to the highest blower setting.

To aid in side window defogging and demisting in cold or humid weather:

1. Select Floor/Panel.
2. Select A/C.
3. Adjust the temperature control to maintain comfort.
4. Set the fan speed to the highest setting.
5. Direct the outer instrument panel vents toward the side windows.
6. To increase airflow to the outer instrument panel vents, close the vents located in the middle of the instrument panel.

**HEATED WINDOWS AND MIRRORS (IF EQUIPPED)****Heated Rear Window**

**Note:** The vehicle must be running to use this feature.

Press the control to clear the rear window of thin ice and fog. Press the control again within 15 minutes to switch it off. It turns off automatically after approximately 15 minutes, or when you switch off the ignition.

**Do not use razor blades or other sharp objects to clean the inside of the rear window or to remove decals from the inside of the rear window. This may cause damage to the heated grid lines. Your warranty does not cover this damage.**

**Heated Exterior Mirrors (If Equipped)**

**Note:** Do not remove ice from the mirrors with a scraper or attempt to readjust the mirror glass that has frozen in place. These actions could cause damage to the glass and mirrors.

**Note:** Do not clean the housing or glass of any mirror with harsh abrasives, fuel or other petroleum-based cleaning products.

Both mirrors heat to remove ice, mist and fog when you switch on the heated rear window.

**SITTING IN THE CORRECT POSITION**

**!** **WARNING:** Sitting improperly out of position or with the seatback reclined too far can take off weight from the seat cushion and affect the passenger sensing system, resulting in serious injury or death in a crash. Always sit upright against your seatback, with your feet on the floor.

**!** **WARNING:** Do not recline the seatback as this can cause the occupant to slide under the seat's safety belt, resulting in severe personal injury in the event of a crash.

**!** **WARNING:** Do not place objects higher than the seatbacks to reduce the risk of injury in a crash or during heavy braking or when stopping suddenly.

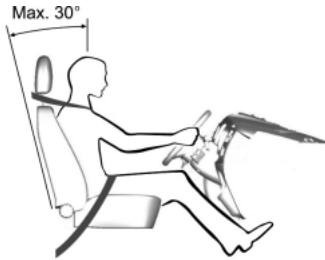



When you use them properly, the seat, head restraint, safety belt and airbags will provide optimum protection in the event of a crash. We recommend that you follow these guidelines:

- Do not recline the seatback more than 30 degrees from vertical.
- Sit in an upright position with the base of your spine as far back as possible.
- Adjust the head restraint so that the top of it is level with the top of your head and as far forward as possible, remaining comfortable.
- Keep sufficient distance between yourself and the steering wheel. We recommend a minimum of 10 inches (25 centimeters) between your breastbone and the airbag cover.
- Hold the steering wheel with your arms slightly bent.
- Bend your legs slightly so that you can press the pedals fully.
- Position the shoulder strap of the safety belt over the center of your shoulder and position the lap strap tightly across your hips.

Make sure that your driving position is comfortable and that you can maintain full control of your vehicle.

**HEAD RESTRAINTS**

 **WARNING:** To minimize the risk of neck injury in the event of a crash, you and the passenger occupants should not sit in or operate the vehicle, until the head restraint is placed in its proper position. Never adjust the head restraint while the vehicle is in motion.

 **WARNING:** The adjustable head restraint is a safety device. Whenever possible it should be installed and properly adjusted when the seat is occupied.

 **WARNING:** Install the head restraint properly to minimize the risk of neck injury in the event of a crash.

**Note:** Adjust the seat back to an upright driving position before adjusting any head restraint. Properly adjust the head restraint so that the top of the head restraint is even with the top of your head and positioned as close as possible to the back of your head. For occupants of extremely tall stature, adjust the head restraint to its full up position.

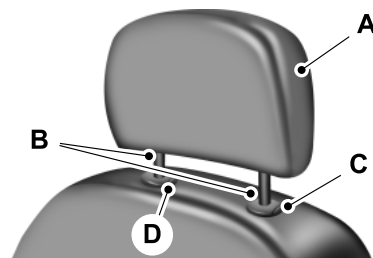
**Front Seat Head Restraints**

The head restraints consist of :

- A. An energy absorbing head restraint
- B. Two steel stems
- C. Guide sleeve adjust and release button
- D. Guide sleeve unlock and remove button

**Adjusting the Head Restraint**

Raise: Pull up the head restraint.

Lower:

1. Press and hold button C.
2. Push down on the head restraint.

Remove:

1. Pull up the head restraint until it reaches the highest adjustment position.
2. Press and hold buttons C and D.

3. Pull up the head restraint.

Reinstall Align the steel stems into the guide sleeves and push the head restraint down until it locks.

**Second row outboard seat head restraints** – The outboard head restraints are non-adjustable, but you can fold them.

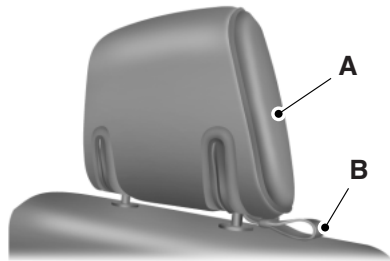

The non-adjustable head restraints consist of:

- A trimmed energy absorbing foam and structure (A).
- A fold strap (B).

1. Pull the fold strap to fold the outboard head restraint.

2. Pull up on the head restraint to place the head restraint back to the upright position.

**Second row center seat head restraint** – The center rear head restraint is fixed and non-adjustable. The head restraint consists of a trimmed foam covering over the upper structure of the seat back.

**Third row head restraints** – The third row head restraints are non-adjustable, but you can fold them.

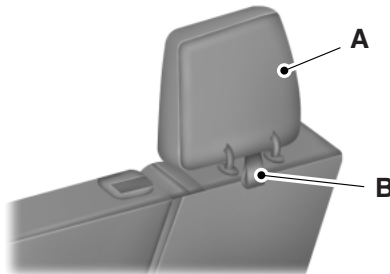

The non-adjustable head restraints consist of:

- A trimmed energy absorbing foam and structure (A).
- A fold strap (B).

1. Pull the fold strap to fold the head restraint.

2. Pull up on the head restraint to place the head restraint back to the upright position.

**POWER SEATS**

 **WARNING:** Before returning the seatback to its original position, make sure that cargo or any objects are not trapped behind the seatback.

 **WARNING:** Never adjust the driver seat or seatback when the vehicle is moving.

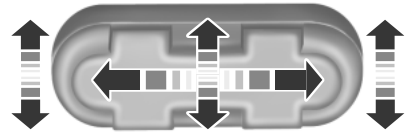

The control is located on the outboard side of the seat. Move the switch in the direction of the arrow to raise or lower the seat cushion or to move the seat forward, backward, up or down.

**Power Recline**

Move the switch to recline the seat back forward or rearward.

**Note:** On vehicles with memory seats, to prevent damage to the seat, the power seats are designed to set a stopping position just short of the end of the seat track. If the seat encounters an object while moving forward or backward, a new stopping position will be set.

To reset the seat to its normal stopping position:

1. After encountering the new stopping position, press the power seat control again to override.
2. Continue pressing the control until it reaches the end of the seat track.
3. Continue pressing the control for about two seconds. You will feel the seat bounce back slightly.

**Power Lumbar**

The control is located on the outboard side of the seat. Press the forward or rearward side of the control for more or less support.

**MEMORY FUNCTION**

This feature will save and recall the positions of the driver seat, power mirrors, adjustable pedals, and steering column.



The memory seat control is located on left side of the driver's seat.

**Programming Memory Positions**

1. Turn the ignition on.
2. To program position 1, move the memory features to their desired position using the associated controls.
3. Press and hold button 1 for about two seconds. A chime will sound confirming that a memory position has been set.

To program position 2, repeat the previous procedure using button 2.

You can program a memory position at any time.

To program the memory feature to a remote control transmitter, see the *Keys and Remote Control* chapter.

**Recalling Saved Memory Positions**

To recall position 1 settings, press and release memory button 1. The memory features will move to the saved memory 1 position.

You can also recall the memory positions when you:

- Press your remote control transmitter unlock button (if the remote control is programmed to a memory position) or,
- Enter a valid Securicode personal entry code that is programmed to a memory position.

If the easy entry and exit feature is on, the mirrors and pedals will move to the programmed memory position and the seat will move to the easy entry position. The seat will move to the driving memory position when the ignition is activated.

You can recall a programmed memory position:

- In any gearshift position if the ignition is not on.
- Only in park (P) or neutral (N) if the ignition is on.

**Easy Entry and Exit Feature**

If you enable the easy entry and exit feature, it automatically moves the drivers seat 2 inches (5 centimeters) rearward when the transmission is in park (P) and the key is removed from the ignition.

**Note:** If the seat is located less than 2 inches (5 centimeters) from the rear of the seat track, the seat travel will be less than 2 inches (5 centimeters) rearward.

The driver seat will return to the previous position when the key is put in the ignition.

Enable or disable this feature through the information display. See the *Information Displays* chapter for more information.

**Climate Controlled Seats (If Equipped)****Heated Seats**

**WARNING:** Persons who are unable to feel pain to the skin because of advanced age, chronic illness, diabetes, spinal cord injury, medication, alcohol use, exhaustion, or other physical conditions, must exercise care when using the seat heater. The seat heater may cause burns even at low temperatures, especially if used for long periods of time. Do not place anything on the seat that insulates against heat, such as a blanket or cushion, because this may cause the seat heater to overheat. Do not puncture the seat with pins, needles, or other pointed objects because this may damage the heating element which may cause the seat heater to overheat. An overheated seat may cause serious personal injury.

**Note:** Do not do the following:

- Place heavy objects on the seat.
- Operate the seat heater if water or any other liquid is spilled on the seat. Allow the seat to dry thoroughly.

The heated seats will only function when the engine is running.

To operate the heated seats:



Press the heated seat symbol to cycle through the various heat settings and off. Warmer settings are indicated by more indicator lights.

**Cooled Seats**

The cooled seats will only function when the engine is running.

To operate the cooled seats:



Press the cooled seat symbol to cycle through the various cooling settings and off. Cooler settings are indicated by more indicator lights.

If the engine falls below 350 RPM while the cooled seats are on, the feature will turn itself off. You will need to reactivate it.

**Heated and Cooled Seats Air Filter Replacement (If Equipped)**

The heated and cooled seat system includes air filters. You must replace them periodically. See *scheduled maintenance information* for more information.

There is a filter located under each front seat. You can access the filter from the second row seat. Move the front seats all the way forward and up to ease access.

To remove a filter:

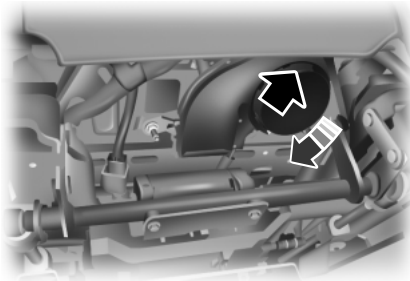

1. Remove the key from the ignition.
2. Press up on the outside rigid edge of the filter and rotate counterclockwise once the tabs are released.
3. Remove the filter.

To install a filter:

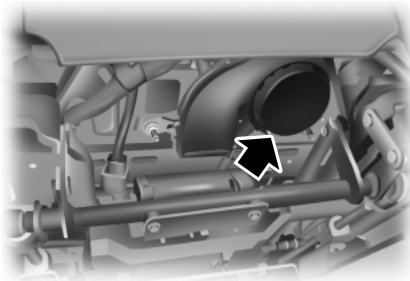

1. First, position the filter in its housing making sure that the far forward end is all the way up in the housing.
2. Then, push in on the center of the outside edge of the filter and rotate up into the housing until it clips into position.

**REAR SEATS**

**Folding Down the Second Row 40% Seat System**

**!** **WARNING:** Use caution when folding the seatback to the flat back position as the system will move forward when you lift the release handle.

**!** **WARNING:** Before returning the seatback to its original position, make sure that cargo or any objects are not trapped behind the seatback. After returning the seatback to its original position, pull on the seatback to make sure that it has fully latched. An unlatched seat may become dangerous in the event of a sudden stop or crash .

Make sure that the head restraint is in the down position and no objects such as books, purses or briefcases are on the floor in front of the second row seats before folding them down.

Move the front passenger seat forward so that the second row seat head restraint clears the front seat.

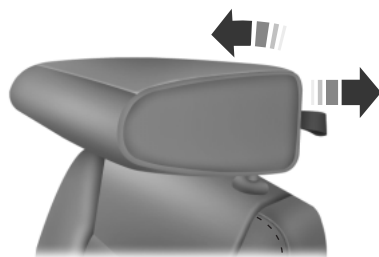

1. Lower the head restraints by pulling on the strap.

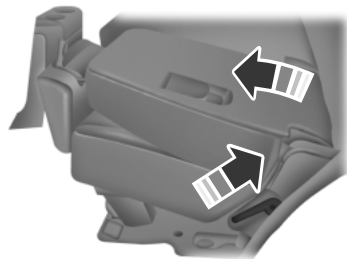

2. Locate handle on the side of the seat cushion by the door.

3. Pull up on the handle and push the seat back forward toward the front of the vehicle.

To return the seat to the upright position:

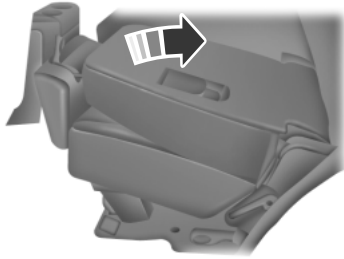

1. Lift the seatback toward the rear of the vehicle.
2. Rotate the seatback until you hear a click, locking it in the upright position.

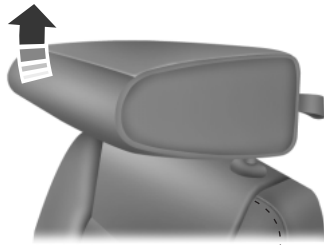

3. Lift up on the head restraint until it locks into its original position.

### Placing the Second Row Outboard 40% Seats in Cargo Mode



**WARNING:** Use caution when folding the seatback to the flat back position as the system will move forward when you lift the release handle.



**WARNING:** Always return the seat from the kneel position prior to raising the seatback. Failure to do so could result in personal injury.

Place the second-row seats in a kneel down load floor position to allow more cargo space.

To place the seats in the cargo mode:



1. Fold down the second row seat.
2. Pull the cargo mode lever up to release the seat into a kneel down load floor position.

**Returning to the upright position from full lowered load floor position**

You cannot return the seatback to the upright position until the seat is returned from the kneel down position. To return the seat to the upright position:

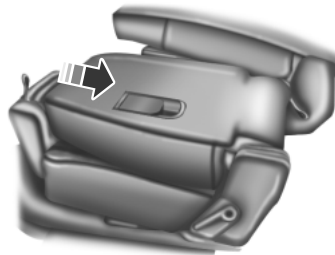

1. Push the seat rearward until the latch is engaged.
2. Return the seatback to the upright position.

**Adjusting the Second Row Outboard 40% Seat for E-Z Entry**

 **WARNING:** Always latch the vehicle seat to the floor, whether the seat is occupied or empty. If not latched, the seat may cause injury during a sudden stop.

 **WARNING:** After using the E-Z Entry feature make sure there are not any objects, cargo or the feet of a third row occupant under the second row seat when latching the seat to the floor. Injury to the third row occupants feet or damage to the seat may occur.

 **WARNING:** Before returning the seatback to its original position, make sure that cargo or any objects are not trapped behind the seatback. After returning the seatback to its original position, pull on the seatback to make sure that it has fully latched. An unlatched seat may become dangerous in the event of a sudden stop or crash.

The E-Z entry seat allows for easier entry and exit to and from the third row seat.

To enter the third row seat:

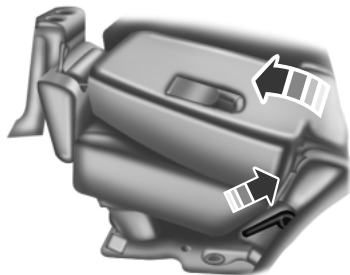

1. Fold down the second row seat and release the handle.
2. Pull the handle up again until the seat releases from the floor.
3. Push the seat upward and fold it away from the third row.

To return the seat to a seating position:



1. Push the seat down and latch to the floor.
2. Bring the seatback to an upright position. The seatback should lock into position.

**Note:** If the seatback will not return to the upright position, tumble the seat again and re-latch it to the floor. Be sure that cargo or other objects are not trapped underneath the seatback.



**Note:** If a squeak is heard from the latch area, the latch striker pin should be wiped clean of dust or debris.

**Exiting the Third Row**



1. Pull the strap located at the bottom outboard of the seat back to release the seat from the floor, and rotate the seat up towards the front seat.
2. Follow the directions above to return the seat from the E-Z entry and to the upright position.

### Reclining the Second-Row Outboard 40% Seat Back

 **WARNING:** Reclining the seat back can cause an occupant to slide under the seat's safety belt, resulting in severe personal injuries in the event of a crash.



The release handle is located on the outboard side of the seat cushion. Lift it to allow the seat back to be adjusted to the desired location.

### Folding the Second-Row Center 20% Seat System (If Equipped)

 **WARNING:** To prevent possible damage to the seat or safety belts, make sure that the safety belts are not buckled when moving the seat to the load floor position.

 **WARNING:** Before returning the seatback to its original position, make sure that cargo or any objects are not trapped underneath the seatback. After returning the seatback to its original position, pull on the seatback to make sure that it has fully latched. An unlatched seat may become dangerous in the event of a sudden stop or crash.

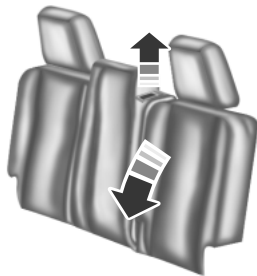

1. Locate the release handle located in the upper left seatback, and pull the handle to release the folding seat latch.



2. With the latch released the seatback can be lowered into the load floor position.



3. To return the seat to the upright position, lift the seat back until the latch is fully engaged.

**Adjusting the Second-Row Center 20% Seat (If Equipped)**

**Note:** Move this seat forward to keep a child in a child restraint close to the front seat occupants. Move the seat to the full rearward position when it is occupied by older children or adults, including children in booster seats.

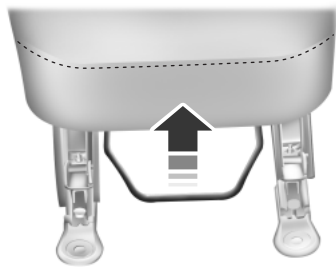

Lift the handle to move the seat forward or backward.

**Rear Heated Seats (If Equipped)**

**WARNING:** Persons who are unable to feel pain to the skin because of advanced age, chronic illness, diabetes, spinal cord injury, medication, alcohol use, exhaustion, or other physical conditions, must exercise care when using the seat heater. The seat heater may cause burns even at low temperatures, especially if used for long periods of time. Do not place anything on the seat that insulates against heat, such as a blanket or cushion, because this may cause the seat heater to overheat. Do not puncture the seat with pins, needles, or other pointed objects because this may damage the heating element which may cause the seat heater to overheat. An overheated seat may cause serious personal injury.

**Note:** Do not do the following:

- Place heavy objects on the seat
- Operate the seat heater if water or any other liquid is spilled on the seat. Allow the seat to dry thoroughly.

The rear seat heat controls are located on the rear of the center console.

The heated seats only operate when the ignition is on. To operate the heated seats:



Press the heated seat button to cycle through the various heat settings and off. Warmer settings are indicated by more indicator lights.

**Third Row Seats**

Make sure that no objects are on the floor in front of the third row seats or on the seat cushion before lowering them. Make sure that the head restraints are lowered and the second row seats are not reclined.

**Folding Down the Third Row Seats to the Load Floor**

**!** **WARNING:** To prevent possible damage to the seat or safety belts, make sure that the safety belts are not buckled when moving the seat to the load floor position.

**!** **WARNING:** Before returning the seatback to its original position, make sure that cargo or any objects are not trapped behind the seatback. After returning the seat back to its original position, pull on the seatback to make sure that it has fully latched. An unlatched seat may become dangerous in the event of a sudden stop or crash.

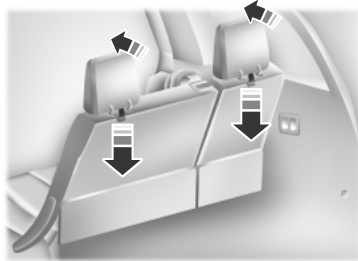

Before folding the third row seats, fold the head restraints down by pulling on the strap located at the bottom of the restraint.

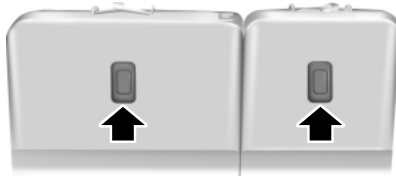

Pull up on the handle located behind the seatback while pushing the seat back forward and down into the seat cushion.

To return the seat back to its original position, lift the seat back until it latches into place.

**PowerFold™ Third-Row Seat (If Equipped)**

**Note:** The power fold down seats will operate for 10 minutes after the ignition switch is in off. The transmission must be in park (P) and the liftgate, or liftgate glass must be open. Similar to the battery saver feature, the power third row seat will be disabled 10 minutes after turning the vehicle off.

**Note:** Be sure that the head restraints are folded down before powering the third row seat down.

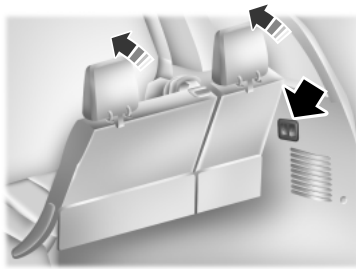

The control buttons are located on the right-hand rear quarter trim panel (accessible from the liftgate area).

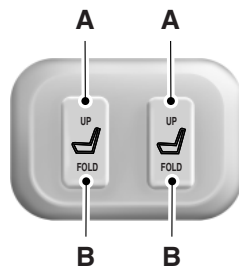

Press B to lower the desired seatback. Press A to return the seatback to its original position.

If the power third row seat is disabled after 10 minutes, you can enable the seat by:

- Opening any door.
- Pressing the unlock button on the key fob.
- Pressing any keyless entry keypad button.
- Turning the ignition key.

## Universal Garage Door Opener (If Equipped) 143

### UNIVERSAL GARAGE DOOR OPENER

The appearance of your vehicle's universal garage door opener will vary according to your option package. Before programming, make sure you identify which transmitter you have by comparing it to the graphics below.

**HomeLink®**



**Car2U® Home Automation System**

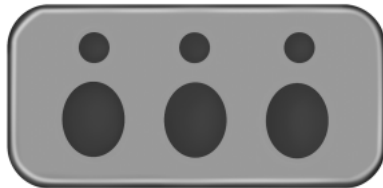

**Note:** The programming of the two types of universal garage door openers are different and have different instructions. Identify your package and refer to the instructions listed in this chapter.

### CAR2U® HOME AUTOMATION SYSTEM (IF EQUIPPED)



**WARNING:** Make sure that the garage door and security device are free from obstruction when you are programming. Do not program the system with the vehicle in the garage.



**WARNING:** Do not use the system with any garage door opener that does not have the safety stop and reverse feature as required by U.S. Federal Safety Standards (this includes any garage door opener manufactured before April 1, 1982).

## 144 Universal Garage Door Opener (If Equipped)

---

**Note:** Before you begin the programming process, park your vehicle in front of the garage door opener motor or other device you want to program.

**Note:** Make sure you keep the original remote control transmitter for use in other vehicles as well as for future system programming.

**Note:** We recommend that upon the sale or lease termination of your vehicle, you erase the programmed function buttons for security reasons. See *Erasing the Function Button Codes* later in this section.

**Note:** You can program a maximum of three devices. To change or replace any of the three devices after it has been initially programmed, you must first erase the current settings. See *Erasing the Function Button Codes* later in this section.

**Note:** Programming the system to a community gate will require a unique set of instructions depending on the gate system model. Contact the help line at 1-866-572-2728 for further information.

**Note:** If you accidentally enter the program mode by pressing and releasing the outer two buttons or all three buttons simultaneously, do not press any button until the module times out after a few seconds and resets to normal mode. When the module has timed out, all three LED lamps will flash rapidly for a few seconds then turn off. Any settings should remain as previously set.

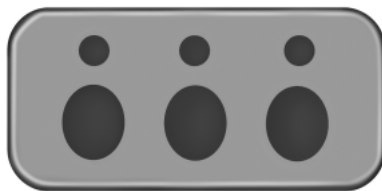

The universal garage door opener replaces the common hand-held garage door opener with a three-button transmitter that is integrated into the driver's sun visor.

The system includes two primary features, a garage door opener and a platform for remote activation of devices with the home. As well as being programmed for garage doors, the system transmitter can be programmed to operate security devices and home lighting systems.

Additional system information can be found on-line at [www.learcar2U.com](http://www.learcar2U.com) or by calling the toll-free help line 1-866-572-2728.

## Universal Garage Door Opener (If Equipped) 145

### Rolling Code Programming

**Note:** If you do not follow the time-sensitive instructions, the device will time out and you will have to repeat the complete procedure.

**Note:** It may be helpful to have another person assist you in programming the transmitter.

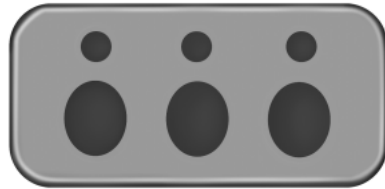
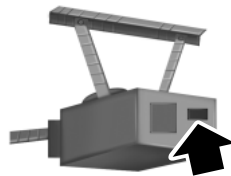
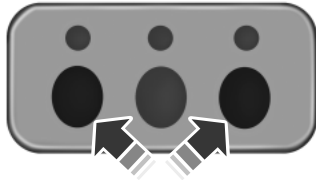

1. Switch the ignition on.
2. Press and hold the outer two buttons for 1–2 seconds, then release.

**Note:** You may need a ladder to reach the unit and you may need to remove the cover or lamp lens.

**Note:** If you cannot locate the learn button, see the Owner's Manual for your garage door opener or call the toll-free help line at 1-866-572-2728.

3. Press the learn button on the garage door opener motor.

**Note:** You will have 10–30 seconds to complete the following steps.

4. Return to your car.
5. Press and hold the function button you would like to use to control the garage door. You may need to hold the button from 5–20 seconds, during which time

the selected button LED lamp will flash slowly.

6. When the garage door moves, release the button **within one second**. The LED lamp will flash rapidly until programming is complete.

7. Press and release the button again. The garage door should move, confirming that programming is successful. If your garage door does not operate, repeat the previous steps.

The LED lamp above the selected button will illuminate to confirm that the system is responding to the button command.

To program another rolling code device, repeat Steps 1 through 6, substituting a different function button in Step 5.

## 146 Universal Garage Door Opener (If Equipped)

---

### Fixed Code Programming

**Note:** It may be helpful to have another person assist you in programming the transmitter.



To program units with fixed code DIP switches, you will need the garage door hand-held transmitter, paper and a pen or pencil.

1. Switch the ignition on.
2. Open the battery cover and note all the switch settings from left to right.

When the switch is in the up, on, or + position, mark down “left button”.

When the switch is in the middle, neutral, or 0 position, mark down “middle button”.

When the switch is in the down, off, or – position, mark down “right button”.

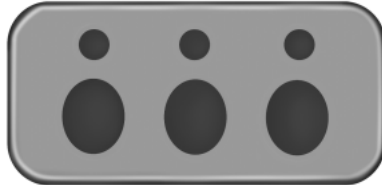

3. Press all three function buttons simultaneously for a few seconds and then release. The LED lamps will flash slowly.

**Note:** The following step must be completed within 2.5 minutes.

4. Enter the corresponding DIP switch settings from left to right into the system by pressing and releasing the buttons corresponding to the settings you noted.

5. Simultaneously press and release all three function buttons. The LED lamps will illuminate.

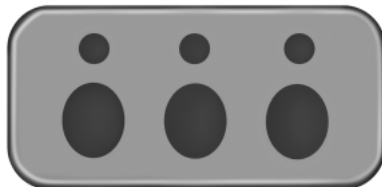

6. Press and hold the function button you would like to use to control the garage door.

**Note:** You may need to hold the button from 5–55 seconds before observing movement of the garage door.

## Universal Garage Door Opener (If Equipped) 147

7. When the garage door moves, release the button within one second. When the button is released, the LED lamp will flash slowly.

8. The LED lamp will begin to flash rapidly until programming is complete. If your garage door does not operate, repeat the previous steps. Otherwise, call the toll-free help line at 1-866-572-2728.

The LED lamp above the selected button will illuminate to confirm that the system is responding to the button command.

### **Erasing the Function Button Codes**

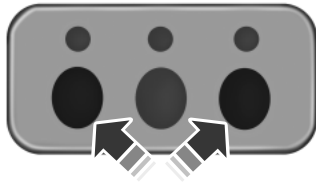

**Note:** You cannot erase individual buttons.

1. Press and hold the outer two function buttons simultaneously for approximately 20 seconds until the LED lamps above the buttons flash rapidly.

2. When the LED lamps flash, release the buttons. The codes for all buttons are erased.

### **FCC and RSS-210 Industry Canada Compliance**

This device complies with Part 15 of the FCC Rules and with RSS-210 of Industry Canada. Operation is subject to the following two conditions: (1) this device may not cause harmful interference, and (2) this device must accept any interference received, including interference that may cause undesired operation.

Changes or modifications to your device not expressly approved by the party responsible for compliance can void the user's authority to operate the equipment.

### **HOMELINK® WIRELESS CONTROL SYSTEM (IF EQUIPPED)**



**WARNING:** Make sure that the garage door and security device are free from obstruction when you are programming. Do not program the system with the vehicle in the garage.



**WARNING:** Do not use the system with any garage door opener that does not have the safety stop and reverse feature as required by U.S. Federal Safety Standards (this includes any garage door opener manufactured before April 1, 1982).

## 148 Universal Garage Door Opener (If Equipped)

---

**Note:** Make sure you keep the original remote control transmitter for use in other vehicles as well as for future system programming.

**Note:** We recommend that upon the sale or lease termination of your vehicle, you erase the programmed function buttons for security reasons. See *Erasing the function button codes* later in this section.

**Note:** You can program a maximum of three devices. To change or replace any of the three devices after it has been initially programmed, you must first erase the current settings. See *Erasing the function button codes* later in this section.

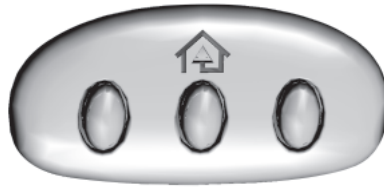

The universal garage door opener replaces the common hand-held garage door opener with a three-button transmitter that is integrated into the driver's sun visor.

The system includes two primary features, a garage door opener and a platform for remote activation of devices with the home. As well as being programmed for garage doors, the system transmitter can be programmed to operate entry gate operators, security systems, entry door locks, and home or office lighting.

Additional system information can be found online at [www.homelink.com](http://www.homelink.com) or by calling the toll-free help line on 1-800-355-3515.

### **Programming**

**Note:** Put a new battery in the hand-held transmitter. This will ensure quicker training and accurate transmission of the radio-frequency signal.

1. With your vehicle parked outside of the garage and your key in the ignition, turn the key so that the ignition is in the on position.

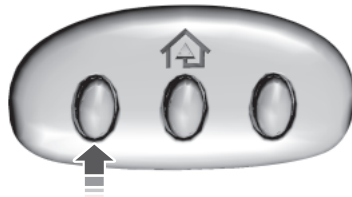

2. Hold your hand-held, garage door transmitter 1–3 inches (2–8 centimeters) away from the HomeLink button you want to program.

3. Using both hands, simultaneously press and hold the desired HomeLink button and the hand-held transmitter button. DO NOT release either one until the HomeLink indicator light flashes slowly and then

## Universal Garage Door Opener (If Equipped) 149

rapidly. When the indicator light flashes rapidly, both buttons may be released. The rapid flashing indicates successful training.

4. Press and hold the HomeLink button you programmed for five seconds, then release. You may need to do this twice to activate the door. If your garage door does not operate, watch the HomeLink indicator light.

If the indicator light stays on, the programming is complete. Press and release the programmed HomeLink button, and then begin programming your garage door opener. See below for Steps 5 – 7.

If the indicator light flashes rapidly for two seconds and then turns to a constant light, the HomeLink button is not programmed yet. Do the following:

Press and hold the HomeLink button while you press and release the hand-held transmitter button every two seconds. The HomeLink indicator light will flash slowly and then rapidly once the HomeLink function button recognizes and accepts the hand-held transmitter's radio frequency signal.

After programming the HomeLink button, follow Steps 5 – 7 as listed below to program your garage door opener.



**Note:** You may need a ladder to reach the unit and you may need to remove the cover or lamp lens on your garage door opener.

5. Press the learn button on the garage door opener motor, and then you have 30 seconds to complete the next step.

6. Return to your car.

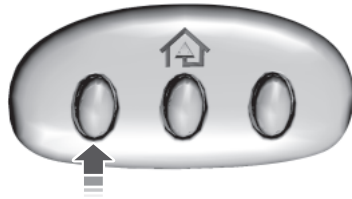

7. Press and hold the function button you want to program for two seconds, then release. Repeat this step. Depending on your brand of garage door opener, you may need to repeat this sequence a third time.

To program additional buttons, repeat Steps 1 – 4 .

For questions or comments, please contact HomeLink® at [www.homelink.com](http://www.homelink.com) or 1-800-355-3515.

## 150 Universal Garage Door Opener (If Equipped)

### **Erasing the Function Button Codes**

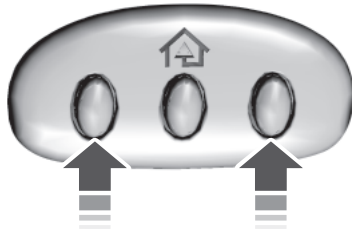

**Note:** You cannot erase individual buttons.

1. Press and hold the outer two function buttons simultaneously for approximately 20 seconds until the indicator lights above the buttons flash rapidly.
2. When the indicator lights flash, release the buttons. The codes for all buttons are erased.

### **Reprogramming a single button**

To program a device to a previously trained button, follow these steps:

1. Press and hold the desired button. **Do NOT** release the button.
2. The indicator light will begin to flash after 20 seconds. Without releasing the button, follow Step 1 in the *Programming* section.

For questions or comments, contact HomeLink® at [www.homelink.com](http://www.homelink.com) or 1-800-355-3515.

### **Programming HomeLink to a Genie Intellicode 2 garage door opener**

**Note:** The Genie Intellicode 2 transmitter must already be programmed to operate with the garage door opener.

### **Programing the transmitters**

To program HomeLink to the transmitter you must first put the transmitter into programming mode. To do this:

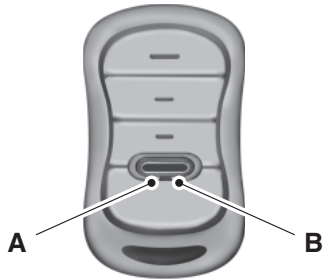

- A. Red LED
- B. Green LED

1. Press and hold one of the buttons on the hand-held transmitter for 10 seconds. The LED light will change from green to green and red.

## Universal Garage Door Opener (If Equipped) 151

---

2. Press the same button twice to confirm the change to Programming mode. If done properly the LED light will appear red.
3. Hold the transmitter within 1–3 inches (2–8 centimeters) of the button on the sun visor you want to program.
4. Press and hold both the programmed Genie button on the hand-held transmitter and the button on the sun visor you want to program. The indicator light on the sun visor will flash rapidly when the programming is successful.

**Note:** the Genie transmitter will transmit for up to 30 seconds. If HomeLink does not program within 30 seconds the Genie transmitter will need to be pressed again. If the Genie transmitter LED displays green and red, release the button until the LED turns off before pressing the button again.

Once HomeLink has been programmed successfully, the Genie transmitter must be changed out of program mode. To do this:

1. Press and hold the previously programmed Genie button on the hand-held transmitter for 10 seconds. The indicator light will change from red to red and green.
2. Press the same button twice to confirm the change. If done correctly the LED will turn green.

### **Programming HomeLink to the Genie Intellicode garage door opener motor**

**Note:** You may need a ladder to access the garage door opener motor.

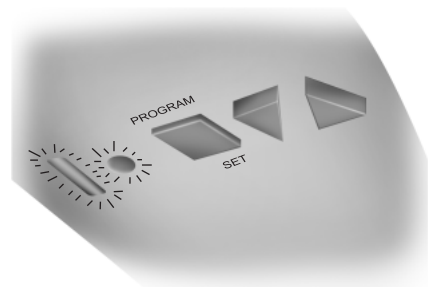

To program HomeLink to the garage door opener motor:

1. Press and hold the PROGRAM button on the garage door opener motor until both blue LED's turn on.
2. Release the PROGRAM button. Only the smaller round LED should be on.
3. Press and release the program button. The larger purple LED will flash

## 152 Universal Garage Door Opener (If Equipped)

---

**Note:** The next two steps must be completed in 30 seconds.

4. Press and release the Genie Intellicode 2 hand-held transmitter's previously programmed button. Both indicator lights on the garage door opener motor unit should now flash purple.
5. Press and hold the previously programmed button on the sun visor for two seconds. Repeat this step up to 3 times until the garage door moves. Programming is now complete.

### ***Clearing a HomeLink device***

To erase programming from the three HomeLink buttons, press and hold the two outer HomeLink buttons until the indicator light begins to flash. The LED will begin flashing in 10 to 20 seconds, at which time both buttons should be released. Programming has now been erased, and the LED should blink slowly to indicate the device is in train mode when any one of the three HomeLink buttons is pressed.

### ***FCC and RSS-210 Industry Canada Compliance***

This device complies with Part 15 of the FCC Rules and with RSS-210 of Industry Canada. Operation is subject to the following two conditions: (1) this device may not cause harmful interference, and (2) this device must accept any interference received, including interference that may cause undesired operation.

Changes or modifications to your device not expressly approved by the party responsible for compliance can void the user's authority to operate the equipment.

**AUXILIARY POWER POINTS**

**WARNING:** Do not plug optional electrical accessories into the cigarette lighter socket (if equipped). Improper use of the lighter can cause damage not covered by your warranty, and can result in fire or serious injury.

**Note:** If used when the engine is not running, the battery will discharge. There may be insufficient power to restart your engine.

**Note:** Do not insert objects other than an accessory plug into the power point. This will damage the outlet and blow the fuse.

**Note:** Do not hang any type of accessory or accessory bracket from the plug.

**Note:** Do not use the power point over the vehicle capacity of 12 volt DC 180 watts or a fuse may blow.

**Note:** Do not use the power point for operating a cigarette lighter element.

**Note:** Improper use of the power outlet can cause damage not covered by your warranty.

**Note:** Always keep the power point caps closed when not in use.

Run the engine for full capacity use of the power point. To prevent the battery from being discharged:

- Do not use the power point longer than necessary when the engine is not running.
- Do not leave devices plugged in overnight or when the vehicle is parked for extended periods.

**Locations**

Power points may be found:

- By the passenger's ankle near the floor on the front console.
- In the console bin.
- On the rear of the center console.
- On the right rear quarter panel.

**110 Volt AC Power Point (If Equipped)**

**WARNING:** Do not keep electrical devices plugged in the power point whenever the device is not in use. Do not use any extension cord with the 110 volt AC power point, since it will defeat the safety protection design. Doing so may cause the power point to overload due to powering multiple devices that can reach beyond the 150-watt load limit and could result in fire or serious injury.

**Note:** The cap should always be closed whenever the power point outlet is not in use.

**Note:** The power point will turn off after 13 minutes if the ignition is on without the engine running. Keep the engine running to use the power point.

The 110-volt AC power point outlet is used for powering electrical devices that require up to 150 watts. Exceeding the 150-watt limit will cause the power point to cut off the power temporarily to provide overload protection.



The power point is located on the back of the center console.

---

The power point is not designed for the following electric appliances; they may not work properly:

- Cathode-ray, tube-type televisions
- Motor loads, such as vacuum cleaners, electric saws and other electric power tools, compressor-driven refrigerators, etc.
- Measuring devices that process precise data, such as medical equipment, measuring equipment, etc.
- Other appliances requiring an extremely stable power supply: microcomputer-controlled electric blankets, touch sensor lamps, etc.

The power point can switch to a fault mode when it is overloaded, overheated or shorted. Unplug your device and turn the ignition off then on for overloading and shorting conditions. Let the system cool off, then turn the ignition off then on for an overheating condition.

The power point can provide power whenever the ignition is on and the indicator light is on. The indicator light is located in the top left corner of the power point.

When the indicator light is:

- on — power point is ready to supply power
- off — power point power supply is off; ignition is not on
- blinking — power point is in fault mode

**CENTER CONSOLE**

Stow items in the cupholder carefully as items may become loose during hard braking, acceleration or collisions, including hot drinks which may spill.

Available console features include:

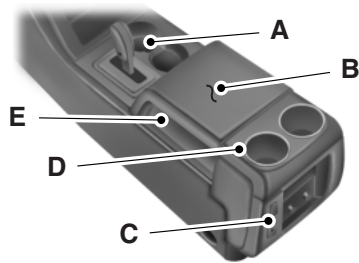

- A. Cupholders
- B. Utility compartment, coin holder slots, tissue box holder, audio input jack and USB port
- C. Power point, rear climate controls, rear audio controls, rear heated seat controls and 110-volt AC power point
- D. Rear cupholders
- E. Side storage

**OVERHEAD CONSOLE (IF EQUIPPED)**

The appearance of the overhead console will vary according to your option package.

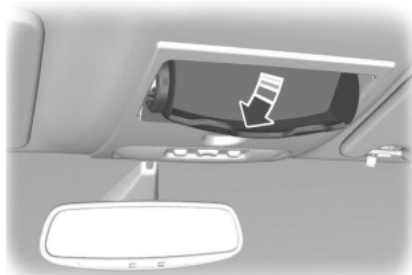



Press near the rear edge of the door to open it.

### GENERAL INFORMATION

 **WARNING:** Extended idling at high engine speeds can produce very high temperatures in the engine and exhaust system, creating the risk of fire or other damage.

 **WARNING:** Do not park, idle, or drive your vehicle on dry grass or other dry ground cover. The emission system heats up the engine compartment and exhaust system, which can start a fire.

 **WARNING:** Do not start your vehicle in a closed garage or in other enclosed areas. Exhaust fumes can be toxic. Always open the garage door before you start the engine.

 **WARNING:** If you smell exhaust fumes inside your vehicle, have your vehicle checked by an authorized dealer immediately. Do not drive if you smell exhaust fumes.

If you disconnect the battery, your vehicle may exhibit some unusual driving characteristics for approximately 5 miles (8 kilometers) after you connect it. This is because the engine management system must realign itself with the engine. You may disregard any unusual driving characteristics during this period.

The powertrain control system meets all Canadian interference-causing equipment standard requirements regulating the impulse electrical field or radio noise.

Do not press the accelerator pedal while starting the engine. If you have difficulty starting the engine, see *Failure to start* later in this section.

## 158 Starting and Stopping the Engine

---

### IGNITION SWITCH

**Note:** Do not store the key in the ignition after the vehicle is turned off and you have left the vehicle. This could cause a drain on the battery.

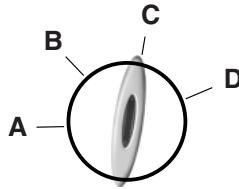

- A. **Off:** The ignition is off.
- B. **Accessory:** Allows the electrical accessories, such as the radio, to operate while the engine is not running.
- C. **On:** All the electrical circuits are operational. Warning lights are illuminated. This is the key position when driving.
- D. **Start:** Cranks the engine. Release the key as soon as the engine starts.

### STARTING A GASOLINE ENGINE

When you start the engine, the idle speed increases, this helps to warm up the engine. If the engine idle speed does not slow down automatically, have your vehicle checked by an authorized dealer.

Before starting the engine:

- Make sure all occupants have fastened their safety belts.
- Make sure the headlamps and electrical accessories are off.
- Make sure the parking brake is on.
- Move the transmission selector lever to position **P**.
- Turn the ignition key to the on position.

Some warning lights briefly illuminate.

**Note:** Do not touch the accelerator pedal.

1. Fully press the brake pedal.
2. Turn the key to the start position to start the engine. Release the key when the engine starts.

**Note:** The engine may continue cranking for up to 15 seconds or until it starts.

**Note:** If you cannot start the engine on the first try, wait for a short period and try again.

If you have difficulty starting the engine when the temperature is below -13°F (-25°C), press the accelerator pedal slightly and try again.

### Failure to Start

If you cannot start the engine after three attempts, wait 10 seconds and follow this procedure:

1. Fully press the brake pedal.
2. Fully press the accelerator pedal and hold it there.
3. Start the engine.

### Stopping the Engine When Your Vehicle is Stationary

1. Move the transmission selector lever to position **P**.
2. Turn the key to the off position.

### Stopping the Engine When Your Vehicle is Moving



**WARNING:** When you switch off the engine when your vehicle is still moving, this results in a loss of brake and steering assistance. The steering does not lock, but higher effort is required. When you switch off the ignition, some electrical circuits, warning lamps and indicators may also be off.

1. Move the transmission selector lever to position **N** and use the brakes to bring your vehicle to a safe stop.
2. When your vehicle has stopped, move the transmission selector lever to position **P** and turn the key to the off position.

## 160 Starting and Stopping the Engine

---

### **Cold Weather Starting (Flexible Fuel Vehicles Only)**

The starting characteristics of all grades of E-85 ethanol make it unsuitable for use when ambient temperatures fall below 0°F (-18°C). Consult your fuel distributor for the availability of winter grade ethanol. As the outside temperature approaches freezing, ethanol fuel distributors should supply winter grade ethanol (same as with unleaded gasoline). If summer grade ethanol is used in cold weather conditions, 0°F to 32°F (-18°C to 0°C), you may experience increased cranking times, rough idle or hesitation until the engine has warmed up.

You may experience a decrease in peak performance when the engine is cold when operating on E-85 ethanol.

Do not crank the engine for more than 10 seconds at a time as starter damage may occur. If the engine fails to start, turn the key to off and wait 30 seconds before trying again.

Do not use starting fluid such as ether in the air intake system. Such fluid could cause immediate explosive damage to the engine and possible personal injury.

If you should experience cold weather starting problems on E-85 ethanol, and neither an alternative brand of E-85 ethanol nor an engine block heater is available, the addition of unleaded gasoline to your tank improves cold starting performance. Your vehicle is designed to operate on E-85 ethanol alone, unleaded gasoline alone, or any mixture of the two.

### **If the Engine Fails to Start Using the Preceding Instructions (Flexible Fuel Vehicles Only)**

1. Press and hold down the accelerator 1/3 to 1/2 way to floor, then crank the engine.
2. When the engine starts, release the key, then gradually release the accelerator pedal as the engine speeds up. If the engine still fails to start, repeat Step 1.

### Guarding Against Exhaust Fumes



**WARNING:** If you smell exhaust fumes inside your vehicle, have this checked immediately. Do not drive your vehicle if you smell exhaust fumes. Carbon monoxide is present in exhaust fumes. Take precautions to avoid its dangerous effects.

### Important Ventilating Information

If you stop your vehicle and leave the engine idling for long periods, we recommend that you do one of the following:

- Open the windows at least 1 inch (2.5 centimeters).
- Set your climate control to outside air.

### ENGINE BLOCK HEATER (IF EQUIPPED)



**WARNING:** Failure to follow engine block heater instructions could result in property damage or personal injury.



**WARNING:** Do not use your heater with ungrounded electrical systems or two-pronged (cheater) adapters. There is a risk of electrical shock.

**Note:** The heater is most effective when outdoor temperatures are below 0°F (-18°C).

The heater acts as a starting aid by warming the engine coolant. This allows the climate control system to respond quickly. The equipment includes a heater element (installed in the engine block) and a wire harness. You can connect the system to a grounded 120-volt A/C electrical source.

## 162 Starting and Stopping the Engine

---

We recommend that you do the following for safe and correct operation:

- Use a 16-gauge outdoor extension cord that is product certified by Underwriter's Laboratory or Canadian Standards Association. This extension cord must be suitable for use outdoors, in cold temperatures, and be clearly marked *Suitable for Use with Outdoor Appliances*. Never use an indoor extension cord outdoors; it could result in an electric shock or become a fire hazard.
- Use as short an extension cord as possible.
- Do not use multiple extension cords.
- Make sure that when in operation, the extension cord plug and the heater cord plug connections are free and clear of water. This could cause an electric shock or fire.
- Make sure your vehicle is parked in a clean area, clear of combustibles.
- Make sure the heater, heater cord and extension cord are firmly connected.
- Check for heat anywhere in the electrical hookup once the system has been operating for approximately 30 minutes.
- Make sure the system is unplugged and properly stowed before driving your vehicle. Make sure the protective cover seals the prongs of the block heater cord plug when not in use.
- Keep plug terminals clean and free of dirt and corrosion.
- Make sure the heater system is checked for proper operation before winter.

### Using the Engine Block Heater

Make sure the receptacle terminals are clean and dry before use. To clean them, use a dry cloth.

The heater uses 0.4 to 1.0 kilowatt-hours of energy per hour of use. The system does not have a thermostat. It achieves maximum temperature after approximately three hours of operation. Using the heater longer than three hours does not improve system performance and unnecessarily uses electricity.

**SAFETY PRECAUTIONS**

**WARNING:** Do not overfill the fuel tank. The pressure in an overfilled tank may cause leakage and lead to fuel spray and fire.



**WARNING:** The fuel system may be under pressure. If you hear a hissing sound near the fuel filler inlet, do not refuel until the sound stops. Otherwise, fuel may spray out, which could cause serious personal injury.



**WARNING:** Automotive fuels can cause serious injury or death if misused or mishandled.



**WARNING:** The flow of fuel through a fuel pump nozzle can produce static electricity, which can cause a fire if fuel is pumped into an ungrounded fuel container.



**WARNING:** Fuel ethanol and gasoline may contain benzene, which is a cancer-causing agent.



**WARNING:** When refueling always shut the engine off and never allow sparks or open flames near the filler neck. Never smoke while refueling. Fuel vapor is extremely hazardous under certain conditions. Care should be taken to avoid inhaling excess fumes.

Observe the following guidelines when handling automotive fuel:

- Extinguish all smoking materials and any open flames before refueling your vehicle.
- Always turn off the vehicle before refueling.
- Automotive fuels can be harmful or fatal if swallowed. Fuel, such as gasoline, is highly toxic and if swallowed can cause death or permanent injury. If fuel is swallowed, call a physician immediately, even if no symptoms are immediately apparent. The toxic effects of fuel may not be visible for hours.

- Avoid inhaling fuel vapors. Inhaling too much fuel vapor of any kind can lead to eye and respiratory tract irritation. In severe cases, excessive or prolonged breathing of fuel vapor can cause serious illness and permanent injury.
- Avoid getting fuel liquid in your eyes. If fuel is splashed in the eyes, remove contact lenses (if worn), flush with water for 15 minutes and seek medical attention. Failure to seek proper medical attention could lead to permanent injury.
- Fuels can also be harmful if absorbed through the skin. If fuel is splashed on the skin or clothing, promptly remove contaminated clothing and wash skin thoroughly with soap and water. Repeated or prolonged skin contact with fuel liquid or vapor causes skin irritation.
- Be particularly careful if you are taking Antabuse or other forms of disulfiram for the treatment of alcoholism. Breathing gasoline vapors, or skin contact could cause an adverse reaction. In sensitive individuals, serious personal injury or sickness may result. If fuel is splashed on the skin, promptly wash skin thoroughly with soap and water. Consult a physician immediately if you experience an adverse reaction.

**FUEL QUALITY**

**Note:** Use of any fuel other than those recommended may cause powertrain damage and a loss of vehicle performance; repairs may not be covered under warranty.

**Choosing the Right Fuel (Gasoline Vehicles)**

Use only UNLEADED gasoline or UNLEADED gasoline blended with a maximum of 15% ethanol in your gasoline vehicle. If your vehicle is a Flex Fuel Vehicle (FFV), it will have a yellow bezel placed over the fuel fill inlet.

Do not use:

- Fuels containing more than 15% ethanol or E-85 fuel.
- Fuels containing methanol.
- Fuels containing metallic based additives, including manganese-based compounds.
- Fuels containing the octane booster additive, methylcyclopentadienyl manganese tricarbonyl (MMT).
- Leaded-fuel (The use of leaded fuel is prohibited by law).

**Note:** Use of any fuel other than recommended fuel can cause powertrain damage, impair the emission control system or cause loss of vehicle performance. Any damage to the vehicle that is caused by the use of fuel not recommended will not be covered under warranty.

### Choosing the Right Fuel With a Flex Fuel Vehicle (If Equipped)

Use only UNLEADED gasoline or UNLEADED gasoline blended with a maximum of 85% ethanol (E-85) in your Flex Fuel Vehicle (FFV). If your vehicle is flex fuel capable, it will have a yellow bezel placed over the fuel fill inlet.

Do not use:

- Fuels containing more than 85% ethanol or E-100 fuel.
- Fuels containing methanol.
- Fuels containing metallic based additives, including manganese-based compounds.
- Fuels containing the octane booster additive, methylcyclopentadienyl manganese tricarbonyl (MMT).
- Leaded-fuel (The use of leaded fuel is prohibited by law).

Use of any fuel other than recommended fuel can cause powertrain damage, impair the emission control system or cause loss of vehicle performance. Any damage to a vehicle that is caused by use of fuel not recommended will not be covered under warranty.

### Octane Recommendations

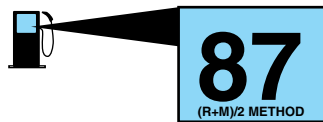

Regular unleaded gasoline with a pump (R+M)/2 octane rating of 87 is recommended. Some stations offer fuels posted as Regular with an octane rating below 87,

particularly in high altitude areas. Fuels with octane levels below 87 are not recommended. Premium fuel will provide improved performance and is recommended for severe duty usage such as trailer tow.

Do not be concerned if your engine sometimes knocks lightly. However, if it knocks heavily under most driving conditions while you are using fuel with the recommended octane rating, see your authorized dealer to prevent any engine damage.

**RUNNING OUT OF FUEL**

Avoid running out of fuel because this situation may have an adverse effect on powertrain components.

If you have run out of fuel:

- You may need to cycle the ignition from off to on several times after refueling to allow the fuel system to pump the fuel from the tank to the engine. On restarting, cranking time will take a few seconds longer than normal.
- Normally, adding 1 gallon (3.8L) of fuel is enough to restart the engine. If the vehicle is out of fuel and on a steep grade, more than 1 gallon (3.8L) may be required.
- The service engine soon indicator may come on. For more information on the service engine soon indicator, refer to the *Instrument Cluster* chapter.

See *Settings* in the *Instrument Cluster* chapter for information on calculating DTE (Distance to empty).

**Refilling With a Portable Fuel Container**

**WARNING:** Do not insert the nozzle of portable fuel containers or aftermarket funnels into the Easy Fuel® system. This could damage the fuel system and its seal, and may cause fuel to run onto the ground instead of filling the tank, which could result in serious personal injury.



**WARNING:** Do not try to pry open or push open the Easy Fuel® system with foreign objects. This could damage the fuel system and its seal and cause injury to you or others.

With the Easy Fuel® “no cap” fuel system, use the following directions when filling from a portable fuel container:

When filling the vehicle’s fuel tank from a portable fuel container, use the funnel included with the vehicle.

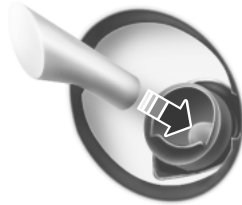

1. The white plastic funnel is located under the spare tire tool panel located in the floor compartment behind the rear seat.

2. Unlatch and remove the spare tire tool panel. Remove the white plastic funnel.
3. Slowly insert the funnel into the Easy Fuel system.
4. Fill the vehicle with fuel from the portable fuel container.
5. Clean the funnel or properly dispose of it. Extra funnels can be purchased from your authorized dealer if you choose to dispose of the funnel. Do not use aftermarket funnels; they will not work and can damage the Easy Fuel system. The included funnel has been specially designed to work safely with your vehicle.

## REFUELING



**WARNING:** Fuel vapor burns violently and a fuel fire can cause severe injuries. To help avoid injuries to you and others:

- Read and follow all the instructions on the pump island.
- Turn off your engine when you are refueling.
- Do not smoke if you are near fuel or refueling your vehicle.
- Keep sparks, flames and smoking materials away from fuel.
- Stay outside your vehicle and do not leave the fuel pump unattended when refueling your vehicle - this is against the law in some places.
- Keep children away from the fuel pump; never let children pump fuel.
- Do not use personal electronic devices while refueling.

Use the following guidelines to avoid electrostatic charge build-up when filling an ungrounded fuel container:

- Place approved fuel container on the ground.
- DO NOT fill a fuel container while it is in the vehicle (including the cargo area).
- Keep the fuel pump nozzle in contact with the fuel container while filling.
- DO NOT use a device that would hold the fuel pump handle in the fill position.

### Easy Fuel® “No Cap” Fuel System



**WARNING:** The fuel system may be under pressure. If you hear a hissing sound near the fuel filler door, do not refuel until the sound stops. Otherwise, fuel may spray out, which could cause serious personal injury.

When fueling your vehicle:

1. Turn the engine off.
2. Open the fuel door by pulling the indent on the door.
3. Insert the fuel plug key (if equipped) into the locking plug and turn it counterclockwise to unlock it.
4. Slowly insert the fuel filler nozzle fully into the fuel system, and leave the nozzle fully inserted until you are done pumping.
5. After you are done pumping fuel, slowly remove the fuel filler nozzle—allow about ten seconds after pumping fuel before removing the fuel filler nozzle. This allows residual fuel to drain back into the fuel tank and not spill onto the vehicle.
6. Reinstall the plug (if equipped) into the fuel fill inlet and turn the key clockwise to lock.

**Note:** Do not overfill the tank or fuel spillage will occur.

If the fuel fill inlet was not properly closed, a Check Fuel Fill Inlet message may appear on the information display. See the *Information Displays* chapter for more information.

At the next opportunity, do the following:

1. Safely pull off the road.
2. Turn off the engine.
3. Open the fuel filler door and remove any visible debris from the fuel fill opening.
4. Insert either the fuel fill nozzle or the fuel fill funnel provided with the vehicle several times to dislodge any debris and/or allow the inlet to close properly.

If this action corrects the problem, the message may not reset immediately. It may take several driving cycles for the message to turn off. A driving cycle consists of an engine start-up (after four or more hours with the engine off) followed by city/highway driving. Continuing to drive with the message on may cause the service engine soon lamp to turn on as well.

## FUEL CONSUMPTION

### Filling the Tank

The advertised capacity is the indicated capacity and the empty reserve combined. Indicated capacity is the difference in the amount of fuel in a full tank and a tank when the fuel gauge indicates empty. Empty reserve is the amount of fuel in the tank after the fuel gauge indicates empty.

**Note:** The amount of usable fuel in the empty reserve varies and should not be relied upon to increase driving range. When refueling your vehicle after the fuel gauge indicates empty, you might not be able to refuel the full amount of the advertised capacity of the fuel tank due to the empty reserve still present in the tank.

For consistent results when filling the fuel tank:

- Turn the ignition off before fueling; an inaccurate reading results if the engine is left running.
- Use the same fill rate (low–medium–high) each time the tank is filled.
- Allow no more than two automatic click–offs when filling.

Results are most accurate when the filling method is consistent.

**Calculating Fuel Economy**

Do not measure fuel economy during the first 1000 miles (1600 kilometers) of driving (this is your engine's break-in period); a more accurate measurement is obtained after 2000 miles–3000 miles (3200 kilometers–4800 kilometers). Also, fuel expense, frequency of fill-ups or fuel gauge readings are not accurate ways to measure fuel economy.

1. Fill the fuel tank completely and record the initial odometer reading.
2. Each time you fill the tank, record the amount of fuel added.
3. After at least three to five tank fill-ups, fill the fuel tank and record the current odometer reading.
4. Subtract your initial odometer reading from the current odometer reading.
5. Calculate fuel economy as follows:

Standard: Divide miles traveled by gallons used.

Metric: Multiply liters used by 100, then divide by kilometers traveled.

Keep a record for at least one month and record the type of driving (city or highway). This provides an accurate estimate of the vehicle's fuel economy under current driving conditions. Additionally, keeping records during summer and winter show how temperature impacts fuel economy. In general, lower temperatures mean lower fuel economy.

**EMISSION CONTROL SYSTEM**

**WARNING:** Do not park, idle, or drive your vehicle in dry grass or other dry ground cover. The emission system heats up the engine compartment and exhaust system, which can start a fire.



**WARNING:** Exhaust leaks may result in entry of harmful and potentially lethal fumes into the passenger compartment. If you smell exhaust fumes inside your vehicle, have your dealer inspect your vehicle immediately. Do not drive if you smell exhaust fumes.

Your vehicle is equipped with various emission control components and a catalytic converter which will enable your vehicle to comply with applicable exhaust emission standards. To make sure that the catalytic converter and other emission control components continue to work properly:

- Use only the specified fuel listed.
- Avoid running out of fuel.
- Do not turn off the ignition while your vehicle is moving, especially at high speeds.
- Have the items listed in *Scheduled Maintenance Information* performed according to the specified schedule.

The scheduled maintenance items listed in *Scheduled Maintenance Information* are essential to the life and performance of your vehicle and to its emissions system.

If other than Ford, Motorcraft® or Ford-authorized parts are used for maintenance replacements or for service of components affecting emission control, such non-Ford parts should be equivalent to genuine Ford Motor Company parts in performance and durability.

Illumination of the service engine soon indicator, charging system warning light or the temperature warning light, fluid leaks, strange odors, smoke or loss of engine power could indicate that the emission control system is not working properly.

An improperly operating or damaged exhaust system may allow exhaust to enter the vehicle. Have a damaged or improperly operating exhaust system inspected and repaired immediately.

Do not make any unauthorized changes to your vehicle or engine. By law, vehicle owners and anyone who manufactures, repairs, services, sells, leases, trades vehicles, or supervises a fleet of vehicles are not permitted to intentionally remove an emission control device or prevent it from working. Information about your vehicle's emission system is on the Vehicle Emission Control Information Decal located on or near the engine. This decal also lists engine displacement.

Please consult your warranty information for complete emission warranty information.

**On-board Diagnostics (OBD-II)**

Your vehicle is equipped with a computer that monitors the engine's emission control system. This system is commonly known as the on-board diagnostics system (OBD-II). The OBD-II system protects the environment by ensuring that your vehicle continues to meet government emission standards. The OBD-II system also assists your authorized dealer in properly servicing your vehicle.



When the service engine soon indicator illuminates, the OBD-II system has detected a malfunction. Temporary malfunctions may cause the service engine soon indicator to illuminate.

Examples are:

1. The vehicle has run out of fuel—the engine may misfire or run poorly.
2. Poor fuel quality or water in the fuel—the engine may misfire or run poorly.
3. The fuel fill inlet may not have been properly closed. See *Easy Fuel® No Cap Fuel System* in this chapter.
4. Driving through deep water—the electrical system may be wet.

These temporary malfunctions can be corrected by filling the fuel tank with good quality fuel, properly closing the fuel fill inlet or letting the electrical system dry out. After three driving cycles without these or any other temporary malfunctions present, the service engine soon indicator should stay off the next time the engine is started. A driving cycle consists of a cold engine start-up followed by mixed city or highway driving. No additional vehicle service is required.

If the service engine soon indicator remains on, have your vehicle serviced at the first available opportunity. Although some malfunctions detected by the OBD-II may not have symptoms that are apparent, continued driving with the service engine soon indicator on can result in increased emissions, lower fuel economy, reduced engine and transmission smoothness, and can lead to more costly repairs.

**Readiness for Inspection/Maintenance (I/M) Testing**

Some state, provincial and local governments may have Inspection/Maintenance (I/M) programs to inspect the emission control equipment on your vehicle. Failure to pass this inspection could prevent you from getting a vehicle registration.



If the service engine soon indicator is on or the bulb does not work, the vehicle may need to be serviced. See *On-board Diagnostics (OBD-II)* in this chapter.

Your vehicle may not pass the I/M test if the service engine soon indicator is on or not working properly (bulb is burned out), or if the OBD-II system has determined that some of the emission control systems have not been properly checked. In this case, the vehicle is considered not ready for I/M testing.

If the vehicle's engine or transmission has just been serviced, or the battery has recently run down or been replaced, the OBD-II system may indicate that the vehicle is not ready for I/M testing. To determine if the vehicle is ready for I/M testing, turn the ignition key to the on position for 15 seconds without cranking the engine. If the service engine soon indicator blinks eight times, it means that the vehicle is not ready for I/M testing; if the service engine soon indicator stays on solid, it means that the vehicle is ready for I/M testing.

The OBD-II system is designed to check the emission control system during normal driving. A complete check may take several days. If the vehicle is not ready for I/M testing, the following driving cycle consisting of mixed city and highway driving may be performed:

15 minutes of steady driving on an expressway or highway followed by 20 minutes of stop-and-go driving with at least four 30-second idle periods.

Allow the vehicle to sit for at least eight hours without starting the engine. Then, start the engine and complete the above driving cycle. The engine must warm up to its normal operating temperature. Once the engine is started, do not turn off the engine until the above driving cycle is complete. If the vehicle is still not ready for I/M testing, the above driving cycle will have to be repeated.

**AUTOMATIC TRANSMISSION**

**WARNING:** Always set the parking brake fully and make sure the gearshift is latched in P (Park). Turn the ignition to the LOCK position and remove the key whenever you leave your vehicle.



**WARNING:** Do not use the Tow/Haul feature when driving in icy or slippery conditions as the increased engine braking can cause the rear wheels to slide and the vehicle to swing around with the possible loss of vehicle control.

Your vehicle has been designed to improve fuel economy by reducing fuel usage while coasting or decelerating. When you take your foot off the accelerator pedal and the vehicle begins to slow down, the torque converter clutch locks up and aggressively shuts off fuel flow to the engine while decelerating. This fuel economy benefit may be perceived as a light to medium braking sensation when removing your foot from the accelerator pedal.

This vehicle is equipped with an Adaptive Transmission Shift Strategy. The Adaptive Transmission Shift Strategy offers the optimal transmission operation and shift quality. When the engine is turned off, the shift data which includes the adaptive information will be stored automatically in the Powertrain Control Module. If the battery is disconnected for any reason, the stored information from the last time the key was turned to off will be read. This way, no information will be lost with any battery removal or battery disconnect.

**P (Park)**

This position locks the transmission and prevents the rear wheels from turning.



To put your vehicle in gear:

- Press the brake pedal
- Start the engine
- Move the gearshift lever into the desired gear. If your vehicle is equipped with a floor-shift transmission, press the gearshift lever release button (on the front of the lever) while shifting into the desired gear.

To put your vehicle in P (Park):

- Come to a complete stop
- Move the gearshift lever and securely latch it in P (Park)

### **R (Reverse)**

With the gearshift lever in R (Reverse), the vehicle will move backward. Always come to a complete stop before shifting into and out of R (Reverse).

### **N (Neutral)**

With the gearshift lever in N (Neutral), the vehicle can be started and is free to roll. Hold the brake pedal down while in this position.

### **D (Drive with Overdrive) with Tow/Haul Off**

D (Drive with Overdrive) with Tow/Haul OFF is the normal driving position for the best fuel economy. Transmission operates in gears one through six.

### **D (Drive with Overdrive) with Tow/Haul On**



The Tow/Haul feature improves transmission operation when towing a trailer or a heavy load. All transmission gear ranges are available when using Tow/Haul.

To activate Tow/Haul, press the button on the side of the gearshift lever.

**TOW  
HAUL**

The TOW HAUL indicator light will illuminate in the instrument cluster.

Tow/Haul delays upshifts to reduce frequency of transmission shifting. Tow/Haul also provides engine braking in all forward gears when the transmission is in the D (Drive with Overdrive) position; this engine braking will slow the vehicle and assist the driver in controlling the vehicle when descending a grade. Depending on driving conditions and load conditions, the transmission may downshift, slow the vehicle and control the vehicle speed when descending a hill, without the accelerator pedal being pressed. The amount of downshift braking provided will vary based upon the amount the brake pedal is depressed.

To deactivate the Tow/Haul feature and return to normal driving mode, press the button on the end of the gearshift lever. The TOW HAUL light will no longer be illuminated.

When you shut-off and restart the engine, the transmission will automatically return to normal D (Drive with Overdrive) mode (Tow/Haul OFF).

**3 (Third) (column-shift only)**

Transmission operates in third gear only.

Used for improved traction on slippery roads.

**2 (Second)**

Transmission operates in 2nd gear only.

Use 2 (Second) to start-up on slippery roads.

**1 (First)**

- Transmission operates in 1st gear only.
- Provides maximum engine braking.
- Allows upshifts by moving gearshift lever.
- Will not downshift into 1 (First) at high speeds; allows for 1 (First) when vehicle reaches slower speeds.

**Forced downshifts**

- Allowed in D (Drive) only.
- Press the accelerator to the floor.
- Allows transmission to select an appropriate gear.

**Automatic Transmission Adaptive Learning**

This feature is designed to increase durability and provide consistent shift feel over the life of the vehicle. A new vehicle or transmission may have firm shifts, soft shifts or both. This operation is considered normal and will not affect function or durability of the transmission. Over time, the adaptive learning process will fully update transmission operation. Additionally, whenever the battery is disconnected or a new battery installed, the strategy must be relearned.

**Brake-Shift Interlock – Floor-Shift Transmission**

**WARNING:** Do not drive your vehicle until you verify that the brake lamps are working.



**WARNING:** When doing this procedure, you will be taking the vehicle out of park which means the vehicle can roll freely. To avoid unwanted vehicle movement, always fully set the parking brake prior to doing this procedure. Use wheel chocks if appropriate.



**WARNING:** If the parking brake is fully released, but the brake warning lamp remains illuminated, the brakes may not be working properly. See your authorized dealer.

This vehicle is equipped with a brake-shift interlock feature that prevents the gearshift lever from being moved from P (Park) when the ignition is in the on position unless the brake pedal is pressed.

If you cannot move the gearshift lever out of P (Park) with ignition in the on position and the brake pedal pressed, it is possible that a fuse has blown or the vehicle's brake lamps are not operating properly. Refer to *Fuses* chapter for more information.

If the fuse is not blown and the brake lamps are working properly, the following procedure will allow you to move the gearshift lever from P (Park):

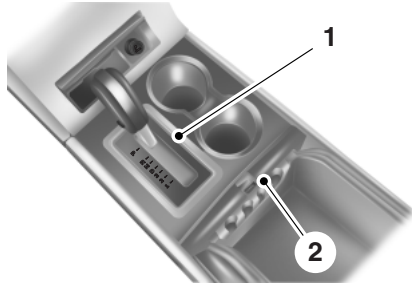

1. Apply the parking brake, turn the ignition key to the off position, and remove the key.

2. Using a screwdriver (or similar tool), carefully pry off and remove the chrome trim ring (1) from the shifter bezel base.

3. Using a screwdriver (or similar tool), carefully pry the trim panel (2) up and disconnect it from the console to expose the inside of the gearshift.

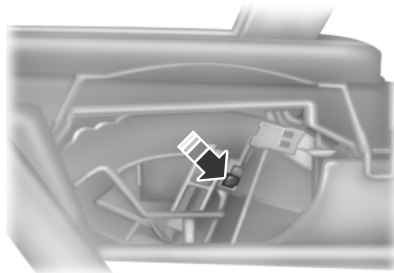

4. Locate the brake shift interlock lever on the passenger side of the shifter assembly.

5. Apply the brake pedal and turn the ignition key to the on position. Using a screwdriver (or similar tool), press and hold the brake shift interlock lever while pulling the gearshift lever out of the P (Park) position and into the N (Neutral) position.

6. Install the trim panel (2) and chrome ring (1) in reverse order.

7. Apply brake pedal, start the vehicle, and release the parking brake.

**Note:** See your authorized dealer as soon as possible if this procedure is used.

#### If Your Vehicle Gets Stuck in Mud or Snow

**Note:** Do not rock the vehicle if the engine is not at normal operating temperature or damage to the transmission may occur.

**Note:** Do not rock the vehicle for more than a minute or damage to the transmission and tires may occur, or the engine may overheat.

If your vehicle gets stuck in mud or snow, it may be rocked out by shifting between forward and reverse gears, stopping between shifts in a steady pattern. Press lightly on the accelerator in each gear.

**USING FOUR-WHEEL DRIVE (4WD) (if equipped)**

**WARNING:** For important information regarding safe operation of this type of vehicle, see *General Information* in the *Wheels and Tires* chapter.

**Note:** Do not use 4X4 mode on dry, hard surfaced roads. Doing so will produce excessive noise, increase tire wear and may damage drive components. 4X4 mode is only intended for consistently slippery or loose surfaces.

Your 4x4 features the heavy-duty Control Trac® 4WD system which includes a computer-operated transfer case. This unique system is interactive with the road, continually monitoring and adjusting torque delivery to the front and rear wheels to optimize vehicle control.

**4WD Indicator Lights**

The indicator lights illuminate in the message center in the reconfigurable telltale (RTT) location under the following conditions. Refer to *Warning Lamps and Indicators* in the *Instrument Cluster* chapter.

**Note:** When a 4X4 system fault is present, the system will typically remain in whichever 4X4 mode was selected prior to the fault condition occurring. It will not default to 4X2 in all circumstances. When this warning is displayed, have your vehicle serviced by an authorized dealer.

**4x2**

**4X2** - Momentarily illuminates when 2H is selected.

**4x4  
AUTO**

**4X4 AUTO** - Continuously illuminates when 4A is selected.

**4x4**

**4X4** - Continuously illuminates when 4H is selected.



**CHECK 4X4** - Displays when a 4X4 fault is present.

**4WD switch positions**

**WARNING:** Utility and four-wheel drive vehicles are **not** designed for cornering at speeds as high as passenger cars any more than low-slung sports cars are designed to perform satisfactorily under off-road conditions. Avoid sharp turns or abrupt maneuvers in these vehicles.

**Note:** The AdvanceTrac® with RSC® stability enhancement system can be turned off manually by pressing the AdvanceTrac button, see the *Traction Control* chapter for more information. This will disable the engine management feature, allowing the vehicle to maintain full power and enhanced momentum through the obstacle.

**Note:** The Control Trac selector switch should not be changed while the rear wheels are slipping.



The Control Trac system functions in three modes:

- **4X2 (2WD)** delivers power to the rear wheels only. The information display will momentarily display 4X2 when this mode is selected. This mode is appropriate for normal on-road driving on dry pavement and provides best fuel economy.
- **4X4 AUTO** provides electronic control four-wheel drive with power delivered to all four wheels, as required, for increased traction. The information display will display 4X4 AUTO when this mode is selected. This mode is appropriate for all on-road driving conditions, such as dry road surfaces, wet pavement, snow, or gravel.
- **4X4** provides electronically locked four-wheel drive power to front and rear wheels. The information display will display 4X4 when this mode is selected. This mode is not recommended for use on dry pavement. This position is only intended for severe winter or off-road conditions, such as deep snow, ice or shallow sand.

**Shifting between system modes**

**Note:** Do not perform these operations if the rear wheels are slipping.

**Note:** Some noise may be heard as the system shifts or engages.

Press any button (4X2, 4X4 AUTO or 4X4) at a stop or while driving. The message center may display a message indicating a 4X4 shift is in progress. Once the shift is complete the message center will then display the system mode selected.

**How Your Vehicle Differs From Other Vehicles**

**WARNING:** Vehicles with a higher center of gravity such as utility and four-wheel drive vehicles handle differently than vehicles with a lower center of gravity. Utility and four-wheel drive vehicles are **not** designed for cornering at speeds as high as passenger cars any more than low-slung sports cars are designed to perform satisfactorily under off-road conditions. Avoid sharp turns, excessive speed and abrupt maneuvers in these vehicles. Failure to drive cautiously could result in an increased risk of loss of vehicle control, vehicle rollover, personal injury and death.

Truck and utility vehicles can differ from some other vehicles. Your vehicle may be higher to allow it to travel over rough terrain without getting hung up or damaging underbody components.

The differences that make your vehicle so versatile also make it handle differently than an ordinary passenger car.

Maintain steering wheel control at all times, especially in rough terrain. Since sudden changes in terrain can result in abrupt steering wheel motion, make sure you grip the steering wheel from the outside. Do not grip the spokes.

Drive cautiously to avoid vehicle damage from concealed objects such as rocks and stumps.

You should either know the terrain or examine maps of the area before driving. Map out your route before driving in the area. To maintain steering and braking control of your vehicle, you must have all four wheels on the ground and they must be rolling, not sliding or spinning.

***Driving Off-Road With Truck and Utility Vehicles***

**Note:** On some 4WD models, the initial shift from two-wheel drive to four-wheel drive while the vehicle is moving can cause some momentary clunk and ratcheting sounds. This is the front drivetrain coming up to speed and the automatic locking hubs engaging and is not cause for concern.

**Note:** Your vehicle may be equipped with a front air dam that can become damaged (due to reduced ground clearance) when taking your vehicle off-road. This air dam can be taken off by removing two bolts.

4WD vehicles are specially equipped for driving on sand, snow, mud and rough terrain and have operating characteristics that are somewhat different from conventional vehicles, both on and off the road.

## 182 Four-Wheel Drive (If Equipped)

---

Power is supplied to all four wheels through a transfer case. On 4WD vehicles, the transfer case allows you to select 4WD when necessary. Information on transfer case operation and shifting procedures can be found in this chapter. Information on transfer case maintenance can be found in the *Maintenance* chapter. You should become thoroughly familiar with this information before you operate your vehicle.

4WD (when you select a 4WD mode) uses all four wheels to power the vehicle. This increases traction, enabling you to drive over terrain and road conditions that a conventional two-wheel drive vehicle cannot.

### ***Basic Operating Principles In Special Conditions***

- Do not use 4WD on dry, hard surfaced roads. Doing so will produce excessive noise, increase tire wear and may damage drive components. 4WD modes are only intended for consistently slippery or loose surfaces.
- Drive slower in strong crosswinds which can affect the normal steering characteristics of your vehicle.
- Be extremely careful when driving on pavement made slippery by loose sand, water, gravel, snow or ice.

### ***If your vehicle goes off the edge of the pavement***

- If your vehicle goes off the edge of the pavement, slow down, but avoid severe brake application, ease the vehicle back onto the pavement only after reducing your speed. Do not turn the steering wheel too sharply while returning to the road surface.
- It may be safer to stay on the apron or shoulder of the road and slow down gradually before returning to the pavement. You may lose control if you do not slow down or if you turn the steering wheel too sharply or abruptly.
- It often may be less risky to strike small objects, such as highway reflectors, with minor damage to your vehicle rather than attempt a sudden return to the pavement which could cause the vehicle to slide sideways out of control or roll over. Remember, your safety and the safety of others should be your primary concern.

### ***If your vehicle gets stuck***



**WARNING:** Do not spin the wheels at over 35 mph (56 km/h). The tires may fail and injure a passenger or bystander.

**Note:** Do not rock the vehicle if the engine is not at normal operating temperature or damage to the transmission may occur.

**Note:** Do not rock the vehicle for more than a few minutes or damage to the transmission and tires may occur or the engine may overheat.

If your vehicle gets stuck in mud or snow it may be rocked out by shifting between forward and reverse gears, stopping between shifts, in a steady pattern. Press lightly on the accelerator in each gear.

### ***Emergency maneuvers***

- In an unavoidable emergency situation where a sudden sharp turn must be made, remember to avoid over-driving your vehicle, i.e., turn the steering wheel only as rapidly and as far as required to avoid the emergency. Excessive steering will result in less vehicle control, not more. Additionally, smooth variations of the accelerator and/or brake pedal pressure should be utilized if changes in vehicle speed are called for. Avoid abrupt steering, acceleration or braking which could result in an increased risk of loss of vehicle control, vehicle rollover and/or personal injury. Use all available road surface to return the vehicle to a safe direction of travel.
- In the event of an emergency stop, avoid skidding the tires and do not attempt any sharp steering wheel movements.
- If the vehicle goes from one type of surface to another (i.e., from concrete to gravel) there will be a change in the way the vehicle responds to a maneuver (steering, acceleration or braking). Again, avoid these abrupt inputs.

### ***Sand***

When driving over sand, try to keep all four wheels on the most solid area of the trail. Avoid reducing the tire pressures but shift to a lower gear and drive steadily through the terrain. Apply the accelerator slowly and avoid spinning the wheels.

Avoid excessive speed because vehicle momentum can work against you and cause the vehicle to become stuck to the point that assistance may be required from another vehicle. Remember, you may be able to back out the way you came if you proceed with caution.

### ***Mud and water***

**Note:** Driving through deep water may damage the vehicle.

If you must drive through high water, drive slowly. Traction or brake capability may be limited.

When driving through water, determine the depth; avoid water higher than the bottom of the hubs (if possible) and proceed slowly. If the ignition system gets wet, the vehicle may stall.

Once through water, always try the brakes. Wet brakes do not stop the vehicle as effectively as dry brakes. Drying can be improved by moving your vehicle slowly while applying light pressure on the brake pedal.

Be cautious of sudden changes in vehicle speed or direction when you are driving in mud. Even 4WD vehicles can lose traction in slick mud. As when you are driving over sand, apply the accelerator slowly and avoid spinning your wheels. If the vehicle does slide, steer in the direction of the slide until you regain control of the vehicle.

If the transmission, transfer case or front axle are submerged in water, their fluids should be checked and changed, if necessary.

If the front or rear axle is submerged in water, the axle lubricant should be replaced.

After driving through mud, clean off residue stuck to rotating driveshafts and tires. Excess mud stuck on tires and rotating driveshafts causes an imbalance that could damage drive components.



“Tread Lightly” is an educational program designed to increase public awareness of land-use regulations and responsibilities in our nations wilderness areas. Ford Motor Company joins the U.S. Forest

Service and the Bureau of Land Management in encouraging you to help preserve our national forest and other public and private lands by “treading lightly.”

### ***Driving on hilly or sloping terrain***

**Note:** Avoid driving crosswise or turning on steep slopes or hills.

Although natural obstacles may make it necessary to travel diagonally up or down a hill or steep incline, you should always try to drive straight up or straight down. A danger lies in losing traction, slipping sideways and possibly rolling over. Whenever driving on a hill, determine beforehand the route you will use. Do not drive over the crest of a hill without seeing what conditions are on the other side. Do not drive in reverse over a hill without the aid of an observer.

When climbing a steep slope or hill, start in a lower gear rather than downshifting to a lower gear from a higher gear once the ascent has started. This reduces strain on the engine and the possibility of stalling.

If you do stall out, do not try to turn around because you might roll over. It is better to back down to a safe location.

Apply just enough power to the wheels to climb the hill. Too much power will cause the tires to slip, spin or lose traction, resulting in loss of vehicle control.



Descend a hill in the same gear you would use to climb up the hill to avoid excessive brake application and brake overheating. Do not descend in neutral; instead, disengage overdrive or manually shift to a lower gear. When descending a steep hill, avoid sudden hard braking as you could lose control. When you brake hard, the front wheels can't turn and if

they aren't turning, you won't be able to steer. The front wheels have to be turning in order to steer the vehicle.

If your vehicle has anti-lock brakes, apply the brakes steadily. Do not pump the brakes.

### ***Driving on snow and ice***



**WARNING:** If you are driving in slippery conditions that require tire chains or cables, then it is critical that you drive cautiously. Keep speeds down, allow for longer stopping distances and avoid aggressive steering to reduce the chances of a loss of vehicle control which can lead to serious injury or death. If the rear end of the vehicle slides while cornering, steer in the direction of the slide until you regain control of the vehicle.

4WD vehicles have advantages over 2WD vehicles in snow and ice but can skid like any other vehicle.

Should you start to slide while driving on snowy or icy roads, turn the steering wheel in the direction of the slide until you regain control.

Avoid sudden applications of power and quick changes of direction on snow and ice. Apply the accelerator slowly and steadily when starting from a full stop.

Avoid sudden braking as well. Although a 4WD vehicle may accelerate better than a two-wheel drive vehicle in snow and ice, it won't stop any faster, because as in other vehicles, braking occurs at all four wheels. Do not become overconfident as to road conditions.

Make sure you allow sufficient distance between you and other vehicles for stopping. Drive slower than usual and consider using one of the lower gears. In emergency stopping situations, apply the brake steadily. Do not pump the brakes. Refer to the *Brakes* section of this chapter for additional information on the operation of the Anti-lock Brake System (ABS).

***Maintenance and modifications***

The suspension and steering systems on your vehicle have been designed and tested to provide predictable performance whether loaded or empty and durable load carrying capability. For this reason, Ford Motor Company strongly recommends that you do not make modifications such as adding or removing parts (such as lift kits or stabilizer bars) or by using replacement parts not equivalent to the original factory equipment.

Any modifications to a vehicle that raise the center of gravity can make it more likely the vehicle will roll over as a result of a loss of control. Ford Motor Company recommends that caution be used with any vehicle equipped with a high load or device (such as ladder racks or pickup box cover).

Failure to maintain your vehicle properly may void the warranty, increase your repair cost, reduce vehicle performance and operational capabilities and adversely affect driver and passenger safety. Frequent inspection of vehicle chassis components is recommended if the vehicle is subjected to heavy off-road usage.

**GENERAL INFORMATION**

**Note:** Occasional brake noise is normal. If a metal-to-metal, continuous grinding or continuous squeal sound is present, the brake linings may be worn out. Have them inspected by an authorized dealer. If your vehicle has continuous vibration or shudder in the steering wheel while braking, have your vehicle inspected by an authorized dealer.

**Note:** Brake dust may accumulate on the wheels, even under normal driving conditions. Some dust is inevitable as the brakes wear and does not contribute to brake noise. See the *Vehicle Care* chapter for wheel cleaning instructions.



See the *Instrument Cluster* chapter for information on the brake system warning light.

Wet brakes result in reduced braking efficiency. Gently press the brake pedal a few times when driving from a car wash or standing water to dry the brakes.

**Brake Over Accelerator**

In the event the accelerator pedal becomes stuck or entrapped, apply steady and firm pressure to the brake pedal to slow your vehicle and reduce engine power. If you experience this condition, apply the brakes and bring your vehicle to a safe stop. Turn the engine off, shift to park (P) and apply the parking brake. Inspect the accelerator pedal and the area around it for any items or debris that may be obstructing its movement. If none are found and the condition persists, have your vehicle towed to the nearest authorized dealer.

**Anti-Lock Brake System**

This system helps you maintain steering control during emergency stops by keeping the brakes from locking.



This lamp momentarily illuminates when you turn the ignition on. If the light does not illuminate during start-up, remains on or flashes, the anti-lock brake system may be disabled and may need to be serviced.



If the anti-lock brake system is disabled, normal braking is still effective. If the brake warning lamp illuminates with the parking brake released, have your brake system serviced immediately.

**HINTS ON DRIVING WITH ANTI-LOCK BRAKES**

When the system is operating, the brake pedal will pulse and may travel further. Maintain pressure on the brake pedal. You may also hear a noise from the system. This is normal.

The anti-lock braking system will not eliminate the dangers inherent when:

- You drive too closely to the vehicle in front of you.
- Your vehicle is hydroplaning.
- You take corners too fast.
- The road surface is poor.

**PARKING BRAKE**

**WARNING:** Always set the parking brake fully and make sure that the transmission is securely latched in park (P).

To set the parking brake, press the parking brake pedal down until the pedal stops.

The brake warning lamp will illuminate and will remain illuminated until the parking brake is released.

To release, pull the brake release lever located at the lower left side of the instrument panel.

**PRINCIPLES OF OPERATION**

The traction control system helps avoid drive wheel spin and loss of traction.

If your vehicle begins to slide, the system applies the brakes to individual wheels and, when needed, reduces engine power at the same time. If the wheels spin when accelerating on slippery or loose surfaces, the system reduces engine power in order to increase traction.

**USING TRACTION CONTROL**

In certain situations (for example, stuck in snow or mud), turning the traction control off may be beneficial as this allows the wheels to spin with full engine power. Turn the traction control system off using the **TCS OFF** button located on the center of the instrument panel.

**System indicator lights and messages**

**WARNING:** If a failure has been detected within the traction control system, the stability control light will illuminate steadily. Verify that the traction control system was not manually disabled using the stability control button. If the stability control light still illuminates steadily, have the system serviced by an authorized dealer immediately. Operating your vehicle with traction control disabled could lead to an increased risk of loss of vehicle control, vehicle rollover, personal injury and death.



The stability control light temporarily illuminates on engine start-up and flashes when a driving condition activates the stability system.



The stability control off light temporarily illuminates on engine start-up and stays on when the traction control system is turned off or if a problem occurs in the stability system.

---

**PRINCIPLES OF OPERATION**

**WARNING:** Vehicle modifications involving braking system, aftermarket roof racks, suspension, steering system, tire construction or wheel and tire size may change the handling characteristics of the vehicle and may adversely affect the performance of the AdvanceTrac® system. In addition, installing any stereo loudspeakers may interfere with and adversely affect the AdvanceTrac® system. Install any aftermarket stereo loudspeaker as far as possible from the front center console, the tunnel, and the front seats in order to minimize the risk of interfering with the AdvanceTrac® sensors. Reducing the effectiveness of the AdvanceTrac® system could lead to an increased risk of loss of vehicle control, vehicle rollover, personal injury and death.



**WARNING:** Remember that even advanced technology cannot defy the laws of physics. It's always possible to lose control of a vehicle due to inappropriate driver input for the conditions. Aggressive driving on any road condition can cause you to lose control of your vehicle increasing the risk of personal injury or property damage. Activation of the AdvanceTrac® system is an indication that at least some of the tires have exceeded their ability to grip the road; this could reduce the operator's ability to control the vehicle potentially resulting in a loss of vehicle control, vehicle rollover, personal injury and death. If your AdvanceTrac® system activates, SLOW DOWN.

The AdvanceTrac® with Roll Stability Control™ system helps you keep control of your vehicle when on a slippery surface. The electronic stability control portion of the system helps avoid skids and lateral slides and roll stability control helps avoid a vehicle rollover. The traction control system helps avoid drive wheel spin and loss of traction. See the *Traction Control* chapter for details on traction control system operation.

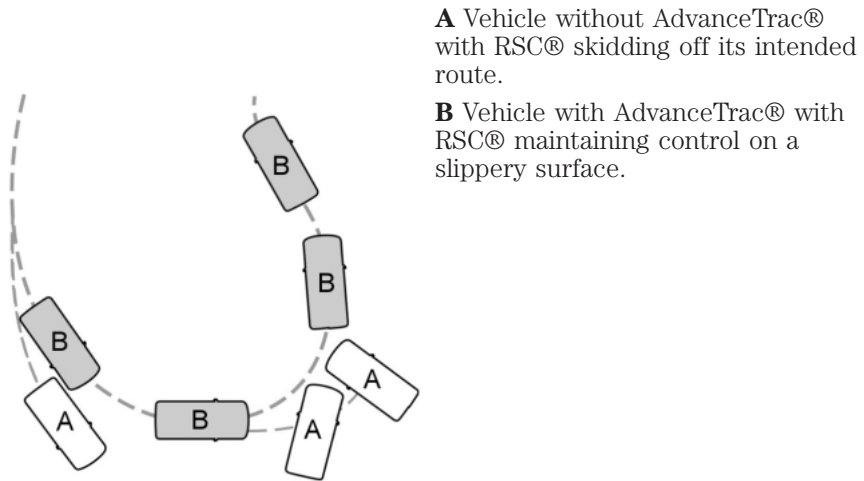

**A** Vehicle without AdvanceTrac® with RSC® skidding off its intended route.

**B** Vehicle with AdvanceTrac® with RSC® maintaining control on a slippery surface.

#### USING ADVANCETRAC® WITH RSC®

The system automatically activates when you start your engine. The AdvanceTrac with RSC system cannot be completely turned off, but the electronic stability control and roll stability control portions of the system are disabled when the transmission is in reverse (R). You can turn off the traction control portion of the system independently. See the *Traction Control* chapter.

**SENSING SYSTEM (IF EQUIPPED)**

**WARNING:** To help avoid personal injury, please read and understand the limitations of the system as contained in this section. Sensing is only an aid for some (generally large and fixed) objects when moving in reverse on a flat surface at parking speeds. Traffic control systems, inclement weather, air brakes, and external motors and fans may also affect the function of the sensing system; this may include reduced performance or a false activation.



**WARNING:** To help avoid personal injury, always use caution when in R (Reverse) and when using the sensing system.



**WARNING:** This system is not designed to prevent contact with small or moving objects. The system is designed to provide a warning to assist the driver in detecting large stationary objects to avoid damaging the vehicle. The system may not detect smaller objects, particularly those close to the ground.



**WARNING:** Certain add-on devices such as large trailer hitches, bike or surfboard racks and any device that may block the normal detection zone of the system, may create false beeps.

**Note:** Keep the sensors (located on the bumper/fascia) free from snow, ice and large accumulations of dirt. If the sensors are covered, the system's accuracy can be affected. Do not clean the sensors with sharp objects.

**Note:** If your vehicle sustains damage to the bumper/fascia, leaving it misaligned or bent, the sensing zone may be altered causing inaccurate measurement of obstacles or false alarms.

**Note:** If your vehicle is equipped with MyKey®, it is possible to prevent turning the sensing system off. Refer to the *MyKey®* chapter.

The sensing system warns the driver of obstacles within a certain range of the bumper area. The system turns on automatically whenever the ignition is switched on.

When receiving a detection warning, the radio volume is reduced to a predetermined level. After the warning goes away, the radio volume returns to the previous level.

**Using the Front and Rear Sensing System**

**Rear Sensing System**

The rear sensors are only active when the transmission is in R (Reverse). As the vehicle moves closer to the obstacle, the rate of the audible warning increases. When the obstacle is fewer than 10 inches (25 centimeters) away, the warning sounds continuously. If a stationary or receding object is detected farther than 10 inches (25 centimeters) from the side of the vehicle, the tone sounds for only three seconds. Once the system detects an object approaching, the warning sounds again.

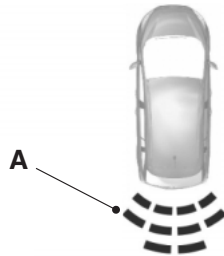

A. Coverage area of up to 6 feet (2 meters) from the rear bumper (with a decreased coverage area at the outer corners of the bumper).

The system detects certain objects while the transmission is in R (Reverse):

- and moving toward a stationary object at a speed of 3 mph (5 km/h) or less.
- but not moving, and a moving object is approaching the rear of the vehicle at a speed of 3 mph (5 km/h) or less.
- and moving at a speed of less than 3 mph (5 km/h) and a moving object is approaching the rear of the vehicle at a speed of less than 3 mph (5 km/h).

**Front Sensing System**

The front sensors are active when the gearshift is in any position other than P (Park) or N (Neutral) and the vehicle speed is below 8 mph (13 km/h).

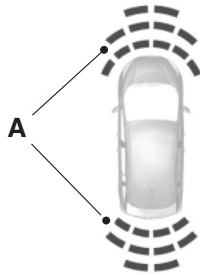

A. Coverage area of up to 27 inches (70 centimeters) from the front of the vehicle and about 6–9 inches (15–23 centimeters) to the side of the front end of the vehicle. Refer to the reverse sensing section for details on coverage area.

The system sounds an audible warning when obstacles are near either bumper in the following manner:

- Objects detected by the front sensors are indicated by a high-pitched tone from the front of the vehicle.
- Objects detected by the rear sensors are indicated by a lower pitched tone from the rear of the vehicle.
- The sensing system reports the obstacle which is closest to the front or rear of the vehicle. For example, if an obstacle is 12 inches (30 centimeters) from the front of the vehicle and, at the same time, an obstacle is only 6 inches (15 centimeters) from the rear of the vehicle, the lower pitched tone sounds.
- An alternating warning sounds from the front and rear if there are objects at both bumpers that are closer than 10 inches (25 centimeters).

For specific information on the reverse sensing portion of the system, refer to that section.

**REAR VIEW CAMERA SYSTEM (IF EQUIPPED)**

**!** **WARNING:** The rear view camera system is a reverse aid supplement device that still requires the driver to use it in conjunction with the interior and exterior mirrors for maximum coverage.

**!** **WARNING:** Objects that are close to either corner of the bumper or under the bumper, might not be seen on the screen due to the limited coverage of the camera system.

**!** **WARNING:** Back up as slow as possible since higher speeds might limit your reaction time to stop the vehicle.

**!** **WARNING:** Use caution when using the rear video camera and the liftgate is ajar. If the liftgate is ajar, the camera will be out of position and the video image may be incorrect. All guidelines (if enabled) have been removed when the liftgate is ajar.

**!** **WARNING:** Use caution when turning camera features on or off while in R (Reverse). Make sure the vehicle is not moving.

The rear view camera system provides a video image of the area behind the vehicle.

During operation, lines appear in the display which represent your vehicle's path and proximity to objects behind the vehicle.

The camera is located on the liftgate.



**Using the Rear View Camera System**

The rear view camera system displays what is behind your vehicle when you place the transmission in R (Reverse). The system uses two types of guides to help you see what is behind your vehicle:

1. Fixed guidelines: Show the actual path the vehicle is moving in while reversing in a straight line, which can be helpful when backing into a parking space or aligning the vehicle with another object behind the vehicle.
2. Centerline: Helps align the center of the vehicle with an object (i.e. a trailer).

**Note:** If the image comes on while the transmission is not in R (Reverse), have the system inspected by your authorized dealer.

**Note:** When towing, the camera only sees what is being towed behind the vehicle. This might not provide adequate coverage as it usually provides in normal operation and some objects might not be seen. In some vehicles, the guidelines may disappear once the trailer tow connector is engaged.

**Note:** The default setting for the camera delay is off. Press the Settings button found on the navigation screen (if equipped) to set the camera delay feature to on or off.

**Note:** The camera may not operate correctly under the following conditions:

- Nighttime or dark areas if one or both reverse lamps are not operating.
- The camera's view is obstructed by mud, water or debris. Clean the lens with a soft, lint-free cloth and non-abrasive cleaner.
- The rear of the vehicle is hit or damaged, causing the camera to become misaligned.

**Guidelines and the Centerline**

**Note:** Fixed guidelines are only available when the transmission is in R (Reverse).

**Note:** The centerline is only available if fixed guidelines are on.

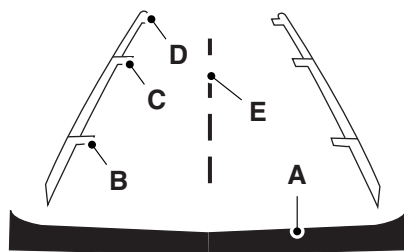

- A. Rear bumper
- B. Fixed guideline: Red zone
- C. Fixed guideline: Yellow zone
- D. Fixed guideline: Green zone
- E. Centerline

The fixed guidelines fade in and out depending on the steering wheel position.

Always use caution while reversing. Objects in the red zone are closest to your vehicle and objects in the green zone are further away. Objects are getting closer to your vehicle as they move from the green zone to the yellow or red zones. Use the side view mirrors and rear view mirror to get better coverage on both sides and rear of the vehicle.

**Rear Camera Delay**

**Navigation display**

When shifting the transmission out of R (Reverse) and into any gear other than P (Park), the camera image remains in the display until the vehicle speed reaches 5 mph (8 km/h). This occurs when the rear camera delay feature is on, or until a radio button is selected.

Selectable settings for this feature are ON and OFF. The default setting for the rear camera delay is OFF.

**Rearview mirror display**

When shifting out of R (Reverse) and into any other gear, the image in the rearview mirror will remain on for a few seconds before it shuts off to assist in parking or trailer hookup.

**PRINCIPLES OF OPERATION**

Cruise control lets you maintain a set speed without keeping your foot on the accelerator pedal.

**USING CRUISE CONTROL**

**WARNING:** Do not use cruise control in heavy traffic, on winding roads or when the road surface is slippery. This could result in loss of vehicle control, serious injury or death.



**WARNING:** When you are going downhill, your vehicle speed may increase above the set speed. The system will not apply the brakes. Change down a gear to assist the system in maintaining the set speed. Failure to do so could result in loss of vehicle control, serious injury or death.

**Note:** Cruise control will disengage if your vehicle speed decreases more than 10 mph (16 km/h) below your set speed while driving uphill.



The cruise controls are located on the steering wheel.

**Switching On Cruise Control**

Press and release **ON**.

**Setting a Speed**

1. Accelerate to the desired speed.
2. Press and release **SET+**.
3. Take your foot off the accelerator pedal.



The indicator will turn on in the instrument cluster.

**Changing the Set Speed**

- Press and hold **SET+** or **SET-**. Release the button when you reach the desired speed.
- Press and release **SET+** or **SET-**. The set speed will change in approximately 1 mph (2 km/h) increments.
- Press the accelerator pedal or brake pedal until you reach the desired speed. Press and release **SET+**.

**Canceling a Set Speed**

Tap the brake pedal. The set speed will not be erased.

**Resuming a Set Speed**

Press and release **RESUME**.

**Switching Off Cruise Control**

**Note:** The set speed is erased when you turn off cruise control.

Press **OFF** or turn off the ignition.

**STEERING**

Your vehicle is equipped with power steering. Power steering uses energy from the engine to decrease the driver's effort in steering the vehicle.

To help prevent damage to the power steering pump:

- Never hold the steering wheel to the extreme right or the extreme left for more than a few seconds when the engine is running.
- Do not operate the vehicle with the power steering pump fluid level below the MIN mark on the reservoir.
- Some noise is normal during operation. If the noise is excessive, check for low power steering pump fluid level before seeking service by your authorized dealer.
- Heavy or uneven steering efforts may be caused by low power steering pump fluid level. Check for low power steering pump fluid level before seeking service by your authorized dealer.
- Do not fill the power steering pump reservoir above the MAX mark on the reservoir, as this may result in leaks from the reservoir.

If the power steering system breaks down (or if the engine is turned off), you can steer the vehicle manually, but it takes more effort.

If the steering wanders or pulls, check for:

- Underinflated tire(s) on any wheel(s)
- Uneven vehicle loading
- High crown in center of road
- High crosswinds
- Wheels out of alignment
- Loose or worn suspension components

**AUTO LEVELING SUSPENSION SYSTEM (if equipped)**

The automatic leveling suspension system is designed to improve ride, handling and general vehicle performance during:

- Certain road conditions
- Steering maneuvers
- Braking
- Acceleration
- Towing

This system keeps the rear of your vehicle at a constant level through a hydraulic pump inside each rear shock. Depending on the payload or road surface conditions it will take approximately 2 miles (3.2 km) for the leveling to complete.

If the loaded vehicle is not moved for approximately 12 hours, the leveling system may bleed down to a lower height. This can be especially apparent if a trailer is left attached to the parked vehicle for long periods of time. You must drive your vehicle in order to re-level the suspension.

If a self-equalizing hitch is being used, your vehicle should be drive approximately 2 miles (3.2 km) with the trailer prior to adjusting (leveling) the hitch.

**ROOF RACKS AND LOAD CARRIERS**

**WARNING:** When loading the roof rail crossbars, it is recommended to evenly distribute the load, as well as maintain a low center of gravity. Loaded vehicles, with higher centers of gravity, may handle differently than unloaded vehicles. Extra precautions, such as slower speeds and increased stopping distance, should be taken when driving a heavily loaded vehicle.

**Note:** The maximum recommended load is 200 pounds (90 kilograms), evenly distributed on the crossbars.

**Note:** Loads should never be placed directly on the roof panel. The roof panel is not designed to directly carry a load.

For proper function of the roof rack system, loads must be placed directly on crossbars affixed to the roof rack side rails. Your vehicle may be equipped with factory-installed crossbars. Ford Genuine Accessory crossbars, designed specifically for your vehicle, are also recommended for use with your roof rack system.

Make sure that the load is securely fastened. Check the tightness of the load before driving and at each fuel stop.

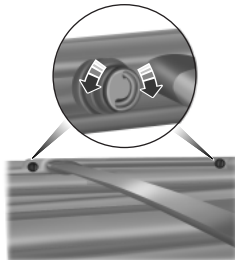
**Adjusting the Crossbars (If Equipped)**

1. Loosen the thumbwheels at both ends of the crossbar by turning them counterclockwise (both crossbars are adjustable).
2. Slide the crossbar to the desired location.
3. Tighten the thumbwheels at both ends of the crossbar by turning them clockwise.

Make sure to check that the thumbwheels are tight each time a load is added or removed from the roof rack, and periodically while traveling. Make sure that the load is secure before traveling.

**LOAD LIMIT****Vehicle Loading – With and Without a Trailer**

This section will guide you in the proper loading of your vehicle and/or trailer, to keep your loaded vehicle weight within its design rating capability, with or without a trailer. Properly loading your vehicle will provide maximum return of vehicle design performance. Before loading your vehicle, familiarize yourself with the following terms for determining your vehicle's weight ratings, with or without a trailer, from the vehicle's Tire Label or Safety Compliance Certification Label:

**Base Curb Weight** – is the weight of the vehicle including a full tank of fuel and all standard equipment. It does not include passengers, cargo, or optional equipment.

**Vehicle Curb Weight** – is the weight of your new vehicle when you picked it up from your authorized dealer plus any aftermarket equipment.

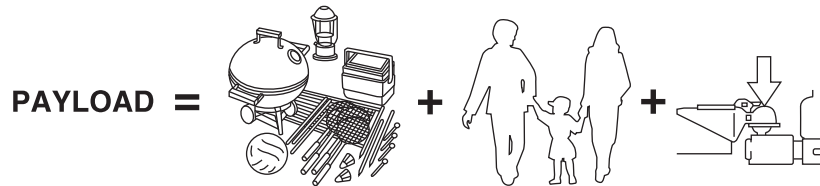

**Payload** – is the combined weight of cargo and passengers that the vehicle is carrying. The maximum payload for your vehicle can be found on the Tire Label on the B-Pillar or the edge of the driver's door (vehicles exported outside the US and Canada may not have a Tire Label). Look for **“THE COMBINED WEIGHT OF OCCUPANTS AND CARGO SHOULD NEVER EXCEED XXX kg OR XXX lb.”** for maximum payload. The payload listed on the Tire Label is the maximum payload for the vehicle as built by the assembly plant. If any aftermarket or authorized-dealer installed equipment has been installed on the vehicle, the weight of the equipment must be subtracted from the payload listed on the Tire Label in order to determine the new payload.

**WARNING:** The appropriate loading capacity of your vehicle can be limited either by volume capacity (how much space is available) or by payload capacity (how much weight the vehicle should carry). Once you have reached the maximum payload of your vehicle, do not add more cargo, even if there is space available. Overloading or improperly loading your vehicle can contribute to loss of vehicle control and vehicle rollover.

**Example only:**

**TIRE AND LOADING INFORMATION**

SEATING CAPACITY | TOTAL 5 | FRONT 2 | REAR 3

The combined weight of occupants and cargo should never exceed : XXX kg or XXX lbs.

TIRE	SIZE	COLD TIRE PRESSURE	SEE OWNERS MANUAL FOR ADDITIONAL INFORMATION
FRONT	LT225/75R 16,5E	200 KPA, 29 PSI	
REAR	LT225/75R 16,5E	200 KPA, 29 PSI	
SPARE	T145/80D16 P225/60R17	420 KPA, 60 PSI 200 KPA, 29 PSI	

**TIRE AND LOADING INFORMATION**  
**RENSEIGNEMENTS SUR LES PNEUS ET LE CHARGEMENT**

SEATING CAPACITY | TOTAL 5 | FRONT 2 | REAR 3  
NOMBRE DE PLACES | TOTAL 5 | AVANT 2 | ARRIERE 3

The combined weight of occupants and cargo should never exceed 492 kg or 1085 lbs.  
Le poids total des occupants et du chargement ne doit jamais dépasser 492 kg ou 1085 lb.

TIRE PNEU	SIZE DIMENSIONS	COLD TIRE PRESSURE PRESSION DES PNEUS A FROID	SEE OWNER'S MANUAL FOR ADDITIONAL INFORMATION  VOIR LE MANUEL DE L'USAGER POUR PLUS DE RENSEIGNEMENTS
FRONT AVANT	P235/70R16	240 KPA, 35 PSI	
REAR ARRIERE	P235/70R16	240 KPA, 35 PSI	
SPARE DE SECOURS	T145/90R17	415 KPA, 60 PSI	



**Cargo Weight** – includes all weight added to the Base Curb Weight, including cargo and optional equipment. When towing, trailer tongue load or king pin weight is also part of cargo weight.

**GAW (Gross Axle Weight)** – is the total weight placed on each axle (front and rear) – including vehicle curb weight and all payload.

**GAWR (Gross Axle Weight Rating)** – is the maximum allowable weight that can be carried by a single axle (front or rear). **These numbers are shown on the Safety Compliance Certification Label. The label shall be affixed to either the door hinge pillar, door-latch post, or the door edge that meets the door-latch post, next to the driver’s seating position. The total load on each axle must never exceed its GAWR.**

**Note:** For trailer towing information refer to the *RV and Trailer Towing Guide* provided by your authorized dealer.

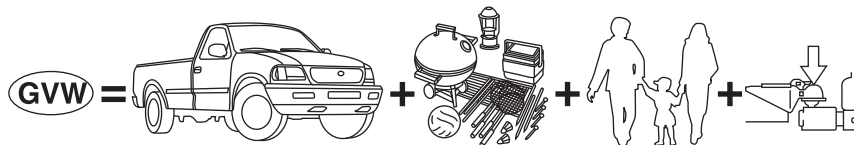

**GVW (Gross Vehicle Weight)** – is the Vehicle Curb Weight + cargo + passengers.

**GVWR (Gross Vehicle Weight Rating)** – is the maximum allowable weight of the fully loaded vehicle (including all options, equipment, passengers and cargo). **The GVWR is shown on the Safety Compliance Certification Label. The label shall be affixed to either the door hinge pillar, door-latch post, or the door edge that meets the door-latch post, next to the driver’s seating position. The GVW must never exceed the GVWR.**

- Example only:

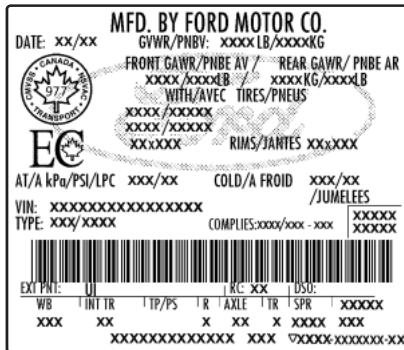
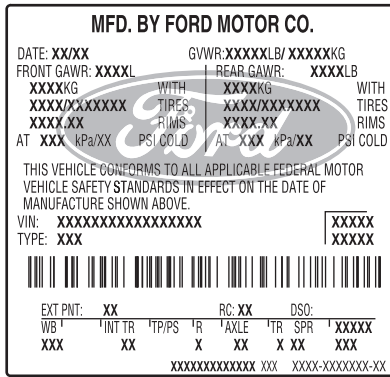

 **WARNING:** Exceeding the Safety Compliance Certification Label vehicle weight rating limits could result in substandard vehicle handling or performance, engine, transmission and/or structural damage, serious damage to the vehicle, loss of control and personal injury.



**GCW (Gross Combined Weight)** – is the weight of the loaded vehicle (GVW) plus the weight of the fully loaded trailer.

**GCWR (Gross Combined Weight Rating)** – is the maximum allowable weight of the vehicle and the loaded trailer – including all cargo and passengers – that the vehicle can handle without risking damage.

(Important: The towing vehicle's braking system is rated for operation at GVWR, not at GCWR.) Separate functional brakes should be used for safe control of towed vehicles and for trailers where the GCW of the towing vehicle plus the trailer exceed the GVWR of the towing vehicle.

**The GCW must never exceed the GCWR.**

**Maximum Loaded Trailer Weight** – is the highest possible weight of a fully loaded trailer the vehicle can tow. It assumes a vehicle with only mandatory options, no cargo (internal or external), a tongue load of 10–15% (conventional trailer) or king pin weight of 15–25% (fifth wheel trailer), and driver only (150 lb. [68 kg]). **Consult your authorized dealer (or the *RV and Trailer Towing Guide* provided by your authorized dealer) for more detailed information.**

**Tongue Load or Fifth Wheel King Pin Weight** – refers to the amount of the weight that a trailer pushes down on a trailer hitch.

**Examples:** For a 5,000 lb. (2,268 kg) conventional trailer, multiply 5,000 by 0.10 and 0.15 to obtain a proper tongue load range of 500 to 750 lb. (227 to 340 kg). For an 11,500 lb. (5,216 kg) fifth wheel trailer, multiply by 0.15 and 0.25 to obtain a proper king pin load range of 1,725 to 2,875 lb. (782 to 1,304 kg)

 **WARNING:** Do not exceed the GVWR or the GAWR specified on the Safety Compliance Certification Label.



**WARNING:** Do not use replacement tires with lower load carrying capacities than the original tires because they may lower the vehicle's GVWR and GAWR limitations. Replacement tires with a higher limit than the original tires do not increase the GVWR and GAWR limitations.



**WARNING:** Exceeding any vehicle weight rating limitation could result in serious damage to the vehicle and/or personal injury.

### Steps for determining the correct load limit:

1. Locate the statement "The combined weight of occupants and cargo should never exceed XXX kg or XXX lb." on your vehicle's placard.
2. Determine the combined weight of the driver and passengers that will be riding in your vehicle.
3. Subtract the combined weight of the driver and passengers from XXX kg or XXX lb.
4. The resulting figure equals the available amount of cargo and luggage load capacity. For example, if the "XXX" amount equals 1,400 lb. and there will be five 150 lb. passengers in your vehicle, the amount of available cargo and luggage load capacity is 650 lb. (1400-750 (5 x 150) = 650 lb.).
5. Determine the combined weight of luggage and cargo being loaded on the vehicle. That weight may not safely exceed the available cargo and luggage load capacity calculated in Step 4.
6. If your vehicle will be towing a trailer, load from your trailer will be transferred to your vehicle. Consult this manual to determine how this reduces the available cargo and luggage load capacity of your vehicle.

The following gives you a few examples on how to calculate the available amount of cargo and luggage load capacity:

- Suppose your vehicle has a 1400 lb. (635 kg) cargo and luggage capacity. You decide to go golfing. Is there enough load capacity to carry you, 4 of your friends and all the golf bags? You and four friends average 220 lb. (99 kg) each and the golf bags weigh approximately 30 lb. (13.5 kg) each. The calculation would be:  $1400 - (5 \times 220) - (5 \times 30) = 1400 - 1100 - 150 = 150$  lb. Yes, you have enough load capacity in your vehicle to transport four friends and your golf bags. In metric units, the calculation would be:  $635 \text{ kg} - (5 \times 99 \text{ kg}) - (5 \times 13.5 \text{ kg}) = 635 - 495 - 67.5 = 72.5$  kg.

- Suppose your vehicle has a 1400 lb. (635 kg) cargo and luggage capacity. You and one of your friends decide to pick up cement from the local home improvement store to finish that patio you have been planning for the past 2 years. Measuring the inside of the vehicle with the rear seat folded down, you have room for 12-100 lb. (45 kg) bags of cement. Do you have enough load capacity to transport the cement to your home? If you and your friend each weigh 220 lb. (99 kg), the calculation would be:  $1400 - (2 \times 220) - (12 \times 100) = 1400 - 440 - 1200 = -240$  lb. No, you do not have enough cargo capacity to carry that much weight. In metric units, the calculation would be:  $635 \text{ kg} - (2 \times 99 \text{ kg}) - (12 \times 45 \text{ kg}) = 635 - 198 - 540 = -103$  kg. You will need to reduce the load weight by at least 240 lb. (104 kg). If you remove 3-100 lb. (45 kg) cement bags, then the load calculation would be:  
 $1400 - (2 \times 220) - (9 \times 100) = 1400 - 440 - 900 = 60$  lb. Now you have the load capacity to transport the cement and your friend home. In metric units, the calculation would be:  $635 \text{ kg} - (2 \times 99 \text{ kg}) - (9 \times 45 \text{ kg}) = 635 - 198 - 405 = 32$  kg.

The above calculations also assume that the loads are positioned in your vehicle in a manner that does not overload the Front or the Rear Gross Axle Weight Rating specified for your vehicle on the Safety Compliance Certification Label. The label shall be affixed to either the door hinge pillar, door-latch post, or the door edge that meets the door-latch post, next to the driver's seating position.

### Special Loading Instructions for Owners of Pick-up Trucks and Utility-type Vehicles



**WARNING:** Loaded vehicles may handle differently than unloaded vehicles. Extra precautions, such as slower speeds and increased stopping distance, should be taken when driving a heavily loaded vehicle.

Your vehicle can haul more cargo and people than most passenger cars. Depending upon the type and placement of the load, hauling cargo and people may raise the center of gravity of the vehicle.

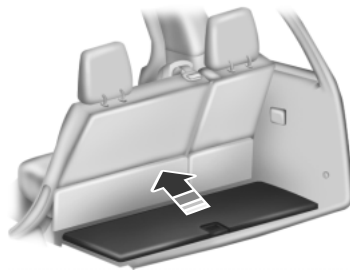
**CARGO MANAGEMENT SYSTEM (IF EQUIPPED)**

A storage compartment is located in the floor of the rear cargo area.

Lift up on the handle to open the cover.

To close, lower the cover and press down on the handle until the latch clicks.

**Cargo Shelf and Divider (If Equipped)**

**WARNING:** Do not load any objects on the shelf that may obstruct your vision or strike occupants of the vehicle in the case of a sudden stop or collision.



**WARNING:** Do not place people or pets on or under the parcel shelf.

**Note:** Do not put more than 30 pounds (14 kilograms) on the shelf.

The cargo shelf and divider is located behind the rear seat of your vehicle and has two positions:

- A flat shelf which pivots up and snaps into place.
- A divider which pivots up and snaps vertically into place.

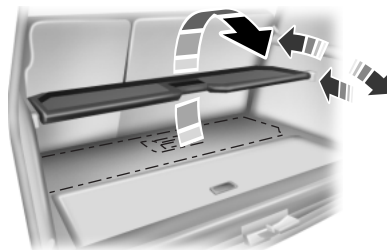

**To move the shelf to the shelf position:** Pull up and pivot the shelf over the channels on the side trim panels and snap the shelf ends in the channels.

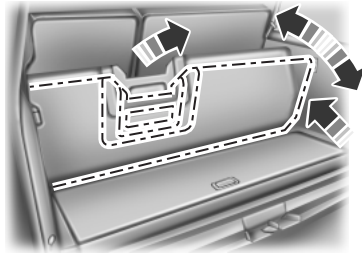

**To move the shelf to the divider position:** Pull up and pivot the shelf over the channels on the side trim panels and snap vertically in place.

#### POWER DEPLOYABLE RUNNING BOARDS (IF EQUIPPED)

**!** **WARNING:** In extreme climates, excessive ice buildup may occur, causing the running boards not to deploy. Be sure that the running boards have deployed, and have finished moving before attempting to step on them. The running boards will resume normal function once the blockage is cleared.

**!** **WARNING:** Turn off the running boards before jacking or placing any object under the vehicle. Never place your hand between the extended running board and the vehicle. A moving running board may cause injury.

**Note:** Do not use the running boards, front and rear hinge assemblies, running board motors, or the running board under body mounts to lift the vehicle when jacking. Always use proper jacking points.

**Note:** The running boards may operate slower in cooler temperatures. Debris such as mud, dirt and salt may become trapped in the running board mechanism, possibly leading to unwanted noise. If this occurs, manually set the running boards to the deployed position and flush the system (in particular the front and rear hinge arms) with a high-pressure car wash wand.

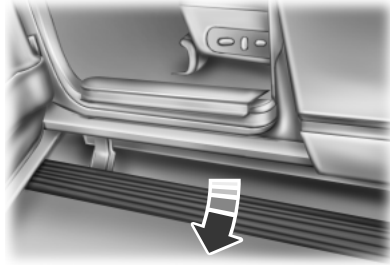

The running boards automatically move when the doors are opened to assist entering and exiting the vehicle.

#### **Automatic Power Deploy**

The running boards will extend down and out when the doors are opened.

#### **Automatic Power Stow**

The running boards will return to the stowed position after a two second delay when the doors are closed.

#### **Manual Power Deploy**

To manually operate the running boards, refer to the *Information Displays* chapter.

- This feature can manually set the running boards in the deployed (OUT) position for access to the roof.
- When running boards are manually set in the deployed position, they will return to the stowed position and enter automatic mode when the vehicle speed exceeds 5 mph (8 km/h).

#### **Enable and Disable**

To enable and disable the power running board feature, refer to the *Information Displays* chapter.

- When this feature is disabled (OFF), the running boards will move to the stowed position regardless of the position of the doors.
- When this feature is enabled (AUTO), the running boards will move back to the correct positions based off of the door positions.

#### **Bounce-Back**

If an object is in the way of the moving running board, it will reverse direction and move to the end of travel.

**TOWING A TRAILER**

**WARNING:** Do not exceed the GVWR or the GAWR specified on the certification label.



**WARNING:** Towing trailers beyond the maximum recommended gross trailer weight exceeds the limit of your vehicle and could result in engine damage, transmission damage, structural damage, loss of vehicle control, vehicle rollover and personal injury.

**Note:** For information on electrical items such as fuses or relays, see the *Fuses* chapter.

The load capacity of your vehicle is designated by weight not volume. You may not necessarily be able to use all available space when loading your vehicle or trailer.

Towing a trailer places extra load on the engine, transmission, axle, brakes, tires, and suspension. Inspect these components before, during and after towing.

**Load Placement**

To help minimize how trailer movement affects your vehicle when driving:

- Load the heaviest items closest to the trailer floor.
- Load the heaviest items centered between the left and right side trailer tires.
- Load the heaviest items above the trailer axles or just slightly forward toward the trailer tongue. Do not allow the final trailer tongue weight to go above or below 10–15% of the loaded trailer weight.
- Select a tow bar with the correct rise or drop. When both the loaded vehicle and trailer are connected, the trailer frame should be level, or slightly angled down toward your vehicle, when viewed from the side.

When driving with a trailer or payload, a slight takeoff vibration or shudder may be present due to the increased payload weight. You can find more information about proper trailer loading and setting your vehicle up for towing under *Load limit* in the *Load Carrying* chapter.

You can also find information in the *RV and Trailer Towing Guide* available at your authorized dealer.

**TRAILER SWAY CONTROL**

**WARNING:** Turning off trailer sway control increases the risk of loss of vehicle control, serious injury or death. Ford does not recommend disabling this feature except in situations where speed reduction may be detrimental (such as hill climbing), the driver has significant trailer towing experience, and can control trailer sway and maintain safe operation.

**Note:** This feature does not prevent trailer sway, but reduces it once it begins.

**Note:** This feature cannot stop all trailers from swaying.

**Note:** In some cases, if vehicle speed is too high, the system may turn on multiple times, gradually reducing vehicle speed.

This feature applies your vehicle brakes at individual wheels and, if necessary, reduces engine power. If the trailer begins to sway, the stability control light flashes and the message **TRAILER SWAY REDUCE SPEED** appears in the information display. The first thing to do is slow your vehicle down, then pull safely to the side of the road and check for proper tongue load and trailer load distribution. See the *Load Carrying* chapter for specific loading information.

**RECOMMENDED TOWING WEIGHTS**

**Note:** Do not exceed the trailer weight for your vehicle configuration listed in the chart below.

**Note:** Make sure to take into consideration trailer frontal area. Do not exceed:

- 36.5 feet<sup>2</sup> (3.39 meters<sup>2</sup>) trailer frontal area for vehicles equipped with the standard towing package.
- 60.0 feet<sup>2</sup> (5.57 meters<sup>2</sup>) trailer frontal area for vehicles equipped with the optional towing package.

**Note:** Exceeding this limitation may significantly reduce the performance of your towing vehicle. Selecting a trailer with a low aerodynamic drag and rounded front design helps optimize performance and fuel economy.

**Note:** For high altitude operation, reduce the gross combined weight by 2% per 1000 feet (300 meters) starting at the 1000 foot (300 meter) elevation point.

**Note:** Certain states require electric trailer brakes for trailers over a specified weight. Be sure to check state regulations for this specified weight. The maximum trailer weights listed may be limited to this specified weight, as your vehicle's electrical system may not include the wiring connector needed to use electric trailer brakes.

Your vehicle may tow a trailer provided the maximum trailer weight is less than or equal to the maximum trailer weight listed for your vehicle configuration on the following chart.

To calculate the maximum loaded trailer weight for your vehicle:

1. Start with the gross combined weight rating for your vehicle model and axle ratio. See the following chart.
2. Subtract all of the following that apply to your vehicle:
  - Vehicle curb weight
  - Hitch hardware weight, such as a draw bar, ball, locks or weight distributing
  - Driver weight
  - Passenger(s) weight
  - Payload, cargo and luggage weight
  - Aftermarket equipment weight.
3. This equals the maximum loaded trailer weight for this combination.

**Note:** The trailer tongue load figures into the payload for your vehicle. Reduce the total payload by the final trailer tongue weight.

Consult an authorized dealer to determine the maximum trailer weight allowed for your vehicle if you are not sure.

Vehicle type	Towing package	Maximum GCWR
Two-wheel drive (except L)	Standard	12000 lb (5443 kg)
Two-wheel drive L Four-wheel drive (except L)		12300 lb (5579 kg)
Four-wheel drive L		12500 lb (5670 kg)
Two-wheel drive Four-wheel drive	Optional	15000 lb (6804 kg)

**ESSENTIAL TOWING CHECKS**

Follow these guidelines for safe towing:

- Do not tow a trailer until you drive your vehicle at least 1000 miles (1600 kilometers).
- Consult your local motor vehicle laws for towing a trailer.
- See the instructions included with towing accessories for the proper installation and adjustment specifications.
- Service your vehicle more frequently if you tow a trailer. See your scheduled maintenance information.
- If you use a rental trailer, follow the instructions the rental agency gives you.

For load specification terms found on the tire label and Safety Compliance label and for instructions on calculating your vehicle's load, refer to *Load limit* in the *Load Carrying* chapter.

Remember to account for the trailer tongue weight as part of your vehicle load when calculating the total vehicle weight.

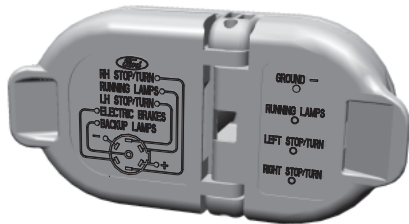
**Trailer Towing Connector (Vehicles with a Trailer Towing Package and 7-Pin Connector)**

When attaching the trailer wiring connector to your vehicle, only use a proper fitting connector that works with the vehicle and trailer functions. If your vehicle has a trailer towing package, it may have a 7-pin connector. Some connectors may have the SAE J2863 logo, which confirms that it is the proper

wiring connector and works correctly with your vehicle.

Color	Function
1. Yellow	Left turn signal and stop lamp
2. White	Ground (-)
3. Blue	Electric brakes
4. Green	Right turn signal and stop lamp
5. Orange	Battery (+)
6. Brown	Running lights
7. Grey	Reverse lights

### Trailer Hitch Cover

Your vehicle is equipped with a removable trailer hitch trim cover. To remove the trim cover:

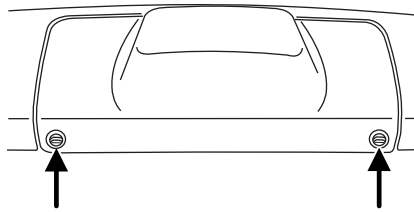

1. Loosen the two quarter-turn fasteners in the bottom of the cover by turning them counterclockwise. Pull the cover downward to remove it. The fasteners remain attached to the cover.

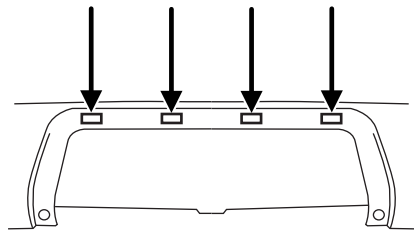

2. To reinstall the cover, insert the four plastic tabs on top of the cover into the corresponding slots, as shown in the illustration and push the cover up into the bumper trim.

3. Hold the cover against the bumper trim and reinstall the two quarter-turn fasteners by turning them clockwise.

### Hitches



**WARNING:** The trailer hitch on this vehicle is part of the vehicle rear crash safety structure. Do not remove the trailer hitch.

Failure to follow this warning could compromise vehicle crash structure and increase the risk of injury in a rear end crash.

Do not use a hitch that clamps onto your vehicle's bumper. Use a load-carrying hitch. You must distribute the load in your trailer so that 10–15% of the total weight of the trailer is on the tongue.

**Integrated Hitch Rating**

**WARNING:** Towing trailers beyond the maximum tongue weight exceeds the limit of the towing system and could result in vehicle structural damage, loss of vehicle control and personal injury.

The standard integrated hitch has two ratings depending on mode of operation:

- Weight-carrying mode requires a draw bar and hitch ball. The draw bar supports all the vertical tongue load of the trailer.
- Weight-distributing mode requires an aftermarket weight-distributing system, which includes draw bar, hitch ball, spring bars and snap-up brackets. This system distributes the vertical tongue load of the trailer between the truck and the trailer.

Mode	Maximum trailer weight - lb. (kg)	Maximum tongue weight - lb. (kg)
Weight-carrying	6000 (2721)	600 (272)
Weight-distributing	9000 (4082)	900 (408)

**Note:** These are hitch ratings only. Actual vehicle ratings are dependent on engine, transmission and axle combinations.

**Weight-distributing Hitch – Vehicles without Automatic Leveling Suspension**

**WARNING:** Do not adjust a weight-distributing hitch to any position where the rear bumper of the vehicle is higher than it was before attaching the trailer. Doing so will defeat the function of the weight-distributing hitch, which may cause unpredictable handling, and could result in serious personal injury.

When hooking-up a trailer using a weight-distributing hitch, always use the following procedure:

1. Park your vehicle, without the trailer, on a level surface.
2. Measure the height of the top of your vehicle's front wheel opening on the fender. This is H1.
3. Attach the trailer to your vehicle without the weight-distributing bars connected.
4. Measure the height of the top of your vehicle's front wheel opening on the fender a second time. This is H2.

5. Install and adjust the tension in the weight distributing bars so that the height of the front fender is approximately halfway between H1 and H2.
6. Check that the trailer is level or slightly nose down toward your vehicle. If not, adjust the ball height accordingly and repeat Steps 2–6.

Once the trailer is level or slightly nose down toward the vehicle:

- Lock the bar tension adjuster in place.
- Check that the trailer tongue securely attaches and locks onto the hitch.
- Install safety chains, lighting, and trailer brake controls as required by law or the trailer manufacturer.

#### ***Weight-distributing Hitch – Vehicles with Automatic Leveling Suspension***



**WARNING:** Do not adjust a weight-distributing hitch to any position where the rear bumper of the vehicle is higher than it was before attaching the trailer. Doing so will defeat the function of the weight-distributing hitch, which may cause unpredictable handling, and could result in serious personal injury.

**Note:** If you do not move the loaded vehicle for approximately 12 hours, the leveling system may bleed down to a lower height. This can be especially apparent if you leave a trailer attached to the parked vehicle for long periods. You must drive your vehicle in order to re-level the suspension.

When connecting a trailer to a vehicle with automatic leveling suspension using a weight-distributing hitch, always use the following procedure:

1. Load the interior of the vehicle to a weight similar to that which you intend to carry when towing. This includes things such as passenger weight and cargo.
2. Drive the vehicle for approximately 2 miles (3 kilometers) to re-level the suspension.
3. Park your vehicle, without the trailer, on a level surface.
4. Measure the height to the top of your vehicle's front wheel opening on the fender. This is H1.
5. Attach the trailer to your vehicle without the weight-distributing bars connected.

6. Make sure you securely attach and lock the trailer tongue to the hitch.
7. Install safety chains, lighting, and trailer brake controls as required by law or the trailer manufacturer.
8. Drive the vehicle and trailer at 20–25 mph (32–40 km/h) for approximately 2 miles (3 kilometers) to re-level the suspension.
9. Park your vehicle and trailer on a level surface.
10. Measure the height to the top of your vehicle's front wheel opening on the fender a second time. This is H2.
11. Install and adjust the tension in the weight distributing bars so that the height of the front fender is approximately halfway between H1 and H2.
12. Check that the trailer is level or slightly nose down toward the vehicle. If it is not, remove the trailer, adjust the ball height accordingly, and repeat Steps 5 -11.

Once the trailer is level or slightly nose down toward the vehicle:

- Lock the bar tension adjuster in place.
- Check that the trailer tongue securely attaches and locks onto the hitch.
- Install safety chains, lighting, and trailer brake controls as required by law or the trailer manufacturer.

### Safety Chains

**Note:** Do not attach safety chains to the bumper.

Always connect the trailer's safety chains to the frame or hook retainers of your vehicle hitch.

To connect the trailer's safety chains, cross the chains under the trailer tongue and allow enough slack for turning tight corners. Do not allow the chains to drag on the ground.

### Trailer Brakes



**WARNING:** Do not connect a trailer's hydraulic brake system directly to your vehicle's brake system. Your vehicle may not have enough braking power and your chances of having a collision greatly increase.

Electric brakes and manual, automatic or surge-type trailer brakes are safe if you install them properly and adjust them to the manufacturer's specifications. The trailer brakes must meet local and federal regulations.

**The rating for the tow vehicle's braking system operation is at the gross vehicle weight rating, not the gross combined weight rating.**

**Separate functioning brake systems are required for safe control of towed vehicles and trailers weighing more than 1500 pounds (680 kilograms) when loaded.**

### Trailer Lamps



**WARNING:** Never connect any trailer lamp wiring to the vehicle's tail lamp wiring; this may damage the electrical system resulting in a fire. Contact an authorized dealer as soon as possible for assistance in proper trailer tow wiring installation. Additional electrical equipment may be required.

Trailer lamps are required on most towed vehicles. Make sure all running lights, brake lights, turn signals and hazard lights are working.

### Before Towing a Trailer

Practice turning, stopping and backing up to get the feel of your vehicle-trailer combination before starting on a trip. When turning, make wider turns so the trailer wheels clear curbs and other obstacles.

### When Towing a Trailer

- Do not drive faster than 70 mph (113 km/h) during the first 500 miles (800 kilometers).
- Do not make full-throttle starts.
- Check your hitch, electrical connections and trailer wheel lug nuts thoroughly after you have traveled 50 miles (80 kilometers).
- When stopped in congested or heavy traffic during hot weather, place the gearshift in position **P** to aid engine and transmission cooling and to help air conditioning performance.
- Turn off the speed control with heavy loads or in hilly terrain. The speed control may turn off automatically when you are towing on long, steep grades.
- Shift to a lower gear when driving down a long or steep hill. Do not apply the brakes continuously, as they may overheat and become less effective.
- If your transmission is equipped with a Grade Assist or Tow/Haul feature, use this feature when towing. This provides engine braking and helps eliminate excessive transmission shifting for optimum fuel economy and transmission cooling.

- If your vehicle is equipped with AdvanceTrac™ with RSC, this system may turn on during typical cornering maneuvers with a heavily loaded trailer. This is normal. Turning the corner at a slower speed while towing may reduce this tendency.
- If you are towing a trailer frequently in hot weather, hilly conditions, at the gross combined weight rating (or any combination of these factors), consider refilling your rear axle with synthetic gear lubricant (if the axle is not already filled with it). See the *Capacities and Specifications* chapter for the lubricant specification.
- Allow more distance for stopping with a trailer attached. Anticipate stops and brake gradually.
- Avoid parking on a grade. However, if you must park on a grade:
  1. Turn the steering wheel to point your vehicle tires away from traffic flow.
  2. Set your vehicle parking brake.
  3. Place the automatic transmission in position **P**.
  4. Place wheel chocks in front and back of the trailer wheels.  
(Chocks not included with vehicle.)

Your vehicle may be equipped with a temporary or conventional spare tire. A “temporary” spare tire is different in size (diameter or width), tread-type (All-Season or All-Terrain) or is from a different manufacturer than the road tires on your vehicle. Consult information on the tire label or Safety Compliance label for limitations when using.

#### **Launching or Retrieving a Boat or Personal Watercraft (PWC)**

**Note:** Disconnect the wiring to the trailer **before** backing the trailer into the water.

**Note:** Reconnect the wiring to the trailer **after** removing the trailer from the water.

When backing down a ramp during boat launching or retrieval:

- Do not allow the static water level to rise above the bottom edge of the rear bumper.
- Do not allow waves to break higher than 6 inches (15 centimeters) above the bottom edge of the rear bumper.

Exceeding these limits may allow water to enter vehicle components:

- Causing internal damage to the components.
- Affecting driveability, emissions, and reliability.

Replace the rear axle lubricant anytime the rear axle submerges in water. Water may have contaminated the rear axle lubricant, which does not normally require checking or changing unless it is leaking or other axle repair is required.

---

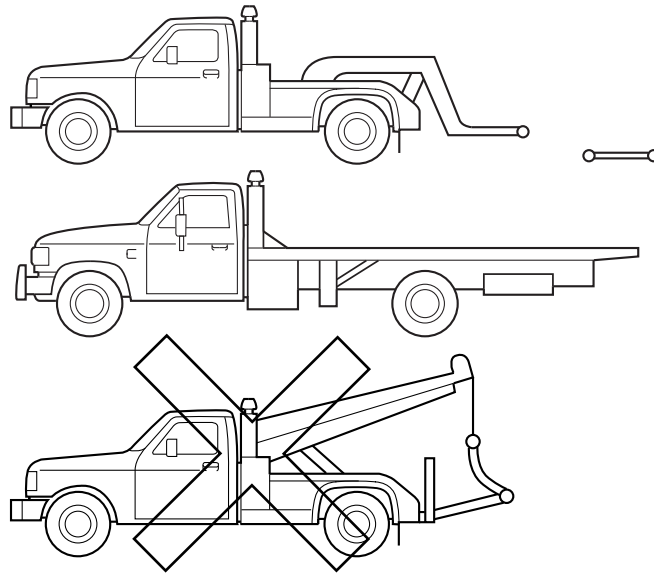
**TRANSPORTING THE VEHICLE**

If you need to have your vehicle towed, contact a professional towing service or, if you are a member of a roadside assistance program, your roadside assistance service provider.

We recommend the use of a wheel lift and dollies or flatbed equipment to tow your vehicle. Do not tow with a slingbelt. Ford Motor Company has not approved a slingbelt towing procedure. Vehicle damage may occur if towed incorrectly, or by any other means.

Ford Motor Company produces a towing manual for all authorized tow truck operators. Have your tow truck operator refer to this manual for proper hook-up and towing procedures for your vehicle.

It is acceptable to have your two-wheel drive vehicle towed with the front wheels on the ground (without dollies) and the rear wheels off the ground.

We recommend towing a four-wheel drive vehicle with all wheels off the ground, such as using a wheel lift and dollies or flatbed equipment.

**TOWING THE VEHICLE ON FOUR WHEELS****Emergency Towing**

If your vehicle becomes inoperable (without access to wheel dollies, car-hauling trailer, or flatbed transport vehicle), it can be flat-towed (all wheels on the ground, regardless of the powertrain and transmission configuration) under the following conditions:

- Your vehicle is facing forward for towing in a forward direction.
- Place the transmission in position **N**. See *Automatic transmission* in the *Transmission* chapter if you cannot move the transmission into **N**.
- Maximum speed is 35 mph (56 km/h).
- Maximum distance is 50 miles (80 kilometers).

**Recreational Towing**

**Note:** Put your climate control system in recirculated air mode to prevent exhaust fumes from entering your vehicle. See the *Climate Control* chapter.

Follow these guidelines if you have a need for recreational towing, such as towing your vehicle behind a motorhome. We designed these guidelines to prevent damage to your transmission.

Do not tow your vehicle with any wheels on the ground as transmission or vehicle damage may occur. It is recommended to tow your vehicle with all four (4) wheels off the ground, such as when using a car-hauling trailer. Otherwise, you cannot tow your vehicle. See an authorized dealer if you must flat-tow a vehicle equipped with the Control Trac® four-wheel drive system.

**BREAKING-IN**

You need to break in new tires for approximately 300 miles (480 kilometers). During this time, your vehicle may exhibit some unique driving characteristics. Avoid driving too fast during the first 1000 miles (1600 kilometers). Vary your speed frequently and change up through the gears early. Do not labor the engine. Do not tow during the first 1000 miles (1600 kilometers).

**ECONOMICAL DRIVING**

Fuel economy is affected by several things, such as how you drive, the conditions you drive under and how you maintain your vehicle.

There are some things to keep in mind that may improve your fuel economy:

- Accelerate and slow down in a smooth, moderate fashion.
- Drive at steady speeds without stopping.
- Anticipate stops; slowing down may eliminate the need to stop.
- Combine errands and minimize stop-and-go driving.
- Close the windows for high-speed driving.
- Drive at reasonable speeds (traveling at 55 mph [88 km/h] uses 15% less fuel than traveling at 65 mph [105 km/h]).
- Keep the tires properly inflated and use only the recommended size.
- Use the recommended engine oil.
- Perform all regularly scheduled maintenance.

There are also some things you may not want to do because they may reduce your fuel economy:

- Sudden or hard accelerations.
- Rev the engine before turning it off.
- Idle for periods longer than one minute.
- Warm up your vehicle on cold mornings.
- Use the air conditioner or front defroster.
- Use the speed control in hilly terrain.
- Rest your foot on the brake pedal while driving.
- Drive a heavily loaded vehicle or tow a trailer.
- Carry unnecessary weight (approximately 1 mpg [0.4 km/L] is lost for every 400 pounds [180 kilograms] of weight carried).
- Add particular accessories to your vehicle (e.g.; bug deflectors, rollbars or light bars, running boards, ski racks).
- Drive with the wheels out of alignment.

**DRIVING THROUGH WATER**

**Note:** Driving through deep water may allow water into the transmission and engine causing internal damage. If you drove through deep water, check the transmission and engine fluid. If water is found, see your authorized dealer immediately for fluid replacement.

Do not drive quickly through standing water, especially if the depth is unknown. Traction or brake capability may be limited and if the ignition system gets wet, your engine may stall. Water may also enter your engine's air intake and severely damage your engine.

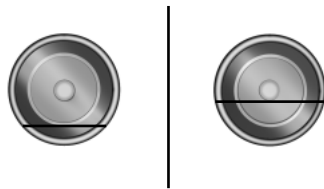

If driving through deep or standing water is unavoidable, proceed very slowly. Never drive through water that is higher than the bottom of the hubs (for trucks) or the bottom of the wheel rims (for cars).

Once through the water, always try the brakes. Wet brakes do not stop the vehicle as effectively as dry brakes. Drying can be improved by moving your vehicle slowly while applying light pressure on the brake pedal.

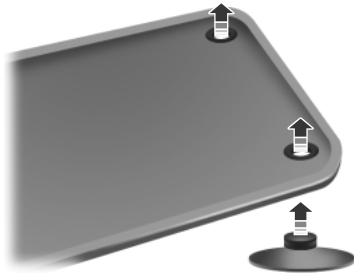
**FLOOR MATS**

**!** **WARNING:** Always use floor mats that are designed to fit the foot well of your vehicle, leaving the pedal area unobstructed, and which can be firmly secured to retention posts so that they cannot slip out of position and interfere with the pedals or impair safe operation of your vehicle in other ways.

- Incorrectly fitted floor mats can cause the accelerator pedal to become stuck in the open position. This can cause loss of vehicle control.
- Always correctly install the floor mats to the retention posts so that they cannot slip out of position or obstruct pedal operation.
- Do not place unsecured floor mats or any other covering in the foot well.
- Do not place additional floor mats or any other covering on top of the original floor mats. This will reduce the pedal clearance and interfere with the pedal operation.
- Do not allow objects to fall or become trapped under the pedals of your vehicle. This can cause loss of vehicle control.
- Carry out regular inspections to make sure the floor mats are secure.

To install the floor mats, position the floor mat eyelet over the retention post and press down to lock in position.

Remove in reverse order.

**ROADSIDE ASSISTANCE****Vehicles Sold in the United States: Getting Roadside Assistance**

To fully assist, if you have a vehicle concern, Ford Motor Company offers a complimentary Roadside Assistance program. This program is separate from the New Vehicle Limited Warranty. The service is available:

- 24 hours a day, seven days a week.
- Throughout the life of the vehicle for original owners.
- For six years or 70000 miles (112655 kilometers) (whichever comes first) within the extended powertrain warranty coverage period for subsequent owners.
- For the coverage period listed on the Roadside Assistance Card included in your Owner's Manual portfolio.

Roadside assistance will cover:

- A flat tire change with a good spare (except vehicles supplied with a temporary mobility kit).
- Battery jump start.
- Lock-out assistance (key replacement cost is the customer's responsibility).
- Fuel delivery – independent service contractors, if not prohibited by state, local or municipal law, shall deliver up to 2.0 gallons (7.5 liters) of gasoline or 5.0 gallons (18.9 liters) of diesel fuel to a disabled vehicle. Fuel delivery service is limited to two no-charge occurrences within a 12-month period.
- Winch out – available within 100 feet (30.5 meters) of a paved or county maintained road, no recoveries.
- Towing – Lincoln eligible vehicles to the client's selling or preferred dealer within 100 miles (161 kilometers) of the disablement location or to the nearest Lincoln dealer. If a client requests a tow to a selling or preferred dealer that is more than 100 miles (161 kilometers) from the disablement location, the client shall be responsible for any mileage costs in excess of 100 miles (161 kilometers).

Roadside Assistance will include up to \$200 coverage for a towed trailer if the disabled eligible vehicle requires service at the nearest authorized dealer. If the towing vehicle is operational but the trailer is not, then the trailer does not qualify for any roadside services.

**Vehicles sold in the United States: Using roadside assistance**

United States Lincoln vehicle clients who require Roadside Assistance, call 1-800-521-4140. If you need to arrange roadside assistance for yourself, Ford Motor Company will reimburse a reasonable amount for towing to the nearest Lincoln dealership within 100 miles (161 kilometers). To obtain reimbursement information, United States Lincoln vehicle clients, call 1-800-521-4140. Clients will be asked to submit their original receipts.

**Vehicles Sold in Canada: Getting Roadside Assistance**

Canadian clients who require roadside assistance, call 1-800-387-9333.

**Vehicles Sold in Canada: Using Roadside Assistance**

For your convenience, you may complete the roadside assistance identification card found in the centerfold of this warranty guide and retain for future reference.

Canadian roadside coverage and benefits may differ from the U.S. coverage. If you require more information, please refer to the coverage section of your warranty guide, call us in Canada at 1-800-387-9333 or visit our website at [www.lincolncanada.com](http://www.lincolncanada.com).

**HAZARD WARNING FLASHERS**

The hazard flasher control is located on the instrument panel by the radio. Use it when your vehicle is disabled and is creating a safety hazard for other motorists.

- Press the flasher control and all front and rear direction signals will flash.
- Press the flasher control again to turn them off.

**Note:** With extended use, the flashers may run down your 12-volt battery.

**FUEL PUMP SHUT-OFF SWITCH**

The fuel pump shut-off switch is a device intended to stop the electric fuel pump when your vehicle has been involved in a substantial jolt.

After a collision, if the engine cranks but does not start, the fuel pump shut-off switch may have been activated.



**WARNING:** Failure to inspect and, if necessary, repair fuel leaks after a collision may increase the risk of fire and serious injury.

Ford Motor Company recommends that the fuel system be inspected by an authorized dealer after any collision.

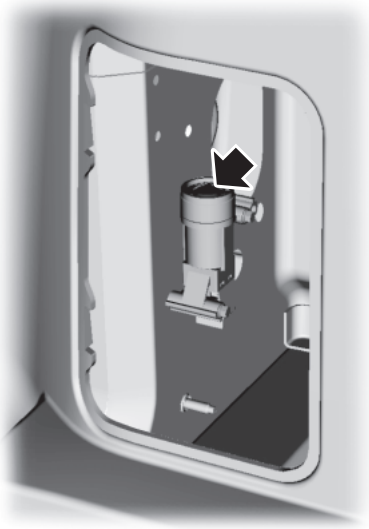

The fuel pump shut-off switch is located behind an access panel in the left rear quarter trim panel, near the liftgate.

The fuel pump shut-off switch has a red reset button on top of it.

If your vehicle is equipped with a power liftgate, the fuel pump shut-off switch is left of the power liftgate motor.

Use the following procedure to reset the fuel pump shut-off switch.

1. Turn the ignition to the off position.
2. Check the fuel system for leaks.
3. If you cannot see a fuel leak, reset the fuel pump shut-off switch by pushing the red reset button in.
4. Turn the ignition to the on position. Pause for a few seconds and return the key to the off position.
5. Check again for fuel system leaks.

**JUMP-STARTING THE VEHICLE**

**WARNING:** The gases around the battery can explode if exposed to flames, sparks, or lit cigarettes. An explosion could result in injury or vehicle damage.



**WARNING:** Batteries contain sulfuric acid which can burn skin, eyes and clothing, if contacted.

Do not attempt to push-start your automatic transmission vehicle. Automatic transmissions do not have push-start capability. Attempting to push-start a vehicle with an automatic transmission may cause transmission damage.

When the battery is disconnected or a new battery is installed, the automatic transmission must relearn its shift strategy. As a result, the transmission may exhibit a combination of firm and soft shifts. This operation is considered normal and will not affect function or durability of the transmission. Over time, the adaptive learning process will fully update transmission operation.

**Preparing Your Vehicle**

**Note:** Use only a 12-volt supply to start your vehicle.

**Note:** Do not disconnect the battery of the disabled vehicle as this could damage the vehicle's electrical system.

1. Park the booster vehicle close to the hood of the disabled vehicle making sure the two vehicles do not touch. Set the parking brake on both vehicles and stay clear of the engine cooling fan and other moving parts.
2. Check all battery terminals. Remove the positive terminal cover (if equipped) and any excessive corrosion before you attach the battery cables. Ensure that vent caps are tight and level.
3. Turn the heater fan on in both vehicles to protect from any electrical surges. Turn all other accessories off.

### Connecting the Jumper Cables



**WARNING:** Do not connect the end of the second cable to the negative (-) terminal of the battery to be jumped. A spark may cause an explosion of the gases that surround the battery.

**Note:** Do not attach the negative (-) cable to fuel lines, engine rocker covers, the intake manifold or electrical components as grounding points.

**Note:** In the illustration, the vehicle on the bottom is used to designate the assisting (boosting) battery.

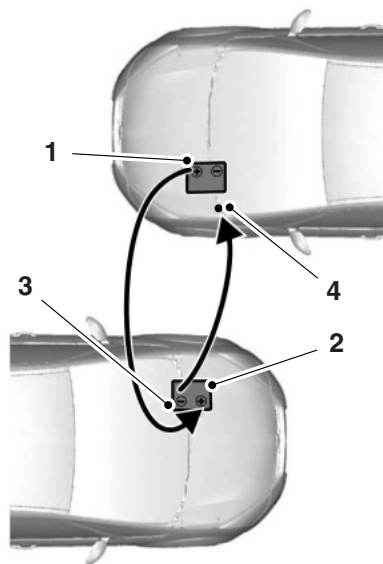

1. Connect the positive (+) jumper cable to the positive (+) terminal of the discharged battery.

2. Connect the other end of the positive (+) cable to the positive (+) terminal of the assisting battery.

3. Connect the negative (-) cable to the negative (-) terminal of the assisting battery.

4. Make the final connection of the negative (-) cable to an exposed metal part of the stalled vehicle's engine, away from the battery and the carburetor or fuel injection system.

Ensure that the cables are clear of fan blades, belts, moving parts of both engines, or any fuel delivery system parts.

### Jump Starting

1. Start the engine of the booster vehicle and run the engine at a moderately increased speed.
2. Start the engine of the disabled vehicle.
3. Once the disabled vehicle has been started, run both engines for an additional three minutes before disconnecting the jumper cables.

### Removing the Jumper Cables

**Note:** In the illustration, the vehicle on the bottom is used to designate the assisting (boosting) battery.

Remove the jumper cables in the reverse order that they were connected.

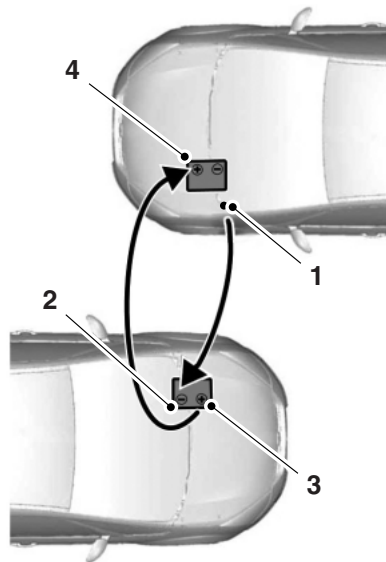

1. Remove the jumper cable from the ground metal surface.
2. Remove the jumper cable on the negative (-) terminal of the booster vehicle's battery.
3. Remove the jumper cable from the positive (+) terminal of the booster vehicle's battery.
4. Remove the jumper cable from the positive (+) terminal of the disabled vehicle's battery.

After the disabled vehicle has been started and the jumper cables removed, allow it to idle for several minutes so the engine computer can relearn its idle conditions.

**GETTING THE SERVICES YOU NEED**

Warranty repairs to your vehicle must be performed by an authorized dealer. While any authorized dealer handling your vehicle line will provide warranty service, we recommend you return to your selling authorized dealer who wants to ensure your continued satisfaction.

Please note that certain warranty repairs require special training, equipment or both, so not all authorized dealers are authorized to perform all warranty repairs. This means that, depending on the warranty repair needed, you may have to take your vehicle to another authorized dealer.

A reasonable time must be allowed to perform a repair after taking your vehicle to the authorized dealer. Repairs will be made using Ford or Motorcraft parts, or remanufactured or other parts that are authorized by Ford.

**Away from home**

If you are away from home when your vehicle needs service, contact the Ford Customer Relationship Center or use the online resources listed below to find the nearest authorized dealer.

In the United States:

**Mailing address**

Ford Motor Company  
Customer Relationship Center  
P.O. Box 6248  
Dearborn, MI 48121

**Telephone**

1-800-521-4140  
(TDD for the hearing impaired: 1-800-232-5952)

**Online**

Additional information and resources are available online at [www.lincolnowner.com](http://www.lincolnowner.com)

- U.S. dealer locator by Dealer Name, City/State, or Zip Code
- Owner Guides
- Maintenance Schedules
- Recalls
- Ford Extended Service Plans
- Ford Genuine Accessories
- Service specials and promotions.

In Canada:

**Mailing address**

Lincoln Customer Relationship Centre  
Ford Motor Company of Canada, Limited  
P.O. Box 2000  
Oakville, Ontario L6K 1C8

**Telephone**

1-800-387-9333

**Online**

[www.lincolncanada.com](http://www.lincolncanada.com)

**Additional assistance**

If you have questions or concerns, or are unsatisfied with the service you are receiving, follow these steps:

1. Contact your Sales Representative or Service Advisor at your selling/servicing authorized dealer.
2. If your inquiry or concern remains unresolved, contact the Sales Manager, Service Manager or Customer Relations Manager.
3. If you require assistance or clarification on Ford Motor Company policies, please contact the Ford Customer Relationship Center

In order to help you serve you better, please have the following information available when contacting a Customer Relationship Center:

- Vehicle Identification Number (VIN)
- Your telephone number (home and business)
- The name of the authorized dealer and city where located
- The vehicle's current odometer reading

In some states, you must directly notify Ford in writing before pursuing remedies under your state's warranty laws. Ford is also allowed a final repair attempt in some states.

In the United States, a warranty dispute must be submitted to the BBB AUTO LINE before taking action under the Magnuson-Moss Warranty Act, or to the extent allowed by state law, before pursuing replacement or repurchase remedies provided by certain state laws. This dispute handling procedure is not required prior to enforcing state created rights or other rights which are independent of the Magnuson-Moss Warranty Act or state replacement or repurchase laws.

**IN CALIFORNIA (U.S. ONLY)**

California Civil Code Section 1793.2(d) requires that, if a manufacturer or its representative is unable to repair a motor vehicle to conform to the vehicle's applicable express warranty after a reasonable number of attempts, the manufacturer shall be required to either replace the vehicle with one substantially identical or repurchase the vehicle and reimburse the buyer in an amount equal to the actual price paid or payable by the consumer (less a reasonable allowance for consumer use). The consumer has the right to choose whether to receive a refund or replacement vehicle.

California Civil Code Section 1793.22(b) presumes that the manufacturer has had a reasonable number of attempts to conform the vehicle to its applicable express warranties if, within the first 18 months of ownership of a new vehicle or the first 18000 mi (29 000 km), whichever occurs first:

1. Two or more repair attempts are made on the same nonconformity likely to cause death or serious bodily injury OR
2. Four or more repair attempts are made on the same nonconformity (a defect or condition that substantially impairs the use, value or safety of the vehicle) OR
3. The vehicle is out of service for repair of nonconformities for a total of more than 30 calendar days (not necessarily all at one time).

In the case of 1 or 2 above, the consumer must also notify the manufacturer of the need for the repair of the nonconformity at the following address:

Ford Motor Company  
16800 Executive Plaza Drive  
Mail Drop 3NE-B  
Dearborn, MI 48126

You are required to submit your warranty dispute to BBB AUTO LINE before asserting in court any rights or remedies conferred by California Civil Code Section 1793.22(b). You are also required to use BBB AUTO LINE before exercising rights or seeking remedies created by the Federal Magnuson-Moss Warranty Act, 15 U.S.C. sec. 2301 et seq. If you choose to seek redress by pursuing rights and remedies not created by California Civil Code Section 1793.22(b) or the Magnuson-Moss Warranty Act, resorting to BBB AUTO LINE is not required by those statutes.

**THE BETTER BUSINESS BUREAU (BBB) AUTO LINE PROGRAM  
(U.S. ONLY)**

Your satisfaction is important to Ford Motor Company and to your dealer. If a warranty concern has not been resolved using the three-step procedure outlined earlier in this chapter in the *Getting the Services You Need* section, you may be eligible to participate in the BBB AUTO LINE program.

The BBB AUTO LINE program consists of two parts – mediation and arbitration. During mediation, a representative of the BBB will contact both you and Ford Motor Company to explore options for settlement of the claim. If an agreement is not reached during mediation or you do not want to participate in mediation, and if your claim is eligible, you may participate in the arbitration process. An arbitration hearing will be scheduled so that you can present your case in an informal setting before an impartial person. The arbitrator will consider the testimony provided and make a decision after the hearing.

Disputes submitted to the BBB AUTO LINE program are usually decided within 40 days after you file your claim with the BBB. You are not bound by the decision, and may reject the decision and proceed to court where all findings of the BBB Auto Line dispute, and decision, are admissible in the court action. Should you choose to accept the BBB AUTO LINE decision, Ford is then bound by the decision, and must comply with the decision within 30 days of receipt of your acceptance letter.

BBB AUTO LINE Application: Using the information provided below, please call or write to request a program application. You will be asked for your name and address, general information about your new vehicle, information about your warranty concerns, and any steps you have already taken to try to resolve them. A Customer Claim Form will be mailed that will need to be completed, signed and returned to the BBB along with proof of ownership. Upon receipt, the BBB will review the claim for eligibility under the Program Summary Guidelines.

**You can get more information by calling BBB AUTO LINE at 1-800-955-5100, or writing to:**

**BBB AUTO LINE  
3033 Wilson Boulevard, Suite 600  
Arlington, Virginia 22201**

BBB AUTO LINE applications can also be requested by calling the Ford Motor Company Customer Relationship Center at 1-800-392-3673.

**Note:** Ford Motor Company reserves the right to change eligibility limitations, modify procedures, or to discontinue this process at any time without notice and without obligation.

**UTILIZING THE MEDIATION or ARBITRATION PROGRAM  
(CANADA ONLY)**

This pertains to vehicles delivered to authorized Canadian dealers. In those cases, where you continue to feel that the efforts by Ford of Canada and the authorized dealer to resolve a factory-related vehicle service concern have been unsatisfactory, Ford of Canada participates in an impartial third party mediation or arbitration program administered by the Canadian Motor Vehicle Arbitration Plan (CAMVAP).

The CAMVAP program is a straightforward and relatively speedy alternative to resolve a disagreement when all other efforts to produce a settlement have failed. This procedure is without cost to you and is designed to eliminate the need for lengthy and expensive legal proceedings.

In the CAMVAP program, impartial third-party arbitrators conduct hearings at mutually convenient times and places in an informal environment. These impartial arbitrators review the positions of the parties, make decisions and, when appropriate, render awards to resolve disputes. CAMVAP decisions are fast, fair, and final as the arbitrator's award is binding on both you and Ford of Canada.

CAMVAP services are available in all Canadian territories and provinces. For more information, without charge or obligation, call your CAMVAP Provincial Administrator directly at 1-800-207-0685 or visit [www.camvap.ca](http://www.camvap.ca).

**GETTING ASSISTANCE OUTSIDE THE U.S. AND CANADA**

Before exporting your vehicle to a foreign country, contact the appropriate foreign embassy or consulate. These officials can inform you of local vehicle registration regulations and where to find unleaded fuel.

If you cannot find unleaded fuel or can only get fuel with an anti-knock index lower than is recommended for your vehicle, contact our Customer Relationship Center.

The use of leaded fuel in your vehicle without proper conversion may damage the effectiveness of your emission control system and may cause engine knocking or serious engine damage. Ford Motor Company or Ford of Canada is not responsible for any damage caused by use of improper fuel. Using leaded fuel may also result in difficulty importing your vehicle back into the United States.

**If your vehicle must be serviced while you are traveling or living in Asia-Pacific Region, Sub-Saharan Africa, U.S. Virgin Islands, Central America, the Caribbean, and Israel, contact the nearest authorized dealer. If the authorized dealer cannot help you, contact:**

**FORD MOTOR COMPANY**  
Customer Relationship Center  
1555 Fairlane Drive  
Fairlane Business Park #3  
Allen Park, Michigan 48101  
U.S.A.  
Telephone: (313) 594-4857  
FAX: (313) 390-0804  
Email: expcac@ford.com

**For customers in Guam, the Commonwealth of the Northern Mariana Islands (CNMI), American Samoa, and the U.S. Virgin Islands, please feel free to call our Toll-Free Number:**  
(800) 841-FORD (3673)

**If your vehicle must be serviced while you are traveling or living in Puerto Rico, contact the nearest authorized dealer. If the authorized dealer cannot help you, contact:**

**FORD MOTOR COMPANY**  
Customer Relationship Center  
1555 Fairlane Drive  
Fairlane Business Park #3  
Allen Park, Michigan 48101  
Telephone: (800) 841-FORD (3673)  
FAX: (313) 390-0804  
Email: prcac@ford.com  
www.ford.com.pr

**If your vehicle must be serviced while you are traveling or living in the Middle East, contact the nearest authorized dealer. If the authorized dealer cannot help you, contact:**

**FORD MOTOR COMPANY**

Customer Relationship Center

1555 Fairlane Drive

Fairlane Business Park #3

Allen Park, Michigan 48101

Telephone: +971 4 3326084

Toll-Free Number of the Kingdom of Saudi Arabia: 800 8971409

Local Telephone Number of Kuwait: 24810575

FAX: +971 4 3327299

Email: [menacac@ford.com](mailto:menacac@ford.com)

[www.me.ford.com](http://www.me.ford.com)

If you buy your vehicle in North America and then relocate to any of the above locations, register your vehicle identification number (VIN) and new address with Ford Motor Company Export Operations & Global Growth Initiatives by emailing [expcac@ford.com](mailto:expcac@ford.com).

**If you are in another foreign country, contact the nearest authorized dealer. In the event your inquiry is unresolved, communicate your concern with the dealership's Sales Manager, Service Manager or Customer Relations Manager. If you require additional assistance or clarification, please contact the respective Customer Relationship Center as previously listed.**

**Customers in the U.S. should call 1-800-392-3673.**

**ORDERING ADDITIONAL OWNER'S LITERATURE**

To order the publications in this portfolio, contact Helm, Incorporated at:

HELM, INCORPORATED

47911 Halyard Drive

Plymouth, Michigan 48170

Attention: Customer Service

Or to order a free publication catalog, call toll free: 1-800-782-4356

Monday-Friday 8:00 a.m. - 6:00 p.m. EST

Helm, Incorporated can also be reached by their website:

[www.helminc.com](http://www.helminc.com).

*(Items in this catalog may be purchased by credit card, check or money order.)*

**Obtaining a French Owner's Manual**

A French owner's manual can be obtained from your authorized dealer or by contacting Helm, Incorporated using the contact information listed previously in this section.

**REPORTING SAFETY DEFECTS (U.S. ONLY)**

If you believe that your vehicle has a defect which could cause a crash or could cause injury or death, you should immediately inform the National Highway Traffic Safety

Administration (NHTSA) in addition to notifying Ford Motor Company.

If NHTSA receives similar complaints, it may open an investigation, and if it finds that a safety defect exists in a group of vehicles, it may order a recall and remedy campaign. However, NHTSA cannot become involved in individual problems between you, your dealer, or Ford Motor Company.

To contact NHTSA, you may call the Vehicle Safety Hotline toll-free at 1-888-327-4236 (TTY: 1-800-424-9153); go to <http://www.safercar.gov>; or write to:

Administrator  
1200 New Jersey Avenue, Southeast  
Washington, D.C. 20590

You can also obtain other information about motor vehicle safety from <http://www.safercar.gov>.

**REPORTING SAFETY DEFECTS (CANADA ONLY)**

If you believe that your vehicle has a defect which could cause a crash or could cause injury or death, you should immediately inform Transport Canada, using their toll-free number: 1-800-333-0510, or online at: <http://www.tc.gc.ca/eng/roadsafety/menu.htm>

**CHANGING A FUSE****Fuses**

**WARNING:** Always replace a fuse with one that has the specified amperage rating. Using a fuse with a higher amperage rating can cause severe wire damage and could start a fire.

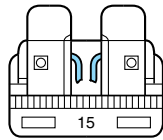

If electrical components in your vehicle are not working, a fuse may have blown. Blown fuses are identified by a broken wire within the fuse. Check the appropriate fuses before replacing any electrical components.

**Standard Fuse Amperage Rating and Color**

COLOR					
Fuse rating	Mini fuses	Standard fuses	Maxi fuses	Cartridge maxi fuses	Fuse link cartridge
2A	Grey	Grey	—	—	—
3A	Violet	Violet	—	—	—
4A	Pink	Pink	—	—	—
5A	Tan	Tan	—	—	—
7.5A	Brown	Brown	—	—	—
10A	Red	Red	—	—	—
15A	Blue	Blue	—	—	—
20A	Yellow	Yellow	Yellow	Blue	Blue
25A	Natural	Natural	—	Natural	Natural
30A	Green	Green	Green	Pink	Pink
40A	—	—	Orange	Green	Green
50A	—	—	Red	Red	Red
60A	—	—	Blue	Yellow	Yellow
70A	—	—	Tan	—	Brown
80A	—	—	Natural	Black	Black

**FUSE SPECIFICATION CHART**

**Power Distribution Box**



**WARNING:** Always disconnect the battery before servicing high current fuses.



**WARNING:** To reduce risk of electrical shock, always replace the cover to the power distribution box before reconnecting the battery or refilling fluid reservoirs.

The power distribution box is located in the engine compartment. It has high-current fuses that protect your vehicle's main electrical systems from overloads.

If the battery has been disconnected and reconnected, see *Changing the Vehicle Battery* in the *Maintenance* chapter.

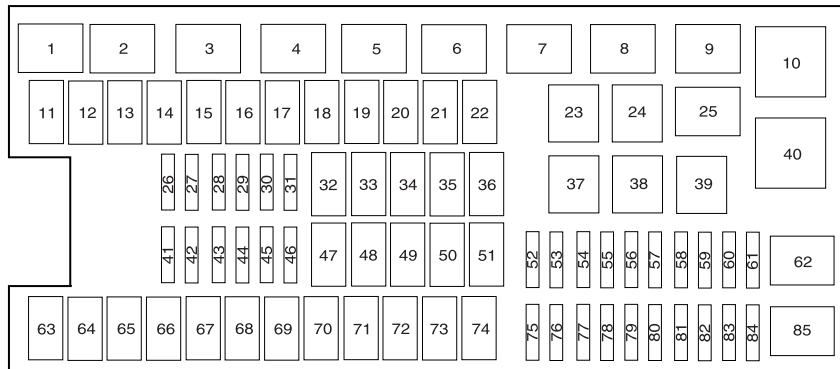

The high-current fuses are coded as follows:

Fuse or relay location	Fuse amp rating	Protected circuits
1	—	Powertrain control module relay
2	—	Starter relay
3	—	Blower motor relay

Fuse or relay location	Fuse amp rating	Protected circuits
4	—	Trailer tow battery charge relay
5	—	Fuel pump relay
6	—	Electronic fan 1 relay
7	—	Rear window defroster, heated mirror relay
8	—	Electronic fan 3 relay
9	—	Run/start relay
10	—	Not used
11	40A**	Power running boards
12	40A**	Run/start relay
13	30A **	Starter relay
14	40A**	Electronic fan
15	20A**	Right hand high intensity discharge headlamp relay
16	40A**	Electronic fan
17	20A**	Right hand high intensity discharge headlamp relay
18	30A**	Trailer brake
19	—	Not used
20	—	Not used
21	30A**	Trailer tow battery charge relay
22	30A**	Passenger power seat
23	—	Air conditioner clutch relay
24	—	Trailer tow park lamp relay
25	—	Right hand high intensity discharge headlamp relay
26	—	Not used
27	20A*	4x4
28	25A*	Trailer tow park lamp relay
29	20A*	Backup lamps, Integrated wheel end solenoid
30	10A*	Air conditioner clutch relay

Fuse or relay location	Fuse amp rating	Protected circuits
31	—	Not used
32	40A**	Blower motor relay
33	40A**	110-volt AC power point
34	30A**	Auxiliary blower motor
35	30A**	Powertrain control module relay
36	30A**	Power liftgate
37	—	Trailer tow left hand stop/turn relay
38	—	Trailer tow right hand stop/ turn relay
39	—	Backup lamps relay
40	—	Electronic fan 2 relay
41	10A*	Powertrain control module keep-alive power
42	—	Not used
43	5A*	Brake on/off switch
44	20A*	Fuel pump relay
45	25A*	Trailer tow stop/turn lamps relay
46	—	Not used
47	—	Not used
48	—	Not used
49	—	Not used
50	30A**	Front wiper motor relay
51	40A**	Rear window defroster and heated mirror relay
52	10A*	Anti-lock brake system run/start feed
53	—	Not used
54	—	Not used
55	5A*	Fuel pump relay coil run/start feed

Fuse or relay location	Fuse amp rating	Protected circuits
56	30A*	Passenger compartment fuse panel run/start feed
57	10A*	Blower motor relay coil
58	15A*	Trailer tow backup lamps
59	15A*	Heated mirrors
60	—	Not used
61	—	Fuel pump diode
62	—	Left high intensity discharge headlamp relay
63	25A**	Electronic fan
64	30A**	Moonroof
65	20A**	Auxiliary power point (instrument panel)
66	20A**	Auxiliary power point (rear of center console)
67	40A**	Front row climate controlled seats
68	60A**	Anti-lock brake system valves
69	60A**	Anti-lock brake system pump
70	30A**	Third row power fold seat
71	20A**	Auxiliary power point/cigar lighter
72	20A**	Auxiliary power point (right rear quarter panel)
73	—	Not used
74	30A**	Driver power seat
75	20A*	Vehicle power 1 – powertrain control module
76	20A*	Vehicle power 2 – powertrain control module
77	15A*	Vehicle power 4 – ignition coils

Fuse or relay location	Fuse amp rating	Protected circuits
78	—	Not used
79	20A*	Vehicle power 3 – powertrain control module
80	—	Not used
81	—	Not used
82	—	Not used
83	—	Not used
84	—	Not used
85	—	Wiper motor relay

\* Mini Fuses \*\* Cartridge Fuses

### Passenger Compartment Fuse Panel

The fuse panel is located under the right-hand side of the instrument panel.

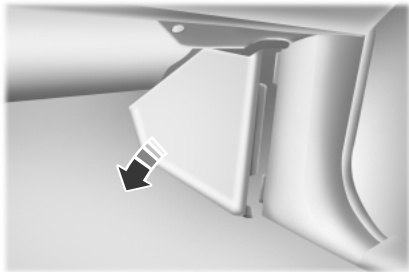

To remove the trim panel for access to the fuse box, pull the panel toward you and swing it out away from the side and remove it.

To reinstall it, line up the tabs with the grooves on the panel, then push it shut.

To remove the fuse box cover, press in the tabs on both sides of the cover, then pull the cover off.

To reinstall the fuse box cover, place the top part of the cover on the fuse panel, then push the bottom part of the cover until you hear it click shut. Gently pull on the cover to make sure it is seated properly.

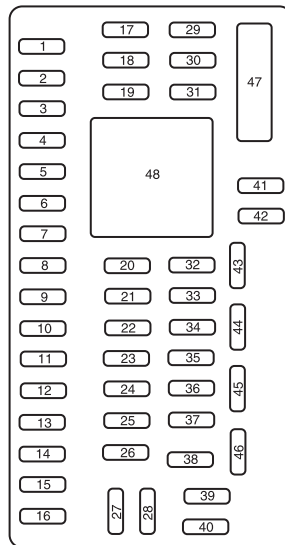

The fuses are coded as follows:

Fuse or relay location	Fuse amp rating	Protective circuits
1	30A	Driver window
2	15A	Driver side memory module
3	15A	Audio rear seat controls, Satellite radio, SYNC
4	30A	Passenger window
5	10A	Keypad illumination, 3rd row seat enable, Brake-shift interlock, Smart fuse panel logic power
6	20A	Turn signals
7	10A	Low beam headlamps (left)
8	10A	Low beam headlamps (right)

Fuse or relay location	Fuse amp rating	Protective circuits
9	15A	Interior lights
10	15A	Switch backlighting, Puddle lamps
11	10A	Not used (spare)
12	7.5A	Power mirrors, Driver seat memory switch
13	5A	Not used (spare)
14	10A	Power liftgate module – keep-alive power, Clock
15	10A	Climate control, Global positioning satellite module
16	15A	Not used (spare)
17	20A	Door locks, Liftgate release, Liftglass release
18	20A	Second row heated seats
19	25A	Rear wiper
20	15A	Adjustable pedals, Datalink
21	15A	Fog lamps
22	15A	Park lamps
23	15A	High beam headlamps
24	20A	Horn
25	10A	Demand lamps, Glove box, Visor
26	10A	Instrument panel cluster
27	20A	Ignition switch
28	5A	Radio
29	5A	Instrument panel cluster
30	5A	Not used (spare)
31	10A	Not used (spare)
32	10A	Airbag module
33	10A	Not used (spare)
34	5A	Not used (spare)

Fuse or relay location	Fuse amp rating	Protective circuits
35	10A	Rear park assist, 4x4, Rear video camera, 2nd row heated seats
36	5A	Passive anti-theft system
37	10A	Climate control
38	20A	Subwoofer, THX amplifier
39	20A	Radio
40	20A	THX amplifier
41	15A	Power windows, Power vents, Power moonroof, Auto dimming rear view mirror, 110-volt AC power point
42	10A	Not used (spare)
43	10A	Rear wiper logic, Rain sensor
44	10A	Trailer tow battery charge relay coil
45	5A	Front wiper logic
46	7.5A	Climate control, Auxiliary relay control
47	30A Circuit Breaker	Power windows, Moonroof
48	—	Delayed accessory relay

**GENERAL INFORMATION**

**WARNING:** Turn off the power running boards, if equipped, before working under the vehicle, jacking or placing any object under the vehicle. Never place your hand between the extended running board and the vehicle. A moving running board may cause injury.

Have your vehicle serviced regularly to help maintain its roadworthiness and resale value. There is a large network of Ford authorized dealers that are there to help you with their professional servicing expertise. We believe that their specially trained technicians are best qualified to service your vehicle properly and expertly. They are supported by a wide range of highly specialized tools developed specifically for servicing your vehicle.

To help you service your vehicle, we provide *scheduled maintenance information* which makes tracking routine service easy.

If your vehicle requires professional service, your authorized dealer can provide the necessary parts and service. Check your warranty information to find out which parts and services are covered.

Use only recommended fuels, lubricants, fluids and service parts conforming to specifications. Motorcraft® parts are designed and built to provide the best performance in your vehicle.

**Precautions**

- Do not work on a hot engine.
- Make sure that nothing gets caught in moving parts.
- Do not work on a vehicle with the engine running in an enclosed space, unless you are sure you have enough ventilation.
- Keep all open flames and other burning material (such as cigarettes) away from the battery and all fuel related parts.

**Working with the Engine Off**

1. Set the parking brake and shift to **P** (Park).
2. Turn off the engine and remove the key (if equipped).
3. Block the wheels.

**Working with the Engine On**

**WARNING:** To reduce the risk of vehicle damage or personal burn injuries, do not start your engine with the air cleaner removed and do not remove it while the engine is running.

1. Set the parking brake and shift to position **P** (Park).
2. Block the wheels.

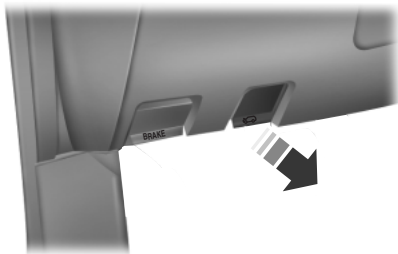
**OPENING AND CLOSING THE HOOD**

1. Inside the vehicle, pull the hood release handle located under the bottom of the instrument panel.
2. Go to the front of the vehicle and release the auxiliary latch that is located under the front center of the hood.
3. Lift the hood until the lift cylinders hold it open.

---

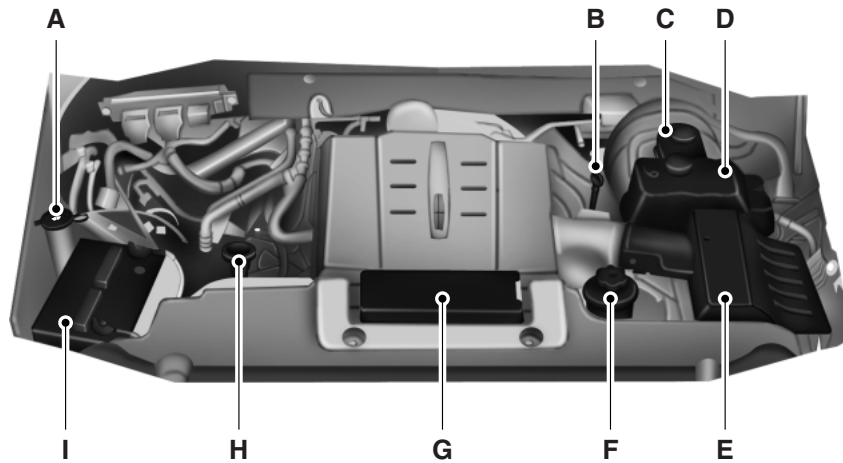
**UNDER HOOD OVERVIEW****5.4L V8**

- A. Windshield washer fluid reservoir
- B. Engine oil dipstick
- C. Brake fluid reservoir
- D. Engine coolant reservoir
- E. Air filter assembly
- F. Power steering fluid reservoir
- G. Power distribution box
- H. Engine oil filler cap
- I. Battery

**ENGINE OIL DIPSTICK**

A. – MIN

B. – MAX

**ENGINE OIL CHECK**

Refer to the *scheduled maintenance information* for the appropriate intervals for checking the engine oil.

1. Make sure the vehicle is on level ground.
2. Turn the engine off and wait 15 minutes for the oil to drain into the oil pan.
3. Set the parking brake and ensure the gearshift is securely latched in P (Park).
4. Open the hood. Protect yourself from engine heat.
5. Locate and carefully remove the engine oil level dipstick. See the *Under Hood Overview* in this chapter for location of dipstick.
6. Wipe the dipstick clean. Insert the dipstick fully, then remove it again.

If the oil level is between the lower and upper holes or between the MIN and MAX marks (depending on application), the oil level is acceptable. **DO NOT ADD OIL.**

If the oil level is below the lower hole or the MIN mark, add enough oil to raise the level within the lower and upper holes or within the MIN-MAX range.

Oil levels above the upper hole or the MAX mark may cause engine damage. Some oil must be removed from the engine by an authorized dealer.

7. Put the dipstick back in and ensure it is fully seated.

### Adding Engine Oil

**Note:** Do not remove the engine oil level dipstick or the filler cap when the engine is running.

**Note:** Do not add engine oil further than the MAX mark. Oil levels above the MAX mark may cause engine damage.



Only use oils certified for gasoline engines by the American Petroleum Institute (API). An oil with this trademark symbol conforms to the current engine and emission system protection standards and fuel economy requirements of the International Lubricants Specification Advisory Council (ILSAC), comprised of U.S. and Japanese automobile manufacturers.

1. Check the engine oil level.
2. If the engine oil level is not within the normal range, add engine oil that meets Ford specifications. See *Capacities and Specifications* for more information. Remove the engine oil filler cap and use a funnel to pour the engine oil into the opening.
3. Recheck the engine oil level. Make sure the oil level is not above the normal operating range on the engine oil level dipstick.
4. Install the dipstick and ensure it is fully seated.
5. Fully install the engine oil filler cap by turning the filler cap clockwise until three clicks are heard or until the cap is fully seated.

### ENGINE COOLANT CHECK

#### Checking the Engine Coolant

When the engine is cold, check the concentration and level of the engine coolant at the intervals listed in the *Scheduled Maintenance Information*.

**Note:** Make sure that the level is between the MIN and MAX marks on the coolant reservoir.

**Note:** Coolant expands when it is hot. The level may extend beyond the MAX mark.

**Note:** If the level is at the MIN mark, below the MIN mark, or empty, add coolant immediately. See *Adding Engine Coolant* in this chapter.

The coolant concentration should be maintained within 48% to 50%, which equates to a freeze point between -30°F (-34°C) and -34°F (-37°C).

**Note:** For best results, coolant concentration should be tested with a refractometer such as Rotunda tool 300-ROB75240 available from your dealer. Ford does not recommend the use of hydrometers or coolant test strips for measuring coolant concentrations.

**Note:** Automotive fluids are not interchangeable; do not use engine coolant/antifreeze or windshield washer fluid outside of its specified function and vehicle location.

### Adding Engine Coolant



**WARNING:** Do not add engine coolant when the engine is hot.

Steam and scalding liquids released from a hot cooling system can burn you badly. Also, you can be burned if you spill coolant on hot engine parts.



**WARNING:** Do not put engine coolant in the windshield washer

fluid container. If sprayed on the windshield, engine coolant could make it difficult to see through the windshield.



**WARNING:** To reduce the risk of personal injury, make sure the engine is cool before unscrewing the coolant pressure relief cap.

The cooling system is under pressure; steam and hot liquid can come out forcefully when the cap is loosened slightly.



**WARNING:** Do not add coolant further than the MAX mark.

**Note:** Do not use stop leak pellets, cooling system sealants or additives as they can cause damage to the engine cooling or heating systems. This damage would not be covered under your vehicle's warranty.

**Note:** During normal vehicle operation, the engine coolant may change color from orange to pink or light red. As long as the engine coolant is clear and uncontaminated, this color change does not indicate the engine coolant has degraded nor does it require the engine coolant to be drained, the system to be flushed, or the engine coolant to be replaced.

- DO NOT MIX different colors or types of coolant in your vehicle. Make sure the correct coolant is used. Mixing of engine coolants may harm your engine's cooling system. The use of an improper coolant may harm engine and cooling system components and may void the warranty.
- In case of emergency, a large amount of water without engine coolant may be added in order to reach a vehicle service location. In this instance, the cooling system must be drained, chemically cleaned with Motorcraft Premium Cooling System Flush, and refilled with engine coolant as soon as possible. Water alone (without engine coolant) can cause engine damage from corrosion, overheating or freezing.
- Do not use alcohol, methanol, brine or any engine coolants mixed with alcohol or methanol antifreeze (coolant). Alcohol and other liquids can cause engine damage from overheating or freezing.
- Do not add extra inhibitors or additives to the coolant. These can be harmful and compromise the corrosion protection of the engine coolant.

Unscrew the cap slowly. Any pressure will escape as you unscrew the cap.

Add prediluted engine coolant meeting the Ford specification.

See *Capacities and Specifications* for more information.

Whenever coolant has been added, the coolant level in the coolant reservoir should be checked the next few times you drive the vehicle. If necessary, add enough prediluted engine coolant to bring the coolant level to the proper level.

### Recycled Engine Coolant

Ford Motor Company does not recommend the use of recycled engine coolant since a Ford-approved recycling process is not yet available.



Used engine coolant should be disposed of in an appropriate manner. Follow your community's regulations and standards for recycling and disposing of automotive fluids.

**Severe Climates**

If you drive in extremely cold climates:

- It may be necessary to have a Ford authorized dealer increase the coolant concentration above 50%.
- A coolant concentration of 60% will provide improved freeze point protection. Engine coolant concentrations above 60% will decrease the overheat protection characteristics of the engine coolant and may cause engine damage.

If you drive in extremely hot climates:

- It may be necessary to have a Ford authorized dealer decrease the coolant concentration to 40%.
- A coolant concentration of 40% will provide improved overheat protection. Engine coolant concentrations below 40% will decrease the corrosion/freeze protection characteristics of the engine coolant and may cause engine damage.

Vehicles driven year-round in non-extreme climates should use prediluted engine coolant for optimum cooling system and engine protection.

**What You Should Know About Fail-Safe Cooling**

If the engine coolant supply is depleted, this feature allows the vehicle to be driven temporarily before incremental component damage is incurred. The fail-safe distance depends on ambient temperatures, vehicle load and terrain.

**How Fail-Safe Cooling Works**

If the engine begins to overheat, the engine coolant temperature gauge will move to the red (hot) area and:



The coolant temperature warning light will illuminate.



The service engine soon indicator will illuminate.

If the engine reaches a preset over-temperature condition, the engine will automatically switch to alternating cylinder operation. Each disabled cylinder acts as an air pump and cools the engine.

When this occurs the vehicle will still operate. However:

- The engine power will be limited.
- The air conditioning system will be disabled.

Continued operation will increase the engine temperature and the engine will completely shut down, causing steering and braking effort to increase.

Once the engine temperature cools, the engine can be restarted. Take your vehicle to an authorized dealer as soon as possible to minimize engine damage.

#### **When Fail-Safe Mode is Activated**



**WARNING:** Fail-safe mode is for use during emergencies only.

Operate the vehicle in fail-safe mode only as long as necessary to bring the vehicle to rest in a safe location and seek immediate repairs. When in fail-safe mode, the vehicle will have limited power, will not be able to maintain high-speed operation, and may completely shut down without warning, potentially losing engine power, power steering assist, and power brake assist, which may increase the possibility of a crash resulting in serious injury.



**WARNING:** Never remove the coolant reservoir cap while the engine is running or hot.

You have limited engine power when in the fail-safe mode, so drive the vehicle with caution. The vehicle will not be able to maintain high-speed operation and the engine will run rough. Remember that the engine is capable of completely shutting down automatically to prevent engine damage, therefore:

1. Pull off the road as soon as safely possible and turn off the engine.
2. Arrange for the vehicle to be taken to an authorized dealer.
3. If this is not possible, wait a short period for the engine to cool.
4. Check the coolant level and replenish if low.
5. Restart the engine and take your vehicle to an authorized dealer.

**Note:** Driving the vehicle without repairing the engine problem increases the chance of engine damage. Take your vehicle to an authorized dealer as soon as possible.

**AUTOMATIC TRANSMISSION FLUID CHECK**

**Note:** Transmission fluid should be checked by an authorized dealer. If required, fluid should be added by an authorized dealer.

The automatic transmission does not have a transmission fluid dipstick.

Refer to your *scheduled maintenance information* for scheduled intervals for fluid checks and changes. Your transmission does not consume fluid. However, the fluid level should be checked if the transmission is not working properly, (i.e., if the transmission slips or shifts slowly) or if you notice some sign of fluid leakage.

Do not use supplemental transmission fluid additives, treatments or cleaning agents. The use of these materials may affect transmission operation and result in damage to internal transmission components.

**BRAKE FLUID CHECK**

Fluid levels between the MIN and MAX lines are within the normal operating range; there is no need to add fluid. If the fluid levels are outside of the normal operating range, the performance of the system could be compromised; seek service from your authorized dealer immediately.

**POWER STEERING FLUID CHECK**

Check the power steering fluid. Refer to *scheduled maintenance information*.

1. Start the engine and let it run until it reaches normal operating temperature (the engine coolant temperature gauge indicator will be near the center of the normal area between H and C).
2. While the engine idles, turn the steering wheel left and right several times.
3. Turn the engine off.
4. Check the fluid level in the reservoir. It should be between the MIN and MAX lines. Do not add fluid if the level is in this range.
5. If the fluid is low, add fluid in small amounts, continuously checking the level until it reaches the range between the MIN and MAX lines. Be sure to put the cap back on the reservoir. Refer to the *Capacities and Specifications* chapter for the proper fluid type.

**FUEL FILTER**

Your vehicle is equipped with a lifetime fuel filter that is integrated with the fuel tank. Regular maintenance or replacement is not needed.

**WASHER FLUID CHECK**

 **WARNING:** If you operate your vehicle in temperatures below 40°F (5°C), use washer fluid with antifreeze protection. Failure to use washer fluid with antifreeze protection in cold weather could result in impaired windshield vision and increase the risk of injury or accident.

Add fluid to fill the reservoir if the level is low. Only use a washer fluid that meets Ford specifications. See the technical specifications chart in the *Capacities and Specifications* chapter.

**Note:** The front and rear washer systems are supplied from the same reservoir.

State or local regulations on volatile organic compounds may restrict the use of methanol, a common windshield washer antifreeze additive. Washer fluids containing non-methanol antifreeze agents should be used only if they provide cold weather protection without damaging the vehicle's paint finish, wiper blades or washer system.

**CHANGING THE VEHICLE BATTERY**

 **WARNING:** Batteries normally produce explosive gases which can cause personal injury. Therefore, do not allow flames, sparks or lighted substances to come near the battery. When working near the battery, always shield your face and protect your eyes. Always provide proper ventilation.

 **WARNING:** When lifting a plastic-cased battery, excessive pressure on the end walls could cause acid to flow through the vent caps, resulting in personal injury and/or damage to the vehicle or battery. Lift the battery with a battery carrier or with your hands on opposite corners.



**WARNING:** Keep batteries out of reach of children. Batteries contain sulfuric acid. Avoid contact with skin, eyes or clothing. Shield your eyes when working near the battery to protect against possible splashing of acid solution. In case of acid contact with skin or eyes, flush immediately with water for a minimum of 15 minutes and get prompt medical attention. If acid is swallowed, call a physician immediately.



**WARNING:** Battery posts, terminals and related accessories contain lead and lead compounds. **Note:** Wash hands after handling.

**Note:** If your battery has a cover/shield, make sure it is reinstalled after the battery has been cleaned or replaced.

For longer, trouble-free operation, keep the top of the battery clean and dry. Also, make certain the battery cables are always tightly fastened to the battery terminals.

**Note:** Electrical or electronic accessories or components added to the vehicle by the dealer or the owner may adversely affect battery performance and durability.

Your vehicle is equipped with a Motorcraft® maintenance-free battery which normally does not require additional water during its life of service.

If you see any corrosion on the battery or terminals, remove the cables from the terminals and clean with a wire brush. You can neutralize the acid with a solution of baking soda and water.

It is recommended that the negative battery cable terminal be disconnected from the battery if you plan to store your vehicle for an extended period of time. This will minimize the discharge of your battery during storage.

Because your vehicle's engine is electronically controlled by a computer, some control conditions are maintained by power from the battery. When the battery is disconnected or a new battery is installed, the engine must relearn its idle and fuel trim strategy for optimum driveability and performance. To begin this process:

1. With the vehicle at a complete stop, set the parking brake.
  2. Put the gearshift in P (Park), turn off all accessories and start the engine.
  3. Run the engine until it reaches normal operating temperature.
  4. Allow the engine to idle for at least one minute.
  5. Turn the A/C on and allow the engine to idle for at least one minute.
  6. Drive the vehicle to complete the relearning process.
- The vehicle may need to be driven 10 miles (16 km) or more to relearn the idle and fuel trim strategy.
  - **Note:** If you do not allow the engine to relearn its idle trim, the idle quality of your vehicle may be adversely affected until the idle trim is eventually relearned.

If the battery has been disconnected or a new battery has been installed, the clock and radio settings must be reset once the battery is reconnected.

#### CHECKING THE WIPER BLADES

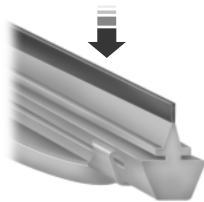

Run the tip of your fingers over the edge of the blade to check for roughness.

Clean the wiper blades with washer fluid or water applied with a soft sponge or cloth.

**CHANGING THE WIPER BLADES**

Replace wiper blades at least once per year for optimum performance.

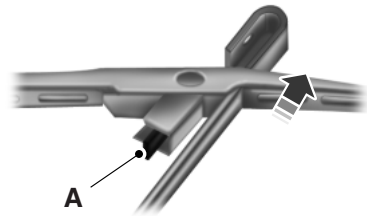

To replace the wiper blades:

1. Fold back the wiper arm and position the wiper blade at a right angle to the wiper arm.
2. To remove the wiper blade, press the retaining clip (A) to disengage the wiper blade, then pull the blade down toward the windshield to remove it from the arm.

3. Install the new wiper blade on the arm and press it into place until a click is heard.

Poor wiper quality can be improved by cleaning the wiper blades and windshield. Refer to *Windows and wiper blades* in the *Cleaning* chapter.

To prolong the life of the wiper blades, it is highly recommended to scrape off the ice on the windshield before turning on the wipers. The layer of ice has many sharp edges and can damage the micro edge of the wiper rubber element.

**Changing the Rear Window Wiper Blade**

To replace the rear wiper blade:

1. Pull the wiper arm as far away from the glass as possible. Do not use excessive force because it can break the wiper arm. Hold it there until the next step.

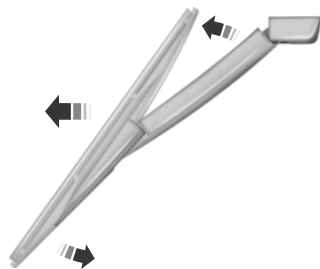

2. Grasp the wiper blade and rotate it away from the wiper arm using moderate force until it disengages from the wiper arm.
3. Once the wiper blade is loose, slide it away from the wiper arm.

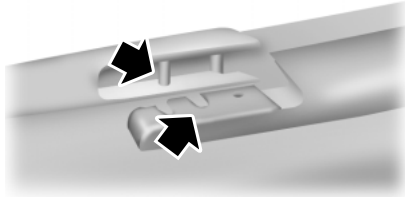

4. To attach the new wiper to the wiper arm, align the cross pin and keyway (denoted with the arrows) and firmly press the wiper blade into the wiper arm until an audible snap is heard.

If you find this procedure too difficult, please see your dealer.

#### AIR FILTER CHECK



**WARNING:** To reduce the risk of vehicle damage and or personal burn injuries, do not start your engine with the air cleaner removed and do not remove it while the engine is running.

**Note:** Failure to use the correct air filter element may result in severe engine damage. The customer warranty may be void for any damage to the engine if the correct air filter element is not used.

When changing the air filter element, use only the air filter element listed. See *Motorcraft® Part Numbers* in the *Capacities and Specifications* chapter.

See *Scheduled Maintenance Information* for the appropriate intervals for changing the air filter element.

**Note:** Failure to use the correct air filter element may result in severe engine damage. The customer warranty may be void for any damage to the engine if the correct air filter element is not used.

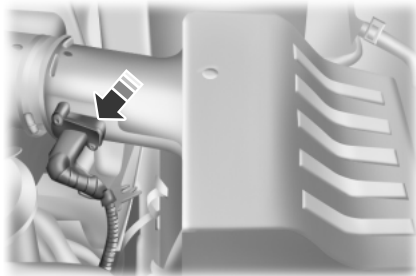
**Changing the Air Filter Element**

1. Locate the mass air flow sensor electrical connector on the air outlet tube. This connector will need to be unplugged.

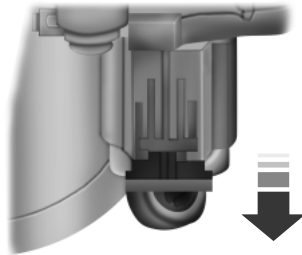

2. Unlock the locking clip on the connector (connector shown from below for clarity), then squeeze and pull the connector off of the air outlet tube.

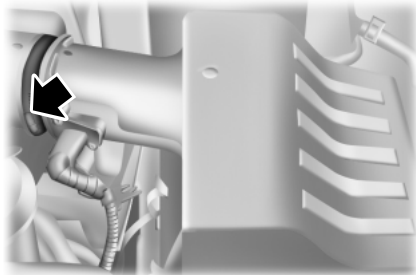

3. Clean the area around the air tube to air cover connection to prevent debris from entering the system and then loosen the bolt on the air tube clamp so the clamp is no longer snug to the air tube. It is not necessary to completely remove the clamp.

4. Pull the air tube off from the air cleaner housing.

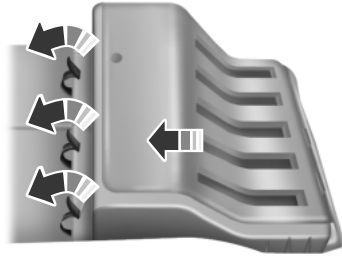

5. Release the three clamps that secure the cover to the air filter housing. Push the air filter cover toward the center of the vehicle and up slightly to release it.

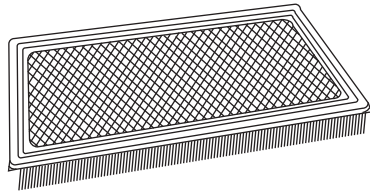

6. Remove the air filter element from the air filter housing.  
7. Install a new air filter element.



8. Replace the air filter housing cover and secure the clamps. Be careful not to crimp the filter element edges between the air filter housing and cover and ensure that the tabs on the edge are properly aligned into the slots.

9. Slip the air tube onto the air filter housing and tighten the air-tube clamp bolt snugly, but do not overtighten it.

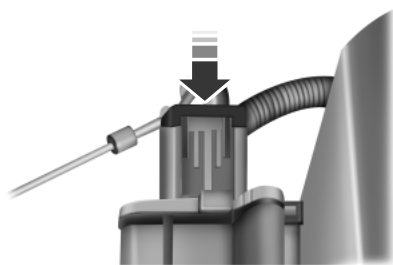

10. Reconnect the mass air flow sensor electrical connector to the outlet tube. Make sure the locking tab on the connector is in the "locked" position (connector shown from below for clarity).

**ADJUSTING THE HEADLAMPS**

The headlamps on your vehicle are properly aimed at the assembly plant. If your vehicle has been in an accident, an authorized dealer should check the alignment of your headlamps.

**Vertical Aim Adjustment**

Before aim adjustment, disable the air suspension system. Refer to *Message center* in the *Driver Controls* chapter.

1. Park the vehicle directly in front of a wall or screen on a level surface, approximately 25 feet (7.6 meters) away.

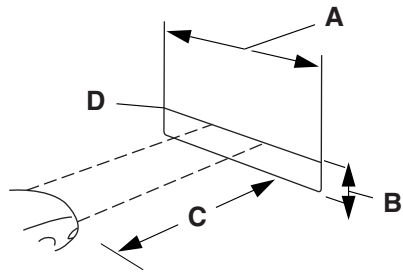

- (A) 8 feet (2.4 meters)
- (B) Center height of lamp to ground
- (C) 25 feet (7.6 meters)
- (D) Horizontal reference line

2. Measure the height from the center of your headlamp (indicated by a 3.0 millimeter circle on the lens) to the ground and mark an 8 foot (2.4 meter) horizontal reference line on the vertical wall or screen at this height (a piece of masking tape works well).

3. Turn on the low beam headlamps to illuminate the wall or screen and open the hood. Cover one of the headlamps so no light from that lamp hits the wall.



4. On the wall or screen you will observe a light pattern with a distinct horizontal edge towards the right. If this edge is not at the horizontal reference line, the beam will need to be adjusted so the edge is at the same height as the horizontal reference line.

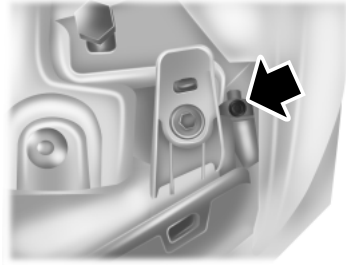

5. Locate the vertical adjuster on each headlamp, then use a Phillips #2 screwdriver to turn the adjuster either counterclockwise or clockwise in order to adjust the vertical aim of the headlamp. The upper edge of the light pattern should touch the horizontal reference line.

6. HORIZONTAL AIM IS NOT REQUIRED FOR THIS VEHICLE AND IS NOT ADJUSTABLE.

7. Repeat Steps 3–5 for the other headlamp.

8. Close the hood and turn off the lamps.

### CHANGING A BULB

#### Lamp Assembly Condensation

Exterior lamps are vented to accommodate normal changes in pressure. Condensation can be a natural by-product of this design. When moist air enters the lamp assembly through the vents, there is a possibility that condensation can occur when the temperature is cold. When normal condensation occurs, a thin film of mist can form on the interior of the lens. The thin mist eventually clears and exits through the vents during normal operation. Clearing time may take as long as 48 hours under dry weather conditions.

These are examples of acceptable condensation:

- Presence of thin mist (no streaks, drip marks or droplets).
- Fine mist covers less than 50% of the lens.

These are examples of unacceptable moisture (usually caused by a lamp water leak):

- Water puddle inside the lamp.
- Large water droplets, drip marks or streaks present on the interior of the lens.

Take your vehicle to a dealer for service if any of the above conditions of unacceptable moisture are present.

**Replacing HID Headlamp Bulbs**

The low/high beam headlamps on your vehicle use a “high intensity discharge” source. These lamps operate at a high voltage. For bulb replacement, see your authorized dealer.

**Replacing Front Parking Lamp, Turn Signal, and Side Marker Bulbs**

The front parking lamp, turn signal, and side marker bulbs are located in the headlamp assembly. Follow the same steps to replace any of these bulbs.

1. Make sure the headlamp control is in the off position.
2. Open the hood.

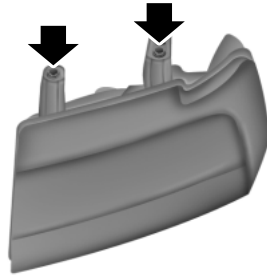

3. At the back of the headlamp lens, remove the two headlamp assembly bolts.

4. Pull the headlamp assembly forward slightly to expose the electrical connectors.

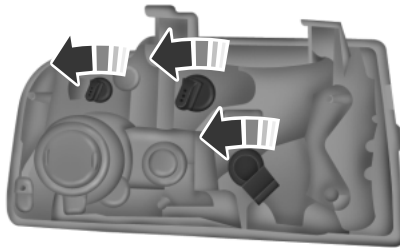

5. Rotate the bulb socket counterclockwise and remove it.

6. Pull the bulb straight out of the socket and push in the new bulb.

7. To complete installation of the parking lamp/turn signal assembly, follow the removal procedures in reverse order.

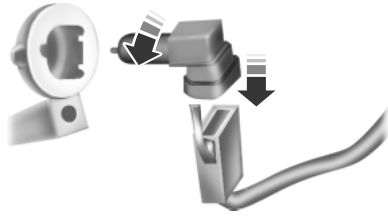
**Replacing Fog Lamp Bulbs**

1. From underneath the vehicle, rotate the harness/bulb assembly counterclockwise to remove it from the fog lamp assembly.

2. Carefully disconnect the bulb from the harness assembly via the two snap clips.

Install the new bulb in reverse order.

**Replacing Tail, Stop, Turn Signal, and Backup Lamp Bulbs**

The tail, stop, turn signal, and backup lamp bulbs are located in the same portion of the tail lamp assembly, one just below the other. Follow the same steps to replace any of these bulbs.

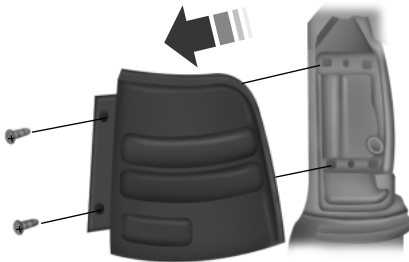

1. Make sure the headlamp switch is in the off position.

2. Open the liftgate to expose the lamp assembly screws.

3. Remove the two screws from the lamp assembly.

4. Carefully pry the lamp assembly away from the vehicle by pulling the assembly directly straight out to expose the bulb socket. **DO NOT TIP THE LAMP ASSEMBLY SIDEWAYS.**

5. Rotate the bulb socket counterclockwise and remove from lamp assembly.

6. Pull bulb straight out of the socket and push in the new bulb.

7. Install the bulb socket into the lamp assembly and rotate clockwise.

8. Install the lamp assembly on the vehicle and secure with two screws.

**Replacing Supplemental Tail Lamp Bulbs**

1. Make sure the headlamp switch is in the off position.
2. Open the liftgate and remove interior trim panel.

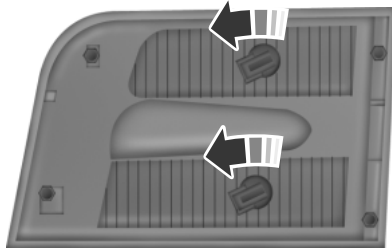

3. Remove four nuts from the lamp assembly.
4. Carefully pry the lamp assembly away from the vehicle by pulling the assembly directly straight out to expose the bulb socket. **DO NOT TIP THE LAMP ASSEMBLY SIDEWAYS.**

5. Rotate the bulb socket counterclockwise and remove from lamp assembly.
6. Pull bulb straight out of socket and push in the new bulb.
7. Install the bulb socket into the lamp assembly and rotate clockwise.
8. Install the lamp assembly on the vehicle and secure with four nuts.
9. Install the interior trim panel.

**Replacing License Plate Lamp Bulbs**

The license plate bulbs are located in the license plate housing assembly on the liftgate. To change the license plate bulbs:

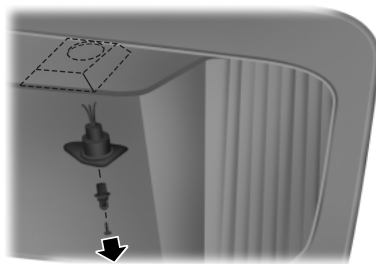

1. Make sure the headlamp switch is in the off position.
2. Remove the license lamp screw from the assembly.
3. Pull the lamp down and twist the bulb socket counterclockwise. Remove the bulb socket from the lamp.
4. Pull out the old bulb and push in the new bulb.
5. Install the bulb socket in the lamp assembly by turning it clockwise.
6. Install the lamp assembly and secure it with the retaining screw.

**Replacing the High-Mount Brake Lamp Bulbs**

To change the high-mount brake lamp bulbs:

1. Remove the two screws holding the lamp assembly in place.
2. Pull the lamp assembly straight out.
3. Disconnect the wire harness.

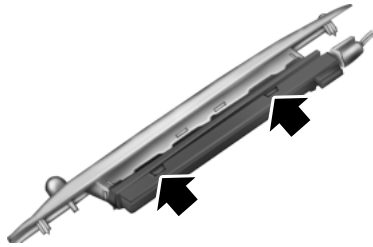

4. Press the four tabs that hold the light assembly on, one at a time, and pull the black bulb carrier away from the lamp.
5. Pull the old bulb out and replace with the new bulb.
6. Snap the black bulb carrier into the lamp assembly.
7. Connect the wire harness.
8. Install the lamp assembly with two screws.

**Replacing Approach Lamp/Mirror Turn Signal Bulbs**

For bulb replacement, see your authorized dealer.

**BULB SPECIFICATION CHART**

Replacement bulbs are specified in the chart below. Headlamp bulbs must be marked with an authorized "D.O.T." for North America to ensure lamp performance, light brightness and pattern and safe visibility. The correct bulbs will not damage the lamp assembly or void the lamp assembly warranty and will provide quality bulb burn time.

<b>Function</b>	<b>Number of bulbs</b>	<b>Trade number</b>
Headlamps (low and high-beam)	2	*See your dealer
Front park lamps	2	3157K
Front turn lamps	2	3157A (amber)
Front side marker	2	168A (amber)
Fog lamps	2	H11
Front row map lamps	2	1600XB
2nd row reading lamp	1	1600XB
Rear cargo lamp	1	211-2XB
Rear turn/tail/brake lamps	4	3057K
Backup lamps	2	921
Supplemental tail lamps	4	906
Approach lamps	2	906
Mirror turn signal lamps	2	906 (amber)
License lamp	2	168
High-mount brake lamp	5	W5W
Visor vanity lamp - Slide on rail system (SOR)	2	A6224PF
All replacement bulbs are clear in color except where noted.		
To replace all instrument panel lights - see your authorized dealer		

\* For vehicles with HID (high intensity discharge) lamps, see your authorized dealer for service.

**GENERAL INFORMATION**

Your Ford or Lincoln authorized dealer has many quality products available to clean your vehicle and protect its finishes.

**CLEANING PRODUCTS**

For best results, use the following products or products of equivalent quality:

Motorcraft Bug and Tar Remover (ZC-42)

Motorcraft Custom Bright Metal Cleaner (ZC-15)

Motorcraft Detail Wash (ZC-3-A)

Motorcraft Dusting Cloth (ZC-24)

Motorcraft Engine Shampoo and Degreaser (United States only) (ZC-20)

Motorcraft Engine Shampoo (Canada only) (CXC-66-A)

Motorcraft Multi-Purpose Cleaner (Canada only) (CXC-101)

Motorcraft Premium Glass Cleaner (Canada only) (CXC-100)

Motorcraft Premium Quality Windshield Washer Fluid (Canada only) [CXC-37-(A, B, D or F)]

Motorcraft Premium Windshield Wash Concentrate with Bitterant (United States only) (ZC-32-B2)

Motorcraft Professional Strength Carpet & Upholstery Cleaner (ZC-54)

Motorcraft Spot and Stain Remover (United States only) (ZC-14)

Motorcraft Ultra-Clear Spray Glass Cleaner (ZC-23)

Motorcraft Wheel and Tire Cleaner (ZC-37-A)

**CLEANING THE EXTERIOR**

Wash your vehicle regularly with cool or lukewarm water and a neutral pH shampoo, such as Motorcraft® Detail Wash.

- Never use strong household detergents or soap, such as dish washing or laundry liquid. These products can discolor and spot painted surfaces.
- Never wash a vehicle that is hot to the touch or during exposure to strong, direct sunlight.
- Dry the vehicle with a chamois or soft terry cloth towel in order to eliminate water spotting.

- Immediately remove items such as gasoline, diesel fuel, bird droppings and insect deposits because they can cause damage to the vehicle's paintwork and trim over time. Use Motorcraft Bug and Tar Remover.
- **Note:** Suntan lotions and insect repellents can damage any painted surface; if these substances come in contact with your vehicle, wash it off as soon as possible.
- Remove any exterior accessories before entering a car wash.

**Stripes or Graphics (if equipped)**

Do not use a commercial or high-pressure wand on the surface or edge of stripes and graphics. This can cause damage to the film and cause the edge of the film to peel away from the vehicle surface.

**Exterior Chrome**

**Note:** Never use abrasive materials such as steel wool or plastic pads as they can scratch the chrome surface.

**Note:** Do not use chrome cleaner, metal cleaner or polish on wheels and wheel covers.

- Wash the vehicle first, using cool or lukewarm water and a neutral pH shampoo, such as Motorcraft Detail Wash.
- Use Motorcraft Custom Bright Metal Cleaner. Apply the product as you would a wax to clean bumpers and other chrome parts; allow the cleaner to dry for a few minutes, then wipe off the haze with a clean, dry rag.
- Do not apply cleaning product to hot surfaces and do not leave cleaning product on chrome surfaces for a period of time exceeding that which is recommended.
- **Note:** Using other non-recommended cleaners can result in severe and permanent cosmetic damage.

**Underbody**

Flush the complete underside of your vehicle frequently. Keep body and door drain holes free from packed dirt.

**Cleaning Plastic Exterior Parts**

Use only approved products to clean plastic parts.

- For routine cleaning, use Motorcraft Detail Wash.
- If tar or grease spots are present, use Motorcraft Bug and Tar Remover.

**WAXING**

Regular waxing is necessary to protect the paint on your car from the elements. We recommend that you wash and wax the painted surface once or twice a year.

When washing and waxing, park your vehicle in a shaded area out of direct sunlight. Always wash your vehicle before applying wax.

- Use a quality wax that does not contain abrasives.
- Follow the manufacturer's instructions to apply and remove the wax.
- Apply a small amount of wax in a back-and-forth motion, not in circles.
- Do not allow wax to come in contact with any non-body (low-gloss black) colored trim. The wax discolors or stains the parts over time, such as:
  - Bumpers
  - Grained door handles
  - Side mouldings
  - Mirror housings
  - Windshield cowl area.
- Do not apply wax to glass areas.
- After waxing, your car's paint should feel smooth, and be free of streaks and smudges.

**REPAIRING MINOR PAINT DAMAGE**

Your authorized dealer has touch-up paint to match your vehicle's color. Take your color code (printed on a sticker in the driver's door jamb) to an authorized dealer to make sure you get the correct color.

- Remove particles, such as bird droppings, tree sap, insect deposits, tar spots, road salt and industrial fallout, before repairing paint chips.
- Always read the instructions before using the products.

**CLEANING THE ENGINE**

Engines are more efficient when they are clean because grease and dirt buildup keep the engine warmer than normal.

When washing:

- Take care when using a power washer to clean the engine. The high-pressure fluid could penetrate the sealed parts and cause damage.
- Do not spray a hot engine with cold water to avoid cracking the engine block or other engine components.

- Spray Motorcraft Engine Shampoo and Degreaser on all parts that require cleaning and pressure rinse clean. In Canada, use Motorcraft Engine Shampoo.
- Never wash or rinse the engine while it is hot or running; water in the running engine may cause internal damage.
- Never wash or rinse any ignition coil, spark plug wire or spark plug well, or the area in and around these locations.
- Cover the battery, power distribution box, and air filter assembly to prevent water damage when cleaning the engine.

### **CLEANING THE WINDOWS AND WIPER BLADES**

The windows and wiper blades should be cleaned regularly. If the wipers do not wipe properly, substances on the vehicle's glass or the wiper blades may cause squeaking or chatter noise from the blades, and streaking and smearing of the windshield. To clean these items, follow these tips:

- The windows may be cleaned with a non-abrasive cleaner such as Motorcraft® Ultra-Clear Spray Glass Cleaner.
- The wiper blades can be cleaned with isopropyl (rubbing) alcohol or Motorcraft Premium Windshield Washer Concentrates in the U.S., or Motorcraft Premium Quality Windshield Washer Fluid in Canada. Replace your wiper blades when they appear worn or do not function properly.
- Do not use abrasive materials, as they may cause scratches.
- Do not use fuel, kerosene, or paint thinner to clean any parts.

If you cannot remove those streaks after cleaning with the glass cleaner or if the wipers chatter and move in a jerky motion, clean the outer surface of the windshield and the wiper blades using a sponge or soft cloth with a neutral detergent or mild-abrasive cleaning solution. After cleaning, rinse the windshield and wiper blades with clean water. The windshield is clean if beads do not form when you rinse the windshield with water.

**Note:** Do not use sharp objects, such as a razor blade, to clean the inside of the rear window or to remove decals, as it may cause damage to the rear window defroster's heated grid lines.

**CLEANING THE INTERIOR**

**WARNING:** Do not use cleaning solvents, bleach or dye on the vehicle's safety belts, as these actions may weaken the belt webbing.



**WARNING:** On vehicles equipped with seat-mounted airbags, do not use chemical solvents or strong detergents. Such products could contaminate the side airbag system and affect performance of the side airbag in a collision.

For fabric, carpets, cloth seats, safety belts and seats equipped with side airbags:

- Remove dust and loose dirt with a vacuum cleaner.
- Apply a layer of high quality foam cleaner, designed for automotive interiors, to the dry stained area (s) of the item you are cleaning and allow soaking for one minute.
- If grease or tar is present on the material, spot-clean the area first with Motorcraft Spot and Stain Remover. In Canada, use Motorcraft Multi-Purpose Cleaner.
- If a ring forms on the fabric after spot cleaning, clean the entire area immediately (but do not oversaturate) or the ring can set.
- Do not use household cleaning products or glass cleaners, which can stain and discolor the fabric and affect the flame retardant abilities of the seat materials.

**CLEANING THE CLIMATE CONTROLLED SEATS (IF EQUIPPED)**

Remove dust and loose dirt with a whisk broom or a vacuum cleaner. Remove fresh spots immediately. Clean the seat with a damp cloth, using a mild soap and water solution, if necessary.

**CLEANING THE INSTRUMENT PANEL AND INSTRUMENT CLUSTER LENS**

**WARNING:** Do not use chemical solvents or strong detergents when cleaning the steering wheel or instrument panel to avoid contamination of the airbag system.

Clean the instrument panel and cluster lens with a clean, damp, white, cotton cloth, then use a clean and dry, white, cotton cloth to dry these areas.

- Avoid cleaners or polishes that increase the gloss of the upper portion of the instrument panel. The dull finish in this area helps protect the driver from undesirable windshield reflection.
- Be certain to wash or wipe your hands clean if you have been in contact with certain products, such as insect repellent and suntan lotion, in order to avoid possible damage to the interior painted surfaces.
- Do not use household or glass cleaners as these may damage the finish of the instrument panel, interior trim and cluster lens.
- Do not allow air fresheners and hand sanitizers to spill on interior surfaces. If a spill occurs, wipe off immediately. Damage may not be covered by your warranty.

If a staining liquid like coffee or juice has been spilled on the instrument panel or on interior trim surfaces, clean as follows:

1. Wipe up spilled liquid using a clean, white, cotton cloth.
2. Wipe the surface with a damp, clean, white, cotton cloth. For more thorough cleaning, use a mild soap and water solution. If the spot cannot be completely cleaned by this method, the area may be cleaned using a commercially available cleaning product designed for automotive interiors.
3. If necessary, apply more soap and water solution or cleaning product to a clean, white, cotton cloth and press the cloth onto the soiled area; allow this to set at room temperature for 30 minutes.
4. Remove the soaked cloth, and if it is not soiled badly, use this cloth to clean the area by using a rubbing motion for 60 seconds.
5. Following this, wipe area dry with a clean, white, cotton cloth.

**CLEANING LEATHER SEATS (IF EQUIPPED)**

- Remove dust and loose dirt with a vacuum cleaner.
- Clean spills and stains as quickly as possible.
- For routine cleaning, wipe the surface with a soft, damp cloth. For more thorough cleaning, wipe the surface with a mild soap and water solution. Dry the area with a soft cloth.
- If the leather cannot be completely cleaned using a mild soap and water solution, the leather may be cleaned using a commercially available leather cleaning product designed for automotive interiors.
- To check for compatibility, first test any cleaner or stain remover on an inconspicuous part of the leather.
- Do not use household cleaning products, alcohol solutions, oil/petroleum-based leather conditioners, or solvents or cleaners intended specifically for rubber, vinyl and plastics. These products may cause premature wearing or damage to the leather.

**CLEANING THE ALLOY WHEELS**

**Note:** Do not use chrome cleaner, metal cleaner or polish on wheels and wheel covers.

A clearcoat paint finish coats aluminum wheels and wheel covers. In order to maintain their condition:

- Clean weekly with Motorcraft Wheel and Tire Cleaner. Use a sponge to remove heavy deposits of dirt and brake dust accumulation. Rinse thoroughly with a strong stream of water when you have completed the cleaning process.
- To remove tar and grease, use Motorcraft Bug and Tar Remover.
- Never apply any cleaning chemical to hot or warm wheel rims or covers.
- Some automatic car washes may cause damage to the finish on your wheel rims or covers.
- Industrial-strength (heavy-duty) cleaners, or cleaning chemicals, in combination with brush agitation to remove brake dust and dirt, could wear away the clearcoat finish over time.
- Do not use hydrofluoric acid-based or high caustic-based wheel cleaners, steel wool, fuels or strong household detergent.
- If you intend on parking your vehicle for an extended period after cleaning the wheels with a wheel cleaner, drive your vehicle for a few minutes before doing so. This reduces the risk of increased corrosion of the brake discs.

**VEHICLE STORAGE**

If you plan on storing your vehicle for an extended period of time (30 days or more), read the following maintenance recommendations to make sure your vehicle stays in good operating condition.

All motor vehicles and their components were engineered and tested for reliable, regular driving. Long-term storage under various conditions may lead to component degradation or failure unless specific precautions are taken to preserve the components.

*General*

- Store all vehicles in a dry, ventilated place.
- Protect from sunlight, if possible.
- If vehicles are stored outside, they require regular maintenance to protect against rust and damage.

*Body*

- Wash vehicle thoroughly to remove dirt, grease, oil, tar or mud from exterior surfaces, rear-wheel housing and underside of front fenders.
- Periodically wash vehicles stored in exposed locations.
- Touch up raw or primed metal to prevent rust.
- Cover chrome and stainless steel parts with a thick coat of auto wax to prevent discoloration. Re-wax as necessary when the vehicle is washed.
- Lubricate hood latch, all door latches and trunk lid hinges with a light grade oil.
- Cover interior trim to prevent fading.
- Keep all rubber parts free from oil and solvents.

*Engine*

- The engine oil and filter should be changed prior to storage, as used engine oil contains contaminants that may cause engine damage.
- Start the engine every 15 days. Run at fast idle until it reaches normal operating temperature.
- With your foot on the brake, shift through all the gears while the engine is running.

*Fuel system*

- Fill the fuel tank with high-quality fuel until the first automatic shutoff of the fuel pump nozzle.

*Cooling system*

- Protect against freezing temperatures.

- When removing vehicle from storage, check coolant fluid level. Confirm there are no cooling system leaks, and fluid is at the recommended level.

#### *Battery*

- Check and recharge as necessary. Keep connections clean.
- If storing your vehicle for more than 30 days without recharging the battery, it may be advisable to disconnect the battery cables to ensure battery charge is maintained for quick starting.

**Note:** If battery cables are disconnected, it will be necessary to reset memory features.

#### *Brakes*

- Make sure brakes and parking brake are fully released.

#### *Tires*

- Maintain recommended air pressure.

#### *Miscellaneous*

- Make sure all linkages, cables, levers and pins under vehicle are covered with grease to prevent rust.
- Move vehicles at least 25 feet (8 meters) every 15 days to lubricate working parts and prevent corrosion.

### **Removing Vehicle from Storage**

When your vehicle is ready to come out of storage, do the following:

- Wash your vehicle to remove any dirt or grease film build-up on window surfaces.
- Check windshield wipers for any deterioration.
- Check under the hood for any foreign material that may have collected during storage (mice/squirrel nests).
- Check the exhaust for any foreign material that may have collected during storage.
- Check tire pressures and set tire inflation per the Tire Label.
- Check brake pedal operation. Drive the vehicle 15 feet (4.5 meters) back and forth to remove rust build-up.
- Check fluid levels (including coolant, oil and gas) to make sure there are no leaks and fluids are at recommended levels.
- If the battery was removed, clean the battery cable ends and inspect.

Contact your authorized dealer if you have any concerns or issues.

**GENERAL INFORMATION****Notice to Utility Vehicle, Van and Truck Owners**

**WARNING:** Utility vehicles have a significantly higher rollover rate than other types of vehicles. To reduce the risk of serious injury or death from a rollover or other crash you must:

- Avoid sharp turns and abrupt maneuvers;
- Drive at safe speeds for the conditions;
- Keep tires properly inflated;
- Never overload or improperly load your vehicle; and
- Make sure every passenger is properly restrained.



**WARNING:** In a rollover crash, an unbelted person is significantly more likely to die than a person wearing a seat belt. All occupants must wear seat belts. Children and infants must use appropriate restraints to minimize the risk of injury or ejection.



Utility vehicles, vans and trucks handle differently than passenger cars in the various driving conditions that are encountered on streets, highways and off-road. Utility vehicles, vans and trucks are not designed for cornering at speeds as high as passenger cars any more than low-slung sports cars are designed to perform satisfactorily under off-road conditions.

**Four-Wheel Drive System (If Equipped)**

**WARNING:** Do not become overconfident in the ability of four-wheel drive vehicles. Although a four-wheel drive vehicle may accelerate better than a two-wheel drive vehicle in low-traction situations, it will not stop any faster than two-wheel drive vehicles. Always drive at a safe speed.

A vehicle equipped with four-wheel drive (when selected) has the ability to use all four wheels to power itself. This increases traction which may enable you to safely drive over terrain and road conditions that a conventional two-wheel drive vehicle cannot.

Power is supplied to all four wheels through a transfer case or power transfer unit. Four-wheel drive vehicles allow you to select different drive modes as necessary. You can find information on transfer case operation and shifting procedures in the *Transmission* chapter. You can find information on transfer case maintenance in the *Maintenance* chapter. You should become thoroughly familiar with this information before you operate your vehicle.

On some four-wheel drive models, the initial shift from two-wheel drive to four-wheel drive while the vehicle is moving can cause a momentary clunk and ratcheting sound. These sounds are normal as the front drivetrain comes up to speed and are not cause for concern.

#### **How Your Vehicle Differs from Other Vehicles**

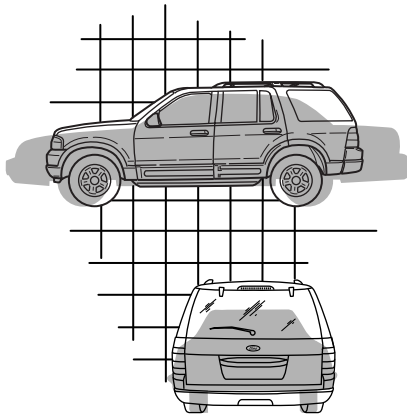

Sport-utility vehicles, vans and trucks can differ from some other vehicles in a few noticeable ways. Your vehicle may be:

- Higher – to allow higher load carrying capacity and to allow it to travel over rough terrain without getting hung up or damaging underbody components.
- Shorter – to give it the capability to approach inclines and drive over the crest of a hill without getting hung up or damaging underbody components. All other things held equal, a shorter

wheelbase may make your vehicle quicker to respond to steering inputs than a vehicle with a longer wheelbase.

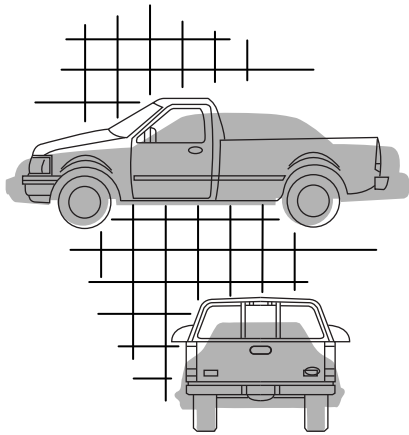

- Narrower – to provide greater maneuverability in tight spaces, particularly in off-road use.

As a result of the above dimensional differences, sport-utility vehicles, vans and trucks often will have a higher center of gravity and a greater difference in center of gravity between the loaded and unloaded condition.

These differences that make your vehicle so versatile also make it handle differently than an ordinary passenger car.

## TIRE CARE

### Information About Uniform Tire Quality Grading



Tire Quality Grades apply to new pneumatic passenger car tires. The Tire Quality Grades can be found where applicable on the tire sidewall between tread shoulder and maximum section width. For example:

- **Treadwear 200 Traction AA Temperature A**

These Tire Quality Grades are determined by standards that the United States Department of Transportation has set.

Tire Quality Grades apply to new pneumatic passenger car tires. They do not apply to deep tread, winter-type snow tires, space-saver or temporary use spare tires, light truck or LT type tires, tires with nominal rim diameters of 10 to 12 inches or limited production tires as defined in Title 49 Code of Federal Regulations Part 575.104(c)(2).

**U.S. Department of Transportation-Tire quality grades:** The U.S. Department of Transportation requires Ford Motor Company to give you the following information about tire grades exactly as the government has written it.

**Treadwear**

The treadwear grade is a comparative rating based on the wear rate of the tire when tested under controlled conditions on a specified government test course. For example, a tire graded 150 would wear 1½ times as well on the government course as a tire graded 100. The relative performance of tires depends upon the actual conditions of their use, however, and may depart significantly from the norm due to variations in driving habits, service practices, and differences in road characteristics and climate.

**Traction AA A B C**

**WARNING:** The traction grade assigned to this tire is based on straight-ahead braking traction tests, and does not include acceleration, cornering, hydroplaning or peak traction characteristics.

The traction grades, from highest to lowest are AA, A, B, and C. The grades represent the tire's ability to stop on wet pavement as measured under controlled conditions on specified government test surfaces of asphalt and concrete. A tire marked C may have poor traction performance.

**Temperature A B C**

**WARNING:** The temperature grade for this tire is established for a tire that is properly inflated and not overloaded. Excessive speed, underinflation, or excessive loading, either separately or in combination, can cause heat buildup and possible tire failure.

The temperature grades are A (the highest), B and C, representing the tire's resistance to the generation of heat and its ability to dissipate heat when tested under controlled conditions on a specified indoor laboratory test wheel. Sustained high temperature can cause the material of the tire to degenerate and reduce tire life, and excessive temperature can lead to sudden tire failure. The grade C corresponds to a level of performance which all passenger car tires must meet under the Federal Motor Vehicle Safety Standard No. 139. Grades B and A represent higher levels of performance on the laboratory test wheel than the minimum required by law.

**Glossary of Tire Terminology**

- **Tire label:** A label showing the OE (Original Equipment) tire sizes, recommended inflation pressure and the maximum weight the vehicle can carry.
- **Tire Identification Number (TIN):** A number on the sidewall of each tire providing information about the tire brand and manufacturing plant, tire size and date of manufacture. Also referred to as DOT code.
- **Inflation pressure:** A measure of the amount of air in a tire.
- **Standard load:** A class of P-metric or Metric tires designed to carry a maximum load at set pressure. For example: For P-metric tires 35 psi (2.4 bar) or 36 (2.5 bar) depending on tire size and for Metric tires 36 psi (2.5 bar). Increasing the inflation pressure beyond this pressure will not increase the tire capability.
- **Extra load:** A class of P-metric or Metric tires designed to carry a heavier maximum load at 42 psi (2.9 bar). Increasing the inflation pressure beyond this pressure will not increase the tire's load-carrying capability.
- **kPa:** KiloPascal, a metric unit of air pressure.
- **PSI:** Pounds per square inch, a standard unit of air pressure.
- **Cold tire pressure:** The tire pressure when the vehicle has been stationary and out of direct sunlight for an hour or more and prior to the vehicle being driven for 1 mile (1.6 kilometers).
- **Recommended inflation pressure:** The cold inflation pressure found on the Safety Compliance Certification Label (affixed to either the door hinge pillar, door-latch post, or the door edge that meets the door-latch post, next to the driver's seating position) or Tire Label located on the B-Pillar or the edge of the driver's door.
- **B-pillar:** The structural member at the side of the vehicle behind the front door.
- **Bead area of the tire:** Area of the tire next to the rim.
- **Sidewall of the tire:** Area between the bead area and the tread.
- **Tread area of the tire:** Area of the perimeter of the tire that contacts the road when mounted on the vehicle.
- **Rim:** The metal support (wheel) for a tire or a tire and tube assembly upon which the tire beads are seated.

**INFORMATION CONTAINED ON THE TIRE SIDEWALL**

Both U.S. and Canada Federal regulations require tire manufacturers to place standardized information on the sidewall of all tires. This information identifies and describes the fundamental characteristics of the tire and also provides a U.S. DOT Tire Identification Number for safety standard certification and in case of a recall.

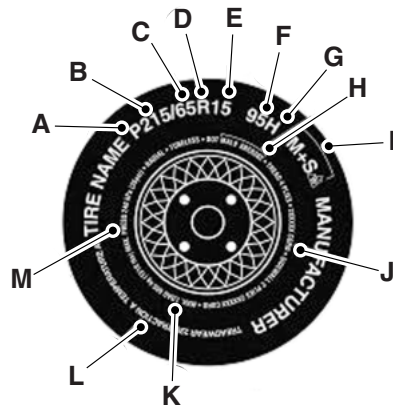
**Information on P Type Tires**

P215/65R15 95H is an example of a tire size, load index and speed rating. The definitions of these items are listed below. (Note that the tire size, load index and speed rating for your vehicle may be different from this example.)

A. **P:** Indicates a tire, designated by the Tire and Rim Association, that may be used for service on cars, sport utility vehicles, minivans and light trucks.

**Note:** If your tire size does not begin with a letter, this may mean it is designated by either the European Tire and Rim Technical Organization or the Japan Tire Manufacturing Association.

B. **215:** Indicates the nominal width of the tire in millimeters from sidewall edge to sidewall edge. In general, the larger the number, the wider the tire.

C. **65:** Indicates the aspect ratio which gives the tire's ratio of height to width.

D. **R:** Indicates a radial type tire.

E. **15:** Indicates the wheel or rim diameter in inches. If you change your wheel size, you will have to purchase new tires to match the new wheel diameter.

**F. 95:** Indicates the tire's load index. It is an index that relates to how much weight a tire can carry. You may find this information in your owner's manual. If not, contact a local tire dealer.

**Note:** You may not find this information on all tires because it is not required by federal law.

**G. H:** Indicates the tire's speed rating. The speed rating denotes the speed at which a tire is designed to be driven for extended periods of time under a standard condition of load and inflation pressure. The tires on your vehicle may operate at different conditions for load and inflation pressure. These speed ratings may need to be adjusted for the difference in conditions. The ratings range from 81 mph (130 km/h) to 186 mph (299 km/h). These ratings are listed in the following chart.

**Note:** You may not find this information on all tires because it is not required by federal law.

Letter rating	Speed rating - mph (km/h)
M	81 (130)
N	87 (140)
Q	99 (159)
R	106 (171)
S	112 (180)
T	118 (190)
U	124 (200)
H	130 (210)
V	149 (240)
W	168 (270)
Y	186 (299)

**Note:** For tires with a maximum speed capability over 149 mph (240 km/h), tire manufacturers sometimes use the letters ZR. For those with a maximum speed capability over 186 mph (299 km/h), tire manufacturers always use the letters ZR.

**H. U.S. DOT Tire Identification Number (TIN):** This begins with the letters DOT and indicates that the tire meets all federal standards. The next two numbers or letters are the plant code designating where it was manufactured, the next two are the tire size code and the last four numbers represent the week and year the tire was built. For example, the numbers 317 mean the 31st week of 1997. After 2000 the numbers go to four digits. For example, 2501 means the 25th week of 2001. The numbers in between are identification codes used for traceability. This information is used to contact customers if a tire defect requires a recall.

I. **M+S or M/S:** Mud and Snow, or

**AT:** All Terrain, or

**AS:** All Season.

J. **Tire Ply Composition and Material Used:** Indicates the number of plies or the number of layers of rubber-coated fabric in the tire tread and sidewall. Tire manufacturers also must indicate the ply materials in the tire and the sidewall, which include steel, nylon, polyester, and others.

K. **Maximum Load:** Indicates the maximum load in kilograms and pounds that can be carried by the tire. See the Safety Compliance Certification Label (affixed to either the door hinge pillar, door-latch post, or the door edge that meets the door-latch post, next to the driver's seating position), for the correct tire pressure for your vehicle.

L. **Treadwear, Traction and Temperature Grades**

- **Treadwear:** The treadwear grade is a comparative rating based on the wear rate of the tire when tested under controlled conditions on a specified government test course. For example, a tire graded 150 would wear one and one-half (1½) times as well on the government course as a tire graded 100.
- **Traction:** The traction grades, from highest to lowest, are AA, A, B, and C. The grades represent the tire's ability to stop on wet pavement as measured under controlled conditions on specified government test surfaces of asphalt and concrete. A tire marked C may have poor traction performance.
- **Temperature:** The temperature grades are A (the highest), B and C, representing the tire's resistance to the generation of heat and its ability to dissipate heat when tested under controlled conditions on a specified indoor laboratory test wheel.

M. **Maximum Inflation Pressure:** Indicates the tire manufacturer's maximum permissible pressure or the pressure at which the maximum load can be carried by the tire. This pressure is normally higher than the vehicle manufacturer's recommended cold inflation pressure, which can be found on the Safety Compliance Certification Label (affixed to either the door hinge pillar, door-latch post, or the door edge that meets the door-latch post, next to the driver's seating position), or Tire Label which is located on the B-Pillar or the edge of the driver's door. The cold inflation pressure should never be set lower than the recommended pressure on the vehicle label.

The tire suppliers may have additional markings, notes or warnings, such as standard load or radial tubeless.

### **Additional Information Contained on the Tire Sidewall for LT Type Tires**

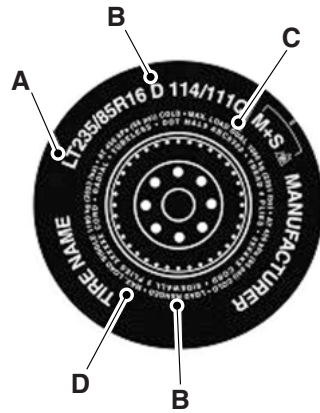

LT type tires have some additional information beyond those of P type tires. These differences are described below.

**Note:** Tire Quality Grades do not apply to this type of tire.

A. **LT:** Indicates a tire, designated by the Tire and Rim Association, that is intended for service on light trucks.

B. **Load Range/Load Inflation Limits:** Indicates the tire's load-carrying capabilities and its inflation limits.

C. **Maximum Load Dual lb (kg) at psi (kPa) cold:** Indicates the maximum load and tire pressure when the tire is used as a dual, defined as four tires on the rear axle (a total of six or more tires on the vehicle).

D. **Maximum Load Single lb (kg) at psi (kPa) cold:** Indicates the maximum load and tire pressure when the tire is used as a single, defined as two tires (total) on the rear axle.

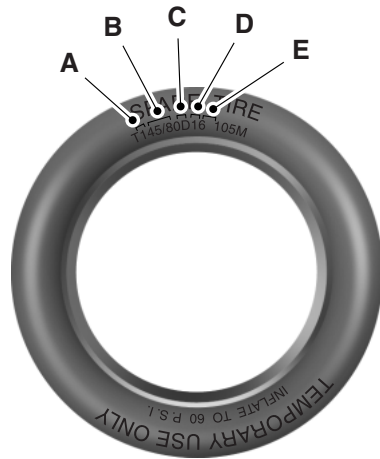
**Information on T Type Tires**

T type tires have some additional information beyond those of P type tires. These differences are described below.

T145/80D16 is an example of a tire size.

**Note:** The temporary tire size for your vehicle may be different from this example. Tire Quality Grades do not apply to this type of tire.

- A. **T:** Indicates a type of tire, designated by the Tire and Rim Association, that is intended for temporary service on cars, sport-utility vehicles, minivans and light trucks.
- B. **145:** Indicates the nominal width of the tire in millimeters from sidewall edge to sidewall edge. In general, the larger the number, the wider the tire.
- C. **80:** Indicates the aspect ratio, which gives the tire's ratio of height to width. Numbers of 70 or lower indicate a short sidewall.
- D. **D:** Indicates a diagonal type tire. **R:** Indicates a radial type tire.
- E. **16:** Indicates the wheel or rim diameter in inches. If you change your wheel size, you will have to purchase new tires to match the new wheel diameter.

**Location of the Tire Label**

You will find a Tire Label containing tire inflation pressure by tire size and other important information located on the B-Pillar or the edge of the driver's door. See the payload description and graphic in the *Load Carrying* chapter.

**INFLATING YOUR TIRES**

Safe operation of your vehicle requires that your tires are properly inflated. Remember that a tire can lose up to half of its air pressure without appearing flat.

Every day before you drive, check your tires. If one looks lower than the others, use a tire gauge to check pressure of all tires and adjust if required.

At least once a month and before long trips, inspect each tire and check the tire pressure with a tire gauge (including spare, if equipped). Inflate all tires to the inflation pressure recommended by Ford Motor Company.



**WARNING:** Under-inflation is the most common cause of tire failures and may result in severe tire cracking, tread separation or blowout, with unexpected loss of vehicle control and increased risk of injury. Under-inflation increases sidewall flexing and rolling resistance, resulting in heat build-up and internal damage to the tire. It also may result in unnecessary tire stress, irregular wear, loss of vehicle control and accidents. A tire can lose up to half of its air pressure and not appear to be flat!

You are strongly urged to buy a reliable tire pressure gauge, as automatic service station gauges may be inaccurate. Ford recommends the use of a digital or dial-type tire pressure gauge rather than a stick-type tire pressure gauge.

Use the recommended cold inflation pressure for optimum tire performance and wear. Under-inflation or over-inflation may cause uneven treadwear patterns.

Always inflate your tires to the Ford recommended inflation pressure even if it is less than the maximum inflation pressure information found on the tire. The Ford recommended tire inflation pressure is found on the Safety Compliance Certification Label (affixed to either the door hinge pillar, door-latch post, or the door edge that meets the door-latch post, next to the driver's seating position), or Tire Label which is located

on the B-Pillar or the edge of the driver's door. Failure to follow the tire pressure recommendations can cause uneven treadwear patterns and adversely affect the way your vehicle handles.

**Maximum Inflation Pressure** is the tire manufacturer's maximum permissible pressure or the pressure at which the maximum load can be carried by the tire. This pressure is normally higher than the manufacturer's recommended cold inflation pressure, which can be found on the Safety Compliance Certification Label (affixed to either the door hinge pillar, door-latch post, or the door edge that meets the door-latch post, next to the driver's seating position), or Tire Label which is located on the B-Pillar or the edge of the driver's door. The cold inflation pressure should never be set lower than the recommended pressure on the Safety Compliance Certification Label or Tire Label.

When weather temperature changes occur, tire inflation pressures also change. A 10°F (6°C) temperature drop can cause a corresponding drop of 1 psi (7 kPa) in inflation pressure. Check your tire pressures frequently and adjust them to the proper pressure which can be found on the Safety Compliance Certification Label or Tire Label.

To check the pressure in your tire(s):

1. Make sure the tires are cool, meaning they are not hot from driving even a mile.

**Note:** If you are checking tire pressure when the tire is hot (for example, driven more than 1 mile [1.6 kilometers]), never bleed or reduce air pressure. The tires are hot from driving and it is normal for pressures to increase above recommended cold pressures. A hot tire at or below recommended cold inflation pressure could be significantly under-inflated.

**Note:** If you have to drive a distance to get air for your tire(s), check and record the tire pressure first and add the appropriate air pressure when you get to the pump. It is normal for tires to heat up and the air pressure inside to go up as you drive.

2. Remove the cap from the valve on one tire, then firmly press the tire gauge onto the valve and measure the pressure.
3. Add enough air to reach the recommended air pressure.

**Note:** If you overfill the tire, release air by pressing on the metal stem in the center of the valve. Then recheck the pressure with your tire gauge.

4. Replace the valve cap.
5. Repeat this procedure for each tire, including the spare.

**Note:** Some spare tires operate at a higher inflation pressure than the other tires. For T-type mini-spare tires, see the *Dissimilar Spare Tire and Wheel Assembly Information* section. Store and maintain at 60 psi (4.15 bar). For full-size and dissimilar spare tires, see *Dissimilar Spare Tire and Wheel Assembly Information* under *Changing a Road Wheel* in this chapter. Store and maintain at the higher of the front and rear inflation pressure as shown on the Tire Label.

6. Visually inspect the tires to make sure there are no nails or other objects embedded that could poke a hole in the tire and cause an air leak.
7. Check the sidewalls to make sure there are no gouges, cuts or bulges.

### Inspecting Your Tires and Wheel Valve Stems

Periodically inspect the tire treads for uneven or excessive wear and remove objects such as stones, nails or glass that may be wedged in the tread grooves. Check the tire and valve stems for holes, cracks, or cuts that may permit air leakage and repair or replace the tire and replace the valve stem. Inspect the tire sidewalls for cracking, cuts, bruises and other signs of damage or excessive wear. If internal damage to the tire is suspected, have the tire demounted and inspected in case it needs to be repaired or replaced. For your safety, tires that are damaged or show signs of excessive wear should not be used because they are more likely to blow out or fail.

Improper or inadequate vehicle maintenance can cause tires to wear abnormally. Inspect all your tires, including the spare, frequently, and replace them if one or more of the following conditions exist:

#### Tire Wear

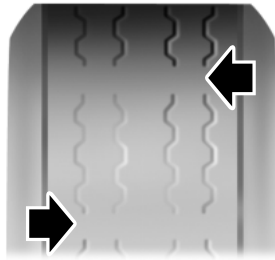

When the tread is worn down to 1/16th of an inch (2 millimeters), tires must be replaced to help prevent your vehicle from skidding and hydroplaning. Built-in treadwear indicators, or wear bars, which look like narrow strips of smooth rubber across the tread will appear on the tire when the tread is worn down to 1/16th of an inch (2 millimeters).

When the tire tread wears down to the same height as these wear bars, the tire is worn out and must be replaced.

**Damage**

Periodically inspect the tire treads and sidewalls for damage (such as bulges in the tread or sidewalls, cracks in the tread groove and separation in the tread or sidewall). If damage is observed or suspected, have the tire inspected by a tire professional. Tires can be damaged during off-road use, so inspection after off-road use is also recommended.

**WARNING: Age**

Tires degrade over time depending on many factors such as weather, storage conditions, and conditions of use (such as load, speed, inflation pressure) the tires experience throughout their lives. In general, tires should be replaced after six years regardless of tread wear. However, heat caused by hot climates or frequent high loading conditions can accelerate the aging process and may require tires to be replaced more frequently. You should replace your spare tire when you replace the road tires or after six years due to aging even if it has not been used.

**U.S. DOT Tire Identification Number**

Both U.S. and Canada Federal regulations require tire manufacturers to place standardized information on the sidewall of all tires. This information identifies and describes the fundamental characteristics of the tire and also provides a U.S. DOT Tire Identification Number for safety standard certification and in case of a recall.

This begins with the letters DOT and indicates that the tire meets all federal standards. The next two numbers or letters are the plant code designating where it was manufactured, the next two are the tire size code and the last four numbers represent the week and year the tire was built. For example, the numbers 317 mean the 31st week of 1997. After 2000 the numbers go to four digits. For example, 2501 means the 25th week of 2001. The numbers in between are identification codes used for traceability. This information is used to contact customers if a tire defect requires a recall.

**Tire Replacement Requirements**

**WARNING:** Only use replacement tires and wheels that are the same size, load index, speed rating and type (such as P-metric versus LT-metric or all-season versus all-terrain) as those originally provided by Ford. The recommended tire and wheel size may be found on either the Safety Compliance Certification Label (affixed to either the door hinge pillar, door-latch post, or the door edge that meets the door-latch post, next to the driver's seating position), or the Tire Label which is located on the B-Pillar or edge of the driver's door. If this information is not found on these labels, then you should contact your authorized dealer as soon as possible. Use of any tire or wheel not recommended by Ford can affect the safety and performance of your vehicle, which could result in an increased risk of loss of vehicle control, vehicle rollover, personal injury and death. Additionally the use of non-recommended tires and wheels could cause steering, suspension, axle, transfer case or power transfer unit failure. If you have questions regarding tire replacement, contact your authorized dealer as soon as possible.



**WARNING:** To reduce the risk of serious injury, when mounting replacement tires and wheels, you should not exceed the maximum pressure indicated on the sidewall of the tire to set the beads without additional precautions listed below. If the beads do not seat at the maximum pressure indicated, re-lubricate and try again. When inflating the tire for mounting pressures up to 20 psi (1.38 bar) greater than the maximum pressure on the tire sidewall, the following precautions must be taken to protect the person mounting the tire:

1. Make sure that you have the correct tire and wheel size.
2. Lubricate the tire bead and wheel bead seat area again.
3. Stand at a minimum of 12 feet (3.66 meters) away from the tire wheel assembly.
4. Use both eye and ear protection.

For a mounting pressure more than 20 psi (1.38 bar) greater than the maximum pressure, a Ford dealer or other tire service professional should do the mounting. Always inflate steel carcass tires with a remote air fill with the person inflating standing at a minimum of 12 feet (3.66 meters) away from the tire wheel assembly.

Your vehicle is equipped with tires designed to provide a safe ride and handling capability.

**Important:** Remember to replace the wheel valve stems when the road tires are replaced on your vehicle.

The two front tires or two rear tires should generally be replaced as a pair.

The tire pressure sensors mounted in the wheels (originally installed on your vehicle) are not designed to be used in aftermarket wheels.

The use of wheels or tires not recommended by Ford Motor Company may affect the operation of your tire pressure monitoring system.

If the tire pressure monitoring system indicator is flashing, the system is malfunctioning. Your replacement tire might be incompatible with your tire pressure monitoring system, or some component of the system may be damaged.

### Safety Practices



**WARNING:** If your vehicle is stuck in snow, mud, or sand, do not rapidly spin the tires. Spinning the tires can tear the tire and cause an explosion. A tire can explode in as little as three to five seconds.



**WARNING:** Do not spin the wheels at over 35 mph (56 km/h). The tires may fail and injure a passenger or bystander.

Driving habits have a great deal to do with your tire mileage and safety.

- Observe posted speed limits.
- Avoid fast starts, stops and turns.
- Avoid potholes and objects on the road.
- Do not run over curbs or hit the tire against a curb when parking.

**Highway Hazards**

No matter how carefully you drive, there is always the possibility that you may eventually have a flat tire on the highway. Drive slowly to the closest safe area out of traffic. This may further damage the flat tire, but your safety is more important.

If you feel a sudden vibration or ride disturbance while driving, or you suspect your tire or vehicle has been damaged, immediately reduce your speed. Drive with caution until you can safely pull off the road. Stop and inspect the tires for damage. If a tire is under-inflated or damaged, deflate it, remove the wheel and replace it with your spare tire and wheel. If you cannot detect a cause, have the vehicle towed to the nearest repair facility or tire dealer to have the vehicle inspected.

**Tire and Wheel Alignment**

A bad jolt from hitting a curb or pothole can cause the front end of your vehicle to become misaligned or cause damage to your tires. If your vehicle seems to pull to one side when you are driving, the wheels may be out of alignment. Have an authorized dealer check the wheel alignment periodically.

Wheel misalignment in the front or the rear can cause uneven and rapid treadwear of your tires and should be corrected by an authorized dealer. Front-wheel drive vehicles and those with an independent rear suspension may require alignment of all four wheels.

The tires should also be balanced periodically. An unbalanced tire and wheel assembly may result in irregular tire wear.

**Tire Rotation**

**Note:** If your tires show uneven wear ask an authorized dealer to check for and correct any wheel misalignment, tire imbalance or mechanical problem involved before tire rotation.

**Note:** Your vehicle may be equipped with a dissimilar spare tire and wheel assembly. A dissimilar spare tire and wheel assembly is defined as a spare tire or wheel that is different in brand, size or appearance from the road tires and wheels. If you have a dissimilar spare tire and wheel assembly, it is intended for temporary use only and should not be used in a tire rotation.

**Note:** After having your tires rotated, inflation pressure must be checked and adjusted to the vehicle requirements.

Rotating your tires at the recommended interval (as indicated in your scheduled maintenance information) will help your tires wear more evenly, providing better tire performance and longer tire life.

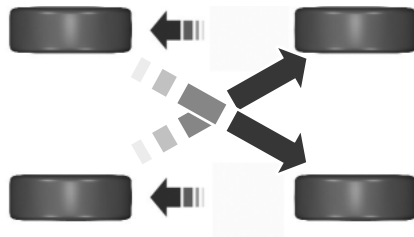

- Rear-wheel drive vehicles/Four-wheel drive vehicles (front tires at left of diagram)

Sometimes irregular tire wear can be corrected by rotating the tires.

### USING SNOW CHAINS



**WARNING:** Snow tires must be the same size, load index, speed rating as those originally provided by Ford. Use of any tire or wheel not recommended by Ford can affect the safety and performance of your vehicle, which could result in an increased risk of loss of vehicle control, vehicle rollover, personal injury and death. Additionally, the use of non-recommended tires and wheels could cause steering, suspension, axle, transfer case or power transfer unit failure.

**Note:** The suspension insulation and bumpers will help prevent vehicle damage. Do not remove these components from your vehicle when using snow tires and chains.

The tires on your vehicle have all-weather treads to provide traction in rain and snow. However, in some climates, you may need to use snow tires and chains. If you need to use chains, it is recommended that steel wheels (of the same size and specifications) be used, as chains may chip aluminum wheels.

Follow these guidelines when using snow tires and chains:

- If possible, avoid fully loading your vehicle.
- Use only cable type chains or chains offered by Ford as an accessory or equivalent. Other conventional link type chains may contact and cause damage to the vehicle's wheel house and/or body.
- Do not install chains on the front wheels as this may interfere with suspension components.
- Chains are not recommended for use on the P275/55R20 tire.
- Install chains securely, verifying that the chains do not touch any wiring, brake lines or fuel lines.
- Do not exceed 30 mph (48 km/h) with tire chains on your vehicle.
- Drive cautiously. If you hear the chains rub or bang against your vehicle, stop and retighten the chains. If this does not work, remove the chains to prevent damage to your vehicle.
- Remove the tire chains when they are no longer needed. Do not use tire chains on dry roads.

#### TIRE PRESSURE MONITORING SYSTEM



**WARNING:** The tire pressure monitoring system is NOT a substitute for manually checking tire pressure. The tire pressure should be checked periodically (at least monthly) using a tire gauge. See *Inflating Your Tires* in this chapter. Failure to properly maintain your tire pressure could increase the risk of tire failure, loss of control, vehicle rollover and personal injury.



Each tire, including the spare (if provided), should be checked monthly when cold and inflated to the inflation pressure recommended by the vehicle manufacturer on the vehicle placard or tire inflation pressure label. (If your vehicle has tires of a different size than the size indicated on the vehicle placard or tire inflation pressure label, you should determine the proper tire inflation pressure for those tires.)

As an added safety feature, your vehicle has been equipped with a tire pressure monitoring system (TPMS) that illuminates a low tire pressure telltale when one or more of your tires is significantly under-inflated. Accordingly, when the low tire pressure telltale illuminates, you should stop and check your tires as soon as possible, and inflate them to the proper pressure. Driving on a significantly under-inflated tire causes the tire to overheat and can lead to tire failure. Under-inflation also reduces fuel efficiency and tire tread life, and may affect the vehicle's handling and stopping ability.

Please note that the TPMS is not a substitute for proper tire maintenance, and it is the driver's responsibility to maintain correct tire pressure, even if under-inflation has not reached the level to trigger illumination of the TPMS low tire pressure telltale.

Your vehicle has also been equipped with a TPMS malfunction indicator to indicate when the system is not operating properly. The TPMS malfunction indicator is combined with the low tire pressure telltale. When the system detects a malfunction, the telltale will flash for approximately one minute and then remain continuously illuminated. This sequence will continue upon subsequent vehicle start-ups as long as the malfunction exists.

When the malfunction indicator is illuminated, the system may not be able to detect or signal low tire pressure as intended. TPMS malfunctions may occur for a variety of reasons, including the installation of replacement or alternate tires or wheels on the vehicle that prevent the TPMS from functioning properly. Always check the TPMS malfunction telltale after replacing one or more tires or wheels on your vehicle to ensure that the replacement or alternate tires and wheels allow the TPMS to continue to function properly.

The tire pressure monitoring system complies with part 15 of the FCC rules and with RSS-210 of Industry Canada. Operation is subject to the following two conditions: (1) This device may not cause harmful interference, and (2) This device must accept any interference received, including interference that may cause undesired operation.

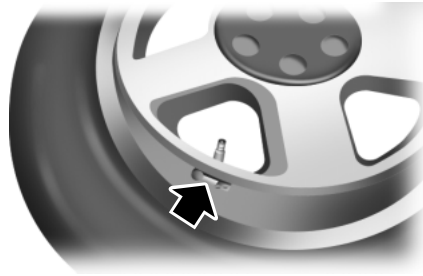
**Changing Tires with a Tire Pressure Monitoring System**

**Note:** Each road tire is equipped with a tire pressure sensor located inside the tire and wheel assembly cavity. The pressure sensor is attached to the valve stem. The pressure sensor is covered by the tire and is not visible unless the tire is removed. Take care when changing the tire to avoid damaging the sensor.

You should always have your tires serviced by an authorized dealer.

Check the tire pressure periodically (at least monthly) using an accurate tire gauge. See *Inflating Your Tires* in this chapter.

**Understanding Your Tire Pressure Monitoring System**

The tire pressure monitoring system measures pressure in your four road tires and sends the tire pressure readings to your vehicle. The low tire pressure warning light will turn on if the tire pressure is significantly low. Once the light is illuminated, your tires are under-inflated and need to be inflated to the manufacturer's recommended tire pressure. Even if the light turns on and a short time later turns off, your tire pressure still needs to be checked.

***When your temporary spare tire is installed***

When one of your road tires needs to be replaced with the temporary spare, the tire pressure monitoring system will continue to identify an issue to remind you that the damaged road wheel or tire needs to be repaired and put back on your vehicle.

To restore the full function of the tire pressure monitoring system, have the damaged road wheel or tire repaired and remounted on your vehicle. For additional information, see *Changing Tires with a Tire Pressure Monitoring System* in this section.

**When you believe your system is not operating properly**

The main function of the tire pressure monitoring system is to warn you when your tires need air. It can also warn you in the event the system is no longer capable of functioning as intended. See the following chart for information concerning your tire pressure monitoring system:

Low tire pressure warning light	Possible cause	Customer action required
Solid warning light	Tire(s) under-inflated	1. Make sure tires are at the proper pressure. See <i>Inflating your tires</i> in this chapter. 2. After inflating your tires to the manufacturer's recommended pressure as shown on the Tire Label (located on the edge of driver's door or the B-Pillar), the vehicle must be driven for at least two minutes over 20 mph (32 km/h) before the light turns off.
	Spare tire in use	Repair the damaged road wheel and tire and reinstall it on the vehicle to restore system function. For a description on how the system functions, see <i>When your temporary spare tire is installed</i> in this section.
	Tire pressure monitoring system malfunction	If the tires are properly inflated and the spare tire is not in use but the light remains on, contact your authorized dealer as soon as possible.
	Tire rotation without sensor training	On vehicles with different front and rear tire pressures, the system must be retrained following every tire rotation. See <i>Tire rotation</i> in this chapter.

Low tire pressure warning light	Possible cause	Customer action required
Flashing warning light	Spare tire in use	Repair the damaged road wheel and tire and reinstall it on the vehicle to restore system function. For a description on how the system functions, see <i>When your temporary spare tire is installed</i> in this section.
	Tire pressure monitoring system malfunction	If the tires are properly inflated and the spare tire is not in use but the light remains on, contact your authorized dealer as soon as possible.

#### ***When inflating your tires***

When putting air into your tires (such as at a gas station or in your garage), the tire pressure monitoring system may not respond immediately to the air added to your tires.

It may take up to two minutes of driving over 20 mph (32 km/h) for the light to turn off after you have filled your tires to the recommended inflation pressure.

#### ***How temperature affects your tire pressure***

The tire pressure monitoring system monitors tire pressure in each pneumatic tire. While driving in a normal manner, a typical passenger tire inflation pressure may increase approximately 2 to 4 psi (14 to 28 kPa) from a cold start situation. If the vehicle is stationary overnight with the outside temperature significantly lower than the daytime temperature, the tire pressure may decrease approximately 3 psi (21 kPa) for a drop of 30°F (17°C) in ambient temperature. This lower pressure value may be detected by the system as being significantly lower than the recommended inflation pressure and activate the system warning light for low tire pressure. If the low tire pressure warning light is on, visually check each tire to verify that no tire is flat. If one or more tires are flat, repair as necessary. Check air pressure in the road tires. If any tire is under-inflated, carefully drive the vehicle to the nearest location where air can be added to the tires. Inflate all the tires to the recommended inflation pressure.

**CHANGING A ROAD WHEEL**

**WARNING:** The use of tire sealants may damage your tire pressure monitoring system and should not be used. However, if you must use a sealant, have an authorized dealer install a new tire pressure monitoring system sensor and valve stem.



**WARNING:** See *Tire Pressure Monitoring System* in this chapter for important information. If the tire pressure monitoring sensor becomes damaged, it will no longer function.

**Note:** The tire pressure monitoring system indicator light will illuminate when the spare tire is in use. To restore the full function of the monitoring system, all road wheels equipped with tire pressure monitoring sensors must be mounted on this vehicle.

If you get a flat tire while driving, do not apply the brake heavily. Instead, gradually decrease your speed. Hold the steering wheel firmly and slowly move to a safe place on the side of the road.

Have a flat serviced by an authorized dealer in order to prevent damage to the system sensors. See *Tire Pressure Monitoring System* earlier in this chapter. Replace the spare tire with a road tire as soon as possible. During repairing or replacing of the flat tire, have the authorized dealer inspect the tire pressure monitoring system sensor for damage.

**Dissimilar Spare Tire and Wheel Assembly Information**

**WARNING:** Failure to follow these guidelines could result in an increased risk of loss of vehicle control, injury or death.

If you have a dissimilar spare tire and wheel assembly, then it is intended for temporary use only. This means that if you need to use it, you should replace it as soon as possible with a road tire and wheel assembly that is the same size and type as the road tires and wheels that were originally provided by Ford. If the dissimilar spare tire or wheel is damaged, it should be replaced rather than repaired.

A dissimilar spare tire and wheel assembly is defined as a spare tire or wheel that is different in brand, size or appearance from the road tires and wheels and can be one of three types:

1. **T-type mini-spares:** This spare tire begins with the letter T for tire size and may have Temporary Use Only molded in the sidewall.
2. **Full-size dissimilar spare with label on wheel:** This spare tire has a label on the wheel that states: THIS TIRE AND WHEEL FOR TEMPORARY USE ONLY

When driving with one of the dissimilar spare tires listed above, do not:

- exceed 50 mph (80 km/h).
- load the vehicle beyond maximum vehicle load rating listed on the Safety Compliance Label.
- tow a trailer.
- use snow chains on the end of the vehicle with the dissimilar spare tire.
- use more than one dissimilar spare tire at a time.
- use commercial car washing equipment.
- try to repair the dissimilar spare tire.

Use of one of the dissimilar spare tires listed above at any one wheel location can lead to impairment of the following:

- Handling, stability and braking performance
- Comfort and noise
- Ground clearance and parking at curbs
- Winter weather driving capability
- Wet weather driving capability
- All-wheel driving capability

### 3. **Full-size dissimilar spare without label on wheel**

When driving with the full-size dissimilar spare tire and wheel assembly, do not:

- exceed 70 mph (113 km/h).
- use more than one dissimilar spare tire and wheel at a time.
- use commercial car washing equipment.
- use snow chains on the end of the vehicle with the dissimilar spare tire and wheel.

The usage of a full-size dissimilar spare tire and wheel assembly can lead to impairment of the following:

- Handling, stability and braking performance
- Comfort and noise
- Ground clearance and parking at curbs
- Winter weather driving capability
- Wet weather driving capability
- All-wheel driving capability (if applicable)
- Load leveling adjustment (if applicable)

When driving with the full-size dissimilar spare tire and wheel assembly, additional caution should be given to:

- towing a trailer.
- driving vehicles equipped with a camper body.
- driving vehicles with a load on the cargo rack.

Drive cautiously when using a full-size dissimilar spare tire and wheel, and seek service as soon as possible.

#### Tire Change Procedure



**WARNING:** When one of the front wheels is off the ground, the transmission alone will not prevent the vehicle from moving or slipping off the jack, even if the transmission is in park (P).



**WARNING:** To help prevent the vehicle from moving when you change a tire, be sure to place the transmission in park (P), set the parking brake and block (in both directions) the wheel that is diagonally opposite (other side and end of the vehicle) to the tire being changed.



**WARNING:** Never get underneath a vehicle that is supported only by a jack. If the vehicle slips off the jack, you or someone else could be seriously injured.



**WARNING:** Do not attempt to change a tire on the side of the vehicle close to moving traffic. Pull far enough off the road to avoid the danger of being hit when operating the jack or changing the wheel.



**WARNING:** Always use the jack provided as original equipment with your vehicle. If using a jack other than the one provided as original equipment with your vehicle, make sure the jack capacity is adequate for the vehicle weight, including any vehicle cargo or modifications.



**WARNING:** Disable the power running boards before jacking, lifting, or placing any object under the vehicle. Never place your hand between the power running board and vehicle as extended power running boards will retract when the doors are closed. Failure to follow these instructions may result in personal injury.

**Note:** Passengers should not remain in the vehicle when the vehicle is being jacked.

Park on a level surface, activate the hazard flashers and set the parking brake. Then, place the transmission in park (P) and turn the engine off.

#### Location of the spare tire and tools

The spare tire and tools for your vehicle are stowed in the following locations:

Item	Location
Spare tire	Under the vehicle, just forward of the rear bumper
Jack tools	Under the access panel located in the floor compartment behind the rear seat

### Removing the jack and tools

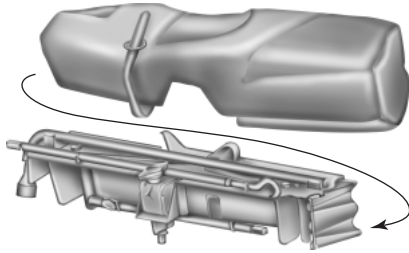

1. Open the liftgate, then locate the access panel on the floor behind the third row seat. Unlatch and remove the panel.
2. Remove the jack and tools assembly tray from the compartment by turning the wing-nut counterclockwise to relieve tension against the jack assembly tray. Remove the bag from the jack and tool assembly tray by loosening the strap.

**Note:** Pay close attention to the orientation of the bag, because it will have to be reinstalled after changing the tire.

3. Unsnap the wheel lug nut wrench, jack extension and handle from the plastic tray.
4. Remove the jack from the tray assembly.

### Removing the spare tire

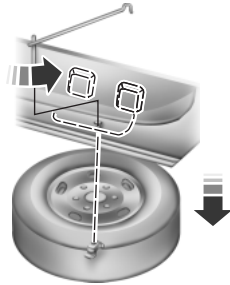

1. Remove the jack handle and winch extension from the tray and assemble them.
2. Open the spare tire winch access plug in the bottom of the compartment for the jack and tools tray.
3. Insert the winch extension tool assembly through the access hole in the floor and engage the winch.
4. To remove the spare tire, turn the handle counterclockwise until the tire is lowered to the ground and the cable is slightly slack.
5. Slide the retainer through the center of the spare tire wheel.

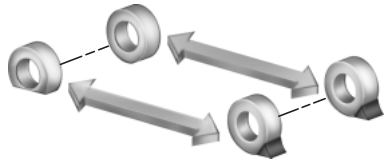

6. Block the wheels (both front or both rear) on the opposite end of the vehicle from the wheel being changed. If on a grade, block both wheels on the downward side of the hill.

7. Turn off the deployable running boards. See the *Driving Aids* chapter.
8. Obtain the spare tire and jack tools from their storage locations.
9. Use the tip of the jack handle to remove any wheel trim.
10. Loosen each wheel lug nut one-half turn counterclockwise but do not remove them until the wheel is raised off the ground.

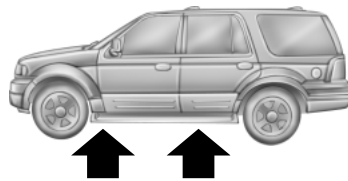

11. Position the jack according to the jack locator arrows found on the frame and turn the jack handle and extension tool assembly clockwise.  
**Note:** Use the frame rail as the jacking location point, not the control arm.

12. Raise the vehicle to provide sufficient ground clearance when installing the spare tire; about 1/4 inch (6 millimeters).

- Front

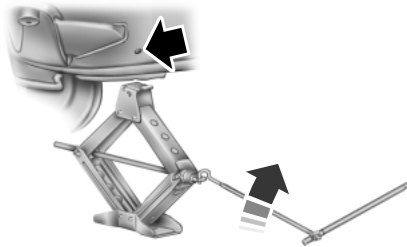

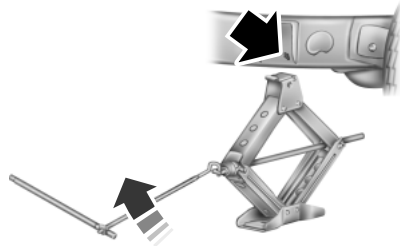

- Rear

• **Note:** Jack at the specified locations to avoid damage to the vehicle.

13. Remove the lug nuts with the lug wrench.
14. Replace the flat tire with the spare tire, making sure the valve stem is facing outward.
15. Reinstall the lug nuts until the wheel is snug against the hub. Do not fully tighten the lug nuts until the wheel has been lowered.
16. Lower the wheel by turning the jack handle counterclockwise.

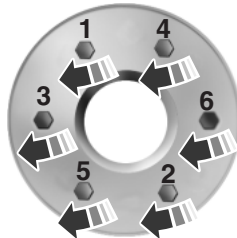

17. Remove the jack and fully tighten the lug nuts in the order shown and reinstall the wheel cover. See *Wheel Lug Nut Torque Specifications* later in this chapter for the proper lug nut torque specification.

18. Unblock the wheels.
19. Put flat tire, jack, lug wrench and tools away. Make sure the jack bag is properly reinstalled around the jack and tools assembly tray with the strap securely fastened. Be sure to tighten the wing nut sufficiently so it does not rattle when you drive.

**Stowing the Spare Tire**

1. Lay the tire on the ground, near the rear of the vehicle, with the valve stem side facing up.

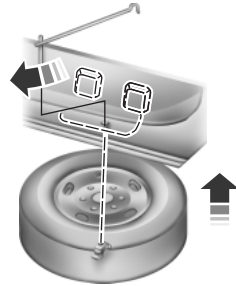

2. Slide the wheel partially under the vehicle and install the retainer through the wheel center. If equipped, you may have to remove the wheel center cap prior to pushing the retainer through the center of the wheel. To remove the center cap, press it off with the jack tool from the inner side of the wheel. Pull on the cable to align the components at the end of the cable.

3. Assemble the jack handle and winch extension (as shown in illustration), then insert the winch extension through the access hole behind the third row seat and engage the winch.

4. Turn the jack handle clockwise until the tire is raised to its stowed position underneath the vehicle. The wrench will become harder to turn and the spare tire winch will ratchet or slip when the tire is raised to maximum tightness. A clicking sound will be heard from the winch indicating that the tire is properly stowed.

5. Disassemble the jack tool and winch extension and snap them back into the tool tray.

6. Reinstall the jack bag properly around the jack and tool assembly tray, making sure the strap is securely fastened.

7. Close the access hole with the rubber plug.

8. Reinstall the tray into the vehicle and secure it with the wing nut (turn clockwise until tight).

**TECHNICAL SPECIFICATIONS**

**Wheel Lug Nut Torque Specifications**

**!** **WARNING:** When a wheel is installed, always remove any corrosion, dirt or foreign materials present on the mounting surfaces of the wheel or the surface of the wheel hub, brake drum or brake disc that contacts the wheel. Make sure that any fasteners that attach the rotor to the hub are secured so they do not interfere with the mounting surfaces of the wheel. Installing wheels without correct metal-to-metal contact at the wheel mounting surfaces can cause the wheel nuts to loosen and the wheel to come off while the vehicle is in motion, resulting in loss of control.

Retighten the lug nuts to the specified torque within 100 miles (160 kilometers) after any wheel disturbance (such as rotation, flat tire, wheel removal).

Bolt size	Wheel lug nut torque*	
	ft-lb	N•m
M14 x 2.0	150	200

\* Torque specifications are for nut and bolt threads free of dirt and rust. Use only Ford recommended replacement fasteners.



**Note:** Inspect the wheel pilot hole and mounting surface prior to installation. Remove any visible corrosion or loose particles.

## 316 Capacities and Specifications

### ENGINE SPECIFICATIONS

Engine	5.4L V8 Engine
Cubic inches	330
Fuel	Minimum 87 octane or (E-85)
Firing order	1-3-7-2-6-5-4-8
Ignition system	Coil on plug
Spark plug gap	0.039-0.043 inch (1.05 +/- 0.05 mm)
Compression ratio	9.8:1

### Engine Drivebelt Routing

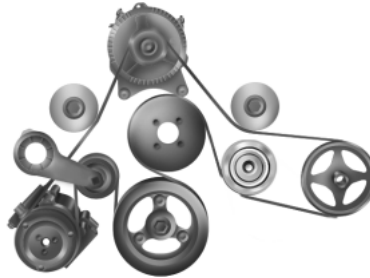

**TECHNICAL SPECIFICATIONS**

Item	Capacity	Ford part name	Ford part number / Ford specification
Brake fluid <sup>1</sup>	Between MIN and MAX on reservoir	Motorcraft High Performance DOT 4 LV Motor Vehicle Brake Fluid	PM-20 / WSS-M6C65-A2
Hinges, latches, striker plates and rotors, seat tracks, fuel filler door hinge and spring	—	Multi-Purpose Grease (Lithium grease)	Motorcraft XL-5 (aerosol) / CRC SL3151ESB / ESB-M1C93-B
Lock cylinders	—	Motorcraft Penetrating and Lock Lubricant	XL-1 / None
Engine coolant <sup>2</sup>	Base radiator without auxiliary rear heat 16.4 qt (15.5L)	Motorcraft Orange Antifreeze/Coolant Prediluted	VC-3DIL-B (US) CVC-3DIL-B (Canada) / WSS-M97B44-D2
	Heavy duty trailer without auxiliary rear heat 16.9 qt (16.0L)		
	Base radiator with auxiliary rear heat 19.0 quarts (18.0L)		
	Heavy duty trailer tow radiator with auxiliary rear heat 19.5 qt (18.5L)		

Item	Capacity	Ford part name	Ford part number / Ford specification
Engine oil <sup>3,4,5</sup>	7.0 qt (6.6L)	Motorcraft SAE 5W-20 Motor Oil	XO-5W20-QSP WSS-M2C945-A
Automatic transmission fluid (6R80) <sup>6,7</sup>	13.1 qt (12.4L)	Motorcraft MERCON LV ATF	XT-10-QLV / MERCEN LV
Power steering fluid	Fill between MIN and MAX lines on reservoir	Motorcraft MERCON LV ATF	XT-10-QLV / MERCEN LV
Front axle fluid (Four Wheel Drive)	3.5 pt (1.7L)	Motorcraft SAE 80W-90 Premium Rear Axle Lube	XY-80W90-QL / WSP-M2C197-A
Rear axle fluid (9.75 inch axle) <sup>8</sup>	4.5 pt (2.1L)	Motorcraft SAE 75W-140 Synthetic Rear Axle Lube	XY-75W140-QL (US); CXY-75W140-1L (Canada) / WSL-M2C192-A
Transfer case fluid	Four Wheel Drive Electronic Shift On Fly 1.6 - 1.8 qt (1.5 - 1.7L)	Motorcraft Transfer Case Fluid	XL-12 / ESP-M2C166-H
	Four Wheel Drive Torque On Demand 1.5 qt (1.4L)	Motorcraft MERCON LV ATF	XT-10-QLV / MERCEN LV

Item	Capacity	Ford part name	Ford part number / Ford specification
Windshield washer fluid	Fill as required	Motorcraft Premium Windshield Washer Concentrate with Bitterant (US); Premium Quality Windshield Washer Fluid (Canada)	ZC-32-B2 (US) CXC-37-(A, B, D, and F) (Canada) / WSB-M8B16-A2/- -
Fuel tank	Standard 28.0 gal (106.0L)	—	—
	Navigator L 33.5 gal (126.8L)	—	—
A/C Refrigerant <sup>9</sup>	2.25 lb (1.02 kg)	Motorcraft R134a Refrigerant	YN-19 (US) CYN-16-R (Canada) / WSH-M17B19-A
A/C Refrigerant Compressor Oil <sup>9</sup>	8 fl oz (236 ml)	Motorcraft PAG Refrigerant Compressor Oil	YN-12-D / WSH-M1C231-B

<sup>1</sup>Ford recommends using Motorcraft (Ford) DOT 4 LV High Performance Brake Fluid or equivalent meeting WSS-M6C65-A2. Use of any fluid other than the recommended fluid may cause degraded brake performance and not meet the Ford performance standards. Keep brake fluid clean and dry. Contamination with dirt, water, petroleum products or other materials may result in brake system damage and possible failure.

<sup>2</sup>Add the coolant type originally equipped in your vehicle.

<sup>3</sup>We have designed your engine to use Motorcraft motor oils or equivalent oil brands that meet our specifications. Motor oils of the recommended viscosity grade that meet API SN requirements and display the API Certification Mark for gasoline engines are also acceptable.

<p><sup>1</sup>Ford recommends using Motorcraft (Ford) DOT 4 LV High Performance Brake Fluid or equivalent meeting WSS-M6C65-A2. Use of any fluid other than the recommended fluid may cause degraded brake performance and not meet the Ford performance standards. Keep brake fluid clean and dry. Contamination with dirt, water, petroleum products or other materials may result in brake system damage and possible failure.</p>
<p><sup>4</sup>Do not use API S category oils labeled as SN, SM,SL or lower category unless the label also displays the API certification mark. These oils do not meet all of the requirements of the engine and emission systems.</p>
<p><sup>5</sup>Do not use supplemental engine oil additives in your engine. They are unnecessary and could lead to engine damage that is not covered by your Ford warranty.</p>
<p><sup>6</sup>Automatic transmissions that require MERCON LV should only use MERCON LV fluid. Refer to <i>scheduled maintenance information</i> to determine the correct service interval. Use of any fluid other than the recommended fluid may cause transmission damage.</p>
<p><sup>7</sup>Indicates only approximate dry-fill capacity. Some applications may vary based on cooler size and if equipped with an in-tank cooler.</p>
<p><sup>8</sup>Your vehicle's rear axle is filled with a synthetic rear axle lubricant and is considered lubricated for life. These lubricants are not to be checked or changed unless a leak is suspected, service is required or the axle has been submerged in water. The axle lubricant should be changed any time the axle has been submerged in water.</p>
<p><sup>9</sup><b>Warning:</b> The air conditioning refrigerant system contains refrigerant R-134a under high pressure. Opening and air conditioning refrigerant system can cause personal injury. Only qualified personnel should service the air conditioning refrigerant system.</p>

**MOTORCRAFT® PART NUMBERS**

Component	5.4L V8 engine
Air filter element	FA-1883
Battery	BXT-65-650 or BXT-65-750 (if equipped)
Oil filter	FL-820-S
Spark plugs <sup>1</sup>	HJFS24FP/SP-509
Seat filter (if equipped)	FS-104
Windshield wiper blade	WW-2201-PF WW-1601-PF (rear)

<sup>1</sup>Refer to *scheduled maintenance information* for the appropriate intervals for changing the spark plugs.

**Note:** Replace the spark plugs with ones that meet Ford material and design specifications for your vehicle, such as Motorcraft® or equivalent replacement parts. The customer warranty may be void for any damage to the engine if such spark plugs are not used.

**VEHICLE IDENTIFICATION NUMBER**

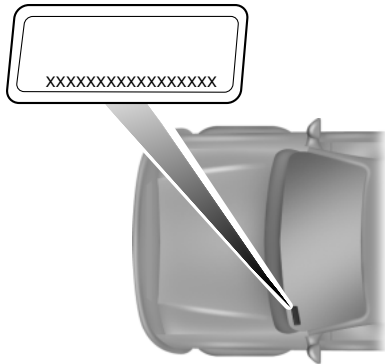

The vehicle identification number is located on the driver's side instrument panel.

Please note that in the graphic, XXXX is representative of your vehicle identification number.



**TRANSMISSION CODE DESIGNATION**

You can find a transmission code on the Safety Compliance Certification Label. The following table tells you which transmission each code represents.

MFD. BY FORD MOTOR CO.

DATE: XX/XX GVWR: XXXX KG (XXXX LB)  
 FRONT GAWR: REAR GAWR:  
 XXXX KG (XXXX LB) WITH XXXX KG (XXXX LB) WITH  
 XXXXXXXXXXXXXXXX TRES XXXXXXXXXXXXXXXX TRES  
 XXXXXXX RIMS XXXXXXX RIMS  
 AT XXXX kPa/ XXX PSI COLD AT XXXX kPa/ XXX PSI COLD

THIS VEHICLE CONFORMS TO ALL APPLICABLE FEDERAL MOTOR VEHICLE SAFETY AND THEFT PREVENTION STANDARDS IN EFFECT ON THE DATE OF MANUFACTURE SHOWN ABOVE.

VIN: XXXXXXXXXXXXXXXXXXXX XXXXX  
 TYPE: XXXX XXXXX



EXT PNT: XX XXXXXX IRC: XY DSO: XXXX  
 WB INT TR T/P/PS R AXLE TR SPR XXXX  
 XXX XX XXX X XX X XXXX XXXX  
 XXXXXXXXXXXXXXXX XX XXXX-XXXXXXXX-XX

↑

Description	Code
Six-speed automatic (6R80)	6

**ACCESSORIES**

For a complete listing of the accessories that are available for your vehicle, please contact an authorized dealer or visit our online store at: **www.Accessories.Lincoln.com** (United States only).

Lincoln Motor Company will repair or replace any properly authorized dealer-installed Lincoln Genuine Accessories found to be defective in factory-supplied materials or workmanship during the warranty period, as well as any component damaged by the defective accessories.

Lincoln Motor Company will warrant your vehicle through the warranty that provides the greatest benefit:

- 24 months, unlimited mileage.
- The remainder of your new vehicle limited warranty.

Contact an authorized dealer for details and a copy of the warranty.

**Exterior style**

- Chrome hood accent
- Splash guards
- Deflectors

**Interior style**

- Ambient lighting
- Illuminated door sill plates
- Floor mats

**Lifestyle**

- SUV camping tent\*
- Racks and carriers\*
- Cargo organization and management
- Rear seat entertainment\*
- Towing accessories

**Peace of mind**

- Remote start
- Forward bumper mounted warning sensors\*
- Locking gas plug for capless fuel system
- Vehicle security systems
- Vehicle cover\*
- Wheel locks

\*The accessory manufacturer designs, develops and therefore warrants Lincoln Licensed Accessories, and does not design or test these accessories to Lincoln Motor Company engineering requirements. Contact an authorized Lincoln dealer for the manufacturer's limited warranty details, and request a copy of the Lincoln Licensed Accessories product limited warranty from the accessory manufacturer.

For maximum vehicle performance, keep the following information in mind when adding accessories or equipment to your vehicle:

- When adding accessories, equipment, passengers and luggage to your vehicle, do not exceed the total weight capacity of the vehicle or of the front or rear axle (GVWR or GAWR as indicated on the Safety Compliance Certification label). Ask an authorized dealer for specific weight information.
- The Federal Communications Commission (FCC) and Canadian Radio Telecommunications Commission (CRTC) regulate the use of mobile communications systems that are equipped with radio transmitters, for example, two-way radios, telephones and theft alarms. Any such equipment installed in your vehicle should comply with Federal Communications Commission (FCC) and Canadian Radio Telecommunications Commission (CRTC) regulations and should be installed only by an authorized dealer.
- An authorized dealer needs to install mobile communications systems. Improper installation may harm the operation of your vehicle, particularly if their manufacturer did not design the mobile communication device specifically for automotive use.
- If you or an authorized Lincoln dealer add any non-Lincoln electrical or electronic accessories or components to the vehicle, you may adversely affect battery performance and durability. In addition, you may adversely affect the performance of other electrical systems in the vehicle.

**Extended Service Plan (ESP)**

PROTECT YOURSELF FROM THE RISING COST OF VEHICLE REPAIRS WITH A LINCOLN EXTENDED SERVICE PLAN.

**SERVICE PLANS (U.S. Only)**

Lincoln owners have discovered the powerful protection of Lincoln Extended Service Plan. It is the only extended service plan backed by Lincoln Motor Company, and provides peace of mind protection beyond the New Vehicle Limited Warranty coverage.

**Lincoln ESP Can Quickly Pay for Itself**

One service bill – the cost of parts and labor – can easily exceed the price of your Lincoln Extended Service Plan. With Lincoln ESP, you minimize your risk for unexpected repair bills and rising repair costs.

**Up to 1000+ Covered Vehicle Components**

There are four Extended Service Plans with different levels of coverage. Ask your authorized dealer for details.

1. PremiumCARE - Our most comprehensive coverage. With over 1000 covered components, this plan is so complete that we generally only discuss what's not covered.
2. ExtraCARE - Covers 113 components, and includes many high-tech items.
3. BaseCARE - Covers 84 components.
4. PowertrainCARE - Covers 29 critical components.

Lincoln Extended Service Plan is honored by all authorized Lincoln and Ford dealers in the U.S. and Canada. It is the only extended service plan authorized and backed by Lincoln Motor Company.

That means you get:

- Reliable, quality service at any Lincoln or Ford dealership.
- Repairs performed by factory trained technicians, using genuine parts.

**Rental Car Reimbursement***1st Day Rental Benefit*

You take advantage of replacement transportation if your vehicle is at your authorized dealer for same day covered repairs.

*Extended Rental Benefits*

If your vehicle is kept overnight for covered repairs, you are eligible for rental car coverage, including bumper to bumper warranty repairs, and Field Service Actions.

**Roadside Assistance**

Exclusive 24/7 roadside assistance, including:

- Towing, flat-tire change and battery jump starts.
- Out of fuel and lock-out assistance.
- Travel expense reimbursement for lodging, meals and rental car.
- Destination assistance for taxi, shuttle, rental car coverage and emergency transportation.

**Transferable Coverage**

If you sell your vehicle before your Lincoln Extended Service Plan coverage expires, you can transfer any remaining coverage to the new owner. Whenever you sell your vehicle, prospective buyers may have a higher degree of confidence that vehicle was properly maintained with Lincoln ESP, thereby improving resale value.

**Avoid the Rising Cost of Properly Maintaining Your Vehicle!**

Lincoln Extended Service Plan also offers a Premium Maintenance Plan that covers all scheduled maintenance, and select items that routinely wear out. The coverage is prepaid, so you never have to worry about affording your vehicle maintenance. It covers regular checkups, routine inspections, preventive care and replacement of select items that require periodic attention for normal wear:

- Windshield wiper blades.
- Spark plugs (except in California).
- The clutch disc.
- Brake pads and linings.
- Shock absorbers.
- Belts and hoses.
- Diesel exhaust fluid replenishment.

**Interest Free Finance Options Available**

Take advantage of our interest free installment payment plan. Just a 10% down payment will provide you with an affordable, no interest, no fee payment program allowing you all the security and benefits Lincoln ESP has to offer while paying over time. You are pre-approved with no credit checks, no hassles! To learn more, call our Lincoln ESP specialists at 800-367-3377.

Lincoln ESP  
P.O. Box 8072  
Royal Oak, MI 48068-0039

**SERVICE PLANS (CANADA ONLY)**

You can get more protection for your vehicle by purchasing a Lincoln Extended Service Plan. Lincoln Extended Service Plan is the only service contract backed by Lincoln Motor Company of Canada, Limited. Depending on the plan you purchase, Lincoln Extended Service Plan provides benefits such as:

- Rental reimbursement.
- Coverage for certain maintenance and wear items.
- Protection against repair costs after your New Vehicle Limited Warranty Coverage expires.
- Roadside Assistance benefits.

There are several Lincoln Extended Service Plans available in various time, distance and deductible combinations. Each plan is tailored to fit your own driving needs, including reimbursement for towing and rental. When you purchase Lincoln Extended Service Plan, you receive added peace-of-mind protection throughout Canada and the United States, provided by a network of participating authorized Lincoln Motor Company dealers.

**Note:** *Repairs performed outside of Canada and the United States are not eligible for Lincoln Extended Service Plan coverage.*

This information is subject to change. For more information, visit your local Lincoln of Canada dealer or [www.lincoln.ca](http://www.lincoln.ca) to find the Lincoln Extended Service Plan that is right for you.

**GENERAL INFORMATION**

**Radio Frequencies and Reception Factors**

AM and FM frequencies are established by the Federal Communications Commission (FCC) and the Canadian Radio and Telecommunications Commission (CRTC). Those frequencies are:

AM: 530, 540–1700, 1710 kHz

FM: 87.9–107.7, 107.9 MHz

Radio reception factors	
<b>Distance and strength</b>	The further you travel from an FM station, the weaker the signal and the weaker the reception.
<b>Terrain</b>	Hills, mountains, tall buildings, bridges, tunnels, freeway overpasses, parking garages, dense tree foliage and thunderstorms can interfere with the reception.
<b>Station overload</b>	When you pass a ground-based broadcast repeating tower, a stronger signal may overtake a weaker one and result in the audio system muting.

**CD and CD Player Information**

**Note:** CD units play commercially pressed 4.75-inch (12 centimeter) audio compact discs only. Due to technical incompatibility, certain recordable and re-recordable compact discs may not function correctly when used in Ford CD players.

**Note:** Do not insert CDs with homemade paper (adhesive) labels into the CD player as the label may peel and cause the CD to become jammed. You should use a permanent felt tip marker rather than adhesive labels on your homemade CDs. Ballpoint pens may damage CDs. Please contact your authorized dealer for further information.

**Note:** Do not use any irregularly shaped discs or discs with a scratch protection film attached.

Always handle discs by their edges only. Clean the disc with an approved CD cleaner only. Wipe it from the center of the disc toward the edge. Do not clean in a circular motion.

Do not expose discs to direct sunlight or heat sources for extended periods.

**MP3 Track and Folder Structure**

Audio systems capable of recognizing and playing MP3 individual tracks and folder structures work as follows:

- There are two different modes for MP3 disc playback: MP3 track mode (system default) and MP3 folder mode.
- MP3 track mode ignores any folder structure on the MP3 disc. The player numbers each MP3 track on the disc (noted by the .mp3 file extension) from T001 to a maximum of T255. **Note:** The maximum number of playable MP3 files may be less depending on the structure of the CD and exact model of radio present.
- MP3 folder mode represents a folder structure consisting of one level of folders. The CD player numbers all MP3 tracks on the disc (noted by the .mp3 file extension) and all folders containing MP3 files, from F001 (folder) T001 (track) to F253 T255.
- Creating discs with only one level of folders helps with navigation through the disc files.

If you are burning your own MP3 discs, it is important to understand how the system reads the structures you create. While various files may be present, (files with extensions other than mp3), only files with the .mp3 extension are played; other files are ignored by the system. This enables you to use the same MP3 disc for a variety of tasks on your work computer, home computer and your in-vehicle system.

In track mode, the system displays and plays the structure as if it were only one level deep (all .mp3 files play, regardless of being in a specific folder). In folder mode, the system only plays the .mp3 files in the current folder.

## AM/FM/CD WITH SYNC®

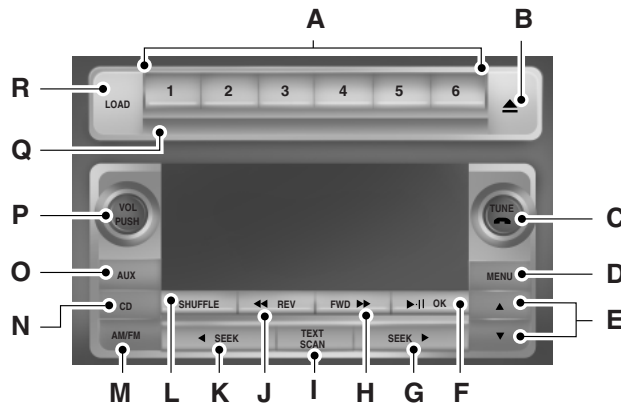

**WARNING:** Driving while distracted can result in loss of vehicle control, crash and injury. We strongly recommend that you use extreme caution when using any device that may take your focus off the road. Your primary responsibility is the safe operation of your vehicle. We recommend against the use of any hand-held device while driving and encourage the use of voice-operated systems when possible. Make sure you are aware of all applicable local laws that may affect the use of electronic devices while driving.

**A. Memory presets:**

- In radio mode, store your favorite radio stations. To store a radio station, tune to the station, then press and hold a preset button until sound returns.
- In satellite radio mode, store up to six stations on each satellite band.

**B. Eject:**

- Press this button to eject the current CD.
- To eject a specific CD, press this button, then the corresponding memory preset button.
- Press and hold this button to eject all CDs.

**C. TUNE and Phone:**

- In radio mode, turn the control to manually search the frequency band.
- In MP3 mode, turn the control to go to the next or previous folder (when folder mode is active).

- In satellite radio mode, press the **SEEK** buttons to tune to the next or previous channel.
- In category mode, turn the control to scroll through the list of available satellite radio categories.
- In phone mode, press this button to access the phone features of the SYNC system. See the *SYNC*® chapter for more information.

D. **MENU:** Press this button to access different audio system features. You can also adjust settings for the family entertainment system if your vehicle is equipped with this feature.

- If your vehicle is equipped with satellite radio, you can access different menus by pressing **OK**.
- Set the time by pressing **MENU** until **SET HOURS** or **SET MINUTES** appears and using the arrow buttons to adjust the time.
- Set the strongest stations on the radio frequency by pressing **MENU** until **AUTOSET** appears. **AUTOSET** does not override your original presets.
- **RBDS** displays text transmitted by certain radio stations and searches for music categories. To search for music categories, turn on RBDS (by using the **SEEK** buttons when **RBDS ON/OFF** appears). Press the up and down arrow buttons to scroll through categories, then use the **SEEK** buttons to begin the search.
- **SPEEDVOL** (speed compensated volume) allows you to adjust radio volume to compensate for noise levels when vehicle speed increases.
- **Track/Folder** is only available on MP3 files when in CD mode. In track mode, pressing the **SEEK** arrows allows you to scroll through all the tracks on the disc. In folder mode, pressing the **SEEK** arrows allows you to scroll through all the tracks within the selected folder. Press the **FOLDER** buttons to access other folders.
- **COMPRESS** (Compression) is only available in CD and MP3 modes. Switching compression on brings the soft and loud passages together for a more consistent listening level. Use the **SEEK** buttons and up and down arrow buttons to switch it on and off.
- Family entertainment options are also available, if your vehicle is equipped with this feature.

E. **Up and down arrow buttons:** Press these buttons to make selections in **MENU** mode.

F. **Play, Pause and OK:**

- Play and Pause allow you to play or pause a track when listening to a CD.
- **OK** allows you to confirm commands with phone and media features of the SYNC system. See the *SYNC*® chapter for more information.

**G. SEEK:**

- In radio mode, press and release this button to go to the next preset radio station or disc track.
- In CD and MP3 modes, press this button to select the next track, or press and hold to advance within the same track.

H. **FWD:** Press this button to manually fast forward in a CD track or MP3 file.

**I. TEXT/SCAN:**

- In radio and CD/MP3 mode, press and hold to hear a brief sampling of radio stations, CD tracks or MP3 files.
- In CD/MP3 mode, press and release to display track title, artist name and disc title.

**Note:** In text mode, sometimes the display requires additional text to be displayed. When the > or < indicator is present, press the SEEK arrows to view the additional text.

J. **REV:** Press this button to manually rewind in a CD track or MP3 file.

**K. SEEK:**

- In radio mode, press and release this button to go to the previous preset radio station or disc track.
- In CD and MP3 modes, press this button to select the previous track, or press and hold to reverse within the same track.

L. **SHUFFLE:** Play music on the selected CD or MP3 folder in random order.

M. **AM/FM:** Press this button to select a frequency band.

N. **CD:** Press this button to enter CD or MP3 mode.

O. **AUX:** Press this button to access the media features of the SYNC® system. See the SYNC® chapter for more information.

**P. VOL-PUSH:**

- Press this button to switch the system off and on.
- Turn it to adjust the volume.

Q. **CD slot:** Insert a CD.

R. **LOAD:** Load a CD.

- Press LOAD and a memory preset button to load a CD to a specific slot.
- Press and hold to autoloading up to six CDs. The last disc inserted automatically plays.

**REAR AUDIO CONTROLS**

Your vehicle is equipped with rear seat audio controls. This allows front and middle seat passengers to listen to different media sources (radio, CD or SYNC) simultaneously.

**Note:** The front and middle seat passengers cannot listen to two different radio stations at the same time.

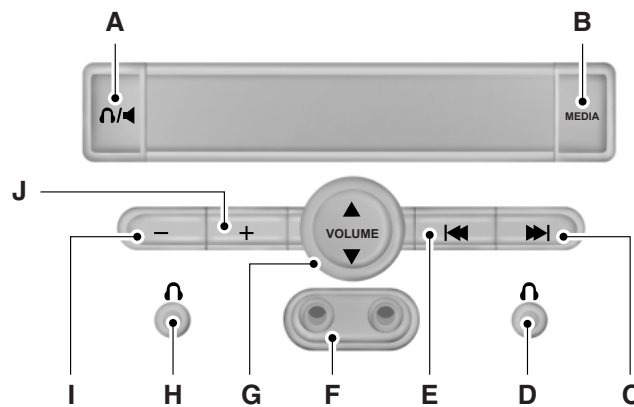

**A. Headphone/Speaker** Press this button to turn the rear speakers on (Single Play mode) or off (Dual Play mode).

**B. MEDIA** Press this button to scroll through available playing media, such as AM, FM1, FM2, CD, SAT1, SAT2, SAT3, and SYNC.

- If in Dual Play mode, **SHARED** illuminates in the audio display when the front and rear modes are set to the same media.
- If you select SYNC, press **+** or **-** to scroll through the different options: SYNC USB, SYNC BTST and SYNC LINE. See the *SYNC* chapter for more information.

**C. Right arrow button**

- In radio mode, press and release this button to scroll through memory presets. Press and hold to go to the next station.
- In CD and SYNC modes, press and release this button to go to the next track. Press and hold to fast forward within that track.

**D. Wired headphone jack**

**E. Left arrow button**

- In radio mode, press and release this button to scroll through memory presets. Press and hold to go to the previous station
- In CD and SYNC modes, press and release this button to advance to the previous track. Press and hold to rewind within that track.

**F. Auxiliary audio input jacks:** Plug in and play auxiliary audio sources.

**G. VOLUME** Press the up and down arrow buttons to increase or decrease the headphone volume level. From the rear seat controls, the volume cannot be higher than the current audio setting unless the speakers are off.

**H. Wired headphone jack**

I. - Press the button to access the previous CD.

J. + Press to access the next CD.

**Switching the Rear Audio Controls On**

After you switch the ignition on, FULL rear controls are on and the system is in Single Play mode.

**Parental Control**

The multimedia system allows for three varying levels of parental control. By simultaneously pressing the 3 and 5 memory preset buttons, the rear passengers may be allowed to access FULL or LOCAL control or be LOCKED out of rear seat controls altogether.

1. Press the 3 and 5 memory preset buttons at the same time. LOCAL illuminates in both front and rear audio displays, indicating that only LOCAL rear control is available. **Note:** While in Single Play mode, LOCAL is the same as LOCKED. In Dual Play mode, LOCAL allows the driver to control the media selected at the radio, or over media played through the rear auxiliary input jacks.
2. Pressing the 3 and 5 buttons a second time locks the rear control. The rear passengers are restricted from control over media of any kind (the rear controls are disabled). **Note:** If in Dual Play mode, the headphone icon normally illuminated in the audio display when in Dual Play turns off in the audio display.
3. Pressing the 3 and 5 buttons a third time restores full control to the rear seat controls. Switching the ignition off and then on again has the same effect.

**Switching Dual Play Mode On**

You can switch Dual Play mode on by simultaneously pressing the 2 and 4 memory preset buttons on the audio or by doing the following:

1. Press the headphone/speaker control. The headphone icon illuminates in both front and rear audio displays indicating the rear seat speakers are off and the headphones are on.
2. Press MEDIA to change audio sources (as heard in the headphones only).
3. Use the other controls to adjust the playing media.

**Switching Off Dual Play Mode**

Use any one of the following to switch off Dual Play mode:

- Press the 2 and 4 memory preset buttons simultaneously again.
- Press the 3 and 5 memory preset buttons simultaneously to LOCK the rear seat controls.
- Press the headphone/speaker button again.

**Using Dual Play Mode with Headphones**

**WARNING:** Do not leave children unattended in your vehicle and do not let children operate the system while unsupervised. If wired headphones or auxiliary systems are used, children may become entangled in the cords and seriously injure themselves.

Plug a 1/8-inch (3.5 millimeter) headphone (not included) into the headphone jack. Press the speaker button, or the 2 and 4 memory preset buttons simultaneously on the radio to switch on the headphones. DUAL PLAY illuminates in the audio display, there is no sound from the rear speakers and the fade control is inactive, signaling that Dual Play is on.

The front speakers remain on for the front passengers. Press the speaker button, or the 2 and 4 memory preset buttons simultaneously on the radio again to switch off the headphones and Dual Play mode. SINGLE PLAY illuminates in the audio display; fade control is active and there is sound from rear speakers, signaling that Single Play is on.

You need to switch the rear seat controls on to use any rear controls (whether in Single Play or Dual Play mode). To use Dual Play, switch on the rear seat controls; the headphone icon illuminates in the audio display. See *Switching the rear audio controls on* previously.

**SATELLITE RADIO INFORMATION (IF EQUIPPED)**

**Satellite Radio Channels**

Sirius broadcasts a variety of music, news, sports, weather, traffic and entertainment satellite radio channels. For more information and a complete list of Sirius satellite radio channels, visit [www.siriusxm.com](http://www.siriusxm.com) in the United States, [www.sirius.ca](http://www.sirius.ca) in Canada, or call Sirius at 1-888-539-7474.

**Note:** This receiver includes the eCos real-time operating system. eCos is published under the eCos License.

**Satellite Radio Reception Factors**

<b>Potential satellite radio reception issues</b>	
<b>Antenna obstructions</b>	For optimal reception performance, keep the antenna clear of snow and ice build-up and keep luggage and other material as far away from the antenna as possible.
<b>Terrain</b>	Hills, mountains, tall buildings, bridges, tunnels, freeway overpasses, parking garages, dense tree foliage and thunderstorms can interfere with your reception.
<b>Station overload</b>	When you pass a ground-based broadcast-repeating tower, a stronger signal may overtake a weaker one and the audio system may mute.
<b>Satellite radio signal interference</b>	Your display may show ACQUIRING . . . to indicate the interference and the audio system may mute.

**Sirius Satellite Radio Service**

**Note:** Sirius reserves the unrestricted right to change, rearrange, add or delete programming including canceling, moving or adding particular channels, and its prices, at any time, with or without notice to you. Ford Motor Company shall not be responsible for any such programming changes.



Sirius satellite radio is a subscription-based satellite radio service that broadcasts a variety of music, sports, news, weather, traffic and entertainment programming.

Your factory-installed Sirius satellite radio system includes hardware and a limited subscription term which begins on the date of sale or lease of your vehicle. See an authorized dealer for availability.

For more information on extended subscription terms (a service fee is required), the online media player and a complete list of Sirius satellite radio channels, and other features, please visit [www.siriusxm.com](http://www.siriusxm.com) in the United States, [www.sirius.ca](http://www.sirius.ca) in Canada, or call Sirius at 1-888-539-7474.

**Satellite Radio Electronic Serial Number (ESN)**

You need your ESN to activate, modify or track your satellite radio account. When in satellite radio mode, you can view this number by pressing **SIRIUS** and memory preset 1 at the same time. To access your ESN, press the bottom left corner of the touchscreen, then **SIRIUS > Options**.

**Troubleshooting**

Radio display	Condition	Possible action
Acquiring	Radio requires more than two seconds to produce audio for the selected channel.	No action required. This message should disappear shortly.
Sat Fault/SIRIUS system failure	There is an internal module or system failure present.	If this message does not clear shortly, or with an ignition key cycle, your receiver may have a fault. See an authorized dealer for service.

<b>Radio display</b>	<b>Condition</b>	<b>Possible action</b>
Invalid Channel	The channel is no longer available.	Tune to another channel or choose another preset.
Unsubscribed Channel	Your subscription does not include this channel.	Contact Sirius at 1-888-539-7474 to subscribe to the channel, or tune to another channel.
No Signal	The signal is lost from the Sirius satellite or Sirius tower to your vehicle antenna.	The signal is blocked. When you move into an open area, the signal should return.
Updating	Update of channel programming in progress.	No action required. The process may take up to three minutes.
Call SIRIUS 1-888-539-7474	Your satellite service is no longer available.	Call Sirius at 1-888-539-7474 to resolve subscription issues.
None Found. Check Channel Guide.	All the channels in the selected category are either skipped or locked.	Use the channel guide to turn off the Lock or Skip function on that station.
Subscription Updated	Sirius has updated the channels available for your vehicle.	No action required.

**AUXILIARY INPUT JACK**

 **WARNING:** Driving while distracted can result in loss of vehicle control, crash and injury. We strongly recommend that you use extreme caution when using any device that may take your focus off the road. Your primary responsibility is the safe operation of your vehicle. We recommend against the use of any hand-held device while driving and encourage the use of voice-operated systems when possible. Make sure you are aware of all applicable local laws that may affect the use of electronic devices while driving.

 **WARNING:** For safety reasons, do not connect or adjust the settings on your portable music player while your vehicle is moving.

 **WARNING:** Store the portable music player in a secure location, such as the center console or the glove box, when your vehicle is moving. Hard objects may become projectiles in a crash or sudden stop, which may increase the risk of serious injury. The audio extension cable must be long enough to allow the portable music player to be safely stored while your vehicle is moving.

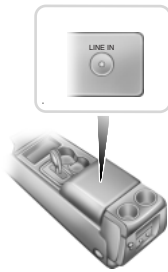

The auxiliary input jack allows you to connect and play music from your portable music player through your vehicle speakers. You can use any portable music player designed for use with headphones. Your audio extension cable must have male 1/8-inch (3.5 millimeter) connectors at each end.

1. Switch off the engine, radio and portable music player. Set the parking brake and put the transmission in position **P**.
2. Plug the extension cable from the portable music player into the auxiliary input jack.

3. Switch the radio on. Select either a tuned FM station or a CD.
4. Adjust the volume as desired.
5. Switch your portable music player on and adjust its volume to half its maximum level.
6. Press **AUX** until **LINE** or **LINE IN** appears in the display. You should hear music from your device even if it is low.
7. Adjust the volume on your portable music player until it reaches the volume level of the FM station or CD. Do this by switching back and forth between the AUX and FM or CD controls.

**USB PORT (IF EQUIPPED)**

**WARNING:** Driving while distracted can result in loss of vehicle control, crash and injury. We strongly recommend that you use extreme caution when using any device that may take your focus off the road. Your primary responsibility is the safe operation of your vehicle. We recommend against the use of any hand-held device while driving and encourage the use of voice-operated systems when possible. Make sure you are aware of all applicable local laws that may affect the use of electronic devices while driving.

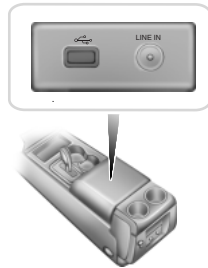

The USB port allows you to plug in media playing devices, memory sticks and charge devices (if supported). See the *SYNC* chapter for more information.

**REAR SEAT ENTERTAINMENT SYSTEM (IF EQUIPPED)**

**WARNING:** Driving while distracted can result in loss of vehicle control, crash and injury. We strongly recommend that you use extreme caution when using any device that may take your focus off the road. Your primary responsibility is the safe operation of your vehicle. We recommend against the use of any hand-held device while driving and encourage the use of voice-operated systems when possible. Make sure you are aware of all applicable local laws that may affect the use of electronic devices while driving.

**Note:** Make sure you run the engine while using the device. To avoid discharging your vehicle battery:

- Do not use this device without the engine running.
- Turn off the device when your vehicle is not in use for long periods.

The system consists of the following features:

- Seven-inch color TFT-LCD panel (480x234) with 16:9 aspect
- Built-in, top-loading slot load DVD player
- Infrared transmitters for infrared wireless headphones
- Audio/Video source input (three RCA jacks)
- USB 2.0 (optional)
- One-eighth inch stereo headphone jack
- Forward remote sensor on the front panel
- Full-function remote control
- Five control buttons on the front panel: POWER, SOURCE, STOP, PLAY and EJECT
- On-screen display control
- 12V DC power input
- FM transmitter (may be optional)

**Note:** Do not touch the inner pins of the jacks on the front panel. Electrostatic discharge may cause permanent damage to the device.

Your system plays the following types of discs:

- **DVD-Video:** DVD contains video.
- **DVD +/- R:** DVD contains video.
- **CD-DA:** CD contains musical or sound content only.
- **CD-Video:** CD contains movie only.
- **CD-R/RW:** CD contains audio files (such as a CD-R with MP3 files), MPEG or JPEG files.

Your system does not play the following types of discs:

- Optical disc CD-1
- CD-ROM
- DVD-ROM mini disc-CDG (audio only, not graphics)

### Important Notice

It is unlawful in most jurisdictions for a person to drive a motor vehicle which is equipped with a television viewer or screen that is located in the motor vehicle at any point forward of the back of the driver's seat, or that is visible, directly or indirectly, to the driver while operating your vehicle. In the interest of safety, do not install the unit where it is visible, directly or indirectly, by the operator of the motor vehicle. If your vehicle is equipped with a wireless rear seat audio system or any other wireless infrared device, power the system off in order to operate the DVD headrest system. If the system is on, the two systems may interfere with each other canceling out or creating undesirable audio through the wireless headphones.

### Safety Precaution

For safety reasons:

- Do not change discs while your vehicle is moving.
- Do not allow children to unfasten their safety belts to change discs or make changes to the system.
- Make changes with the remote control, while safety belts remain fastened.

Enjoy your entertainment system, but remember that safety of your passengers is the highest priority.

### Wireless Headphones

This unit includes a built-in dual channel infrared transmitter for use with your wireless headphones. You can change headphone volume using the individual controls on each headset. To use wireless headphones effectively, you must maintain line-of-sight between headphones and transmitter. Allowing obstructions to come between headphone and transmitter, or body motions that allow the user to conceal the headphone from the transmitter (like reaching or bending), adversely affect audio performance. Infrared transmission, like visible light, travels only in a straight line.

**Wired Headphones**

You can use any standard stereo headphones by plugging them into the 1/8-inch (3.5 millimeter) headphone jack on each of the headrest DVD systems. Remove and save the protective plastic cover to access the jacks. Remember to replace the cover when the jacks are not in use.

**A/V Input**

You can connect an external audio/video device that uses common RCA interface cables to the Ford DVD system, such as a video game device or VCR. Connect the device RCA cables to the AV RCA INPUT jacks according to color: yellow for video, red for right audio and white for left audio. The signal from the external audio/video source overrides other video sources for that monitor.

**Wireless FM Transmitter**

Your device has an internal FM transmitter. This allows you to listen to the DVD player audio signal by tuning your vehicle FM radio to a radio frequency that you select, then accessing the SOUND-AROUND feature by using the remote control. SOUND-AROUND allows the user to choose from a number of pre-programmed frequencies to play back the rear-seat entertainment system audio over the radio. When you engage SOUND-AROUND, as long as the DVD player is active, it adversely affects the FM radio reception of other stations, especially neighboring stations nearest to whichever station is in use for the DVD player. Performance of SOUND-AROUND varies based on geographic location. You may need to change the SOUND-AROUND frequency periodically when travelling long distances. This helps maintain the best performance when listening to DVD system content over the radio. Audio heard through wireless headphones remains unaffected by SOUND-AROUND. There may also be a reduction in AM radio performance as well. AM and FM radio performance can be expected to return to normal when the DVD system is turned off.

**How to use the FM Transmitter**

1. Switch on the system and place a disc in Monitor A.
2. Point the remote control at the monitor, and then press DVD A.
3. Press **SOUND AROUND ON/OFF** to turn FM transmission off and on.
4. Select a radio frequency (88.3, 88.7, 89.1, 89.5, 89.9, and 90.3MHz) by pressing **SOUND AROUND SELECT**.
5. Select a frequency, and then tune your radio to the corresponding frequency. Try each station frequency until you achieve a clear audio signal.

**Console Controls**

**Note:** Do not use any solvents or cleaning materials when cleaning the video device.

**Note:** Do not use any abrasive cleaners, which may scratch the screen. Use only a lightly dampened lint free cloth to wipe the screen if it is dirty.

**Note:** Lock the LCD screen in the fully closed position when not in use.

**Note:** Do not put pressure on the screen.

**Note:** Caution children against touching or scratching the screen, as it may become dirty or damaged.

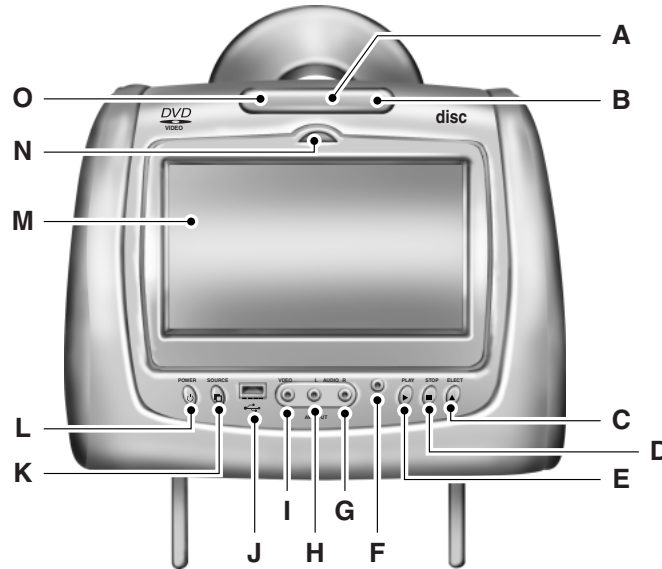

**Note:** Items marked with an \* are only available on systems with a DVD player.

**A. DVD compartment slot\*:** Insert a disc with the label side facing the rear passengers.

**B. Infrared transmitters:** These transmit audio to the wireless headphones.

**C. EJECT\*:** Press this button to eject the disc from the DVD compartment.

- D. **STOP\***: Press this button to stop playing the disc.
- E. **PLAY\***: Press this button to play the disc.
- F. **Headphone jack**: Plug in your wired headphones with a 1/8-inch (3.5 millimeter) stereo connector plug to listen to audio from the program.
- G. **Video input jack (red)**: Connect an RCA cable to this port.
- H. **Video input jack (white)**: Connect an RCA cable to this port.
- I. **Video input jack (yellow)**: Connect an RCA cable to this port.
- J. **USB port (optional)**: Listen to music or view images you stored on a USB device such as a USB memory stick or a memory card reader.
- K. **SOURCE**: Press this button to select Monitor A, Monitor B, AUX/TV (if available), and AUX 2 (if available).
- L. **POWER**: Press this button to turn the system off and on.
- M. **TFT LCD panel**: Seven-inch TFT LCD panel.
- N. **Level lock and release latch**: Use this latch to change the viewing angle of the LCD panel or lock the panel into the secured position.
- O. **Infrared sensor - forward sensor eye**: This allows the remote control to navigate the on-screen display.

### Remote Control

**Note:** The remote control uses infrared light to send commands to the DVD player, just as many home video systems do. Just point the remote control at the DVD player infrared window located above each screen in order to control that DVD player. While you can connect a second device such as a VCR through the auxiliary inputs, and view the playback on the screen, you cannot control that device by aiming its remote control at the Ford DVD player. The Ford DVD system remote control is the only remote control you can use with the system. For example, if you connect a VCR to the DVD system, you must point the VCR remote control at the VCR to control it.

### Installing the Battery

Before using your remote control, install the batteries as follows:

1. Turn the remote control face down. Press down on the ridged area of the battery cover and slide it off.
2. Install two AAA batteries. Make sure you install the batteries properly, with the + and – facing the correct way, as shown in the battery compartment.
3. Slide the cover back until it clicks.

**Note:** Different types of batteries have different characteristics. Do not mix different types.

**Note:** Do not mix old and new batteries. Mixing old and new batteries can shorten battery life and cause chemical leaks from the old batteries.

**Note:** Keep the batteries out of the reach of children. If someone swallows a battery, immediately consult a doctor. When you dispose of used batteries, keep to governmental regulations or environmental public institution rules that apply in your area.

**Note:** Remove the batteries if the remote control is not used for a month or longer.

**Button Function Descriptions**

**Note:** The remote control only operates this device. It is not a universal remote control and does not control other equipment.

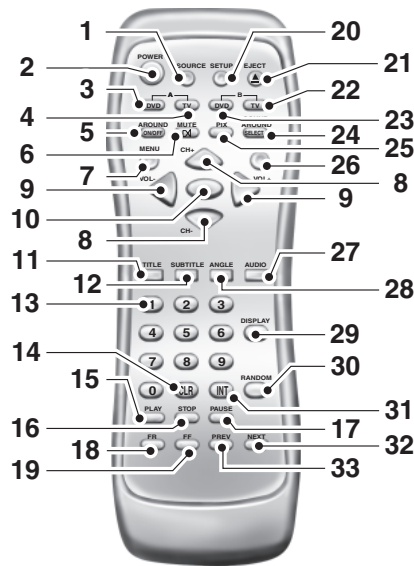

1. **SOURCE:** Press this button to use any equipment connected to the audio/video inputs. Each time you press the button, the source changes in the following sequence: Monitor A, Monitor B, AUX/TV and AUX 2.
2. **POWER:** Press this button to turn the device off and on.
3. **DVD-Monitor A:** Press this button to control DVD mode of Monitor A.

4. **TV-Monitor A\***: Press this button to control TV mode of Monitor A.
5. **SOUND AROUND ON/OFF\***: Press this button to turn the FM transmitter off and on.
6. **MUTE**: Press this button to turn off the sound sent to the headphones. The screen displays that the sound is muted. Pressing the button again restores sound to the previously set level. This feature is only functional in DVD mode.
7. **MENU**: Press this button to go to the disc's root menu.
8. **CH + and CH -**:
  - In DVD mode, press these buttons to move the select bar to items among the menu or file list.
  - In TV mode, press these buttons to go to the next channel or previous channel.
  - In on-screen display mode, press these buttons to change the setting of a selected item.
9. **VOL + and VOL -**:
  - In DVD mode, press these buttons to move the select bar to items to one of the items in the menu or file list.
  - When not in on-screen display mode, press these buttons to change the volume of the playing media.
10. **ENTER**: Press this button to select from the on-screen display, or begin disc playback.
11. **TITLE**: Press this button to go to a disc's title menu.
12. **SUBTITLE**: If a disc has subtitle options, press this button to display the subtitle menu. Keep pressing the button until you reach your desired option.
13. **Numbers**: Decimal numbers: 0 to 9.
14. **CLR**: Press this button to clear any numeric input from the number keypad.
15. **PLAY**: Press this button to play a disc in the DVD player.
16. **STOP**: Press this button to stop the playing media.
  - Pressing STOP once, then PLAY, resumes disc playback from where it left off.
  - Pressing STOP twice, then PLAY, resumes disc playback from the beginning.
17. **PAUSE**: Press this button to pause the disc.
18. **FR (Fast Rewind)**: Press this button to search the disc backward continuously. There are five speed options to choose: 2X, 4X, 8X, 16X, and 32X.

19. **FF (Fast Forward):** Press this button to search the disc forward continuously. There are five speed options to choose: 2X, 4X, 8X, 16X, and 32X.
20. **SETUP:** Press this button to navigate the Setup Menu. See *How to use the DVD on-screen display (OSD) menu* for more information.
21. **EJECT:** Press this button to eject or load a disc.
22. **TV-Monitor B\*:** Press this button to control TV mode of Monitor B.
23. **DVD-Monitor B:** Press this button to control DVD mode of Monitor B.
24. **SOUND AROUND SELECT\*:** Press this button to select an FM transmitter channel.
25. **PIX:** Press this button to access settings for BRIGHTNESS, CONTRAST, SATURATION, HUE, SHARPNESS, IR HEADPHONE, and RESET. When you find the desired setting, use **CH +** and **CH -** to change the setting. The bar display automatically disappears if no changes are made within six seconds, or if any button is pressed.
26. **REPEAT:** Press this button to switch the repeat mode by ALL, TITLE, CHAPTER and cancel the repeat mode while playing DVD-video. Other disc types such as VCD, CD, and SVCD only have two repeat modes that you can select: TRACK and ALL. **Note:** Both repeat functions of VCD and SVCD need the PBC status set to ON, when available.
27. **AUDIO:** Press this button if a disc has different language options. Press this button repeatedly until you reach your desired option.
28. **ANGLE:** Press this button to view with a different camera angle. Press this button repeatedly until you have reached your desired viewing angle. This feature is only available on DVDs that support frames with multiple angles.
29. **DISPLAY:** Press this button display information on the screen including title, chapter or track, time elapsed and time remaining. You can also press this button to turn off the display.
30. **RANDOM:** Press this button to play titles in a random order
31. **INT:** Press this button to play each audio file for 10 seconds as a review or scan.
32. **NEXT:** When a disc has more than one chapter, track or file, press this button to move to the next chapter, track or file. Press the button briefly during play to select the next chapter for DVD-video or track and file for media such as VCD, SVCD, MP3 and CD.
33. **PREV:** When a disc has more than one chapter, track or file, press this button to move to the previous chapter, track or file. Press the button briefly during play to select the next chapter for DVD-video or track and file for media such as VCD, SVCD, MP3 and CD.

\*If available

**Turning the Device On and Off**

1. Pivot the screen downward until you reach a comfortable viewing angle.
2. Press **POWER** on the lower-left corner of the front panel or on the remote control. The controls illuminate when the system is in use.
3. When the device is on and is displaying a picture, pivot the screen to change the viewing angle to optimize the picture quality.
4. Remember to turn the device off and pivot the LCD panel to the locked position when not in use.

**DVD Basics**

To get the most use out of each DVD, make sure you read this section completely.

***Regional Coding***

Both the DVD player and disc have specific region codes. These regional codes must match in order for the disc to play. If the codes do not match, the disc does not play. The system is set to the region code designated for your area by the DVD Copy Control Association. Other regions do not play in this system.

***Loading and Playing Discs***

When you press **POWER**, the system turns on in DVD mode. Place the disc about halfway into the disc compartment slot, with the disc's label facing the rear of your vehicle. Insert the disc straight into the player; do not insert the disc at an angle.

The disc loads automatically and begins to play. Some discs start at the root menu, where you have to select disc play manually.

Depending on the disc and playback location on the disc, the icon may display in the upper-left corner of the screen indicating that still playback is not possible.

***Notes***

- To keep a disc clean, do not touch its surface. Handle the disc by its edge.
- Keep your discs in their cases or disc magazines when not in use. Also, do not subject a disc to heat or high temperatures. Avoid leaving them in a parked vehicle, on a dashboard or on a rear tray.
- Do not attach labels, or use discs with sticky ink or residue. Such discs may stop spinning, causing a system malfunction, or ruining the disc.

- Do not use any discs with labels or stickers attached. The following malfunctions may result from using such discs:
  - The system cannot eject a disc due to a label or sticker peeling off and jamming the eject mechanism.
  - The system cannot read audio data correctly, such as playback skipping or no playback at all, due to heat shrinking of a sticker or label causing the disc to warp.
- Before playing a disc, clean it with a commercially available cleaning cloth. Wipe each disc from the center out. Do not use solvents such as benzene, thinner, commercially available cleaners, or antistatic spray intended for analog discs.
- Do not use any irregularly shaped discs. If you insert an irregular, non-round, shaped disc, it may jam in the DVD player or not play properly.

### How to Use the DVD On-screen Display Menus

You can use the on-screen display menu screen to adjust all the settings on your screen.

#### **General Setup**

Press **SETUP** on the remote control, and then use **CH +**, **CH -**, **VOL +** and **VOL -** to navigate the Setup Page. Press **ENTER** to make a selection, and then **VOL -** to return to the submenu.

To exit the Setup Display, press **SETUP** again.

#### **OSD Language**

The OSD Lang submenu allows the user to select the language for the on-screen display. Press **VOL +**, and then use **CH +** and **CH -** on the remote control to select the desired language. The user can select English, Simple/Traditional Chinese, French, German, Italian, Spanish, Portuguese or Korean. Press **ENTER** to make a selection, and then **VOL -** to return to the submenu.

#### **Angle Mark**

The angle mark is an option for different viewing angles on the DVD.

Press **VOL +** and **VOL -** to turn the angle mark setting off and on. Press **ENTER** to make a selection, and then **VOL -** to return to the submenu.

**Audio Setup**

Press **SETUP** on the remote control, and then use **CH +**, **CH -**, **VOL +** and **VOL -** to navigate the Setup Page. Press **ENTER** to make a selection, and then **VOL -** to return to the submenu.

**Speaker Setup**

Press **SETUP** on the remote control and then use **VOL +** to navigate to the Audio Setup Page. Press **ENTER** to navigate to the submenu. Use **CH +**, **CH -**, **VOL +** and **VOL -** to navigate the submenus. Press **ENTER** or **VOL +** to make a selection, and then **VOL +** and **VOL -** to see the selection items. Press **ENTER** to make a selection, and then **VOL -** to return to the submenu.

The Speaker Setup menu has the following options:

- LT/RT
- Stereo
- V SURR
- OFF

The Dolby Digital Setup menu has the following options:

- Stereo
- L-Mono
- R-Mono
- Mix-Mono

**Quality Setup**

Press **SETUP** on the remote control, and then use **CH +**, **CH -**, **VOL +** and **VOL -** to navigate the Setup Page. Press **ENTER** to make a selection, and then **VOL -** to return to the submenu.

**Video Quality Setup**

Press **SETUP** on the remote control and then press **VOL +** to navigate to the Video Setup Page. Press **ENTER** twice to enter the submenu. Use **CH +**, **CH -**, **VOL +** and **VOL -** to navigate the submenus. Press **ENTER** or **VOL +** to select an item, and then **VOL +** and **VOL -** to see the selection items. Press **ENTER** to make a selection, and then **VOL -** to return to the submenu.

**Video Quality**

You can adjust the following features:

- **SHARPNESS** softens or sharpens the picture. You can select Low, Med. or High.
- **BRIGHTNESS** brightens or darkens the picture. The setting ranges from -20 to +20.

- **CONTRAST** allows you to increase or decrease the picture contrast. The setting ranges from -16 to +16.
- **HUE** allows you to increase or decrease the color hue. The setting ranges from -9 to +9.
- **SATURATION** allows you to increase or decrease the color intensity. The setting ranges from -9 to +9.

#### **How to Use the Device On-screen Display Menus**

Press **SETUP** on the remote control, and then use **CH +**, **CH -**, **VOL +** and **VOL -** to navigate the Setup Page. Press **ENTER** to make a selection, and then **VOL -** to return to the submenu.

#### **Audio**

This allows the user to control the audio stream in the selected language for playback automatically.

#### **Subtitle**

This allows the user to turn the subtitles on and off in the selected language for playback automatically.

#### **Disc Menu**

This allows the user to control the DVD disc menu in the selected language.

#### **Parental**

This section of the Setup Menu allows user to control the content of movie playback from G to ADULT. The parental control function allows you to limit viewing to your preference. The rating levels are 1 through 8 and are country-dependent.

After navigating to the Parental submenu, use **VOL +** and the **CH +** and **CH -** buttons to select:

- KID SAFE (Children)
- G
- PG
- PG 13
- PGR
- R
- NC 17
- ADULT

**Note:** The lower you make the value, the stricter the limitation is.

**Password**

Press **SETUP** and navigate to the Password submenu under the Password Setup Page.

1. Press **VOL +**, and then press **ENTER** on the remote control to enter the submenu.
2. Input the old six-digit password or the default password. The default password is 136900.
3. Input a new six-digit password using the numeric buttons.
4. Confirm the new password by entering the same new password again.
5. Scroll to OK, and then press **ENTER** to finish.

**Default**

Press **SETUP** on the remote control, and then navigate to the Default submenu under the Preference page using **CH +**, **CH -** and **VOL +**.

Press **VOL +**, and then press **ENTER** to carry out the reset. This function does not affect the parental settings.

**Playing an Audio CD**

When playing an audio CD, the DISPLAY banner appears automatically. It displays the current track and the amount of time the track has been playing, the total amount of time on the disc and the current time running on the disc.

Press **DISPLAY** on the remote control to see the DISPLAY banner.

- Press **DISPLAY** once: Single Elapsed appears along with the current track playing and the time of that track.
- Press **DISPLAY** twice: Single Remain appears along with the current track playing and the amount of time left.
- Press **DISPLAY** three times: Total Elapsed appears along with the current track playing and the total time playing on CD.
- Press **DISPLAY** four times: Total Remain appears along with the current track playing and the amount of time left on CD.

Press the **REPEAT** on the remote control to repeat either the currently playing track or the entire CD.

**Playing an MP3 Disc**

MP3 is a format for storing digital audio. An audio CD-quality song compressed into the MP3 format has very little loss of quality, while taking up much less space. You can play CD-R discs encoded in MP3 format in your DVD player.

### **Selecting Folders and Songs**

When you insert an MP3 disc in the player, an MP3 audio-navigation screen appears automatically. You can change folders and songs by navigating the file system. The DVD player plays the songs in the order you burned them to the disc.

1. If a disc is playing, press **DISPLAY** on the remote control, and then press **CH +** and **CH -** to go through the folder list on the left side of the navigation screen.
2. Highlight the folder you want, and then press **ENTER**.
3. Press **CH +** and **CH -** to go through the song list and highlight the song you want. Press **ENTER** to begin playing the highlighted song.

### **Skipping Songs**

Press **NEXT** on the remote control to move to the next song. Press **PREV** to move to the beginning of the currently playing song. Press **PREV** twice to move to the previous song.

### **Selecting a Play Mode**

You can choose what order the songs play on a disc temporarily. The FOLDER play mode is the default. To access the play mode operations, press **REPEAT** on the remote control. The play mode options are:

- **Single:** Play a selected song.
- **Repeat One:** Repeat the song that is playing.
- **Folder:** Play the folder in the order you recorded the songs.
- **Folder Repeat:** Repeat the folder that is playing.
- **Random:** Play the songs in the random order.
- **Shuffle:** Play the songs within the selected folder in random order.

### **Order of Tracks**

The DVD-headrest module plays the files in the order that you added them to the USB drive. Therefore, the playback order may not be the same as what appears on the screen. To access the file structure and menus, for the USB device, you need the remote control set to the appropriate systems (A or B).

When you insert the USB device, the system may begin playing files automatically, returning to the previous position, if it was unplugged during a previous playback. To return to the menus, press **MENU** or **VOL -**, depending on the type of file you are playing. The current directory appears, listing all file types.

**Controls**

- **MENU:** Press this button to return to the menu structure.
- **CH + and CH -:** Press these buttons to move the select bar up and down within the selected menu or file list.
- **VOL -:** Press this button to move the menu up one level. Pressing this button in some menu functions returns you to the menu structure.
- **VOL +:** Press this button to select a menu item.
- **ENTER:** Press this button to make a selection or begin file playback.
- **PLAY:** Press this button to play a file.
- **STOP:** Press this button to stop the playing media.
- **PAUSE:** Press this button to stop the media playback temporarily.
- **FR (Fast Rewind):** Press this button to reverse through the file continuously. There are five speed options to choose: 2X, 4X, 8X, 16X, and 32X.
- **FF (Fast Forward):** Press this button to fast forward through the file continuously. There are five speed options to choose: 2X, 4X, 8X, 16X, and 32X.
- **PREV:** Press this button to go to the previous file.
- **NEXT:** Press this button to go to the next file.

**Connecting an MP3 Device****Using a USB Cable**

Plug the MP3 Dock Connector to USB cable into a high-power USB port on your DVD-headrest module, and then connect the other end to the player.

See the documentation that came with your device for more information.

**Charging the MP3 Player Battery**

After you turn the DVD-headrest module on, connect the device to the USB port on your DVD-headrest module

**Note:** Not all devices are able to charge when connected to the USB port.

**Using an A/V Cable**

1. Connect the device to the headphone port using an A/V cable.  
**Note:** Use the A/V cable made specifically for the device. Other similar RCA-type cables might not work.
2. Connect the video and audio connectors to the AV-IN ports on your DVD-headrest module, matching the yellow, red and white connectors to the appropriate jacks.

**Troubleshooting**

Symptom	Possible cause
The device does not power on.	Your vehicle ignition is not on.
	The remote control does not have batteries installed.
The infrared sensor is inoperative.	The batteries in the remote control are not working.
	The remote sensor eye is blocked.
	The infrared transmitter is blocking the sensor eye of the component to be controlled
The disc does not play.	You inserted the disc backward.
	The disc is defective. Try another disc.
	The disc is not compatible with the entertainment system.
	The device code and disc region code do not match. This device is set to Region 1.
The disc plays, but then immediately stops.	The disc is dirty and needs cleaning.
	Condensation has formed inside the device. Allow the player to dry out.
There is no picture.	The signal source is not connected.
	The setting may be in the wrong status. Match the monitor mode with the source correctly.
There is a distorted picture.	The disc may be dirty. Check the disc for fingerprints and clean with a soft cloth, wiping from center to edge.
	Sometimes a small amount of picture distortion may appear. This is not a malfunction.
I cannot advance through a movie.	You cannot advance through the opening credits and warning information that appears at the beginning of movies because the disc prohibits that action.

Symptom	Possible cause
There is no sound, or there is distorted sound.	You did not connect the DVD player properly.
	You did not attach the cables securely into the appropriate jacks.
	If you are using the wireless headphones, make sure you turn them on.
	The headphone volume is too low.
	Something may be blocking the signal between the monitor and the headphones.
The device feels warm.	If the device is in use for a long time, it does become warm. This is normal.
The player does not respond to all commands during playback.	The disc prohibits some operations.
	Refer to the instructions in the disc inlay.

### Compliance Information

#### **FCC Notice**

This device has been tested and found to comply with the limits for a Class B digital device, pursuant to part 15 of the FCC Rules. These limits are designed to provide reasonable protection against harmful interference in a residential installation. This device generates, uses, and can radiate radio frequency energy, and if not installed and used in accordance with the instructions, may cause harmful interference to radio communications. However, there is no guarantee that interference will not occur in a particular installation. If this device does cause unacceptable interference to radio or television reception, which can be determined by turning the device off and on, the user is encouraged to try to correct the interference by one or more of the following measures:

- Reorient or relocate the receiving antenna.
- Increase the separation between the device and receiver.
- Connect the device into an outlet on a circuit different from that to which the receiver is connected.
- Consult your dealer or an experienced radio or TV technician for help.

**FCC Warning:**

To assure continued FCC compliance, the user must use the provided grounded power supply cord and the shielded video interface cable with bonded ferrite cores. Also, any unauthorized change or modifications to this device would void the user's authority to operate this device.

**Macrovision Notice**

This product incorporates copyright protection technology that is protected by U.S. patents and other intellectual property rights. Use of this copyright protection technology must be authorized by Macrovision, and is intended for home and other limited viewing uses only unless otherwise authorized by Macrovision. Reverse engineering or disassembly is prohibited.

**Warranty**

INVISION Automotive Systems Inc., (the "Company") warrants to the original retail purchaser of this product, when purchased from a participating new car dealership, that should this product under normal use and conditions, be proven defective in material or workmanship, such defect(s) will be repaired or replaced with reconditioned product (at the Company's option) without charge for parts and repair labor when the work is performed by the original dealership of purchase, or an authorized representative of that dealership.

This Warranty will match the warranty of the Original Equipment Manufacturer ("OEM") when installed on a new vehicle with a minimum of 36 months or 36,000 miles. If the product is installed on a used vehicle, then only a 12 month or 12,000 mile Warranty from the date of installation will apply. This Warranty is not applicable to any extended warranty purchased.

To obtain repair or replacement within the terms of this Warranty, the product must be returned to a participating new car dealership for warranty service or replacement. The dealership will perform troubleshooting to determine if repair or replacement is warranted. If a participating dealership cannot be contacted, then the Purchaser should contact the Company to obtain the name and location of a dealership where service under this Warranty can be obtained.

This Warranty does not extend to the elimination of externally generated static or noise, correction of antenna problems, costs incurred for installation, removal or reinstallation of the product, or to damage to digital memory devices, media devices, gaming devices, discs, speakers, accessories, or vehicle electrical systems.

This Warranty does not apply to any product or part thereof which, in the opinion of the Company, has suffered or been damaged through alteration, improper installation, mishandling, misuse, neglect, accident, or by removal or defacement of the factory serial number/bar code label(s). THE EXTENT OF THE COMPANY'S LIABILITY UNDER THIS WARRANTY IS LIMITED TO THE REPAIR OR REPLACEMENT PROVIDED ABOVE AND, IN NO EVENT, SHALL THE COMPANY'S LIABILITY EXCEED THE PURCHASE PRICE PAID BY PURCHASER FOR THE PRODUCT.

This Warranty is in lieu of all other express warranties or liabilities. ANY IMPLIED WARRANTIES, INCLUDING ANY IMPLIED WARRANTY OF MERCHANTABILITY, SHALL BE LIMITED TO THE DURATION OF THIS WRITTEN WARRANTY. ANY ACTION FOR BREACH OF ANY WARRANTY HEREUNDER, INCLUDING ANY IMPLIED WARRANTY OF MERCHANTABILITY, MUST BE BROUGHT WITHIN A PERIOD OF 48 MONTHS FROM THE DATE OF ORIGINAL PURCHASE. IN NO CASE SHALL THE COMPANY BE LIABLE FOR ANY CONSEQUENTIAL OR INCIDENTAL DAMAGES FOR BREACH OF THIS OR ANY OTHER WARRANTY, EXPRESS OR IMPLIED, WHATSOEVER. No person or representative is authorized to assume for the Company any liability other than expressed herein in connection with the sale of this product.

Some states do not allow limitations on how long an implied warranty lasts or the exclusion or limitation of incidental or consequential damage so the above limitations or exclusions may not apply to you. This Warranty gives you specific legal rights and you may also have other rights which vary from state to state.

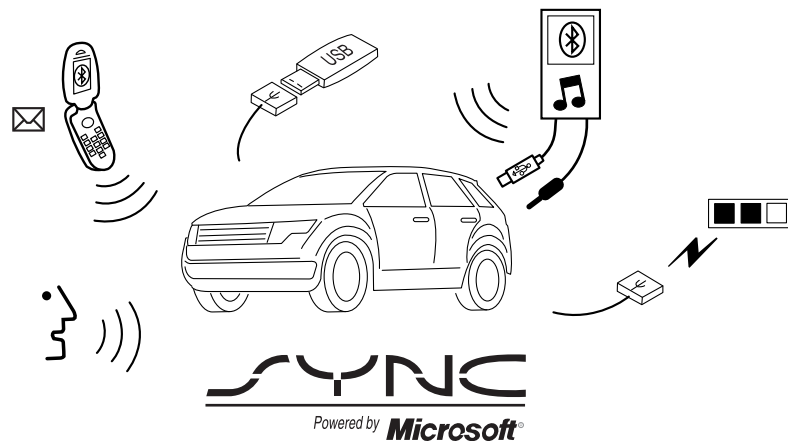

SYNC is an in-vehicle communications system that works with your Bluetooth-enabled cellular phone and portable media player. This allows you to:

- Make and receive calls.
- Access and play music from your portable music player.
- Use 911 Assist, Vehicle Health Report and SYNC Services (Traffic, Directions & Information) (if equipped).
- Use applications, such as Pandora and Stitcher, via SYNC AppLink™ (if applicable).
- Access phonebook contacts and music via voice commands.
- Stream music from your connected phone.
- Text message.
- Use the advanced voice recognition system.
- USB device charging (if your device supports this).

---

**GENERAL INFORMATION**

Make sure you review your device's manual before using it with SYNC.

**Support**

The SYNC support team is available to help you with any questions you cannot answer on your own.

Monday-Saturday, 8:30am-9:00pm EST.

Sunday, 10:30am-7:30pm EST.

In the United States, call: 1-800-392-3673.

In Canada, call: 1-800-565-3673.

Times are subject to change due to holidays.

**SYNC Owner Account**

Why do I need a SYNC owner account?

- Required to activate Vehicle Health Report and to view the reports online.
- Required to activate the subscription-based SYNC Services and to personalize your Saved Points and Favorites.
- Essential for keeping up with the latest software downloads available for SYNC.
- Access to customer support for any questions you may have.

**Driving Restrictions**

For your safety, certain features are speed-dependent and restricted when your vehicle is traveling over 3 mph (5 km/h).

**Safety Information**

**WARNING:** Driving while distracted can result in loss of vehicle control, crash and injury. We strongly recommend that you use extreme caution when using any device that may take your focus off the road. Your primary responsibility is the safe operation of your vehicle. We recommend against the use of any handheld device while driving and encourage the use of voice-operated systems when possible. Make sure you are aware of all applicable local laws that may affect the use of electronic devices while driving.

When using SYNC:

- Do not operate playing devices if the power cords or cables are broken, split or damaged. Place cords and cables out of the way, so they do not interfere with the operation of pedals, seats, compartments or safe driving abilities.
- Do not leave playing devices in your vehicle during extreme conditions as it could cause them damage. See your device's manual for further information.
- Do not attempt to service or repair the system. See your authorized dealer.

For your safety, some SYNC functions are speed-dependent. Their use is limited to when your vehicle is traveling at speeds under 3 mph (5 km/h).

Make sure that you review your device's manual before using it with SYNC.

### **Privacy Information**

When a cellular phone is connected to SYNC, the system creates a profile within your vehicle that is linked to that cellular phone. This profile is created in order to offer you more cellular features and to operate more efficiently. Among other things, this profile may contain data about your cellular phone book, text messages (read and unread), and call history, including history of calls when your cell phone was not connected to the system. In addition, if you connect a media device, the system creates and retains an index of supported media content. The system also records a short development log of approximately 10 minutes of all recent system activity. The log profile and other system data may be used to improve the system and help diagnose any problems that may occur.

The cellular profile, media device index, and development log remain in the vehicle unless you delete them and are generally accessible only in the vehicle when the cellular phone or media player is connected. If you no longer plan to use the system or the vehicle, we recommend you perform a Master Reset to erase all stored information.

System data cannot be accessed without special equipment and access to the vehicle's SYNC module. Ford Motor Company and Ford of Canada do not access the system data for any purpose other than as described absent consent, a court order, or where required by law enforcement, other government authorities, or other third parties acting with lawful authority. Other parties may seek to access the information independently of Ford Motor Company and Ford of Canada. For further privacy information, see the sections on 911 Assist, Vehicle Health Report, and Traffic, Directions and Information.

## USING VOICE RECOGNITION

This system helps you control many features using voice commands. This allows you to keep your hands on the wheel and focus on what is in front of you.

### Initiating a Voice Session



Push the voice icon; a tone sounds and Listening appears in the display. Say any of the following:

Say:	If you want to:
“Phone”	Make calls.
“USB”	Access the device connected to your USB port.
“Bluetooth Audio”	Stream audio from your phone.
“Line in”	Access the device connected to the auxiliary input jack.
“Cancel”	Cancel the requested action.
“SYNC”	Return to the main menu.
“Voice settings”	Adjust the level of voice interaction and feedback.
“Vehicle Health Report”	Run a vehicle health report.*
“Services”	Access the SYNC Services portal.*
“Mobile apps”	Access mobile applications.*
“Help”	Hear a list of voice commands available in the current mode.

\*If equipped, U.S. only.

### System Interaction and Feedback

The system provides feedback through audible tones, prompts, questions and spoken confirmations depending on the situation and the chosen level of interaction (voice settings). You can customize the voice recognition system to provide more or less instruction and feedback.

The default setting is to a higher level of interaction in order to help you learn to use the system. You can change these settings at any time.

**Adjusting the Interaction Level**



Push the voice icon; when prompted, say “Voice settings”, then any of the following:

When you say:	The system:
“Interaction mode standard”	Provides more detailed interaction and guidance.
“Interaction mode advanced”	Provides less audible interaction and more tone prompts.

The system defaults to the standard interaction mode.

Confirmation prompts are short questions the system asks when it is not sure of your request or when there are multiple possible responses to your request. (For example, the system may ask “Phone, is that correct?”) If turned off, the system simply makes a best guess as to what you requested and you may still occasionally be asked to confirm settings.

“Confirmation prompts on”
“Confirmation prompts off”

The system creates candidate lists when it has the same confidence level of several options based on your voice command. When turned on, you may be prompted with as many as four possibilities for clarification.

For example, “Say 1 after the tone to call John Doe at home. Say 2 after the tone to call Johnny Doe on mobile. Say 3 after the tone to call Jane Doe at home.” Or, “Say 1 after the tone to play John Doe, Say 2 after the tone to play Johnny Doe.”

“Phone candidate lists on”
“Phone candidate lists off”
“Media candidate lists on”
“Media candidate lists off”

**Helpful Hints**

- Make sure the interior of the vehicle is as quiet as possible. Wind noise from open windows and road vibrations may prevent the system from correctly recognizing spoken commands.
- After pressing the voice icon, wait until after the tone sounds and Listening appears before saying a command. Any command spoken prior to this does not register with the system.
- Speak naturally, without long pauses between words.
- At any time you can interrupt the system while it is speaking by pressing the voice icon.

---

**USING SYNC WITH YOUR PHONE**

Hands-free calling is one of the main features of SYNC. While the system supports a variety of features, many are dependent on your cellular phone's functionality. At a minimum, most cellular phones with Bluetooth wireless technology support the following functions:

- Answering an incoming call
- Ending a call
- Using privacy mode
- Dialing a number
- Redialing
- Call waiting notification
- Caller ID.

Other features, such as text messaging using Bluetooth and automatic phonebook download, are phone-dependent features. To check your phone's compatibility, see your phone's user manual and visit [www.SYNCMYride.com](http://www.SYNCMYride.com), [www.SYNCMYride.ca](http://www.SYNCMYride.ca) or [www.syncmaroute.ca](http://www.syncmaroute.ca).

**Pairing a Phone for the First Time**

**Note:** SYNC can support downloading up to approximately 1000 entries per Bluetooth-enabled cellular phone.

**Note:** Make sure the vehicle ignition and radio are turned on and the transmission is in position **P**.

**Note:** To scroll through the menus, press the up and down arrows on your audio system.

Wirelessly pairing your phone with SYNC allows you to make and receive hands-free calls.

1. Press the phone button; when the display indicates no phone is paired, press **OK**.
2. When **Find SYNC** appears in the display, press **OK**.
3. Put your phone into Bluetooth discovery mode. See your phone's user guide if necessary.
4. When prompted on your phone's display, enter the six-digit PIN provided by SYNC in the radio display.
5. The display indicates when the pairing is successful.

Depending on your phone's capability and your market, the system may prompt you with questions such as setting the current phone as the primary phone (the phone SYNC automatically tries to connect with first upon vehicle start-up), downloading your phone book, etc.

**Pairing Subsequent Phones**

**Note:** To scroll through the menus, press the up and down arrows on your audio system.

**Note:** Make sure the vehicle ignition and radio are turned on and that the transmission is in position **P**.

1. Press the phone button and scroll until System Settings is selected.
2. Press OK and scroll until Bluetooth Devices is selected and press OK.
3. Scroll until Add Bluetooth Device is selected and press OK.
4. When Find SYNC appears in the display, press OK.
5. Put your phone into Bluetooth discovery mode. See your phone's user guide if necessary.
6. When prompted on your phone's display, enter the six-digit PIN provided by SYNC in the radio display. The display indicates when the pairing is successful.
7. The system then prompts with questions such as if you would like to set the current phone as the primary phone (the phone SYNC automatically tries to connect with first upon vehicle start-up), download your phone book, etc.

**Phone Voice Commands**



Press the voice icon and say "Phone". Say any of the following:

<b>"PHONE"</b>
"Call <name>" <sup>1,2</sup>
"Call <name> on mobile OR cell" <sup>1,2</sup>
"Call <name> on other" <sup>1,2</sup>
"Phone book <name> at home" <sup>2</sup>
"Phone book <name> on mobile OR cell" <sup>2</sup>
"Call history outgoing" <sup>2</sup>
"Phone book <name> on Other" <sup>2</sup>
"Call history missed" <sup>2</sup>
"Menu" <sup>2,3</sup>
"Join"
"Call <name> at home" <sup>1,2</sup>
"Call <name> at work" OR "Call <name> in office" <sup>1,2</sup>

<b>“PHONE”</b>
“Dial” <sup>1,4</sup>
“Phone book <name>” <sup>2</sup>
“Phone book <name> at work” OR “Phone book <name> at office” <sup>2</sup>
“Call history incoming” <sup>2</sup>
“Connections” <sup>2</sup>
“Go to privacy”
“Hold”

<sup>1</sup>These commands do not require you to say “Phone” first.

<sup>2</sup>These commands are not available until phone information is completely downloaded using Bluetooth.

<sup>3</sup>See “MENU” table below.

<sup>4</sup>See “DIAL” table below.

<b>“MENU”</b>
“(Phone) connections” <sup>*</sup>
“(Phone) settings (message) notification off” <sup>*</sup>
“(Phone) settings (message) notification on” <sup>*</sup>
“(Phone) settings (set) phone ringer” <sup>*</sup>
“(Phone) settings (set) ringer 1” <sup>*</sup>
“(Phone) settings (set) ringer 2” <sup>*</sup>
“(Phone) settings (set) ringer 3” <sup>*</sup>
“(Phone) settings (set) ringer off” <sup>*</sup>
“Battery”
“Phone name”
“Signal”
“Text message inbox”

<sup>\*</sup>Words in ( ) are optional and do not have to be spoken for the system to understand the command.

**Phone book commands:** When you ask SYNC® to access a phone book name, number, etc., the requested information appears in the display to view. Press the phone button and say “Call” to call the contact.

<b>“DIAL”</b>
“411” (four-one-one), “911” (nine-one-one)
“700 (seven hundred)” (seven hundred)
“800 (eight hundred)” (eight hundred)
“900 (nine hundred)” (nine hundred)
“#” (pound)
“<number> 0–9”
“Asterisk” (*)
“Clear” (deletes all entered digits)
“Delete” (deletes one digit)
“Plus”
“Star”

**Note:** To exit dial mode, press and hold the phone button or press MENU to go to the PHONE menu.

**Making Calls**

Press the voice icon and when prompted say:

1. Say “Call <name>” or “Dial”, then the desired number.
2. When the system confirms the number, say “Dial” again to initiate the call.

To erase the last spoken digit, say “Delete” or press the left arrow button. To erase all spoken digits, say “Clear” or press and hold the left arrow button.

To end the call, press and hold the phone button.

**Receiving Calls**

When receiving a call, you can:

- Answer the call by pressing the phone button.
- Reject the call by pressing and holding the phone button.
- Ignore the call by doing nothing.

### Phone Options during an Active Call

During an active call, you have additional menu features which become available such as putting a call on hold, joining calls, etc. Use the arrow buttons to scroll through the menu options.

To access:

1. Press MENU during an active call.
2. When Active Call Menu is selected, press OK.
3. Scroll to cycle through the following options:

When you select:	You can:
<b>Mute Call?</b>	Mute the call.
<b>Privacy</b>	Switch a call from an active hands-free environment to your cellular phone for a more private conversation. Press OK when Privacy on/off appears. (The display indicates In Privacy and the system transfers your call.)
<b>Call Hold</b>	Put an active call on hold. Press OK when Place Call on Hold? appears. To answer another call at this time, press the phone button.
<b>Join Calls</b>	Join two separate calls. 1. Press the phone button. 2. Access the desired contact through SYNC or use voice commands to place the second call. Once actively in the second call, press MENU. 3. Scroll until Join Calls appears and press OK. Press OK again when Join Calls? appears. <b>Note:</b> SYNC supports a maximum of three callers on a multiparty/conference call.

<b>When you select:</b>	<b>You can:</b>
<b>Enter Tones</b>	Enter “tones” such as numbers for passwords. Scroll until the desired number appears in the display, then press OK; a tone sounds as confirmation. Repeat as necessary.
<b>Phonebook</b>	Access your phonebook contacts. 1. Press OK to select, then scroll through your phonebook contacts. 2. Press OK again when the desired selection appears in the display. 3. Press the phone button.
<b>Call History</b>	Access your call history log. 1. Press OK to select, then scroll through your call history options (incoming, outgoing or missed). 2. Press OK when the desired selection appears in the display. 3. Press the phone button to call the selection.
<b>Return</b>	Exit the current menu.

### Accessing Features through the Phone Menu

SYNC's phone menu allows you to redial a number, access your call history and phone book and send text messages as well as access phone and system settings. You can also access advanced features, such as 911 Assist, Vehicle Health Report and SYNC Services.

1. Press the phone button to enter the Phone Menu.
2. Scroll to cycle through:

When you select:	You can:
<b>Phone Redial</b>	Redial the last number called (if available). Press OK to select, then press OK again to confirm.
<b>Call History</b> <sup>1</sup>	Allows you to access any previously dialed, received or missed calls while your phone has been connected to the system. <ol style="list-style-type: none"> <li>1. Press OK to select.</li> <li>2. Scroll to select from Call History Incoming, Call History Outgoing or Call History Missed. Press OK make your selection.</li> <li>3. Press OK or the phone button to call the desired selection.</li> </ol> <p><b>Note:</b> The system attempts to automatically re-download your phone book and call history each time your phone connects to SYNC (if the auto download feature is on and your Bluetooth-enabled cellular phone supports this feature).</p>
<b>Phonebook</b> <sup>1,2</sup>	Allows you to access your downloaded phonebook. <ol style="list-style-type: none"> <li>1. Press OK to confirm and enter. If your phonebook has fewer than 255 listings, they appear alphabetically in flat file mode. If there are more, they are organized into alphabetical categories.</li> <li>2. Scroll until the desired contact appears, then press OK.</li> <li>3. Press OK or the phone button.</li> </ol>

When you select:	You can:
<b>Text Message</b> <sup>1</sup>	Enables you to send, download and delete text messages.
<b>Phone Settings</b> <sup>1</sup>	Allows you to view your phone's status, set ring tones, select your message notification, change phone book entries and automatically download your cellular phone among other features.
<b>SYNC Services</b> <sup>3</sup>	Access the SYNC services portal where you can request various types of information, traffic reports and directions.
<b>911 Assist</b> <sup>4</sup>	Place an emergency call to a 911 operator for you after an accident (if the feature is used properly).
<b>Vehicle Health Report</b> <sup>3</sup>	Create and receive a diagnostic report card on your vehicle.
<b>Mobile Apps</b> <sup>3</sup>	Interact with SYNC-capable mobile applications on your smartphone.
<b>System Settings</b>	Access Bluetooth Devices menu listings (add, connect, set as primary, on/off, delete) as well as Advanced menu listings (prompts, languages, defaults, master reset, install application and system information).
<b>Exit Phone Menu</b>	Exit the phone menu by pressing OK.

<sup>1</sup>This is a phone-dependent feature.

<sup>2</sup>This is a phone-dependent and speed-dependent feature.

<sup>3</sup>If equipped, United States only.

<sup>4</sup>If equipped, United States and Canada only.

**Text Messaging**

**Note:** This is a phone-dependent feature.

SYNC allows you to receive, send, download and delete text messages. The system can also read incoming text messages to you so that you do not have to take your eyes off the road.

**Receiving a Text Message**

**Note:** This is a phone-dependent feature. Your phone must support downloading text messages using Bluetooth to receive incoming text messages.

**Note:** Forwarding a text message is a speed-dependent feature and can only be done when the vehicle is traveling at 3 mph (5 km/h) or less.

**Note:** Only one recipient is allowed per text message.

When a new message arrives, an audible tone sounds and the display indicates you have a new message. You have these options:

1. Press the voice button, wait for the prompt and say "Read Message" to have SYNC read the message to you.
2. Press OK to receive and open the text message or do nothing and the message goes into your text message inbox. Press OK again and SYNC reads your message aloud as you are not able to view the message. You can then also choose whether you'd like to reply or forward the message.
3. Press OK and scroll to choose between:
  - Reply to Text Message: Press OK to access and then scroll through the list of pre-defined messages to send.
  - Forward Text Message: Press OK to forward the message to anyone in your Phonebook or Call History. You can also choose Enter Number.

**Sending, Downloading and Deleting Your Text Messages**

Text messaging is a phone-dependent feature. If your phone is compatible, SYNC allows you to receive, send, download and delete text messages.

1. Press the phone button.
2. Scroll until Text Message appears and press OK.
3. Scroll to select from the following options:

**Send Text Message?** enables you to send a new text message based on a pre-defined set of 15 messages.

**Download Unread Msgs** allows you to download your unread messages (only) to SYNC. To download the messages, press OK to select. The display indicates your messages are being downloaded. When complete, SYNC takes you to your inbox.

**Delete All Messages?** allows you to delete current text messages from SYNC (not your phone). To delete the messages, press OK to select. The display indicates when all your text messages have been deleted and SYNC returns you to the text message menu.

**Note:** SYNC does not automatically download all of your unread text messages at every ignition cycle (as it does with call history and phonebook if automatic download is set to on).

**Return** exits the current menu when you press OK.

If you select **Send Text Message?**:

1. Press OK to select. If the system detects your phone does not support this feature, Unsupported appears in the display and SYNC returns to the main menu.
2. Scroll to cycle through the message options in the following chart.
3. Press OK when the desired selection is in the display. The system now needs to know who to send the message to.
4. Scroll to cycle through Phonebook or Call History entries. You can also select Enter Number to audibly enter a desired number.
5. Press OK to enter the desired menu and scroll to select the specific contact.
6. Press OK when the contact appears and press OK again to confirm when the system asks if you would like to send the message. Each text message is sent with the following signature: "This message was sent from my <Ford or Lincoln>".

Pre-defined text message options
Can't talk right now
Call me
Call you later
Be there in 10 minutes
Be there in 20 minutes
Yes
No
Why?
Thanks
Where R you?
I need more directions
I love you
Too funny
Can't wait to see you
I'm stuck in traffic

### Accessing Your Phone Settings

These are phone-dependent features. Your phone settings allow you to access and adjust features such as your ring tone, text message notification, modify your phone book and also set up automatic download.

1. Press the phone button.
2. Scroll until Phone Settings appears, then press OK.
3. Scroll to select from the following options:

When you select:	You can:
<b>Phone Status</b>	See the provider, name, signal power, battery power and roaming status of your connected phone. Press OK to select and scroll to view the information. When done, press OK again to return to the phone status menu.
<b>Set Ringer</b>	Select which ring tone sounds during an incoming call (one of the system's or your phone's). 1. Press OK to select and scroll to hear Ringer 1, Ringer 2, Ringer 3 and Phone Ringer. 2. Press OK to select. <b>Note:</b> If your phone supports in-band ringing, your phone's ringer sounds when Phone Ringer is chosen.
<b>Message Notification</b>	Have the option of hearing an audible tone to notify you when a text message arrives. 1. Press OK to select and scroll between Message Notification On or Message Notification Off. 2. Press OK to select.

When you select:	You can:
<b>Modify Phonebook</b>	<p>Modify the contents of your phone book (such as add, delete, download). Press OK to select and scroll between:</p> <p>Add Contacts: Press OK to add more contacts from your phone book. Push the desired contact(s) on your phone. See your phone's user guide on how to push contacts.</p> <p>Delete Phonebook: Press OK to delete the current phone book and call history. When Delete Phonebook appears, press OK to confirm. SYNC takes you back to the Phone Settings menu.</p> <p>Download Phonebook: Press OK to select and press OK again when Confirm Download? appears.</p>
<b>Auto Download</b>	<p>Automatically download your phone book each time your phone connects to SYNC. Press OK to select. When Auto Download On? appears, press OK to have your phonebook automatically downloaded each time.</p> <p>Select Off to NOT download your phonebook every time your phone connects to SYNC. Your phonebook, call history and text messages can only be accessed when your specific phone is connected to SYNC.</p> <p><b>Note:</b> Downloading times are phone- and quantity-dependent.</p> <p><b>Note:</b> When auto download is on, any changes, additions or deletions saved since your last download are deleted.</p>
<b>Return</b>	Exit the current menu.

### System Settings

System Settings provide access to your Bluetooth Devices and Advanced menu features. Use the arrow buttons to scroll through the menu options.

The Bluetooth Devices menu allows you to add, connect, delete and set a phone as primary as well as turn your Bluetooth feature on and off.

The Advanced menu allows you to access and set prompts, languages, defaults, perform a master reset, install an application and view system information.

#### **Bluetooth Devices Menu Options**

This menu allows you to add, connect, delete, set a phone as primary, and turn Bluetooth on or off.

1. Press the phone button to enter the Phone Menu.
2. Scroll until System Settings appears and press OK.
3. Scroll until Bluetooth Devices appears and select OK.
4. Scroll to select from the following options:

If you select:	You can:
<b>Add Bluetooth Device*</b>	See <i>Using SYNC with your phone</i> earlier in this chapter for pairing instructions.
<b>Connect Bluetooth Device</b>	Connect a previously paired Bluetooth-enabled phone. <ol style="list-style-type: none"> <li>1. Press OK to select and view a list of previously paired phones.</li> <li>2. Scroll until the desired device is chosen, then press OK to connect the phone.</li> </ol> <b>Note:</b> Only one device can be connected at a time. When another phone is connected, the previous one is disconnected.
<b>Set Primary Phone</b>	Set a previously paired phone as your primary phone. Press OK to select and scroll to select the desired phone. Press OK to confirm. <b>Note:</b> SYNC attempts to connect with the primary phone at every ignition cycle. When a phone is selected as primary, it appears first in the list and is marked with an asterisk (*).

If you select:	You can:
<b>Set Bluetooth On/Off</b>	Turn the Bluetooth feature on and off. Press OK and scroll to toggle between On and Off. When the desired selection is chosen, press OK. <b>Note:</b> Turning Bluetooth off disconnects all Bluetooth devices and deactivates all Bluetooth features.
<b>Delete Device</b>	Delete a paired phone. Press OK and scroll to select the device. Press OK to confirm.
<b>Delete All Devices</b>	Delete all previously paired phones (and all information originally saved with those phones). Press OK to select.
<b>Return</b>	Exit the current menu.

\*This is a speed-dependent feature.

**Advanced Menu Options**

This menu allows you to access settings such as prompts, languages, defaults, perform a master reset, install an application and view system information.

1. Press the phone button to enter the Phone Menu.
2. Scroll until System Settings appears and press OK.
3. Scroll until Advanced appears and select OK.
4. Scroll to select from the following options:

If you select:	You can:
<b>Prompts</b>	Get help from SYNC by using questions, helpful hints or asking you for a specific action. To turn these prompts on or off: 1. Press OK to select and scroll to select between on or off. 2. Press OK when the desired selection appears in the display. SYNC takes you back to the Advanced menu.

<b>If you select:</b>	<b>You can:</b>
<b>Languages</b>	Choose between English, Espanol and Francais. Once selected, all of SYNC's radio displays and prompts are in the selected language. 1. Press OK to select and then scroll through the languages. 2. Press OK when the desired selection appears in the display. If you change the language setting, the display indicates that the system is updating. When complete, SYNC takes you back to the Advanced menu.
<b>Factory Defaults</b>	Return to the factory default settings. This selection does not erase your indexed information (phonebook, call history, text messages and paired devices). 1. Press OK to select and then press OK again when Restore Defaults? appears in the display. 2. Press OK to confirm.
<b>Master Reset</b>	Completely erase all information stored on SYNC (phonebook, call history, text messages and paired devices) and return to the factory default settings. Press OK to select. The display indicates when complete and SYNC takes you back to the Advanced menu.
<b>Install Application</b>	Install applications you have downloaded. Press OK and scroll to select. Press OK to confirm.
<b>System Info</b>	Access the Auto Version number as well as the FPN number. Press OK to select.
<b>MAP Profile</b>	This is a Bluetooth component which can further help your phone with the exchange of text messages.
<b>Return</b>	Exit the current menu.

**SYNC APPLICATIONS AND SERVICES (IF EQUIPPED)**

**Note:** In order for the following features to work, your cellular phone must be compatible with SYNC. To check your phone's compatibility, visit [www.SYNCMyRide.com](http://www.SYNCMyRide.com), [www.SYNCMyRide.ca](http://www.SYNCMyRide.ca) or [www.syncmaroute.ca](http://www.syncmaroute.ca).

- SYNC Services (if equipped, United States only): Provides access to traffic, directions and information such as travel, horoscopes, stock prices and more.
- 911 Assist: Can alert 911 in the event of an emergency.
- Vehicle Health Report (if equipped, United States only): Provides a diagnostic and maintenance report card of your vehicle.
- SYNC AppLink: Allows you to connect to and use certain applications such as Pandora and Stitcher (if your phone is compatible).

**911 Assist®**

**WARNING:** Unless the 911 Assist setting is set on prior to a crash, the system will not dial for help which could delay response time, potentially increasing the risk of serious injury or death after a crash.



**WARNING:** Do not wait for 911 Assist to make an emergency call if you can do it yourself. Dial emergency services immediately to avoid delayed response time which could increase the risk of serious injury or death after a crash. If you do not hear 911 Assist within five seconds of the crash, the system or phone may be damaged or non-functional.



**WARNING:** Always place your phone in a secure location in the vehicle so it does not become a projectile or get damaged in a crash. Failure to do so may cause serious injury to someone or damage the phone which could prevent 911 Assist from working properly.

**Note:** SYNC 911 Assist feature must be set on prior to the incident.

**Note:** Before setting this feature on, ensure that you read the 911 Assist privacy notice later in this section for important information.

**Note:** If 911 Assist is turned on or off by any user, that setting applies for all paired phones. If 911 Assist is turned off, a voice message plays and/or a display message/icon comes on when the vehicle is started after a previously paired phone connects.

**Note:** Every phone operates differently. While SYNC 911 Assist works with most cellular phones, some may have trouble using this feature.

If a crash deploys an airbag (excludes knee airbags and rear inflatable safety belts [if equipped]) or activates the fuel pump shut-off, your SYNC equipped vehicle may be able to contact emergency services by dialing 911 through a paired and connected Bluetooth-enabled phone. For more information about 911 Assist, visit [www.SYNCMYride.com](http://www.SYNCMYride.com), [www.SYNCMYride.ca](http://www.SYNCMYride.ca) or [www.syncmaroute.ca](http://www.syncmaroute.ca).

- For information on airbag deployment, see the *Supplementary Restraints System* chapter.
- For information on the fuel pump shut-off, see the *Roadside Emergencies* chapter.

### **Setting 911 Assist On**

Perform the following:

1. Press the phone button to enter the Phone Menu.
2. Scroll until 911 Assist is selected.
3. Press OK to confirm and enter the 911 Assist menu.
4. Scroll to select between On and Off selections.
5. Press OK when the desired option appears in the radio display. Set On or Set Off appears in the display as confirmation.

Off selections include: Off with reminder and Off without reminder. Off with reminder provides a display and voice reminder at phone connection at vehicle start. Off without reminder provides a display reminder only without a voice reminder at phone connection.

To make sure that 911 Assist works properly:

- SYNC must be powered and working properly at the time of the incident and throughout feature activation and use.
- SYNC 911 Assist feature must be set on prior to the incident.
- A Bluetooth-enabled and compatible phone has to be paired and connected to SYNC.
- A connected Bluetooth-enabled phone must have the ability to make and maintain an outgoing call at the time of the incident.
- A connected Bluetooth-enabled phone must have adequate network coverage, battery power and signal strength.
- The vehicle must have battery power and be located in the United States, Canada or in a territory in which 911 is the emergency number.

***In the Event of a Crash***

Not all crashes deploy an airbag or activate the fuel pump shut-off (which would activate 911 Assist); however, if 911 Assist is triggered, SYNC tries to contact emergency services. If a connected phone is damaged or loses connection to SYNC, SYNC searches for, and tries to connect to, any available previously paired phone and tries to make the call to 911.

Before making the call:

- SYNC provides a short window of time (about 10 seconds) to cancel the call. Failure to cancel the call results in SYNC attempting to dial 911.
- SYNC says the following, or a similar message: “SYNC will attempt to call 911, to cancel the call, press Cancel on your screen or press and hold the phone button on your steering wheel.”

If the call is not cancelled and a successful call is made, a pre-recorded message is played for the 911 operator, then the occupant(s) in the vehicle is able to talk with the operator. Be prepared to provide your name, phone number and location immediately, because not all 911 systems are capable of receiving this information electronically.

***911 Assist May Not Work If***

- Your cellular phone or 911 Assist hardware was damaged in a crash.
- The vehicle’s battery or SYNC system has no power.
- The phone(s) paired and connected to the system was thrown from the vehicle.

***911 Assist Privacy Notice***

Once 911 Assist is set on, it may disclose to emergency services that the vehicle has been in a crash involving the deployment of an airbag or activation of the fuel pump shut-off. Certain versions or updates to 911 Assist may also be capable of electronically or verbally disclosing to 911 operators the vehicle location, and/or other details about the vehicle or crash to assist 911 operators to provide the most appropriate emergency services. If you do not want to disclose this information, do not turn the feature on.

---

**Vehicle Health Report**

**WARNING:** Always follow scheduled maintenance instructions, regularly inspect your vehicle, and seek repair for any damage or problem you suspect. Vehicle Health Report supplements, but cannot replace normal maintenance and vehicle inspection. Vehicle Health Report only monitors certain systems that are electronically monitored by the vehicle and will not monitor or report the status of any other system, (i.e., brake lining wear). Failure to perform scheduled maintenance and regularly inspect your vehicle may result in vehicle damage and serious injury.

**Note:** Your Vehicle Health Report feature requires activation prior to use. Visit [www.SYNCMYRide.com](http://www.SYNCMYRide.com) to register. There is no fee or subscription associated with Vehicle Health Report, but you must register to use this feature.

**Note:** This feature may not function properly if you have enabled caller ID blocking on your mobile phone. Before running a report, review the *Vehicle Health Report privacy notice*.

**Note:** In order to allow a break-in period for your vehicle, you may not be able to create a Vehicle Health Report until your vehicle odometer has reached 200 miles.

Register for Vehicle Health Report and set your report preferences at [www.SYNCMYRide.com](http://www.SYNCMYRide.com). After registering, you can request a Vehicle Health Report (inside your vehicle). Return to your account at [www.SYNCMYRide.com](http://www.SYNCMYRide.com) to view your report. You can also choose for SYNC to automatically remind you to run reports at specific mileage intervals. Cellular phone airtime usage may apply when reporting.

The system allows you to check your vehicle's overall health in the form of a diagnostic report card. The vehicle health report contains valuable information such as:

- Vehicle Diagnostic Information
- Scheduled maintenance
- Open Recalls and Field Service Actions
- Unserviced items from vehicle inspections by your authorized dealer.

You can run a report (after the vehicle has been running a minimum of 60 seconds) by pressing the voice button and saying “Vehicle health report”, or pressing the phone button.

To run a report using the phone button:

1. Press the phone button to enter Phone Menu.
2. Scroll until Vehicle Health is selected and press OK.
3. Scroll to select from the following options:

<b>Vehicle Health Report options</b>	
<b>User Preferences:</b> <b>Press OK to select and enter the menu.</b> <b>Scroll to select from:</b>	<p><b>Automatic Reports:</b> Press OK and select on or off. Select On to have SYNC automatically prompt you to run a health report at certain mileage intervals. <b>Note:</b> You must first turn this feature on before you can select the mileage intervals at which you would like to be prompted.</p> <p><b>Mileage Intervals:</b> Press OK. Scroll to select between 5000, 7500 or 10000 mile intervals and press OK to make your selection.</p> <p><b>Return:</b> Press OK to exit the menu.</p>
<b>Run Report?</b>	Press OK for SYNC to run a health report of your vehicle’s diagnostic systems and send the results to Ford where it is combined with scheduled maintenance information, open recalls and other field service actions and unserviced vehicle inspection items from your authorized dealer.

**Vehicle Health Report Privacy Notice**

When you run a Vehicle Health Report, Ford Motor Company may collect your cellular phone number (to process your report request) and diagnostic information about your vehicle. Certain versions or updates to Vehicle Health Report may also collect additional vehicle information. Ford may use the vehicle information it collects for any purpose. If you do not want to disclose your cellular phone number or vehicle information, do not run the feature or set up your Vehicle Health Report profile at [www.SYNCMYride.com](http://www.SYNCMYride.com). See [www.SYNCMYride.com](http://www.SYNCMYride.com) - Vehicle Health Report Terms and Conditions, and Privacy Statement - for more information.

---

**SYNC Services: Traffic, Directions & Information (TDI)  
(If Equipped, United States Only)**

**Note:** SYNC Services varies by trim level and model year and may require a subscription. Traffic alerts and turn-by-turn directions available in select markets. Message and data rates may apply. Ford Motor Company reserves the right to change or discontinue this product service at any time without prior notification or incurring any future obligation.

**Note:** SYNC Services requires activation prior to use. Visit [www.SYNCMYride.com](http://www.SYNCMYride.com) to register and check your eligibility for complimentary services. Standard phone and message rates may apply. Subscription may be required. You must also have the active SYNC Services Bluetooth-enabled cellular phone paired and connected to the system in order to connect to, and use, SYNC Services. See the *Using SYNC with your phone* for pairing instructions.

**Note:** This feature does not function properly if you have enabled caller ID blocking on your mobile phone. Make sure your mobile phone is not blocking caller ID before using SYNC Services.

**Note:** The driver is ultimately responsible for the safe operation of the vehicle, and therefore, must evaluate whether it is safe to follow the suggested directions. Any navigation features are provided only as an aid. Make your driving decisions based on your observations of local conditions and existing traffic regulations. Do not follow the route suggestions if doing so would result in an unsafe or illegal maneuver, if you would be placed in an unsafe situation, or if you would be directed into an area that you consider unsafe. Maps used by this system may be inaccurate because of errors, changes in roads, traffic conditions or driving conditions.

**Note:** When you connect, the service uses GPS technology and advanced vehicle sensors to collect the vehicle's current location, travel direction and speed to help provide you with the directions, traffic reports, or business searches you request. Further, to provide the services you request and for continuous improvement, the service may collect and record call details and voice communications. For more information, see SYNC Services Terms and Conditions at [www.SYNCMYride.com](http://www.SYNCMYride.com). If you do not want Ford or its service providers to collect the vehicle travel information or other information identified in the Terms and Conditions, do not activate or use the service.

SYNC Services uses advanced vehicle sensors, integrated GPS technology and comprehensive map and traffic data, to give you personalized traffic

reports, precise turn-by-turn directions, business search, news, sports, weather and more. For a complete list of services, or to learn more, please visit [www.SYNCMYRide.com](http://www.SYNCMYRide.com).

#### ***Connecting to SYNC Services Using Voice Commands***

1. Press the voice button.
2. When prompted, say “Services”. This initiates an outgoing call to SYNC Services using your paired and connected Bluetooth-enabled cellular phone.
3. Once you are connected to the service, follow the voice prompts to request the desired service, such as “Traffic” or “Directions”. You can also say “What are my choices?” to receive a complete list of available services from which to choose.
4. Say “Services” to return to the services main menu or for help, say “Help”.

#### ***Connecting to SYNC Services Using the Navigation Screen***

1. Select the Phone hard button.
2. Select the SYNC Apps soft button tab.
3. Select the SYNC Services soft button to connect to SYNC Services.

#### ***Receiving Turn-by-Turn Directions***

1. When connected to SYNC Services, say “Directions” or “Business search”. To find the closest business or type of business to your current location, just say “Business search” and then “Search near me”. If you need further assistance in finding a location you can say “Operator” at any time within a Directions or Business search to speak with a live operator. You may also be prompted to speak with an operator when the automatic system has difficulty matching your voice request. The live operator can assist you by searching for businesses by name or by category, residential addresses by street address or by name or specific street intersections. Operator Assist is a feature of your SYNC Services subscription. For more information on Operator Assist visit [www.SYNCMYRide.com/support](http://www.SYNCMYRide.com/support).
2. Follow the voice prompts to select your destination. Once your destination is selected, your current vehicle location is uploaded and a route based on current traffic conditions is calculated and sent back to your vehicle. After the route download is complete, the phone call is automatically ended. You then receive audible and visual driving instructions as you travel toward your destination.
3. While on an active route, you can select or say “Route summary” or “Route status” to view the Route Summary turn list or the Route Status ETA. You can also turn voice guidance on or off, cancel the route or update the route.

If you miss a turn, SYNC automatically asks if you want the route updated. Just say, “Yes” when prompted and a new route will be delivered to your vehicle.

**Disconnecting from SYNC Services**

1. Press and hold the phone button on the steering wheel.
2. Say “Good-bye” from the SYNC Services main menu.

<b>SYNC Services quick tips</b>	
<b>Personalizing</b>	You can personalize your Services feature to provide quicker access to your most used or favorite information. You can save address points such as work or home. You can also save favorite information like sports teams or a news category. To learn more, log onto <a href="http://www.SYNCMYride.com">www.SYNCMYride.com</a> .
<b>Push to interrupt</b>	Press the voice button at any time (while you are connected to SYNC Services) to interrupt a voice prompt or an audio clip (such as a sports report), wait for the listening tone, and say your voice command.
<b>Portable</b>	Your subscription is associated with your Bluetooth-enabled cellular phone number, not your VIN (Vehicle Identification Number). You can pair and connect your phone to any vehicle equipped with SYNC Services and continue enjoying your personalized services. You can even access your account outside the vehicle. Just use the number on your phone’s call history. Traffic and Directions features do not function properly but information services and the 411 connect and text message features are available.

**SYNC AppLink™**

**Note:** This feature is only available in the United States.

**Note:** Your smartphone must be paired and connected to SYNC to access AppLink.

**Note:** iPhone users need to connect the phone to the USB port in order to start the application. It is recommended to lock your iPhone after starting an application.

**Note:** The AppLink feature is not available if your vehicle is equipped with the MyFord Touch or MyLincoln Touch system.

Depending on your display type, you can access AppLink from the media menu, the phone menu, or by using voice commands. Once an app is running through AppLink, you can control main features of the app through voice commands and steering wheel controls.

**To Access Using the Phone Menu**

1. Press the Phone button.
2. Browse to Mobile Applications and press **OK**.
3. Browse to your desired app and press **OK**.
4. Once an app is running through SYNC, you can access an app's menu by pressing the **MENU** button to first access the SYNC menu.
5. Scroll until "<App name> Menu" is displayed (such as Pandora Menu), then press **OK**. From here, you can access an application's features, such as Thumbs up, Thumbs down, etc. For more information, please visit [www.SYNCMyRide.com](http://www.SYNCMyRide.com).

**To Access Using the Media Menu**

1. Press the **AUX** button to access the SYNC menu.
2. Press the Menu button to access the SYNC Media menu.
3. Browse to Mobile Applications and press **OK**.
4. Browse to your desired app and press **OK**.
5. Once an app is running through SYNC, you can access an app's menu by pressing the **MENU** button to first access the SYNC menu.
6. Scroll until "<App name> Menu" is displayed (such as Pandora Menu), then press **OK**. From here, you can access an application's features, such as Thumbs up, Thumbs down, etc. For more information, please visit [www.SYNCMyRide.com](http://www.SYNCMyRide.com).

**To Access Using the Navigation Screen (If Equipped)**

1. Press the Phone button.
2. Press the SYNC Apps tab.
3. Press Mobile Apps.
4. Select the app to start it.

**To Access Using Voice Commands**

1. Press the voice icon.
2. When prompted, say “Mobile Apps”.
3. Say the name of the application after the tone.
4. The app should start. While an app is running through SYNC, you can press the voice button and speak commands specific to the app, such as “Play Station Quickmix”. Say “Help” to discover available voice commands.

**USING SYNC WITH YOUR MEDIA PLAYER**

You can access and play music from your digital music player over the vehicle’s speaker system using the system’s media menu or voice commands. You can also sort and play your music by specific categories, such as artists or albums.

**Note:** The system is capable of indexing up to 30,000 songs.

SYNC is capable of hosting nearly any digital media player including: iPod, Zune™, Plays from device players, and most USB drives. SYNC also supports audio formats such as MP3, WMA, WAV and ACC.

**Connecting Your Digital Media Player via the USB Port**

**Note:** If your digital media player has a power switch, ensure that the device is turned on.

To connect using voice commands:

1. Plug the device into the vehicle’s USB port.
2. Press the voice icon and when prompted, say “USB”.
3. You can now play music by saying any of the appropriate voice commands. See the media voice commands.

To connect using the system menu:

1. Plug the device into the vehicle’s USB port.
2. Press AUX and then MENU to enter the Media Menu.
3. Scroll until Select Source appears and press OK.
4. Scroll to select USB and press OK.

5. Depending on how many digital media files are on your connected device, Indexing may appear in the radio display. When indexing is complete, the screen returns to the Play Menu.
6. Press OK and scroll through selections of:
  - Play All
  - Artists
  - Albums
  - Genres
  - Playlists
  - Tracks
  - Explore USB
  - Similar Music
  - Return

When the desired selection appears in the display, press OK to build your desired music selection.

**What’s Playing?**



At any time when a track is playing, you can press the voice icon and ask the system, “What’s playing?”. The system reads the metadata tags (if populated) of the playing track to you.

**Media Voice Commands**



Press the voice icon and, when prompted, say “USB” then any of the following:

<b>“USB”</b>
“Autoplay off”
“Autoplay on”
“(Phone) (Media) (Bluetooth) Connections”
“Pause”
“Play”
“Play album <name>” <sup>1,3</sup>
“Play all”
“Play artist <name>” <sup>1,3</sup>
“Play genre <name>” <sup>1,3</sup>
“Play next folder” <sup>2</sup>
“Play next track”

<b>“USB”</b>
“Play playlist <name>” <sup>1,3</sup>
“Play previous folder” <sup>2</sup>
“Play previous track”
“Play song <name>” <sup>1,3</sup>
“Play track <name>” <sup>1,3</sup>
“Refine album <name>” <sup>1,3</sup>
“Refine artist <name>” <sup>1,3</sup>
“Refine song <name>” <sup>1,3</sup>
“Refine track <name>” <sup>1,3</sup>
“Repeat off”
“Repeat on”
“Search album <name>” <sup>1,3</sup>
“Search artist <name>” <sup>1,3</sup>
“Search genre <name>” <sup>1,3</sup>
“Search song <name>” <sup>1,3</sup>
“Search track <name>” <sup>1,3</sup>
“Shuffle off”
“Shuffle on”
“Similar music”
“What’s playing?”

<sup>1</sup>“<name>” is a dynamic listing, meaning that it could be the name of any desired group, artist, etc.

<sup>2</sup>Voice commands which are only available in folder mode.

<sup>3</sup>Voice commands which are not available until indexing is complete.

<b>Voice command guide</b>	
<b>“Autoplay”</b>	Turn on to listen to music which has already been randomly indexed during the indexing process. Turn off and the system does not begin to play any of your music until all media has all been indexed. Indexing times can vary from device to device and also with regard to the number of songs being indexed.
<b>“Search/Play Genre”</b>	The system searches all the data from your indexed music and, if available, begins to play the chosen type of music. You can only play genres of music which are present in the GENRE metadata tags that you have on your digital media player.
<b>“Similar Music”</b>	The system compiles a playlist and then plays similar music to what is currently playing from the USB port using indexed metadata information.
<b>“Search/Play Artist/Track/Album”</b>	The system searches for a specific artist/track/album from the music indexed through the USB port.
<b>“Refine”</b>	This allows you to make your previous command more specific. For example, if you asked to search and play all music by a certain artist, you could then say “refine album” and choose a specific album from the list to view. If you then select Play, the system only plays music from that specific album.

Press the voice icon and when prompted say “Bluetooth Audio” and then any of the following:

<b>“BLUETOOTH AUDIO”</b>
“(Phone) (Media) (Bluetooth) Connections”
“Pause”
“Play”
“Play next track ”
“Play previous track ”

### Media Menu Features

The media menu allows you to select your media source, how to play your music (by artist, genre, shuffle, repeat, etc.), and also to add, connect or delete devices.

1. Press AUX and then MENU to enter the Media Menu.
2. Scroll to cycle through:

<b>When you select:</b>	<b>You can:</b>
<b>Play Menu</b>	Play your music by artist, album, genre, playlists, tracks, similar music or to simply, play all. You can also choose to Explore USB to view the supported digital music files on your playing device. See Play Menu later in this section for more information.

When you select:	You can:
<p><b>Select Source</b></p>	<p><b>SYNC USB:</b> Press OK to access music plugged into your USB port. You can also plug in devices to charge them (if supported by your device). Once connected, the system indexes any readable media files. (The time required to complete this depends on the size of the media content being indexed.) If Autoplay is on, you can access media files randomly as they are indexed. If turned off, indexed media is not available until the indexing process is complete. SYNC is capable of indexing thousands of average size media and notifies you if the maximum indexing file size is reached.</p> <p><b>Bluetooth Audio:</b> This is a phone-dependent feature which allows you to stream music playing on your Bluetooth-enabled phone. If supported by your device, you can press SEEK to play the previous or next track.</p> <p><b>SYNC Line In:</b> Press OK to select and play music from your portable music player over the vehicle's speakers.</p> <p><b>Note:</b> If you have already connected a device to the USB port, you cannot access the line in feature. Some digital media players require both USB and line in ports to stream data and music separately.</p>

When you select:	You can:
<b>Media Settings</b>	<p>Choose to shuffle or repeat your music and select your Autoplay settings. Once these selections are turned on, they remain on until turned off. Press SEEK to play the previous or next track.</p> <p><b>Note:</b> Some digital media players require both USB and line in ports to stream data and music separately. Press OK to select and then scroll to choose from:</p> <p><b>Shuffle:</b> Press OK to shuffle available media files in the current playlist. <b>Note:</b> To shuffle all media tracks, you must select Play All in the Play Menu and then select Shuffle.</p> <p><b>Repeat:</b> Press OK to repeat any song.</p> <p><b>Autoplay:</b> Press OK to listen to music which has already been randomly indexed during the indexing process.</p>
<b>Mobile Apps</b>	Interact with SYNC-capable mobile applications on your smart phone. See <i>SYNC AppLink</i> earlier in this chapter for more information.
<b>System Settings</b>	<p>Access Bluetooth Device menu listings (add, connect, set as primary, on/off, delete) as well as Advanced menu listings (prompts, languages, defaults, master reset, install application and system information).</p> <p><b>Note:</b> See System Settings for more information.</p>
<b>Exit Media Menu</b>	Press OK to exit the media menu.

**Accessing Your Play Menu**

This menu allows you to select and play your media by artist, album, genre, playlist, track, similar music or even to explore what is on your USB device.

1. Make sure that your device is plugged into the USB port and is turned on.
2. Press AUX and then MENU to enter the Media Menu.
3. Scroll to select the Play Menu and press OK.

If there are no media files to access, the display indicates there is no media. If there are media files, you have the following options to scroll through and select from:

When you select:	You can:
<b>Play All</b>	Play all indexed media (tracks) from your playing device in flat file mode, one at a time in numerical order. Press OK to select. The first track title appears in the display.
<b>Artists</b>	Sort all indexed media by artist. Once selected, the system lists and then play all artists and tracks alphabetically. If there are less than 255 indexed artist, they are listed alphabetically in flat file mode. If there are more, they are categorized in alphabetical categories. 1. Press OK to select. You can select to play All Artists or any indexed artist. 2. Scroll until the desired artist is chosen and press OK.

<b>When you select:</b>	<b>You can:</b>
<b>Albums</b>	<p>Sort all indexed media by albums. If there are less than 255 indexed albums, they are listed alphabetically in flat file mode. If there are more, they are organized into alphabetical categories.</p> <ol style="list-style-type: none"> <li>1. Press OK to enter the album menu and select from playing all albums or from any individual indexed album.</li> <li>2. Scroll until the desired album is chosen and press OK.</li> </ol>
<b>Genres</b>	<p>Sort indexed music by genre (category) type. SYNC lists the genres alphabetically in flat file mode. If there are more than 255, SYNC automatically organizes them into alphabetical categories.</p> <p>Press OK to select and then scroll to select the desired genre and press OK.</p>
<b>Playlists</b>	<p>Access your playlists (from formats such as ASX, .M3U, .WPL, .MTP.). The system lists your playlists alphabetically in flat file mode. If there are more than 255, they are organized into alphabetical categories.</p> <p>Press OK to select. Then scroll to select the desired playlist and press OK.</p>
<b>Tracks</b>	<p>Search for and play a specific track which has been indexed. SYNC lists your tracks alphabetically in flat file mode. If there are more than 255, SYNC automatically organizes them into alphabetical categories.</p> <p>Press OK to select. Then scroll to select the desired track and press OK.</p>

When you select:	You can:
<b>Explore USB</b>	<p>Explore all supported digital media on your media device connected to the USB port. You can only view media content which is compatible with SYNC; other files saved are not visible.</p> <p>Press OK to select. Then scroll to explore indexed media on your flash drive.</p>
<b>Similar Music</b>	<p>Play music similar to what is currently playing from the USB port. The system uses the metadata information of each song to compile a playlist for you.</p> <p>Press OK to select. The system creates a new list of similar songs and begins playing. The metadata tags must be populated for this feature to include each track.</p> <p><b>Note:</b> With certain playing devices, if your metadata tags are not populated, the tracks won't be available in voice recognition, play menu or similar music. However, if you place these tracks onto your playing device in "Mass Storage Device Mode", they are available in voice recognition, play menu browsing and similar music. Unknowns are placed into any unpopulated metadata tag.</p>
<b>Return</b>	Exit the current menu.

### System Settings

System settings provide access to your Bluetooth Devices and Advanced menu features.

The Bluetooth Devices menu allows you to add, connect and delete a device as turn the Bluetooth feature on and off.

Your Advanced menu allows you to access and set prompts, languages, defaults and perform a master reset.

#### **Bluetooth Devices Menu Options**

This menu allows you to add, connect and delete devices as well as turn Bluetooth on and off.

1. Press AUX and then MENU to enter the Media Menu.
2. Scroll until System Settings appears and select OK.
3. Scroll until Bluetooth Devices appears.
4. Press OK and then scroll to select from:

<b>When you select:</b>	<b>You can:</b>
<b>Add Bluetooth Device*</b>	<p>Allows you to pair additional devices to the system.</p> <ol style="list-style-type: none"> <li>1. Press OK to select and press OK again when Find SYNC appears in the display.</li> <li>2. Follow the directions in your phone's user guide to put your phone into discovery mode. A six-digit PIN appears in the display.</li> <li>3. When prompted on your phone's six-digit display, enter the PIN.</li> </ol>
<b>Connect Bluetooth Device</b>	<p>Connect a previously paired Bluetooth-enabled phone.</p> <ol style="list-style-type: none"> <li>1. Press OK to select and view a list of devices.</li> <li>2. Scroll until the desired device is chosen and press OK to connect the device.</li> </ol>

When you select:	You can:
<b>Set Bluetooth On/Off</b>	Turn the Bluetooth feature on and off. Press OK and scroll to toggle between On and Off. When the desired selection is chosen, press OK. Turning Bluetooth off disconnects all Bluetooth devices and deactivates Bluetooth features.
<b>Delete Device</b>	Delete a paired media device. Press OK and scroll to select the device. Press OK to confirm.
<b>Delete All Devices</b>	Delete all previously paired devices. Press OK to select.
<b>Return</b>	Exit the current menu.

\*This is a speed-dependent feature

**Advanced Menu Options**

This menu allows you to access settings such as prompts, language, performing a master reset as well as returning to factory defaults.

1. Press AUX and then MENU to access the Media Menu.
2. Scroll until System Settings appears and select OK.
3. Scroll until Advanced appears.
4. Press OK and then scroll to select from the following:

When you select:	You can:
<b>Prompts</b>	Have SYNC guide you via questions, helpful hints or ask you for a specific action. 1. Press OK to select and scroll to select between on or off. 2. Press OK when the desired selection appears in the display. SYNC takes you back to the Advanced menu.

<b>When you select:</b>	<b>You can:</b>
<b>Languages</b>	Choose from English, Francais and Espanol. The displays and prompts are in the selected language. 1. Press OK to select and then scroll through the languages. 2. Press OK when the desired selection appears in the display. 3. If you change the language setting, the display indicates that the system is updating. When complete, SYNC takes you back to the Advanced menu.
<b>Factory Defaults</b>	Return to the factory default settings. This selection does not erase your indexed information (phonebook, call history, text messages and paired devices). 1. Press OK to select and then press OK again when Restore Defaults? appears in the display. 2. Press OK to confirm.
<b>Master Reset</b>	Completely erase all information stored on SYNC (all phonebook, call history, text messages and all paired devices) and return to the factory default settings.
<b>Application</b>	Download new software applications (if available) and then load the desired applications through your USB port. See the web site for more information.
<b>Return</b>	Exit the current menu.

**TROUBLESHOOTING**

Your SYNC system is easy to use. However, should questions arise, see the tables below.

Use the website at any time to check your phone’s compatibility, register your account and set preferences as well as access a customer representative via an online chat (during certain hours). Visit [www.SYNCMYride.com](http://www.SYNCMYride.com), [www.SYNCMYride.ca](http://www.SYNCMYride.ca) or [www.syncmaroute.ca](http://www.syncmaroute.ca) for more information.

Phone issues		
Issue	Possible cause(s)	Possible solution(s)
Excessive background noise during a phone call.	The audio control settings on your phone may be affecting SYNC performance.	Review your phone’s user guide regarding audio adjustments.
During a call, I can hear the other person but they cannot hear me.	Possible phone malfunction.	Try turning off the device, resetting the device, removing the device’s battery, then trying again.
SYNC is not able to download my phonebook.	<ul style="list-style-type: none"> <li>• This is a phone-dependent feature, OR</li> <li>• Possible phone malfunction.</li> </ul>	<ul style="list-style-type: none"> <li>• Go to the website to review your phone’s compatibility.</li> <li>• Try turning off the device, resetting the device or removing the device’s battery, then trying again.</li> <li>• Try pushing your phonebook contacts to SYNC by using the Add Contacts feature.</li> <li>• Use the SYNCmyphone feature available on the website.</li> </ul>

Phone issues		
Issue	Possible cause(s)	Possible solution(s)
The system says Phonebook Downloaded but my phonebook in SYNC is empty or is missing contacts.	Limitations on your phone's capability.	<ul style="list-style-type: none"> <li>• Try pushing your phonebook contacts to SYNC by using the Add Contacts feature.</li> <li>• If the missing contacts are stored on your SIM card, try moving them to the device memory.</li> <li>• Remove any pictures or special ring tones associated with the missing contact.</li> </ul>
I am having trouble connecting my phone to SYNC.	<ul style="list-style-type: none"> <li>• This is a phone-dependent feature, OR</li> <li>• Possible phone malfunction.</li> </ul>	<ul style="list-style-type: none"> <li>• Go to the website to review your phone's compatibility.</li> <li>• Try turning off the device, resetting the device or removing the device's battery, then trying again.</li> <li>• Try deleting your device from SYNC, deleting SYNC from your device and trying again.</li> <li>• Check the security and auto accept/prompt always settings relative to the SYNC Bluetooth connection on your phone.</li> <li>• Update your device's software firmware.</li> <li>• Turn off the Auto phonebook download setting.</li> </ul>

Phone issues		
Issue	Possible cause(s)	Possible solution(s)
Text messaging is not working on SYNC.	<ul style="list-style-type: none"> <li>• This is a phone-dependent feature, OR</li> <li>• Possible phone malfunction.</li> </ul>	<ul style="list-style-type: none"> <li>• Go to the website to review your phone's compatibility.</li> <li>• Try turning off the device, resetting the device or removing the device's battery, then trying again.</li> </ul>

USB and media issues		
Issue	Possible cause(s)	Possible solution(s)
I am having trouble connecting my device.	Possible device malfunction.	<ul style="list-style-type: none"> <li>• Try turning off the device, resetting the device or removing the device's battery, then trying again.</li> <li>• Make sure you are using the manufacturer's cable.</li> <li>• Make sure the USB cable is properly inserted into the device and the vehicle's USB port.</li> <li>• Make sure that the device does not have an auto-install program or active security settings.</li> </ul>
SYNC does not recognize my device when I turn on the car.	This is a device limitation.	Make sure you are not leaving the device in your vehicle during very hot or cold temperatures.

<b>USB and media issues</b>		
<b>Issue</b>	<b>Possible cause(s)</b>	<b>Possible solution(s)</b>
Bluetooth audio does not stream.	<ul style="list-style-type: none"> <li>• This is a phone-dependent feature, OR</li> <li>• The device is not connected.</li> </ul>	Make sure the device is connected to SYNC and that you have pressed play on your device.
SYNC does not recognize music that is on my device.	<ul style="list-style-type: none"> <li>• Your music files may not contain the proper artist, song title, album or genre information, OR</li> <li>• The file may be corrupted, OR</li> <li>• The song may have copyright protection which does not allow it to play.</li> </ul>	<ul style="list-style-type: none"> <li>• Make sure that all song details are populated.</li> <li>• Some devices require you to change the USB settings from mass storage to MTP class.</li> </ul>

<b>Vehicle Health Report and SYNC Services (Traffic, Directions and Information) issues</b>		
<b>Issue</b>	<b>Possible cause(s)</b>	<b>Possible solution(s)</b>
I received a text that the Vehicle Health Report is not activated.	<ul style="list-style-type: none"> <li>• Your account may not be activated on the website, OR</li> <li>• You may have the wrong VIN (vehicle identification number) listed.</li> </ul>	<ul style="list-style-type: none"> <li>• This is a free feature, but you must first register online to use it.</li> <li>• Make sure that your VIN is correctly listed in your account.</li> </ul>

<b>Vehicle Health Report and SYNC Services (Traffic, Directions and Information) issues</b>		
<b>Issue</b>	<b>Possible cause(s)</b>	<b>Possible solution(s)</b>
I am unable to retrieve the report on the website, or I receive a system error.	The preferred dealer information did not load correctly.	When you register your account, you must list a preferred dealer. If one is already listed, try selecting another dealer and logging out. Log back in and change it back to your preferred dealer and retrieve the report.
I am unable to submit a report.	<ul style="list-style-type: none"> <li>• This could be due to your phone's compatibility, OR</li> <li>• Bad signal strength, OR</li> <li>• Your phone may not be activated on the website.</li> </ul>	<ul style="list-style-type: none"> <li>• Update your mobile number in your account on the website.</li> <li>• Make sure you have full signal strength and that your <i>Bluetooth</i> volume level has been turned up.</li> <li>• Try deleting your phone and performing a clean pairing.</li> </ul>
I heard a commercial when I tried to use Traffic, Directions and Information.	<ul style="list-style-type: none"> <li>• The phone in use is not activated, OR</li> <li>• Your phone has ID blocker active.</li> </ul>	<ul style="list-style-type: none"> <li>• This is a free feature, but you must first register online to use it.</li> <li>• Turn off ID blocker on your phone as the system recognizes you by your phone number.</li> <li>• Make sure the currently connected phone is the same one that is registered on your SyncMyRide account.</li> </ul>

<b>Voice command issues</b>		
<b>Issue</b>	<b>Possible cause(s)</b>	<b>Possible solution(s)</b>
SYNC does not understand what I am saying.	<ul style="list-style-type: none"> <li>• You may be using the wrong voice commands, OR</li> <li>• You may be speaking too soon or at the wrong time.</li> </ul>	<ul style="list-style-type: none"> <li>• Review the Phone voice commands and the Media voice commands at the beginning of their respective sections.</li> <li>• Be aware that SYNC's microphone is either in your rear view mirror or in the headliner just above the windshield.</li> </ul>
SYNC does not understand the name of a song or artist.	<ul style="list-style-type: none"> <li>• You may be using the wrong voice commands, OR</li> <li>• You may not be saying the name exactly as it is saved, OR</li> <li>• The system may not be reading the name the same way you are saying it.</li> </ul>	<ul style="list-style-type: none"> <li>• Review the media voice commands at the beginning of the media section.</li> <li>• Say the song or artist exactly as listed. If you say, "Play Artist Prince", the system does not play music by Prince and the Revolution or Prince and the New Power Generation.</li> <li>• Make sure you are saying the complete title, such as "California remix featuring Jennifer Nettles".</li> <li>• If the songs are saved in all CAPS, you have to spell them. LOLA requires you to say, "Play L-O-L-A".</li> <li>• Do not use special characters in the title as the system does not recognize them.</li> </ul>

<b>Voice command issues</b>		
<b>Issue</b>	<b>Possible cause(s)</b>	<b>Possible solution(s)</b>
<p>SYNC does not understand or is calling the wrong contact when I want to make a call.</p>	<ul style="list-style-type: none"> <li>• You may be using the wrong voice commands, OR</li> <li>• You may not be saying the name exactly as it is saved, OR</li> <li>• Contacts in your phonebook may be very short and similar, or they may contain special characters, OR</li> <li>• Your phonebook contacts may be saved in CAPS.</li> </ul>	<ul style="list-style-type: none"> <li>• Review the phone voice commands at the beginning of the phone section.</li> <li>• Make sure you are saying the contacts exactly as listed. For example, if a contact is saved as Joe Wilson, say “Call Joe Wilson”.</li> <li>• The system works better if you list full names, such as “Joe Wilson” rather than “Joe”.</li> <li>• Do not use special characters such as 123 or ICE, as the system does not recognize them.</li> <li>• If contacts are saved in CAPS, you have to spell them. JAKE requires you to say, “Call J-A-K-E”.</li> </ul>

<b>AppLink issues</b>		
<b>Issue</b>	<b>Possible cause(s)</b>	<b>Possible solution(s)</b>
<p>SYNC does not find any mobile apps that are on my phone.</p>	<ul style="list-style-type: none"> <li>• Your device may not support the AppLink feature, OR</li> <li>• The application does not support AppLink., OR</li> <li>• If you have an iPhone, it may not be plugged in, OR</li> <li>• Your phone may not be paired or connected.</li> </ul>	<ul style="list-style-type: none"> <li>• Check the website for compatible devices and applications.</li> <li>• Make sure your device is paired and connected. If you have an iPhone, make sure it is plugged in using the USB and that the application is running in the foreground.</li> </ul>

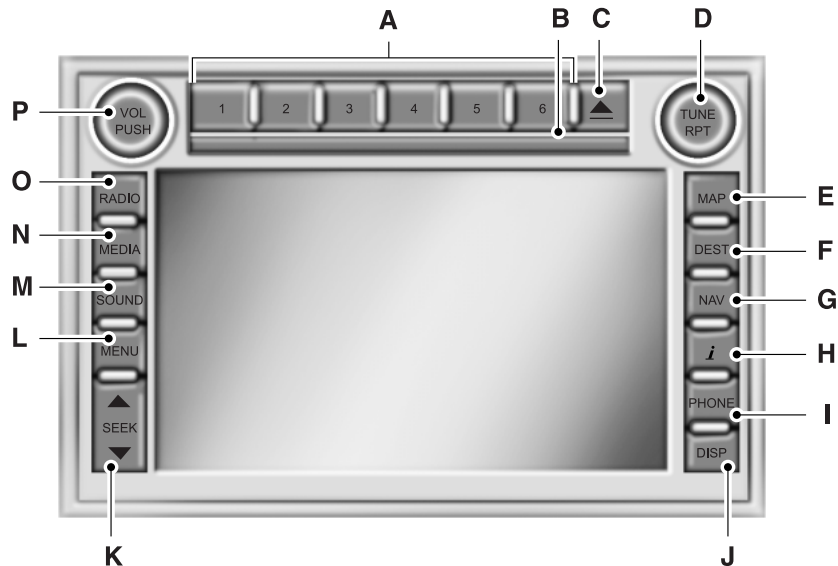

### NAVIGATION CONTROLS



**WARNING:** Driving while distracted can result in loss of vehicle control, crash and injury. We strongly recommend that you use extreme caution when using any device that may take your focus off the road. Your primary responsibility is the safe operation of your vehicle. We recommend against the use of any hand-held device while driving and encourage the use of voice-operated systems when possible. Make sure you are aware of all applicable local laws that may affect the use of electronic devices while driving.

The system divides the screen in two sections after it initializes:

- **Status bars:** This is the top and bottom portion of the screen. It displays the clock or date and other useful information, depending on which mode you are in.
- **Display area:** The touchscreen changes depending on current system operation. Different buttons display in this area, depending on which mode you are in.

**Note:** Some features, such as Sirius satellite radio, may not be available in your location. Check with an authorized dealer.

**A. Memory presets:**

- Store your favorite radio stations. To store a radio station, tune to the station, then press and hold a preset button until sound returns.
- In radio and satellite radio mode, press a button to access your saved presets or channels.

**B. CD and DVD slot:** Insert a CD or DVD, label side up.

**C. Eject:** Press this button to eject a CD or DVD from the system.

**D. TUNE RPT:**

- In radio or satellite radio mode, turn the control to advance in individual increments up or down the frequency band to the desired station.
- In MP3 mode, turn the control to advance to the next or previous folder.
- In navigation mode, press this button to hear the last spoken navigation guidance prompt.

**E. MAP:**

- Press this button to access the navigation map.
- Press while the map display is active to center the map on the current vehicle position. Press while the map display and route are active to see the different map guidance views.

**F. DEST:**

- Press this button to access the destination entry menu.
- Press while the destination entry menu is active to show additional destination entry techniques.

**G. NAV:**

- Press this button to access the navigation menu.
- Press while the navigation menu is active to access the navigation menu tabs.

**H. I (Information):** Press this button to access features such as Where am I?, Sirius Travel Link, Calendar, System Info and Help.

**I. PHONE:** Press this button to access the SYNC phone menu.

**J. DISP:** Press this button to select a display mode: On, Status Bar Only, and Off.

**K. SEEK:**

- In radio and satellite radio mode, press the arrow buttons to find previous or next available stations or channels within the currently selected Category or Genre.
- In CD and DVD modes, press the arrow buttons to select the previous or next track or chapter.

## 412 Navigation System (If Equipped)

---

### L. **MENU:**

- Press this button to access the system menu.
- Press while the system menu is active to access the menu tabs of Display, Clock, Feedback Settings, System Settings and Valet Mode.

### M. **SOUND:**

- Press this button to access the sound menu.
- Press while the sound menu is active to access the menu tabs of Bass/Treble, Balance/Fade, SCV (Speed Compensated Volume), DSP (Digital Signal Processing) and Visualizer.

### N. **MEDIA:**

- Press this button to access the media menu.
- Press while the media menu is active to access the available sources of CD/DVD, Jukebox and User Device.

### O. **RADIO:**

- Press this button to access the radio menu.
- Press while the radio menu is active to access the available sources of AM, FM1, FM2, SAT1, SAT2, and SAT3.

P. **VOL:** Press and hold this button to turn the system off and on. Turn the control to adjust the volume.

**Note:** If a navigation route is active when the navigation system is off, the system resumes the route when you turn the system on.

## DISPLAY MODE

You can choose to turn your screen on or off and if you would like to view the status bars on the top and bottom of the screen. Press DISP to see the options.

### **Display Mode Voice Commands**



The following voice commands are available in display mode. If you are not in display mode, press the voice button on the steering wheel. When prompted, say “Display mode” and then any of the following commands.

Display mode voice commands
“Display on”
“Display off”
“Status bar”
“Brighter”
“Dimmer”

Display mode voice commands
“Day”
“Night”
“Auto”
“Help”

**STATUS BARS**



The top status bar shows the current mode, exterior temperature, time and display icons if you have enabled Bluetooth or other options.



The bottom status bar shows the Home icon and may show the Artist and Title of the currently playing CD, Artist and Title for Jukebox and radio.

**Customizing Your Home Screen**

Depending on your vehicle’s option package and software, your screens may vary in appearance from the screens shown in this section. Your features may also be limited depending on your market. Check with an authorized dealer for availability.



Press the house icon to access the home screen. Here you can:

- Save or view pictures.
- View your current audio settings.
- Display the audio visualizer.

You can split the screen in to two different sections, or you can choose to have one main view.

- The left side displays an uploaded photo or the map screen.
- The right side displays an uploaded photo or the radio and visualizer.

## 414      **Navigation System (If Equipped)**

---

### **Loading Photos**

**Note:** The system is not compatible with discs written in Packet Write mode.

Your system allows you to upload and view up to 32 photos.

Only the photograph(s), which meets the following conditions, display:

- The file must be 1.5MB or smaller.
- The file extension must be .jpe, .jpg or .jpeg.
- The file path must be 255 characters or fewer.
- Up to 256 files or folders can display in one folder.
- The CD or DVD must be ISO 9660 format; the system does not support UDF format.

To load photos:

1. Touch the left side of the home screen.
2. Touch the Add button. When the disclaimer appears asking to confirm the supported photo formats, press OK.
3. Insert a CD-ROM that contains your photos.
4. Touch OK. The right side of the screen displays a list of the photos.
5. Select either Add or Add All to save photos to the hard drive.

### **Editing and Deleting Photos**

To edit photos, go to the home screen, then:

1. Touch the current photo on the home screen.
2. Select the Edit button.
3. Adjust the photo by zooming in or out, moving right, left, up or down and rotating left or right.

**Note:** Press the Reset button to return to the original image.

To delete a photo, select the Delete button.

To delete all photos:

1. Press the Menu hard button.
2. Select the System Settings tab on the touchscreen.
3. Press the View button for Delete Stored Items.
4. Select Saved photos.

### **Using the Touch-sensitive Controls on Your System**

To turn a feature on and off, just touch the graphic with your finger.

To get the best performance from the touch-sensitive controls:

- Make sure your hands are clean and dry.
- Since the touchscreen operates based on the touch of a finger, you may have trouble using it if you are wearing gloves.

- Use your bare finger to touch the center of a touch-control graphic. Touching off-center of the graphic may affect operation of a nearby control.
- Do not press hard on the controls. They are sensitive to light touch.
- Keep metal and other conductive material away from the surface of the touchscreen as this may cause electronic interference (for example, inadvertently turning on a feature other than the one you meant to turn on).

**Cleaning the Touchscreen Display**

Use a clean, soft cloth such as one used for cleaning glasses. If dirt or fingerprints are still visible, apply a small amount of alcohol to the cloth. Do not pour or spray alcohol onto the display. Do not use detergent or any type of solvent to clean the display.

**USING VOICE RECOGNITION**

This system helps you control many features using voice commands. This allows you to keep your hands on the wheel and focus on what is in front of you. The system provides feedback through audible tones, prompts, questions and spoken confirmations depending on the situation and the chosen level of interaction (voice settings).

The system also asks short questions (confirmation prompts) when it is not sure of your request or when there are multiple possible responses to your request.

When using voice commands, words and icons may appear in the lower left status bar indicating the status of the voice session (such as Listening, Success, Failed, Paused or Try Again).

**How To Use Voice Commands with Your System**



Press the voice icon; after the tone, speak your command clearly.

You can say these commands at any time.	
“Audio”	“Navigation”
“CD”	“Radio”
“Disc”	“SYNC”*
“Display mode”	“Tutorial”

## 416 Navigation System (If Equipped)

You can say these commands at any time.	
“DVD”	“User profile”
“Jukebox”	“Video CD”
“Line in”	“Voice settings”
“Mobile apps”	“Help”

\*See the *SYNC* chapter for more information on these features.

To access a list of all available voice commands, press the I hard button. Select the Help tab on the touchscreen, then the Voice Commands tab and choose the desired category.

### Helpful Hints

- Make sure the interior of your vehicle is as quiet as possible. Wind noise from open windows and road vibrations may prevent the system from correctly recognizing spoken commands.
- After pressing the voice icon, wait until after the tone sounds and Listening appears before saying a command. Any command spoken prior to this does not register with the system.
- Speak naturally, without long pauses between words.
- At any time, you can interrupt the system while it is speaking by pressing the voice icon.

### Voice Settings

Voice settings allow you to customize the level of system interaction, help and feedback. The system defaults to standard interaction, which uses candidate lists, and confirmation prompts as these provide the highest level of guidance and feedback.

**Interaction Mode:** Novice mode provides detailed interaction and guidance while the advanced mode has less audible interaction and more tone prompts.

**Confirmation Prompts:** The system uses these short questions to confirm your voice request. If turned off, the system simply makes a best guess as to what you requested. The system may still occasionally ask you to confirm settings.

**SYSTEM MENU FEATURES**

Your system offers many menu features, such as allowing you to adjust the touchscreen brightness, time and language, feedback and system settings. You can access these options by pressing the MENU hard button.

If you select:	You can:
<p><b>Display</b></p>	<p><b>Brightness</b> allows you to adjust screen brightness by touching + or -.</p>
	<p><b>Contrast</b> allows you to adjust screen contrast by touching + or -.</p>
	<p><b>Day/Night Mode</b> allows you to select Day mode, Night mode or have the system automatically switch for you by selecting Auto mode.</p>
	<p><b>Daytime Color</b> allows you to select a light or dark color for daytime screen lighting.  <b>Note:</b> When the headlamps are on under very bright outdoor light conditions, the system remains in day mode, even if you select night.</p>
<p><b>Clock</b></p>	<p><b>Display Clock</b> allows you to turn the clock off and on.  <b>Note:</b> If your vehicle is equipped with an in-dash analog clock, you can set the time on this screen, but it may not appear in the status bar for viewing purposes.</p>
	<p><b>Format</b> allows you to switch between 12- and 24-hour clock displays.</p>
	<p><b>Auto Time Zone</b> allows you to have the system automatically switch the time whenever you enter a new time zone.  <b>Note:</b> The system does not implement daylight savings time.</p>
	<p><b>Restore Defaults</b> allows you to restore system defaults.</p>

If you select:	You can:
<b>Feedback Settings</b>	<b>Touch Screen Button Beep</b> allows you to select when the system sounds an audible tone: All Buttons (whenever any system button is touched), Touch Screen (only when touchscreen selections are made) or Off (no audible tones at all).
	<b>Voice Volume</b> allows you to change navigation voice and audible tone volume by touching + or -.
	<b>Satellite Radio Channel Name</b> allows you to choose to display the satellite radio channel name.
	<b>Voice Recognition Interaction Mode</b> allows you to choose the level of system interaction and feedback. Standard is the default and provides the most interaction and feedback using prompts. Advanced uses less feedback and prompts.
	<b>Voice Recognition Confirmation</b> allows you to choose level of voice command confirmation. Selecting On causes the system to ask you to confirm a command. Selecting Off causes the system to ask for confirmation less frequently.
	<b>Voice Recognition User Profile</b> allows you to switch between user profiles. Train the system to recognize your voice better. You can create two profiles. See <i>Using voice recognition</i> earlier in this section.
	<b>Manage Voice Rec. User profiles</b> allows you to edit Profile 1 or 2 by creating a new profile or deleting a previously created profile.

If you select:	You can:
<p><b>System Settings</b></p>	<p><b>Language</b> allows you to choose between English, Spanish and French.</p>
	<p><b>Units</b> allows you to choose between English and Metric measurements.</p>
	<p><b>Keyboard Layout</b> allows you to choose between an ABC and QWERTY keyboard.</p>
	<p><b>Delete Stored Items</b> allows you to choose to delete all of the entries from Address Book, Previous Destinations, Avoid Areas, Saved Photos and Voice Recognition Profiles. Touch View to see what entries have been stored.</p>
	<p><b>Restore Factory Default Settings</b> allows you to restore factory default settings.</p>
<p><b>Valet Mode</b></p>	<p>Lock and unlock the system using a four-digit PIN.  <b>Note:</b> You can reset the PIN by simultaneously pressing and holding presets 1 and 5 while on the PIN entry screen. After approximately five seconds, the system transitions to the valet mode screen indicating that you reset the PIN. Once you have reset the PIN, the system then allows you to set a new PIN.</p>
<p><b>Voice Control</b></p>	<p>Set the system to listen automatically for USB or SYNC voice commands first. This eliminates the need to say “USB” or “User Device” before any SYNC media commands.</p>

## 420 Navigation System (If Equipped)

### ENTERTAINMENT

Your system offers many media options. You can access these options using the touchscreen or voice commands.

#### AM/FM Radio



Press the RADIO hard button.

To change between AM, FM1 and FM2, touch the AM or FM tab. You can also access satellite radio by pressing this button.

See **Sirius satellite radio** later in this section for more information.

When you select:	You can:
<b>Show Options</b>	<b>Scan</b> allows you to hear a brief sampling of all radio stations.
	<b>Scan Presets</b> allows you to hear a brief sampling of all stations stored in the memory presets.
	<b>Autoset Presets</b> allows you to store the strongest local stations available in the AM and FM frequency bands.
	<b>HD Radio</b> turns HD radio on. This allows you to receive radio broadcasts digitally (where available), providing free, crystal-clear sound. See the <i>HD Radio™ information</i> in the following section.*
	<b>Multicast</b> allows you to choose which HD radio broadcast you would like to receive. When HD Radio broadcasts are available, this button appears if the selected station has more than one digital broadcast. HD1 signifies the main programming status and is available in analog and digital broadcasts. Any additional multicast stations (HD2 through HD8) broadcast digitally. You can access these by pressing Multicast. See the <i>HD Radio™ information</i> in the following section.**

When you select:	You can:
<b>Show Presets</b>	View the preset stations. Save a station by pressing and holding one of the memory preset areas. There is a brief mute while the radio saves the station. Sound returns when finished.
<b>Set PTY/All</b>	Select a category of music you would like to search for and then choose to either seek or scan for the stations.** <b>Note:</b> The system scans the frequency band three times for the chosen program type. If the program type is unavailable in your reception range, the system returns to the previous station.

\*This feature is only available in the United States.

\*\*This feature is only available on the FM1 and FM2 radio tabs in the United States.

**Audio and Radio Voice Commands**



If you are listening to the audio system, press the voice button on the steering wheel control. When prompted, say any of the commands in the following chart.

If you are not listening to the audio system, press the voice button and, after the tone, say “Audio”, then any of the commands in the following chart.

“AUDIO”		
“CD”	“Line in”	“Sirius”
“Disc”	“Off ”	“SYNC”
“DVD”	“On”	“USB”
“Headphones”	“Phone”	“User Device”
“Headphones off”	“Radio”	“Video CD”
“Jukebox”	“Read Message”	“Help”

## 422 Navigation System (If Equipped)



If you are listening to the radio, press the voice button on the steering wheel control. When prompted, say any of the commands in the following chart.

If you are not listening to the radio, press the voice button and, after the tone, say “Radio”, then any of the commands in the following chart.

“RADIO”		
“<530-1710>”	“FM2”	“Store preset <1-6>”
“<87.7-107.9>”	“FM2 preset <1-6>”	“Store AM preset <1-6>”
“AM”	“Off ”	“Store FM 1 preset <1-6>”
“AM <530-1710>”	“On”	“Store FM 2 preset <1-6>”
“AM preset <1-6>”	“Preset <1-6>”	“Store autoset presets”
“FM <87.7-107.9>”	“Seek down”	“Tune”**
“FM1”	“Seek up”	“Help”
“FM1 preset <1-6>”	“Store”*	

\*If you have said, “Store”, see the following “Store” chart.

\*\*If you have said, “Tune”, see the following “Tune” chart.

“TUNE”		
“<530-1710>”	“AM preset <1-6>”	“FM2”
“<87.7-107.9>”	“FM <87.7-107.9>”	“FM2 preset <1-6>”
“AM”	“FM1”	“Preset <1-6>”
“AM <530-1710>”	“FM1 preset <1-6>”	“Help”

“STORE”
“Preset <1-6>”
“AM preset <1-6>”
“FM 1 preset <#>”
“FM 2 preset <#>”
“Autoset presets”

**HD Radio™ Information (If Available)**

**Note:** HD Radio broadcasts are not available in all markets.

HD Radio technology is the digital evolution of analog AM/FM radio. Your system has a special receiver that allows it to receive digital broadcasts (where available) in addition to the analog broadcasts, it already receives. Digital broadcasts provide a better sound quality than analog broadcasts with free, crystal-clear audio and no static or distortion. For more information, and a guide to available stations and programming, please visit [www.hdradio.com](http://www.hdradio.com).

When HD Radio is on and you tune to a station broadcasting HD Radio technology, you may notice the following indicators on your screen:



**HD) logo** blinks when acquiring a digital station and stays solid when digital audio is playing. When this logo is available, you may also see Title and Artist fields on-screen.

**Multicast indicator** appears in FM mode (only) if the current station is broadcasting multiple digital broadcasts. The highlighted numbers signify available digital channels where new or different content is available. HD1 signifies the main programming status and is available in analog and digital broadcasts. Other multicast stations (HD2 through HD7) are only available digitally.

When HD Radio broadcasts are active, you can access the following functions:

When you select:	You can:
<b>Scan</b>	Hear a brief sampling of all available stations. This feature still works when HD Radio reception is on, although it does not scan for HD2-HD7 channels. You may see the HD logo appear if the station has a digital broadcast.
<b>Seek</b>	Hear the next strong radio station. If the current station has multiple digital broadcasts, the multicast indicator appears. Press Seek repeatedly to advance through all available broadcasts. If you are on the last multicast channel, press Seek to advance to the next strong station.

When you select:	You can:
<b>Tune</b>	Go up and down the frequency in individual increments. If the current station has multiple digital broadcasts, the multicast indicator appears. Press Tune repeatedly to advance through all available broadcasts. If you are on the last broadcast channel, press to advance to the next frequency on the band.
<b>Set PTY/All</b>	Select a category of music you would like to search for and then choose to either seek or scan for the stations. <b>Note:</b> The system scans the frequency band three times for the chosen program type. If the program type is unavailable in your reception range, the system returns to the previous station.
<b>Multicast</b>	Allows you to choose which HD radio broadcast you would like to receive. When HD Radio broadcasts are available, this button appears if the selected station has more than one digital broadcast. HD1 signifies the main programming status and is available in analog and digital broadcasts. Any additional multicast stations (HD2 through HD8) broadcast digitally. You can access these by pressing Multicast.

When you select:	You can:
To save a multicast station as a preset	When the channel is active on-screen, press and hold a memory preset slot until the sound returns. There is a brief mute while the radio saves the station. Sound returns when finished. When recalling a HD2 or HD3 memory preset, there is a mute before the digital audio plays, as the system must once again acquire the digital signal. As with any saved radio station, you cannot access the saved station if your vehicle is outside the station's reception area.

**HD Radio Reception and Station Troubleshooting**

Potential Reception Issues	
<b>Reception area</b>	If you are listening to a multicast station and you are on the fringe of the reception area, the station may mute due to weak signal strength. If you are listening to HD1, the system switches back to the analog broadcast until the digital broadcast is available again. However, if you are listening to any of the possible HD2-HD7 multicast channels, the station mutes and stay muted unless it is able to connect to the digital signal again.
<b>Station blending</b>	When the system first receives a station (aside from HD2-HD7 multicast stations), it first plays the station in the analog version. Once the receiver verifies the station is an HD Radio station, it shifts to the digital version. Depending on the station quality, you may hear a slight sound change when the station changes from analog to digital. Blending is the shift from analog to digital sound or digital back to analog sound.

## 426 Navigation System (If Equipped)

In order to provide the best possible experience, use the contact form to report any station issues found while listening to a station broadcasting with HD Radio technology. Independent entities own and operate each station. These stations are responsible for ensuring all audio streams and data fields are accurate.

Potential Station Issues		
Issue	Cause	Action
Echo, stutter, skip or repeat in audio. Increase or decrease in audio volume.	This is poor time alignment by the radio broadcaster.	No action required. This is a broadcast issue.
Sound fading or blending in and out.	The radio is shifting between analog and digital audio.	No action required. The reception issue may clear up as you continue to drive.
There is an audio mute delay when selecting HD2 or HD3, multicast preset or Direct Tune.	The digital multicast is not available until the HD Radio broadcast is decoded. Once decoded, the audio is available.	No action required. This is normal behavior. Wait until the audio is available.
Cannot access HD2 or HD3 multicast channel when recalling a preset or from a direct tune.	The previously stored multicast preset or direct tune is not available in your current reception area.	No action required. The station is not available in your current location.
Text information does not match currently playing audio.	Data service issue by the radio broadcaster.	Fill out the station issue form at website listed below.*
There is no text information shown for currently selected frequency.	Data service issue by the radio broadcaster	Fill out the station issue form at website listed below.*

Potential Station Issues		
Issue	Cause	Action
HD2-HD7 stations not found when Scan is pressed.	Pressing Scan disables HD2-HD7 channel search.	No action required. This is normal behavior.

\*[http://www.ibiquity.com/automotive/report\\_radio\\_station\\_experiences](http://www.ibiquity.com/automotive/report_radio_station_experiences)

HD Radio Technology manufactured under license from iBiquity Digital Corp. U.S. and foreign patents. HD Radio and the HD and HD Radio logos are proprietary trademarks of iBiquity Digital Corp. Ford Motor Company and iBiquity Digital Corp. are not responsible for the content sent using HD Radio technology. Content may be changed, added or deleted at any time at the station owner's discretion.

**HD Radio Voice Commands**



If you are listening to the radio, press the voice button on the steering wheel control. When prompted, say any of the commands in the following chart.

If you are not listening to the radio, press the voice button and, after the tone, say "Radio", then any of the commands in the following chart.

"RADIO"
"<87.7 - 107.9> HD <1-8>"
"FM <87.7-107.9> HD <1-8>"
"Tune"*
"Help"

\*If you have said, "Tune", see the following "Tune" chart.

"TUNE"
"<87.7 - 107.9> HD <1-8>"
"FM <87.7-107.9> HD <1-8>"
"Tune HD <1-8>"
"Help"

## 428 Navigation System (If Equipped)

### Sirius® Satellite Radio (If Activated)



Press the RADIO hard button, then select SAT on the touchscreen.

<b>When you select:</b>	<b>You can:</b>
<b>SAT123</b>	Press this button to access three different satellite radio modes (SAT1, SAT2 or SAT3).
<b>Scan</b>	Press this button to hear a brief sampling of all satellite radio channels within the current genre.
<b>Scan Presets</b>	Press these buttons to hear a brief sampling of all channels stored in the memory presets.
<b>Channel Guide</b>	See a list of channels sorted by genre and also skip or lock out certain channels. Select the desired genre and choose a channel by pressing the channel name button. You can then choose to Skip or Lock a certain channel. A skipped channel is not accessible using the tune knob, scan or seek functions. (To access the skipped channel, select Direct Tune and enter the channel number.) You can only access a locked channel by entering the Channel Guide and then entering the system's PIN.
<b>Direct Tune</b>	Enter the desired satellite channel number using the on-screen keypad.
<b>Set Genre</b>	Press this button to choose from a list of genres. Once you choose a genre, and you press SEEK, it only looks for channels in that genre.

When you select:	You can:
<p><b>Memo</b></p>	<p>Press this button to save a song title and artist to the system. When the saved song is playing on any satellite radio channel, the system alerts you with a pop-up in the lower status bar. You can either tune to the station or ignore the pop-up. When you are in the Memo screen, the following options are available:</p>
	<p><b>Refresh</b> allows you to refresh the current artist and title information.</p>
	<p><b>Song Alert</b> allows you to store the song information displayed in the Title Field. The next time the stored song plays, the system displays an audio and visual notification.</p>
	<p><b>Artist Alert</b> allows you to store the artist information currently displayed in the Artist Field. The next time the artist plays, the system alerts you with a pop-up.</p>
	<p><b>Alert On/Off</b> allows you to select Artists and Titles that you would like the system to alert you to when they are playing on other channels.  <b>Note:</b> Sirius® does not support the Alert feature on all channels. Ford Motor Company shall not be responsible for Alert feature variation.</p>
<p><b>Show Presets</b></p>	<p>Display presets at the bottom of the screen.</p>

## 430 Navigation System (If Equipped)

### Sirius® Satellite Radio Voice Commands



If you are listening to Sirius satellite radio, press the voice button on the steering wheel control. When prompted, say any of the commands in the following chart.

If you are not listening to Sirius satellite radio, press the voice button and, after the tone, say “Sirius”, then any of the commands in the following chart.

“Sirius”	
“<0-233>”	“Seek up”
“<Channel name>”	“Sirius off”
“Preset <#>”	“Sirius On”
“SAT 1”	“Store”*
“SAT 1 preset <#>”	“Store preset <1-6>”
“SAT 2”	“Store SAT1 preset <1-6>”
“SAT 2 preset <#>”	“Store SAT2 preset <1-6>”
“SAT 3”	“Store SAT3 preset <1-6>”
“SAT 3 preset <#>”	“Tune”**
“Seek down ”	“Help”

\*If you have said, “Store”, see the following “Store” chart.

\*\*If you have said, “Tune”, see the following “Tune” chart.

“STORE”	
“Preset <1-6>”	
“SAT1 preset <1-6>”	
“SAT2 preset <1-6>”	
“SAT3 preset <1-6>”	

“TUNE”	
“<0-233>”	“SAT 2”
“<Channel name>”	“SAT 2 preset <#>”
“Preset <#>”	“SAT 3”
“SAT 1”	“SAT 3 preset <#>”
“SAT 1 preset <#>”	“Help”

**Sirius® Information**

**Note:** Sirius reserves the unrestricted right to change, rearrange, add or delete programming including canceling, moving or adding particular channels, and its prices, at any time, with or without notice to you. Ford Motor Company shall not be responsible for any such programming changes.



Sirius satellite radio is a subscription-based satellite radio service that broadcasts a variety of music, sports, news, weather, traffic and entertainment programming.

Your factory-installed Sirius satellite radio system includes hardware and a limited subscription term that begins on the date of sale or lease of your vehicle. See an authorized dealer for availability.

For more information on extended subscription terms (a service fee is required), the online media player and a list of Sirius satellite radio channels, and other features, please visit [www.siriusxm.com](http://www.siriusxm.com) in the United States, [www.sirius.ca](http://www.sirius.ca) in Canada, or call Sirius at 1-888-539-7474.

**Satellite radio electronic serial number (ESN):** You need your ESN to turn on, modify or track your satellite radio account. The ESN is on the System Information Screen (SR ESN: XXXXXXXXXXXXX). To access your ESN, touch the I button on the navigation screen, and then select the System Info tab.

Potential reception issues	
<b>Antenna obstructions</b>	For optimal reception performance, keep the antenna clear of snow and ice build-up and keep luggage and other materials as far away from the antenna as possible.
<b>Terrain</b>	Hills, mountains, tall buildings, bridges, tunnels, freeway overpasses, parking garages, dense tree foliage and thunderstorms can interfere with your reception.

<b>Potential reception issues</b>	
<b>Station overload</b>	When you pass a ground-based broadcast-repeating tower, a stronger signal may overtake a weaker one and the audio system may mute.
<b>Satellite radio signal interference</b>	Your display may show ACQUIRING... to indicate the interference and the audio system may mute.

<b>Troubleshooting tips</b>		
<b>Radio Display</b>	<b>Condition</b>	<b>Possible Action</b>
Acquiring..	Radio requires more than two seconds to produce audio for the selected channel.	No action required. This message should disappear shortly.
Sat Fault/Sirius System Failure	There is an internal module or system failure present.	If this message does not clear shortly, or with an ignition key cycle, your receiver may have a fault. See an authorized dealer for service.
Invalid Channel.	The channel is no longer available.	Tune to another channel or choose another preset.
Unsubscribed Channel.	Your subscription does not include this channel.	Contact Sirius at 1-888-539-7474 to subscribe to the channel, or tune to another channel.
No Signal.	The signal is lost from the Sirius satellite or Sirius tower to your vehicle antenna.	The signal is blocked. When you move into an open area, the signal should return.

Troubleshooting tips		
Radio Display	Condition	Possible Action
Updating.	Update of channel programming in progress.	No action required. The process may take up to three minutes.
Call Sirius 1-888-539-7474.	Your satellite service is no longer available.	Contact Sirius at 1-888-539-7474 to resolve subscription issues.
No Channels Available.	All the channels in the selected channels are either skipped or locked.	Use the channel guide to turn off the <b>Lock</b> or <b>Skip</b> function on that station.
Subscription Updated.	Sirius has updated the channels available for your vehicle.	No action required.

**CD**



Press the MEDIA hard button, and then select the CD tab on the touchscreen. If there is no disc in the system, NO DISC appears in the status bar and you cannot access the CD screen.

Once a disc is loaded, you can choose from Scan, Compress, Repeat, Shuffle, Track List and Record.

When you select:	You can:
<b>Scan</b>	Hear a brief sampling of all listenable tracks.
<b>Compress</b>	Turn the compression feature on and off. This feature boosts more quiet music and lowers louder music to minimize the need for volume adjustment.
<b>Repeat</b>	Hear the selected track continuously.
<b>Shuffle</b>	Play the tracks in a random order.
<b>Track List</b>	View a list of the tracks.
<b>Record</b>	Save the CD or CD tracks into the Jukebox to hear them played later.

## 434 Navigation System (If Equipped)

### CD Voice Commands



If you are listening to a CD, press the voice button on the steering wheel control. When prompted, say any of the commands in the following chart.

If you are not listening to a CD, press the voice button and, after the tone, say “CD”, then any of the commands in the following chart.

“CD”		
“Folder mode”	“Play next folder”	“Repeat folder”
“Folder mode off”	“Play next track”	“Repeat off”
“Pause”	“Play previous folder”	“Repeat track”
“Play”	“Play previous track”	“Shuffle”
“Play folder <1-255>”	“Play track <1-512>”	“Shuffle off”
“Play folder <1-255> track <1-512>”	“Repeat”	“Help”

### MP3



Press the MEDIA hard button, and then select the CD tab on the touchscreen. If there is no disc in the system, NO DISC appears in the status bar and you cannot access the CD screen.

Once a disc is loaded, you can choose from Scan, Compress, Repeat, Shuffle, Folder Mode and Folder List.

When you select:	You can:
<b>Scan</b>	Hear a brief sampling of all listenable tracks.
<b>Compress</b>	Turn the compression feature on and off. This feature boosts more quiet music and lowers louder music to minimize the need for volume adjustment.
<b>Repeat</b>	Hear the selected track continuously.
<b>Shuffle</b>	Play the tracks in a random order.
<b>Folder Mode</b>	Listen to and seek through songs within the current folder.
<b>Folder List</b>	Press this button to access and view folders on the disc. Select the root folder (if available), then any other folder on the disc.

**DVD**

**Note:** Your system only plays NTSC formatted discs. The system does not support PAL format.

Your system allows you to play DVD audio and video discs. Make sure your vehicle is in position **P** (vehicles equipped with an automatic transmission) or the parking brake is engaged (vehicles equipped with a manual transmission). This allows you to be able to view and hear the DVD. If your vehicle is moving, the video does not play.

<b>When you select:</b>	<b>You can:</b>
<b>Title</b>	Go to the disc's main title screen.
<b>Menu</b>	Go to the disc's main menu.
<b>Cursor Controls</b>	Navigate to the desired menu selections.
<b>Settings</b>	<b>Video Display Settings</b> allows you to adjust the brightness and contrast. You can also choose to return to the default settings by pressing Restore Default.
	<b>Audio Language</b> allows you to choose which language you would like the DVD audio track to play in.
	<b>Subtitle Display</b> allows you to turn subtitles off and on.
	<b>Subtitle Language</b> allows you to choose the subtitle language.
	<b>Aspect Ratio</b> allows you to choose wide, full, normal or cinema display.
	<b>Angle Mark Notification</b> allows you to have more viewing angles from which to select. Once you have made your selection, press ENTER to confirm.
<b>Search</b>	Go to a specific title or chapter using the keypad.

## 436 Navigation System (If Equipped)

**Note:** Some of the above settings are disc-dependent and availability and operation may vary.



During disc play, you can also touch the screen to access the virtual remote, which allows you to Move Controls on the screen, as well as use the cursor controls, Enter and Return to navigate and select within the menus.

Dolby noise reduction is manufactured under license from Dolby Laboratories Licensing Corporation. Dolby and the double-D symbol are registered trademarks of Dolby Laboratories Licensing Corporation.

### **Disc Voice Commands**



If you are listening to or watching a disc, press the voice button on the steering wheel control. When prompted, say any of the commands in the following chart.

If you are not listening to or watching a disc, press the voice button and, after the tone, say “Disc”, then any of the commands in the following chart.

“Disc”		
“Folder mode”	“Play next chapter”	“Play previous track”
“Folder mode off”	“Play next folder”	“Play title <1-99>”
“Menu”	“Play next group”	“Play track <1-512>”
“Pause”	“Play next title”	“Repeat”
“Play”	“Play next track”	“Repeat off”
“Play chapter <1-999>”	“Play previous chapter”	“Shuffle”
“Play folder <1-255>”	“Play previous folder”	“Shuffle off”
“Play folder <1-255> track <1-512>”	“Play previous group”	“Title menu”
“Play group <1-9>”	“Play previous title”	“Help”

**DVD Voice Commands**



If you are watching a DVD, press the voice button on the steering wheel control. When prompted, say any of the commands in the following chart.

If you are not watching a DVD, press the voice button and, after the tone, say “DVD”, then any of the commands in the following chart.

“DVD”	
“Menu”	“Play next title”
“Menu title”	“Play next track <1-512>”
“Pause”	“Play previous chapter”
“Play”	“Play previous title”
“Play chapter <1-999>”	“Play previous track”
“Play group <1-9>”	“Play title <1-99>”
“Play next chapter”	“Repeat”
“Play next group”	“Repeat off”

**Video CD Voice Commands**



If you are watching a video CD, press the voice button on the steering wheel control. When prompted, say any of the commands in the following chart.

If you are not watching a video CD, press the voice button and, after the tone, say “Video CD”, then any of the commands in the following chart.

Video CD voice commands
“Play”
“Pause”
“Play next track”
“Play previous track”
“Play track <1-512>”
“Help”

## 438 Navigation System (If Equipped)

---

### Jukebox

Your system has a Jukebox feature, which allows you to save desired tracks or CDs to the hard drive for later access. The hard drive can store up to 10 GB\* (164 hours; approximately 2472 tracks) of music. The system contains a Gracenote media database that allows for display of song title, album title, and album cover art. After saving music to the hard drive, you can access and play your music by specific tracks, artists, albums or genres. You can even choose to create and access your own playlists.

**\*Note:** 1 GB equals one billion bytes (1000000000B).

### Recording Music to Your Jukebox

To record music to your jukebox:

1. Insert a CD, and then select Record on the touchscreen.
2. Select individual tracks or press Select All to record the entire CD.  
**Note:** The system automatically saves all tracks if you do not select any.
3. Press the Start Recording button.

The progress shows at the bottom of the screen.

**Note:** If you are not actively listening to the disc during recording, the record rate is much quicker (as fast as five minutes).

### Accessing the Music in Your Jukebox

Once you have saved music to your jukebox, you can then choose different ways to play the music.

1. Press the MEDIA hard button on the navigation system.
2. Select the Jukebox tab on the touchscreen. You can then select from the following options:

When you select:	You can:
<b>Scan</b>	Hear a brief sampling of all listenable tracks.
<b>Repeat</b>	Hear the selected track continuously.
<b>Shuffle</b>	Play the tracks in a random order.

When you select:	You can:
<b>Music library</b>	<p>Access all of your saved music. You can choose to view or play the material in the following ways:</p> <p><b>Play All Tracks</b> allows you to play all tracks saved in the jukebox.</p> <p><b>Playlist</b> allows you to play your own playlist.</p> <p><b>Play genre</b> allows you to have the system play only music from a specific genre.</p> <p><b>Play artist</b> allows you to have the system play only music by a specific artist.</p> <p><b>Play album</b> allows you to have the system play only music from a specific album.</p>
<b>Options</b>	<p><b>Edit Playlists</b> allows you to edit your playlists.</p> <p><b>Edit Music Library Contents</b> allows you to make changes to the content in your music library.</p> <p><b>Update Album Information from CD Database</b> allows you to update the residing album information from the Gracenote database after a recent software update.</p> <p><b>Hard Disk Drive Information</b> allows you to access the system's hard drive disc information, such as used space, free space and total capacity.</p> <p><b>CD Database Information</b> allows you to access the CD database information.</p>

**Creating a Playlist**

Press the MEDIA hard button, and then select the Jukebox tab on the touchscreen.

1. Select Options.
2. Select Edit Playlists, then which playlist you would like to create.
3. Select which category you would like to access from your saved music.
4. Select the desired songs and then press Add. The system shows you the currently selected songs. You can choose to Edit Name to change the name of the playlist, Delete Playlist to remove it, Add Tracks to the playlist or Sort Playlist.
5. After you change the playlist, select Edit Name to rename your playlist.

**Jukebox Voice Commands**



If you are listening to music stored in the jukebox, press the voice button on the steering wheel control. When prompted, say any of the commands in the following chart.

If you are not listening to music stored in the jukebox, press the voice button and, after the tone, say “Jukebox”, then any of the commands in the following chart.

“JUKEBOX”		
“Pause”	“Play playlist <name>”	“Search album <name>” <sup>3</sup>
“Play” <sup>1</sup>	“Play previous track”	“Search artist <name>” <sup>3</sup>
“Play album <name>” <sup>1</sup>	“Play track <name>” <sup>1</sup>	“Search genre <name>” <sup>3</sup>
“Play artist <name>” <sup>1</sup>	“Refine album <name>” <sup>2</sup>	“Search track <name>” <sup>3</sup>
“Play genre <name>”	“Refine artist <name>” <sup>2</sup>	“Shuffle”
“Play next track”	“Repeat”	“Shuffle off”
“Play playlist <1-5>”	“Repeat off”	“Help”

<sup>1</sup>You can say these commands at any time during listening to the jukebox and after any of the search and refine commands.

<sup>2</sup>You can narrow your search beyond the “Search” command by using these commands.

<sup>3</sup>While listening to the jukebox, press the voice button on the steering wheel control. When prompted, you may say any of these commands.

**User Device**

If your vehicle is equipped with SYNC, there is a User Device tab. For more information, see the *SYNC* chapter.

**Line In (Auxiliary Input Jack)**

Your vehicle is equipped with an audio input jack, which allows you to plug a portable audio device into your vehicle's audio system. To turn this feature on, press the MEDIA hard button on the system.

For more information on the auxiliary input jack, see *Auxiliary input jack* in the *Audio Systems* chapter.

**INFORMATION**

Under the Information menu, you can access features such as Where Am I? and Sirius Travel Link, view your calendar, see system information and get basic system help.

Press the I (Information) hard button to access these features.

**Where Am I?**

Press the I button and select the Where Am I? tab. The system gives you your current GPS location (latitude and longitude), the current street you are on as well as the street in front and behind your vehicle position along with distance information.

**Note:** Not all tab selections shown here are available in all markets. Check with an authorized dealer for availability.

**Sirius® Travel Link™**

**WARNING:** Driving while distracted can result in loss of vehicle control, crash and injury. We strongly recommend that you use extreme caution when using any device that may take your focus off the road. Your primary responsibility is the safe operation of your vehicle. We recommend against the use of any hand-held device while driving and encourage the use of voice-operated systems when possible. Make sure you are aware of all applicable local laws that may affect the use of electronic devices while driving.

**Note:** A paid subscription is required to access and use these features. Go to [www.siriusxm.com/travellink](http://www.siriusxm.com/travellink) for more information.

## 442 Navigation System (If Equipped)

Sirius Travel Link can help you locate the best gas prices, find movie listings, get current traffic alerts, access the current weather map, get accurate ski conditions and scores to current sports games.



Press the I (information) button, then select Sirius Travel Link. Choose from any of the following services:

When you select:	You can:
<b>Traffic On Route</b>	Identify traffic incidents on your route, nearby your vehicle's current location or near any of your favorite places (if programmed).
<b>Traffic Nearby</b>	
<b>My Places</b>	
<b>Weather</b>	View the nearby weather, current weather, or the 5-day forecast for the chosen area. Select Weather Map to see storms, radar information, charts and winds. Select Area to select from a listing of weather locations. In addition, you can view ski conditions for a specific area.
<b>Fuel Prices</b>	View fuel prices at stations close to your vehicle's location or on an active navigation route.
<b>Movie Listings</b>	View nearby movie theaters and their show times (if available).
<b>Sports Info.</b>	View scores and schedules from a variety of sports. You can also save up to 10 favorite teams for easier access. The score automatically refreshes when a game is in progress.

### Sirius Travel Link Voice Commands



Press the voice button and, after the tone, say "Travel Link", then any of the commands in the following chart:

"TRAVEL LINK"	
"5-day weather forecast"	"NBA schedule"
"Baseball schedule"	"NBA scores"
"Baseball scores"	"NFL schedule"

<b>“TRAVEL LINK”</b>	
“College basketball schedule”	“NFL scores”
“College basketball scores”	“NHL schedule”
“College football schedule”	“NHL scores”
“College football scores”	“Sports schedule”*
“Fuel prices”	“Sports scores”**
“Golf leaders”	“Traffic”
“Golf schedule”	“Travel link help”
“Motor sports order”	“Weather”
“Motor sports schedule”	“Weather map”
“Movie listings”	

\*If you have said, “Sports schedule”, you may say any of the commands in the “Sports schedule” chart:

\*\*If you have said, “Sports scores”, you may say any of the commands in the “Sports scores” chart:

<b>“SPORTS SCHEDULES”</b>	
“Baseball schedule”	“NBA schedule”
“College basketball schedule”	“NFL schedule”
“College football schedule”	“NHL schedule”
“Golf schedule”	“Travel link help”
“Motor sports schedule”	

<b>“SPORTS SCORES”</b>	
“Baseball scores”	“NBA scores”
“College basketball scores”	“NFL scores”
“College football scores”	“NHL scores”
“Golf leaderboard”	“Travel link help”
“Motor sports results”	

**Calendar**

Press the I (information) button, then select Calendar. You can then select which month you would like to view by using the arrow buttons or selecting Go to Today.

You can view calendars from one previous year and the next 10 years.

**Note:** Not all tab selections may be available in all markets. Check with an authorized dealer for availability.

**System Information**

Press the I (information) button, then select System Information.

In this screen, you can view the following options:

- Phone number for your Customer Service Center
- Current system versions installed
- Current Sirius Radio ESN
- Sirius Travel Link ESN.

**Note:** Not all tab selections may be available in all markets. Check with an authorized dealer for availability.

**Help**

The Help screen allows you to view basic information about controls and driving restrictions as well as traffic legend information and basic voice commands available in various modes.

<b>If you select:</b>	<b>You can:</b>
<b>Basic Operation</b>	View hard buttons on your navigation system. Press the desired icon to view the button description.
<b>Driving Restriction</b>	View the system's driving restriction.
<b>Traffic Legend</b>	View the color code for the Speed and Flow of roads on the navigation system. You can also select Traffic Incidents to help you differentiate between viewed and unviewed incidents.
<b>Voice Commands</b>	View a brief listing of possible voice commands in a specific mode.

**SOUND**

The sound menu allows you to access and adjust settings, such as Bass, Treble, Fade, Balance, Speed Compensated Volume (SCV) and the visualizer. Press the SOUND hard button.

When you select:	You can:
<b>Bass/Treble</b>	Increase or decrease levels by pressing + or -.
<b>Balance/Fade</b>	Adjust the sound between the left and right speakers and front and rear speakers.
<b>SCV</b>	Have the system automatically adjust radio volume according to vehicle speed to compensate for road and wind noise. Select a level of compensation between 1 and 7 by pressing the corresponding button.
<b>Visualizer</b>	Turn the audio visualizer display on or off. <b>Note:</b> Turning the visualizer setting to off does not remove the visualizer on the home screen. You need to select a different view in order to remove the visualizer.

**NAVIGATION SYSTEM**

Your navigation system allows you to set a destination by using your touchscreen or voice commands.

The navigation system contains map coverage for the United States, Puerto Rico and U.S. Virgin Islands, Canada and Mexico.

**Disclaimer**

A disclaimer appears once per ignition cycle when the **DEST** button is pressed. Press **Accept** to agree to the terms and access navigation functions. If you do not press Accept, you only have access to non-navigation functions. The disclaimer has information similar to the following:

- Always obey local traffic regulations.
- We recommend you program the system only when your vehicle is at a stop.
- Some functions are unavailable while your vehicle is moving to help minimize distraction.
- Periodic map updates are available at an additional cost.

## 446 Navigation System (If Equipped)

---

### Route Guidance in Incompletely Mapped Areas

There are some rural areas in the map database without fully verified roads. When the system is in route guidance mode, and the navigation system encounters these incompletely mapped areas, the system alerts you by:

- Announcing, “Entering an area with incomplete map data; please follow with caution”
- Saying, “with caution” in the first route guidance instruction before each turn
- Highlighting the route on the map in yellow
- Highlighting the incomplete mapped streets in yellow on the turn list
- Coloring the guidance arrows yellow.

Please drive using extra caution when driving in these areas as the mapping information may be somewhat inaccurate.

### Programming a Destination Using the Touchscreen

1. Press the **DEST** hard button.
2. Select from the following:

<b>Quick</b>	
<b>Note:</b> Items on this screen are selectable at any speed.	
<b>Cancel Route</b>	Touch this button to cancel the current route.
<b>Emergency</b>	Touch this button to find hospitals and police stations close to your vehicle’s location. The system may display up to 25 locations.
<b>Favorite Destinations</b>	This feature stores your home location and up to five address book entries. To set an entry, touch a preset button, and then follow the screen prompts. The system displays the icon and name associated with the location.

<b>Quick</b>	
<b>Note:</b> Items on this screen are selectable at any speed.	
<b>Find Nearest POI</b>	<p>Select up to five different points of interest (POI) favorites that you can search for while your vehicle is moving. You can change these categories at any time but the default categories are:</p> <ul style="list-style-type: none"> <li>• Gas Station</li> <li>• ATM</li> <li>• Restaurant</li> <li>• Accommodations</li> <li>• Parking Garage</li> </ul> <p>When you select a category, the system displays a list in order of distance from your vehicle's location. The Quick POI search range automatically increases to a 50 mile (80 km) radius if no point of interest is found within the default 25 mile (40 km) radius. You also have the option to select List All Categories, which displays a list of all categories.</p>
<b>Previous Destination</b>	Touch this button to select one of your previous destinations.
<b>Address Book</b>	Touch this button to set an entry in your address book as your destination.

<b>Standard</b>	
<b>Note:</b> Items on this screen are selectable only when your vehicle is moving at speeds slower than 5 mph (8 km/h).	
<b>Address Book</b>	You can store up to 25 entries, which you can use as destinations, waypoints and areas to avoid. You can sort the entries alphabetically, by date or icon.*
<b>Previous Destination</b>	You can store up to 20 recently used destinations and waypoints. Duplicate entries do not appear in the list. Adding a new entry deletes the oldest one from the list.*
<b>Phone Number</b>	Touch this button to search for a destination using the phone number of a saved point of interest or address book entry. Use the keypad on the screen to enter the phone number.
<b>Map</b>	Touch this button to select a point on the map as a destination or waypoint by using the map cursor.

<b>Standard</b>	
<p><b>Note:</b> Items on this screen are selectable only when your vehicle is moving at speeds slower than 5 mph (8 km/h).</p>	
<b>Street Address</b>	<p>Touch this button to program a street address as a destination or waypoint.</p> <ul style="list-style-type: none"> <li>• <b>State/Prov</b> lets you use the keyboard to type or you can select the area to search from a list. The system bases the search on your vehicle's current position or the previous selection. You can set the Auto Fill feature on to have the system fill in some information for you based on readings from your vehicle's GPS. Depending on your settings, the system may automatically fill in some of the location information for you.</li> <li>• <b>City</b> is the name of the city of your destination.</li> <li>• <b>Street</b> is the name of the street where your destination is located. You can search for street names, which include numbers, such as Second Street, if the name is entered using digits or a spelling of the number. This is valid for street names containing numbers 1 (One) through 20 (Twenty) or 1st (First) through 20th (Twentieth) only.</li> <li>• <b>Number</b> is the address number.</li> <li>• <b>List</b> is where you can view and select from a list of State, Province, Territories, Cities and Names. The system provides a list based on the first letter you type into a field.</li> </ul>

<b>Standard</b>	
<b>Note:</b> Items on this screen are selectable only when your vehicle is moving at speeds slower than 5 mph (8 km/h).	
<b>Point of Interest (POI)</b>	<p>Touch this button to select a point of interest on the map as a destination or waypoint. There are three ways to search for a point of interest:</p> <ol style="list-style-type: none"> <li>1. Enter a city name in the City field and a point of interest in the Name field.</li> <li>2. Enter a city name in the City field, choose a point of interest category by selecting Category, and then enter the point of interest name in the Name field. You can also press List. However, if there are more than 999 choices, this option is not possible.</li> <li>3. Choose a category from the point of interest by selecting <b>Category</b> and enter a point of interest name in the Name field. <ul style="list-style-type: none"> <li>• <b>State/Prov</b> lets you use the keyboard to type or you can select the area to search from a list. The system bases the search on your vehicle's current position or the previous selection. You can set the Auto Fill feature on to have the system fill in some information for you. Depending on your settings, the system may automatically fill in some of the location information for you.</li> <li>• <b>City</b> is the name of the city.</li> <li>• <b>Category</b> is where you select the desired point of interest category or subcategory.</li> <li>• <b>Name</b> is where you select to search for a point of interest using a full or partial name.</li> <li>• <b>List</b> is where you can view and select from a list of State, Province, Territories, Cities and Names. The system provides a list based on the first letter you type into a field.</li> </ul> </li> </ol>

<b>Standard</b>	
<b>Note:</b> Items on this screen are selectable only when your vehicle is moving at speeds slower than 5 mph (8 km/h).	
<b>Freeway Entrance/Exit</b>	<p>Touch this button to select an entrance and exit point to a freeway you select. You can sort the entrance and exit point alphabetically or in order of distance from your vehicle's position. You can then select the point you choose as a destination or waypoint.</p> <ul style="list-style-type: none"> <li>• <b>State/Prov</b> lets you use the keyboard to type or you can select the area to search from a list. The system bases the search on your vehicle's current position or the previous selection. You can set the Auto Fill feature on to have the system fill in some information for you. Depending on your settings, the system may automatically fill in some of the location information for you.</li> <li>• <b>Freeway</b> is the name of the freeway you can search.</li> <li>• <b>List</b> is where you can view and select from a list of State, Province, Territories, Cities and Names. The system provides a list based on the first letter you type into a field.</li> </ul>

<b>Standard</b>	
<b>Note:</b> Items on this screen are selectable only when your vehicle is moving at speeds slower than 5 mph (8 km/h).	
<b>Intersection</b>	<p>Touch this button to select an intersection point. Enter the name of the first street, then the first letter of the second street. The system displays possible intersection matches based on the first letter of the second street. Once you choose the intersection, you can sort the list alphabetically or in order of distance from your vehicle's position.</p> <ul style="list-style-type: none"> <li>• <b>State/Prov</b> lets you use the keyboard to type or you can select the area to search from a list. The system bases the search on your vehicle's current position or the previous selection. You can set the Auto Fill feature on to have the system fill in some information for you. Depending on your settings, the system may automatically fill in some of the location information for you.</li> <li>• <b>City</b> is the name of the city you can search.</li> <li>• <b>Street # 1</b> is the name of the first street you can search. You can search for street names, which include numbers, such as Second Street, if the name is entered using digits or a spelling of the number. This is valid for street names containing numbers 1 (One) through 20 (Twenty) or 1st (First) through 20th (Twentieth) only.</li> <li>• <b>Street # 2</b> is the field where you enter the first letter of the second street to search.</li> <li>• <b>List</b> is where you can view and select from a list of State, Province, Territories, Cities and Names. The system provides a list based on the first letter you type into a field.</li> </ul>

\*To delete all stored Address Book and Previous Destination entries at once:

1. Press the **MENU** hard button.
2. Select the **System Settings** tab.
3. Press the **View** button for **Delete Stored Items**.
4. Select **Address Book** or **Previous Destinations**.

<b>Edit Route</b>	
<b>Cancel Route</b>	Touch this button to cancel the current route.
<b>Detour</b>	Touch this button to avoid an area on the current route.
<b>View Route</b>	Touch this button to view the entire current route. You can select from the following options: <ul style="list-style-type: none"> <li>• <b>View Destination</b> displays a close-up view of the destination and surrounding area.</li> <li>• <b>View Next Waypoint</b> displays a close-up view of next waypoint and surrounding area.</li> <li>• <b>View Turn List</b> displays the turn list for the current destination. You can also select a road on the turn list to avoid, if you choose.</li> </ul>
<b>Edit Route Preferences</b>	Once you select a route as the fastest or shortest route, you can also select from to: <ul style="list-style-type: none"> <li>• Avoid Freeways</li> <li>• Avoid Tollroads</li> <li>• Avoid Ferries</li> <li>• Avoid Time Restrictions</li> <li>• Avoid HOV Lanes</li> </ul>
<b>Edit Traffic Preferences</b>	Touch this button to edit traffic preferences.*
<b>Edit Destination/Waypoints</b>	Touch this button to edit the destination or waypoints of a defined route.
<b>Edit Turn List</b>	Touch this button to delete or avoid a road in the current turn list.

\*This feature requires activation of Sirius Travel Link, which is only available in the United States.

## 454 Navigation System (If Equipped)

### Programming a Destination Using Voice Commands

Press the voice button on the steering wheel.

<b>If you want to:</b>	<b>Say:</b>
Enter an address.	“Destination street address”
Enter an intersection.	“Destination intersection”
Find a point of interest (POI) by its category.	“Destination nearest <POI category>” or “Destination nearest POI”
Find a point of interest (POI) by its name.	“Destination POI”
Go to a previous destination.	“Destination previous destination”
Go to your home location.	“Destination home”
Use a nametag from your address book.	“Destination <nametag>”
Get help.	“Help”

**Note:** If you set the system language to French or Spanish, you need to spell out the city and street names. When in Spelling Mode, you may speak letters or say, “Line #”. The system works even if you have made a spelling error.

### POI Categories

Your system offers a variety of POI (Point of Interest) categories.

<b>Main Categories</b>	
Food/Drink & Dining	Automotive
Travel & Transportation	Shopping
Financial	Entertainment & Arts
Emergency	Recreation & Sports
Community	Government
Health & Medicine	Domestic Services

Within these main categories, there are subcategories, which contain more listings:

Subcategories
Restaurant
Auto Dealership
Parking
Public Transit
Home & Garden
Education
Personal Care Services

**Setting Your Navigation Preferences**

Select settings for the system to take into account when planning your route. Press the **NAV** hard button.

Map Preferences	
<b>Map Content</b>	<b>Street Name</b> displays current street name during route guidance.
	<b>Time to Dest</b> displays the distance to your destination and the estimated time of arrival.
	<b>Speed Limit</b> displays the speed limit of major roads during route guidance.
	<b>Breadcrumbs</b> displays your vehicle's previously traveled route with white dots. The dots display for about the last 140 miles (225 km) driven.
	<b>Point of Interest (POI) Icons</b> displays point of interest icons on the map.
<b>Map View</b>	<b>Full Map</b> displays the map in full screen with turn icons in the upper right corner.
	<b>Arrow/Map</b> divides the screen in two. The map is on the left and upcoming turn information on the right.
	<b>Turn List/Map</b> divides the screen in two. The map is on the left and turn list on the right.

<b>Map Preferences</b>	
<b>Bird's Eye View</b>	<b>ON</b> provides an elevated map perspective.
	<b>OFF</b> turns the feature off.
	<b>Adjust Angle</b> offers six different map angles.
<b>Turn List Format</b>	<b>Top-to-Bottom</b> starts the turn instructions from the top.
	<b>Bottom-to-Top</b> starts the turn instructions from the bottom.
<b>Route Preferences</b>	
<b>Preferred Route</b>	Have the system display the shortest or fastest route first.
<b>Avoid Freeways</b>	Have the system avoid freeways when calculating a route.
<b>Avoid Tollroads</b>	Have the system avoid tollroads when calculating a route.
<b>Avoid Ferries</b>	Have the system avoid ferries when calculating a route.
<b>Avoid Time Restricted Roads</b>	Have the system avoid time-restricted roads when calculating a route. These roads may have turn, lane or entrance restrictions based on local traffic conditions or seasonal restrictions.
<b>Traffic Preferences*</b>	
<b>Traffic Icons to overlay on Map</b>	Touch this button to display a list of map icons that you can turn off and on. The list of icons includes: <ul style="list-style-type: none"> <li>• Weather related incidents</li> <li>• Road work</li> <li>• Incident</li> <li>• Accident</li> <li>• Closed road</li> </ul>

<b>Traffic Preferences*</b>	
<b>Traffic Flow Overlay</b>	Touch this button to have the map show traffic flow coloring on major roads. Roads display in green (all clear), yellow (reduced speed) and red (stopped).
<b>Traffic Alert Notification</b>	Touch this button to have the system traffic incidents notifications along your programmed route. If you select <b>Yes</b> , a traffic incident pop-up asks you to consider or ignore the traffic incident. If you select <b>Yes</b> again, this makes the system recalculate a new route for you. If you select <b>Ignore</b> , this closes the pop-up window.

\*This feature requires activation of Sirius Travel Link, which is only available in the United States.

<b>Navigation Preferences</b>	
<b>Guidance Prompts</b>	<b>Voice</b> guides you with tones and voice prompts only.
	<b>Tone only</b> guides you with tones only.
	<b>OFF</b> turns off any voice or tone prompts.
<b>Auto-Fill State/Province</b>	When this feature is on, the system automatically fills in the state or province information based on your vehicle's GPS location. If you live in a border area, you may not want this feature on.
<b>Avg. Speed: Residential</b>	When this feature is on, the system displays the average speed on a residential road, initially set to 25 mph (40 km/h). You can change the setting for your driving preferences. This setting helps estimate your arrival time at a destination based on your driving preferences.

Navigation Preferences	
<b>Avg. Speed: Main Roads</b>	When this feature is on, the system displays the average speed on a main road, initially set to 45 mph (72 km/h). You can change the setting for specific roads and for your driving preferences. This setting helps estimate your arrival time at a destination based on your driving preferences.
<b>Avg. Speed: Freeways</b>	When this feature is on, the system displays the average speed on a freeway, initially set to 65 mph (105 km/h). You can change the setting for specific roads and for your driving preferences. This setting helps estimate your arrival time at a destination based on your driving preferences.
<b>Parking POI Notification</b>	When this feature is on, the system displays available parking accommodations around a destination that is part of your route.
<b>Low Fuel POI Notification</b>	When this feature is on, the system displays gas station icons when the fuel level is low.
<b>Fuel Price Display</b>	When this feature is on, the system displays fuel prices at local stations. You can choose to display prices for <b>Unleaded</b> or <b>Diesel</b> .*
<b>Calibrate</b>	<b>Position</b> allows you to adjust the direction of your vehicle by pressing the arrow buttons on the screen.
	<b>Distance</b> allows you to recalibrate the distance to the destination while your vehicle is moving.
<b>Restore Default Settings</b>	Touch the <b>Reset</b> button to return the settings to factory defaults.

\*This feature requires activation of Sirius Travel Link, which is only available in the United States.

Avoid Areas	
<b>Add</b>	Add items and areas that you want the system to avoid when creating a route for you. The system does its best to avoid these.*

\*There may be some situations where it is impossible to avoid the selection(s) completely. For example, if a destination or waypoint is located in the area that is set to avoid, the system cannot avoid it.

**Map Mode**

Press the **MAP** hard button to view map mode. When in map mode, an icon appears on the upper left side of the screen; this is a toggle button to change the view of the map display.

Roads on the map display in a variety of colors. Building footprints display areas of major buildings in the 20 largest cities in the U.S. These areas may display depending on their size and the map zoom level.



**Heading Up** always shows the direction of forward travel to be upward on the screen. This view is available for map scales up to 2.5 miles (4 kilometers). The system remembers this setting for larger map scales, but shows the map in North Up only. If the scale returns below this level, the system restores Heading Up.



**Heading Up Bird's Eye View** provides an elevated perspective of the map. You can adjust the viewing angle through the map preferences.



**North Up** always shows the northern direction to be upward on the screen.

**Map Icons**



**Vehicle mark** shows the current location of your vehicle. It stays in the center of the map display, except when in scroll mode.



**Scroll cursor** allows you to scroll the map; the fixed icon is in the center of the screen. The map position closest to the cursor is in a window on the top center part of the screen.



**Address book entry default icon(s)** indicates the location on the map of an address book entry. This is the default symbol shown after the entry has been stored to the Address Book by any method other than the map. You can select from any of the 22 icons available. You can use each icon more than once.



**Home** indicates the location on the map currently stored as the home position. You can only save one address from the Address Book as your Home entry. You cannot change this icon.



**POI (Point Of Interest) icons** display on the map and can be turned on or turned off. Up to about 56 subcategories can display on the map one at a time.



**Starting point** indicates the starting point of a planned route.



**Waypoints** indicate the location of a waypoint on the map. The number inside the circle is different for each waypoint and represents the position of the waypoint in the route list.



**Destination symbol** indicates the ending point of a planned route.



**Next maneuver point** indicates the location of the next turn on the planned route.



**No GPS symbol** indicates that insufficient GPS satellite signals are available for accurate map positioning. This icon may display under normal operation in an area with poor GPS access.

### Map Scale



The map display scale has 17 levels, ranging from 0.02 miles (.03 kilometers) to 1000 miles (1600 kilometers). The system synchronizes the zoom scales for North Up, Heading Up and 3D Map views.

In Map Mode, you can zoom in or out, changing the display scale, by touching an arrow button on the left side of the screen.

In Full Screen Map Mode, touch this button to use the Zoom Direct buttons. The Zoom Direct buttons represent the most common map scales. Touch a button to show the map at the desired scale. The scale is approximate and based on the width of the map scale button. The size of the scale varies based on the screen size.

**Map Scrolling**

**Single scroll mode** allows you to press and release on the map display to bring the pressed position to the center of the screen. The scroll mode times out after five minutes of inactivity.

**Continuous scroll mode** allows you to touch and hold the map to begin scrolling continuously in one of eight directions closest to the point that is touched. The scroll continues until you release the map, and increases in speed after three seconds. This is not possible if your vehicle is moving. The scroll mode times out after five minutes of inactivity.

**Bird’s eye view scroll mode** is available after you touch the map twice, and then selecting one of the eight buttons that appear on the map, in an oval pattern, in the center of the screen. The two scroll buttons located in the farthest east and west points of the oval, scroll in a circle around your vehicle. The remaining buttons scroll in a straight line in the arrow direction.

**Quick-touch Buttons**

When in map mode, touch anywhere on the map display to access the following options:

When you select:	You can:
<b>Set as Dest</b>	Select a scrolled location on the map as your destination. You may scroll the map by pressing your index finger on the map display. When you reach the desired location, simply let go and then press Set as Dest.
<b>Set as Waypoint</b>	Set the current location as a waypoint.
<b>Save to Address Book</b>	Save the current location to the address book.
<b>POI Icons On/Off</b>	Select point of interest icons to display on the map. You can select up to three icons to display on the map at the same time.

## 462 Navigation System (If Equipped)

When you select:	You can:
<b>View Traffic</b>	Adjust the map display to the right scale. This scale allows the entire route to be visible in the screen.
<b>View/Edit Route</b>	Access these features when a route is active: Cancel route. Edit route preferences. Edit destination/waypoints. View route. Edit traffic preferences.* Edit turn list.

\*This feature requires activation of Sirius Travel Link, which is only available in the United States.

Navteq is the digital map provider for the navigation application. If you find map data errors, you may report them directly to Navteq by going to <http://mapreporter.navteq.com>. Navteq evaluates all reported map errors and responds with the result of their investigation by e-mail.

### Navigation Map Updates

Annual navigation map updates are available for purchase through your dealership, by calling 1-800-NAVMAPS (in Mexico, call 01-800-557-5539) or going to [www.navigation.com/ford](http://www.navigation.com/ford). You need to specify the make and model of your vehicle to determine if there is an update available.

### Navigation Voice Commands



When in navigation mode, press the voice button on the steering wheel control. After the tone, say “Navigation”, then any of the following commands:

“NAVIGATION”	
“Cancel next waypoint”	“Show destination”
“Cancel route”	“Show heading up”
“Destination”*	“Show map”
“Destination <nametag>”	“Show next waypoint”
“Destination <POI category>”	“Show north up”

<b>“NAVIGATION”</b>	
“Destination home”	“Show route”
“Destination intersection”	“Show turn list”
“Destination nearest <POI category>”	“Voice off”
“Destination nearest POI”	“Voice on”
“Destination POI”	“Voice volume decrease”
“Destination previous destination”	“Voice volume increase”
“Destination street address”	“Zoom in”
“Detour”	“Zoom out”
“Play nametags”	“Help”
“Repeat instruction”	

\*If you have said the command, “Destination”, you may say any of the above commands or commands in the following Destination chart.

<b>“DESTINATION”</b>
<nametag>
<POI category>
“Home”
“Intersection”
“Nearest <POI category>”
“Nearest POI”
“POI”
“POI category”
“Previous destination”
“Street address”
“Help”

## 464 Navigation System (If Equipped)

### Troubleshooting

Symptoms	Possible Cause	Action
Focus error.	The system is not able to play a reproduced disc.	Contact an authorized dealer.
Bad disc.	You inserted the disc upside down or the system is unable to read the information on the disc.	The system automatically ejects the disc.
Track error.	The system is unable to reproduce a corrupt MP3 file.	The system skips the corrupted track.
Invalid disc detected.	The disc is either dirty or contains an unsupported format.	Wipe the disc with a dry, soft cloth from the center to the outer edge of the disc.
A pop-up window displays "Address not found" or "Address range does not exist. Show the midpoint of the street?"	The house number entered does not exist in the map database.	Press <b>NO</b> and enter a valid number for the specified street, or press <b>YES</b> to view the middle point of the street.

## Navigation System (If Equipped)

465

Symptoms	Possible Cause	Action
A pop-up window displays "Navigation fault. A system fault has been detected that may cause the navigation to perform abnormally. Please contact your dealership."	There is a system hardware or software error.	Contact an authorized dealer.
A pop-up window displays "Error. PINs did not match. Please re-enter."	You entered the wrong PIN to unlock the system for valet mode.	Press <b>OK</b> and try entering your PIN again. If it does not work, contact an authorized dealer.
A pop-up window displays "Invalid PIN. Please Re-enter."	You entered the wrong PIN.	Press <b>OK</b> and try entering your PIN again to lock the system.

**GENERAL INFORMATION****SYNC® End User License Agreement (EULA)**

- You have acquired a device (“DEVICE”) that includes software licensed by Ford Motor Company and its affiliates (“FORD MOTOR COMPANY”) from an affiliate of Microsoft Corporation (“MS”). Those installed software products of MS origin, as well as associated media, printed materials, and “online” or electronic documentation (“MS SOFTWARE”) are protected by international intellectual property laws and treaties. The MS SOFTWARE is licensed, not sold. All rights reserved.

- The MS SOFTWARE may interface with and/or communicate with, or may be later upgraded to interface with and/or communicate with additional software and/or systems provided by FORD MOTOR COMPANY. The additional software and systems of FORD MOTOR COMPANY origin, as well as associated media, printed materials, and “online” or electronic documentation (“FORD SOFTWARE”) are protected by international intellectual property laws and treaties. The FORD SOFTWARE is licensed, not sold. All rights reserved.

- The MS SOFTWARE and/or FORD SOFTWARE may interface with and/or communicate with, or may be later upgraded to interface with and/or communicate with additional software and/or systems provided by third party software and service suppliers. The additional software and services of third party origin, as well as associated media, printed materials, and “online” or electronic documentation (“THIRD PARTY SOFTWARE”) are protected by international intellectual property laws and treaties. The THIRD PARTY SOFTWARE is licensed, not sold. All rights reserved.

- The MS SOFTWARE, FORD SOFTWARE and THIRD PARTY SOFTWARE hereinafter collectively and individually will be referred to as “SOFTWARE.”

**IF YOU DO NOT AGREE TO THIS END USER LICENSE AGREEMENT (“EULA”), DO NOT USE THE DEVICE OR COPY THE SOFTWARE. ANY USE OF THE SOFTWARE, INCLUDING BUT NOT LIMITED TO USE ON THE DEVICE, WILL CONSTITUTE YOUR AGREEMENT TO THIS EULA (OR RATIFICATION OF ANY PREVIOUS CONSENT).**

**GRANT OF SOFTWARE LICENSE:** This EULA grants you the following license:

- You may use the SOFTWARE as installed on the DEVICE and as otherwise interfacing with systems and/or services provide by or through FORD MOTOR COMPANY or its third party software and service providers.

**DESCRIPTION OF OTHER RIGHTS AND LIMITATIONS:**

- **Speech Recognition:** If the SOFTWARE includes speech recognition component(s), you should understand that speech recognition is an inherently statistical process and that recognition errors are inherent in the process. Neither FORD MOTOR COMPANY nor its suppliers shall be liable for any damages arising out of errors in the speech recognition process.
- **Limitations on Reverse Engineering, Decompilation and Disassembly:** You may not reverse engineer, decompile, or disassemble nor permit others to reverse engineer, decompile or disassemble the SOFTWARE, except and only to the extent that such activity is expressly permitted by applicable law notwithstanding this limitation.
- **Limitations on Distributing, Copying, Modifying and Creating Derivative Works:** You may not distribute, copy, make modifications to or create derivative works based on the SOFTWARE, except and only to the extent that such activity is expressly permitted by applicable law notwithstanding this limitation.
- **Single EULA:** The end user documentation for the DEVICE and related systems and services may contain multiple EULAs, such as multiple translations and/or multiple media versions (e.g., in the user documentation and in the software). Even if you receive multiple EULAs, you are licensed to use only one (1) copy of the SOFTWARE.
- **SOFTWARE Transfer:** You may permanently transfer your rights under this EULA only as part of a sale or transfer of the DEVICE, provided you retain no copies, you transfer all of the SOFTWARE (including all component parts, the media and printed materials, any upgrades, and, if applicable, the Certificate(s) of Authenticity), and the recipient agrees to the terms of this EULA. If the SOFTWARE is an upgrade, any transfer must include all prior versions of the SOFTWARE.
- **Termination:** Without prejudice to any other rights, FORD MOTOR COMPANY or MS may terminate this EULA if you fail to comply with the terms and conditions of this EULA.
- **Security Updates/Digital Rights Management:** Content owners use the WMDRM technology included in your DEVICE to protect their intellectual property, included copyrighted content. Portions of the SOFTWARE on your DEVICE use WMDRM software to access WMDRM-protected content. If the WMDRM software fails to protect the content, content owners may ask Microsoft to revoke the

SOFTWARE's ability to use WMDRM to play or copy protected content. This action does not affect unprotected content. When your DEVICE downloads licenses for protected content, you agree that Microsoft may include a revocation list with the licenses. Content owners may require you to upgrade the SOFTWARE on your DEVICE to access their content. If you decline an upgrade, you will not be able to access content that requires the upgrade.

- **Consent to Use of Data:** You agree that MS, Microsoft Corporation, FORD MOTOR COMPANY, third party software and systems suppliers, their affiliates and/or their designated agent may collect and use technical information gathered in any manner as part of product support services related to the SOFTWARE or related services. MS, Microsoft Corporation, FORD MOTOR COMPANY, third party software and services suppliers, their affiliates and/or their designated agent may use this information solely to improve their products or to provide customized services or technologies to you. MS, Microsoft Corporation, FORD MOTOR COMPANY, third party software and systems suppliers, their affiliates and/or their designated agent may disclose this information to others, but not in a form that personally identifies you.
- **Internet-Based Services Components:** The SOFTWARE may contain components that enable and facilitate the use of certain Internet-based services. You acknowledge and agree that MS, Microsoft Corporation, FORD MOTOR COMPANY, third party software and service suppliers, their affiliates and/or their designated agent may automatically check the version of the SOFTWARE and/or its components that you are utilizing and may provide upgrades or supplements to the SOFTWARE that may be automatically downloaded to your DEVICE.
- **Additional Software/Services:** The SOFTWARE may permit FORD MOTOR COMPANY, third party software and service suppliers, MS, Microsoft Corporation, their affiliates and/or their designated agent to provide or make available to you SOFTWARE updates, supplements, add-on components, or Internet-based services components of the SOFTWARE after the date you obtain your initial copy of the SOFTWARE ("Supplemental Components").

If FORD MOTOR COMPANY or third party software and services suppliers provide or make available to you Supplemental Components and no other EULA terms are provided along with the Supplemental Components, then the terms of this EULA shall apply.

If MS, Microsoft Corporation, their affiliates and/or their designated agent make available Supplemental Components, and no other EULA terms are provided, then the terms of this EULA shall apply, except that the MS, Microsoft Corporation or affiliate entity providing the Supplemental Component(s) shall be the licensor of the Supplemental Component(s).

FORD MOTOR COMPANY, MS, Microsoft Corporation, their affiliates and/or their designated agent reserve the right to discontinue without liability any Internet-based services provided to you or made available to you through the use of the SOFTWARE.

- **Links to Third Party Sites:** The MS SOFTWARE may provide you with the ability to link to third party sites through the use of the SOFTWARE. The third party sites are not under the control of MS, Microsoft Corporation, their affiliates and/or their designated agent. Neither MS nor Microsoft Corporation nor their affiliates nor their designated agent are responsible for (i) the contents of any third party sites, any links contained in third party sites, or any changes or updates to third party sites, or (ii) webcasting or any other form of transmission received from any third party sites. If the SOFTWARE provides links to third party sites, those links are provided to you only as a convenience, and the inclusion of any link does not imply an endorsement of the third party site by MS, Microsoft Corporation, their affiliates and/or their designated agent.
- **Obligation to Drive Responsibly:** You recognize your obligation to drive responsibly and keep attention on the road. You will read and abide with the DEVICE operating instructions particularly as they pertain to safety and assumes any risk associated with the use of the DEVICE.

**UPGRADES AND RECOVERY MEDIA:** If the SOFTWARE is provided by FORD MOTOR COMPANY separate from the DEVICE on media such as a ROM chip, CD ROM disk(s) or via web download or other means, and is labeled "For Upgrade Purposes Only" or "For Recovery Purposes Only" you may install one (1) copy of such SOFTWARE onto the DEVICE as a replacement copy for the existing SOFTWARE, and use it in accordance with this EULA, including any additional EULA terms accompanying the upgrade SOFTWARE.

**INTELLECTUAL PROPERTY RIGHTS:** All title and intellectual property rights in and to the SOFTWARE (including but not limited to any images, photographs, animations, video, audio, music, text and "applets," incorporated into the SOFTWARE), the accompanying printed materials, and any copies of the SOFTWARE, are owned by MS, Microsoft Corporation, FORD MOTOR COMPANY, or their affiliates or suppliers. The SOFTWARE is licensed, not sold. You may not copy the

printed materials accompanying the SOFTWARE. All title and intellectual property rights in and to the content which may be accessed through use of the SOFTWARE is the property of the respective content owner and may be protected by applicable copyright or other intellectual property laws and treaties. This EULA grants you no rights to use such content. All rights not specifically granted under this EULA are reserved by MS, Microsoft Corporation, FORD MOTOR COMPANY, third party software and service providers, their affiliates and suppliers. Use of any on-line services which may be accessed through the SOFTWARE may be governed by the respective terms of use relating to such services. If this SOFTWARE contains documentation that is provided only in electronic form, you may print one copy of such electronic documentation.

**EXPORT RESTRICTIONS:** You acknowledge that the SOFTWARE is subject to U.S. and European Union export jurisdiction. You agree to comply with all applicable international and national laws that apply to the SOFTWARE, including the U.S. Export Administration Regulations, as well as end-user, end-use and destination restrictions issued by U.S. and other governments. For additional information, see <http://www.microsoft.com/exporting/>.

**TRADEMARKS:** This EULA does not grant you any rights in connection with any trademarks or service marks of FORD MOTOR COMPANY, MS, Microsoft Corporation, third party software or service providers, their affiliates or suppliers.

**PRODUCT SUPPORT:** Product support for the SOFTWARE is not provided by MS, its parent corporation Microsoft Corporation, or their affiliates or subsidiaries. For product support, please refer to FORD MOTOR COMPANY instructions provided in the documentation for the DEVICE. Should you have any questions concerning this EULA, or if you desire to contact FORD MOTOR COMPANY for any other reason, please refer to the address provided in the documentation for the DEVICE.

**No Liability for Certain Damages:** EXCEPT AS PROHIBITED BY LAW, FORD MOTOR COMPANY, ANY THIRD PARTY SOFTWARE OR SERVICES SUPPLIERS, MS, MICROSOFT CORPORATION AND THEIR AFFILIATES SHALL HAVE NO LIABILITY FOR ANY INDIRECT, SPECIAL, CONSEQUENTIAL OR INCIDENTAL DAMAGES ARISING FROM OR IN CONNECTION WITH THE USE OR PERFORMANCE OF THE SOFTWARE. THIS LIMITATION SHALL APPLY EVEN IF ANY REMEDY FAILS OF ITS ESSENTIAL PURPOSE. IN NO EVENT SHALL MS, MICROSOFT CORPORATION AND/OR THEIR AFFILIATES BE LIABLE FOR ANY AMOUNT IN EXCESS OF U.S. TWO HUNDRED FIFTY DOLLARS (U.S.\$250.00).

- THERE ARE NO WARRANTIES OTHER THAN THOSE THAT MAY EXPRESSLY BE PROVIDED FOR YOUR NEW VEHICLE.

**Adobe**

Contains Adobe® [Flash® Player] or [AIR®] technology by Adobe Systems Incorporated. This [Licensee Product] contains [Adobe® Flash® Player] [Adobe® AIR®] software under license from Adobe Systems Incorporated, Copyright © 1995-2009 Adobe Macromedia Software LLC. All rights reserved. Adobe, Flash and AIR are trademarks of Adobe Systems Incorporated.

**End user notice****Microsoft® Windows® Mobile for Automotive Important Safety Information**

This system Ford SYNC™ contains software that is licensed to Manufacturer FORD MOTOR COMPANY by an affiliate of Microsoft Corporation pursuant to a license agreement. Any removal, reproduction, reverse engineering or other unauthorized use of the software from this system in violation of the license agreement is strictly prohibited and may subject you to legal action.

**Read and follow instructions**

Before using your Windows Automotive-based system, read and follow all instructions and safety information provided in this end user manual (“User’s Guide”). Not following precautions found in this User’s Guide can lead to an accident or other serious consequences.

**Keep User’s Guide in Vehicle**

When kept in the vehicle, the User’s Guide will be a ready reference for you and other users unfamiliar with the Windows Automotive-based system. Please make certain that before using the system for the first time, all persons have access to the User’s Guide and read its instructions and safety information carefully.



**WARNING:** Operating certain parts of this system while driving can distract your attention away from the road, and possibly cause an accident or other serious consequences. Do not change system settings or enter data non-verbally (using your hands) while driving. Stop the vehicle in a safe and legal manner before attempting these operations. This is important since while setting up or changing some functions you might be required to distract your attention away from the road and remove your hands from the wheel.

**General operation****Voice Command Control**

Functions within the Windows Automotive-based system may be accomplished using only voice commands. Using voice commands while driving allows you to operate the system without removing your hands from the wheel.

**Prolonged Views of Screen**

Do not access any function requiring a prolonged view of the screen while you are driving. Pull over in a safe and legal manner before attempting to access a function of the system requiring prolonged attention. Even occasional short scans to the screen may be hazardous if your attention has been diverted away from your driving task at a critical time.

**Volume Setting**

Do not raise the volume excessively. Keep the volume at a level where you can still hear outside traffic and emergency signals while driving. Driving while unable to hear these sounds could cause an accident.

**Use of Speech Recognition Functions**

Speech recognition software is inherently a statistical process which is subject to errors. It is your responsibility to monitor any speech recognition functions included in the system and address any errors.

**Navigation Features**

Any navigation features included in the system are intended to provide turn by turn instructions to get you to a desired destination. Please make certain all persons using this system carefully read and follow instructions and safety information fully.

**Distraction Hazard**

Any navigation features may require manual (non-verbal) setup. Attempting to perform such set-up or insert data while driving can seriously distract your attention and could cause an accident or other serious consequences. Stop the vehicle in a safe and legal manner before attempting these operations.

**Let Your Judgment Prevail**

Any navigation features are provided only as an aid. Make your driving decisions based on your observations of local conditions and existing traffic regulations. Any such feature is not a substitute for your personal judgment. Any route suggestions made by this system should never replace any local traffic regulations or your personal judgment or knowledge of safe driving practices.

**Route Safety**

Do not follow the route suggestions if doing so would result in an unsafe or illegal maneuver, if you would be placed in an unsafe situation, or if you would be directed into an area that you consider unsafe. The driver is ultimately responsible for the safe operation of the vehicle and therefore, must evaluate whether it is safe to follow the suggested directions.

**Potential Map Inaccuracy**

Maps used by this system may be inaccurate because of changes in roads, traffic controls or driving conditions. Always use good judgment and common sense when following the suggested routes.

**Emergency Services**

Do not rely on any navigation features included in the system to route you to emergency services. Ask local authorities or an emergency services operator for these locations. Not all emergency services such as police, fire stations, hospitals and clinics are likely to be contained in the map database for such navigation features.

**Map Data DVD End User License Terms**

The data ("Data") is provided for your personal, internal use only and not for resale. It is protected by copyright, and is subject to the following terms and conditions which are agreed to by you, on the one hand, and (Licensee). ("Licensee") and its licensors (including their licensors and suppliers) on the other hand. Such licensors include NAVTEQ North America, LLC. Without limiting the foregoing, you agree that NAVTEQ North America, LLC shall have the right to enforce these Terms directly against you. © 2013 NAVTEQ. All rights reserved. The Data for areas of Canada includes information taken with permission from Canadian authorities, including: © Her Majesty the Queen in Right of Canada, © Queen's Printer for Ontario, © Canada Post Corporation, Geobase®.

**Terms and Conditions**

**Personal use only:** You agree to use this Data together with your FLM navigation system for solely personal, non commercial purposes for which you were licensed, and not for service bureau, time-sharing or other similar purposes. Accordingly, but subject to the restrictions set forth in the following paragraphs, you may copy this Data only as necessary for your personal use to (i) view it, and (ii) save it, provided that you do not remove any copyright notices that appear and do not modify the Data in any way. You agree not to otherwise reproduce copy, modify, decompile, disassemble or reverse engineer any portion of this Data, and may not transfer or distribute it in any form, for any purpose, except to the extent permitted by mandatory laws.

**Restrictions:** Except where you have been specifically licensed to do so by (Licensee), and without limiting the preceding paragraph, you may not (a) use this Data with any products, systems, or applications installed or otherwise connected to or in communication with vehicles, capable of vehicle navigation, positioning, dispatch, real time route guidance, fleet management or similar applications; or (b) with or in communication with any positioning devices or any mobile or wireless-connected electronic or computer devices, including without limitation cellular phones, palmtop and handheld computers, pagers, and personal digital assistants or PDAs.

**No warranty:** This Data is provided to you “as is,” and you agree to use it at your own risk. (Licensee) and its licensors (and their licensors and suppliers) make no guarantees, representations or warranties of any kind, express or implied, arising by law or otherwise, including but not limited to, content, quality, accuracy, completeness, effectiveness, reliability, fitness for a particular purpose, usefulness, use or results to be obtained from this Data, or that the Data or server will be uninterrupted or error-free.

**Disclaimer of warranty:**(Licensee) and its licensors (including their licensors and suppliers) disclaim any warranties, express or implied, of quality, performance, merchantability, fitness for a particular purpose or non infringement. Some States, Territories and Countries do not allow certain warranty exclusions, so to that extent the above exclusion may not apply to you.

**Disclaimer of liability:** (Licensee) and its licensors (including their licensors and suppliers) shall not be liable to you: in respect of any claim, demand or action, irrespective of the nature of the cause of the claim, demand or action alleging any loss, injury or damages, direct or indirect, which may result from the use or possession of the information; or for any loss of profit, revenue, contracts or savings, or any other direct, indirect, incidental, special or consequential damages arising out of your use of or inability to use this information, any defect in the information, or the breach of these terms or conditions, whether in an action in contract or tort or based on a warranty, even if (Licensee) or its licensors have been advised of the possibility of such damages. Some States, Territories and Countries do not allow certain liability exclusions or damages limitations, so to that extent the above may not apply to you.

**Export control:** You agree not to export from anywhere any part of the Data provided to you or any direct product thereof except in compliance with, and with all licenses and approvals required under, applicable export laws, rules and regulations.

**Termination for Breach or Bankruptcy:** (Licensee) and its licensors, including NAVTEQ, may terminate this Agreement if you breach any of its terms. Upon any such termination, you shall immediately cease your use of the Data and return all copies thereof to LICENSEE or NAVTEQ, as instructed. (Licensee) and its licensors also may terminate this Agreement in the event that you (i) fail to pay license fees due for the Data, or (ii) if any of the following events occur affecting you: (a) voluntary bankruptcy or application for bankruptcy; (b) involuntary bankruptcy or application for bankruptcy not discharged within sixty (60) days; (c) appointment of receiver for all or a portion of your assets; or (d) any assignment for the benefit of creditors.

**Entire agreement:** These terms and conditions constitute the entire agreement between (Licensee) (and its licensors, including their licensors and suppliers) and you pertaining to the subject matter hereof, and supersedes in their entirety any and all written or oral agreements previously existing between us with respect to such subject matter.

**Governing law:** The above terms and conditions shall be governed by the laws of the Illinois, without giving effect to (i) its conflict of laws provisions, or (ii) the United Nations Convention for Contracts for the International Sale of Goods, which is explicitly excluded. You agree to submit to the jurisdiction of Illinois for any and all disputes, claims and actions arising from or in connection with the Data provided to you hereunder.

### **FCC Compliance**

Changes or modifications not approved by Ford could void user's authority to operate the equipment. This equipment has been tested and found to comply with the limits with the Class B digital device, pursuant to Part 15 of the FCC Rules. These limits are designed to provide reasonable protection against harmful interference in a residential installation. This equipment generates, uses and can radiate radio frequency energy and, if not installed and used in accordance with the instructions, may cause harmful interference to radio communications.

However, there is no guarantee that interference will not occur in a particular installation. If this equipment does cause harmful interference to radio or television reception, which can be determined by turning the equipment off and on, the user is encouraged to consult the dealer or an experienced radio/TV technician for help.

**Gracenote® Copyright**

CD and music — related data from Gracenote, Inc., copyright © 2000–2007 Gracenote. Gracenote Software, copyright © 2000–2007 Gracenote. This product and service may practice one or more of the following U.S. Patents #5,987,525; #6,061,680; #6,154,773, #6,161,132, #6,230,192, #6,230,207, #6,240,459, #6,330,593, and other patents issued or pending. Some services supplied under license from Open Globe, Inc. for U.S. Patent: #6,304,523.

Gracenote and CDDB are registered trademarks of Gracenote. The Gracenote logo and logotype, and the "Powered by Gracenote™" logo are trademarks of Gracenote.

**Gracenote® End User License Agreement (EULA)**

This device contains software from Gracenote, Inc. of 2000 Powell Street Emeryville, California 94608 ("Gracenote").

The software from Gracenote (the "Gracenote Software") enables this device to do disc and music file identification and obtain music-related information, including name, artist, track, and title information ("Gracenote Data") from online servers ("Gracenote Servers"), and to perform other functions. You may use Gracenote Data only by means of the intended End User functions of this device

This device may contain content belonging to Gracenote's providers. If so, all of the restrictions set forth herein with respect to Gracenote Data shall also apply to such content and such content providers shall be entitled to all of the benefits and protections set forth herein that are available to Gracenote.

You agree that you will use the content from Gracenote ("Gracenote Content"), Gracenote Data, the Gracenote Software, and Gracenote Servers for your own personal, non-commercial use only. You agree not to assign, copy, transfer or transmit the Gracenote Content, Gracenote Software or any Gracenote Data (except in a Tag associated with a music file) to any third party. YOU AGREE NOT TO USE OR EXPLOIT GRACENOTE CONTENT, GRACENOTE DATA, THE GRACENOTE SOFTWARE, OR GRACENOTE SERVERS, EXCEPT AS EXPRESSLY PERMITTED HEREIN.

You agree that your non-exclusive licenses to use the Gracenote Content, Gracenote Data, the Gracenote Software, and Gracenote Servers will terminate if you violate these restrictions. If your licenses terminate, you agree to cease any and all use of the Gracenote Content, Gracenote Data, the Gracenote Software, and Gracenote Servers. Gracenote,

respectively, reserve all rights in Gracenote Data, the Gracenote Software, and the Gracenote Servers and Gracenote Content, including all ownership rights. Under no circumstances will either Gracenote become liable for any payment to you for any information that you provide, including any copyrighted material or music file information. You agree that Gracenote may enforce its respective rights, collectively or separately, under this agreement against you, directly in each company's own name.

Gracenote uses a unique identifier to track queries for statistical purposes. The purpose of a randomly assigned numeric identifier is to allow Gracenote to count queries without knowing anything about who you are. For more information, see the web page at [www.gracenote.com](http://www.gracenote.com) for the Gracenote Privacy Policy

THE GRACENOTE SOFTWARE, EACH ITEM OF GRACENOTE DATA AND THE GRACENOTE CONTENT ARE LICENSED TO YOU "AS IS." NEITHER GRACENOTE MAKES ANY REPRESENTATIONS OR WARRANTIES, EXPRESS OR IMPLIED, REGARDING THE ACCURACY OF ANY GRACENOTE DATA FROM THE GRACENOTE SERVERS OR GRACENOTE CONTENT. GRACENOTE COLLECTIVELY AND SEPARATELY RESERVE THE RIGHT TO DELETE DATA AND/OR CONTENT FROM THE COMPANIES' RESPECTIVE SERVERS OR, IN THE CASE OF GRACENOTE, CHANGE DATA CATEGORIES FOR ANY CAUSE THAT GRACENOTE DEEMS SUFFICIENT. NO WARRANTY IS MADE THAT EITHER GRACENOTE CONTENT OR THE GRACENOTE SOFTWARE OR GRACENOTE SERVERS ARE ERROR-FREE OR THAT THE FUNCTIONING OF THE GRACENOTE SOFTWARE OR GRACENOTE SERVERS WILL BE UNINTERRUPTED. GRACENOTE IS NOT OBLIGATED TO PROVIDE YOU WITH ANY ENHANCED OR ADDITIONAL DATA TYPES THAT GRACENOTE MAY CHOOSE TO PROVIDE IN THE FUTURE AND IS FREE TO DISCONTINUE ITS ONLINE SERVICES AT ANY TIME. GRACENOTE DISCLAIM ALL WARRANTIES EXPRESS OR IMPLIED, INCLUDING, BUT NOT LIMITED TO, IMPLIED WARRANTIES OF MERCHANTABILITY, FITNESS FOR A PARTICULAR PURPOSE, TITLE, AND NON-INFRINGEMENT. NEITHER GRACENOTE WARRANTS THE RESULTS THAT WILL BE OBTAINED BY YOUR USE OF THE GRACENOTE SOFTWARE OR ANY GRACENOTE SERVER. IN NO CASE WILL GRACENOTE BE LIABLE FOR ANY CONSEQUENTIAL OR INCIDENTAL DAMAGES OR FOR ANY LOST PROFITS OR LOST REVENUES FOR ANY REASON WHATSOEVER.

© Gracenote 2007

**GENERAL MAINTENANCE INFORMATION****Why Maintain Your Vehicle?**

Carefully following the maintenance schedule helps protect against major repair expenses resulting from neglect or inadequate maintenance and may help to increase the value of your vehicle when you sell or trade it. Keep all receipts for completed maintenance with your vehicle.

We have established regular maintenance intervals for your vehicle based upon rigorous testing. It is important that you have your vehicle serviced at the proper times. These intervals serve two purposes; one is to maintain the reliability of your vehicle and the second is to keep your cost of owning your vehicle down.

It is your responsibility to have all scheduled maintenance performed and to make sure that the materials used meet the specifications identified in the *Capacities and Specifications* chapter of this owner's manual.

Failure to perform scheduled maintenance invalidates warranty coverage on parts affected by the lack of maintenance.

**Why Maintain Your Vehicle at Your Dealership?*****Factory-Trained Technicians***

Service technicians participate in extensive factory-sponsored certification training to help them become experts on the operation of your vehicle. Ask your dealership about the training and certification their technicians have received.

***Genuine Ford and Motorcraft® Replacement Parts***

Dealerships stock Ford, Motorcraft and Ford-authorized branded re-manufactured replacement parts. These parts meet or exceed our specifications. Parts installed at your dealership carry a nationwide 24-month or unlimited miles (kilometers) parts and labor limited warranty.

If you do not use Ford authorized parts they may not meet our specifications and depending on the part, it could affect emissions compliance.

### **Convenience**

Many dealerships have extended evening and Saturday hours to make your service visit more convenient and they offer one stop shopping. They can perform any services that are required on your vehicle, from general maintenance to collision repairs.

**Note:** Not all dealers have extended hours or body shops. Please contact your dealer for details.

### **Protecting Your Investment**

Maintenance is an investment that pays dividends in the form of improved reliability, durability and resale value. To maintain the proper performance of your vehicle and its emission control systems, make sure you have scheduled maintenance performed at the designated intervals.

Your vehicle is very sophisticated and built with multiple, complex, performance systems. Every manufacturer develops these systems using different specifications and performance features. That is why it is important to rely upon your dealership to properly diagnose and repair your vehicle.

Ford Motor Company has recommended maintenance intervals for various parts and component systems based upon engineering testing. Ford Motor Company relies upon this testing to determine the most appropriate mileage for replacement of oils and fluids to protect your vehicle at the lowest overall cost to you and recommends against maintenance schedules that deviate from the scheduled maintenance information.

We strongly recommend the use of only genuine Ford, Motorcraft or Ford-authorized re-manufactured replacement parts engineered for your vehicle.

### **Additives and Chemicals**

This owner's manual and the Ford Workshop Manual list the recommended additives and chemicals for your vehicle. We do not recommend using chemicals or additives not approved by us as part of your vehicle's normal maintenance. Please consult your warranty information.

**Oils, Fluids and Flushing**

In many cases, fluid discoloration is a normal operating characteristic and, by itself, does not necessarily indicate a concern or that the fluid needs to be changed. However, a qualified expert, such as the factory-trained technicians at your dealership, should inspect discolored fluids that also show signs of overheating or foreign material contamination immediately.

Make sure to change your vehicle's oils and fluids at the specified intervals or in conjunction with a repair. Flushing is a viable way to change fluid for many vehicle sub-systems during scheduled maintenance. It is critical that systems are flushed only with new fluid that is the same as that required to fill and operate the system or using a Ford-approved flushing chemical.

**Owner Checks and Services**

Certain basic maintenance checks and inspections should be performed every month or at six month intervals.

<b>Check every month</b>
Engine oil level.
Function of all interior and exterior lights.
Tires (including spare) for wear and proper pressure.
Windshield washer fluid level.
<b>Check every six months</b>
Battery connections. Clean if necessary.
Body and door drain holes for obstructions. Clean if necessary.
Cooling system fluid level and coolant strength.
Door weatherstrips for wear. Lubricate if necessary.
Hinges, latches and outside locks for proper operation. Lubricate if necessary.
Parking brake for proper operation.
Safety belts and seat latches for wear and function.
Safety warning lamps (brake, ABS, airbag, safety belt) for operation.
Washer spray and wiper operation. Clean or replace blades as necessary.

**Multi-point Inspection**

In order to keep your vehicle running right, it is important to have the systems on your vehicle checked regularly. This can help identify potential issues and prevent major problems. Ford Motor Company recommends the following multi-point inspection be performed at every scheduled maintenance interval to help make sure your vehicle keeps running great.

<b>Multi-point inspection</b>	
Accessory drive belt(s)	Hazard warning system operation
Battery performance	Horn operation
Engine air filter	Radiator, cooler, heater and A/C hoses
Exhaust system	Suspension components for leaks or damage
Exterior lamps operation	Steering and linkage
Fluid levels <sup>*</sup> ; fill if necessary	Tires (including spare) for wear and proper pressure <sup>**</sup>
For oil and fluid leaks	Windshield for cracks, chips or pits
Half-shaft dust boots	Washer spray and wiper operation

<sup>\*</sup>Brake, coolant recovery reservoir, automatic transmission, power steering (if equipped) and window washer.

<sup>\*\*</sup>If your vehicle is equipped with a temporary mobility kit, check the tire sealant expiration Use By date on the canister. Replace as needed.

Be sure to ask your dealership service advisor or technician about the multi-point vehicle inspection. It is a comprehensive way to perform a thorough inspection of your vehicle. It is your checklist that gives you immediate feedback on the overall condition of your vehicle. You will know what has been checked, what is okay, as well as those things that may require future or immediate attention. The multi-point vehicle inspection is one more way to keep your vehicle running great!



LINK & PIN





Member's Member id:  
Member's Service Balance:

**Multi-Point Inspection Report Card as Recommended by Ford Motor Company**

Name: \_\_\_\_\_ Today's Date: \_\_\_\_\_ Mileage: \_\_\_\_\_ State Inspection Month: \_\_\_\_\_

E-Mail Address: \_\_\_\_\_ Make/Model/Year: \_\_\_\_\_

SCHEDULED MAINTENANCE		THINGS TO DO FOR SERVICES ON THIS MAINT	
OK	NOT OK	OK	NOT OK
<input type="checkbox"/>	<input type="checkbox"/>	Oil Filter	<input type="checkbox"/>
<input type="checkbox"/>	<input type="checkbox"/>	Engine Air Filter	<input type="checkbox"/>
<input type="checkbox"/>	<input type="checkbox"/>	Engine Coolant	<input type="checkbox"/>
<input type="checkbox"/>	<input type="checkbox"/>	Brake Fluid	<input type="checkbox"/>
<input type="checkbox"/>	<input type="checkbox"/>	Oil Change	<input type="checkbox"/>
<input type="checkbox"/>	<input type="checkbox"/>	SI Filter	<input type="checkbox"/>
<input type="checkbox"/>	<input type="checkbox"/>	Spark Plugs	<input type="checkbox"/>
<input type="checkbox"/>	<input type="checkbox"/>	Tire Rotation	<input type="checkbox"/>
<input type="checkbox"/>	<input type="checkbox"/>	Transmission Fluid	<input type="checkbox"/>
<input type="checkbox"/>	<input type="checkbox"/>	Transmission Filter	<input type="checkbox"/>

\*This is only a partial list of vehicle maintenance items and is NOT all-inclusive. Please consult your Owner's Manual or visit www.fordmotor.com for vehicle specific maintenance requirements.

CHECK FLUID LEVELS AND FILL		OK	NOT OK
<input type="checkbox"/>	Oil and/or fluid leaks	<input type="checkbox"/>	<input type="checkbox"/>
<input type="checkbox"/>	Wash Fluid	<input type="checkbox"/>	<input type="checkbox"/>
<input type="checkbox"/>	Engine Oil	<input type="checkbox"/>	<input type="checkbox"/>
<input type="checkbox"/>	Power Steering	<input type="checkbox"/>	<input type="checkbox"/>
<input type="checkbox"/>	Windshield Washer	<input type="checkbox"/>	<input type="checkbox"/>
<input type="checkbox"/>	Brake Fluid	<input type="checkbox"/>	<input type="checkbox"/>
<input type="checkbox"/>	Antifreeze/Coolant	<input type="checkbox"/>	<input type="checkbox"/>

**BATTERY**

State of Health: \_\_\_\_\_ Condition of \_\_\_\_\_

Factory spec cold cranking amps: \_\_\_\_\_

Notes any existing exterior body damage or defects: \_\_\_\_\_

EXTERIOR BODY		OK	NOT OK
<input type="checkbox"/>	Wash/wax	<input type="checkbox"/>	<input type="checkbox"/>
<input type="checkbox"/>	Wash/wax	<input type="checkbox"/>	<input type="checkbox"/>
<input type="checkbox"/>	Wash/wax	<input type="checkbox"/>	<input type="checkbox"/>
<input type="checkbox"/>	Wash/wax	<input type="checkbox"/>	<input type="checkbox"/>

THE BRAKE WEAR		OK	NOT OK
<input type="checkbox"/>	Front Brake Pads/Drum	<input type="checkbox"/>	<input type="checkbox"/>
<input type="checkbox"/>	Front Brake Lining	<input type="checkbox"/>	<input type="checkbox"/>
<input type="checkbox"/>	Rear Brake Pads/Drum	<input type="checkbox"/>	<input type="checkbox"/>
<input type="checkbox"/>	Rear Brake Lining	<input type="checkbox"/>	<input type="checkbox"/>

TIRE TREAD		OK	NOT OK
<input type="checkbox"/>	Front Left	<input type="checkbox"/>	<input type="checkbox"/>
<input type="checkbox"/>	Front Right	<input type="checkbox"/>	<input type="checkbox"/>
<input type="checkbox"/>	Rear Left	<input type="checkbox"/>	<input type="checkbox"/>
<input type="checkbox"/>	Rear Right	<input type="checkbox"/>	<input type="checkbox"/>

Comments: \_\_\_\_\_

Service Advisor: \_\_\_\_\_ Customer's Signature: \_\_\_\_\_

Technician: \_\_\_\_\_

12-XXXXXXXX

© 2014 Ford Motor Company. Ford Motor Company, an Equal Opportunity Employer.

**NORMAL SCHEDULED MAINTENANCE AND LOG**

The following section contains the Normal Scheduled Maintenance. This schedule is presented at specific mileage (kilometer) intervals with exceptions as noted.

Normal scheduled maintenance	
Every 7500 miles (12000 km) or six months (whichever comes first)	Change engine oil and filter.*
	Rotate tires, inspect tire wear and measure tread depth.
	Inspect wheels and related components for abnormal noise, wear, looseness or drag.
	Perform multi-point inspection (recommended).
Every 15000 miles (24000 km) or 12 months (whichever comes first)	Inspect automatic transmission fluid level. Consult dealer for requirements.
	Inspect brake pads, shoes, rotors, drums, brake linings, hoses and parking brake.
	Inspect engine cooling system strength and hoses.
	Inspect exhaust system and heat shields.
	Inspect front axle and U-joints. Lubricate if equipped with grease fittings (4WD vehicles).
	Inspect half-shaft boots.
	Inspect steering linkage, ball joints, suspension, tie-rod ends, driveshaft and U-joints. Lubricate if equipped with grease fittings.

\*Reset your oil life monitoring system after each engine oil and filter change. See the *Instrument Cluster* chapter.

Other maintenance items	
Every 30000 miles (48000 km)	Replace climate-controlled (heated and cooled) seat filter (if equipped).
	Replace engine air filter.
Every 97500 miles (156000 km)	Replace spark plugs.
Every 105000 miles (168000 km)	Change engine coolant.*
	Inspect accessory drive belt(s).**
Every 150000 miles (240000 km)	Change automatic transmission fluid and filter. Consult dealer for requirements.
	Change front axle fluid (4WD vehicles).
	Change rear axle fluid.
	Change transfer case fluid (4WD vehicles).
	Replace accessory drive belt(s) if not replaced within the last 100000 miles (160000 km).

\*Initial replacement at six years or 105000 miles (168000 kilometers), then every three years or 45000 miles (72000 kilometers).

\*\*If not replaced, inspect every 15000 miles (24000 kilometers).

## Scheduled Maintenance

485

### Maintenance Schedule Log

<p style="text-align: center;">DEALER VALIDATION:</p>  <p style="text-align: center;">P&amp;A CODE:</p> <p>RO#:            HOURS:</p> <p>DATE:          MILEAGE:</p>	<p style="text-align: center;">DEALER VALIDATION:</p>  <p style="text-align: center;">P&amp;A CODE:</p> <p>RO#:            HOURS:</p> <p>DATE:          MILEAGE:</p>
<p style="text-align: center;">DEALER VALIDATION:</p>  <p style="text-align: center;">P&amp;A CODE:</p> <p>RO#:            HOURS:</p> <p>DATE:          MILEAGE:</p>	<p style="text-align: center;">DEALER VALIDATION:</p>  <p style="text-align: center;">P&amp;A CODE:</p> <p>RO#:            HOURS:</p> <p>DATE:          MILEAGE:</p>
<p style="text-align: center;">DEALER VALIDATION:</p>  <p style="text-align: center;">P&amp;A CODE:</p> <p>RO#:            HOURS:</p> <p>DATE:          MILEAGE:</p>	<p style="text-align: center;">DEALER VALIDATION:</p>  <p style="text-align: center;">P&amp;A CODE:</p> <p>RO#:            HOURS:</p> <p>DATE:          MILEAGE:</p>
<p style="text-align: center;">DEALER VALIDATION:</p>  <p style="text-align: center;">P&amp;A CODE:</p> <p>RO#:            HOURS:</p> <p>DATE:          MILEAGE:</p>	<p style="text-align: center;">DEALER VALIDATION:</p>  <p style="text-align: center;">P&amp;A CODE:</p> <p>RO#:            HOURS:</p> <p>DATE:          MILEAGE:</p>
<p style="text-align: center;">DEALER VALIDATION:</p>  <p style="text-align: center;">P&amp;A CODE:</p> <p>RO#:            HOURS:</p> <p>DATE:          MILEAGE:</p>	<p style="text-align: center;">DEALER VALIDATION:</p>  <p style="text-align: center;">P&amp;A CODE:</p> <p>RO#:            HOURS:</p> <p>DATE:          MILEAGE:</p>

**Scheduled Maintenance**

<p style="text-align: center;">DEALER VALIDATION:</p>  <p style="text-align: center;">P&amp;A CODE:</p> <p>RO#:            HOURS:</p> <p>DATE:           MILEAGE:</p>	<p style="text-align: center;">DEALER VALIDATION:</p>  <p style="text-align: center;">P&amp;A CODE:</p> <p>RO#:            HOURS:</p> <p>DATE:           MILEAGE:</p>
<p style="text-align: center;">DEALER VALIDATION:</p>  <p style="text-align: center;">P&amp;A CODE:</p> <p>RO#:            HOURS:</p> <p>DATE:           MILEAGE:</p>	<p style="text-align: center;">DEALER VALIDATION:</p>  <p style="text-align: center;">P&amp;A CODE:</p> <p>RO#:            HOURS:</p> <p>DATE:           MILEAGE:</p>
<p style="text-align: center;">DEALER VALIDATION:</p>  <p style="text-align: center;">P&amp;A CODE:</p> <p>RO#:            HOURS:</p> <p>DATE:           MILEAGE:</p>	<p style="text-align: center;">DEALER VALIDATION:</p>  <p style="text-align: center;">P&amp;A CODE:</p> <p>RO#:            HOURS:</p> <p>DATE:           MILEAGE:</p>
<p style="text-align: center;">DEALER VALIDATION:</p>  <p style="text-align: center;">P&amp;A CODE:</p> <p>RO#:            HOURS:</p> <p>DATE:           MILEAGE:</p>	<p style="text-align: center;">DEALER VALIDATION:</p>  <p style="text-align: center;">P&amp;A CODE:</p> <p>RO#:            HOURS:</p> <p>DATE:           MILEAGE:</p>
<p style="text-align: center;">DEALER VALIDATION:</p>  <p style="text-align: center;">P&amp;A CODE:</p> <p>RO#:            HOURS:</p> <p>DATE:           MILEAGE:</p>	<p style="text-align: center;">DEALER VALIDATION:</p>  <p style="text-align: center;">P&amp;A CODE:</p> <p>RO#:            HOURS:</p> <p>DATE:           MILEAGE:</p>

## Scheduled Maintenance

487

<p style="text-align: center;">DEALER VALIDATION:</p>  <p style="text-align: center;">P&amp;A CODE:</p> <p>RO#:                    HOURS:</p> <p>DATE:                  MILEAGE:</p>	<p style="text-align: center;">DEALER VALIDATION:</p>  <p style="text-align: center;">P&amp;A CODE:</p> <p>RO#:                    HOURS:</p> <p>DATE:                  MILEAGE:</p>
<p style="text-align: center;">DEALER VALIDATION:</p>  <p style="text-align: center;">P&amp;A CODE:</p> <p>RO#:                    HOURS:</p> <p>DATE:                  MILEAGE:</p>	<p style="text-align: center;">DEALER VALIDATION:</p>  <p style="text-align: center;">P&amp;A CODE:</p> <p>RO#:                    HOURS:</p> <p>DATE:                  MILEAGE:</p>
<p style="text-align: center;">DEALER VALIDATION:</p>  <p style="text-align: center;">P&amp;A CODE:</p> <p>RO#:                    HOURS:</p> <p>DATE:                  MILEAGE:</p>	<p style="text-align: center;">DEALER VALIDATION:</p>  <p style="text-align: center;">P&amp;A CODE:</p> <p>RO#:                    HOURS:</p> <p>DATE:                  MILEAGE:</p>
<p style="text-align: center;">DEALER VALIDATION:</p>  <p style="text-align: center;">P&amp;A CODE:</p> <p>RO#:                    HOURS:</p> <p>DATE:                  MILEAGE:</p>	<p style="text-align: center;">DEALER VALIDATION:</p>  <p style="text-align: center;">P&amp;A CODE:</p> <p>RO#:                    HOURS:</p> <p>DATE:                  MILEAGE:</p>
<p style="text-align: center;">DEALER VALIDATION:</p>  <p style="text-align: center;">P&amp;A CODE:</p> <p>RO#:                    HOURS:</p> <p>DATE:                  MILEAGE:</p>	<p style="text-align: center;">DEALER VALIDATION:</p>  <p style="text-align: center;">P&amp;A CODE:</p> <p>RO#:                    HOURS:</p> <p>DATE:                  MILEAGE:</p>

**SPECIAL OPERATING CONDITIONS**

If you operate your vehicle **primarily** in any of the following conditions, you need to perform additional maintenance as indicated. If you **occasionally** operate your vehicle under any of these conditions, it is not necessary to perform the additional maintenance. For specific recommendations, see your dealership service advisor or technician.

<b>Towing a trailer or using a car-top carrier</b>	
Inspect frequently, service as required	Inspect and lubricate U-joints, if equipped with grease fittings.
	See axle maintenance items under <i>Exceptions</i> .
Every 5000 miles (8000 km)	Inspect wheels and related components for abnormal noise, wear, looseness or drag.
	Rotate tires, inspect tires for wear and measure tread depth.
Every 5000 miles (8000 km) or six months	Change engine oil and filter.*
	Inspect and lubricate U-joints, if equipped with grease fittings.
Every 60000 miles (96000 km)	Change transfer case fluid (4WD vehicles).

\*Reset your oil life monitoring system after each engine oil and filter change. See the *Instrument Cluster* chapter.

<b>Extensive idling or low-speed driving for long distances as in heavy commercial use (such as delivery, taxi, patrol car or livery)</b>	
Inspect frequently, service as required	Replace engine air filter.
Every 5000 miles (8000 km)	Inspect brake system.
	Inspect wheels and related components for abnormal noise, wear, looseness or drag.
	Lubricate control arm and steering ball joints if equipped with grease fittings.
	Rotate tires, inspect tires for wear and measure tread depth.

<b>Extensive idling or low-speed driving for long distances as in heavy commercial use (such as delivery, taxi, patrol car or livery)</b>	
Every 5000 miles (8000 km) or six months	Change engine oil and filter.*
Every 60000 miles (96000 km)	Change transfer case fluid (4WD vehicles).
	Replace spark plugs.

\*Reset your oil life monitoring system after each engine oil and filter change. See the *Instrument Cluster* chapter.

<b>Operating in dusty or sandy conditions such as unpaved or dusty roads</b>	
Inspect frequently, service as required	Replace engine air filter.
Every 5000 miles (8000 km)	Inspect the wheels and related components for abnormal noise, wear, looseness or drag.
	Rotate tires, inspect tires for wear and measure tread depth.
Every 5000 miles (8000 km) or six months	Change engine oil and filter.*
	Inspect and lubricate U-joints, if equipped with grease fittings.
Every 60000 miles (96000 km)	Change transfer case fluid (4WD vehicles).

\*Reset your oil life monitoring system after each engine oil and filter change. See the *Instrument Cluster* chapter.

<b>Off-road operation</b>	
Inspect frequently, service as required	Inspect steering linkage, ball joints and U-joints. Lubricate if equipped with grease fittings.
	Replace engine air filter.

<b>Off-road operation</b>	
Every 5000 miles (8000 km)	Change engine oil and filter.*
	Inspect the wheels and related components for abnormal noise, wear, looseness or drag.
	Rotate tires, inspect tires for wear and measure tread depth.
Every 60000 miles (96000 km)	Change transfer case fluid (4WD vehicles).

\*Reset your oil life monitoring system after each engine oil and filter change. See the *Instrument Cluster* chapter.

<b>Exclusive use of E85 (flex fuel vehicles only)</b>	
Every oil change	If ran exclusively on E85, fill the fuel tank full with regular unleaded fuel.

## Scheduled Maintenance

491

### Special Operating Condition Log

<p style="text-align: center;">DEALER VALIDATION:</p> <p style="text-align: center;">P&amp;A CODE:</p> <p>RO#:                    HOURS:</p> <p>DATE:                  MILEAGE:</p>	<p style="text-align: center;">DEALER VALIDATION:</p> <p style="text-align: center;">P&amp;A CODE:</p> <p>RO#:                    HOURS:</p> <p>DATE:                  MILEAGE:</p>
<p style="text-align: center;">DEALER VALIDATION:</p> <p style="text-align: center;">P&amp;A CODE:</p> <p>RO#:                    HOURS:</p> <p>DATE:                  MILEAGE:</p>	<p style="text-align: center;">DEALER VALIDATION:</p> <p style="text-align: center;">P&amp;A CODE:</p> <p>RO#:                    HOURS:</p> <p>DATE:                  MILEAGE:</p>
<p style="text-align: center;">DEALER VALIDATION:</p> <p style="text-align: center;">P&amp;A CODE:</p> <p>RO#:                    HOURS:</p> <p>DATE:                  MILEAGE:</p>	<p style="text-align: center;">DEALER VALIDATION:</p> <p style="text-align: center;">P&amp;A CODE:</p> <p>RO#:                    HOURS:</p> <p>DATE:                  MILEAGE:</p>
<p style="text-align: center;">DEALER VALIDATION:</p> <p style="text-align: center;">P&amp;A CODE:</p> <p>RO#:                    HOURS:</p> <p>DATE:                  MILEAGE:</p>	<p style="text-align: center;">DEALER VALIDATION:</p> <p style="text-align: center;">P&amp;A CODE:</p> <p>RO#:                    HOURS:</p> <p>DATE:                  MILEAGE:</p>
<p style="text-align: center;">DEALER VALIDATION:</p> <p style="text-align: center;">P&amp;A CODE:</p> <p>RO#:                    HOURS:</p> <p>DATE:                  MILEAGE:</p>	<p style="text-align: center;">DEALER VALIDATION:</p> <p style="text-align: center;">P&amp;A CODE:</p> <p>RO#:                    HOURS:</p> <p>DATE:                  MILEAGE:</p>

**Scheduled Maintenance**

<p style="text-align: center;">DEALER VALIDATION:</p>  <p style="text-align: center;">P&amp;A CODE:</p> <p>RO#:            HOURS:</p> <p>DATE:           MILEAGE:</p>	<p style="text-align: center;">DEALER VALIDATION:</p>  <p style="text-align: center;">P&amp;A CODE:</p> <p>RO#:            HOURS:</p> <p>DATE:           MILEAGE:</p>
<p style="text-align: center;">DEALER VALIDATION:</p>  <p style="text-align: center;">P&amp;A CODE:</p> <p>RO#:            HOURS:</p> <p>DATE:           MILEAGE:</p>	<p style="text-align: center;">DEALER VALIDATION:</p>  <p style="text-align: center;">P&amp;A CODE:</p> <p>RO#:            HOURS:</p> <p>DATE:           MILEAGE:</p>
<p style="text-align: center;">DEALER VALIDATION:</p>  <p style="text-align: center;">P&amp;A CODE:</p> <p>RO#:            HOURS:</p> <p>DATE:           MILEAGE:</p>	<p style="text-align: center;">DEALER VALIDATION:</p>  <p style="text-align: center;">P&amp;A CODE:</p> <p>RO#:            HOURS:</p> <p>DATE:           MILEAGE:</p>
<p style="text-align: center;">DEALER VALIDATION:</p>  <p style="text-align: center;">P&amp;A CODE:</p> <p>RO#:            HOURS:</p> <p>DATE:           MILEAGE:</p>	<p style="text-align: center;">DEALER VALIDATION:</p>  <p style="text-align: center;">P&amp;A CODE:</p> <p>RO#:            HOURS:</p> <p>DATE:           MILEAGE:</p>
<p style="text-align: center;">DEALER VALIDATION:</p>  <p style="text-align: center;">P&amp;A CODE:</p> <p>RO#:            HOURS:</p> <p>DATE:           MILEAGE:</p>	<p style="text-align: center;">DEALER VALIDATION:</p>  <p style="text-align: center;">P&amp;A CODE:</p> <p>RO#:            HOURS:</p> <p>DATE:           MILEAGE:</p>

**EXCEPTIONS**

**Normal vehicle axle maintenance:** Rear axles and power take-off units with synthetic fluid and light-duty trucks equipped with Ford-design axles are lubricated for life; do not check or change fluid unless a leak is suspected, service is required or the assembly has been submerged in water. During long periods of trailer towing with outside temperatures above 70°F (21°C) and at wide-open throttle for long periods above 45 mph (72 km/h), non-synthetic rear axle fluids should be changed every 3000 miles (4800 kilometers) or three months, whichever comes first. This interval can be waived if the axle is filled with 75W140 synthetic gear fluid meeting Ford specification WSL-M2C192-A, part number FITZ-19580-B or equivalent. Add friction modifier XL-3 (EST-M2C118-A) or equivalent for complete refill of Traction-Lok rear axles (see *Technical specifications* in the *Capacities and Specifications* chapter for details).

**Police/Taxi/Livery vehicle axle maintenance:** Change rear axle fluid every 100000 miles (160000 km). Rear axle fluid change may be waived if the axle was filled with 75W140 synthetic gear fluid meeting Ford specification WSL-M2C192-A, part number FITZ-19580-B or equivalent. Add four ounces (118 mL) of additive friction modifier XL-3 (EST-M2C118-A) or equivalent for complete refill of Traction-Lok rear axles. The axle fluid should be changed anytime the axle has been submerged in water.

**California fuel filter replacement:** If the vehicle is registered in California, the California Air Resources Board has determined that the failure to perform this maintenance item will not nullify the emission warranty or limit recall liability prior to the completion of the vehicle's useful life. Ford Motor Company, however, urges you to have all recommended maintenance services performed at the specified intervals and to record all vehicle service.

**Hot climate oil change intervals:** Vehicles operating in the Middle East, North Africa, Sub-Saharan Africa or locations with similar climates using an American Petroleum Institute (API) Certified for Gasoline Engines (Certification mark) oil of SM or SN quality, the normal oil change interval is 5000 miles (8000 kilometers). If the available API SM or SN oils are not available, then the oil change service interval is 3000 miles (4800 kilometers).

**Engine air filter replacement:** Engine air filter life is dependent on exposure to dusty and dirty conditions. Vehicles operated in these conditions require frequent inspection and replacement of the engine air filter.

**ENGINE COOLANT CHANGE RECORD**

Initial change	Six years or 105000 miles (168000 km) (whichever comes first)
After initial change	Every three years or 45000 miles (72000 km)

**Engine Coolant Change Log**

<p style="text-align: center;">DEALER VALIDATION:</p>  <p style="text-align: center;">P&amp;A CODE:</p> <p>RO#:            HOURS:</p> <p>DATE:           MILEAGE:</p>	<p style="text-align: center;">DEALER VALIDATION:</p>  <p style="text-align: center;">P&amp;A CODE:</p> <p>RO#:            HOURS:</p> <p>DATE:           MILEAGE:</p>
<p style="text-align: center;">DEALER VALIDATION:</p>  <p style="text-align: center;">P&amp;A CODE:</p> <p>RO#:            HOURS:</p> <p>DATE:           MILEAGE:</p>	<p style="text-align: center;">DEALER VALIDATION:</p>  <p style="text-align: center;">P&amp;A CODE:</p> <p>RO#:            HOURS:</p> <p>DATE:           MILEAGE:</p>
<p style="text-align: center;">DEALER VALIDATION:</p>  <p style="text-align: center;">P&amp;A CODE:</p> <p>RO#:            HOURS:</p> <p>DATE:           MILEAGE:</p>	<p style="text-align: center;">DEALER VALIDATION:</p>  <p style="text-align: center;">P&amp;A CODE:</p> <p>RO#:            HOURS:</p> <p>DATE:           MILEAGE:</p>

- 
- 911 Assist™ .....381
- A**
- ABS (see Brakes) .....187
- Accessing call history/phone book during active call .....370
- Accessing the help screen .....444
- Accessing the music in your jukebox .....438
- Accessing your media menu features .....394
- Accessing your phone menu features .....372
- Accessory delay .....93
- Active call menu options .....370
- Advanced menu options ...379, 401
- Advanced menu options (prompts, languages, defaults, master reset, installing applications) .....379
- Airbag supplemental restraint system .....49
- and child safety seats .....50
- description .....49
- disposal .....55
- driver airbag .....49
- passenger airbag .....49
- side airbag .....49, 51
- Air cleaner filter .....265–266, 321
- Air filter .....266, 321
- All Wheel Drive (AWD), driving off road .....179
- Ambulance packages .....15
- AM/FM .....420
- Antifreeze (see Engine coolant) .....255
- Anti-lock brake system (see Brakes) .....187
- Anti-theft system .....77, 79
- arming the system .....77, 79
- disarming a triggered system ...79
- AppLink™ .....389
- Audio system
- Single CD .....331
- Audio system (see Radio) .....331
- Automatic transmission
- driving an automatic overdrive .....174
- fluid, adding .....260
- fluid, checking .....260
- fluid, refill capacities .....317
- fluid, specification .....317
- Auxiliary input jack (Line in) ...340
- Auxiliary powerpoint .....153
- Axle
- lubricant specifications .....317
- refill capacities .....317
- B**
- Battery .....261
- acid, treating emergencies ....261
- jumping a disabled battery ...231
- maintenance-free .....261
- replacement, specifications ...321
- servicing .....261
- Booster seats .....22
- Brakes .....187
- anti-lock .....187
- anti-lock brake system (ABS) warning light .....187
- brake warning light .....187
- fluid, checking and adding ....260
- fluid, refill capacities .....317
- fluid, specifications .....317

- 
- lubricant specifications .....317
  - parking .....188
  - shift interlock .....177
  - trailer .....220
- C**
- Capacities for refilling fluids ....317
  - Car2U® Home Automation System .....143
  - Cargo management system .....210
  - CD .....331
  - CD player .....329
  - CD voice commands .....434, 436–437
  - Cell phone use .....16
  - Changing a tire .....307
  - Changing the air filter .....266
  - Child safety seats
    - automatic locking mode (retractor) .....39
    - LATCH .....27
  - Child safety seats - booster seats .....22
  - Cleaning the touchscreen .....415
  - Cleaning your vehicle .....275
    - engine compartment .....277
    - instrument panel .....280
    - interior .....279
    - plastic parts .....276
    - washing .....275
    - waxing .....277
    - wheels .....281
    - wiper blades .....278
  - Clock .....117, 331
  - Console
    - overhead .....96–97, 156
  - Controls
    - power seat .....128
  - Coolant .....255
    - checking and adding .....255
    - refill capacities .....317
    - specifications .....317
  - Creating a playlist .....440
  - Cruise control .....198
  - Customer Assistance .....228
    - Ford Extended Service Plan ...326
    - Getting roadside assistance ....228
    - Getting the service you need .....234
    - Ordering additional owner’s literature .....240
    - Utilizing the Mediation/Arbitration Program .....238
  - Customizing your home screen .....413
- D**
- Daytime running lamps (see Lamps) .....89
  - Defrost .....118, 120
    - rear window .....124
  - Dipstick
    - automatic transmission fluid ...260
    - engine oil .....254
  - Driving under special conditions .....178, 182, 184
    - sand .....183
    - snow and ice .....185
    - through water .....183, 226
  - Dual automatic temperature control (DATC) .....118, 120
  - DVD (if equipped) .....342

- 
- DVD region coding .....350  
 DVD system .....342
- E**
- Electronic message center .....107  
 Electronic stability control .....191  
 Emergencies, roadside  
   jump-starting .....231  
   running out of fuel .....166  
 Emission control system .....170  
 End user license agreement ....466  
 Engine .....316  
   cleaning .....277  
   coolant .....255  
   fail-safe cooling .....258  
   idle speed control .....261  
   lubrication specifications .....317  
   refill capacities .....317  
   service points .....253  
   starting after a collision .....230  
 Engine block heater .....161  
 Engine oil  
   checking and adding .....254  
   dipstick .....254  
   filter, specifications .....321  
   refill capacities .....317  
   specifications .....317  
 Event data recording .....12  
 Exhaust fumes .....161
- F**
- Fail safe cooling .....258  
 Fleet MyKey programming .....60  
 Floor mats .....227  
 Fluid capacities .....317  
 Fog lamps .....89
- Forward and reverse sensing  
 system .....193  
 Four-Wheel Drive vehicles .....179  
   description .....180  
   driving off road .....181  
   indicator light .....179
- Fuel**  
   cap .....168  
   capacity .....317  
   choosing the right fuel ...164–165  
   filler funnel .....166  
   filling your vehicle with fuel ..168  
   filter, specifications .....261  
   fuel pump shut-off switch ....230  
   octane rating .....165, 316  
   quality .....164  
   running out of fuel .....166  
   safety information relating to  
   automotive fuels .....163
- Fuel - flex fuel vehicle  
 (FFV) .....164–165
- Fuses .....242–243, 247
- G**
- Garage door opener .....143, 147  
 Gas cap (see Fuel cap) .....168  
 Gauges .....100
- H**
- Hazard flashers .....229  
 HD Radio™ .....423  
 Headlamps .....87  
   aiming .....268  
   autolamp system .....88  
   bulb specifications .....274  
   checking alignment .....268  
   daytime running lights .....89  
   flash to pass .....87

- 
- high beam .....87
  - replacing bulbs .....270
  - turning on and off .....87
  - Head restraints .....126
  - Heating .....118, 120
  - Homelink wireless control system .....147
  - Hood .....252
  - I**
  - Ignition .....158, 316
  - Illuminated visor mirror .....97–98
  - Information displays .....107
  - Inspection/maintenance (I/M) testing .....173
  - Instrument panel
    - cleaning .....280
    - cluster .....101
  - J**
  - Jack .....307
    - positioning .....307
    - storage .....307
  - Joining two calls (multiparty/conference call) ....370
  - Jukebox features .....438
  - Jump-starting your vehicle .....231
  - K**
  - Keyless entry system
    - autolock .....68
    - keypad .....75
    - locking and unlocking doors ....76
    - programming entry code .....75
  - Keys .....57, 78
    - positions of the ignition .....158
  - L**
  - Lamps .....87
    - autolamp system .....88
    - bulb replacement specifications chart .....274
    - daytime running light .....89
    - fog lamps .....89
    - headlamps .....87
    - headlamps, flash to pass .....87
    - interior lamps .....90
    - replacing bulbs .....270, 273
  - Lane change indicator (see Turn signal) .....89
  - LATCH anchors .....27
  - Liftgate .....68, 70–71
  - Lights, warning and indicator ...101
  - Loading instructions .....209
  - Loading pictures .....414
  - Load limits .....203
  - Locks
    - autolock .....68
    - childproof .....35
    - doors .....67
  - Lubricant specifications .....317
  - Lug nuts .....315
  - M**
  - MAP DVD - Loading and Unloading .....350
  - Map icons .....459
  - Map mode .....459
  - Map updates .....462
  - Master lighting switch .....87

- 
- Media Bluetooth menu options  
(adding, connecting, deleting,  
turning on/off) .....400
- Message center .....107  
warning messages .....113
- Mirrors .....93, 96  
programmable memory .....58  
side view mirrors (power) .....93  
signal .....94-95
- Moon roof .....98
- Motorcraft® parts .....275, 321
- MyKey .....60
- N**
- Navigation end user license  
agreement .....473
- Navigation features .....445
- O**
- Octane rating .....165
- P**
- Pairing other phones .....367
- Pairing your phone for the  
first time .....366
- Parental MyKey programming ...60
- Parking brake .....188
- Parts (see Motorcraft®  
parts) .....321
- Phone Bluetooth menu options  
(adding, connecting, deleting,  
turning on/off) .....378
- Phone redial .....372
- Playing a DVD in the system ....350
- Playing music (by artist,  
album, genre, playlist, tracks,  
similar) .....397
- POI categories .....454
- Point of Interest (POI) .....454
- Power deployable running  
boards .....211
- Power distribution box  
(see Fuses) .....243, 247
- Power door locks .....67
- Power liftgate .....71
- Power mirrors .....93
- Powerpoint .....153
- Power steering .....200  
fluid, checking and adding ....260  
fluid, refill capacity .....317  
fluid, specifications .....317
- Power Windows .....92
- Privacy information .....363
- Putting a call on/off hold .....370
- Q**
- Quick touch buttons .....461
- R**
- Radio .....331  
Single CD .....331
- Radio reception .....329
- Radio voice commands ....421, 427
- Rear heated seats .....140
- Rear seat entertainment  
system .....342
- Rear view camera display .....195
- Rear window defroster ....118, 120

- 
- Receiving a text message .....374
  - Recommendations for
    - attaching safety restraints for children .....24
  - Relays .....242–243
  - Remote entry system
    - illuminated entry .....70
    - locking/unlocking doors .....67
    - opening the trunk .....68
    - replacing the batteries .....57
  - Roadside assistance .....228
  - Roll stability control .....191
  - Roof rack .....202
  - S**
  - Safety Belt Maintenance .....45
  - Safety belts (see Safety restraints) .....38
  - Safety defects, reporting .....241
  - Safety information .....362
  - Safety restraints .....38–39, 41
    - Belt-Minder® .....42
    - extension assembly .....40
    - for adults .....38–39
    - for children .....24
    - safety belt maintenance .....45
    - seat belt maintenance .....45
    - warning light and chime .....42
  - Safety restraints - LATCH anchors .....27
  - Safety seats for children .....24
  - Safety Compliance Certification Label .....322
  - Satellite Radio .....431
  - Scheduled Maintenance Guide
    - Normal Scheduled Maintenance and Log .....483
  - SD card .....445
  - Seat belts (see Safety restraints) .....38
  - Seats
    - child safety seats .....24
    - climate control .....132
    - filter .....321
    - heated .....140
    - memory seat .....58, 129
  - SecuriCode keyless entry system .....75
  - SecuriLock passive anti-theft system .....77
  - Selecting your media source (USB, Line in, BT audio) .....394
  - Setting a destination .....445
  - Setting the clock .....331
  - Side air curtain .....52
  - Side-curtain airbags system .....52
  - SIRIUS® satellite radio ....428, 445
  - SIRIUS satellite radio voice commands .....430
  - SIRIUS Travel Link .....441
  - Snowplowing .....15
  - SOS Post Crash Alert .....48
  - Spark plugs, specifications .....316, 321
  - Special notice
    - ambulance conversions .....15
  - Specification chart, lubricants .....317
  - Stability system .....191

- 
- Starting a flex fuel vehicle .....160
- Starting your vehicle .....158, 160  
 jump starting .....231
- Status bars .....413
- Steering wheel .....81  
 controls .....82  
 tilting .....81
- Supplemental Restraint System  
 (SRS) (see airbags) .....49
- Suspension .....201
- SYNC® AppLink™ .....389
- SYNC® customer support .....362
- SYNC® Services .....386
- System overview .....410
- T**
- Temperature control  
 (see Climate control) .....118, 120
- Text messaging .....374
- Text messaging (sending,  
 downloading, deleting) ....374, 376
- Third-row power fold seat .....142
- Tilt steering wheel .....81
- Tires .....286–287, 307  
 alignment .....300  
 care .....286  
 changing .....307, 309  
 checking the pressure .....296  
 inflating .....294  
 label .....294  
 replacing .....298  
 rotating .....300  
 safety practices .....299  
 sidewall information .....289  
 snow tires and chains .....301  
 spare tire .....307  
 terminology .....288
- tire grades .....287
- treadwear .....287, 296
- Towing .....213, 223–224  
 recreational towing .....224  
 trailer towing .....213  
 wrecker .....223
- Traction control .....189
- Traffic, Directions and  
 Information .....386
- Trailer sway control .....214
- Transmission  
 brake-shift interlock (BSI) ....177  
 fluid, checking and adding  
 (automatic) .....260  
 fluid, refill capacities .....317  
 lubricant specifications .....317
- Troubleshooting .....357, 464
- Turn signal .....89
- U**
- Universal garage door opener ...143
- USB port .....341
- Using privacy mode .....370
- V**
- Vehicle health report .....384
- Vehicle Identification Number  
 (VIN) .....321
- Vehicle loading .....203
- Ventilating your vehicle .....161
- Voice commands in media  
 mode .....391
- Voice commands in phone  
 mode .....367
- Voice recognition .....415

**W**

Warning lights (see Lights) .....	101	Windows	
Washer fluid .....	261	power .....	92
Water, Driving through .....	226	rear wiper/washer .....	86
Where am I? .....	441	Windshield washer fluid and	
		wipers .....	85
		checking and adding fluid .....	261
		replacing wiper blades .....	264
		Wrecker towing .....	223