

Navigation System

SYNC

Powered by **Microsoft**

if equipped

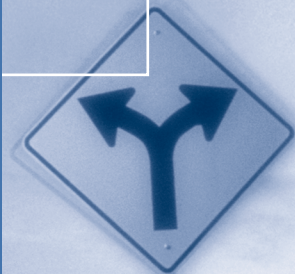
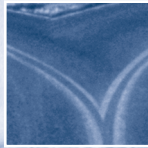
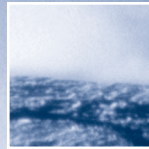
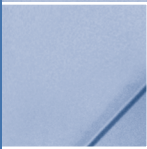
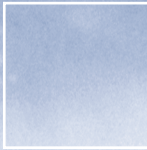
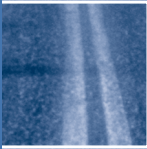

Table of Contents

| | |
|-----------------------------------|-----------|
| Introduction | 4 |
| How to get going | 5 |
| Navigation system overview | 10 |
| Audio features | 14 |
| AM/FM | 14 |
| Satellite radio (if equipped) | 16 |
| CD | 21 |
| Auxiliary input jack (Line in) | 23 |
| User Device (if equipped) | 23 |
| DVD (if equipped) | 23 |
| Sound features | 26 |
| Speed compensated volume | 28 |
| Rear seat controls (if equipped) | 28 |
| System features | 30 |
| Hybrid information (if equipped) | 30 |
| Date/time settings | 35 |
| Security | 38 |
| Help | 39 |
| MAP DVD - Loading and unloading | 41 |
| Cleaning map DVDs | 43 |
| Navigation features | 44 |
| Map icons | 47 |
| Destination entry | 49 |
| Previous destination | 51 |
| Address Book - destination entry | 53 |
| Point of Interest (POI) | 55 |
| Intersection | 60 |
| Freeway entrance/exit | 61 |
| Destination way points | 63 |
| Map preferences | 65 |
| Address Book - editing | 67 |
| Quick POIs | 69 |
| Avoid areas | 69 |
| Voice recognition | 71 |

Table of Contents

| | |
|---|-----------|
| Frequently asked questions | 83 |
| General Information | 86 |
| Navigation end user license agreement | 86 |
| Cleaning | 90 |
| Navigation glossary | 90 |
| SYNC (if equipped) | 91 |
| What is SYNC? | 91 |
| Safety information | 92 |
| Phone dependent features | 92 |
| SYNC voice recognition feature | 93 |
| Using voice commands with SYNC | 94 |
| Quick reference chart | 98 |
| SYNC phone features | 99 |
| Quickstart - How to get going | 99 |
| Pairing your phone through your navigation system | 99 |
| Making a call | 100 |
| SYNC phone features | 102 |
| Saving a contact or phone number as a Quick Dial | 103 |
| Using the quick dial feature | 103 |
| Replacing contacts in your Quick Dial locations | 104 |
| Accessing your phone book | 104 |
| Call history | 105 |
| System settings | 106 |
| Connecting a phone | 106 |
| Adding a phone | 107 |
| Deleting a phone | 107 |
| Advanced settings | 108 |
| Turning Bluetooth on/off | 109 |
| Setting a ring tone | 110 |
| Message notification | 111 |
| Automatically download your phone book | 111 |
| Modifying your phone book and call history | 112 |
| Turning prompts on/off | 114 |
| Returning to factory defaults | 115 |
| Performing a master reset | 116 |

Table of Contents

| | |
|--|------------|
| Installing new vehicle applications | 117 |
| Accessing SYNC system information | 117 |
| Text messaging with your navigation system | 118 |
| Forwarding a text message | 123 |
| Voice commands in phone mode | 124 |
| SYNC media features | 125 |
| How to get going with SYNC media | 125 |
| Connecting your digital media player to SYNC | 125 |
| SYNC media features | 126 |
| Using your USB port | 127 |
| Supported player, media formats and metadata information | 129 |
| What's playing? | 129 |
| Streaming music from your phone | 129 |
| Using the Auxiliary input jack (Line in) | 130 |
| Using the play all feature | 132 |
| Selecting and playing specific artists | 132 |
| Selecting and playing specific albums | 133 |
| Selecting different genres | 133 |
| Accessing your playlists | 134 |
| Playing a specific track | 134 |
| Exploring the USB device | 135 |
| Accessing BT devices | 136 |
| Adding a new device in discovery or discoverable mode | 137 |
| Voice commands in media mode | 138 |
| SYNC End user license agreement | 146 |
| Glossary | 153 |
| Index | 155 |

All rights reserved. Reproduction by any means, electronic or mechanical including photocopying, recording or by any information storage and retrieval system or translation in whole or part is not permitted without written authorization from Ford Motor Company. Ford may change the contents without notice and without incurring obligation.

Copyright © 2007 Ford Motor Company

Introduction

NAVIGATION SYSTEM

Your vehicle is equipped with a navigation system which allows you to listen to the radio, play CDs, and also navigate the vehicle using a navigation map DVD.



Your system has a large range of features, yet is easy to use. Guidance is shown on the display screen and is supplemented with voice prompts. The display screen provides full information for operating the system through the use of tabbed menus, text screens, and map displays. Screen selections are made by touching the desired selection on the touch screen.

Introduction

DRIVING RESTRICTIONS

In order to prevent the navigation system from distracting the driver, access to certain functions are restricted when the vehicle is traveling above 5 mph (8 km/h). (For example, only QUICK DEST (Destination) items are available for destination entry. Refer to *Destination Programming*). When the vehicle is in motion, the following functions are restricted:

- Scrolling of long lists
- Continuous scrolling of map
- Editing/Adding entries in the Address Book and Avoid Areas List
- DVD ROM Load and Eject

When the vehicle begins to move, and the Select Route Screen is shown, the highlighted route is automatically selected and guidance begins. When the vehicle speed is reduced to 5 mph (8 km/h) or less, system restrictions are lifted and you have full access to the system.

QUICK START



Driving while distracted can result in loss of vehicle control, accident and injury. Ford strongly recommends that drivers use extreme caution when using any device that may take their focus off the road. The drivers primary responsibility is the safe operation of their vehicle. Only use cell phones and other devices not essential to the driving task when it is safe to do so.

Introduction

TO PLAY A RADIO STATION

1. Ensure that the navigation system is on.
2. Press MEDIA.



3. Select AM, FM1 or FM2.

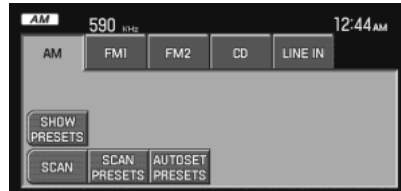

4. Press TUNE to adjust manually up (▲) or down (▼) the frequency band.



5. Press SEEK to find the next strong station up (▲) or down (▼) the frequency band.



TO PLAY SATELLITE RADIO (SR - IF EQUIPPED)

1. Ensure that the navigation system is on.
2. Press MEDIA.



3. If your vehicle is equipped with Satellite Radio, the SR tab will be present on the media screen. Select the SR tab to enter Satellite Radio mode (if equipped).



For further information on Satellite Radio, refer to *Satellite Radio* in the *Audio Features* chapter.

Introduction

TO PLAY A PREVIOUSLY LOADED CD:

1. Ensure that the navigation system is on.
2. Press MEDIA.



3. Select the CD tab or press MEDIA repeatedly until CD is highlighted. Press the corresponding memory preset (1–6) to select the desired CD. The previously loaded CD will begin to play. The system will begin playing the discs in order.



Note: If there are no CDs loaded into the system, NO DISC will display in the status bar and you will not be able to highlight or select the CD tab.

4. Press SEEK to advance to the next (▲) or previous (▼) tracks.



TO LOAD CDS:

1. Ensure that the navigation system is on.
2. Press LOAD.



3. When LOAD CD (#) appears on the status bar, select the desired slot by pressing the corresponding memory preset (1–6.)



4. Insert the disc. The CD will begin to play.

USING THE AUXILIARY INPUT JACK:

Your vehicle is equipped with an auxiliary input jack which allows a portable audio device to be listened to through your vehicle's audio system. To access the auxiliary input jack mode:

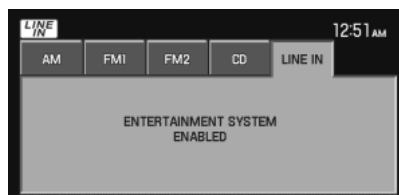

1. Press the MEDIA hard button.

Introduction

2. Select the LINE IN tab.

Once a 3.5 mm input jack is plugged into the Line In jack, sound from the device will be emitted through the vehicle speakers.

For information on the auxiliary input jack location, please refer to *Auxiliary input jack* in the *Entertainment* chapter in your *Owner's Guide*.

TO USE THE NAVIGATION SYSTEM:

1. Ensure that the vehicle ignition is on, and the navigation map DVD is loaded into the navigation map DVD player. If the navigation map DVD is not loaded, refer to *Loading and ejecting navigation map DVDs* in the *System Features* chapter for loading instructions.

2. Press DEST.



3. Select the desired type of destination entry: Quick Destination, Previous Destination, Address Book, POI, Address (shown), Map, Phone Number, Intersection or Freeway Entrance/Exit.



4. Enter the required information. Please note that:

- The system uses a Smart Speller, which facilitates entering information through the keyboard.
- Accented characters in English, Spanish and French will be converted internally to non-accented characters for search purposes.

5. The screen will show the point entered in a map. If this is the intended destination, press SET AS DESTINATION. COMPUTING ROUTE will display while the system is computing the route.

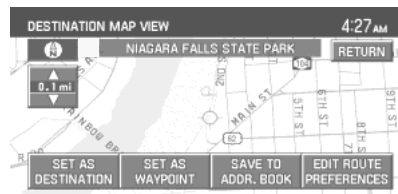

Introduction

6. Select the desired route on the right hand side of the screen. There will be up to three routes possible from which to choose, each highlighted with a different color. For each route, the overall distance, route conditions and the estimated travel time are displayed.



7. Press START ROUTE and follow the instructions.

VOICE RECOGNITION (IF EQUIPPED)

Your navigation system may be equipped with a voice activated feature that allows you to “speak” certain commands to the system. For further information, refer to *Voice recognition* in the *Navigation* chapter.

MENU TAB ARRANGEMENT

The ‘tabs’ that appear across the top of the screen will vary depending on your vehicle’s options. For example, the ‘SR’ tab will appear if your vehicle is equipped with Satellite Radio. The FM tab also varies; and will be represented as FM or FM1 and FM2 depending on your vehicle’s options.

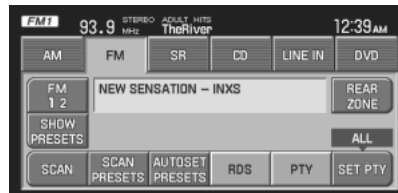

Navigation system overview

FORD AND MERCURY SYSTEM

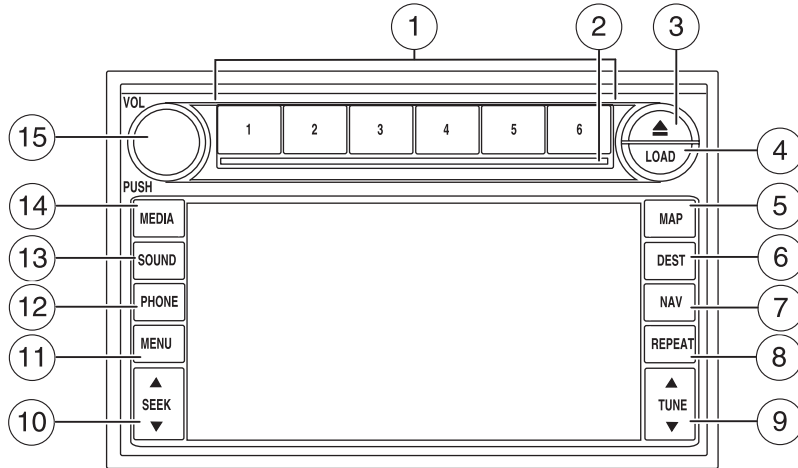

LINCOLN SYSTEM

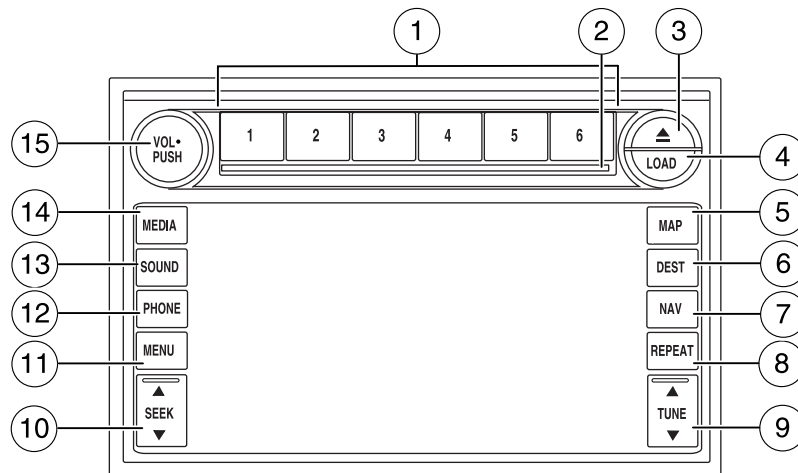

Navigation system overview

Refer to the System Overview graphics on the previous page.



1. **Memory presets:** To save a station (AM/FM1/FM2) in radio mode, tune to the selection. Press and hold the desired memory preset button (1–6). Press the memory preset buttons (1-6) to access your preset stations. In CD mode, press the memory preset buttons (1-6) to play the disc in the corresponding slot location.

2. **CD slot:** To load a CD: Press LOAD and a specific memory preset to load a CD to a specific slot. Once LOAD CD# appears in the display, the CD door will open. Insert the CD label side up.

3. **▲ (Eject):** Press the eject button to eject a single disc. Press and hold the button to eject all discs present in the system. To eject a specific disc, press the eject control and then press the corresponding memory preset button. If you do not select a specific disc, the system will automatically eject the disc that is currently playing.



4. **LOAD:** Press the load button to load a single disc. Press and hold the button to load discs in all empty slot locations.



5. **MAP:** Press to access the navigation map. Press while the map display is active to re-center the map on the current vehicle position. Press while the map display is active and a route is active to step through the different map guidance views.



6. **DEST (Destination):** Press to access the navigation destination entry menu. Press while in the navigation destination entry menu to show additional destination entry techniques.



7. **NAV (Navigation):** Press to access the navigation menu. Press while in the navigation menu to step through the navigation menu tabs.



Navigation system overview

8. **REPEAT:** Press the repeat button while navigation guidance is active to repeat the last spoken navigation guidance prompt.



9. **TUNE:** In radio mode, press ▲ TUNE ▼ to manually advance down or up the frequency band. In MP3 mode, press ▲ TUNE ▼ to advance to the previous/next folder.



Note: This feature requires a disc containing MP3 files organized in multiple folders.

10. **SEEK:** In radio mode, press SEEK ▲ / ▼ to seek to the next/previous available station. In CDX6 / DVD mode (if equipped), press SEEK ▲ / ▼ to advance to the next/previous track.



11. **MENU:** Press to access the system menu. Press while the system menu is active to step through the system menu tabs.



12. **PHONE:** Your vehicle may be equipped with SYNC, a hands-free communications and entertainment system with special phone and media features. For more information, please refer to the *SYNC phone features* chapter.



13. **SOUND:** Press to access the Sound menu. Press while in the sound menu to step through the sound menu tabs.



14. **MEDIA:** Press to access the media menu. Press while in the media menu to step through the media menu tabs consisting of various sources.



Navigation system overview

15. **On/Off/Volume:** Press to turn the audio system on/off. Press and hold to turn the navigation radio completely off. Turn to adjust the volume of the audio system or the navigation voice prompts as they are being given.

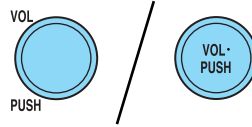

Note: If a route is active when the navigation radio is turned off, the route is resumed when the system is turned on again.

After the system initializes, the screen will be divided in two sections:

- **Status bar:** This is the top portion of screen that displays the clock or date and useful information, depending on current mode.
- **Display area:** The interactive screen that is activated by finger touch and changes depending on current system operation. Graphical buttons are displayed in this area depending on the current screen for the user to make choices.

Audio features

THX AUDIO SYSTEM — IF EQUIPPED (LINCOLN VEHICLES ONLY)

Your vehicle may be equipped with the THX® certified premium audio system. This system creates optimal acoustic quality for all seating positions and road conditions.

The system offers an advanced speaker system, amplifier, subwoofer and equalizer.



AM

1. Ensure that the navigation system is on.
2. Press MEDIA.
3. Select AM. Once in AM mode, you may select between SHOW OPTIONS and SHOW PRESETS.
4. Press SHOW OPTIONS to select from:



- **SCAN:** Press for a brief sampling of all listenable stations. Press again to disable and remain on the current selection.
- **SCAN PRESETS:** Press for a brief sampling of all the stations held in the memory presets.
- **AUTOSET PRESETS:** The autoselect feature allows you to set strong radio stations without losing your original preset stations. This feature is helpful on trips when traveling between cities with different radio stations.
To enable, select AUTOSET PRESETS and the six strongest stations in your current area will be set as presets. To return to your original presets, press AUTOSET PRESETS again and the feature will disable.

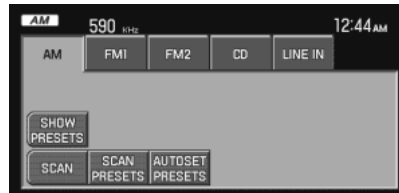

Audio features

5. Press SHOW PRESETS to view the preset stations. To set or change a preset station, press and hold any of the memory presets buttons (1–6) or any of the soft key memory preset buttons on the screen while on the desired station. The new station will replace the previous one recorded.



FM

1. Ensure that the navigation system is on.
2. Press MEDIA.
3. Select FM1 or FM2. Once in FM mode, you may select between SHOW OPTIONS and SHOW PRESETS.
4. Press SHOW OPTIONS to select from:

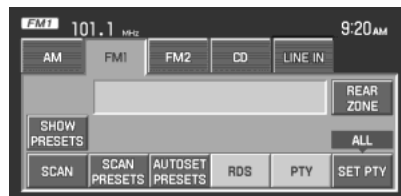

- **SCAN:** Press for a brief sampling of all listenable stations. Press again to disable and remain on the current selection.
- **SCAN PRESETS:** Press for a brief sampling of all the stations held in the memory presets.
- **AUTOSET PRESETS:** The autoselect feature allows you to set strong radio stations without losing your original preset stations. This feature is helpful on trips when traveling between cities with different radio stations. To enable, select AUTOSET PRESETS and the six strongest stations in your current area will be set as presets. To return to your original presets, press AUTOSET PRESETS again and the feature will disable.
- **RDS:** This feature allows the radio system to receive text information from RDS-equipped FM radio stations. In FM mode, press RDS to activate/deactivate. RDS must be activated in order to access PTY and SET PTY.

Audio features

- **PTY:** This feature allows the user to search for Radio Data System (RDS) stations selectively by their Program Type (PTY). To be able to select this feature, RDS must be enabled. PTY and station call letters will be displayed on the Status Bar.
- **SET PTY:** Press to select a program type, which, once selected, will be displayed above the SET PTY button. Once PTY has been programmed, press SEEK or SCAN to initiate a search up or down the frequency. The search will stop when the desired program type has been reached.

Note: The system will scan the frequency band three times for the chosen program type. If the program type is unavailable in your reception range, the system will return to the previous station.

5. Press SHOW PRESETS to view the preset stations. To set or change a preset station, press and hold any of the presets while on the desired station. The new station will replace the previous one recorded.



SATELLITE RADIO (IF EQUIPPED)

Your vehicle may be equipped with Satellite Radio capability. Vehicles that are equipped with a factory installed SIRIUS Satellite Radio system include a limited subscription term which begins on the date of sale/lease of the vehicle. Extended subscription terms are available, please contact SIRIUS at 1-888-539-7474.

You will need to give SIRIUS your Satellite Radio ESN Number for activation. The ESN number is found on the System Information Screen in the lower left corner (SR ESN:XXXXXXXXXXXX).

If the SYSTEM INFO screen is not available, press MENU to access the system information.

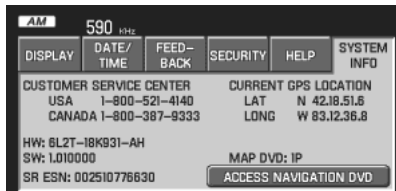

For further information on satellite subscription and service, refer to *Satellite radio information* later in this chapter.

Audio features

SATELLITE RADIO INTERACTION (IF EQUIPPED)

Once the Satellite Radio feature is activated, your navigation system will have additional features.

Press SR to enter Satellite Radio Mode.

- **SR123:** You will be able to access three different Satellite Radio bands, SR1, SR2 and SR3. You can save six presets on each band, for a total of 18 presets.



- **SCAN:** Press to hear a brief sampling of Satellite Radio channels. Press again to stop. When a scan is active, the system will only scan stations available in the selected genre setting.
- **SCAN PRESETS:** Press to hear a brief sampling of all preset stations.
- **TEXT:** Press once to display artist and title information. Press again to display album and genre information.
- **KEYPAD:** Press to display the numeric keypad (0–9). Use the keypad to manually enter a desired channel. Press ENTER to confirm the selection, or press BACK to delete the entered numbers.

- **SHOW PRESETS/SHOW OPTIONS:** Press to toggle between displays of the functional buttons or presets at the bottom of the screen.

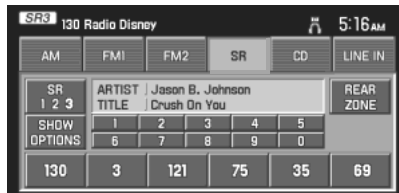

- **CHANNEL GUIDE:** Press to display the list of satellite radio channels. Press the SKIP button located next to the listed channel in order to block that station from being selected when tune, seek or scan searches are active.

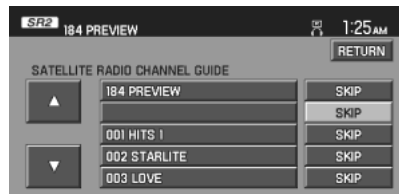

Note: You will not be able to scroll through the channel guide when the vehicle is in motion.

Audio features

- **GENRE:** Press to scroll through a variety of different format types.

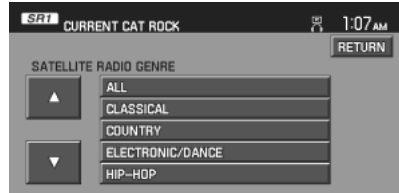

- **REAR ZONE:** Press to enable/disable the rear controls (if equipped), turn the headphones on/off and to select from different media sources.

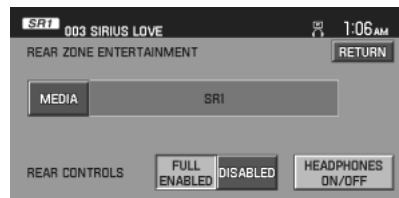

SATELLITE RADIO INFORMATION (IF EQUIPPED)

Satellite radio channels: SIRIUS broadcasts a variety of music, news, sports, weather, traffic and entertainment satellite radio channels. For more information and a complete list of SIRIUS satellite radio channels, visit www.sirius.com in the United States, www.sirius-canada.ca in Canada, or call SIRIUS at 1-888-539-7474.

Satellite radio reception factors: To receive the satellite signal, your vehicle has been equipped with a satellite radio antenna located on the roof of your vehicle. The vehicle roof provides the best location for an unobstructed, open view of the sky, a requirement of a satellite radio system. Like AM/FM, there are several factors that can affect satellite radio reception performance:

- **Antenna Obstructions:** For optimal reception performance, keep the antenna clear of snow and ice build-up and keep luggage and other material as far away from the antenna as possible.
- **Terrain:** Hills, mountains, tall buildings, bridges, tunnels, freeway overpasses, parking garages, dense tree foliage and thunderstorms can interfere with your reception.
- **Station overload:** When you pass a ground based broadcast repeating tower, a stronger signal may overtake a weaker one and result in an audio mute.

Unlike AM/FM audible static, you will hear an audio mute when there is a satellite radio signal interference. Your radio display may display NO SIGNAL to indicate the interference.

Audio features

SIRIUS satellite radio service: SIRIUS Satellite Radio is a subscription based satellite radio service that broadcasts music, sports, news and entertainment programming. A service fee is required in order to receive SIRIUS service. Vehicles that are equipped with a factory installed SIRIUS Satellite Radio system include:

- Hardware and limited subscription term, which begins on the date of sale or lease of the vehicle.
- Online media player providing access to all 65 SIRIUS music channels over the internet (U.S. customers only).

For information on extended subscription terms, contact SIRIUS at 1-888-539-7474.

Note: SIRIUS reserves the unrestricted right to change, rearrange, add or delete programming including canceling, moving or adding particular channels, and its prices, at any time, with or without notice to you. Ford Motor Company shall not be responsible for any such programming changes.

Satellite Radio Electronic Serial Number (ESN): This 12 digit Satellite Serial Number is needed to activate, modify or track your satellite radio account. You will need this number when communicating with SIRIUS. While in Satellite Radio mode, you can view this number by pressing the MENU hard button and then selecting SYSTEM INFO. The number will appear in the bottom left corner of the screen. For further information, please refer to *System information* in the *System features chapter* of this navigation supplement.

| Radio Display | Condition | Action Required |
|---------------|---|--|
| ACQUIRING | Radio requires more than two seconds to produce audio for the selected channel. | No action required. This message should disappear shortly. |
| SAT FAULT | Internal module or system failure present. | If this message does not clear within a short period of time, or with an ignition key cycle, your receiver may have a fault. See your authorized dealer for service. |

Audio features

| Radio Display | Condition | Action Required |
|---------------|--|---|
| INVALID CHNL | Channel no longer available. | This previously available channel is no longer available. Tune to another channel. If the channel was one of your presets, you may choose another channel for that preset button. |
| UNSUBSCRIBED | Subscription not available for this channel. | Contact SIRIUS at 1-888-539-7474 to subscribe to the channel, or tune to another channel. |
| NO TEXT | Artist information not available. | Artist information not available at this time on this channel. The system is working properly. |
| NO TEXT | Song title information not available. | Song title information not available at this time on this channel. The system is working properly. |
| NO TEXT | Category information not available. | Category information not available at this time on this channel. The system is working properly. |

Audio features

| Radio Display | Condition | Action Required |
|-------------------------------|--|--|
| NO SIGNAL | Loss of signal from the SIRIUS satellite or SIRIUS tower to the vehicle antenna. | You are in a location that is blocking the SIRIUS signal (i.e., tunnel, under an overpass, dense foliage, etc). The system is working properly. When you move into an open area, the signal should return. |
| UPDATING | Update of channel programming in progress. | No action required. The process may take up to three minutes. |
| CALL SIRIUS 1-888-539-7474 | Satellite service has been deactivated by SIRIUS Satellite Radio. | Call SIRIUS at 1-888-539-7474 to re-activate or resolve subscription issues. |

CD

To load a CD:

1. Press LOAD.



Note: CD units are designed to play commercially pressed 4.75 in (12 cm) audio compact discs only. Due to technical incompatibility, certain recordable and re-recordable compact discs may not function correctly when used in CD players. Irregular shaped CDs, CDs with a scratch protection film attached, and CDs with homemade paper (adhesive) labels should not be inserted into the CD player. The label may peel and cause the CD to become jammed. It is recommended that homemade CDs be identified with permanent felt tip marker rather than adhesive labels. Ballpoint pens may damage CDs. Please contact your authorized dealer for further information.

2. Select the desired slot by pressing the corresponding memory preset button (1-6).



Audio features

3. Insert the disc, label side up, when LOAD CD# appears in the status bar. The CD will begin to play.

The following functions are available in CD mode:



- **SEEK:** In CD or MP3 mode, press to listen to the next (▲) or previous (▼) track. In MP3 mode with FOLDER MODE selected, press SEEK to advance to the first track in the same folder.
- **TUNE:** In MP3 mode, press to advance to the next (▲) or previous (▼) folder.
- ◀◀ (Reverse): Press to step back through current track.
- ▶ / || (Play/Pause): Press to play or pause the current track.
- ▶▶ (Fast forward): Press to advance through the current track.
- **SCAN:** In CD mode, press to hear a brief sampling of all tracks on the current CD. In MP3 mode, press for a brief sampling of all tracks in all folders.
For an MP3 disc with multiple folders, pressing FOLDER MODE when running a scan will result in brief sampling of all songs in the current folder.
- **COMP** (Compression): Press to engage the compression feature. COMPRESSION boosts more quiet music and lowers louder music to minimize the need for volume adjustments. Press again to disengage.
- **REPEAT:** Press to repeat the current track. REPEAT will appear in the Status Bar when selected. Press again to disengage.
- **SHUFFLE:** Press to engage the shuffle feature. When playing MP3 files, if FOLDER MODE is engaged, the system will shuffle the songs within the current folder only; otherwise, it will shuffle all the tracks in the disc. Press again to disengage.
- **FOLDER MODE:** Press to play only the tracks in the current folder, when playing MP3 files arranged in separate folders.
- **TEXT:** When available, displays information from the CD.

Audio features

AUXILIARY INPUT JACK (LINE IN)

Your vehicle is equipped with an audio input jack which will allow a portable audio device to be listened to through your vehicle's audio system. To activate this feature and access the LINE IN screen:

1. Press the MEDIA hard button.
2. Select the 'Line In' tab.

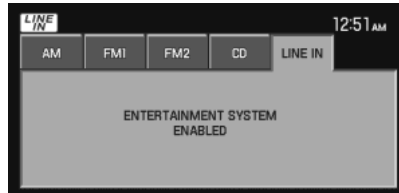

Once a 3.5 mm input jack is plugged into the Line in jack, ensure that the playing device is turned on with the volume set at the maximum level. Press the play button and sound from the device will be emitted through the vehicle speakers. Adjust the volume using the volume control on the navigation system.

For information on the auxiliary input jack location, please refer to the *Auxiliary input jack* in the *Entertainment* chapter of your *Owner's Guide*.

USER DEVICE

If your vehicle is equipped with SYNC, there will be a USER DEVICE tab in your media options. For more information, please refer to the *SYNC media features* chapter later in this supplement.



DVD (IF EQUIPPED)

Your vehicle may be equipped with a DVD player. The navigation system can provide you interaction with the DVD system in the rear of the vehicle. To access the DVD screen:

1. Ensure that the navigation system is ON.

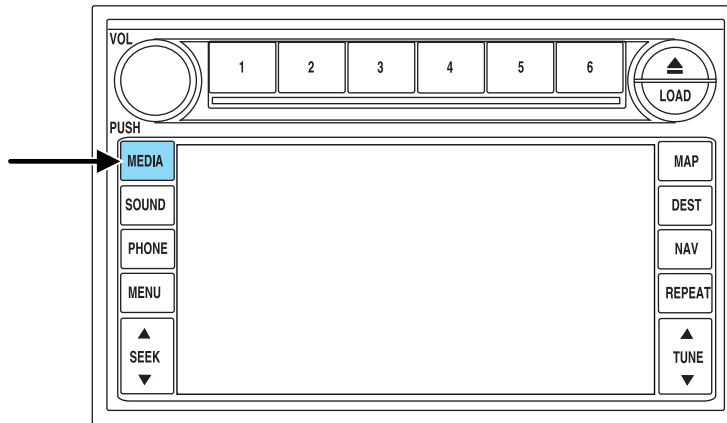

Audio features





2. Press MEDIA.

3. If your vehicle is equipped with a DVD player, DVD will appear as a tab selection in the media screen. The DVD screen will allow you to select from the following options:



-  (Reverse): Press for reverse play.
-  (Play/Pause): Press to play or pause the DVD.
-  (Fast forward): Press for advance play.
- **REAR AUX** : Press to access rear auxiliary mode. There is an external video/audio input for the rear seat passengers to connect to an external DVD player, video games, etc.
- **REAR ZONE**: Press to access the Rear Zone Entertainment Screen. This screen allows back seat passengers to select/listen to a different audio/video source than the front seat passengers. The only restriction being the front and back seat passengers cannot both listen to a different frequency band (AM/FM1/FM2).

SEEK: You may press SEEK on the bezel for the next () or previous () chapter.

24

Audio features

4. The screen will show you the selected playing media of the different headsets (A and B). To make adjustments, ensure that the correct headset (A or B) is highlighted. The appropriate controls will appear to allow you to make adjustments to your current playing media.



- **MEDIA:** Press to select the desired media in the selected headset (A or B).
- **FULL ENABLED:** When active, rear seat passengers can select any audio/video source for the A headset (B headset can only choose from DVD and DVD AUX). If the front seat passengers are listening to the radio, the rear seat passengers can also select to listen to the radio and will have control to change the radio station or Satellite Radio channel.
- **REAR ONLY:** When active, rear seat passengers can select any audio/video source for the A headset (B headset can only choose from DVD and DVD AUX). If the front seat passengers are listening to the radio, the rear seat passengers can also select to listen to the radio but will not have control to change the radio station or Satellite Radio channel.
- **DISABLED:** When active, all features for the rear seat passengers are disabled. REAR ZONE OFF will be displayed in front of the A and B buttons. The audio selection of the front seat will play through all speakers. At any time the rear seat passengers can turn on the Family Entertainment System (FES), if equipped, through the DVD player. At that point, the navigation system will automatically display REAR ZONE ENTERTAINMENT and enable the headsets. The primary selection for the front seat will change to DVD.
- **HEADPHONES ON/OFF:** Press to turn the headphones on/off.

Audio features

SOUND FEATURES

The sound menu allows you to access settings such as Bass, Treble, Fade, Balance, Digital Signal Processing (DSP) and Speed Compensated Volume (SCV).

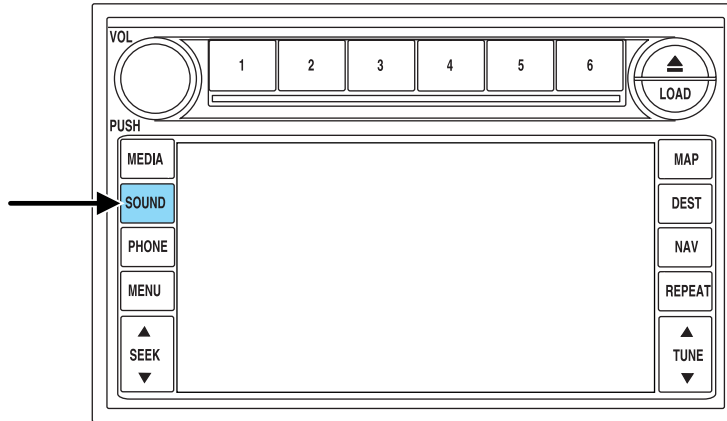

1. To access the sound features, press SOUND. The sound screen will appear.

2. Press the appropriate tab to select from:

BASS/TREBLE: Press + to increase or — to decrease the level of bass/treble.

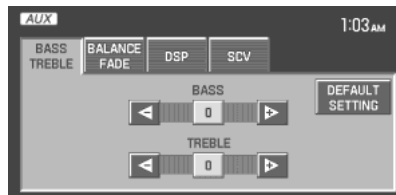

Audio features

BALANCE/FADE: Press ◀/▶ to adjust the sound between the left and right speakers (Balance) and ▲/▼ to adjust the sound to the front and rear speakers (Fade).

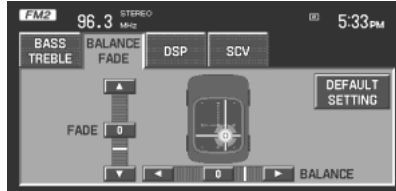

DSP (Digital Signal Processing): Press to optimize the sound quality for ALL SEATS, DRIVER, REAR or CONVERTIBLE (if equipped). If THX equipped, optimization is available for ALL SEATS, DRIVER or FRONT.

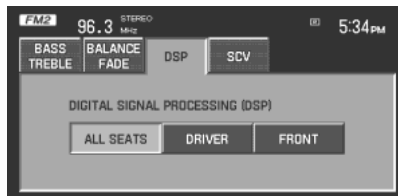

SCV (Speed Compensated Volume): Radio volume changes automatically with vehicle speed to compensate for road and wind noise. You may turn the feature on/off, and select a level of compensation between 1 and 7 by pressing the corresponding button.

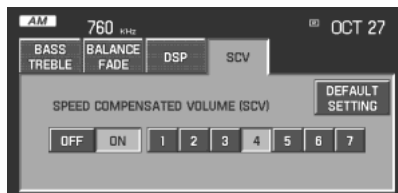

DEFAULT SETTING: Press to clear out any current settings and return the system to the default settings.

Note: Please refer to your *Owner's Guide* for further information.

Audio features

REAR SEAT CONTROLS (IF EQUIPPED)

If you have an **Expedition** or a **Navigator**, your vehicle is equipped with Rear Seat Controls. To access the Rear Zone screen through your Navigation system:

1. Ensure that the navigation system is ON.

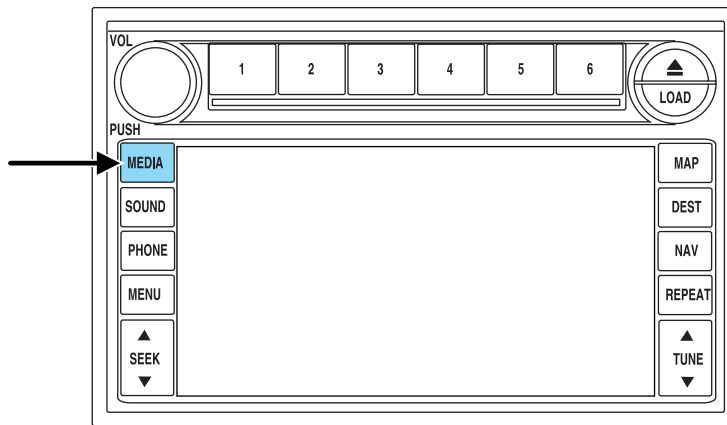

2. Press MEDIA.
3. Press REAR ZONE on the AM, FM, CD or SR media screens.

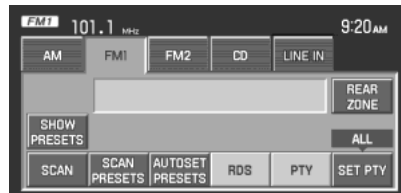

Audio features

4. The screen will show you the selected playing media. The appropriate controls will appear to allow you to make adjustments to your current playing media.



- **HEADPHONES ON/OFF:** Press to turn the headphones on/off.
- **REAR ZONE:** Press to turn the Rear Zone off.
- **MEDIA:** If the headphones are ON, press the media button to select between Radio and Rear AUX.
- **FULL ENABLED:** When active, rear seat passengers can select any audio/video source. If the front seat passengers are listening to the radio, the rear seat passengers can also select to listen to the radio and will have control to change the radio station or Satellite Radio channel.
- **REAR ONLY:** When active, rear seat passengers can select any audio/video source. If the front seat passengers are listening to the radio, the rear seat passengers can also select to listen to the radio but will not have control to change the radio station or Satellite Radio channel.
- **DISABLED:** When active, all features for the rear seat passengers are disabled. REAR ZONE OFF will be displayed. The audio selection of the front seat will play through all speakers. At any time the rear seat passengers can turn on the Family Entertainment System (FES), if equipped, through the DVD player. At that point, the navigation system will automatically display REAR ZONE ENTERTAINMENT and enable the headsets. The primary selection for the front seat will change to DVD.

For more information, please refer to *Rear seat controls* in the Entertainment Chapter of your *Owner's Guide*.

System features

HYBRID INFORMATION (IF EQUIPPED)

If you have a Hybrid vehicle, your navigation system has special Hybrid screens which relay Energy Flow and Fuel Economy information. To access these screens, press MENU and then select the HEV tab.

ENERGY FLOW SCREEN

The Energy flow screen shows a graphical representation of how power is transferred in the Hybrid system to accelerate the vehicle or recharge the battery, and also which mode is currently active. These screens are informational and do not require any input from you.

Note: Due to the screen updates and simplification of the graphics, the display may not show the actual vehicle status.

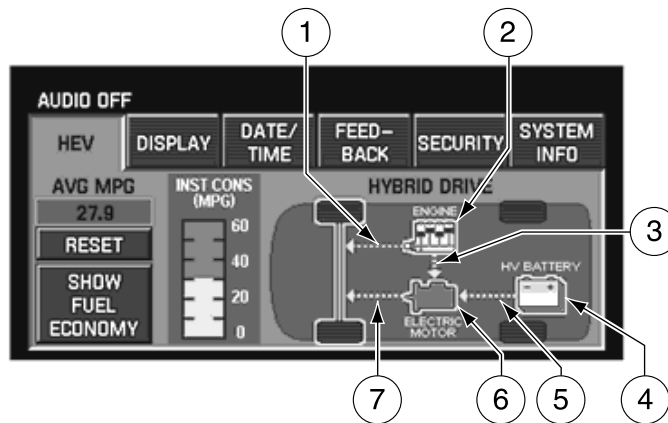

- 1. Engine Power:** This line represents how much power is being provided to the wheels by the engine. The arrow will always flow in one direction and point to the wheels.
- 2. Engine:** This icon represents the Internal Combustion Engine (ICE). It will be highlighted in orange only when the ICE is running.
- 3. Generator Power:** This line represents how much power is being generated by the engine for use by the High Voltage (HV) electric system, or how much power is being used by the High Voltage (HV) electric system to control/start the engine.
- 4. High Voltage (HV) Battery:** This icon represents your High Voltage Battery. The fill level (shown in green), represents the state of charge of your HV

30

System features

5. **Battery Power:** This line represents how much power the HV battery is providing to accelerate the vehicle (discharging), or how much power is being delivered back through the motor to the battery charging.

6. **Electric motor:** This icon represents the Hybrid Electric Motor. This symbol will be highlighted in orange after the vehicle has been started and will remain highlighted until key off to indicate that the vehicle is ready to be driven.

7. **Motor power:** This line represents the Hybrid Electric Motor. This symbol will be highlighted in orange after the vehicle has been started and will remain highlighted until key off to indicate that the vehicle is ready to be driven.

Note: The power arrows may point in different directions, indicating which way the power is flowing. The arrows may also vary in width to indicate the different levels of power being provided to that component.

The energy flow screens contain a title to indicate which mode is active within the Hybrid system.

In **Hybrid Drive** mode, the vehicle is being powered by both the electric motor and the engine.

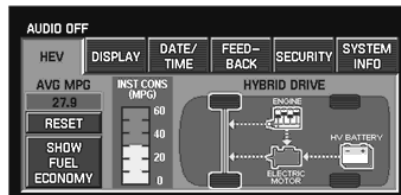

In **Charging HV Battery** mode, the vehicle is slowing down and power is being stored in the high voltage (HV) battery by the Hybrid system.

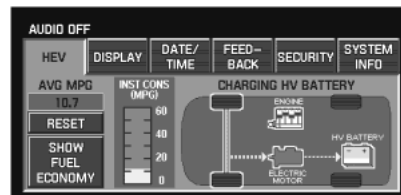

In **Idle with Charging** mode, the vehicle is in a state similar to idle, except that power is being generated to recharge the high voltage battery.



System features

In **Engine Drive** mode, the vehicle is being powered by the engine, not the electric motor. This occurs at higher speeds.

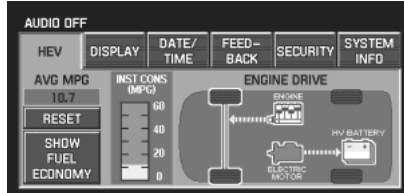

In **Idle** mode, the vehicle is either at rest, or is sharing very little power between the Hybrid parts. This can occur at higher speeds if the vehicle is not speeding up or slowing down.



In **Electric Drive** mode, the vehicle is driving in electric mode. The power is coming from the electric motor and not the engine.

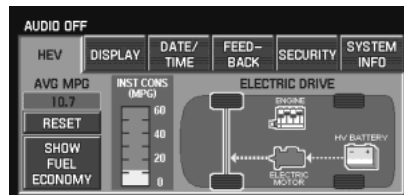

System features

FUEL ECONOMY SCREEN

The fuel economy screen displays instantaneous fuel consumption, overall average fuel economy and also a graph of fuel economy achieved in the last minute of driving. To view this screen, press SHOW FUEL ECONOMY on the HEV tab screen.

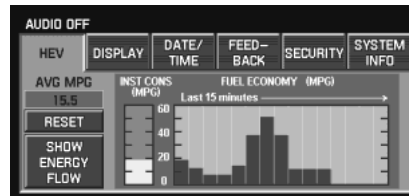

- **Instantaneous Fuel Consumption (Inst Cons):** This is displayed on the vertical bar on the left of the screen ranging from 0–60 mpg. Your vehicle must be moving to calculate instantaneous fuel consumption. When the vehicle is not moving, the Inst Cons function will display no bar on the Inst Cons graph indicating 0 mpg. Conversely, if you are driving in electric mode (Engine off), this function will display 60 mpg. Instantaneous Consumption cannot be reset.
- **Overall Average Fuel Economy (AVG MPG):** The AVG MPG is displayed on the upper left hand corner of the screen. The AVG MPG will be retained when the key is turned OFF and will continue averaging when driving resumes. Pressing RESET will reset the AVG MPG to zero.
- **One minute average graph:** The graph is updated each minute with the fuel economy that was achieved during the prior minute of driving. Each new one minute average will be added to the left side of the graph, shifting the past data to the right. When the graph area is full, the right most point will be deleted, keeping a running scroll from left to right of the last 15 minutes of driving. The graph is intended to provide a graphical representation of how driving habits/conditions can affect fuel economy. Note that the graph will be cleared anytime the key is turned out of RUN (however, the overall average fuel economy will retain its value). Press RESET to clear the graph.

If the Navigation system has been set to units of Kilometer, the Fuel Economy screen will display the equivalent Consumption Graph in units of L/1000 KM. In Consumption (L/1000 KM) mode, the IFE function will display MAX until the vehicle is moving. For more information on Average Fuel Economy, refer to *Message center* in the *Driver Controls* chapter in your *Owner's Guide*.

System features

DISPLAY

To access the display settings:

1. Ensure that the navigation system is ON.

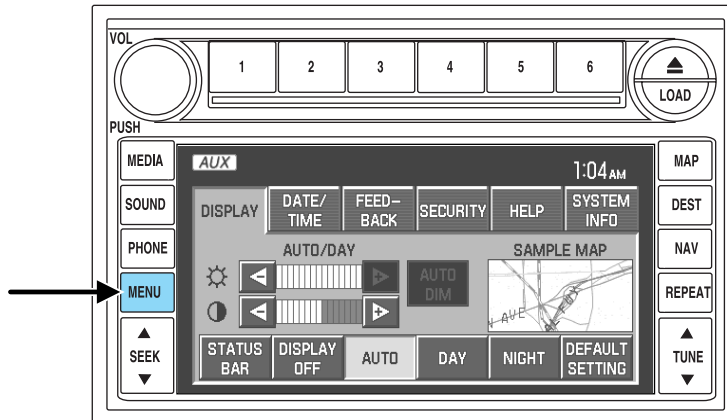

2. Press MENU. The Menu screen will display.
3. Press DISPLAY. You may then select from the following options:
 - **AUTO DIM:** Select to automatically dim the display brightness with the vehicle backlighting (when headlights are turned on). Otherwise, display brightness can be manually adjusted.
 - **STATUS BAR:** Press to display only the Status Bar until the screen is touched again. Refer to *Status Bar Description* in Basic Operation.
 - **DISPLAY OFF:** Press to turn off the entire screen. Press the screen or any hard button to turn the display on again.
 - **AUTO:** Press to set the display to automatic mode. When headlights are turned on, the system will automatically switch to the night display screen. To adjust brightness or contrast, press + or — .
 - **DAY:** Press to select the day screen. To adjust brightness or contrast, press + or — .
 - **NIGHT:** Press to select the night screen display. To adjust brightness or contrast, press + or — .
 - **DEFAULT SETTING:** Press to clear any current settings and return to the system default.

System features

- **SAMPLE MAP:** Shows you how the map will appear with the current settings

DATE/TIME

To access the date/time settings:

1. Ensure that the navigation system is ON.

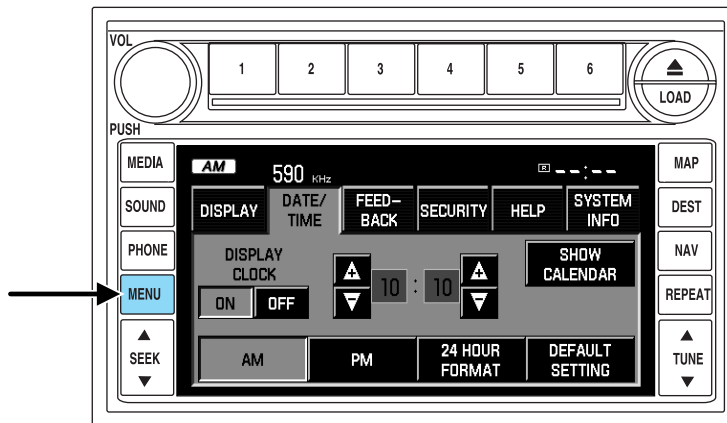

2. Press MENU. The Menu screen will display.
3. Press DATE / TIME. You may then select from the following options:
SHOW CLOCK / SHOW CALENDAR: Press to toggle between CLOCK and CALENDAR screens. Under the CLOCK screen, the following buttons will be available:
 - **CLOCK ON/OFF :** Press ON to enable the clock display in the status bar. Press OFF to disable the clock display in the status bar.
 - **TIME SET BUTTONS:** Press + or - to adjust the hours and minutes.
 - **24 HOUR FFORMAT:** If enabled, the system will display military time. If disabled, the user must select AM or PM.
 - **DEFAULT SETTING:** Press to clear current settings and return to system default settings.

System features

- **SHOW CALENDAR:** Press to display the calendar screen.

The calendar screen will display the current month. Press PREV to view the previous month or NEXT to view the next month. Under the CALENDAR screen, the following buttons are available:



- **GO TO TODAY:** Press to highlight the current date.
- **SHOW CLOCK:** Press to return to the clock screen.

FEEDBACK

To access the feedback screen:

1. Ensure that the navigation system is ON.

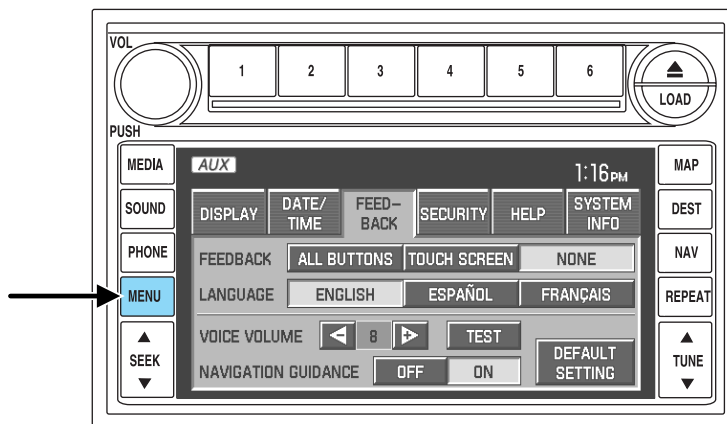

2. Press MENU. The Menu screen will display.
3. Press FEEDBACK. The feedback screen will appear. In this screen you have the following options:

FEEDBACK: One must be selected at all times:

- **ALL BUTTONS:** Press to hear an audible beep every time any button on the system is pressed.

System features

- **TOUCH SCREEN:** Press to hear an audible beep when any touch screen button is pressed.
- **NONE:** Press to turn off all audible beeps. You may press any button and no beeps will be heard.

LANGUAGE: One must be selected at all times:

- **ENGLISH:** Press to set the system language to English.
- **ESPAÑOL:** Press to set the system language to North American Spanish.
- **FRANCAIS:** Press to set the system language to North American French.

Note: The system will automatically restart after a new language is chosen.

VOICE VOLUME: Press +/- to select voice prompt volume level (1–34). You may also turn the volume control during a voice prompt to adjust the volume level.

TEST: Press to hear an audio sample of voice prompt at the currently selected volume.

NAVIGATION GUIDANCE: Press ON to hear navigation guidance voice prompts. Press OFF to turn the voice prompts off.

DEFAULT SETTING: Press to clear any current settings and return to the system default settings.

System features

SECURITY

Your navigation system has a special security feature which allows you to enable the valet mode. In valet mode, if your vehicle is being parked by a valet, they will be unable to access any of the navigational information (addresses, destinations, etc.), change any settings or eject any CDs or the navigation DVD. To access and enable valet mode:

1. Ensure that the navigation system is on.

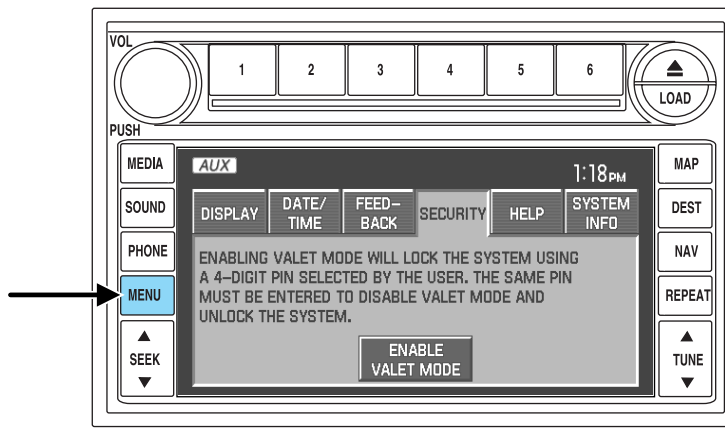

2. Press MENU.
3. Press SECURITY.
4. Press ENABLE VALET MODE to lock the system using any 4-digit PIN (Personal Identification Number). When valet mode is activated, the system will be completely locked. The PIN must be entered in order to disable Valet Mode and unlock the system. You can select a different PIN every time the system needs to be locked. If the PIN is forgotten, you can disable Valet Mode by disconnecting the battery or removing the appropriate fuse for one minute to reset the system.

System features

HELP

Your system has a special help feature. To access the help feature:

1. Ensure that the system is on.

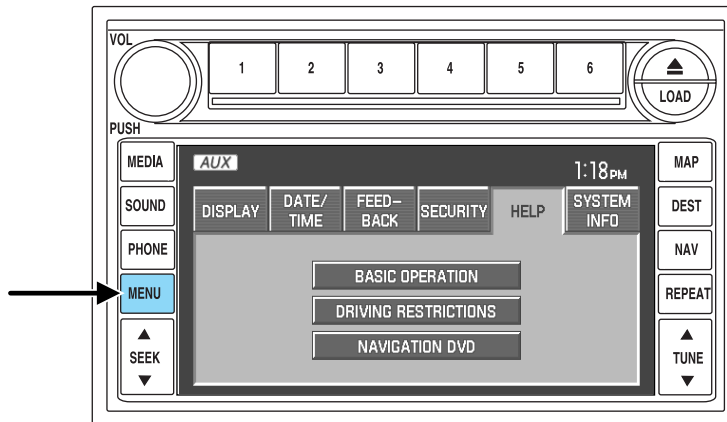

2. Press MENU.
3. Press HELP. You may then select from:
 - **BASIC OPERATION:** This screen will provide basic help with the hard buttons on the system, providing a brief description for each button.
 - **DRIVING RESTRICTIONS:** This screen will inform you that due to driver distraction and safety concerns, certain features will be restricted when the vehicle is in motion.
 - **NAVIGATION DVD INFORMATION:** Press to access information on the navigation map DVD — basic operation , how to access the DVD, and also replacement and contact information for the Customer Relationship Center.

System features

SYSTEM INFORMATION

The system information screen gives you contact information, current location and access to the Navigation DVD. To access the System Information screen:

1. Ensure that the system is on.

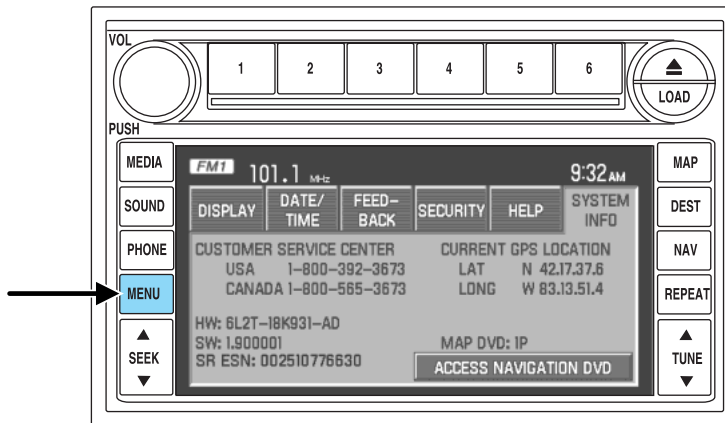

2. Press MENU.
3. Press SYSTEM INFO to view the following information:
 - Customer Relationship Center (shown as "Customer Service Center") phone numbers in USA and Canada
 - Current GPS Location
 - Map DVD Release Version
 - ACCESS NAVIGATION DVD: Press to access the Navigation Map DVD from this screen.
 - Satellite Radio Electronic Serial Number (ESN#)

System features

LOADING AND EJECTING NAVIGATION MAP DVDS

1. Ensure that the system is on.

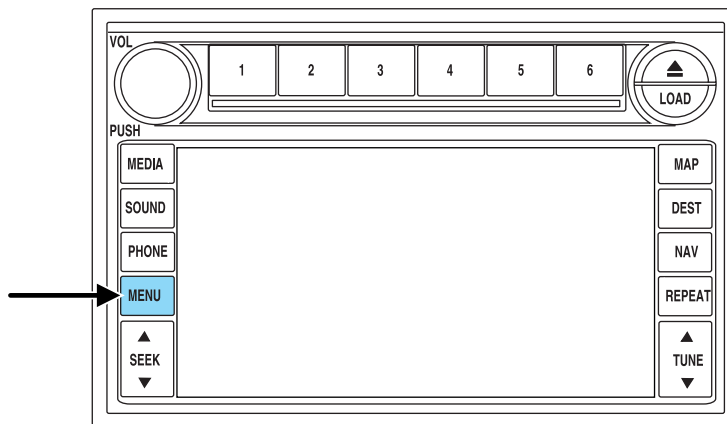

2. Press MENU.
3. Press SYSTEM INFO.
4. Press ACCESS NAVIGATION DVD. The following disclaimer will appear:

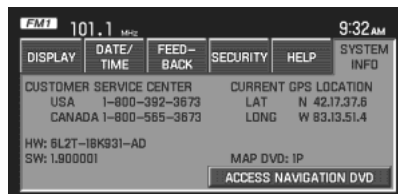

“To access the navigation DVD, select the OPEN button. This will cause the display to open. If the navigation DVD is installed, it will be ejected automatically. The screen will close automatically when a disc is inserted, or if no activity is detected for 5 minutes.”

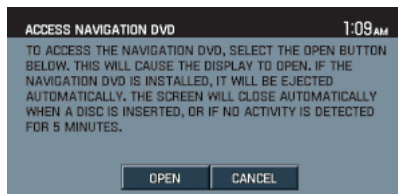

System features

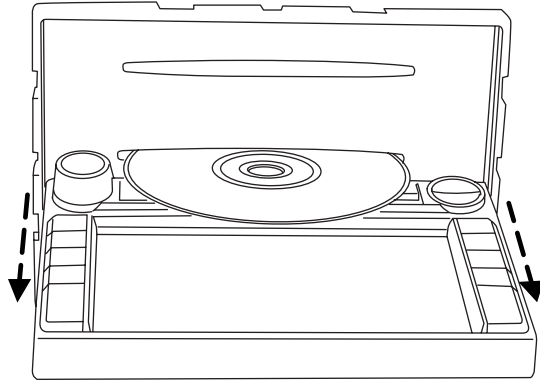

5. Press OPEN. The navigation screen will fold down, allowing you to access the navigation DVD slot. Insert the DVD with the printed side up into the lowest slot. If you do not wish to change the DVD, simply reinsert the DVD and the system will close automatically. Do not allow moisture or foreign objects to enter the slot. The system then will check the disc inserted. If valid, it will install the software and restart the system.

If you do not wish to access the DVD, press CANCEL.

LATEST MAP DVDS

The map content is constantly changing due to new roads, traffic, restrictions, etc. Therefore, it is not always possible to exactly match the DVD map with the current roadways. For best results, always use the latest version of the map DVD. Map information is regularly updated, but all areas are not necessarily covered to the same level of detail. Some areas, in particular private roads, may not be included on the MAP DVD. To help with accuracy, always use the latest DVD version for navigation. Updates to the database will have no effect on the contents of the address book and other user settings. Loading an older version of the map DVD may result in data loss.

System features

CLEANING MAP DVDS

Note: Ensure that you handle the high density digital map DVD with care and by the edges only. Fingerprints, smudges and scratches on the disc can affect Navigation System performance.

1. Ensure that you use a soft, non-abrasive, lint-free cloth.
2. DO NOT clean the disc in a circular motion as this may harm the pits on the surface of the disc.
3. In order to minimize any scratching, wipe the disc with the cloth from the inner hub to the outside of the disc.
4. DO NOT use any type of liquid cleaning solutions on the discs.

ORDERING ADDITIONAL MAP DVDS

If you wish to order a replacement map, an additional map, or an updated DVD, in the United States, please contact:

- Ford Customer Relationship Center at 1 (800) 392-3673 (FORD)
- Lincoln Mercury Customer Service Center at 1 (800) 521-4140

In Canada, please contact:

- Ford Customer Relationship Centre at 1 (800) 565-3673 (FORD)
- Lincoln Customer Service Centre at 1 (800) 387-9333

Navigation features

DISCLAIMER

After each ignition cycle, a disclaimer display will appear. Press AGREE to the content of the screen in order to access the navigation functions. If you do not press AGREE, you will only have access to non-navigation functions.

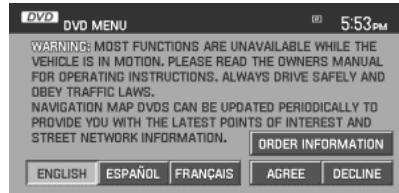

MAP MODE

To enter map mode:

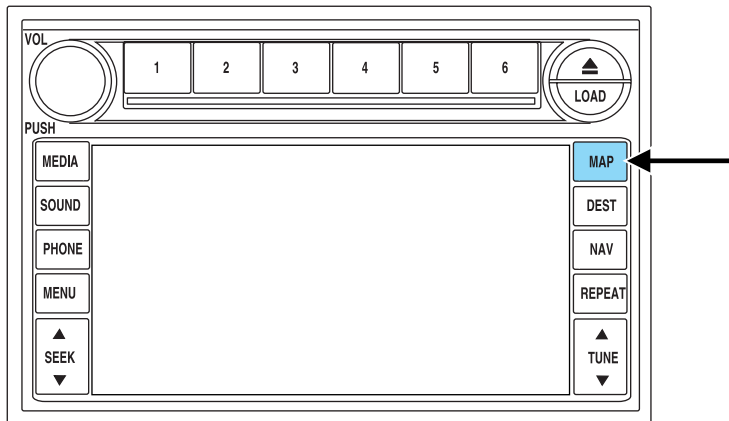

1. Ensure that the system is on.



2. Press MAP. The map screen will display.

Navigation features

When in MAP mode, an icon appears on the upper left side of the screen; this is a toggle button to change the view of the map displayed. The following methods exist for orientation of the map:

- **Heading up:** In this mode, the direction of forward travel is always upward direction on screen. Available for map scales up to 2.5 mi/5km. For scales above that, the setting for Heading-Up is remembered, but the map is shown in North-Up only. If the scale returns below this level, then the Heading-Up setting is restored. 
- **North up:** In this mode, the Northern Direction is always upward direction on screen. 

MAP SCALE

The map display scale on the map has 16 levels, ranging from 0.02 miles to 1000 miles. In MAP mode, you can also zoom in or out, changing the display scale by

pressing on one of the arrows on the button appearing on the left side of the screen. When in Full Screen Map Mode, touching this button will cause the Zoom Direct buttons to appear. The Zoom Direct buttons represent the most common scales and can be pressed directly to show the map at the desired scale. 

Map road colors and building representation on the map:

- **Roads:** Will be displayed in a variety of colors. Specifically, pink roads are not able to be used as routes. Also, purple roads indicate roads under construction currently or at the time of disc compilation. These roads will be open in the future.
- **Building footprints:** Will display areas of major buildings in the 20 largest cities in the U.S. These areas will be displayed depending on their size and the map zoom level.

Navigation features

QUICK TOUCH BUTTONS

When in Map mode, you have the ability to view six quick touch buttons. In order to view these, press and release anywhere on the map display. The map position will not change and they will appear on the map. These buttons are:

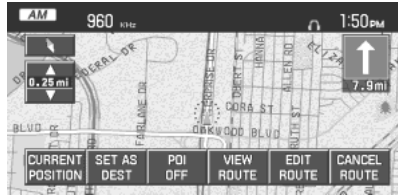

- **TIME TO DESTINATION:** Displays the distance and estimated travel time to the selected destination on the left side of the screen. When selected, a popup screen will also display the Estimated Time of Arrival (ETA).
- **CURRENT POSITION:** Press to show the vehicle's current location (street and State/Province).
- **SET AS DEST:** Press in order to select a scrolled location on the map as your destination. (You may scroll the map by pressing your index finger on the map display. When you reach the desired location, simply let go and then press SET AS DEST to go to the Destination Map View Screen.
- **POI/POI OFF:** Allows you to select from various Point of Interest (POI) icons as well as turn them on/off in the map display. Only one kind of POI will display on the map at a time (i.e., restaurants, banks, etc). The selected PIO icon will show on the button.

Note: This is only possible for scales equal or smaller than 0.75 mi /1 km.

If a navigational route is in progress, the following buttons will also appear at the bottom of the screen when a route exists:

- **VIEW ROUTE:** Press to adjust the map display to the right scale. This scale allows the entire route to be visible in the screen. This screen will also display the following options:

VIEW DEST: Press to shift the destination to the center of the map display.

TURN LIST: Press to view a list of the roads and waypoints for the planned route. You can change the route by selecting to AVOID any of the roads or to DELETE any of the waypoints. At this point the system will refigure the planned route based on the criteria.

Navigation features

- **EDIT ROUTE:** Press in order to adjust the following features of the current route:

DETOUR: Press to select a portion of the route for the navigation system to avoid. Select the desired distance (between one and 100 miles) of the current road. A map for each alternative route will display on the screen. Select the desired route.

EDIT TURN LIST: Press to display the TURN LIST screen and make any desired adjustments. Refer to *Turn list*.

EDIT ROUTE PREFERENCES: Press in order to change settings for route searches. Refer to *Route preferences*.

EDIT DESTINATION/WAYPOINTS: Press in order to add, delete or adjust any waypoints or your destination. Refer to *Destination/Waypoints list*.

- **CANCEL ROUTE:** Press to delete the next waypoint or the whole current route. The route cannot be deleted while a reroute is in progress.

Note: Once deleted, you will not be able to restore the waypoint or route.

MAP SCROLLING

Single scroll: In single scroll mode, press and release on the map display will bring the pressed position to the center of the screen. The scroll mode will time out after five minutes of inactivity.







Continuous scroll: During scroll mode, press and hold to begin scrolling continuously in one of eight directions closest to the point that is pressed. The scroll will continue until the map is released, and will increase in speed after three seconds. This is not possible if the vehicle is moving. The scroll mode will time out after five minutes of inactivity.

MAP ICON DESCRIPTIONS

- **Vehicle mark:** This icon is shown in scroll mode also. The ring around the vehicle mark will flash. The vehicle mark is shown in the center of the map display, except when in scroll mode.



Navigation features

- **Scroll cursor:** This icon is fixed in the center of the screen. The map position closest to the cursor is in a window on the top center part of the screen.

- **Address book entry default icon:** This icon indicates the location on the map of an address book entry. This is the default symbol shown after the entry has been stored to the Address Book by any method other than the map. A different icon can be selected from the 12 icons available; each icon can be used more than once. Refer to *Address book*.

- **Home:** This icon indicates the location on the map currently stored as the home position. Only one entry from the Address Book can be saved as Home. This icon cannot be changed.

- **POI (Point Of Interest) icon:** Icons such as this can be displayed on the map and can be turned on or off. There are about 56 subcategories of POIs that can be selected to be displayed on the map one at a time.

- **Waypoints:** This icon indicates the location of a waypoint on the map. The number inside the circle is different for each waypoint and represents the position of the waypoint in the route list.

- **Destination symbol:** This icon indicates the location of the final destination on the map.

- **Next maneuver point:** This icon shows the location where the next turn should occur on the planned route. You may be able to see up to the next three turns.

Navigation features

- **No GPS symbol:** This icon indicates that insufficient GPS satellite signals are being received for accurate map positioning. The symbol may be intermittently displayed under normal operation in an area with poor GPS access. Refer to *Limited GPS reception* in General Information.



DESTINATION PROGRAMMING

Press DEST to set a destination.

There are nine ways to program a destination. Most of these will be restricted when the vehicle is in motion. One tab for each method will appear on the screen when DEST is pressed. An additional tab with the symbol → or ← will be displayed for additional methods. When entering a destination, the system uses a Smart Speller, which facilitates entering information through the keyboard.

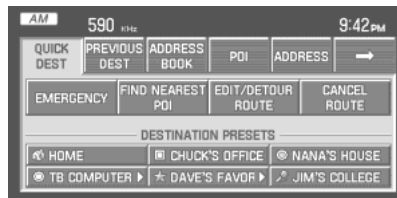

Note: The system will not calculate a route to a destination that is located on the same block as the vehicle's current location.

QUICK DESTINATION

Press the Quick Destination tab to view the possible destination choices when the vehicle is in motion.

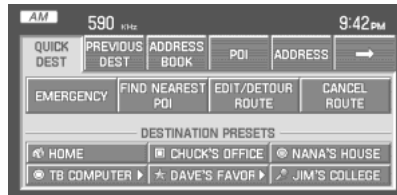

- **EMERGENCY:** There are two categories of Hospital and Police that can be selected under the Emergency category. They can be searched for in order of their distance from the vehicle's current location. The maximum length for the search result will be 25 items.



Navigation features

- **FIND NEAREST POI:** You can select five POI categories at a time. Of these five possible, you can search for one at a time in the vicinity of the vehicle position. The defaults for these five categories are shown in the graphic, and can be changed.



Refer to *Quick POIs*.

The search criteria for Find Nearest POI searches varies by specific category and current road type. The search distance range is 10–80 mi (16–128 km).

Once one of these categories is selected, a list of matches will be shown in order of distance from the current location.

LIST ALL CATEGORIES: When selected, a list of categories will be shown. When one is selected, a list of subcategories will appear. After selecting a subcategory, a search will show a list with name and distance to each POI from the vehicle position. Once a location is selected, the system will display the Destination map screen for confirmation.

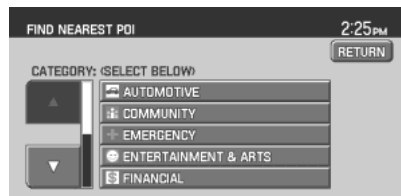

- **DESTINATION PRESETS:** Displays the home location and five entries selected from the Address Book. The icon and the name associated with the location will appear. Refer to *Address Book*.

When a route has been initiated, the following buttons become available under the QUICK DEST tab:

- **EDIT/DETOUR ROUTE:** Gives you the following options to change features of the current route:

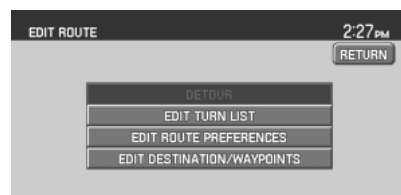

DETOUR: Press to select a portion of the route for the navigation system to avoid. Select the desired distance (between one and 100 miles) of the detour. A map for each alternative route will display on the screen. Select the desired route.

Navigation features

EDIT TURN LIST: Press to display the TURN LIST screen and make any desired adjustments. Refer to *Turn list*.

EDIT ROUTE PREFERENCES: Press in order to change settings for route searches. Refer to *Route preferences*.

EDIT DESTINATION/WAYPOINTS: Press in order to add, delete or adjust any waypoints or your destination. Refer to *Destination/Waypoints list*.

- **CANCEL ROUTE:** Press to delete the next waypoint or the whole current route. The route can be deleted while a reroute is in progress.

PREVIOUS DESTINATION

Your navigation system will allow you to select from a list of the 20 most recent destinations and waypoints. Once the list is full, any newly added items overwrite the oldest ones on the list. To access your previous destinations/waypoints:

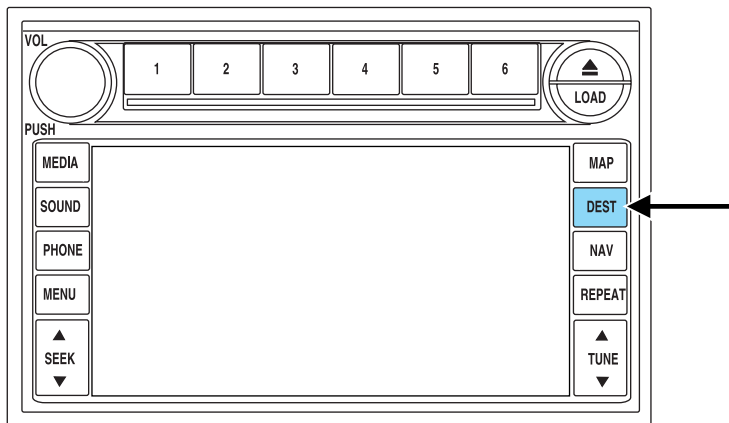

1. Press DEST.

Navigation features

2. Select PREVIOUS DESTINATION.

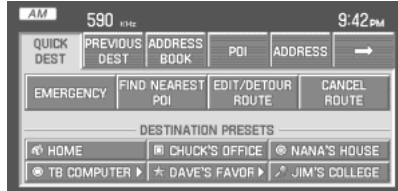

3. You may now scroll through the list of previous destinations using the ▲ /▼ soft keys. Once you have made your destination selection, you can now choose from:

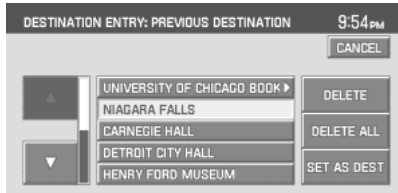

- **SET AS DEST:** Press for the Destination Map screen to appear. You can then decide if you would like to set the desired selection as a waypoint or final destination.
- **DELETE:** Press to delete the desired selection.
- **DELETE ALL:** Press to delete all entries.

Navigation features

ADDRESS BOOK — DESTINATION ENTRY

The address book feature of your system allows you to view a list of address book entries previously saved. To access:

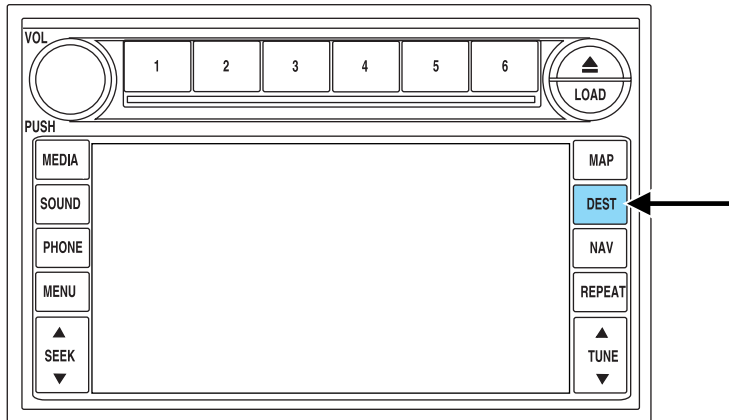

1. Press DEST.
2. Select ADDRESS BOOK.

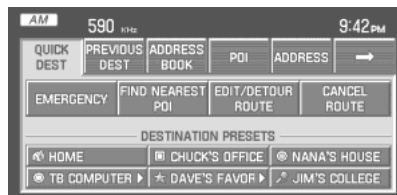

Navigation features

3. You may now choose to sort the list of entries by:

- **A – Z:** Select to view list in alphabetical order
- **DATE:** Select to view list in order of the entry date.
- **ICON:** Select to sort on the icon type.
- **INFO:** When the vehicle is stationary, you may select this in order to view the following information about the current address book entry:

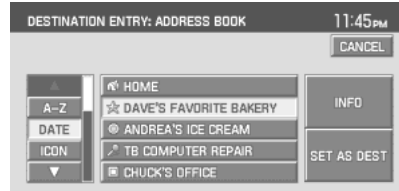

NAME

LOCATION

POINT OF INTEREST (POI) PHONE NUMBER

ICON

QUICK DEST / DESTINATION PRESET NUMBER

- **SET AS DEST:** Press to set the current address book entry as your destination. The Destination Map screen will then appear. Refer to *Destination map* for further information.

Note: If the battery is disconnected, the address book information will be saved but the previous destinations will be deleted.

To edit address book entries, press the NAV hard control and select the 'Address Book' tab. For a complete description, refer to *Address book — editing* later in this section.

Navigation features

POINT OF INTEREST (POI)

To access Points of Interest:

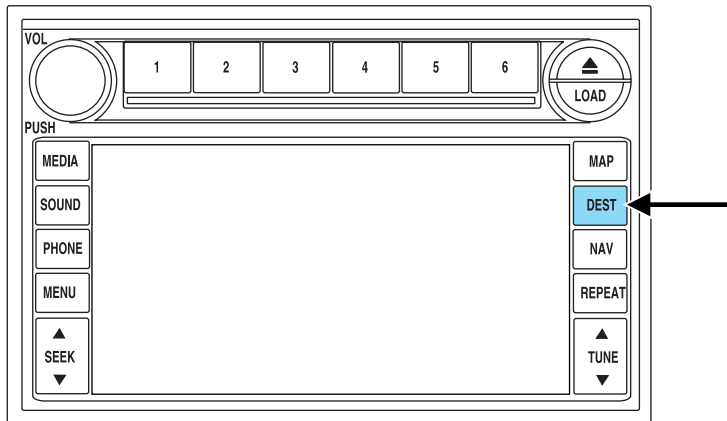

1. Press DEST.
2. Select POINT OF INTEREST (POI).



Navigation features

3. POI listings can be sorted alphabetically or in the order of the distance from the vehicle position. Detailed information on POIs (Name, City name, Street name, House number, Telephone number) can also be displayed.

DESTINATION ENTRY: POINT OF INTEREST (POI) 1:27 PM

| | | | | | | | | | | |
|------------|-----------|------|------|--------|---|---|---|-------|------|--------|
| STATE/PROV | MI | CITY | 2046 | CANCEL | | | | | | |
| CATEGORY | | | | | | | | | | |
| NAME | **** LIST | | | | | | | | | |
| A | B | C | D | E | F | G | H | I | J | 0-9 |
| K | L | M | N | O | P | Q | R | S | T | SYMBOL |
| U | V | W | X | Y | Z | & | - | SPACE | BACK | |

- **STATE/PROV:** Press to set the State, Province or Territory using the keyboard or select from List. The preset value for this field is based on current position (Auto Fill On) or previous selection (Auto Fill Off), depending on the settings.
USA: Select any state (except Alaska), including Puerto Rico and the District of Columbia.
CANADA: Select any province or territory.
- **CITY:** Input city name for desired location.
- **CATEGORY:** POIs can be searched by category and sub-category.
- **NAME:** When searching for a POI by name, the search can be done for a full or partial match.
- **LIST:** State/Provinces/Territories, Cities, and Names can be selected from a list determined by the Smart Speller.

Navigation features

ADDRESS

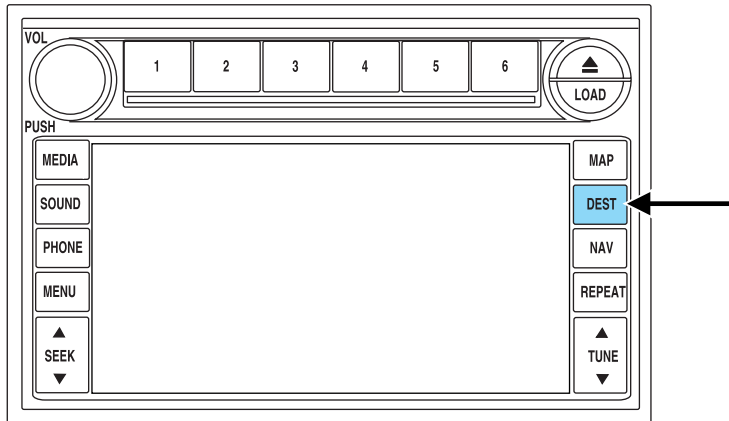

1. Press DEST.
2. Select ADDRESS.



Navigation features

3. Enter the following information:

- **STATE/PROV:** Press to set the State, Province or Territory using the keyboard or select from List. The preset value for this field is based on current position (Auto Fill On) or previous selection (Auto Fill Off), depending on the settings.



USA: Select any state (except Alaska), including Puerto Rico and the District of Columbia.

CANADA: Select any province or territory.

- **CITY:** Input city name for desired location.
- **STREET:** Streets which include numbers in their name can be searched if the name is input using digits or a spelling of the number. This applies to street names containing whole numbers from 1 (one) to 20 (twenty) or 1st (first) to 20th (twentieth) only.
- **NUMBER:** After the street has been input, the Smart Speller will allow the user to enter a house number in the range of the area specified.
- **LIST:** State/Province, City, Street can be selected from a list determined by the Smart Speller.

Navigation features

POI PHONE NUMBER

The system will allow you to search for an address book entry or POI using the phone number.

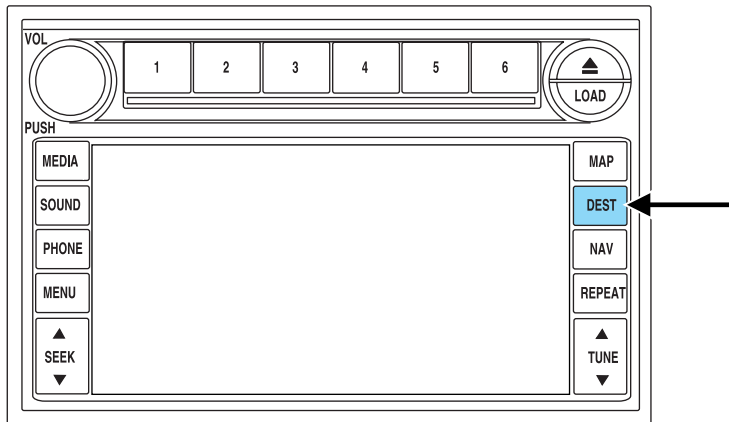

1. Press DEST.
2. Select PHONE NUMBER.



3. Use the key pad to enter the desired phone number. Press ENTER. A list of possible matches will appear. Select the correct one. You can then set that location as your destination. If the phone number matches one of the saved destinations, the destination map will appear showing the location.

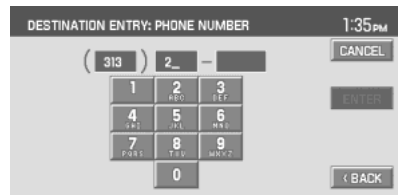

Navigation features

INTERSECTION

To set an intersection as a destination:

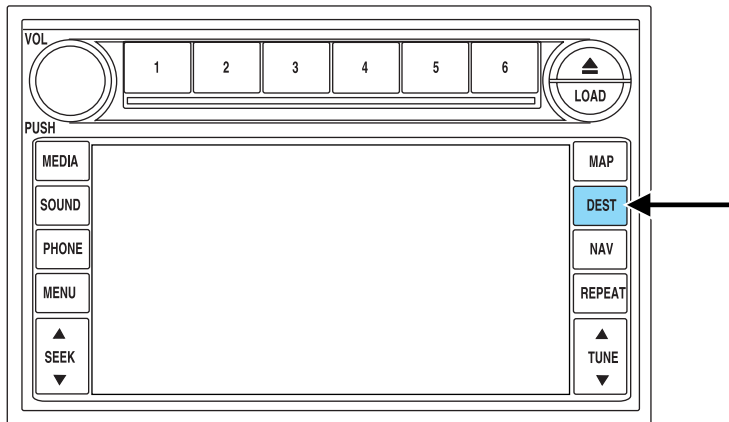

1. Press DEST.
2. Select INTERSECTION to program a destination to a major intersection.



3. Under STREET #1, use the keypad to type in the name of the first street. The streets that intersect with your STREET #1 will appear in a list. Select the desired street (STREET #2) from the list. The list can be sorted alphabetically, or in the order of distance from the current position. After entering the desired intersection, select the city from the list. The Destination Map will appear.

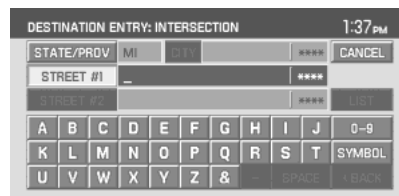

Navigation features

- **STATE/PROV:** Press to set the State, Province or Territory using the keyboard or select from List . The preset value for this field is based on current position (Auto Fill On) or previous selection (Auto Fill Off), depending on the settings.

USA: Select any state including District of Columbia and the U.S. territories of Puerto Rico and U.S. Virgin Islands.

CANADA: Select any province or territory.

- **CITY:** Input city name for desired location.
- **STREET#1:** Streets which include numbers in their name can be searched if the name is input using digits or a spelling of the number. This applies to street names containing whole numbers from 1 (one) to 20 (twenty) or 1st (first) to 20th (twentieth) only.
- **STREET#2:** Enter a valid name for the intersecting street, or select from a list.
- **LIST:** State/Provinces/Territories, Cities, and Names can be selected from a list determined by the Smart Speller.

FREEWAY ENTRANCE/EXIT

To set a freeway entrance or exit as a destination:

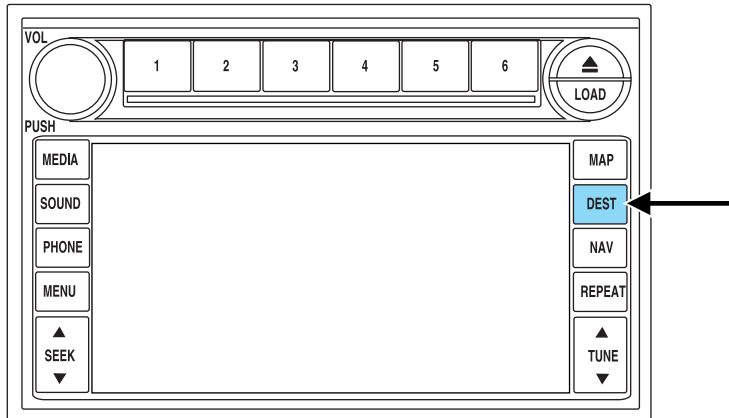

1. Press DEST.

Navigation features

2. Select FREEWAY ENTRANCE/EXIT.



The system will allow you to input a Freeway name, and an entrance or exit to that freeway. The entrance/exit list can be sorted alphabetically or by distance from the vehicle position. After selecting the desired intersection, the Destination Map will appear.

- **STATE/PROV:** Press to set the State, Province or Territory using the keyboard or select from List. The preset value for this field is based on current position (Auto Fill On) or previous selection (Auto Fill Off), depending on the settings.

USA: Select any state (except Alaska), including Puerto Rico and the District of Colombia.

CANADA: Select any province or territory.

- **FREEWAY:** The Smart Speller will facilitate the entry of a valid freeway in the area specified.
- **LIST:** State/Provinces/Territories, Cities, and Names can be selected from a list determined by the Smart Speller.

DESTINATION MAP

After the destination type has been selected, and the necessary information is entered, the desired location will be shown on the destination map. You can then plan a route or save the location by using one of the buttons at the bottom of the screen:

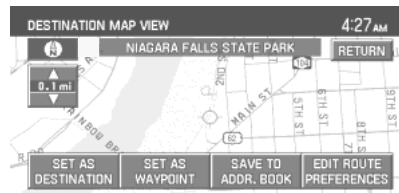

- **SET AS DESTINATION:** Select for the system to calculate your selected destination immediately. The SELECT ROUTE screen will then display. Refer to *Select route*.
- **SET AS WAYPOINT:** Select for the desired location to be stored as a waypoint. The DESTINATION/WAYPOINT LIST will then display. Refer to *Destination/Waypoint list*.

Navigation features

- **SAVE TO ADDRESS BOOK:** Select for the system to store desired location in the address book.
- **EDIT ROUTE PREFERENCES:** Select to set or change the preferences for the selected route. Refer to *Route preferences*.

DESTINATION/WAYPOINTS LIST

After you have selected a location, you can set that location as a waypoint by pressing the SET AS WAYPOINT while in the DESTINATION MAP screen. If a route is already active, press DEST and select the QUICK DEST tab, or press EDIT



DESTINATION/WAYPOINTS directly from the map. The Destination/Waypoint List screen will appear, showing a list of the final destination and up to five waypoints. From this screen, you can select:

- **OPTIMIZE:** This appears on screen when multiple waypoints have been listed. Press in order to find the first closest waypoint and then the next closest waypoint.
- **CHANGE ORDER:** This appears after one waypoint has been selected. Press to manually arrange waypoints moving them one space up or down at a time in the list. You can also move the destination to a waypoint, making the last waypoint the new destination.
- **ADD ANOTHER:** This selection allows you to search and add one more waypoint or destination to the list. This becomes disabled once there are five waypoints and one destination programmed.
- **DELETE:** Press to delete the selected waypoint from the list.
- **DELETE ALL:** Press to delete all the listed items.
- **COMPUTE ROUTE:** Press for the system to begin calculating the selected destination and waypoints.

Note: You can select waypoints before a destination is selected. If a waypoint is deleted while a route is active, the route is recalculated from the current position to the following waypoint or destination.

Navigation features

SELECT ROUTE SCREEN

The Select route screen will appear after COMPUTE ROUTE is selected from the DESTINATION/WAYPOINTS LIST screen or the SET AS DESTINATION from the DESTINATION MAP screen. You can then select from any of the following options:



- **ROUTE PREFS:** Press to change settings for route searches. Refer to *Route preferences*.
- **START ROUTE:** Press to begin guidance for the selected route. All other calculated routes will be deleted.
- **CANCEL ROUTE:** Press to delete the current route (which you will not be able to retrieve.)

The system will display all computed routes, and the preferred route will be highlighted. A route information box will appear on the right hand side of the screen which consists of:

- **ROUTE PREFERENCE ICONS:** These icons indicate the status of the route preferences. Refer to *Route preferences*.
- **CALCULATED POSSIBLE ROUTES:** These routes will be displayed simultaneously, each highlighted with a different color. To view the details of each route, press the corresponding button.

RECALCULATION OF ROUTE

If the vehicle deviates from the selected guidance route, the navigation system will automatically recalculate the route from the current location.

VOICE GUIDANCE PROMPTS

Once a route is selected, you will begin to hear voice guidance prompts. If you are not currently on the route, there will be a prompt. There may be up to three voice prompts for each maneuver, depending on the vehicle speed and the distance before the maneuver. The voice prompts will announce all road names in route guidance instructions. Road name pronunciations may vary from local pronunciations. The last prompt will be a double tone and will give just enough time for you to complete the maneuver.

To adjust the volume level of the voice guidance prompts, turn the volume control during a voice prompt, or set to the desired level on the FEEDBACK screen. (Refer to the *Menu* section).

Navigation features

NAVIGATION MENU

MAP PREFERENCES

Your navigation system allows you to set specific map preferences. In the Map Preference screen you may select from:

MAP CONTENT Select one of the following map displays:

- **CURRENT STREET NAME:** Displays the current street name in a window at the top of the screen.
- **TIME TO DESTINATION:** Displays the distance and estimated travel time to the selected destination on the left side of the screen. When selected, a popup screen will also display the Estimated Time of Arrival (ETA).
- **BREADCRUMBING:** Stores and allows the display of the vehicle's previous route(s). These routes are indicated by white dots on the map display. The system can store up to about 140 miles/230 km.

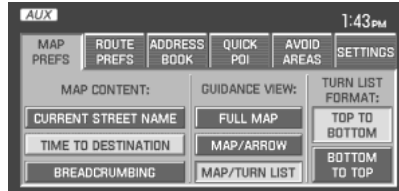

GUIDANCE VIEW: Select one of the guidance views:

- **FULL SCREEN MAP MODE:** The map is displayed on the full screen and a turn icon appears in the upper right hand corner of the screen.
- **SPLIT SCREEN ARROW MODE:** The screen is divided in two: the map is displayed on the left, while a turn icon and street name signify the upcoming maneuver on the right.

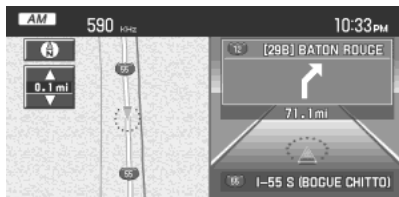
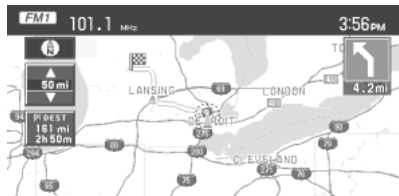

Navigation features

- **SPLIT SCREEN TURN LIST MODE:** The screen is divided in two, the map is displayed on the left, and the planned turn list is on the right.



Regardless which guidance view is selected, a detailed intersection screen will appear on the right side of the map display when the vehicle is approaching the next turn.

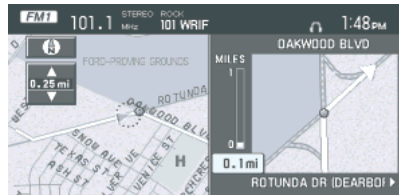

TURN LIST FORMAT: You can select which order the guidance instructions appear on the screen:

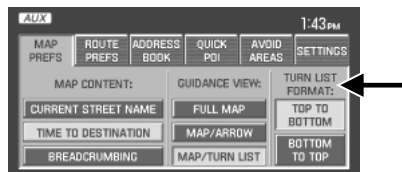

- TOP TO BOTTOM
- BOTTOM TO TOP

Navigation features

ROUTE PREFERENCES

You can select certain preferences for your route.

- **AVOID FREEWAYS / TOLL ROADS / FERRIES:** The system will search for routes attempting to avoid the use of freeways, toll roads and/or ferries whenever possible.

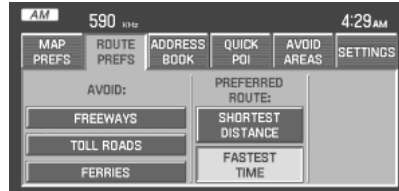

- **PREFERRED ROUTE:** The system can search for up to three routes: fastest route, shortest route and unrestricted route (the fastest or shortest route without any "avoid" settings). If there are not any Avoid settings, only two routes will be calculated and displayed. The preferred route will be automatically highlighted on the map for route selection.

ADDRESS BOOK — EDITING

The ADDRESS BOOK tab allows you to view and edit the address book entries. The maximum number of entries that can be stored in the address book is 25. Five of these entries can be set as Destination Presets (to be easily accessed), and one entry can be saved as the Home location. To set an Address Book entry as a destination preset, select the address book entry and select the view/edit button.

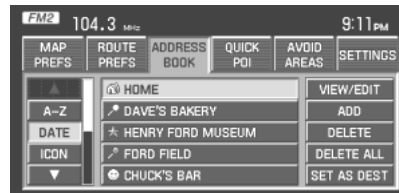

Select the set button at the bottom of the screen adjacent to Quick Dest. The list of entries can be sorted by:

- **A-Z:** List entries by alphabetical order.
- **DATE:** List entries by date of entry.
- **ICON:** List entries by icon type.

Navigation features

VIEW/EDIT: The information related to each entry can be changed or entered according to the following criteria:

| ADDRESS BOOK: VIEW/EDIT | | 12:26 AM |
|-------------------------|-------------------------------|-----------|
| NAME | JASON'S OFFICE | RETURN |
| LOCATION | 20300 ROTUNDA DR, DEARBORN, ▶ | |
| PHONE | 555-555-5555 | |
| ICON | 🏠 | |
| QUICK DEST | DEST PRESET 1 | SET CLEAR |
| VOICE | ENABLED | CLEAR |
| NAMETAG | | |

- **NAME:** Input a name or leave this blank.
- **LOCATION:** Previously programmed address.
- **PHONE NUMBER:** Select to edit phone number for the specified entry.
- **ICON:** Select from a list of available icons. All icons, except for the Home icon, can be used more than once.
- **QUICK DEST SET/CLEAR:** A maximum of five entries can be selected as Destination Preset entries. These entries are accessible directly from the QUICK DEST tab under the DEST menu as well as through any of the ADDRESS BOOK tabs.
- **VOICE NAMETAG SET/CLEAR:** Use for voice tag designation.

| ADDRESS BOOK ENTRY: EDIT PRESET | |
|---------------------------------|-----------------------------|
| SELECT THE PRESET LOCATION: | |
| HOME: | 🏠 HOME |
| PRESET 1: | 🍫 ANDREA'S CHOCOLATES |
| PRESET 2: | ✈️ INTERNATIONAL ARRIVALS ▶ |
| PRESET 3: | 📍 8530 ALLEN RD, ALLEN PA ▶ |
| PRESET 4: | 📍 5278 WABASH ST, DETROIT ▶ |
| PRESET 5: | 🍦 MARK'S FAVORITE ICE CRE ▶ |

ADD: You can select a location by one of the following methods:

- **PREVIOUS DEST**
- **POI**
- **ADDRESS**
- **INTERSECTION**
- **MAP**
- **FREEWAY ENT/EXIT**
- **PHONE NUMBER**

DELETE: Press to delete the selected entry from the list.

DELETE ALL: Press to delete all entries in the address book.

SET AS DEST: Press for the DESTINATION MAP screen to appear with more options from which to select. Refer to *Destination menu*.

Navigation features

QUICK POINTS OF INTEREST (POIS)

This tab allows you to set the five most frequently used Point of Interest (POI) categories.

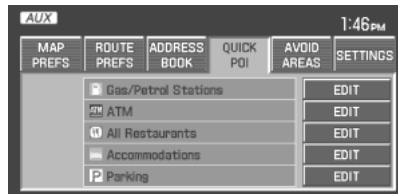

- **QUICK POI LIST:** Lists five preset POI categories. You can change any of them.
- **EDIT:** Press to select a different POI category/subcategory from a list.

AVOID AREAS

You can search avoiding all roads (even freeways) within specified avoid areas. If any road within an avoid area is used for the route, an icon will be displayed on the screen for route selection. A maximum of five areas can be stored as Avoid Areas. They are represented on the map as colored squares. If a road is specified as an avoid area, it is represented by a different color to other roads.

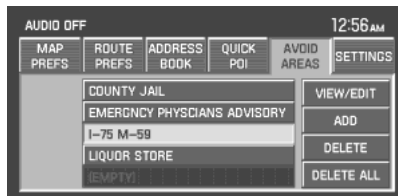

VIEW/EDIT: After entries are programmed, they are shown in a list. Highlight your selection to change/edit the following attributes:

- **NAME:** Select to enter a different name for the area.
- **LOCATION:** A map with the selected location will appear on the screen. You can then:

REDUCE AREA

SAVE AREA

EXPAND AREA

- **RETURN:** Saves changes to the selected area.

ADD: Add an avoid area by selecting an input method and entering the required information:

- **PREVIOUS DEST**
- **POI**
- **ADDRESS**

Navigation features

- **INTERSECTION**
- **MAP**
- **FREEWAY ENTRANCE/EXIT**
- **PHONE NUMBER**
- **CANCEL**

DELETE: Press to delete the selected entry.

DELETE ALL: Press to delete all entries in the Avoid Area list.

SETTINGS

UNITS: The system can be set to display different units:

- **ENGLISH (MILES)**
- **METRIC (KILOMETERS)**

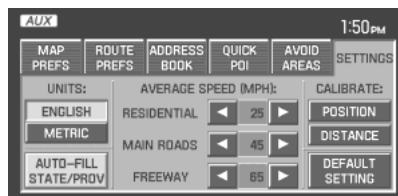

AUTO-FILL STATE/PROV: When selected, the State/Province field will be automatically filled in based on current location for destination entry. If it is not selected, the last State/Province will be displayed.

AVERAGE SPEED (MPH): You can preset speeds based on driving habits for calculation of travel time and ETA (Estimated Time Arrival).

- **RESIDENTIAL**
- **MAIN ROADS**
- **FREEWAY**

CALIBRATE: The navigation system supports a quick method to calibrate the vehicle position. Under normal circumstances this calibration is done automatically, but over a longer period of time. The user may want to recalibrate the system if the vehicle icon is not tracking proper position resulting in inaccurate route guidance instructions.

- **POSITION:** The system supports manual adjustment of the vehicle's position and heading via the Map. Press to scroll on map until the desired location is reached and press ENTER. Adjust the vehicle heading by pressing the arrow buttons until the desired heading is reached. Press ENTER to save the new settings.

DEFAULT SETTINGS: Press to set all the features in this screen back to system default.

Navigation features

VOICE RECOGNITION (IF EQUIPPED)

Your navigation system may be equipped with Voice Recognition (VR), a hands-free way of operating the radio and navigation system while driving. With this feature, you can control navigation, audio, display and voice settings by “speaking” specific commands.

Press  or VOICE on your steering wheel controls to activate Voice recognition. Speak clearly and ensure that the commands are spoken exactly as they are written or they may not function. You must say the system function followed by the sub command. System functions are listed in bold below; subcommands are listed beneath. For example, if you wanted the map to be shown on the system screen, you would say “Navigation Show Map”.

If the voice system is already engaged in a specific function, there is no need to continue repeating that function for future commands within a 30 second period. For example, if you just finished saying “Navigation Show Map” and then wanted to zoom the map in, you could say “Zoom In” instead of “Navigation Zoom In”. After 30 seconds has elapsed, the voice system will start the next voice session from the main menu.

| Navigation+ | Audio+ | Display + | Voice Settings + | Tutorial + |
|----------------------|---------------|------------------|---------------------------|-------------------|
| | Line In | | | |
| | Rear Aux | | | |
| | Radio + | | | |
| Detour / Reroute | Play | ON | Interaction Mode | Lesson 1 |
| Cancel Route | Auto Preset | OFF | Interaction Mode Standard | Lesson 2 |
| Cancel Next Waypoint | Seek Up | Night | Interaction Mode Advanced | Lesson 3 |
| Repeat Instruction | Seek Down | Day | Profile Create | Previous Lesson |

Navigation features

| Navigation+ | Audio+ | Display + | Voice Settings + | Tutorial + |
|-----------------------------|------------------------------------|-----------|-------------------------------|-------------|
| Voice On | Tune Frequency | Auto | Profile Delete (Profile Name) | Next Lesson |
| Voice Off | Tune AM | Brighter | Profile Select (Profile Name) | |
| Voice Louder | Tune FM | Dimmer | Profile Select None | |
| Voice Softer | Tune FM1 | Help | Help | |
| Help | Tune FM2 | | | |
| <i>Map Commands</i> | Tune Preset # | | | |
| Show Map | Store Preset # | | | |
| Zoom In | | | | |
| Zoom Out | Help | | | |
| Zoom In Minimum | CD + | | | |
| Zoom In Maximum | Play | | | |
| Show Destination | Play Disc # | | | |
| Show or Clear Next Waypoint | Play Track # | | | |
| Show or Clear Route | Play Folder # | | | |
| Show North Up | Play Disc # Folder # Track # | | | |
| Show Heading Up | Play Next Disc | | | |

Navigation features

| Navigation+ | Audio+ | Display + | Voice Settings + | Tutorial + |
|--|---------------------------|------------------|-------------------------|-------------------|
| <i>Destination Commands</i> | Play Next Folder | | | |
| Route Home/Return Home | Play Next Track | | | |
| Destination (Nametag) | Play Previous Disc | | | |
| Play Nametags | Play Previous Folder | | | |
| Destination or Find a Restaurant | Play Previous Track | | | |
| Destination or Find all Restaurants | Folder Mode | | | |
| Destination or Find an American Restaurant | Folder Mode On | | | |
| Destination or Find an Chinese Restaurant | Folder Mode Off | | | |
| Destination or Find a Fast food Restaurant | Shuffle, Random or Mix | | | |
| Destination or Find an Italian Restaurant | Shuffle, Random or Mix On | | | |

Navigation features

| Navigation+ | Audio+ | Display + | Voice Settings + | Tutorial + |
|--|-------------------------------|-----------|------------------|------------|
| Destination or Find a Mexican Restaurant | Shuffle, Random or Mix Off | | | |
| Destination or Find a Seafood Restaurant | Help | | | |
| Destination or Find a Steak House Restaurant | DVD+ | | | |
| Destination or Find a Vegetarian Restaurant | Play | | | |
| I'm Hungry | Play Next or Previous Chapter | | | |
| Destination or Find an Auto Parts | Play Next or Previous Chapter | | | |
| Destination or Find an/a automobile / car dealership | Play Next or Previous Folder | | | |
| Destination or Find a Ford dealership | Play AUX | | | |
| Destination or Find a Lincoln dealership | Play Previous Folder | | | |

Navigation features

| Navigation+ | Audio+ | Display + | Voice Settings + | Tutorial + |
|---|---------------------------|------------------|-------------------------|-------------------|
| Destination or Find a Mercury dealership | Headphones ON | | | |
| Destination or Find an oil change | Headphones OFF | | | |
| Destination or Find a Business Facility | Shuffle Tracks | | | |
| Destination or Find a Community Center | Shuffle ON | | | |
| Destination or Find Education | Shuffle OFF | | | |
| Destination or Find Higher Education/ College/ University | Folder Mode ON | | | |
| Destination or Find K-12 Schools | Folder Mode OFF | | | |
| Destination or Find an Exhibition/ Conference Center | Help | | | |
| Destination or Find a Library | *Satellite Radio + | | | |

Navigation features

| Navigation+ | Audio+ | Display + | Voice Settings + | Tutorial + |
|--|----------------|-----------|------------------|------------|
| Destination or Find a Named Place | Play | | | |
| Destination or Find a Hospital | Seek up | | | |
| Destination Police, Find a Police Station or Find Police | Seek Down | | | |
| Destination or Find an Amusement Theme Park | Tune (#) | | | |
| Destination or Find a Casino | Tune SR1 | | | |
| Destination or Find a Movie Theater | Tune SR2 | | | |
| Destination or Find a Museum | Turn SR3 | | | |
| Destination or Find a Performing Arts | Preset # | | | |
| Destination or Find a Zoo/Botanical Gardens | Store Preset # | | | |
| Destination or Find an ATM | Next Channel | | | |

Navigation features

| Navigation+ | Audio+ | Display + | Voice Settings + | Tutorial + |
|--|------------------|------------------|-------------------------|-------------------|
| Destination Bank/Banking or Find a Bank | Previous Channel | | | |
| Destination or Find a Historical Monument | | | | |
| Destination or Find an International Border Crossing | | | | |
| Destination or Find Parking | | | | |
| Destination or Find Public Transit | | | | |
| Destination or Find an Airport | | | | |
| Destination or Find a Bus Station | | | | |
| Destination or Find a Commuter Rail | | | | |
| Destination or Find a Ferry Terminal | | | | |

Navigation features

| Navigation+ | Audio+ | Display + | Voice Settings + | Tutorial + |
|---|--------|-----------|------------------|------------|
| Destination or Find a Rest Area | | | | |
| Destination or Find a Tourist Attraction | | | | |
| Destination or Find Tourist Information | | | | |
| Destination or Find Coffee House, Find Cafe | | | | |
| Destination or Find Pharmacies | | | | |
| Destination or Find a Book Store | | | | |

When voice commands are given for points of interest searches (i.e. Navigation + Destination + All restaurants), the search criteria varies by specific category and current road type. The search distance range is 10–80 mi (16–128 km).

Note: Satellite Radio and DVD voice commands are operational only on vehicles equipped with those features.

Navigation features

A listing of all available voice commands also resides in the navigation system. To access this list:

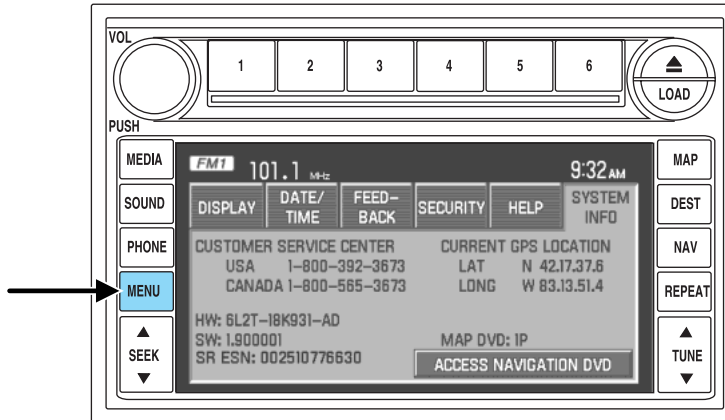

1. Press the MENU hard key.
2. Press SYSTEM INFO.
3. Press HELP.
4. Select VOICE SETTING COMMANDS.

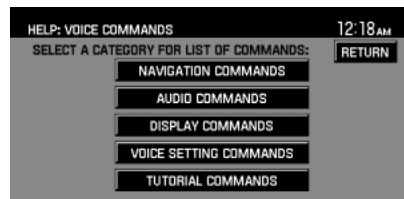

Voice recognition (VR) operates for all system languages. There is a push to talk button on the vehicle steering wheel labeled either VOICE or . Press to activate Voice Recognition. The system will state available commands, and then listen for a spoken response from you. Speak the command clearly to ensure that the system is able to recognize and perform the desired function.

Navigation features

VOICE RECOGNITION VISUAL FEEDBACK (NAVIGATION STATUS BAR)



When Voice recognition (VR) is activated, the following icons will appear on the screen in the status bar.







| VR State | VR Icon | VR Device Text |
|-------------------------------------|---------|------------------|
| Main Menu | | Main Menu |
| Audio system | | Audio System |
| Navigation | | Navigation |
| MP3 | | MP3 |
| Satellite Radio | | Satellite Radio |
| FM Radio | | FM |
| AM Radio | | AM |
| CD | | CD |
| Voice Preferences | | Voice Settings |
| Display | | Display |
| Tutorial | | Tutorial |
| DVD | | DVD |
| DVD_MP3 | | DVD_MP3 |
| DVD_CD | | DVD_CD |
| VR Recognition Failure | | Listening Failed |
| VR Session Successful Completion | | Voice Success |
| VR Session Unsuccessful Termination | | Voice Failed |
| Listening | | Listening |

Navigation features

For the best system performance, please adhere to the following:

- The interior of the vehicle needs to be as quiet as possible. Wind noise from open windows, road vibrations, and radio volume may prevent the system from correctly recognizing voice commands.
- Wait until the tone sounds after pressing the push to talk button before speaking a command.
- Speak naturally without large pauses in between words.
- Please realize voice recognition performance is not 100% and varies by user. The voice recognition system is meant to be a secondary convenience control and if it doesn't operate optimally, users can still operate their navigation system via the touch screen and hard buttons.

To speak voice commands:

1. Push VOICE or  on the steering wheel. A tone will sound.
2. 'Main Menu' and  will appear in the status bar.
3. The system will speak the available voice commands and a tone will sound.
4. 'Listening' and  will appear in the status bar and the system waits for your response.
5. If the system is not confident that it recognized your voice command, it will ask for a confirmation of yes or no.
6. If the system does not recognize or hear the your voice command, it will say, "Sorry, please say" and repeat the available voice commands. The voice failed icon  will be displayed in the status bar.
7. If the system does not recognize or hear your voice command a second time, the system will say, "Sorry, please press the voice button and try again" and the voice session is terminated.
8. Once confirmation / recognition takes place, the voice success icon  is displayed. The system will speak the next level of available commands, a tone will sound, and the appropriate voice menu name and icon will be displayed.
9. If the voice session is not complete, the system will then speak the next set of available voice commands, a tone will sound, and the system will display 'listening'  and again, waits for a response.
10. This sequence of events occurs until the voice recognition session is complete.

Navigation features

Three voice recognition tutorials are available through the voice system:

- Lesson One: What you can do with speech
- Lesson Two: How we'll work together
- Lesson Three: Getting accustomed to the system

To access the tutorials, press the voice button on the steering wheel and say, "Tutorial Lesson (1, 2 or 3)".

Voice settings

Voice settings are adjusted through the voice recognition. In voice settings, you can customize the system to behave the way you prefer as well as train the system to fine tune its listening to a specific user by creating a profile. The following settings are available:

- Interaction mode: standard or advanced

Standard system provides detailed user instructions and announces all available voice commands

Advanced system speaks less and assumes that the user knows the voice commands

- Profile: trains the system to create voice profiles of users. The vehicle must be in Park and the profile takes approximately 10 minutes to complete.

Voice Tags

Voice recognition includes a function that allows you to input personal names for locations to be recognized by the system. These are called 'voice name tags'. You can assign voice name tags to all locations stored in the address book to be used later as destinations.

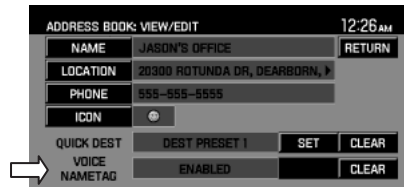

Frequently asked questions

FREQUENTLY ASKED QUESTIONS

How do I turn off the Navigation System?

Press and hold the Volume control for at least 3 seconds.

How do I hear the navigation voice prompts?

1. Press the MENU hard button.
2. Select the FEEDBACK tab.
3. Check the VOICE VOLUME LEVEL and that the NAVIGATION GUIDANCE setting is on.

How do I recover after accidental language re-set?

1. Press the MENU hard button.
2. Select the FEEDBACK/Retour/Reaccion tab.
3. Press the ENGLISH/Anglais/Ingles button to reset language to English.
4. Press the SPANISH/Espanol/Espanol button to reset language to Spanish.
5. Press the FRENCH/Francais/Frances button to reset language to French.

Or, you can also turn vehicle off to restart system. Then from the DISCLAIMER screen, select the desired language before pressing AGREE.

TROUBLESHOOTING

| Symptoms | Possible Cause | Action |
|-------------|--|--|
| Focus Error | System unable to play reproduced disc. | Contact your dealer. |
| Bad Disc | Disc was inserted upside down or the system is unable to read the information in the disc. | The mechanism will automatically eject disc. |
| Track Error | The system is unable to reproduce a corrupt MP3 file. | The system will skip the corrupted track. |

Frequently asked questions

| Symptoms | Possible Cause | Action |
|--|--|---|
| Invalid Disc Detected | Dirty DVD | Wipe the DVD with a dry, soft cloth from the center to the outer edge of the disc. |
| System has detected incompatible NAV DVD Would you like to change a NEW DVD? (Popup window) | The DVD mechanism is unable to reproduce the information in the disc inserted in the DVD slot. | Eject the currently loaded disc, and insert the correct map DVD in the DVD slot. Refer to <i>Loading and Ejecting Navigation Map DVDs</i> in the System Features section. |
| Address not found/ Address range does not exist. Show the midpoint of the street? (Popup window) | The house number entered is not registered in the database. | Press NO and enter a valid number for the specified street, or press YES to view the middle point of the street. |
| Navigation Fault. A system fault has been detected that may cause the navigation to perform abnormally. Please contact your dealership. (Popup window) | System hardware or software error | Contact your dealer. |
| Error. PINs did not match. Please re-enter. (Popup window) | A different PIN was entered to unlock the system for valet mode. | Press OK and try entering PIN again. If unable, contact your dealer. |
| Invalid PIN. Please Re-enter. (Popup window) | System does not recognize PIN as valid. | Press OK and enter different PIN to lock the system. |

Frequently asked questions

| Symptoms | Possible Cause | Action |
|---|--|---|
| Error. Map DVD must be loaded in order to change language. (Popup window) | Map DVD is not in DVD slot. | Press OK, then load a valid map DVD. |
| Navigation DVD error. Installation failed. Please install a valid Navigation DVD. (Popup window) | The DVD mechanism is unable to reproduce the information in the disc inserted in the DVD slot. | Eject the currently loaded disc, and insert the correct map DVD in the DVD slot. Refer to <i>Loading and Ejecting Navigation Map DVDs</i> in the System Features section. |

General Information

SYSTEM HELP

Please refer to the system Help Menu or system functional descriptions. If additional help is required, please contact Ford Customer Service in the US at 1 (800) 392-3673 and in Canada 1 (800) 565-3673.

MAP DATA DVD END-USER LICENSE TERMS

The data ("Data") is provided for your personal, internal use only and not for resale. It is protected by copyright, and is subject to the following terms and conditions which are agreed to by you, on the one hand, and (Licensee). ("Licensee") and its licensors (including their licensors and suppliers) on the other hand. Such licensors include NAVTEQ North America, LLC. Without limiting the foregoing, you agree that NAVTEQ North America, LLC shall have the right to enforce these Terms directly against you. © 2004 NAVTEQ. All rights reserved. The Data for areas of Canada includes information taken with permission from Canadian authorities, including: © Her Majesty the Queen in Right of Canada, © Queen's Printer for Ontario, © Canada Post Corporation, Geobase ®.

TERMS AND CONDITIONS

Personal use only: You agree to use this Data together with your FLM navigation system for solely personal, non commercial purposes for which you were licensed, and not for service bureau, time-sharing or other similar purposes. Accordingly, but subject to the restrictions set forth in the following paragraphs, you may copy this Data only as necessary for your personal use to (i) view it, and (ii) save it, provided that you do not remove any copyright notices that appear and do not modify the Data in any way. You agree not to otherwise reproduce copy, modify, decompile, disassemble or reverse engineer any portion of this Data, and may not transfer or distribute it in any form, for any purpose, except to the extent permitted by mandatory laws.

Restrictions: Except where you have been specifically licensed to do so by (Licensee), and without limiting the preceding paragraph, you may not (a) use this Data with any products, systems, or applications installed or otherwise connected to or in communication with vehicles, capable of vehicle navigation, positioning, dispatch, real time route guidance, fleet management or similar applications; or (b) with or in communication with any positioning devices or any mobile or wireless-connected electronic or computer devices, including without limitation cellular phones, palmtop and handheld computers, pagers, and personal digital assistants or PDAs.

General Information

No warranty: This Data is provided to you “as is,” and you agree to use it at your own risk. (Licensee) and its licensors (and their licensors and suppliers) make no guarantees, representations or warranties of any kind, express or implied, arising by law or otherwise, including but not limited to, content, quality, accuracy, completeness, effectiveness, reliability, fitness for a particular purpose, usefulness, use or results to be obtained from this Data, or that the Data or server will be uninterrupted or error-free.

Disclaimer of warranty: (Licensee) and its licensors (including their licensors and suppliers) disclaim any warranties, express or implied, of quality, performance, merchantability, fitness for a particular purpose or non infringement. Some States, Territories and Countries do not allow certain warranty exclusions, so to that extent the above exclusion may not apply to you.

Disclaimer of liability: (Licensee) and its licensors (including their licensors and suppliers) shall not be liable to you: in respect of any claim, demand or action, irrespective of the nature of the cause of the claim, demand or action alleging any loss, injury or damages, direct or indirect, which may result from the use or possession of the information; or for any loss of profit, revenue, contracts or savings, or any other direct, indirect, incidental, special or consequential damages arising out of your use of or inability to use this information, any defect in the information, or the breach of these terms or conditions, whether in an action in contract or tort or based on a warranty, even if (Licensee) or its licensors have been advised of the possibility of such damages. Some States, Territories and Countries do not allow certain liability exclusions or damages limitations, so to that extent the above may not apply to you.

Export control: You agree not to export from anywhere any part of the Data provided to you or any direct product thereof except in compliance with, and with all licenses and approvals required under, applicable export laws, rules and regulations.

Termination for Breach or Bankruptcy: (Licensee) and its licensors, including NAVTEQ, may terminate this Agreement if you breach any of its terms. Upon any such termination, you shall immediately cease your use of the Data and return all copies thereof to LICENSEE or NAVTEQ, as instructed. (Licensee) and its licensors also may terminate this Agreement in the event that you (i) fail to pay license fees due for the Data, or (ii) if any of the following events occur affecting you: (a) voluntary bankruptcy or application for bankruptcy; (b) involuntary bankruptcy or application for bankruptcy not discharged within sixty (60) days; (c) appointment of receiver for all or a portion of your assets; or (d) any assignment for the benefit of creditors.

General Information

Entire agreement: These terms and conditions constitute the entire agreement between (Licensee) (and its licensors, including their licensors and suppliers) and you pertaining to the subject matter hereof, and supersedes in their entirety any and all written or oral agreements previously existing between us with respect to such subject matter.

Governing law: The above terms and conditions shall be governed by the laws of the Illinois, without giving effect to (i) its conflict of laws provisions, or (ii) the United Nations Convention for Contracts for the International Sale of Goods, which is explicitly excluded. You agree to submit to the jurisdiction of Illinois for any and all disputes, claims and actions arising from or in connection with the Data provided to you hereunder.

FCC COMPLIANCE

Changes or modifications not approved by Ford Lincoln Mercury could void user's authority to operate the equipment. This equipment has been tested and found to comply with the limits with the Class B digital device, pursuant to Part 15 of the FCC Rules. These limits are designed to provide reasonable protection against harmful interference in a residential installation. This equipment generates, uses and can radiate radio frequency energy and, if not installed and used in accordance with the instructions, may cause harmful interference to radio communications.

However, there is no guarantee that interference will not occur in a particular installation. If this equipment does cause harmful interference to radio or television reception, which can be determined by turning the equipment off and on, the user is encouraged to consult the dealer or an experienced radio/TV technician for help.

PRINCIPLES OF NAVIGATION

The system directs the user based on information derived from global positioning satellites, road maps stored on the DVD, sensors in the vehicle and the desired destination. The system compiles all necessary information to guide the user to the selected destination. Space satellites broadcast information used to determine the vehicle's current location.

General Information

LIMITED GPS RECEPTION

System performance may be adversely affected if GPS reception is interrupted or interference occurs over a distance of several miles. The following are possible causes for GPS reception being interrupted. If the vehicle is:

- In multi-story parking garages
- In tunnels and under bridges
- Inside or in between buildings
- By forests or tree-lined avenues
- In heavy rain showers and thunderstorms
- In valleys and in mountainous regions
- Roads under cliffs

Ensure that you do not have any metal objects on the dashboard and that if your windows are tinted, they use non-metal tinting instead of metal oxide tinting. Both of these factors can also interrupt GPS reception.

If the vehicle has been parked for a long period of time, the navigation function may be temporarily unresponsive. The navigation system will operate reliably again once GPS reception is available for a few minutes.

SYSTEM LIMITATIONS

Cold temperature start: When operating the system below 32° F (0°C), the display screen requires a 2–3 minutes warm-up time to achieve maximum brightness.

Other conditions: When calculating a route, the system doesn't take into consideration any of the following conditions:

- Traffic Conditions
- Weather Conditions
- Driving Habits
- Construction Zones
- New Roads

General Information

CLEANING THE NAVIGATION DISPLAY SCREEN

Do not spray cleaning fluid directly onto the navigation display screen as this may cause damage. Instead, spray the cleaning fluid onto a soft cloth and gently wipe the screen and unit. Use only rubbing alcohol-based cleaners (i.e. methyl alcohol) or a damp clean cloth.

Do not clean any part of the screen or system with acid cleaners, alkali cleaners, benzene cleaners, paint thinner or any other solvent.

Do not spill liquids of any kind into the unit.

GLOSSARY

COMP: Compression

DEST: Destination

DSP: Digital Signal Processing

ETA : Estimated Time of Arrival

FCC: Federal Communications Commission

GPS: Global Positioning System

MAP/NAVIGATION DVD: The disc containing a map database to operate the navigation system.

POI: Point(s) Of Interest

PROV: Province

PTY: Program Type

RDS: Radio Data System

SCV: Speed Compensated Volume

SMART SPELLER: Feature that provides a number of available candidates matching partial input entered by the user.

SR: Satellite Radio

TOUCH SCREEN: A touch-sensitive screen that lets the user make choices by touching icons or graphical buttons on the screen.

WAYPOINT: An intermediate stop or destination before the final destination.

SYNC (if equipped)

WHAT IS SYNC?

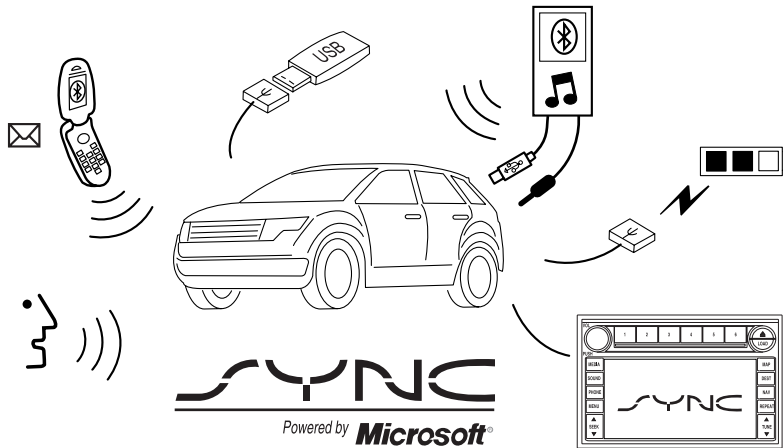

SYNC is a hands-free communications and entertainment system that literally 'syncs up' with all other multimedia systems in your vehicle. SYNC delivers convenience with voice activated calling and hands-free conversations, digital media player command and control as well as easy to use voice commands. The world outside your vehicle cabin may be chaotic, but inside, with SYNC, it's always a smooth ride. All you have to do is sync it and stow it. We'll take care of the rest.

Welcome to the new world of ingenuity and passion - technology that is both fun and functional. Welcome to SYNC.

Please visit www.SyncMyRide.com.

SYNC features

SYNC offers a variety of phone and media features, such as:

- Send and receive hands-free calls
- Play your digital music through voice activated commands
- Use voice recognition to access your cell phone's contact list
- Transfer an active phone conversation to a hands-free environment
- Play music stored on your digital media player
- Use your device while charging through the USB port

SYNC (if equipped)

- Listen to music streaming from your *Bluetooth*® enabled cellular phone
- Advanced voice recognition system fluent in English, French and Spanish

SAFETY INFORMATION



Driving while distracted can result in loss of vehicle control, accident and injury. Ford strongly recommends that drivers use extreme caution when using any device that may take their focus off the road. The driver's primary responsibility is the safe operation of their vehicle. Only use cell phones and other devices not essential to the driving task when it is safe to do so.

- Do not attempt to service or repair SYNC. See your authorized dealer.
- Do not operate playing devices if the power cords and/or cables are broken, split or damaged. Carefully place cords and/or cables where they will not be stepped on or interfere with the operation of pedals, seats and/or compartments, or safe driving abilities.
- Do not leave playing devices in the vehicle in extreme conditions as it could cause damage to your device. Refer to your device's user guide for further information.
- For your safety, some SYNC functions are speed dependent and cannot be performed when the vehicle is traveling at speeds greater than 3 mph (4.82 km/h).
- Ensure that you review your device's user guide before using with SYNC.

PHONE DEPENDENT FEATURES

While SYNC supports a variety of features, many are dependent upon the functionality of your cell phone with *Bluetooth*® wireless technology. At a minimum, most cellular phones with *Bluetooth* wireless technology support the following functions:

- Answering an incoming call
- Ending a call
- Using privacy mode
- Dial a number
- Redial
- Call waiting notification

SYNC (if equipped)

- Caller ID

Other features, such as text messaging via *Bluetooth*, and automatic phone book download are phone dependent features. To ensure that you have a compatible cellular phone, refer to your phone's user manual and visit www.SyncMyRide.com.

SYNC VOICE RECOGNITION FEATURE

SYNC is equipped with an advanced interactive Voice Recognition (VR) system. This system allows you to perform many operations by "speaking" certain commands to the system. The system will respond with a series of audible tones, prompts, questions and spoken confirmations depending on the situation and the chosen level of dialogue interaction.

Feedback through audible tones

Your VR system will respond through various audible tones. You may hear a tone at the following times:

- When you press VOICE or  on your steering wheel controls.
- When you access the help feature.
- When the VR system does not understand your request
- When a VR session is completed successfully
- When a VR session is ended unsuccessfully
- When a speed dependent feature has been accessed
- When a new device is connected

SYNC has five different audible tones that will play depending on the circumstance.

- Initial: Sounds when you are entering a new mode.
- Positive: Sounds for a positive recognition or a successful VR session completion.
- Negative: Sounds for a negative recognition, an unsuccessful VR session, or when a speed dependent feature has been accessed.
- Listening: Sounds when the system is ready to listen for a command.
- Help: Sounds when you ask for 'Help'.

Confirmation prompts

Confirmation prompts are short questions asked by the system when the system has not clearly understood your request or when there are many

SYNC (if equipped)

possible responses to your request. For example, if you have Confirmation prompts ON, the system may say, "Phone, is that correct?". The system will then listen for a "Yes" or "No" confirmation from you. If you say "Yes", the system will proceed. If you say "No", the system will ask you to say the command again. If you have Confirmation prompts OFF, the system will simply make a best guess as to what you requested. If the system has a low confidence level of what was asked, it will prompt you to try again or ask for help.

Note: Even with Confirmation prompts turned OFF, you may be asked to confirm certain settings occasionally.

Clarification through candidate lists

Candidate lists are created when the system has several possible options of similar level of confidence as a result of your request. The system will submit back to you as many as four possibilities for your clarification. This may happen either with your phone book and/or music selections.

Example #1:

You want to call John Doe at home, so you say, "Call John Doe at home". If the system has a similar confidence level for a few items, it may respond with:

- (initial tone) "Say 1 after the tone to call John Doe at home. Say 2 after the tone to call Johnny Doe on mobile. Say 3 after the tone to call Jane Doe at home." (listen tone)

Example #2:

You want to listen to a certain artist, so you say, "Search Artist John". If the system has a similar confidence level for two possible options, it may respond with:

- (initial tone) "Say 1 after the tone to search John Doe. Say 2 after the tone to search Johnny Doe." (listen tone)

Using voice commands with your SYNC system

There is a push to talk button on your steering wheel controls labeled either VOICE or . Press to activate Voice Recognition. You will hear a tone, signaling that the system is ready to accept your command. Any command spoken prior to the beep will not register with the system. Speak the command clearly to ensure that the system is able to recognize and perform the desired function.

For the best system performance:

- Ensure that the interior of the vehicle is as quiet as possible. Wind noise from open windows, road vibrations, and radio volume may prevent the system from correctly recognizing voice commands.

SYNC (if equipped)

- Wait until the tone sounds after pressing the push to talk button before speaking a command.
- At any time, you can interrupt the system while it is speaking by pressing VOICE or . The system will respond with a listening tone and allow you to speak a command.
- Speak naturally without large pauses in between words.
- Voice recognition performance is not 100% and is meant to be a secondary convenience control. SYNC can always be operated through the navigation and steering wheel controls.

At any time, you may say these commands to change modes:

- Phone
- Cancel
- Voice settings
- Help

Phone: Say to access hands-free phone mode.

Voice Settings: Say to access the voice settings menu. Refer to *Commands for voice settings* in the following section.

Help: Say at any time for options in a specific mode. SYNC will list various options for you audibly. The 'help' request is always available.

Cancel: Say to cancel the requested action.

Commands for voice settings

In voice settings, you can customize the level of system interaction, help and feedback. The system default settings include standard interaction as well as candidate lists and confirmation prompts as all provide the most guidance and feedback.

At any time, while in voice settings, you may say these commands to adjust the voice settings:

- Interaction mode advanced
- Confirmation prompts on
- Media candidate lists on
- Phone candidate lists on
- Interaction mode standard
- Confirmation prompts off
- Media candidate lists off
- Phone candidate lists off

Interaction mode standard/advanced: Standard interaction mode provides more detailed interaction and guidance while the advanced mode has less audible interaction and more tone prompts.











Confirmation prompts on/off: Confirmation prompts are short questions asked by the system when the system has not clearly heard or understood your request. **Note:** Even with Confirmation prompts turned OFF, you may be asked to confirm settings occasionally.

SYNC (if equipped)

Phone/media candidate lists on/off: Candidate lists are a list of possible results from your voice commands. These occur when SYNC has equal confidence of several possible results from your voice command. For voice commands available in SYNC phone mode, refer to *Voice commands in phone mode* in the Phone chapter. For voice commands available in SYNC media mode, refer to *Voice commands in media mode* in the Media chapter.

Using SYNC voice commands with your navigation system

When Voice recognition (VR) is activated, the following icons will appear in the status bar.







| VR State | VR Icon |
|-------------------------------------|---|
| Main Menu |  |
| Audio system |  |
| Navigation |  |
| Voice Preferences |  |
| Display |  |
| VR Recognition Failure |  |
| VR Session Successful Completion |  |
| VR Session Unsuccessful Termination |  |
| Listening |  |
| SYNC Phone |  |
| SYNC media |  |

For the best system performance, please adhere to the following:

- The interior of the vehicle needs to be as quiet as possible. Wind noise from open windows, road vibrations, and radio volume may prevent the system from correctly recognizing voice commands.
- Wait until the tone sounds after pressing the push to talk button before speaking a command.
- Speak naturally without large pauses in between words.
- Please realize voice recognition performance is not 100% and varies by user. The voice recognition system is meant to be a secondary convenience control and if it doesn't operate optimally, you can still operate your navigation system via the touch screen and hard buttons.

SYNC (if equipped)





To speak voice commands:

1. Push the VOICE or  button on the steering wheel. A tone will sound.
2. The system will say, “Main menu” and the ‘Listening’ icon () will appear in the status bar.
3. Say “Phone” to access SYNC’s phone features or say “User Device” to access SYNC’s media features. Depending on your choice, SYNC will say “Phone” or “USB”, “Please say a command”. A tone will sound signifying SYNC is ready for your response.
4. ‘Listening’ and  will appear in the status bar and the system waits for your response.
5. If the system is not confident that it recognized your command, it will ask for a confirmation of yes or no.
6. If the system does not recognize your command, the voice failed icon  will be displayed in the status bar. The system will give you a short list of commands you can say. Say the command again. If the system doesn’t recognize the repeated command, the system will say, “Please say a command, help or cancel”.
7. If the system does not recognize your command a second time, the system will say, “I didn’t understand you, please try again.”
8. Once confirmation / recognition takes place, the voice success icon  is displayed, the system will speak the next level of available commands, a tone will sound, and the appropriate voice menu name and icon will be displayed.
9. If the voice session is not complete, the system will then speak the next set of available voice commands, a tone will sound, and the system will display ‘Listening’  and again, waits for a response.
10. This sequence of events occurs until the voice recognition session is complete.

SYNC (if equipped)

QUICK REFERENCE CHART

SYNC works with your navigation system, DVD system (if equipped), voice commands and also through your steering wheel controls. Below is a listing of the functions of your steering wheel controls and navigation bezel controls when using SYNC.

| Navigation bezel control | Steering wheel control | Function |
|--------------------------|--|---|
| N/A |   | Press to answer an incoming call. Press to send a call or text message. Press and hold to end a call. Press it initiate a redial. |
| N/A | VOICE  | Press to activate Voice Recognition. Press and hold to end an active voice session. Refer to <i>SYNC voice recognition feature</i> for further information. |
| ▲ SEEK ▼ |  | Press to access the previous/next track. |
| N/A | OK | Press to confirm your selection. |
| MEDIA | N/A | Press to access all available media sources in your vehicle, including SYNC MEDIA. For further information, refer to the <i>SYNC media features</i> chapter. |
| PHONE | N/A | Press to access SYNC PHONE features. |

SYNC phone features

QUICK START — HOW TO GET GOING

 Driving while distracted can result in loss of vehicle control, accident and injury. Ford strongly recommends that drivers use extreme caution when using any device that may take their focus off the road. The driver's primary responsibility is the safe operation of their vehicle. Only use cell phones and other devices not essential to the driving task when it is safe to do so.

Pairing your phone through your navigation system

Note: This is a speed dependent feature and will not work if your vehicle is traveling at speeds greater than 3 mph (4.82 km/h).

The first thing you will need to do to get going is to pair your *Bluetooth*® enabled cellular phone with SYNC.

1. Press PHONE on the navigation bezel.

2. The screen will read NO PHONE CONNECTED. Press SETTINGS to go to the SETTINGS tab.



3. Press ADD.

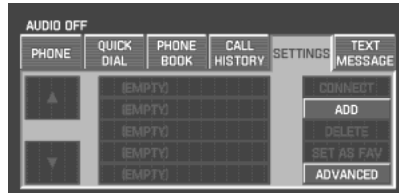

4. If *Bluetooth* is on, SYNC will begin the pairing process between your *Bluetooth* enabled phone or device and SYNC.

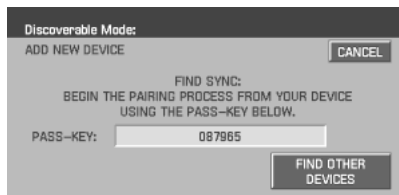

Note: Please refer to your phone's user guide for specific pairing instructions.

SYNC phone features

5. SYNC will give you a six digit Pass-key (PIN) that you will need to enter into your phone or device when prompted.

When the pairing is complete, PAIRING SUCCESSFUL and then *DEVICE NAME* CONNECTED will appear on the screen.

6. Press YES or NO when SYNC prompts you to set the phone as the FAVORITE PHONE.

As a favorite phone, SYNC will search for this phone upon each connection cycle. If a phone is not set as a primary, it will still be stored in the device listing to enable you to reconnect to it at any time.

7. If supported by your *Bluetooth* enabled cellular phone, SYNC will prompt you to download your phone book/call history. Press YES or NO.

Note: Selecting YES will tell SYNC to re-download the phone book and call history information from your *Bluetooth* enabled cellular phone (if supported) EVERY time your phone reconnects to SYNC. If you have made any changes to your phone book/call history in SYNC, they will be overwritten with the new download.

SYNC will confirm when the phone book and call history are downloaded.

Making a call using your navigation system

Making a phone call using SYNC is easy.

Press PHONE on the navigation bezel and select from one of the following:

- Use the keypad on the PHONE tab to manually enter a phone number and press SEND.



OR

SYNC phone features

- Select the PHONE BOOK tab (if the desired number is saved in the downloaded phone book information).
- Use the quick sort buttons to browse to the desired contact.
- Select the desired contact and press  DIAL.



Note: This is a phone dependent feature.

OR

- Select the CALL HISTORY tab (if the desired number is saved in the downloaded call history information).
- Select the desired contact and press  DIAL.



Note: This is a phone dependent feature.

Making a call using voice commands

1. Press  or VOICE. A tone will sound and the system will say “Main menu”.
2. Say “Phone”.
3. When prompted, say, “Call <phone book contact name> or say “Dial” and the desired number.

To erase the last spoken digit, say “Delete”.

To erase all spoken digits, say “Clear”.

4. Once the desired number/contact is on the screen, either say “Call” or “Dial”. SYNC will attempt to connect to the desired number.

Note: Once the call is placed, it will be logged into your outgoing call history folder.

SYNC phone features



USING PHONE FEATURES WITH YOUR NAVIGATION SYSTEM

While SYNC has a variety of features, many of them are dependent on your phone's functionality. To ensure that you have a compatible phone or to check which features are compatible with SYNC, please check your phone's user guide and also visit www.SyncMyRide.com.

Hands-free calling is one of the main features of SYNC. SYNC works in conjunction with your *Bluetooth* enabled cellular phone and your navigation system to offer many options. To access:

1. Press PHONE on the navigation bezel.
2. On the phone screen you can choose from:



- **SEND:** Press to receive an incoming call, make an outgoing call, or to redial.
- **END:** Press to end or ignore a call.
- **PRIVACY MODE:** Press to activate privacy mode. During an active phone call with SYNC, you can choose to transfer the call to your *Bluetooth* enabled cellular phone for a private conversation.
Note: This is a phone dependent feature.
- **HOLD CALL:** Press to put an active call on hold to have a private conversation within your vehicle cabin. Press again to take off hold.
Note: This is a phone dependent feature.
- **JOIN CALLS:** Press to join two active calls.
Note: This is a phone dependent feature.
- **Digit entry:** Press the numbers to manually enter a phone number to call.
- **Signal/battery strength and roaming status**
Note: This is a phone dependent feature.
-  : Press to see additional numbers or information (if available).
-  : This *Bluetooth* icon illuminates when a *Bluetooth* enabled phone is connected to SYNC.

SYNC phone features

SAVING A CONTACT OR A PHONE NUMBER AS A QUICK DIAL

After you have connected your *Bluetooth* enabled cellular phone and downloaded your phone book/call history, SYNC allows you to save 10 frequently called numbers for quick access.

1. Press PHONE on the navigation bezel.
2. Press the PHONE BOOK or CALL HISTORY tab.
3. Select the phone number or the contact you wish to save to the Quick Dial screen.
4. Press SAVE.
5. Select the Quick Dial location in which you wish to store the contact.
6. Press SET/REPLACE at the bottom of the screen to save the contact's number to the chosen Quick Dial location.

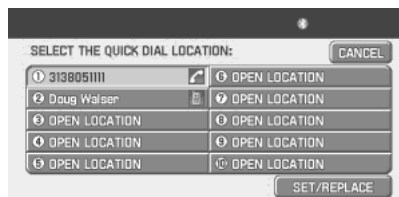

The system will confirm when the number of the contact is successfully stored.

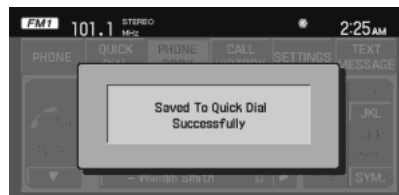

Using Quick Dial numbers

1. Press PHONE on the navigation bezel.
2. Select the QUICK DIAL tab to access saved numbers. The icon to the right of the contact's name will identify the location of the respective contact (i.e. home, work, cell, etc). The number to the left of the name will identify the Quick Save location.



Note: The location icon is a phone dependent feature.

3. Select the desired contact to initiate a call.

SYNC phone features

Replacing contacts in your Quick Dial locations

SYNC allows you to replace contacts in your Quick Dial section.

1. Press PHONE on the navigation bezel.
2. Press the PHONE BOOK or CALL HISTORY tab to select the desired contact or number with which to replace an existing contact or number saved to a Quick Dial.
3. Select the number or the contact you wish to save to the Quick Dial screen.
4. Press SAVE.
5. Select the location in which to place the desired contact or number and press SET/REPLACE at the bottom of the screen.
6. Select the location in which you wish to replace the current one.

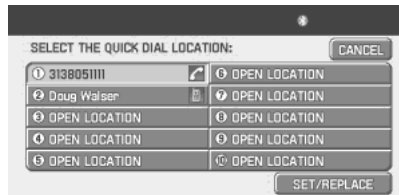

The system will prompt you to confirm the replacement.



USING THE PHONE BOOK FEATURE

Note: This is a speed dependent feature. The vehicle must be moving less than 3 mph (4.82 km/h) to use this feature.

SYNC enables you to view the contacts downloaded from your *Bluetooth* enabled cellular phone. To access:

1. Press PHONE on the navigation bezel.

SYNC phone features

2. Select the PHONE BOOK tab to access the phone numbers of the contacts downloaded from your *Bluetooth* enabled cellular phone.

Note: SYNC will categorize your contacts alphabetically in the Quick Sort buttons on the right of the screen. The buttons will be

highlighted if there are contacts stored in that category. Press the highlighted category to access those listings.

For your safety, while you are driving, SYNC limits the number of viewable contacts. However, all contacts are always available through voice commands.

Note: If supported by your phone, SYNC will assign location icons for the numbers (i.e., cellular number, home number).



USING YOUR CALL HISTORY

If your *Bluetooth* enabled cellular phone supports phone book/call history downloads via *Bluetooth*, SYNC will provide these numbers sorted in the CALL HISTORY tab. If your *Bluetooth* enabled cellular phone does NOT support phone book/call history downloads via *Bluetooth*, then SYNC will log all calls made through SYNC in the CALL HISTORY tab.

1. Press PHONE on the navigation bezel.

2. Select the CALL HISTORY tab which allows you to have quick access to recent call activity.



Press OUTGOING to view your outgoing calls.

Press INCOMING to view your incoming calls.

Press MISSED to view your missed calls.

SYNC phone features

SYSTEM SETTINGS

SYNC allows you to connect, add, delete or set specified phones as a favorite as well as change advanced settings.

To access:

1. Press PHONE on the navigation bezel.
2. Select the SETTINGS tab and then choose the desired device. You can now choose from the following options:



CONNECT

ADD

DELETE

SET AS FAV (Favorite)

ADVANCED

Please refer to the following sections for more information on these features.

Connecting a previously paired phone to SYNC

1. Press PHONE on the navigation bezel.
2. Select the SETTINGS tab.
3. Select the desired device.
4. Press CONNECT.



SYNC will confirm it is connecting to the selected phone.

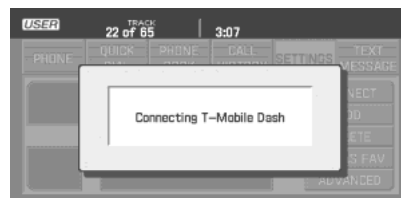

Note: When SYNC connects the newly selected phone, it will disconnect the previously connected phone.

SYNC phone features

Adding a new phone to SYNC

Note: This is a speed dependent feature. For your safety, this procedure cannot be completed if the vehicle is traveling at speeds faster than 3 mph (4.82 km/h).

Note: SYNC can store up to 12 previously paired phones.

This feature allows you to add (pair) a new *Bluetooth* enabled phone to SYNC. To access:

1. Press PHONE on the navigation bezel.
2. Select the SETTINGS tab.
3. Press ADD.



4. When prompted on your phone's display, enter the PIN provided by SYNC.

Depending on your phone's capability, you may be prompted with additional options from your phone or SYNC such as downloading the phone book/call history and setting a favorite.

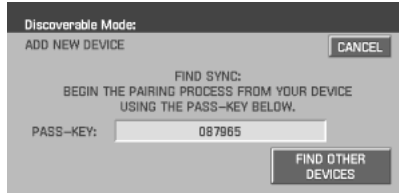

Deleting a phone from SYNC

This feature allows you to delete a previously paired phone from SYNC.

Note: Deleting your phone will remove all information relevant to that phone such as phone book/call history, text messages, etc.

1. Press PHONE on the navigation bezel.
2. Select the SETTINGS tab.
3. Select the desired phone.
4. Press DELETE. The system will ask you to confirm.



SYNC phone features

Setting a phone as your favorite

SYNC allows you to set a phone as your favorite. This will then be the primary phone that SYNC reconnects to after each ignition cycle.

To access:

1. Press PHONE on the navigation bezel.
2. Select the SETTINGS tab.
3. Select the desired device.
4. Press SET AS FAV.



Note: A star icon (☆) will appear to the left of the currently selected favorite phone, and a double arrow icon (↔) will appear to the right of the currently connected phone.

Advanced settings

SYNC allows you to change many Advanced Settings.

To access:

1. Press PHONE on the navigation bezel.
2. Select the SETTINGS tab.
3. Press ADVANCED.



4. Scroll using ▲ / ▼ on the navigation screen to cycle through the following options:

- **Bluetooth On/Off**
- **Incoming Call Ringer**
- **Text Message Notification**
- **Automatic Download On/Off**
- **Modify Phonebook**

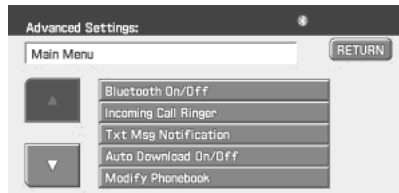

SYNC phone features

- **Provider**
- **Prompts On/Off**
- **Factory Defaults**
- **Master Reset**
- **Install**

- **System Information**

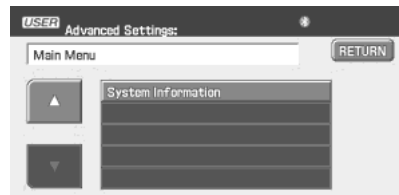
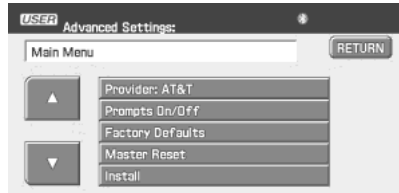

Turning Bluetooth on/off

Turning *Bluetooth* OFF will turn off access to all features to all SYNC *Bluetooth* related features (i.e., text messaging, hands-free calling, *Bluetooth* media streaming). Any incoming text or phone messages will go into their respective missed folders.

To access:

1. Press PHONE on the navigation bezel.
2. Select the SETTINGS tab.
3. Press ADVANCED.

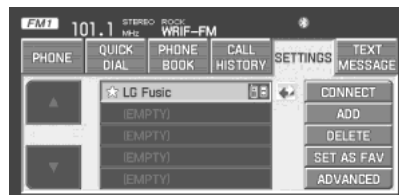

4. Select 'Bluetooth On/Off'.

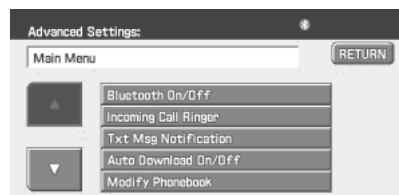

SYNC phone features

5. Select On or Off.

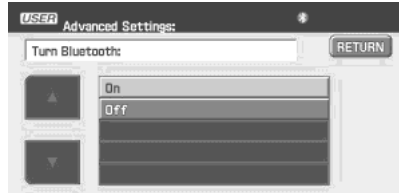

Selecting your ring tone

SYNC allows you to select from various ringers which will sound during an incoming call. To access:

1. Press PHONE on the navigation bezel.
2. Select the SETTINGS tab.
3. Press ADVANCED.



4. Scroll using ▲ / ▼ on the navigation screen and select 'Incoming Call Ringer'.

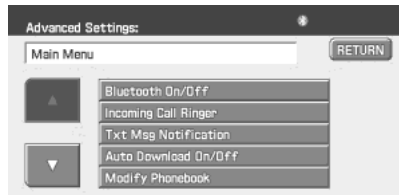

5. Select from three ring tones, your cellular phone's ring tone or to turn the ringer off.

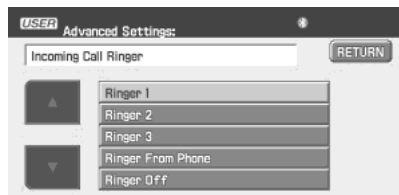

SYNC phone features

Turning the text message notification on/off

You can choose to turn SYNC's text message notification on or off. To access:

1. Press PHONE on the navigation bezel.
2. Select the SETTINGS tab.
3. Press ADVANCED.



4. Select 'Txt Msg Notification' and turn the feature on or off.

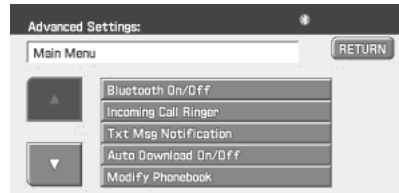

Press YES to turn text message notification on. With notifications turned on, an audible tone sounds during an incoming text message and response options appear in the display (i.e., view the message, have the system read the message aloud, dial the person sending the message or cancel).

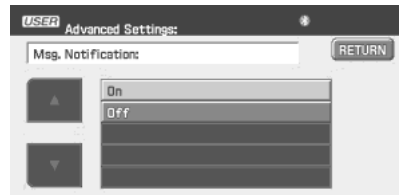

Press NO to turn text notifications off. With notifications turned off, you will not be notified by a tone and the incoming text message will not appear on screen.

Selecting automatic downloading

If you choose, SYNC will automatically download your phone book and call history from your connected *Bluetooth* enabled cellular phone upon every connection cycle. This automatic download will overwrite your existing phone book and call history stored in SYNC.

To access:

1. Press PHONE on the navigation bezel.

SYNC phone features

2. Select the SETTINGS tab.
3. Press ADVANCED.



4. Select 'Auto Download On/Off'.

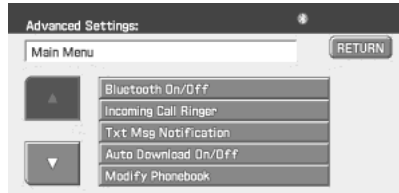

5. Select On or Off.

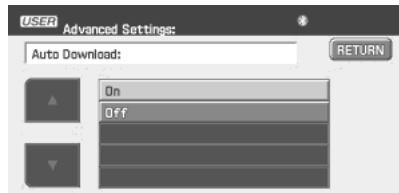

Modifying your phone book and call history

SYNC allows you to add contacts as well as download and delete your phone book/call history.

Note: Erasing a contact or all contacts in your phone book/call history in your SYNC system will NOT erase any information in your cellular phone. To access:

1. Press PHONE on the navigation bezel.
2. Select the SETTINGS tab.
3. Press ADVANCED.



SYNC phone features

4. Select 'Modify Phonebook' and select from:

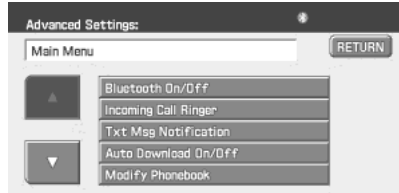

ADD CONTACTS: Select to 'push' contacts from your *Bluetooth* enabled cellular phone. SYNC will prompt you to send the contacts from your phone. When successfully sent, the display will read XXX CONTACTS RECEIVED FINISHED?

Press YES if you are finished or press NO if you wish to send more contacts to SYNC.

Note: Pushing contacts via *Bluetooth* is a phone dependent feature. Refer to your phone's user guide for instructions.

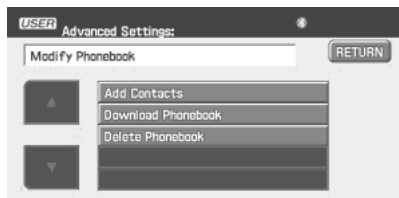

DOWNLOAD PHONE BOOK / CALL HISTORY: Select YES to automatically download the phone book/call history from your currently connected *Bluetooth* enabled cellular phone. Select NO and the system will not perform this function upon every connection cycle.

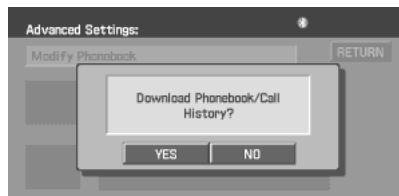

DELETE PHONE BOOK / CALL HISTORY: Select YES to delete the entire phone book/call history from SYNC. **Note:** This function will NOT delete any information from your connected *Bluetooth* enabled cellular phone.

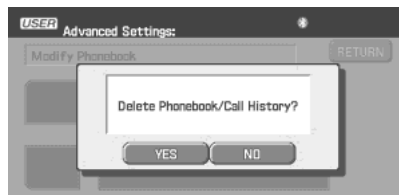

SYNC phone features

Viewing your phone's provider

Note: This is a phone dependent feature.

To view your phone's provider through SYNC:

1. Press PHONE on the navigation bezel.
2. Select the SETTINGS tab.
3. Press ADVANCED.

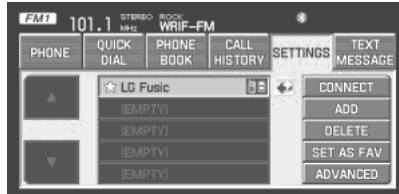

4. Scroll using ▲ / ▼ on the navigation screen until 'Provider' appears.

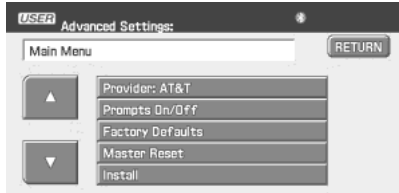

Choosing prompts on/off

SYNC is equipped with an advanced voice recognition system which can perform a multitude of tasks. For example, SYNC's voice recognition system will ask for clarification if it does not have a high level of confidence in what was spoken. The level of feedback which SYNC provides can be adjusted. You can choose a higher level of verbal prompts for more guidance or you can choose to simply hear the prompts when the system needs direction.

To access:

1. Press PHONE on the navigation bezel.
2. Select the SETTINGS tab.
3. Press ADVANCED.



SYNC phone features

4. Scroll using ▲ / ▼ on the navigation screen and select 'Prompts On/Off'.

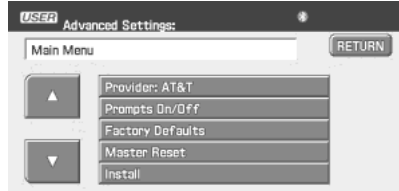

5. Select 'On' for a higher level of voice interaction or 'Off' to turn off the voice prompts.

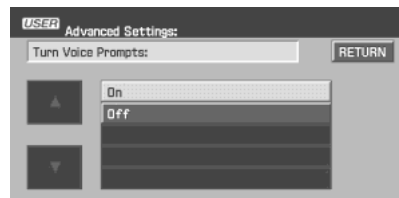

Returning to the factory default settings

SYNC allows you to return to its factory default settings. This selection will not erase your downloaded phone book/call history, text messages, etc. If you wish to erase all information, refer to *Performing a master reset* in the following section.

To access:

1. Press PHONE on the navigation bezel.
2. Select the SETTINGS tab.
3. Press ADVANCED.



4. Scroll using ▲ / ▼ on the navigation screen and select 'Factory Defaults'.

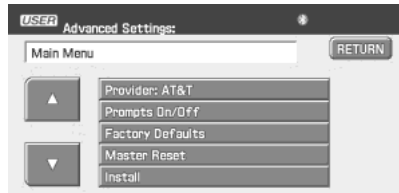

SYNC phone features

5. SYNC will ask you to confirm your selection. Press YES and the system will confirm FACTORY DEFAULTS RESET.



Performing a master reset

Performing a master reset will not only return all preference settings to the factory defaults, but it will also completely erase all phone book, call history and text messages previously downloaded to SYNC. To access:

1. Press PHONE on the navigation bezel.
2. Select the SETTINGS tab.
3. Press ADVANCED.



4. Scroll using ▲ / ▼ on the navigation screen and select 'Master Reset'.

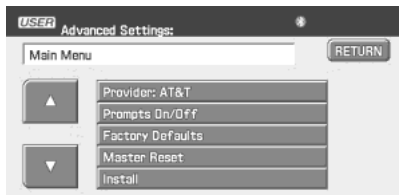

5. SYNC will ask you to confirm. Press YES to continue.

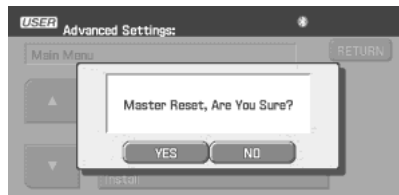

SYNC phone features

SYNC will confirm when the reset is complete.

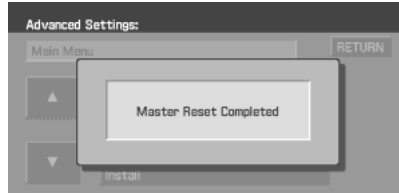

Installing a new application

You can download new software applications (if available) and then load the desired applications onto SYNC through your USB port. Please refer to www.SyncMyRide.com for more information.

To install any downloaded software:

1. Press PHONE on the navigation bezel.
2. Select the SETTINGS tab.
3. Press ADVANCED.



4. Scroll using ▲ / ▼ on the navigation screen and select 'Install'. Follow the prompts.

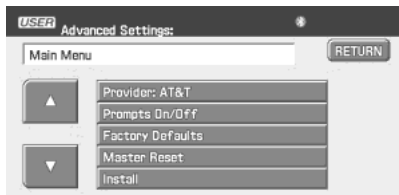

Accessing system information

To access SYNC system information:

1. Press PHONE on the navigation bezel.

SYNC phone features

2. Select the SETTINGS tab.
3. Press ADVANCED.



4. Scroll using ▲ / ▼ on the navigation screen and select 'System Information'.

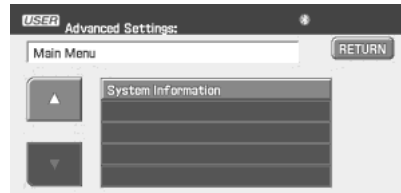

This screen will show you SYNC's system information.

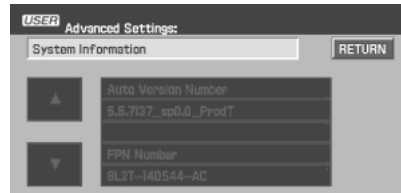

TEXT MESSAGING ✉

Note: Downloading and sending text messages via *Bluetooth* are phone dependent features.

Note: Certain features in text messaging are speed dependent and cannot be completed when the vehicle is traveling at speeds over 3 mph (4.82 km/h).

SYNC not only enables you to send and receive text messages via *Bluetooth*, but SYNC will read them to you aloud and also translate many popularly used text messaging acronyms such as "lol". SYNC also allows you to respond with a list of predefined messages.

To access:

1. Press PHONE on the navigation bezel.

SYNC phone features

2. Select the TEXT MESSAGE tab. SYNC will automatically check to see if the currently connected phone supports text messaging. If it does not, this screen will display.

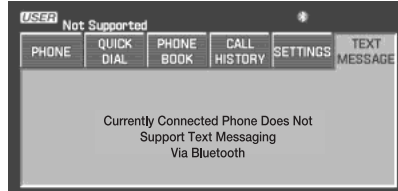

3. If your phone is equipped for text messaging, SYNC will take you to the text messaging screen. From this screen you will be able to select from the following options:



VIEW: Select the desired text message and press VIEW to view the text message.

Note: For your safety, this is a speed dependent feature.

LISTEN: Select desired message and press LISTEN to have the system read the text message to you aloud.

COMPOSE: Select to compose a new text message.

Note: For your safety, this is a speed dependent feature.

DELETE ALL: Select to delete all text messages from SYNC.

Note: This will not delete all messages from your *Bluetooth* enabled cellular phone.

DOWNLOAD: If your phone supports downloading text messages via *Bluetooth* wireless technology, you can download your unread text messages to SYNC.

Note: SYNC does not download read text messages from your phone.

SYNC phone features

Receiving an incoming text message

When there is an incoming text message, an audible tone will sound and the screen will display a pop up with the caller name and ID if the caller is saved in your phone book.



Press VIEW to view the text message.

Press LISTEN for SYNC to read the message to you aloud.

Press REPLY to send a reply text message.

Press DIAL to call the contact.

Press CANCEL to exit the screen.

From the VIEW screen, you can then choose to:

- **LISTEN** as SYNC reads the message to you aloud.
- **COMPOSE** your own message.
- **REPLY** to the message.
- **FORWARD** the text message to someone in your phone book or to a phone number.

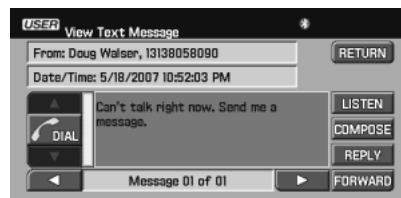

Sending a text message

Note: Sending text messages via *Bluetooth* is a phone dependent feature.

Note: This is a speed dependent feature and cannot be completed when the vehicle is traveling at speeds over 3 mph (4.82 km/h).

1. Press PHONE on the navigation bezel.

SYNC phone features

2. Select the TEXT MESSAGE tab.
3. Press COMPOSE.



4. Scroll using ▲ / ▼ on the navigation screen to cycle through a list of 15 predefined text messages you can send from SYNC.

- Can't talk right now
- Call me
- Call you later
- Be there in 10 minutes
- Be there in 20 minutes
- Yes
- No
- Why?
- Thanks
- Where R you?
- I need more directions
- I love you
- Too funny
- Can't wait to see you
- I'm stuck in traffic

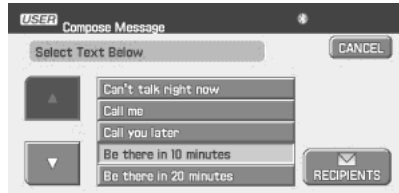





5. Select the desired text message. In addition to your text, the message will also contain a signature of : "This message was sent from my *Ford, Lincoln or Mercury* vehicle."

SYNC phone features

6. Press  RECIPIENTS. SYNC will now allow you to choose to whom you would like to send your text message.

Note: Only one recipient per text message is allowed.

7. Press PHONE BOOK to access your phone book listings. Press  /  to cycle through the contacts. Press the desired contact and press  SEND.

Press PHONE NUMBER to send your text message to a phone number (which is not listed with a contact in your phone book/call history). Use the dial pad to manually enter the desired number. Once the number is entered, press  SEND.

SYNC will ask you to confirm. Press  SEND.

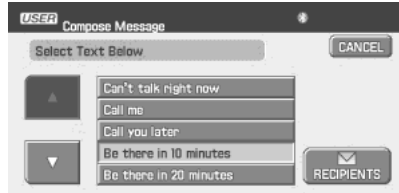

SYNC phone features

Forwarding a text message

Note: Forwarding text messages via *Bluetooth* is a phone dependent feature.

Note: This is a speed dependent feature and cannot be completed when the vehicle is traveling at speeds over 3 mph (4.82 km/h).

1. Press PHONE on the navigation bezel.
2. Select the TEXT MESSAGE tab.
3. Press COMPOSE.



4. Scroll using ▲ / ▼ on the navigation screen to select one of SYNC's 15 predefined text messages.



5. Press ✉ RECIPIENTS.

SYNC will now allow you to choose to whom you would like to send your text message.

Note: Only one recipient per text message is allowed.

6. Press PHONE BOOK to access your phone book contacts. Select the desired contact and press ✉ SEND.



SYNC will ask you to confirm. Press ✉ SEND.



SYNC phone features

VOICE COMMANDS IN PHONE MODE



Driving while distracted can result in loss of vehicle control, accident and injury. Ford strongly recommends that drivers use extreme caution when using any device that may take their focus off the road. The driver's primary responsibility is the safe operation of their vehicle. Only use cell phones and other devices not essential to the driving task when it is safe to do so.

In phone mode, you may say any of the following commands:

- Dial
- Call *<name>* at home
- Call *<name>* at work OR call *<name>* in office
- Call *<name>*
- Call *<name>* on mobile OR cell
- Call *<name>* on other

Note: In the above possible commands, “*<name>*” is a dynamic listing in that it could be any desired name from your phone book, call history, etc.

Note: With the above commands, words in () are optional and do not have to be spoken for the system to understand the command.

In phone mode, you can say “Dial” to access any of the following commands:

- *Number* 0–9
- Delete (deletes one digit)
- Plus
- Asterisk (*)
- 700 (seven hundred)
- 411 (four-one-one), 911 (nine-one-one), etc.
- Dial
- Clear (deletes all entered digits)
- Star
- 800 (eight hundred)
- 900 (nine hundred)
- # / (pound, slash)

In phone mode, you may say these commands at any time:

- Phone
- Cancel
- Voice settings
- Help

SYNC media features

HOW TO GET GOING WITH SYNC MEDIA

 Driving while distracted can result in loss of vehicle control, accident and injury. Ford strongly recommends that drivers use extreme caution when using any device that may take their focus off the road. The drivers primary responsibility is the safe operation of their vehicle. Only use cell phones and other devices not essential to the driving task when it is safe to do so.

Connecting your digital media player to SYNC

1. Ensure that the vehicle and navigation system are ON.
2. Plug the media device into the USB port and ensure that the device is ON. (Refer to your vehicle's *Owner's guide* for exact USB port location.)
3. Press MEDIA on the navigation bezel.
4. Select the USER DEVICE tab.
5. Press SOURCE repeatedly until USB appears.
6. Press MUSIC LIBRARY.



7. Select from the listed features. Please refer to *Using the Media Music Library* later in this chapter.



SYNC media features

Connecting your digital media player to SYNC via voice commands

1. Ensure that the vehicle and navigation system are ON.
2. Plug the media device into the USB port and ensure that the device is ON. (Refer to your vehicle's *Owner's guide* for exact USB port location.)
3. Press VOICE or . SYNC will say, "Main menu" and the listening icon will appear in the display.
4. Say "User Device". The system will say, "USB, please say a command."

SYNC will begin indexing the music media when the device is plugged into the USB port. If your digital media player contains many media files, INDEXING may appear in the display. When the indexing process is complete, you may access the media content in your digital media player using voice commands.

5. Once the music is indexed, you can play music on your digital media player by saying any of the following commands:

- Play All
- Play Artist *<name>*
- Play Album *<name>*
- Play Genre *<name>*
- Play Playlist *<name>*
- Play track *<name>*

SYNC MEDIA SOURCES AND FEATURES

The USER DEVICE tab provides you access and control over the SYNC media sources: USB, BT AUDIO and LINE IN. Once you choose which SYNC media source you would like to listen to, you can then use SYNC's many other features to make playing adjustments.

To access:

1. Ensure that your playing device is plugged into the USB port or Auxiliary input jack (LINE IN) and is ON.
Note: If you already have a device connected to the USB port, you cannot access the LINE IN feature. Some digital media players require both USB and LINE IN ports to stream data and music separately.
2. Press MEDIA on the navigation bezel.

SYNC media features

3. Select the USERS DEVICE tab.
4. Press SOURCE repeatedly to cycle through the possible media sources of USB, BT AUDIO and LINE IN.

You can also access the following buttons:



- **MUSIC LIBRARY:** Provides you access to SYNC's many media features, such as: Play All, Play Artists, Play Albums, Play Tracks, Play Playlists, and Explore the USB.
- **SIMILAR MUSIC:** In USB mode, select to have SYNC create a new playlist of music similar to the currently playing track.
- **REPEAT:** Select to repeat the current track in USB mode.
- **SHUFFLE:** Select to shuffle the current tracks in USB mode.
- **SETTINGS:** Refer to *Advanced settings* in the *SYNC phone features* chapter for information on how to make adjustments to the prompts, language, master reset, factory defaults, etc.
- **TEXT:** Press to view additional information, if available.

ACCESSING AND USING YOUR USB PORT

Your vehicle is equipped with a USB port. (For exact location, refer to your vehicle's *Owner's guide*). You can use the USB port to plug in and access media devices as well as charge devices (if supported by your device). For a list of compatible media players, refer to www.SyncMyRide.com.

Note: Since your USB port allows you to charge your device (if supported by your device), SYNC will not automatically change media modes when something is initially plugged into the USB port. To access:

1. Ensure that your digital playing device is plugged into the USB and is ON.
2. Press MEDIA on the navigation bezel.

SYNC media features

3. Select the USER DEVICE tab.
4. Press SOURCE repeatedly to until USB appears in the line above SOURCE.



If the connected device and media content is supported, SYNC will begin indexing available media files. NO MEDIA will appear if there are no readable media files for SYNC to play. If there are readable files, INDEXING may appear. If Autoplay is ON, SYNC gives you the ability to access media files randomly as they are indexed. If Autoplay is OFF, indexed media is not available until the indexing process is complete. After indexing is complete, INDEXED will appear.

Once indexing is complete, you may press ◀◀ / ▶▶ to access the previous/next track. You may also press ▶ / || to play/pause the current track.

Note: SYNC is capable of indexing thousands of average size media files. The time required to complete the indexing process is dependent upon the size of the media content being indexed.

If at any time the device is removed from the USB port, USB REMOVED will appear.



SYNC media features

Supported media players, formats and metadata information

SYNC is capable of hosting nearly any digital media player, including iPod®, Zune™, “Plays from device” players, and most USB drives. Supported audio formats include MP3, WMA, WAV and AAC.

SYNC is also able to organize and sort your indexed media from your playing device by metadata tags. Metadata tags are descriptive software identifiers embedded in your media files which provide information about the media file. SYNC supports the following metadata tags:

- Artist
- Album
- Genre
- Track

If your indexed media files contain no information embedded in these metadata tags, SYNC will automatically classify the empty metadata tags as UNKNOWN.

What’s playing?

At any time while a track is playing, SYNC will read the metadata tags of the track to you (if populated). Simply press **VOICE** or **VOICE**. A tone will sound and SYNC will say “Main menu”. Say “USER DEVICE” and, when prompted, ask “What’s playing?”

STREAMING MUSIC FROM YOUR BLUETOOTH ENABLED PHONE

Note: This is a phone dependent feature. Refer to your phone’s user guide for further information on how to stream *Bluetooth* audio.

SYNC allows you to stream music from your *Bluetooth* enabled cellular phone to play through SYNC. To access:

1. Ensure that the desired music is playing on your paired phone and your phone is in *Bluetooth* audio streaming mode.
2. Press MEDIA on the navigation bezel.

SYNC media features

3. Select the USER DEVICE tab.



4. Press SOURCE repeatedly to until BT AUDIO appears in the line above SOURCE.

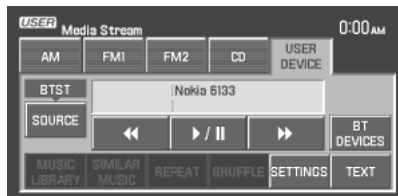

USING LINE IN (AUXILIARY INPUT JACK) WITH SYNC

Your vehicle is equipped with an auxiliary input jack which allows you to plug in and play your portable music player over the vehicle speakers. For exact location of your auxiliary input jack, refer to your vehicle's *Owner's guide*.

To access:

Note: If you already have a device connected to the USB port, you cannot access the LINE IN feature. Some digital media players require both USB and LINE IN ports to stream data and music separately.

1. Ensure that the desired device is plugged into the Auxiliary input jack and is playing.
2. Press MEDIA on the navigation bezel.
3. Select the USER DEVICE tab.



SYNC media features

4. Press SOURCE repeatedly to until LINE IN appears in the line above SOURCE. The music will begin to play over the vehicle's speakers.



USING THE MEDIA MUSIC LIBRARY

Once your music has been indexed into SYNC through the USB port, you can then use the many features of the media library. To access:

1. Press MEDIA on the navigation bezel.
2. Select the USER DEVICE tab. Press SOURCE repeatedly until USB appears in the display.
3. Press MUSIC LIBRARY.



From this screen, you can access the following:

- **Play All**
- **Artists**
- **Albums**
- **Genres**
- **Playlists**
- **Tracks**
- **Explore USB**



SYNC media features

Accessing the Play All feature

The Play All feature in SYNC will play all indexed media (tracks) from your playing device in flat file mode, one at a time in alphabetical order. To access:

1. Press MEDIA on the navigation bezel.
2. Select the USER DEVICE tab.
3. Press SOURCE repeatedly until USB appears in the display.
4. Press MUSIC LIBRARY.



5. Scroll using ▲ / ▼ on the navigation screen to select 'Play All'.



Selecting and playing specific artists

SYNC allows you to sort all indexed media by artists. To access:

1. Press MEDIA on the navigation bezel.
2. Select the USER DEVICE tab.
3. Press SOURCE repeatedly until USB appears in the display.
4. Press MUSIC LIBRARY.



5. Scroll using ▲ / ▼ on the navigation screen and select 'Artists'.



SYNC media features

SYNC will allow you to scroll through all indexed artists and select which you would like to hear.

Selecting and playing specific albums

SYNC allows you to play all indexed media by ALBUMS. To access:

1. Press MEDIA on the navigation bezel.
2. Select the USER DEVICE tab.
3. Press SOURCE repeatedly until USB appears in the display.
4. Press MUSIC LIBRARY.



5. Scroll using ▲ / ▼ on the navigation screen and select 'Albums'.
6. Use ▲ / ▼ to scroll through and select the desired album to play.



Selecting from different genres

SYNC allows you to sort indexed music by genre (category) type. SYNC will automatically re-categorize your indexed music according to the available genre metadata tags. To access:

1. Press MEDIA on the navigation bezel.
2. Select the USER DEVICE tab.
3. Press SOURCE repeatedly until USB appears in the display.
4. Press MUSIC LIBRARY.



SYNC media features

5. Scroll using ▲ / ▼ on the navigation screen and select 'Genres'.



Accessing your playlists

SYNC supports many playlists formats, such as: .ASX, .M3U, .WPL and .MTP. To access:

1. Press MEDIA on the navigation bezel.
2. Select the USER DEVICE tab.
3. Press SOURCE repeatedly until USB appears in the display.
4. Press MUSIC LIBRARY.



5. Scroll ▲ / ▼ using on the navigation screen and select 'Playlists'.

6. Scroll using ▲ / ▼ to select the desired playlist.



Playing a specific track

SYNC allows you to search for and play a specific track which has been indexed. To access:

1. Press MEDIA on the navigation bezel.

SYNC media features

2. Select the USER DEVICE tab.
3. Press SOURCE repeatedly until USB appears in the display.
4. Press MUSIC LIBRARY.



5. Scroll using ▲ / ▼ on the navigation screen and select 'Tracks' to view your indexed tracks.
6. Scroll using ▲ / ▼ and select the desired track to play.



Exploring the USB device

SYNC allows you to explore through all supported digital media on your media device which is connected through the USB port. To access:

1. Press MEDIA on the navigation bezel.
2. Select the USER DEVICE tab.
3. Press SOURCE repeatedly until USB appears in the display.
4. Press MUSIC LIBRARY.



5. Scroll using ▲ / ▼ on the navigation screen and select 'Explore USB'.



SYNC media features

6. Use ▲ / ▼ to scroll through all indexed media on your USB device.

Note: Media can be played directly through the Explore USB feature by selecting the desired track or by selecting PLAY ALL.



Note: When you are playing USB SYNC MEDIA using the Explore USB feature, and you have folders saved on your playing device, you are in folder mode. In folder mode, you can say, “Play next folder” or “Play previous folder” to advance within your saved folders.

Accessing your BT Devices menu and features

The BT DEVICES menu allows you to connect, add and delete *Bluetooth* devices from SYNC.

To access:

1. Press MEDIA on the navigation bezel.
2. Select the USER DEVICE tab.
3. Press BT DEVICES.



4. Select from available options of:

- **CONNECT:** Select to connect a previously paired device to SYNC.
- **ADD:** Select to add a device through Discovery and Discoverable modes. Refer to *Adding a new device in discovery or discoverable mode* in the following section.
- **DELETE:** Select to delete a previously paired device.
- **ADVANCED:** Refer to *Advanced Settings* in the *SYNC phone features* chapter for information on how to make adjustments to advanced settings.

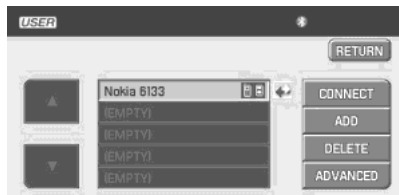

SYNC media features

Adding a new device in discovery or discoverable mode

1. Press MEDIA on the navigation bezel.
2. Select the USER DEVICE tab.
3. Press BT DEVICES.



4. Select ADD.

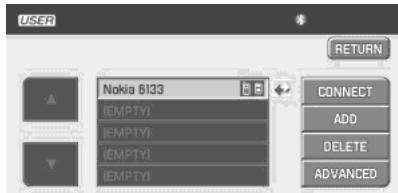

5. If your device supports discoverable mode, enter the PIN given by SYNC. If your device supports discovery mode, press FIND OTHER DEVICES.

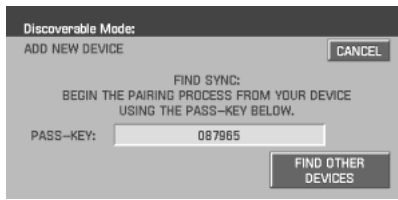

6. Select the desired device.

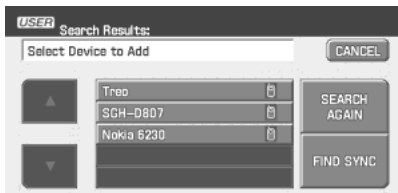

7. SYNC will take you to the NEW DEVICE menu. Enter the PIN given by your device into SYNC via the touch pad and press ENTER.

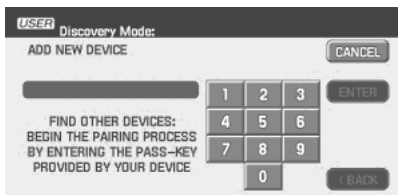

SYNC media features

VOICE COMMANDS WHEN USING THE USB PORT



Driving while distracted can result in loss of vehicle control, accident and injury. Ford strongly recommends that drivers use extreme caution when using any device that may take their focus off the road. The driver's primary responsibility is the safe operation of their vehicle. Only use cell phones and other devices not essential to the driving task when it is safe to do so.

When using the USB port, you may say “User Device” and, when prompted, any of the following commands:

- Play all
- Pause
- Similar music
- Play previous track
- Shuffle
- Autoplay on
- Repeat off
- Play album <name>
- Play genre <name>¹
- Play track <name>¹
- Play
- What's playing?
- Play next track
- Play next folder²
- Play previous folder²
- Autoplay off
- Repeat on
- Play playlist <name>¹
- Play artist <name>¹

¹ Voice commands are not available until indexing is complete.

² Voice commands only available in folder mode. For more information, refer to *Exploring the USB device*.

Note: In the above possible commands, “name” is a dynamic listing in that it could be the name of any desired group, artist, etc.

Autoplay: With this feature ON, SYNC will automatically begin to play your music as it is being indexed. As the system is finishing indexing all of your songs, you can listen to music. With this feature OFF, SYNC will not begin to play any of your music until it has all been indexed.

Note: The larger the number of songs SYNC has to index, the longer indexing will take.

Play Genre: You can play a specific genre (type) of music. SYNC will read all the data from your indexed music and, if available, will begin to play that type of music.

Note: You can only play genres of music which are present in the music you have indexed to SYNC.

Similar music: You can tell SYNC to play music ‘similar’ to what you are currently playing.

SYNC media features

Voice commands when in Bluetooth audio mode

When in Bluetooth audio mode, you may use the following commands:

- Play
- Play next track
- Pause
- Play previous track

Note: Please refer to your device's user guide to see if these commands are supported for *Bluetooth* audio.

At any time, you may say these commands:

- User Device
- Help
- Line in
- Phone
- Cancel

Voice commands while using Line in

While using the Line in feature (Auxiliary input jack), you may speak the following commands:

- Cancel
- Line in

ACCESSING SYNC MEDIA FEATURES THROUGH YOUR DVD SYSTEM (IF EQUIPPED)

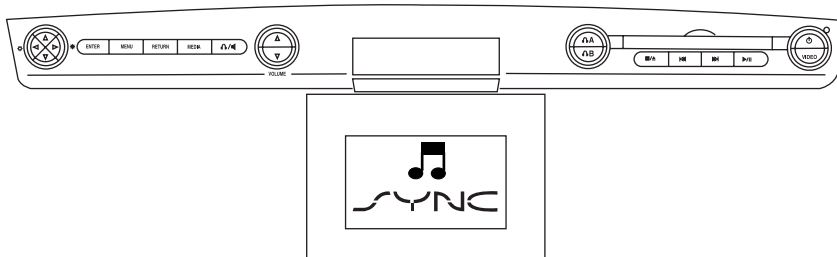

Rear seat passengers can listen to SYNC media sources (USB, BT AUDIO, LINE IN) through the DVD system (if equipped).

To access:

1. Ensure that:

- The DVD and audio system are ON.
- Your digital media playing device is plugged into the USB port or SYNC's Auxiliary input jack (Line in), if desired.

SYNC media features

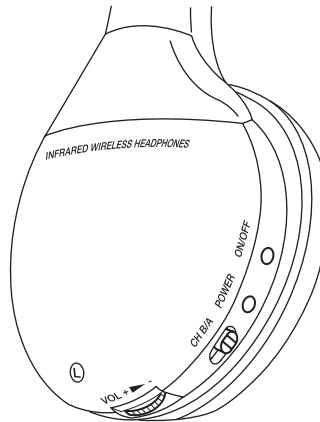

- Your *Bluetooth* enabled cellular phone from which you wish to stream music is ON and is currently paired to SYNC as a *Bluetooth* Device.

2. Ensure that your wireless headphones are set to Channel A. (Channel A can access any possible media source: AM, FM1, FM2, SAT (satellite radio, if equipped), CD, DVD, AUX, SYNC (USB, BT AUDIO and LINE IN). Channel B can only access DVD and AUX sources.)



3. Press  A on the DVD system to gain access to your possible media selections.



4. Press MEDIA (on the DVD system or on the remote control) repeatedly until SYNC appears on the DVD screen in the  A status bar. (You cannot access SYNC through  B.) Either press ENTER or wait until the system times out.

After choosing the SYNC media source, you can then choose from the media settings (Shuffle, Repeat, Autoplay) as well as choosing from these options: Play All music, Play Artists, Play Albums, Play Genres, Play tracks, Explore the USB device or accessing/playing your Playlists.

SYNC media features

You can use the following remote controls to help make SYNC menu selections:

- Use the cursor controls (▲ / ▼ / ◀ / ▶) to make menu selections.
- Press ENTER to confirm a selection.
- Press ◀◀ / ▶▶ to reverse/advance to the next track.

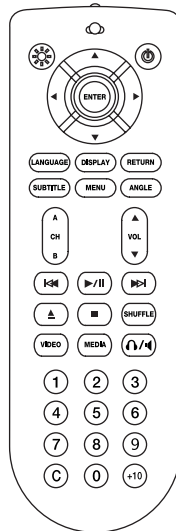

Note: Once SYNC USB is chosen, SYNC will begin indexing your media information. Depending on how much supported media content there is, this process may take a few minutes. You can, however, choose to activate the Autoplay feature which will begin playing the first song as soon as possible so that you will not have to wait until all of the music is indexed prior to playing.

Media menu

Once you have chosen a SYNC media source from which to play, you can then make playing selections through the Media Menu.

- From the main screen, select 'Menu'.



SYNC media features

- Then select 'Media Menu' to choose from:



Play Menu: Choose how to play your SYNC USB media. Access Play All, Artists, Albums, Tracks, Genres, Playlists and Explore USB.

Select Source: Choose another SYNC media source (USB, BT AUDIO, LINE IN).

Media Settings: Choose to activate/deactivate Shuffle, Repeat or Autoplay.

Play menu

The Play Menu gives the choice of how to play music from your SYNC media source. To access:

- From the main screen, select 'Menu'.



Select 'Play Menu'.



SYNC media features

Select from:



Play All: Choose to play all supported media content on your playing device alphabetically.

Artists: In the Artists screen, you can select to play All Artists, or you can select any available artist. Press the cursor controls

(▲ / ▼ / ◀ / ▶) to highlight the desired choice and press ENTER.



Albums: The Albums screen lists all loaded albums alphabetically. Press the cursor controls (▲ / ▼ / ◀ / ▶) to highlight the desired choice and press ENTER.

Genres: The Genre screen lists all available genres. Press the cursor controls (▲ / ▼ / ◀ / ▶) to highlight the desired choice and press ENTER.

Playlists: The Playlist screen allows you to view and select from any previously saved playlists on your playing device. Press the cursor controls (▲ / ▼ / ◀ / ▶) to highlight the desired choice and press ENTER.

Tracks: The Track screen lists all tracks in your playing device alphabetically. Use the scroll bar to advance/reverse in the list. Select to begin play.

Explore USB : The Explore USB screen allows you to scroll through all supported media content stored on your device. Press the cursor controls (▲ / ▼ / ◀ / ▶) to highlight the desired choice and press ENTER.

SYNC media features

Similar Music The Similar Music screen allows you to play music similar to what is currently playing from the USB port. The system will use the metadata information of each song to compile a playlist for you.

Select source menu

The SYNC select source menu screen allows you to choose which SYNC media source to access.

- From the main screen, select 'Menu'.



- Choose 'Select Source'.



Choose from:

- **USB:** Select to access any supported device plugged into the USB port.
- **Bluetooth Stereo:** Select to stream audio from your *Bluetooth* stereo enabled device over the vehicle's speakers.
- **Line In:** Select to access any playing device plugged into the Auxiliary input jack (Line in).

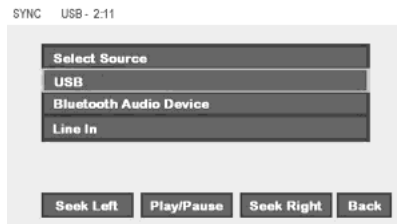

SYNC media features

Media settings

The Media Settings screen allows you to turn Shuffle, Repeat and Autoplay on/off. To access:

- From the main screen, select 'Menu'.



- Select 'Media Settings'.



You can now access:

Shuffle: Select to turn Shuffle on/off. Shuffle will randomly shuffle all selected music.



Repeat: Select to turn repeat on/off. The repeat feature will repeat the currently chosen track until turned off.

Autoplay: Select to begin playing USB tracks as soon as possible during the indexing process. With Autoplay turned off, the chosen USB tracks will not begin to play until all of the USB tracks have been indexed by SYNC. Depending on the size of the playable media and the device being indexed, this may take a few minutes.

SYNC End user license agreement

SYNC DEVICE END USER LICENSE AGREEMENT (EULA)

You have acquired a device (“DEVICE”) that includes software licensed by FORD MOTOR COMPANY from an affiliate of Microsoft Corporation (“MS”). Those installed software products of MS origin, as well as associated media, printed materials, and “online” or electronic documentation (“SOFTWARE”) are protected by international intellectual property laws and treaties. The SOFTWARE is licensed, not sold. All rights reserved.

The SOFTWARE may be configured to interface with and/or communicate with, or may be later upgraded to interface with and/or communicate with additional software systems provided by FORD MOTOR COMPANY. These additional software systems of FORD MOTOR COMPANY origin, as well as associated media, printed materials, and “online” or electronic documentation (“FORD SOFTWARE”) are protected by international intellectual property laws and treaties. The FORD SOFTWARE is licensed, not sold. All rights reserved.

IF YOU DO NOT AGREE TO THIS END USER LICENSE AGREEMENT (“EULA”), DO NOT USE THE DEVICE OR COPY THE SOFTWARE. ANY USE OF THE SOFTWARE, INCLUDING BUT NOT LIMITED TO USE ON THE DEVICE, WILL CONSTITUTE YOUR AGREEMENT TO THIS EULA (OR RATIFICATION OF ANY PREVIOUS CONSENT).

GRANT OF SOFTWARE LICENSE: This EULA grants you the following license:

- You may use the SOFTWARE as installed on the DEVICE.
- You may use the FORD SOFTWARE as installed on the vehicle.

DESCRIPTION OF OTHER RIGHTS AND LIMITATIONS:

- **Speech Recognition:** If the SOFTWARE includes speech recognition component(s), you should understand that speech recognition is an inherently statistical process and that recognition errors are inherent in the process. Neither FORD MOTOR COMPANY nor its suppliers shall be liable for any damages arising out of errors in the speech recognition process.
- **Limitations on Reverse Engineering, Decompilation and Disassembly:** You may not reverse engineer, decompile, or disassemble nor permit others to reverse engineer, decompile or disassemble the SOFTWARE, except and only to the extent that such activity is expressly permitted by applicable law notwithstanding this limitation.

SYNC End user license agreement

You may not reverse engineer, decompile, or disassemble nor permit others to reverse engineer, decompile or disassemble the FORD SOFTWARE, except and only to the extent that such activity is expressly permitted by applicable law notwithstanding this limitation.

- **Single EULA:** The end user documentation for the DEVICE may contain multiple versions of this EULA, such as multiple translations and/or multiple media versions (e.g., in the user documentation and in the software). Even if you receive multiple versions of the EULA, you are licensed to use only one (1) copy of the SOFTWARE and only one (1) copy of the FORD SOFTWARE.
- **SOFTWARE Transfer:** You may permanently transfer all of your rights under this EULA only as part of a sale or transfer of the DEVICE, provided you retain no copies, you transfer all of the SOFTWARE (including all component parts, the media and printed materials, any upgrades, this EULA and, if applicable, the Certificate(s) of Authenticity), and the recipient agrees to the terms of this EULA. If the SOFTWARE is an upgrade, any transfer must include all prior versions of the SOFTWARE.
- **Termination:** Without prejudice to any other rights, FORD MOTOR COMPANY or MS may terminate this EULA if you fail to comply with the terms and conditions of this EULA.
- **Security Updates/Digital Rights Management:** Content owners use the WMDRM technology included in your DEVICE to protect their intellectual property, included copyrighted content. Portions of the SOFTWARE on your DEVICE use WMDRM software to access WMDRM-protected content. If the WMDRM software fails to protect the content, content owners may ask Microsoft to revoke the SOFTWARE's ability to use WMDRM to play or copy protected content. This action does not affect unprotected content. When your DEVICE downloads licenses for protected content, you agree that Microsoft may include a revocation list with the licenses. Content owners may require you to upgrade the SOFTWARE on your DEVICE to access their content. If you decline an upgrade, you will not be able to access content that requires the upgrade.
- **Consent to Use of Data:** You agree that MS, Microsoft Corporation, their affiliates and/or their designated agent may collect and use technical information gathered in any manner as part of product support services related to the SOFTWARE. MS, Microsoft Corporation, their affiliates and/or their designated agent may use this information solely to improve their products or to provide customized services or technologies to you. MS, Microsoft Corporation, their

SYNC End user license agreement

affiliates and/or their designated agent may disclose this information to others, but not in a form that personally identifies you.

- **Internet-Based Services Components:** The SOFTWARE may contain components that enable and facilitate the use of certain Internet-based services. You acknowledge and agree that MS, Microsoft Corporation, their affiliates and/or their designated agent may automatically check the version of the SOFTWARE and/or its components that you are utilizing and may provide upgrades or supplements to the SOFTWARE that may be automatically downloaded to your DEVICE.
- **Additional Software/Services:** The SOFTWARE may permit FORD MOTOR COMPANY, MS, Microsoft Corporation, their affiliates and/or their designated agent to provide or make available to you SOFTWARE updates, supplements, add-on components, or Internet-based services components of the SOFTWARE after the date you obtain your initial copy of the SOFTWARE (“Supplemental Components”).

If FORD MOTOR COMPANY provides or makes available to you Supplemental Components and no other EULA terms are provided along with the Supplemental Components, then the terms of this EULA shall apply.

If MS, Microsoft Corporation, their affiliates and/or their designated agent make available Supplemental Components, and no other EULA terms are provided, then the terms of this EULA shall apply, except that the MS, Microsoft Corporation or affiliate entity providing the Supplemental Component(s) shall be the licensor of the Supplemental Component(s).

FORD MOTOR COMPANY, MS, Microsoft Corporation, their affiliates and/or their designated agent reserve the right to discontinue without liability any Internet-based services provided to you or made available to you through the use of the SOFTWARE.

- **Links to Third Party Sites:** The SOFTWARE may provide you with the ability to link to third party sites through the use of the SOFTWARE. The third party sites are not under the control of MS, Microsoft Corporation, their affiliates and/or their designated agent. Neither MS nor Microsoft Corporation nor their affiliates nor their designated agent are responsible for (i) the contents of any third party sites, any links contained in third party sites, or any changes or updates to third party sites, or (ii) webcasting or any other form of transmission received from any third party sites. If the SOFTWARE provides links to third party sites, those links are provided to you only

SYNC End user license agreement

as a convenience, and the inclusion of any link does not imply an endorsement of the third party site by MS, Microsoft Corporation, their affiliates and/or their designated agent.

- **Obligation to Drive Responsibly:** You recognize your obligation to drive responsibly and keep attention on the road. You will read and abide with the DEVICE operating instructions particularly as they pertain to safety and assumes any risk associated with the use of the DEVICE.

UPGRADES AND RECOVERY MEDIA:

If the SOFTWARE is provided by FORD MOTOR COMPANY separate from the DEVICE on media such as a ROM chip, CD ROM disk(s) or via web download or other means, and is labeled "For Upgrade Purposes Only" or "For Recovery Purposes Only" you may install one (1) copy of such SOFTWARE onto the DEVICE as a replacement copy for the existing SOFTWARE, and use it in accordance with this EULA, including any additional EULA terms accompanying the upgrade SOFTWARE.

INTELLECTUAL PROPERTY RIGHTS: All title and intellectual property rights in and to the SOFTWARE (including but not limited to any images, photographs, animations, video, audio, music, text and "applets," incorporated into the SOFTWARE), the accompanying printed materials, and any copies of the SOFTWARE, are owned by MS, Microsoft Corporation, their affiliates or suppliers. The SOFTWARE is licensed, not sold. You may not copy the printed materials accompanying the SOFTWARE. All title and intellectual property rights in and to the content which may be accessed through use of the SOFTWARE is the property of the respective content owner and may be protected by applicable copyright or other intellectual property laws and treaties. This EULA grants you no rights to use such content. All rights not specifically granted under this EULA are reserved by MS, Microsoft Corporation, their affiliates and suppliers. Use of any on-line services which may be accessed through the SOFTWARE may be governed by the respective terms of use relating to such services. If this SOFTWARE contains documentation that is provided only in electronic form, you may print one copy of such electronic documentation.

All title and intellectual property rights in and to the FORD SOFTWARE (including but not limited to any images, photographs, animations, video, audio, music, text and "applets," incorporated into the FORD SOFTWARE), the accompanying printed materials, and any copies of the FORD SOFTWARE, are owned by FORD MOTOR COMPANY. The FORD SOFTWARE is licensed, not sold. You may not copy the printed materials accompanying the FORD SOFTWARE. All title and intellectual property

SYNC End user license agreement

rights in and to the content which may be accessed through use of the FORD SOFTWARE is the property of the respective content owner and may be protected by applicable copyright or other intellectual property laws and treaties. This EULA grants you no rights to use such content. All rights in the FORD SOFTWARE not specifically granted under this EULA are reserved by FORD MOTOR COMPANY. Use of any on-line services which may be accessed through the FORD SOFTWARE may be governed by the respective terms of use relating to such services. If the FORD SOFTWARE contains documentation that is provided only in electronic form, you may print one copy of such electronic documentation.

EXPORT RESTRICTIONS: You acknowledge that the SOFTWARE is subject to U.S. and European Union export jurisdiction. You agree to comply with all applicable international and national laws that apply to the SOFTWARE, including the U.S. Export Administration Regulations, as well as end-user, end-use and destination restrictions issued by U.S. and other governments. For additional information, see <http://www.microsoft.com/exporting/>.

TRADEMARKS: This EULA does not grant you any rights in connection with any trademarks or service marks of FORD MOTOR COMPANY, MS, Microsoft Corporation, their affiliates or suppliers.

PRODUCT SUPPORT: Product support for the SOFTWARE is not provided by MS, its parent corporation Microsoft Corporation, or their affiliates or subsidiaries. For product support, please refer to FORD MOTOR COMPANY instructions provided in the documentation for the DEVICE. Should you have any questions concerning this EULA, or if you desire to contact FORD MOTOR COMPANY for any other reason, please refer to the address provided in the documentation for the DEVICE.

No Liability for Certain Damages: EXCEPT AS PROHIBITED BY LAW, FORD MOTOR COMPANY, MS, MICROSOFT CORPORATION AND THEIR AFFILIATES SHALL HAVE NO LIABILITY FOR ANY INDIRECT, SPECIAL, CONSEQUENTIAL OR INCIDENTAL DAMAGES ARISING FROM OR IN CONNECTION WITH THE USE OR PERFORMANCE OF THE SOFTWARE AND/OR THE FORD SOFTWARE. THIS LIMITATION SHALL APPLY EVEN IF ANY REMEDY FAILS OF ITS ESSENTIAL PURPOSE. IN NO EVENT SHALL MS, MICROSOFT CORPORATION AND/OR THEIR AFFILIATES BE LIABLE FOR ANY AMOUNT IN EXCESS OF U.S. TWO HUNDRED FIFTY DOLLARS (U.S.\$250.00).

• THERE ARE NO WARRANTIES OTHER THAN THOSE THAT MAY EXPRESSLY BE PROVIDED FOR YOUR NEW VEHICLE.

150

SYNC End user license agreement

END USER NOTICE

MICROSOFT® WINDOWS® MOBILE FOR AUTOMOTIVE IMPORTANT SAFETY INFORMATION

This system Ford SYNC™ contains software that is licensed to Manufacturer FORD MOTOR COMPANY by an affiliate of Microsoft Corporation pursuant to a license agreement. Any removal, reproduction, reverse engineering or other unauthorized use of the software from this system in violation of the license agreement is strictly prohibited and may subject you to legal action.

Read and follow instructions

Before using your Windows Automotive-based system, read and follow all instructions and safety information provided in this end user manual (“User’s Guide”). Not following precautions found in this User’s Guide can lead to an accident or other serious consequences.

Keep User’s Guide in Vehicle

When kept in the vehicle, the User’s Guide will be a ready reference for you and other users unfamiliar with the Windows Automotive-based system. Please make certain that before using the system for the first time, all persons have access to the User’s Guide and read its instructions and safety information carefully.



Operating certain parts of this system while driving can distract your attention away from the road, and possibly cause an accident or other serious consequences. Do not change system settings or enter data non-verbally (using your hands) while driving. Stop the vehicle in a safe and legal manner before attempting these operations. This is important since while setting up or changing some functions you might be required to distract your attention away from the road and remove your hands from the wheel.

General operation

Voice Command Control

Functions within the Windows Automotive-based system may be accomplished using only voice commands. Using voice commands while driving allows you to operate the system without removing your hands from the wheel.

Prolonged Views of Screen

Do not access any function requiring a prolonged view of the screen while you are driving. Pull over in a safe and legal manner before

SYNC End user license agreement

attempting to access a function of the system requiring prolonged attention. Even occasional short scans to the screen may be hazardous if your attention has been diverted away from your driving task at a critical time.

Volume Setting

Do not raise the volume excessively. Keep the volume at a level where you can still hear outside traffic and emergency signals while driving. Driving while unable to hear these sounds could cause an accident.

Use of Speech Recognition Functions

Speech recognition software is inherently a statistical process which is subject to errors. It is your responsibility to monitor any speech recognition functions included in the system and address any errors.

Navigation Features

Any navigation features included in the system are intended to provide turn by turn instructions to get you to a desired destination. Please make certain all persons using this system carefully read and follow instructions and safety information fully.

Distraction Hazard

Any navigation features may require manual (non-verbal) setup. Attempting to perform such set-up or insert data while driving can seriously distract your attention and could cause an accident or other serious consequences. Stop the vehicle in a safe and legal manner before attempting these operations.

Let Your Judgment Prevail

Any navigation features are provided only as an aid. Make your driving decisions based on your observations of local conditions and existing traffic regulations. Any such feature is not a substitute for your personal judgment. Any route suggestions made by this system should never replace any local traffic regulations or your personal judgment or knowledge of safe driving practices.

Route Safety

Do not follow the route suggestions if doing so would result in an unsafe or illegal maneuver, if you would be placed in an unsafe situation, or if you would be directed into an area that you consider unsafe. The driver is ultimately responsible for the safe operation of the vehicle and therefore, must evaluate whether it is safe to follow the suggested directions.

SYNC End user license agreement

Potential Map Inaccuracy

Maps used by this system may be inaccurate because of changes in roads, traffic controls or driving conditions. Always use good judgment and common sense when following the suggested routes.

Emergency Services

Do not rely on any navigation features included in the system to route you to emergency services. Ask local authorities or an emergency services operator for these locations. Not all emergency services such as police, fire stations, hospitals and clinics are likely to be contained in the map database for such navigation features.

GLOSSARY OF TERMS

Autoplay: With Autoplay turned ON, SYNC allows you to listen to music which has already been randomly indexed during the indexing process. With Autoplay turned off, the chosen music will not begin to play until all of the music has been indexed by SYNC. Depending on the size of the material, this may take a few minutes.

Bluetooth enabled cellular phone: Any cellular phone which has the *Bluetooth* wireless technology which will enable the phone to connect with SYNC and exchange information wirelessly.

Digital media player / USB Device: This is a generic term used to signify any of the following media devices: iPod®, Zune™, “Plays from device” players, and most USB drives (thumb drives, flash drives, PEN drives, etc.)

Discoverable mode: A mode which allows other *Bluetooth* enabled devices to find your *Bluetooth* enabled device.

Discovery mode: A mode which allows your *Bluetooth* enabled device to search for other ‘discoverable’ *Bluetooth* enabled devices.

In-band ringing: This is a phone dependent feature. If your *Bluetooth* enabled cellular phone supports this feature, SYNC can play your ring tone during incoming calls.

Indexing: A process in which SYNC builds a voice recognition grammar for the media content of your digital media player. While indexing, SYNC will play already indexed media if Autoplay is on. However, voice recognition is not available for the media until the indexing process is complete.

Metadata: Descriptive tags embedded in your digital media which provide SYNC with information such as ARTIST, ALBUM, GENRE and TRACK.

SYNC End user license agreement

Pairing: To use your *Bluetooth* enabled cellular phone with SYNC, you must go through a pairing (bonding) process. “Pairing” is a special process used when two devices connect for the first time. The pairing process is used to generate a link key that is used for authentication purposes during subsequent *Bluetooth* connections between the two devices.

PIN (Personal Identification number): This six digit number (sometimes referred to as a passkey) will be shown in the radio display during the pairing process with your *Bluetooth* enabled device. You do not need to write down this number as it will only be used for that specific pairing procedure.

Index

- A**
- Accessing SYNC system information117
 - Accessing your phone book104
 - Accessing your playlists134
 - Adding a new device in discovery or discoverable mode136–137
 - Adding a phone107
 - Address Book - destination entry53
 - Address Book - editing67
 - Advanced settings108
 - AM/FM14
 - Automatically download your phone book111
 - Auxiliary input jack (Line in)23
 - Avoid areas69
- C**
- Call history105
 - CD21
 - Cleaning90
 - Cleaning Map DVDs43
 - Connecting a phone106
 - Connecting your digital media player to SYNC125
- D**
- Date/time settings35
 - Deleting a phone107
 - Destination entry49
 - Destination map62
 - Destination way points63
 - Displays34
 - DVD (if equipped)23
- E**
- Exploring the USB device135
- F**
- Forwarding a text message123
 - Freeway entrance/exit61
- G**
- Glossary153
 - GPS reception89
- H**
- Help39
 - How to get going5
 - How to get going with SYNC media125
 - Hybrid information (if equipped)30
- I**
- Installing new vehicle applications117
 - Intersection60
- L**
- Latest map DVDs42
- M**
- Making a call100

Index

MAP DVD - Loading and Unloading41
Map icons47
Map preferences65
Message notification111
Modifying your phone book and call history112

N

Navigation end user license agreement86
Navigation glossary90

O

Ordering additional map DVDs43

P

Pairing your phone through your navigation system99
Performing a master reset116
Phone dependent features92
Playing a specific track134
Point of Interest (POI)55
Previous destination51

Q

Quick destination49
Quick POIs69
Quick reference chart98
Quick touch buttons46

R

Rear seat controls (if equipped)28
Replacing contacts in your Quick Dial locations104
Returning to factory defaults115

S

Safety information92
Satellite Radio (if equipped)16
Saving a contact or phone number as Quick Dial103
Security38
Select route64
Selecting and playing specific albums133
Selecting and playing specific artists132
Selecting different genres133
Setting a ring tone110
Settings70
Sound features26
Speed compensated volume28
Streaming music from your phone129
Supported player, media formats and metadata information129
SYNC media features126
SYNC phone features102
SYNC voice recognition feature93
System information40

Index

- System introduction4
- System limitations89
- System overview10
- System settings106
- T**
- Text messaging with your navigation system118
- Troubleshooting83
- Turning Bluetooth on/off109
- Turning prompts on/off114
- U**
- USB port127
- User Device (if equipped)23
- Using the Auxiliary input jack (Line in)130
- Using the play all feature132
- Using the quick dial feature103
- Using voice commands with SYNC94
- V**
- Voice commands in media mode138
- Voice commands in phone mode124
- Voice recognition71
- W**
- What is SYNC?91
- What's playing?129



8E6J 19A285 AB

October 2007
Second Printing
Owner's Guide Supplement

Navigation System
Litho in U.S.A.