

Table of Contents

Introduction	4
Instrument Cluster	10
Warning and control lights	10
Gauges	15
Entertainment Systems	17
AM/FM stereo cassette with CD	30
CD changer	36
Navigation system	38
Climate Controls	101
Dual automatic temperature control	101
Rear window defroster	104
Lights	105
Headlamps	105
Turn signal control	108
Bulb replacement	109
Driver Controls	115
Windshield wiper/washer control	115
Steering wheel adjustment	116
Power windows	129
Mirrors	130
Speed control	132
Message center	138
Locks and Security	146
Locks	146
Anti-theft system	157

Table of Contents

Seating and Safety Restraints	162
Seating	162
Safety restraints	167
Air bags	182
Child restraints	193
Tires, Wheels and Loading	204
Tire Information	205
Changing tires	209
Wheel lug nut torque	215
Vehicle loading	225
Trailer towing	231
Recreational towing	234
Driving	235
Starting	235
Brakes	238
Traction control	241
Air suspension	243
Transmission operation	243
Roadside Emergencies	251
Getting roadside assistance	251
Hazard flasher switch	252
Fuel pump shut-off switch	252
Fuses and relays	253
Jump starting	260
Wrecker towing	266
Customer Assistance	267
Reporting safety defects (U.S. only)	275
Cleaning	276

Table of Contents

Maintenance and Specifications	282
Engine compartment	284
Engine oil	285
Battery	289
Engine Coolant	291
Fuel information	297
Air filter(s)	311
Refill capacities	312
Lubricant specifications	314
Accessories	321
Index	323

All rights reserved. Reproduction by any means, electronic or mechanical including photocopying, recording or by any information storage and retrieval system or translation in whole or part is not permitted without written authorization from Ford Motor Company. Ford may change the contents without notice and without incurring obligation.

Copyright © 2004 Ford Motor Company

Introduction

CALIFORNIA Proposition 65 Warning



WARNING: Engine exhaust, some of its constituents, and certain vehicle components contain or emit chemicals known to the State of California to cause cancer and birth defects or other reproductive harm. In addition, certain fluids contained in vehicles and certain products of component wear contain or emit chemicals known to the State of California to cause cancer and birth defects or other reproductive harm.

CONGRATULATIONS

Congratulations on acquiring your new Lincoln. Please take the time to get well acquainted with your vehicle by reading this handbook. The more you know and understand about your vehicle, the greater the safety and pleasure you will derive from driving it.

For more information on Ford Motor Company and its products visit the following website:

- In the United States: www.ford.com
- In Canada: www.ford.ca
- In Mexico: www.ford.com.mx
- In Australia: www.ford.com.au

Additional owner information is given in separate publications.

This *Owner's Guide* describes every option and model variant available and therefore some of the items covered may not apply to your particular vehicle. Furthermore, due to printing cycles it may describe options before they are generally available.

Remember to pass on the *Owner's Guide* when reselling the vehicle. It is an integral part of the vehicle.



Fuel pump shut-off switch: In the event of an accident the safety switch will automatically cut off the fuel supply to the engine. The switch can also be activated through sudden vibration (e.g. collision when parking). To reset the switch, refer to the *Fuel pump shut-off switch* in the *Roadside Emergencies* chapter.

SAFETY AND ENVIRONMENT PROTECTION

Warning symbols in this guide

How can you reduce the risk of personal injury to yourself or others? In this guide, answers to such questions are contained in comments highlighted by the warning triangle symbol. These comments should be read and observed.

Warning symbols on your vehicle

When you see this symbol, it is imperative that you consult the relevant section of this guide before touching or attempting adjustment of any kind.



Protecting the environment

We must all play our part in protecting the environment. Correct vehicle usage and the authorized disposal of waste, cleaning and lubrication materials are significant steps towards this aim. Information in this respect is highlighted in this guide with the tree symbol.



BREAKING-IN YOUR VEHICLE

Your vehicle does not need an extensive break-in. Try not to drive continuously at the same speed for the first 1,000 miles (1,600 km) of new vehicle operation. Vary your speed frequently in order to give the moving parts a chance to break in.

Drive your new vehicle at least 2,000 miles (3,200 km) before towing a trailer.

Do not add friction modifier compounds or special break-in oils during the first few thousand miles (kilometers) of operation, since these additives may prevent piston ring seating. See *Engine oil* in the *Maintenance and Specifications* chapter for more information on oil usage.

Introduction

SPECIAL NOTICES

Emission warranty

The New Vehicle Limited Warranty includes Bumper-to-Bumper Coverage, Safety Restraint Coverage, Corrosion Coverage, and 6.0L Power Stroke Diesel Engine Coverage. In addition, your vehicle is eligible for Emissions Defect and Emissions Performance Warranties. For a detailed description of what is covered and what is not covered, refer to the *Warranty Guide* that is provided to you along with your *Owner's Guide*.

Service Data Recording

Service data recorders in your vehicle are capable of collecting and storing diagnostic information about your vehicle. This potentially includes information about the performance or status of various systems and modules in the vehicle, such as engine, throttle, steering or brake systems. In order to properly diagnose and service your vehicle, Ford Motor Company, Ford of Canada, and service and repair facilities may access vehicle diagnostic information through a direct connection to your vehicle when diagnosing or servicing your vehicle.

Event Data Recording

Other modules in your vehicle — event data recorders — are capable of collecting and storing data during a crash or near crash event. The recorded information may assist in the investigation of such an event. The modules may record information about both the vehicle and the occupants, potentially including information such as:

- how various systems in your vehicle were operating;
- whether or not the driver and passenger seatbelts were buckled;
- how far (if at all) the driver was depressing the accelerator and/or the brake pedal;
- how fast the vehicle was traveling; and
- where the driver was positioning the steering wheel.

To access this information, special equipment must be directly connected to the recording modules. Ford Motor Company and Ford of Canada do not access event data recorder information without obtaining consent, unless pursuant to court order or where required by law enforcement, other government authorities or other third parties acting with lawful authority. Other parties may seek to access the information independently of Ford Motor Company and Ford of Canada.

Introduction

Special instructions

For your added safety, your vehicle is fitted with sophisticated electronic controls.



Please read the section *Supplemental restraint system (SRS)* in the *Seating and Safety Restraints* chapter. Failure to follow the specific warnings and instructions could result in personal injury.



Front seat mounted rear-facing child or infant seats should **NEVER** be placed in front of an active passenger air bag.

MIDDLE EAST/NORTH AFRICA VEHICLE SPECIFIC INFORMATION

For your particular global region, your vehicle may be equipped with features and options that are different from the ones that are described in this *Owner's Guide*; therefore, a supplement has been supplied that complements this book. By referring to the pages in the provided supplement, you can properly identify those features, recommendations and specifications that are unique to your vehicle. **Refer to this Owner's Guide for all other required information and warnings.**

Introduction



These are some of the symbols you may see on your vehicle.

Vehicle Symbol Glossary

Safety Alert		See Owner's Guide	
Fasten Safety Belt		Air Bag-Front	
Air Bag-Side		Child Seat	
Child Seat Installation Warning		Child Seat Lower Anchor	
Child Seat Tether Anchor		Brake System	
Anti-Lock Brake System		Brake Fluid - Non-Petroleum Based	
Powertrain Malfunction		Speed Control	
Master Lighting Switch		Hazard Warning Flasher	
Fog Lamps-Front		Fuse Compartment	
Fuel Pump Reset		Windshield Wash/Wipe	
Windshield Defrost/Demist		Rear Window Defrost/Demist	

Introduction

Vehicle Symbol Glossary

Power Windows Front/Rear		Power Window Lockout	
Child Safety Door Lock/Unlock		Interior Luggage Compartment Release Symbol	
Panic Alarm		Engine Oil	
Engine Coolant		Engine Coolant Temperature	
Do Not Open When Hot		Battery	
Avoid Smoking, Flames, or Sparks		Battery Acid	
Explosive Gas		Fan Warning	
Power Steering Fluid		Maintain Correct Fluid Level	
Emission System		Engine Air Filter	
Passenger Compartment Air Filter		Jack	
Check fuel cap		Low tire warning	

Instrument Cluster

WARNING LIGHTS AND CHIMES

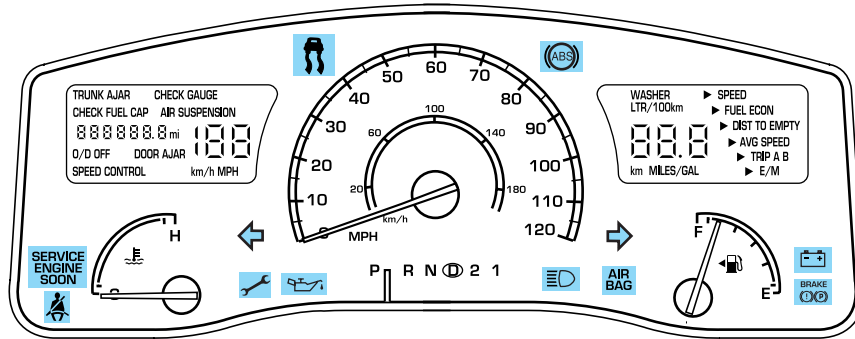

Warning lights and gauges can alert you to a vehicle condition that may become serious enough to cause expensive repairs. A warning light may illuminate when a problem exists with one of your vehicle's functions. Many lights will illuminate when you start your vehicle to make sure the bulb works. If any light remains on after starting the vehicle, have the respective system inspected immediately.

Service engine soon: The *Service engine soon* indicator light illuminates when the ignition is first turned to the ON position to check the bulb. Solid illumination after the engine is started indicates the On Board Diagnostics System (OBD-II) has detected a malfunction. Refer to *On board diagnostics (OBD-II)* in the *Maintenance and Specifications* chapter. If the light is blinking, engine misfire is occurring which could damage your catalytic converter. Drive in a moderate fashion (avoid heavy acceleration and deceleration) and have your vehicle serviced immediately.

**SERVICE
ENGINE
SOON**



Under engine misfire conditions, excessive exhaust temperatures could damage the catalytic converter, the fuel system, interior floor coverings or other vehicle components, possibly causing a fire.

Electronic throttle control:
Illuminates when the engine has



Instrument Cluster

defaulted to a 'limp-home' operation. Report the fault to a dealer at the earliest opportunity.

Check fuel cap: Illuminates when the fuel cap may not be properly installed. Continued driving with this light on may cause the Service engine soon warning light to come on. Refer to *Fuel filler cap* in the *Maintenance and Specifications* chapter.

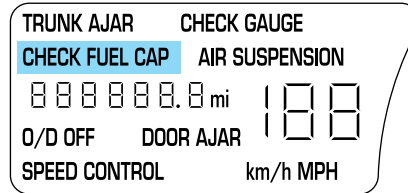

Brake system warning light: To confirm the brake system warning light is functional, it will momentarily illuminate when the ignition is turned to the ON position when the engine is not running, or in a position between ON and START, or by applying the parking brake when the ignition is turned to the ON position. If the brake system warning light does not illuminate at this time, seek service immediately from your dealership. Illumination after releasing the parking brake indicates low brake fluid level and the brake system should be inspected immediately by your servicing dealership.



 Driving a vehicle with the brake system warning light on is dangerous. A significant decrease in braking performance may occur. It will take you longer to stop the vehicle. Have the vehicle checked by your dealer immediately.

Anti-lock brake system: If the ABS light stays illuminated or continues to flash, a malfunction has been detected, have the system serviced immediately. Normal braking is still functional unless the brake warning light also is illuminated.



Air bag readiness: If this light fails to illuminate when ignition is turned to ON, continues to flash or remains on, have the system serviced immediately. A chime will also sound when a malfunction in the supplemental restraint system has been detected.



Instrument Cluster

Safety belt: Reminds you to fasten your safety belt. A chime will also sound to remind you to fasten your safety belt, refer to the *Seating and Safety Restraints* chapter.



Charging system: Illuminates when the battery is not charging properly.



Engine oil pressure: Illuminates when the oil pressure falls below the normal range, refer to *Engine oil* in the *Maintenance and Specifications* chapter.



Traction control™ active: Flashes when the Traction control™ system is active. If the light remains on, have the system serviced immediately, refer to the *Driving* chapter for more information.



Check gage: Illuminates when the engine coolant temperature is high. Stop the vehicle as soon as possible, switch off the engine and let cool. Refer to *Engine coolant* in the *Maintenance and Specifications* chapter.

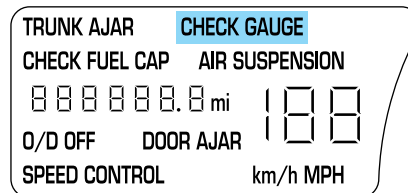

Air suspension: Illuminates when the air suspension is turned OFF or the air suspension system requires servicing.

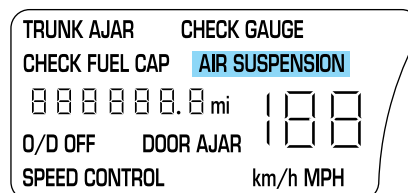

Instrument Cluster

Washer: Illuminates when the windshield washer fluid is low.

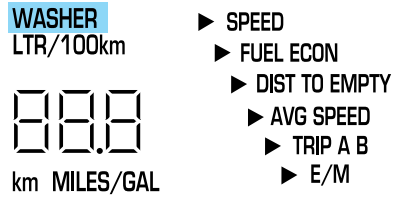

Speed control: Illuminates when the speed control is activated. Turns off when the speed control system is deactivated.

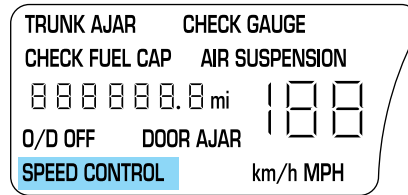

O/D off: Illuminates when the overdrive function of the transmission has been turned OFF using the transmission control switch (TCS), refer to the *Driving* chapter. If the light flashes steadily or does not illuminate, have the transmission serviced soon, or damage may occur.

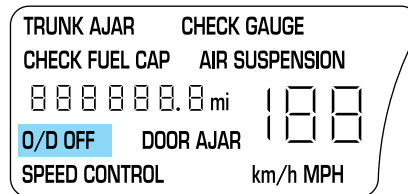

Door ajar: Illuminates when any door is open (or not fully closed).

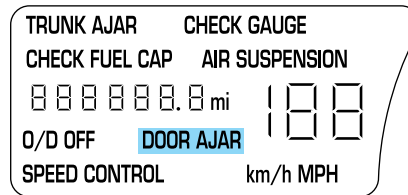

Instrument Cluster

Trunk ajar: Illuminates when the trunk is not completely closed. This light will flash and sound a tone for one second, then the light remains on.

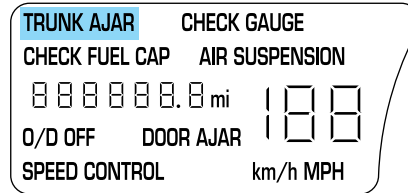

Turn signal: Illuminates when the left or right turn signal or the hazard lights are turned on. If the indicators stay on or flash faster, check for a burned out bulb.



High beams: Illuminates when the high beam headlamps are turned on.



Headlamps on warning chime: Sounds when the headlamps or parking lamps are on, the ignition is off (the key is not in the ignition) and the driver's door is opened.

Key-in-ignition warning chime: Sounds when the key is left in the ignition in the OFF/LOCK or ACCESSORY position and the driver's door is opened.

Turn signal chime (if equipped): Sounds when the turn signal lever has been activated to signal a turn and not turned off after the vehicle is driven more than 0.8 km (1/2 mile).

Instrument Cluster

GAUGES

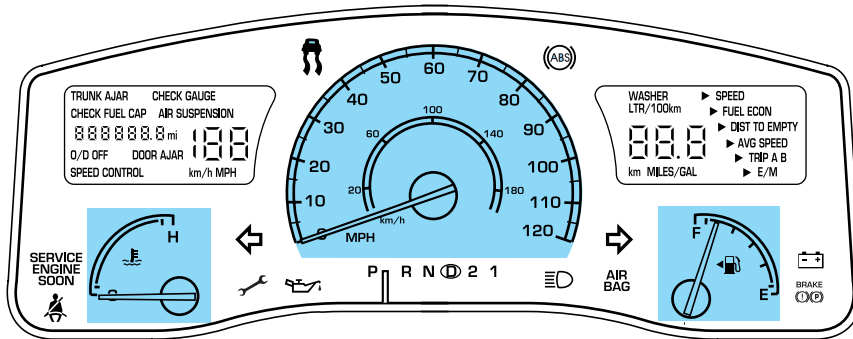

Speedometer: Indicates the current vehicle speed.

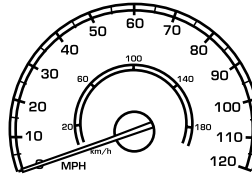

Select **SPEED** from the message center to display the digital speedometer on the left hand side of the cluster. Refer to the *Message Center* in the *Driver Controls* chapter for more information on the Trip A and B feature.

- ▶ **SPEED**
- ▶ **FUEL ECON**
- ▶ **DIST TO EMPTY**
- ▶ **AVG SPEED**
- ▶ **TRIP A B**
- ▶ **E/M**

Engine coolant temperature gauge: Indicates engine coolant temperature. At normal operating temperature, the needle will be in the normal range (between “H” and “C”). **If it enters the red section, the engine is overheating. Stop the vehicle as soon as safely possible, switch off the engine and let the engine cool.**

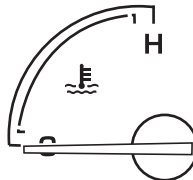

Instrument Cluster



Never remove the coolant reservoir cap while the engine is running or hot.

Odometer: Registers the total miles (kilometers) of the vehicle.

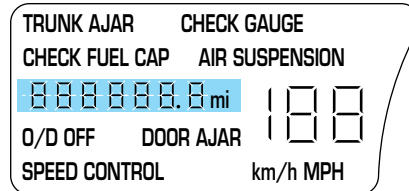

Fuel gauge: Indicates approximately how much fuel is left in the fuel tank (when the ignition is in the ON position). The fuel gauge may vary slightly when the vehicle is in motion or on a grade.

Refer to *Filling the tank* in the *Maintenance and Specifications* chapter for more information.

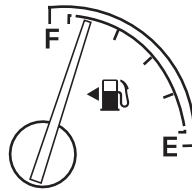

The FUEL icon and arrow indicates which side of the vehicle the fuel door is located.

Entertainment Systems

AM/FM STEREO SINGLE CD PREMIUM AUDIO SYSTEM (IF EQUIPPED)

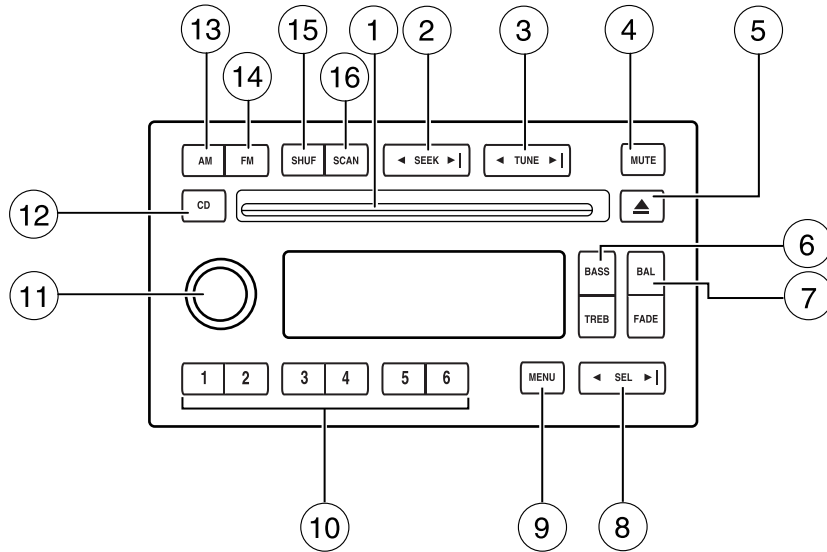

1. **CD slot:** Insert a CD, label side up. With the ignition on, the radio will begin to play a CD once inserted. If the ignition and audio system are off, press CD prior to inserting a disc. Do not force a disc into the system as damage could result.



2. **SEEK:** Press to access the next/previous radio station or CD track. Press and hold to advance/reverse in the current CD track.



3. **TUNE:** Press to manually go up or down the radio frequency.



4. **MUTE:** Press to mute the playing media. Press again to return to the playing media or turn the volume control to adjust the volume.



Entertainment Systems

5. **Eject:** Press to eject the CD. If the disc is not removed within the allotted time, the system will automatically reload the CD and begin play. **Note:** The eject function will work when the ignition is turned off.



6. **BASS:** Press BASS; then press ◀ SEL ▶ to decrease/increase the level of bass output.

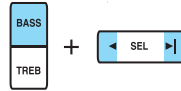

TREB (Treble): Press TREB; then press ◀ SEL ▶ to decrease/increase the level of treble output.

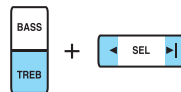

7. **BAL (Balance):** Press BAL; then press ◀ SEL ▶ to shift sound to the left/right speakers.

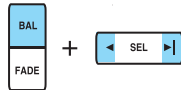

FADE: Press FADE; then press ◀ SEL ▶ to shift sound to the rear/front speakers.

8. **SEL:** Use with Bass, Treble, Balance, Fade and other menu functions.



9. **Menu:** Press MENU to access the following functions:



Compression: Brings soft and loud CD passages together for a more consistent listening level when in CD mode. Press MENU until compression status is displayed. Press ◀ SEL ▶ to enable the compression feature when COMPRESS OFF is displayed. Press ◀ SEL ▶ again to disable the feature when COMPRESS ON is displayed. When activated, the compression icon will appear in the display.

Autoset: Allows you to set the strongest local radio stations without losing your original manually set preset stations for AM/FM1/FM2. Press MENU until AUTOSET appears in the display. Press ◀ SEL ▶ to toggle ON/OFF. When the six strongest stations are filled, the station stored in preset 1 will begin playing. If there are less than six strong stations, the system will store the last one in the remaining presets.

Entertainment Systems

When activated, AUTOSET will momentarily appear in the display when any of the preset controls are pressed.

Speed sensitive volume: Radio volume changes automatically and slightly with vehicle speed to compensate for road and wind noise. Recommended level is 1–3. Level 0 turns the feature off and level 7 is the maximum setting.

Press MENU to access and use ◀ SEL ▶ to adjust the volume setting. The level will appear in the display.

Setting the clock: Your vehicle is equipped with an in-dash clock. Refer to *Setting the clock* in the *Driver Controls* Chapter.

Note: The menu selections will remain in the display for approximately 10 seconds, at which time the display will return to the previous mode. You may also exit the menu options by pressing any other audio control.

10. **Memory presets:** To set a station: Select frequency band, tune to a station, press and hold a preset button until sound returns.

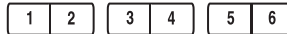

11. **On/Off/Volume:** Push to turn on/off; turn to adjust the volume levels.

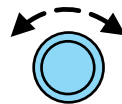

Note: With the ignition turned off, you may press the volume control to momentarily view the clock.

12. **CD:** Press to enter CD mode if a CD is already present in the system. In radio mode, the CD icon will appear in the display if a CD is loaded into the system.

13. **AM:** Press to select the AM frequency.



14. **FM:** Press to select the FM frequency. Press repeatedly to toggle between FM1 and FM2.



15. **SHUF (Shuffle):** Press to play all tracks on the current CD in random order. Press again to stop.



16. **SCAN:** Press SCAN to hear a brief sampling of radio stations or CD tracks. Press again to stop.



Entertainment Systems

PREMIUM SATELLITE COMPATIBLE AM/FM STEREO SINGLE CD/CASSETTE SYSTEM (IF EQUIPPED)

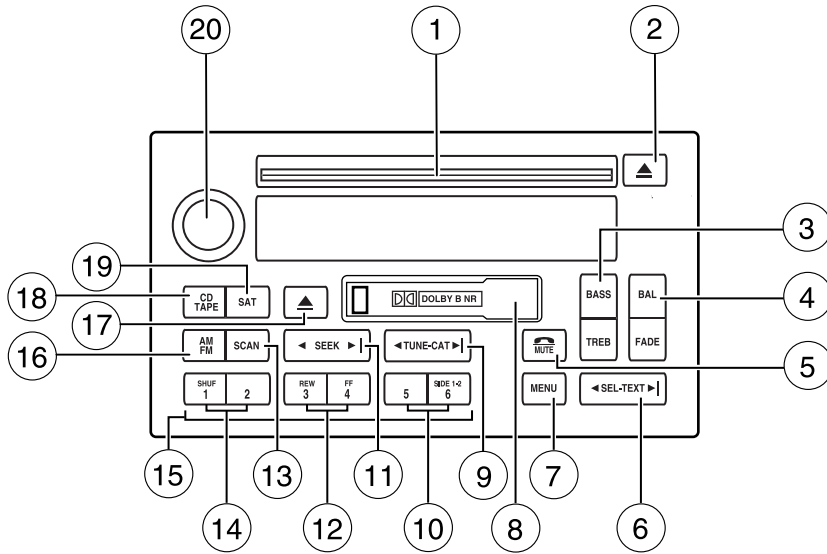

Entertainment Systems

AUDIOPHILE SATELLITE COMPATIBLE AM/FM STEREO SINGLE CD/CASSETTE SYSTEM (IF EQUIPPED)

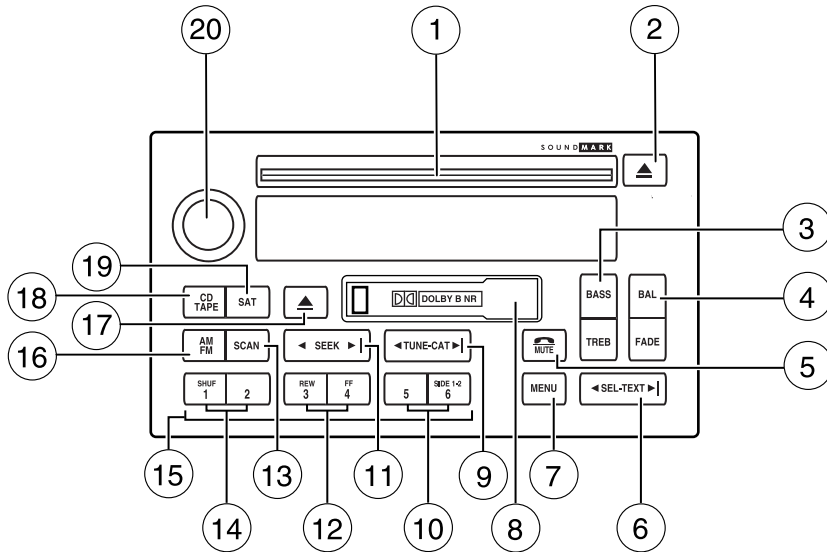

1. **CD slot:** Insert a CD, label side up. With the ignition on, the radio will begin to play a CD once inserted. If the ignition and audio system are off, press CD prior to inserting a disc. Do not force a disc into the system as damage could result.



2. **CD eject:** Press to eject a CD. If the disc is not removed within the allotted time, the system will automatically reload the CD and begin play. **Note:** The eject function will work when the ignition and audio systems are turned off.



3. **BASS:** Press BASS; then press ◀ SEL-TEXT ▶ to decrease/increase the level of bass output.



Entertainment Systems

TREB (Treble): Press TREB; then press ◀ SEL-TEXT ▶ to decrease/increase the level of treble output.

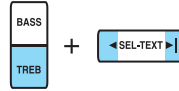

4. **BAL (Balance):** Press BAL; then press ◀ SEL-TEXT ▶ to shift sound to the left/right speakers.

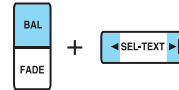

FADE: Press FADE; then press ◀ SEL-TEXT ▶ to shift sound to the rear/front speakers.

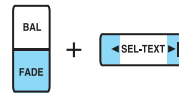

5. **Phone/mute:** Press to mute the playing media. Press again to return to the playing media, or turn the volume control to adjust the volume.



6. **SEL/TEXT:** Use with Bass, Treble, Balance, Fade and other menu functions.



TEXT: TEXT is only available when equipped with Satellite radio. Your Audiophile radio is quipped with Satellite ready capability. The kit to enable Satellite reception is available through your dealer. Detailed Satellite instructions are included with the dealer installed kit. *Dealer installed satellite kit available only in the continental United States.*

7. **MENU:** Press MENU repeatedly to access RDS on/off. Use SEL to toggle RDS on/off. Press MENU again to access Program type mode or Show Type/Name mode. (MENU must be pressed within 10 seconds to proceed to the next RDS mode.)



The Federal Communications Commission (FCC) and the Canadian Radio and Telecommunications Commission (CRTC) recommend that FM radio broadcasters use RDS technology to transmit information. FM radio stations are independently operated and individually elect to use RDS technology to transmit station ID and program type as desired.

FIND Program type: Allows you to search RDS-equipped stations for a certain category of music format: Classic, Country, Info, Jazz, Oldies, R&B, Religious, Rock, Soft, Top 40.

With RDS ON, press MENU until the program type menu is displayed. One of the various program types will appear. Press ◀ SEL-TEXT ▶

Entertainment Systems

to scroll through music types. Press SEEK or SCAN to search for a station playing the requested music category.

Show TYPE: Selects between displaying the station's call letters or music format when RDS is enabled. Press and hold MENU until SHOW XX appears in the display. Press ◀ SEL-TEXT ▶ to select NAME or TYPE.

Compression: Brings soft and loud CD passages together for a more consistent listening level when in CD mode. Press MENU repeatedly until COMP (compression) is displayed. Press ◀ SEL-TEXT ▶ to enable the compression feature when COMPRESS OFF is displayed. Press ◀ SEL-TEXT ▶ again to disable the feature when COMPRESS ON is displayed. When activated, the compression icon will appear in the display.

Occupancy mode: (Available only on Audiophile audios): Press MENU repeatedly until occupancy mode appears in the display. Press ◀ SEL-TEXT ▶ to select ALL, DRIVER or REAR SEAT occupancy mode.

Autoset: Allows you to set the strongest local radio stations without losing your original manually set preset stations for AM/FM1/FM2. Press MENU repeatedly until AUTOSET appears in the display. Press ◀ SEL-TEXT ▶ to toggle ON/OFF. When the six strongest stations are filled, the station stored in preset 1 will begin playing. If there are less than six strong stations, the system will store the last one in the remaining presets.

Speed sensitive volume: Radio volume changes automatically and slightly with vehicle speed to compensate for road and wind noise. Recommended level is 1-3. Level 0 turns the feature off and level 7 is the maximum setting. Press MENU to access and ◀ SEL-TEXT ▶ to adjust the volume setting. The level will appear in the display.

Dolby: Works in tape mode to reduce tape noise and hiss. Press MENU until DOLBY XX appears in the display. Press SEL/TEXT to toggle ON/OFF.

The Dolby® noise reduction system is manufactured under license from Dolby Laboratories Licensing Corporation. Dolby® and the double-D symbol are registered trademarks of Dolby Laboratories Licensing Corporation.

Armrest (if equipped): If your vehicle is equipped with Rear Seat Audio controls, this feature will be listed in Menu mode.

Entertainment Systems

Press ◀ SEL-TEXT ▶ to toggle ON/OFF. When the feature is turned ON, rear seat passengers can adjust the settings of the front audio stem. For further information, refer to *Rear Console Audio Controls (if equipped)* later in this chapter.

Setting the clock: Your vehicle is equipped with a separate in-dash clock. Refer to *Setting the clock* in the *Driver Controls* Chapter.

Note: The menu selections will remain in the display for approximately 10 seconds, at which time the display will return to the previous mode. You may also exit the menu options by pressing any other audio control.

8. **Cassette:** Insert a cassette facing to the right.

9. **TUNE:** Press to manually go up or down the radio frequency.



CAT: CAT is only available when equipped with Satellite Radio. Your vehicle may be equipped with Satellite ready capability. The kit to enable Satellite reception is available through your dealer. Detailed Satellite instructions are included with the dealer installed kit.

Dealer installed satellite kit not available in Canada.

10. **Side 1-2:** Press to access the next side of the cassette tape. The display will indicate whether TAPE 1 or TAPE 2 is playing.



11. **SEEK:** Press to access the next/previous radio station, tape selection or CD track. Press and hold to advance/reverse in the current CD track.



12. **REW (Rewind):** Press to rewind in tape or CD mode.



FF (Fast forward): Press to fast forward in tape or CD mode.



13. **SCAN:** Press SCAN to hear a brief sampling of radio stations, selections or CD tracks. Press again to stop.



Entertainment Systems

14. **SHUF (Shuffle):** Press to play the tracks on the current CD in random order. Press again to stop.



15. **Memory presets:** To set a station: Select frequency band, tune to a station, press and hold a preset button until sound returns.



16. **AM/FM:** Press to toggle between AM/FM1/FM2 modes.



17. **Tape eject:** Press to eject the tape.



18. **CD/TAPE:** Press to toggle between CD and TAPE mode. In radio mode, the CD icon will appear in the display if a CD is loaded into the system.



19. **SAT:** Your system may be equipped with Satellite Ready capability. The kit to enable the Satellite reception is available through your dealer. Detailed satellite instructions are included with the dealer installed kit.
Dealer installed satellite kit not available in Canada.



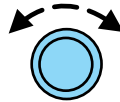

20. **On/Off/Volume:** Push to turn on/off; turn to adjust the volume levels.

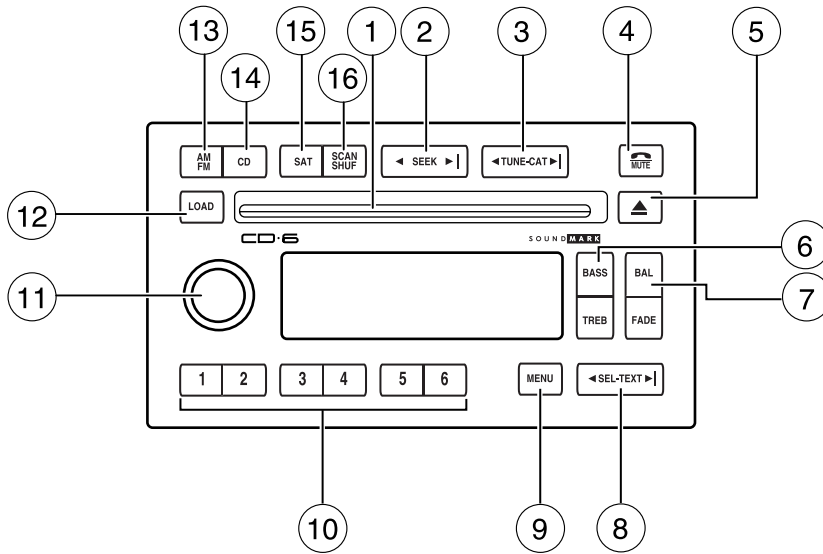

Entertainment Systems

PREMIUM/AUDIOPHILE AM/FM STEREO IN-DASH SIX CD SOUND SYSTEM (IF EQUIPPED)



1. **CD slot:** To insert a CD, press . When the system is ready, insert a CD, label side up. With the ignition on, the radio will begin to play a CD once inserted. If the ignition and audio system are off, press CD prior to inserting a disc. Do not force a disc into the system as damage could result.

2. **SEEK:** Press to access the next/previous radio station or CD track. Press and hold to advance/reverse in the current CD track.



3. **TUNE/CAT:** Press to manually go up or down the radio frequency.



CAT is only available when equipped with Satellite radio. Your vehicle may be equipped with Satellite ready capability. The kit to enable Satellite reception is available through your dealer. Detailed Satellite instructions are included with the dealer installed kit. *Dealer installed satellite kit available only in the continental United States.*

Entertainment Systems

4. **MUTE:** Press to mute the playing media. Press again to return to the playing media or turn the volume control to adjust the volume.



5. **Eject:** Press to eject CD(s) when the ignition is on or off. Numbers will illuminate in the display indicating which CD slots are loaded with CDs. To eject a specific CD, press eject and the corresponding preset number. If no preset is selected, the system will eject the currently selected CD. Press and hold to eject all loaded discs.



Note: If the CD is not removed within approximately 15 seconds, the system will reload the disc and begin play if the system is on.

6. **BASS:** Press BASS; then press ◀ SEL-TEXT ▶ to decrease/increase the level of bass output.



TREB (Treble): Press TREB; then press ◀ SEL-TEXT ▶ to decrease/increase the level of treble output.



7. **BAL (Balance):** Press BAL; then press ◀ SEL-TEXT ▶ to shift sound to the left/right speakers.

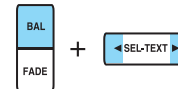

FADE: Press FADE; then press ◀ SEL-TEXT ▶ to shift sound to the rear/front speakers.

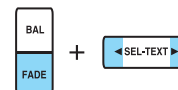

8. **SEL-TEXT:** Use with Bass, Treble, Balance, Fade and other menu functions.



TEXT: TEXT is only available when equipped with Satellite radio. Your vehicle may be equipped with Satellite ready capability. The kit to enable Satellite reception is available through your dealer. Detailed Satellite instructions are included with the dealer installed kit. *Dealer installed satellite kit available only in the continental United States.*

Entertainment Systems

9. **MENU:** Press MENU repeatedly to access RDS on/off.



Use ◀ SEL-TEXT ▶ to toggle

RDS on/off. Press MENU again to access Program type mode or Show Type mode. (MENU must be pressed within 10 seconds to proceed to the next RDS mode.)

The Federal Communications Commission (FCC) and the Canadian Radio and Telecommunications Commission (CRTC) recommend that FM radio broadcasters use RDS technology to transmit information. FM radio stations are independently operated and individually elect to use RDS technology to transmit station ID and program type as desired.

FIND Program type: Allows you to search RDS-equipped stations for a certain category of music format: Classic, Country, Info, Jazz, Oldies, R&B, Religious, Rock, Soft, Top 40.

With RDS ON, press MENU until the program type menu is displayed.

One of the various program types will appear. Press ◀ SEL-TEXT ▶ to scroll through music types. Press SEEK or SCAN to search for a station playing the requested music category.

Show TYPE: Selects between displaying the station's call letters or music format when RDS is enabled. Press and hold MENU until SHOW XX appears in the display. Press ◀ SEL-TEXT ▶ to select NAME or TYPE.

Compression: Brings soft and loud CD passages together for a more consistent listening level when in CD mode. Press MENU until compression status is displayed. Press ◀ SEL-TEXT ▶ to enable the compression feature when COMPRESS OFF is displayed. Press ◀ SEL-TEXT ▶ again to disable the feature when COMPRESS ON is displayed. When activated, the compression icon will illuminate in the display.

Occupancy mode: (Available on Audiophile audios only): Press MENU until occupancy mode appears in the display. Press ◀ SEL-TEXT ▶ to select ALL, DRIVER or REAR SEAT occupancy mode.

Autoset: Allows you to set the strongest local radio stations without losing your original manually set preset stations for AM/FM1/FM2. Press MENU until AUTOSET appears in the display. Press ◀ SEL-TEXT ▶ to toggle ON/OFF. When the six strongest stations are filled, the station stored in preset 1 will begin playing. If there are less than six strong stations, the system will store the last one in the remaining presets. When activated, AUTOSET will appear in the display when any of the preset controls are pressed.

Entertainment Systems

Speed sensitive volume: Radio volume changes automatically and slightly with vehicle speed to compensate for road and wind noise. Recommended level is 1–3. Level 0 turns the feature off and level 7 is the maximum setting.

Press MENU to access and use ◀ SEL-TEXT ▶ to adjust the volume setting. The level will appear in the display.

Setting the clock: Your vehicle is equipped with an in-dash clock. Refer to *Setting the Clock* in the *Driver Controls* Chapter.

10. **Memory presets:** To set a station: Select frequency band, tune to a station, press and hold a preset button until sound returns.

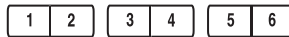

11. **On/Off/Volume:** Push to turn on/off; turn to adjust the volume levels.

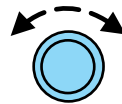

Note: With the ignition and audio system off, you may press the volume control to momentarily view the clock.

12. **LOAD:** Press to load a CD. Press LOAD and a specific preset to load in that particular slot. Available slots are indicated by small flashing indicators in the display. When the system is ready to accept a disc, LOAD CD X will appear in the display. Load the CD. Press and hold to autoloading up to six discs.



Note: Ensure that the system is ready to accept the CD and do not try to force the disc into the CD slot as damage could result.

13. **AM/FM:** Press repeatedly to toggle between AM/FM1/FM2 mode.



14. **CD:** Press to enter CD mode. Press CD and a preset to select a specific CD to play.



15. **SAT:** SAT is only available when equipped with Satellite radio. Your vehicle may be equipped with Satellite ready capability. The kit to enable Satellite reception is available through your dealer. Detailed Satellite instructions are included with the dealer installed kit. *Dealer installed satellite kit available only in the continental United States.*

Entertainment Systems

16. **SHUF/SCAN:** Press SCAN to hear a brief sampling of radio stations or CD tracks. Press again to stop.

SHUF (Shuffle): Press and hold to play the CD tracks in random order for the CD currently being played. Press again to stop.

AUDIOPHILE AM/FM STEREO/CASSETTE/SINGLE CD (IF EQUIPPED)

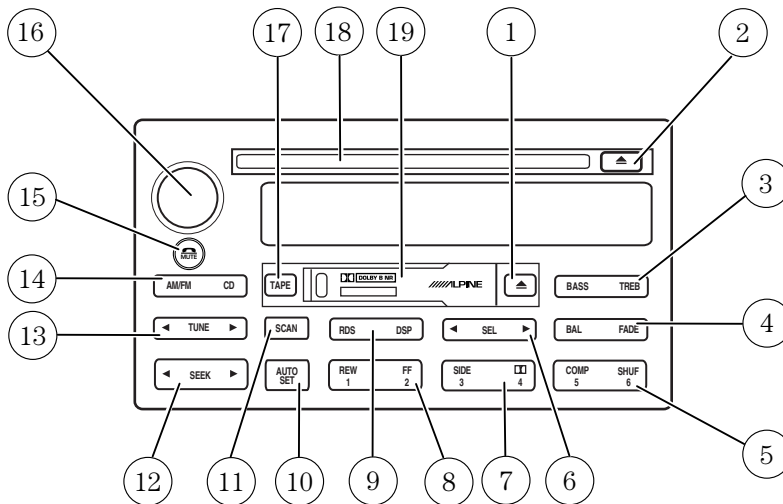

Entertainment Systems

PREMIUM AM/FM STEREO/CASSETTE/SINGLE CD (IF EQUIPPED)

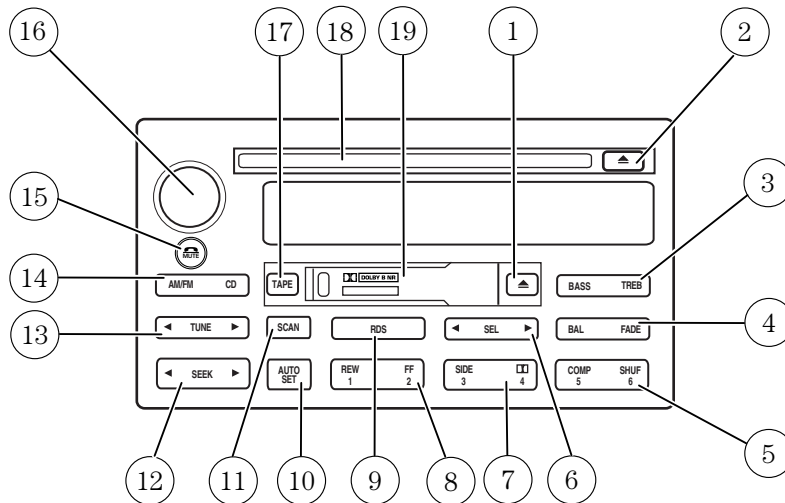

1. **Eject:** Press to eject a tape.



2. **Eject:** Press to eject a CD.



3. **Bass:** Allows you to increase or decrease the audio system's bass output. Press BASS then press SEL to decrease ◀ or increase ▶ the bass levels.



Treble: Allows you to increase or decrease the audio system's treble output. Press TREB then press SEL to decrease ◀ or increase ▶ the treble levels.



4. **Balance:** Allows you to shift speaker sound between the right and left speakers. Press BAL then press SEL to shift sound to the left ◀ or right ▶.



Entertainment Systems

Fade: Allows you to shift speaker sound between the front and rear speakers. Press FADE then press SEL to shift the sound to the rear ◀ or the front ▶.



5. **COMP (Compression):** In CD mode, press to bring soft and loud passages together for a more consistent listening level.



SHUF (Shuffle): Press to play CD tracks in random order.



6. **Select:** Use to adjust bass, treble, balance and fade levels.



7. **Side 1-2:** Press to change sides on the tape.



Dolby:  **Dolby® noise reduction:** Reduces tape noise and hiss; press to activate/deactivate.



8. **REW (Rewind):** Works in tape and CD modes.



In tape mode, radio play continues until rewind is stopped (with the TAPE control) or the beginning of the tape is reached.

In CD mode, REW control reverses the CD within the current track.

FF (fast forward): Works in tape and CD modes.



In the tape mode, tape direction automatically reverses when the end of the tape is reached.

In CD mode, FF advances the CD within the current track.

9. **Digital signal processing (if equipped):** Press to adjust the occupancy modes between the following:



- ALL SEATS
- DRIVER SEAT

Entertainment Systems

- REAR SEATS

RDS: (Radio Data System): Allows you to access FM stations which are RDS- equipped. Press RDS then SEL to select from:



Traffic — Allows you to receive traffic announcements and control their volume level. **Traffic information is not available in most U.S. markets.**

Show — Allows you to view the frequency and program type of the chosen radio station.

The Federal Communications Commission (FCC) and the Canadian Radio and Telecommunications Commission (CRTC) recommend that FM radio broadcasters use RDS technology to transmit information. FM radio stations are independently operated and individually elect to use RDS technology to transmit station ID and program type as desired.

Setting the clock: Your vehicle is equipped with an in-dash mounted clock. Refer to *Clock* in the Driver Controls Chapter for further information.

10. **Autoset:** Press to set first six strong stations into AM, FM1 or FM2 memory buttons; press again to return to normal stations.



11. **Scan:** Works in radio, tape and CD modes. Press SCAN for a brief sampling of radio stations, tape selections or CD tracks.



12. **Seek:** Works in radio, tape and CD modes. Press to access the previous ◀ or next ▶ listenable radio station, tape selection or CD track.



13. **Tune:** Works in radio mode. Press to manually advance up or down the frequency band.



14. **AM/FM/CD:** Press AM/FM to select a radio frequency. Press while in tape or CD mode to return to radio mode. Press CD to enter CD mode and to play a CD already in the system.



Entertainment Systems

15. **Mute mode:** Press to mute the playing media.



16. **Power/volume:** Press to turn the system on/off. Turn to raise/lower the volume.

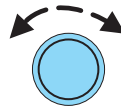

17. **Tape:** Press to play the tape.



18. **CD door:** Insert the disc with the playing side down and printed side up.

19. **Tape door:** Insert the tape facing the right.

REAR CONSOLE AUDIO CONTROLS (IF EQUIPPED)

- **NEXT:** Press to access the next radio memory preset, the next CD track or the next tape selection.
- **VOL:** Press the up arrow to increase the volume or the down arrow to decrease the volume.
- **MODE:** Press to toggle through AM, FM1, FM2, TAPE or CD (if equipped) modes.

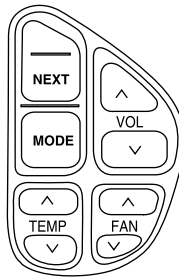

ACCESSORY DELAY

With accessory delay, the window switches, moon roof (if equipped) and audio system may be used for up to ten minutes after the ignition switch is turn to the OFF position or until any door is opened.

RADIO FREQUENCIES

AM and FM frequencies are established by the Federal Communications Commission (FCC) and the Canadian Radio and Telecommunications Commission (CRTC). Those frequencies are:

AM - 530, 540–1700, 1710 kHz

FM- 87.7, 87.9–107.7, 107.9 MHz

Entertainment Systems

RADIO RECEPTION FACTORS

There are three factors that can affect radio reception:

- Distance/strength: The further you travel from an FM station, the weaker the signal and the weaker the reception.
- Terrain: Hills, mountains, tall buildings, power lines, electric fences, traffic lights and thunderstorms can interfere with your reception.
- Station overload: When you pass a broadcast tower, a stronger signal may overtake a weaker one and play while the weak station frequency is displayed.

CASSETTE/PLAYER CARE

Do:

- Use only cassettes that are 90 minutes long or less.
- Tighten very loose tapes by inserting a finger or pencil into the hole and turning the hub.
- Remove loose labels before inserting tapes.
- Allow tapes which have been subjected to extreme heat, humidity or cold to reach a moderate temperature before playing.
- Clean the cassette player head with a cassette cleaning cartridge after 10–12 hours of play to maintain good sound/operation.

Don't:

- Expose tapes to direct sunlight, extreme humidity, heat or cold.
- Leave tapes in the cassette player for a long time when not being played.

CD/CD PLAYER CARE

Do:

- Handle discs by their edges only. Never touch the playing surface.
- Inspect discs before playing. Clean only with an approved CD cleaner and wipe from the center out.

Don't:

- Expose discs to direct sunlight or heat sources for extended periods of time.
- Insert more than one disc into each slot of the CD changer magazine.
- Clean using a circular motion.

Entertainment Systems

CD units are designed to play commercially pressed 4.75 in (12 cm) audio compact discs only. Due to technical incompatibility, certain recordable and re-recordable compact discs may not function correctly when used in Ford CD players. Irregular shaped CDs, CDs with a scratch protection film attached, and CDs with homemade paper (adhesive) labels should not be inserted into the CD player. The label may peel and cause the CD to become jammed. It is recommended that homemade CDs be identified with permanent felt tip marker rather than adhesive labels. Ball point pens may damage CDs. Please contact your dealer for further information.

AUDIO SYSTEM WARRANTY AND SERVICE

Refer to the *Warranty Guide* for audio system warranty information. If service is necessary, see your dealer or qualified technician.

CD CHANGER (IF EQUIPPED)

Your CD changer is located in the trunk.

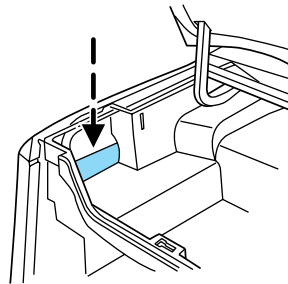

1. Slide the door to access the CD changer magazine.

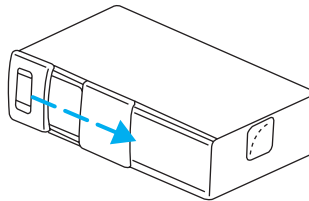

Entertainment Systems

2. Press ▲ to eject the magazine.

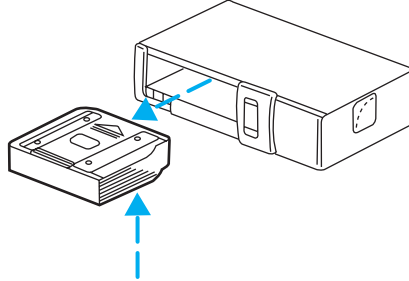

3. Pull the lever to remove a CD tray from the magazine.

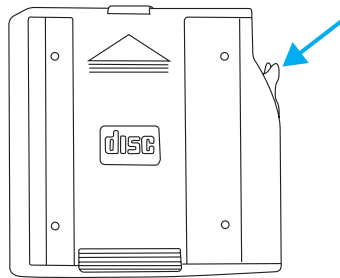

4. Insert one disc into each CD tray of the magazine (up to 6 discs). Ensure that the label side is facing up.

If you pull too hard on the disc holder, the disc holder may come completely out of the magazine. If this happens, reinsert the disc holder back into the magazine.

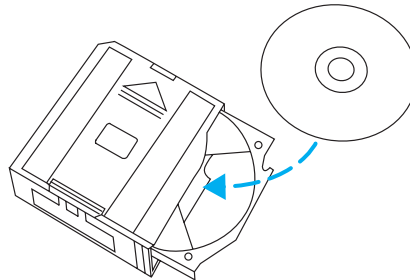

5. Insert each CD tray, with the disc loaded, all the way into the CD magazine.

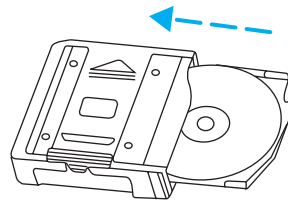

Entertainment Systems

6. Insert the CD magazine into the changer.

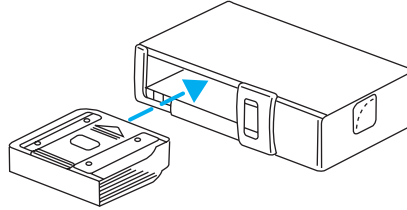

7. Slide the door to the left to close.

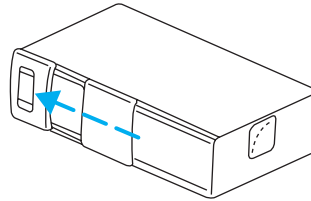

Use only compact discs containing this mark.



The magazine does not need to be full for the changer to operate.

Radio power must be turned on to play the CDs in the changer. The magazine may be stored in the glove compartment when not being used.

The CD magazine may be inserted or ejected with the radio power off.

Do not insert any promotional (odd shaped or sized) discs, or discs with removable labels into the CD player as jamming may occur.

LINCOLN NAVIGATION SYSTEM (IF EQUIPPED)

Your vehicle may be equipped with a Lincoln Navigation System which allows you to listen to the radio, play CDs and also navigate the vehicle using a navigation DVD.

Entertainment Systems

THX audio system (if equipped)

Your vehicle may be equipped with the THX® certified premium audio system. This system creates optimal acoustic quality for all seating positions and road conditions.

The system offers an advanced speaker system, amplifier, subwoofer and equalizer.



Your Lincoln Navigation System has a large range of features, yet is easy to use. Guidance is shown on the display screen and is supplemented with voice prompts. The display screen provides full information for operating the system through use of menus, text screens and map displays. Screen selections are made by touching the desired selection on the screen.

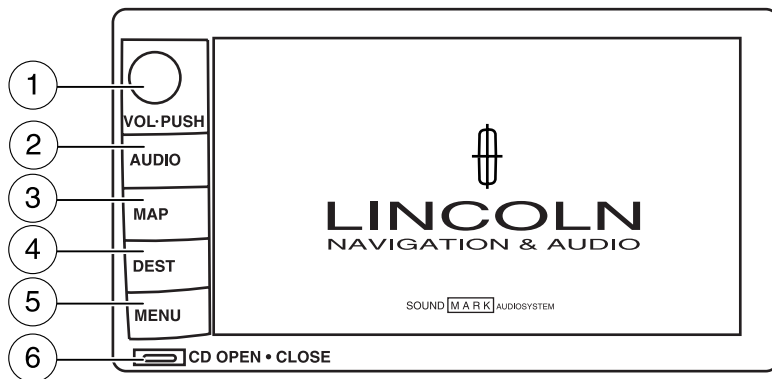

1. **VOL-PUSH:** Press to turn the system ON/OFF. Turn to adjust the audio volume level.
2. **AUDIO:** Press to enter audio mode and access radio, CD, CDDJ, DVD (if equipped) settings.
3. **MAP:** Press to enter map mode and view your current vehicle position on the map. Press and hold to obtain additional position information. This will not function without a map DVD loaded.

Entertainment Systems

4. **DEST:** Press to enter Destination Entry mode. This allows you to enter a destination and route to it. With an active route, pressing DEST allows the user to request a Detour, display entire route, select route preferences, or change or cancel the destination. This will not function without a map DVD loaded.
5. **MENU:** Press to access system settings such as display, brightness, clock mode (if equipped), etc.
6. **CD OPEN CLOSE:** Press to open/close the display screen and access the CD player.

Cold temperature advisory

When operating the system below 32° Fahrenheit (0° Celsius), the display screen requires 20–30 minutes warm-up to achieve maximum brightness. Ensure that the system display setting is set to DAY mode until maximum brightness is achieved (refer to *Menu mode* section). Once maximum brightness is achieved, revert to AUTO mode display setting.

Initial map display

After pressing AGREE to the initial WARNING screen, you will move into the initial map screen which shows the current vehicle location. Pressing the globe icon will take you to the user settings — audible feedback, navigation units, language and clock (if equipped).



Quick Start — How to get going

To play a radio station:

1. Ensure that the vehicle ignition is on.
2. Press AUDIO.

Entertainment Systems

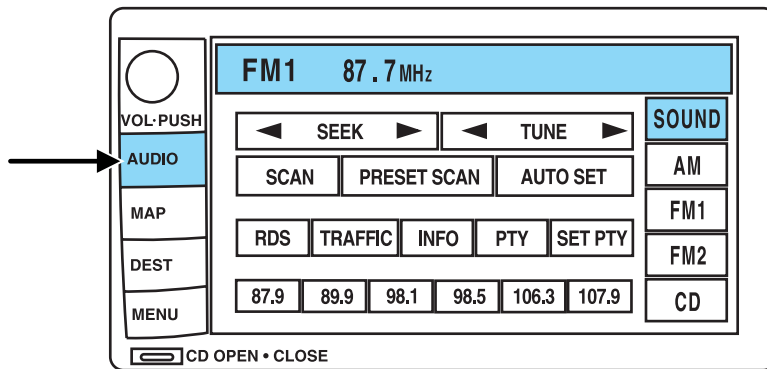

3. Select AM, FM1 or FM2.
4. Press TUNE to adjust manually up (▶) or down (◀) the frequency band.
5. Press SEEK to find the next strong station up (▶) or down (◀).

Note: If PTY (program type) is selected, the station selection will be limited. Refer to *Program Type (PTY)* for further information.

To play a previously loaded CD:

1. Ensure that the vehicle ignition is on.
2. Press AUDIO.
3. Press CD to select a CD which is already loaded. (NO CD will appear in the display if there are no CDs loaded into the system). Use the controls (1–6) to select the desired CD.
4. CD will begin to play.

Entertainment Systems

To load CDs:

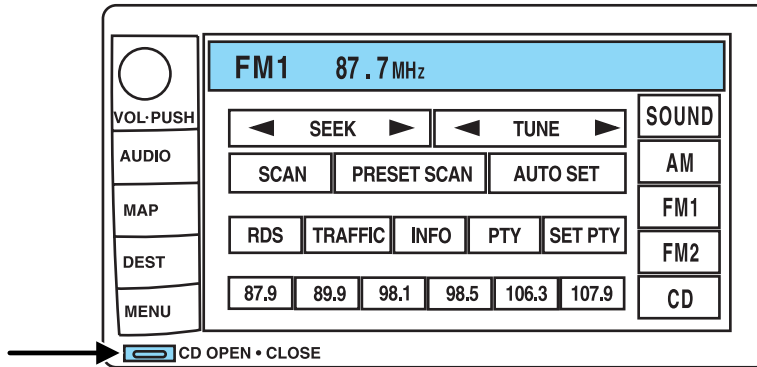

1. Press CD OPEN CLOSURE at the bottom of the screen to load a CD. (The screen will open).
2. Press LOAD and select the desired slot. Or, press and hold LOAD to auto load all available slots. The slot indicator lights blink rate will increase when the system is ready to accept a disc. Push CD OPEN CLOSURE to close the screen. Once closed, the CD will begin to play.
3. Use the touch controls to advance tracks, scan, pause, etc.

To use the Navigation system:

1. Ensure that the vehicle ignition is on, and the navigation DVD is loaded into the navigation DVD player. Refer to *Loading the map DVD* or *Navigation system — DVD location* in the Index for your vehicle's navigation DVD location.

Entertainment Systems

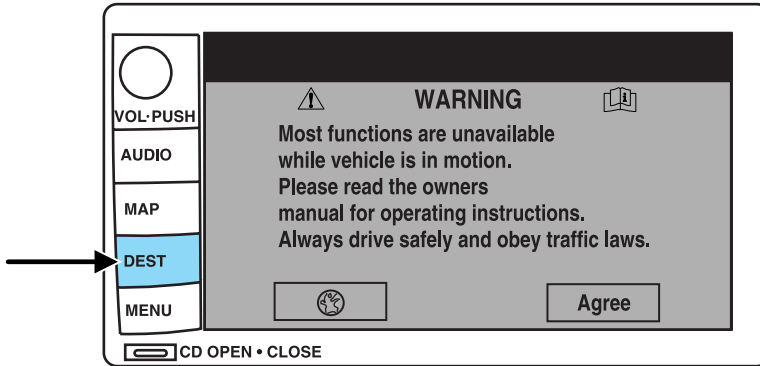

2. Press DEST. The warning screen will appear. After reading, press AGREE. The screen will show a map with your current location. Press DEST again.

3. Select the desired type of destination entry. You may select “Address”, “Point of Interest”, “Emergency” or “Previous Dest” from the first screen.

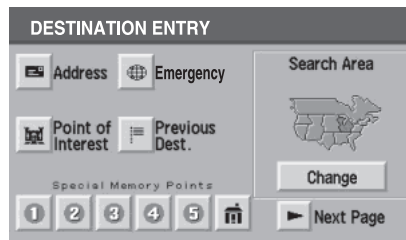

Or, press “▶ Next Page” to access selections of “Memory Point”, “Select from map”, “Freeway Ent/Exit” and “Special Memory Points.” After making your selection, enter any required information.

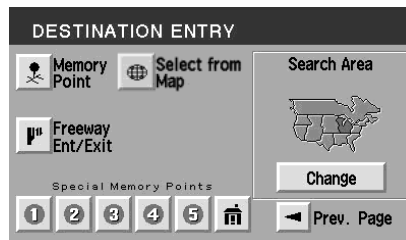

Entertainment Systems

4. Press DEST at the bottom of the map screen.
5. Choose the desired route by pressing the NEXT button (if it appears). There can be up to three alternative routes.
6. Press START to begin the navigation guidance.

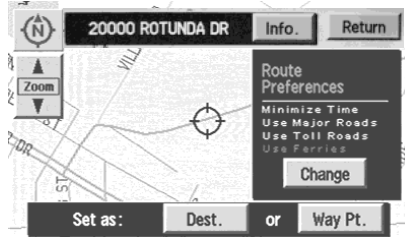

To adjust the voice guidance volume:

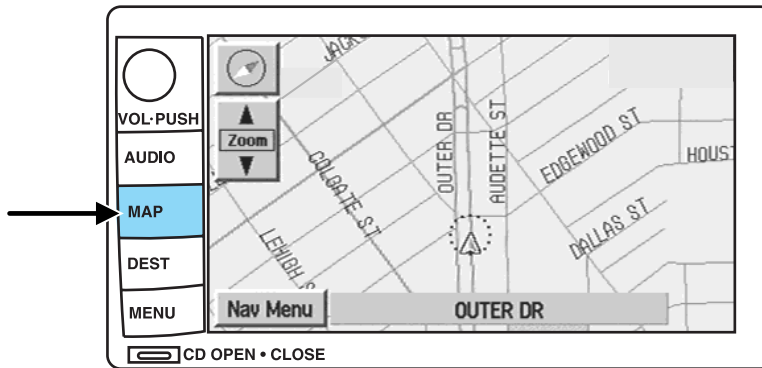

1. Press the MAP hard key.
2. Press “Nav Menu” at the bottom left hand corner of the screen.
3. Press On/Off to turn the voice guidance option on/off. Use the numeric keys (1–7) to determine the volume level of the guidance voice prompts.



Voice activated commands (if equipped)

Your Lincoln Navigation System (LNS) may be equipped with a voice activated feature which allows you to “speak” certain commands to the system. Speaking clearly will help to ensure that the system correctly responds to your commands. Ensure that the commands are spoken in English (not any other language) and that they are spoken exactly as they are written, or they may not function.

Entertainment Systems

Press VOICE briefly (on your steering wheel controls) and the voice icon  appears on the Navigation display. Press the REPEAT button or arrow on your steering wheel controls to hear the previous command repeated from the navigation system.

The voice activated command feature will not operate if a map DVD is not inserted into the navigation DVD unit.

At any time, you may say these commands to change modes:

- Radio
- AM
- FM1
- FM2
- CD
- Power on
- Audio on
- Audio off
- Power off
- CD Changer (if equipped)
- DVD (if equipped)

During normal radio operation, you may say:

- Seek up
- Seek down

Disc operation commands you may say when using a rear seat DVD (if equipped):

- Track up
- Previous track
- Disc down
- Previous disc
- Track down
- Disc up
- Next disc

During CDDJ or in-dash CD play, you may say:

- Track up
- Previous track
- Next disc
- Previous disc
- Track down
- Disc up
- Disc down

To change the screen display, you may say the following commands:

- Screen off
- Day mode on
- Night mode on
- Auto mode on
- Screen day mode
- Screen night mode
- Screen auto mode

Note: If you say “Screen off”, you must touch the screen in order to activate the screen again. The screen will not turn on again with a voice command.

Entertainment Systems

Commands that jump over screens:

- Current position
- Map
- Current location

While in navigation map mode, the following commands are available:

- Zoom in
- Minimum scale
- North up
- Heading up
- Map direction
- Mark this point
- Zoom out
- Maximum scale
- Change to North up
- Change to heading up
- Change map direction
- Mark

While in navigation POI mode, the following commands are available by voice activation:

- Automobile club
- Auto service & maintenance
- Gas station
- Parking garage
- ATM
- City hall
- Community center
- Exhibition center
- Higher education
- College
- Library
- School
- Casino
- Marina
- Park & recreation
- Performing arts
- Skiing
- Stadium
- Winery
- I'm hungry
- American food
- AAA (Triple A)
- Auto service
- Gas
- Parking lot
- Bank
- Civic center
- Convention center
- Court house
- University
- Hospital
- Police station
- Amusement park
- Golf course
- Museum
- Parks & recreation
- Ski resort
- Sports complex
- Tourist attraction
- Restaurant
- American restaurant
- Chinese restaurant

Entertainment Systems

- Chinese food
- Continental food
- French food
- Italian food
- Japanese food
- Mexican food
- Seafood
- Other food
- Shopping mall
- Airport
- Ferry terminal
- Hotel
- Rental car agency
- Rest stop
- Train station
- City center
- Commuter rail station
- Continental restaurant
- French restaurant
- Italian restaurant
- Japanese restaurant
- Mexican restaurant
- Seafood restaurant
- Other restaurant
- Shopping
- Grocery store
- Bus station
- Historical monument
- Park and ride
- Rest area
- Tourist information
- Business facility
- POI off

While in navigation destination (DEST) mode, the following commands are available:

- Home
- Previous starting point
- Next way point map
- Second way point map
- Fourth way point map
- Destination map
- Cancel destination
- Go home
- Go starting point
- First way point map
- Third way point map
- Fifth way point map
- Delete destination

While in navigation guidance mode, the following commands are available by voice activation:

- Repeat guidance
- Louder
- Voice guidance off
- Open guidance screen
- Arrow guidance
- Repeat voice
- Softer
- Voice guidance on
- Close guidance screen
- Arrow guide

Entertainment Systems

- Change to arrow guidance
- Turn list guidance
- Change to turn list guidance
- Entire route map
- Route overview
- Detour
- Change to arrow guide
- Turn list guide
- Change to turn list guide
- Entire route
- Reroute
- Detour entire route

Navigation help commands you may speak at any time:

- Help
- Destination
- Radio
- Map help
- Guidance help
- Disc help
- Map
- Guidance
- Disc
- Destination help
- Radio help

Audio mode

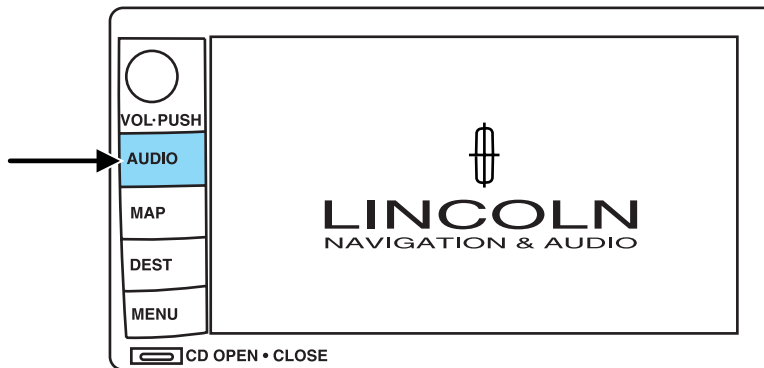

Your Lincoln Navigation Audio System has many features including a full range of audio functions. To access these functions, press AUDIO on the main bezel. This will take you into audio mode.

Entertainment Systems

Volume/power control

Press knob to turn the audio system on/off. Turn to raise or lower volume. The levels will be displayed on the screen.

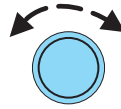

To activate the navigation mode, press MAP or DEST.

To adjust the navigation voice output level, select the NAV MENU button via the map screen.

Speed compensated volume (SCV)

With this feature, radio volume changes automatically with vehicle speed to compensate for road and wind noise. To engage the SCV feature:

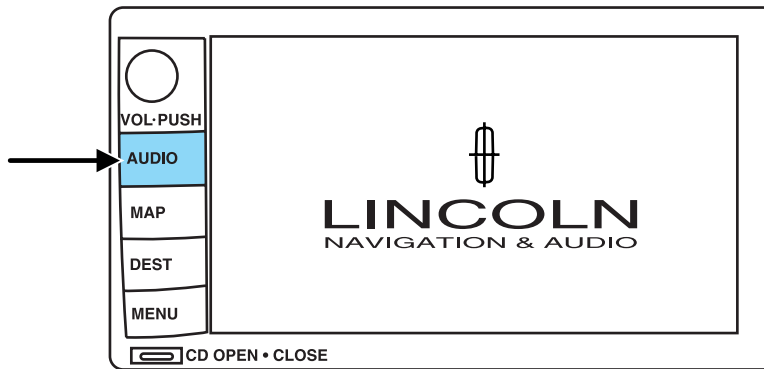

1. Press AUDIO.
2. Press SOUND.

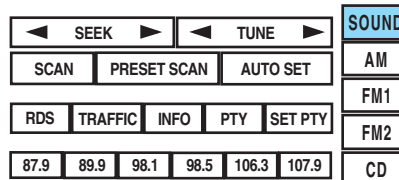

Entertainment Systems

3. SCV is located in the middle of the screen. Press to turn on.
4. Select setting 1 to 7 or turn off.

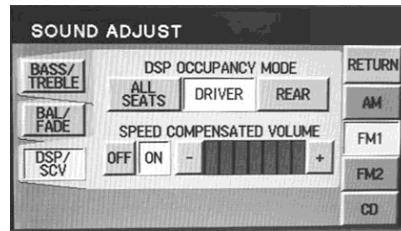

The recommended level for the speed compensated volume is from level 1 through level 3. When activated, level 1 is the minimum setting and level 7 is the maximum setting.

AM/FM select

The AM/FM control works in radio, CD and navigation modes.

AM/FM select in radio mode

Press AM/FM1/FM2 to switch between AM/FM1/FM2 memory preset stations.

AM/FM select in CD mode

Press to stop CD play and begin radio play.

AM/FM select in navigation mode

The radio will continue to play in the background of the navigation screens. To access, press AUDIO then AM/FM1/FM2.

Seek

- Press ► / ◀ to find the next listenable station up/down the frequency band.
- Press ► / ◀ to advance to the next/previous track on a CD.

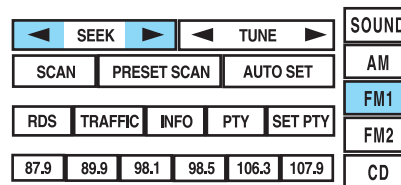

Entertainment Systems

Tune adjust

Press TUNE to manually move down/up (◀/▶) the frequency band.

In CD mode, press TRACK to select the previous/next (◀/▶).

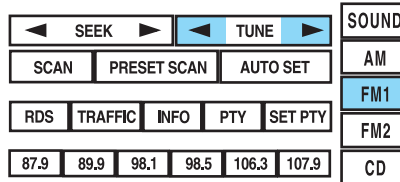

Autoset memory preset

Autoset allows you to set strong radio stations without losing your original manually set preset stations. This feature is helpful on trips when you travel between cities with different radio stations.

Starting autoset memory preset

1. Select a frequency band using AM/FM1/FM2.

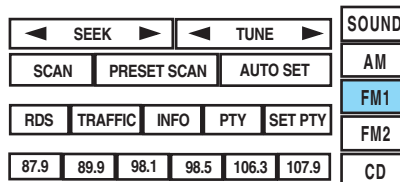

2. Press AUTO SET.

3. When the first six strong stations are filled, the station stored in memory preset control 1 will start playing.

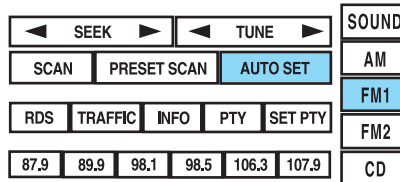

If there are less than six strong stations available on the frequency band, the remaining memory preset controls will all store the last strong station available.

To deactivate autoset and return to your audio system's manually set memory stations, press the AUTO SET again.

Entertainment Systems

Scan

Press SCAN for a brief sampling of all listenable stations and CD tracks. Press again to disable and remain on the current selection.

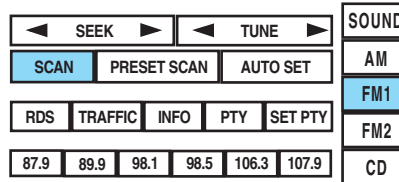

Preset scan

Press PRESET SCAN to scan the stations stored in the memory presets.

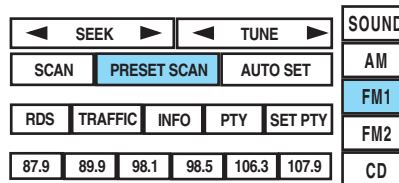

Radio data system (RDS) feature

This feature allows your audio system to receive text information from RDS-equipped FM radio stations such as station call letters, program type, etc. When in FM mode, press RDS to activate/deactivate.

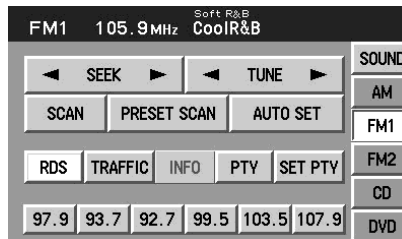

Traffic function

Select TRAFFIC for traffic information broadcast from certain stations which will automatically interrupt radio or CD playback at a preset volume level.

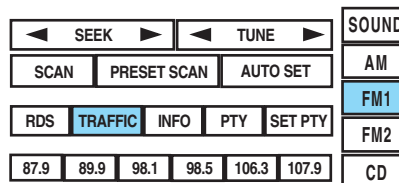

Entertainment Systems

Traffic information not available in most U.S. markets.

Information feature

Press INFO to view the frequency, call letters and PTY category of the selected FM station.

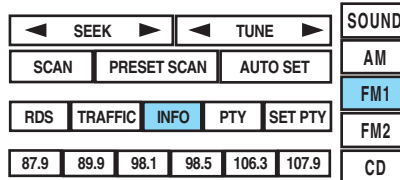

Note: Not all stations support INFO function.

Program type (PTY)

This feature allows you to search for Radio Data System (RDS) stations selectively by their program type.

Ensure that the RDS function is turned on. Press PTY to turn the feature on/off.

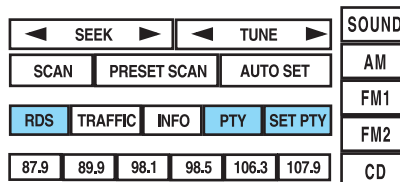

To set/change PTY:

Ensure that the RDS function is turned on. Press SET PTY to select from the following program types:

- All
- Classical
- Country
- Information
- Jazz
- Religious
- Rock

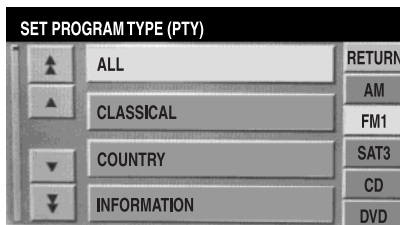
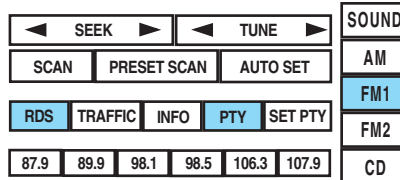

Entertainment Systems

- Soft
- Top 40

Once PTY has been programmed, press SEEK (▶ / ◀) or SCAN to initiate a search up or down the frequency.

Preset scan and Autoset also initiate PTY searches. The search will stop when the desired program type has been reached. If no program type is found, a message will display.

Note: Not all stations support PTY information.

Sound functions

To access settings for Bass, Treble, Balance, Fade, DSP (Digital Signal Programming), SCV (Speed Compensated Volume), and Occupancy modes:

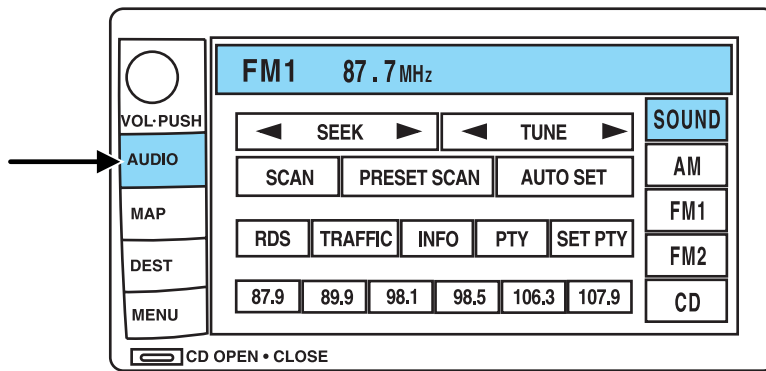

1. Press AUDIO.
2. Press SOUND.
3. Select from Bass/Treb; Bal/Fade; DSP/SCV.
4. Press +/- to increase/decrease the levels.

Entertainment Systems

Bass : Allows you to increase or decrease the audio system's bass output.

Treble : Allows you to raise or lower the audio system's treble output.

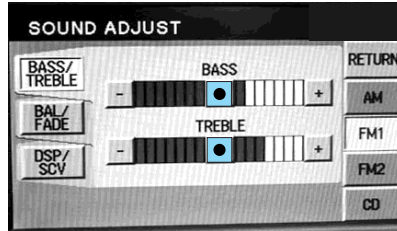

Fade : Allows you to adjust the amount of sound emitted from the front and rear speakers.

Balance : Allows you to adjust the sound distribution between the right and left speakers.

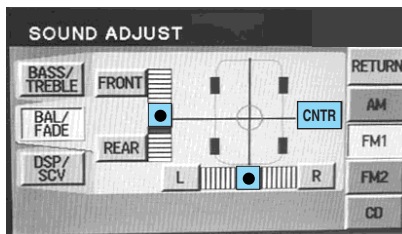

SCV (Speed Compensated Volume): Automatically compensates for road wind and noise. Refer to *Speed compensated volume* earlier in this chapter.

DSP Occupancy mode: Use to optimize the sound based upon the occupants in the vehicle. Select from ALL SEATS, REAR SEATS or DRIVER SEAT.

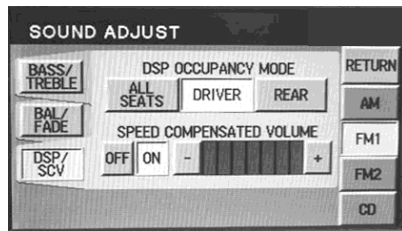

Setting memory preset stations

The radio is equipped with six station memory preset controls. These controls can be used to select up to six preset AM stations and twelve FM stations (six in FM1 and six in FM2).

1. Select the frequency band with the AM/FM1/FM2 touch controls.
2. Select a station.
3. Press and hold a memory preset until the sound returns. The frequency will appear in the preset.

Entertainment Systems

Satellite ready capability

Your Lincoln navigation system comes equipped with Satellite ready capability. The kit to enable Satellite reception is available through your Lincoln dealer. Detailed Satellite instructions are included with the dealer installed kit.

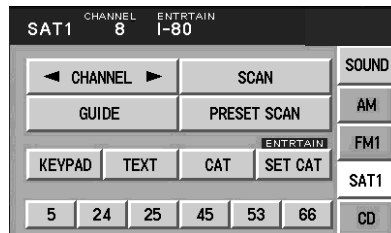

CD mode

CD units are designed to play commercially pressed 4.75 in (12 cm) audio compact discs only. Due to technical incompatibility, certain recordable and re-recordable compact discs may not function correctly when used in Ford CD players. Irregular shaped CDs, CDs with a scratch protection film attached, and CDs with homemade paper (adhesive) labels should not be inserted into the CD player. The label may peel and cause the CD to become jammed. It is recommended that homemade CDs be identified with permanent felt tip marker rather than adhesive labels. Ball point pens may damage CDs. Please contact your dealer for further information.

Playing a previously loaded CD:

To begin CD play (if a CD is already loaded), press AUDIO hard button and then CD.

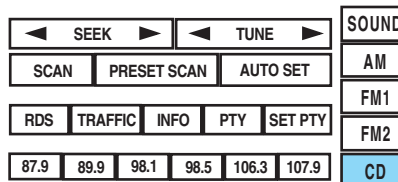

Entertainment Systems

Press CD. CD play will begin where it stopped last.

Loading a CD:

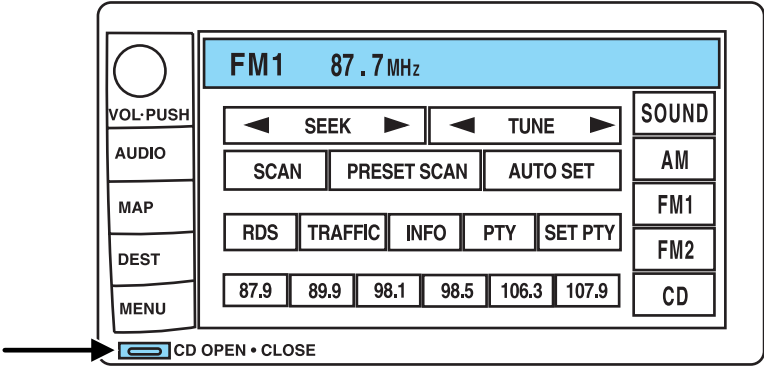
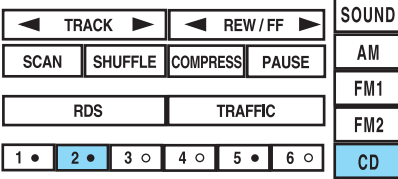

1. Press CD OPEN CLOSE on the bezel.

Entertainment Systems

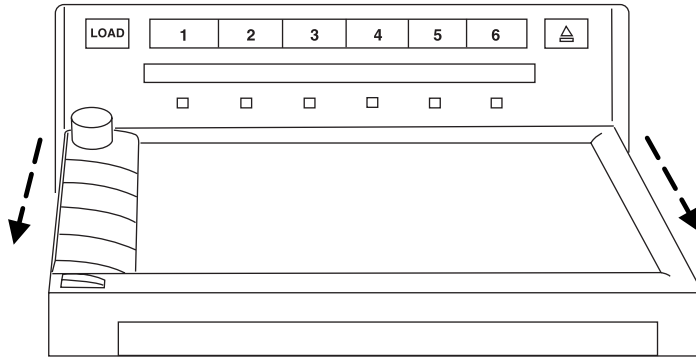

2. The navigation screen will fold down, allowing you access to the in-dash six CD system.
3. Press LOAD and the desired CD slot number. The indicator light will blink slowly at first, then quickly, signaling the system is ready.
4. Insert a disc.
5. **To load more than one disc**, press and hold LOAD. This will initiate autoload and will allow you to load all open CD slots. After an allotted time, the screen will close automatically or you may press CD OPEN CLOSE on the bezel again.
6. Once the screen closes, the system will start playing the last CD loaded.

Track

Press ► / ◀ to advance to the next/previous track.

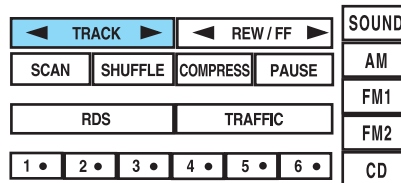

Entertainment Systems

Rewind/fast forward in CD mode

Press to reverse or advance (◀ / ▶) in the current CD track.

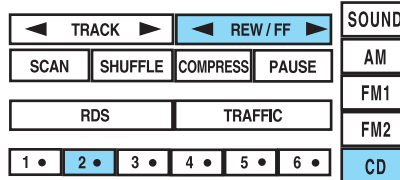

Scan feature in CD mode

Press SCAN to hear a brief sampling of all tracks on the current CD. Press again to disengage and remain with the current track.

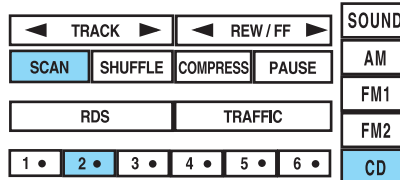

Shuffle feature in CD mode

When in CD (or CDDJ mode), press SHUFFLE to engage the shuffle feature. Press to select from shuffling between tracks (SHUFFLE TRACK) on the current CD or between all tracks on all CDs (SHUFFLE DISC). All tracks will be played in random order. Press again to disengage (SHUFFLE OFF).

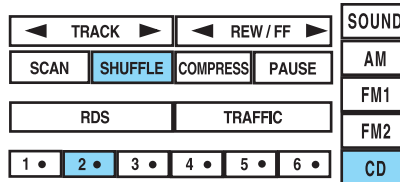

Compression feature

The compression feature works in CD mode and boosts more quiet music and lowers louder music to minimize the need for volume adjustments.

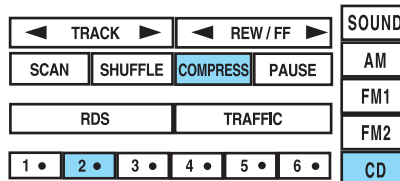

When in CD or CDDJ mode, press COMPRESS to engage or disengage the compression feature.

Entertainment Systems

Pause

In CD mode, press PAUSE to pause the current track. Press again to continue playing.

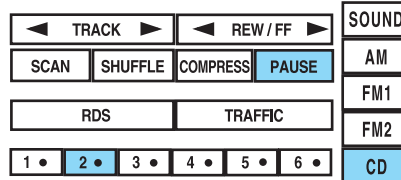

Map mode

Map display information

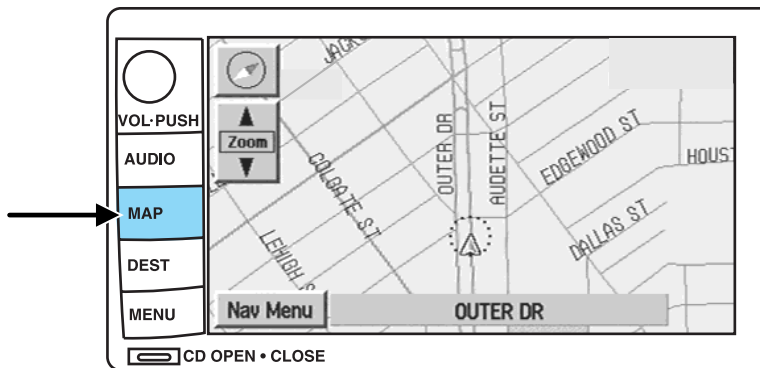

To access the map display, press MAP on the bezel.

Once pressed, the current map display will appear on the screen showing the current vehicle location.



Entertainment Systems

Zoom control

When 'Zoom' is pressed, the scale indicator is shown on the screen. The scale markings are: 1/32, 1/16, 1/4, 1/8, 1/2, 1, 2, 4, 8, 16, 32, 64, 128 miles. The control can be used in a number of ways:

- Touch and hold one of the arrow buttons for the map to be displayed again at each zoom level.
- Touch one of the arrow buttons repeatedly for the map to be displayed again at the final zoom level.
- Touch one of the segments of the scale indicator for the map to be displayed at the selected zoom level.

Additional map function buttons

To initiate the display of additional map function buttons, tap the map anywhere on the screen or press the MAP hard key. These additional features will disappear from the screen within five seconds unless pressed.

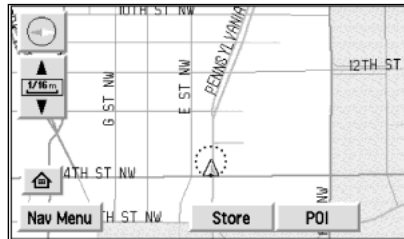

- **STORE** - stores current vehicle location as a memory point. Refer to *Memory Points* for further information.
- **POI** (Point of Interest)- brings up the Quick POI menu which allows the user to perform two functions:
Display POI icons on the map for one category.
Select local map area POIs as destinations or waypoints. The list of local area POIs can be sorted by distance, name, or icon. Refer to *Points of Interest* for further information.

If home has been previously programmed in the "Nav Menu", the home icon (house) will appear on the screen and is able to be selected as a destination.

To delete POI icons from the map, touch the map again and press the POI off button.

Entertainment Systems

Route preferences

After entering a destination, the Route preferences will appear on the screen showing what is currently selected. You may choose to activate/deactivate selections which the system will factor in when calculating your route. Those options are:

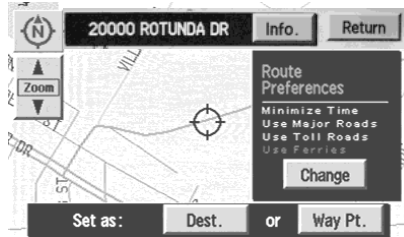

- Minimize Time/Distance
- Use Major Roads
- Use Toll Roads
- Use Ferries

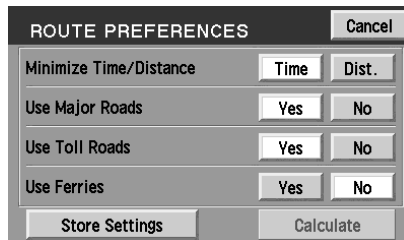

Information function

INFO will appear on the screen when you have calculated a destination. Press INFO for more information about the current destination, if available.

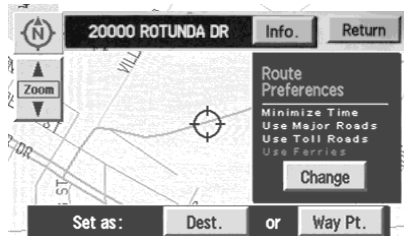

Entertainment Systems

You will be able to view the information (if available) as well as choose to store the destination as a memory point by pressing OK.

PREVIOUS DESTINATION		Return
Store as memory point		OK
Name	: MILITARY ST, DEARBORN, MI	
Address	: MILITARY ST	
City	: DEARBORN, MI	

Screen symbols

Navigation symbol — Indicates the current vehicle position and points to the direction in which the vehicle is currently traveling.



Destination symbol — Indicates the current route destination.

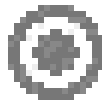

Next turn symbol — Shows the next maneuver that will need to be taken on the current route.



North up button — Indicates that the map is displayed with north to the top of the screen. Press to toggle between “North up” and “Heading up” map display states.



Heading up button — Indicates that the map is displayed with the vehicle heading to the top of the screen. The position of the pointer indicates the direction of north on the map. Press to toggle between “North up” and “Heading up” map display states.



Entertainment Systems

Avoid areas or points — The “X” symbol indicates a point to be avoided in route calculations.



If the avoid point is enlarged to an avoid area, it will appear on the screen as a shaded box.



Way point symbol — Indicates the location of a way point (locations you wish to visit in route to your ultimate destination) on the map.



Home position symbol — Indicates the location on the map, currently stored as the home position.



Stored location symbol — Indicates the location of a memory point. This is the default symbol used when the point is stored. (If desired, an icon of your own choice can be selected from the 15 icons available.) Refer to *Choosing from the icon list*.



GPS symbol— Indicates that insufficient GPS satellite signals are being received for accurate map positioning. The symbol is not displayed under normal operation.



Speaker icon symbol— Press to turn voice guidance on/off.



Navigation menu

To access the Navigation Menu, press NAV MENU at the bottom of the map screen.



Entertainment Systems

Once pressed, the Navigation Menu will display showing the following options:

- Route Options/Preferences
- Navigation Set Up
- Display Options
- Stored Locations
- On Route Scroll
- Voice Guidance/Volume

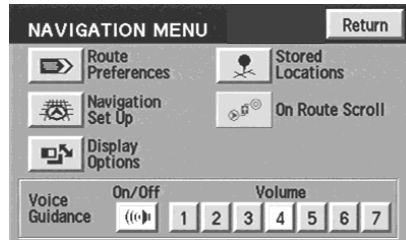

Depending upon whether or not a route is active will determine if route options/route preferences is contained on the Navigation Menu.

Route options (destination entered)

Once in navigation mode and a route is currently active, press “Chng. route” to access the ROUTE OPTIONS screen. Choose from the following selections:

- **Detour:** Press to select a detour around the current route. Refer to *Detour options* later in this chapter for further information.
- **Route Preferences:** When creating a destination, select from: Minimize Time/Distance, Use Major Roads, Use Toll Roads, Use Ferries.
- **Display Whole Route:** Will enter MAP mode and display your entire chosen route.

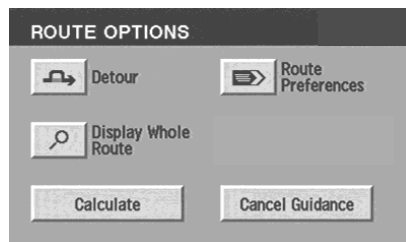

Note: Route preference appears on the Nav menu when no destination is entered.



While driving under route guidance, only follow an instruction when it is safe to do so as the system cannot be aware of changing conditions. Use voice guidance as much as possible, and only view the display when driving conditions permit.

Entertainment Systems

 Ensure that you follow highway code restrictions and do not take any risks. For example, if you are unable to make a U-turn, continue on your journey. The navigation system will recalculate your route to get you back to an appropriate road to your destination.

Navigation set up

The Navigation Set up screen will allow you to make adjustments to the navigation displays.

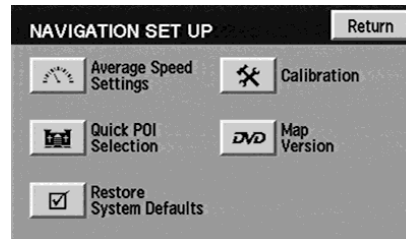

Average speed settings

Allows you to set approximate speeds you drive. These speeds enable the navigation system to aid in calculating timing for routes.

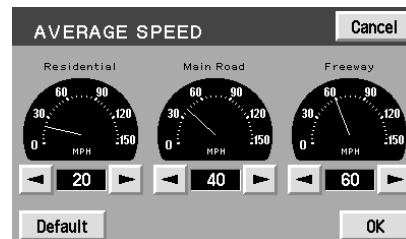

Quick POI (Point of Interest)

Allows you to change the Quick POI menu settings. Select the desired Quick POI (Gas, ATM, etc.) and then press 'List Categories' for further categories, or 'Map Area POIs' to show the desired POIs on your current map.

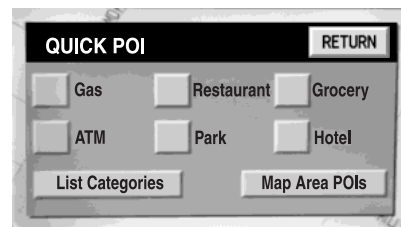

Entertainment Systems

Restore system defaults

Resets all system user-selectable options to the default (automatic) values (i.e. guidance, voice, search area and route preferences).

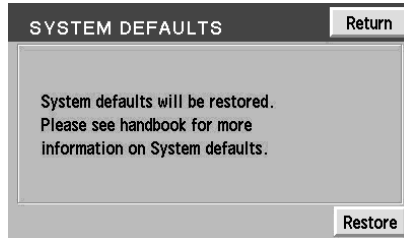

Calibration

This feature is helpful if the car has been towed, or if you notice it is not registering at the correct vehicle location on the map.

Press "Position" to reposition the vehicle location. Press the screen to scroll the map to the desired location and press OK to confirm.

Press "Distance" to calibrate by distance and improve the navigation accuracy. It is recommended to activate this function after every tire replacement. When the button is highlighted, calibration is in process and will turn off automatically when complete.

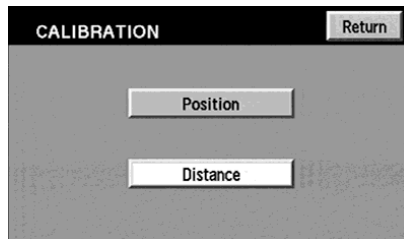

DVD map version

Displays the version of the inserted navigation DVD. Refer to *Ordering additional map DVDs* for further information.

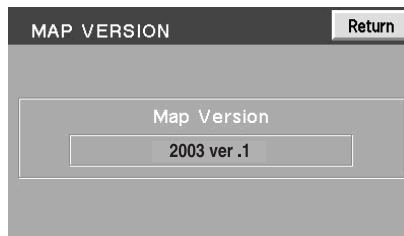

Entertainment Systems

Display Options

The Display Options screen will allow you make adjustments to the navigation display screen. You can choose from:

- Map Mode (Dual or Full)
- Guidance Mode (Arrows or Turn list)
- Guidance Display (On or Off)
- Time to destination (Show or Hide)

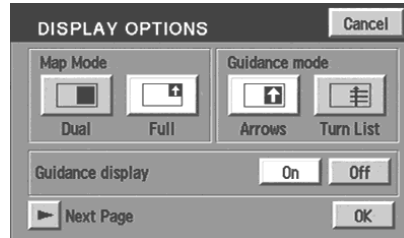

Stored locations

The Stored locations screen will allow you to choose from destinations that have been saved into the navigation system.



Entertainment Systems

In this screen, you can select from Memory Points, Special Memory Points, Home, Avoid Area, Destination and Way Point, or Previous Destination. Please refer to the *Destination menu* section for a complete description of the functions.

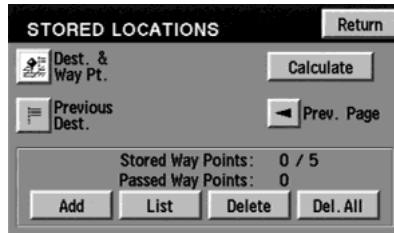

On route scroll

The system automatically scrolls through the entire planned navigation route either forwards or backwards. To activate, press the arrow buttons at the bottom left of the map screen.

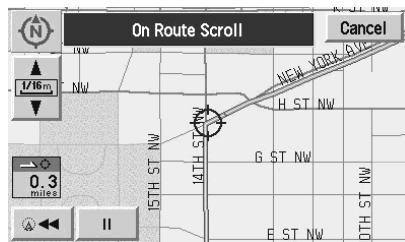

Voice guidance/volume

Allows you to turn the voice guidance option on/off and to determine the volume level of the guidance voice prompts. To adjust:

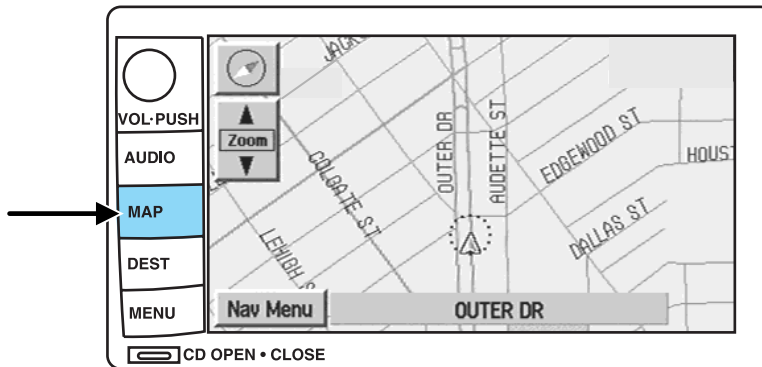

1. Press the MAP hard key.
2. Press "Nav Menu" at the bottom left hand corner of the screen.

Entertainment Systems

3. Press the speaker icon to turn the voice guidance option on/off. Press the desired number to select the volume level for the voice prompts.



Home

To set home for the first time:

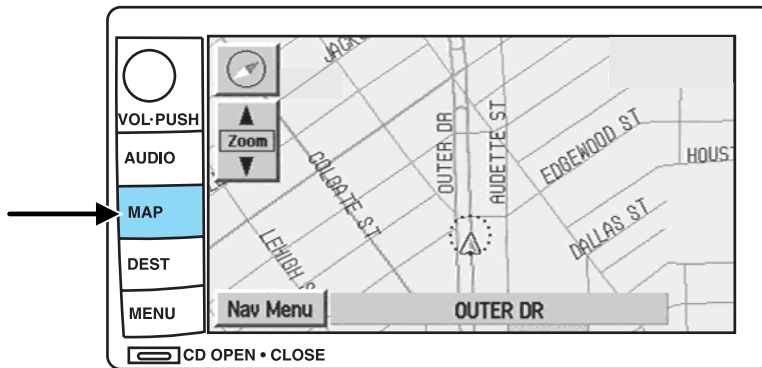

1. Press MAP.
2. Press "Nav. Menu".
3. Press "Stored Locations".

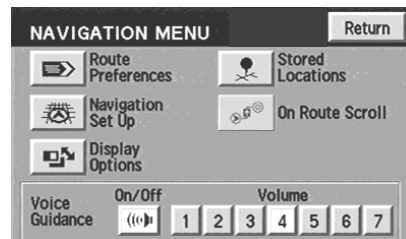

Entertainment Systems

4. Press “Home”.
5. Press “Add”.



6. Select the desired menu item you wish to set as Home (Address, Memory Point, Point of Interest, Previous Destination).
7. Enter the required details.

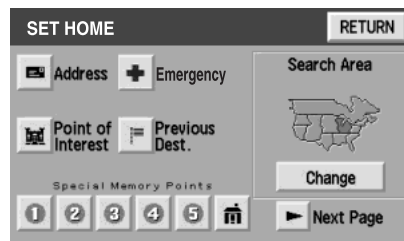

8. Press OK to set the home position.



To view home, press the home icon (house) on the Destination Entry screen.



Entertainment Systems

To view the set home position

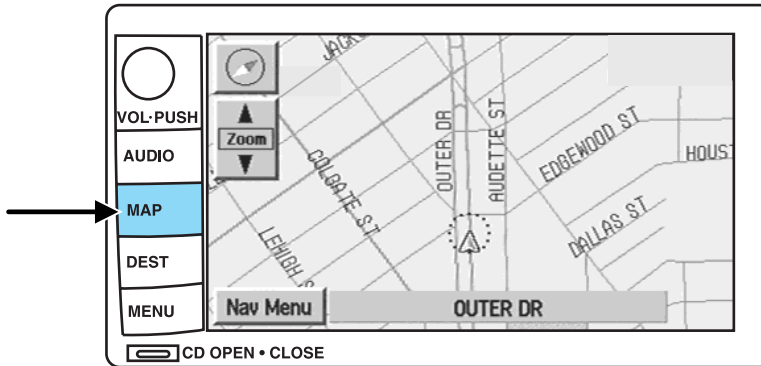

1. Press MAP.
2. Press "Nav. Menu".
3. Press "Stored Locations".

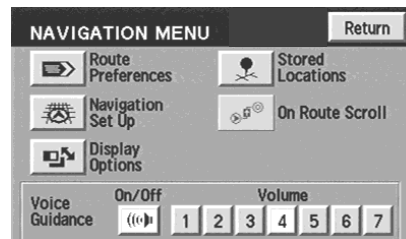

4. Press "Home".
5. Press "List".

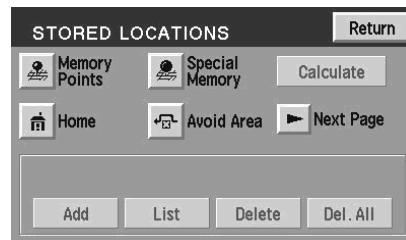

Entertainment Systems

Deleting a home location

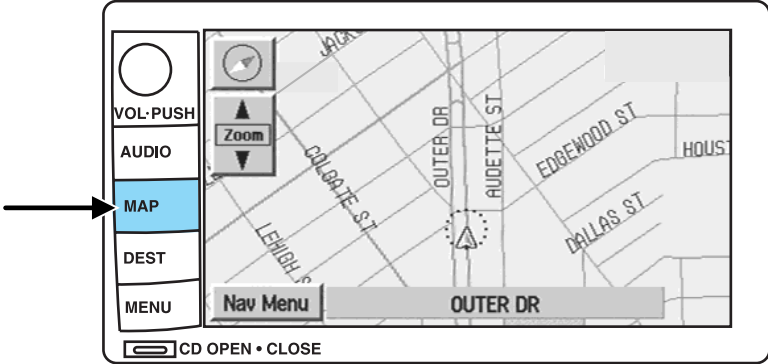

- 1. Press MAP.
- 2. Press "Nav. Menu".
- 3. Press "Stored Locations".

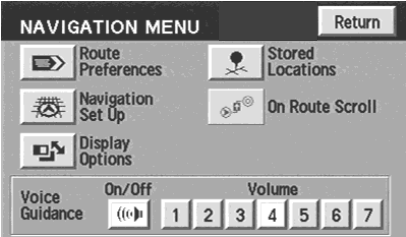

- 4. Press "Home".
- 5. Press "Delete".

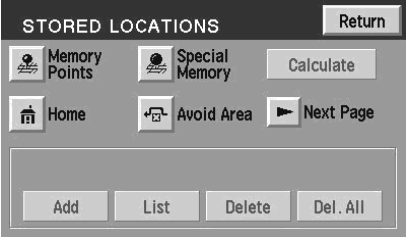

Entertainment Systems

6. Press YES to confirm.

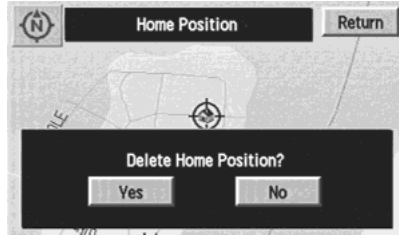

Special memory points

There are five possible special memory points that you can set.

To set a memory point:

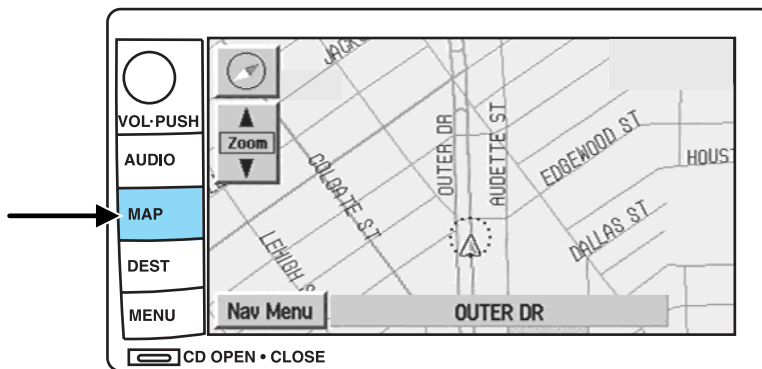

1. Press the MAP hard key.
2. Press "Nav. Menu".

Entertainment Systems

3. Press “Stored Locations”.

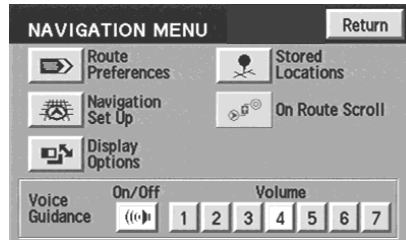

4. Press “Special Memory”.
5. Press “Add” and select a position.
6. Select point 1–5.
7. Input a destination.
8. Press OK.

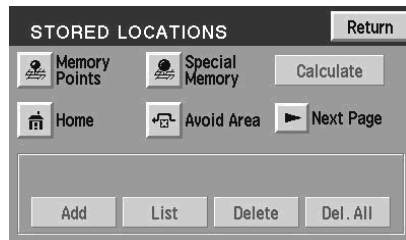

Once all five special memory points are entered, the “Add” control will read as “Full”. You must delete points before more can be added.

To delete a memory point:

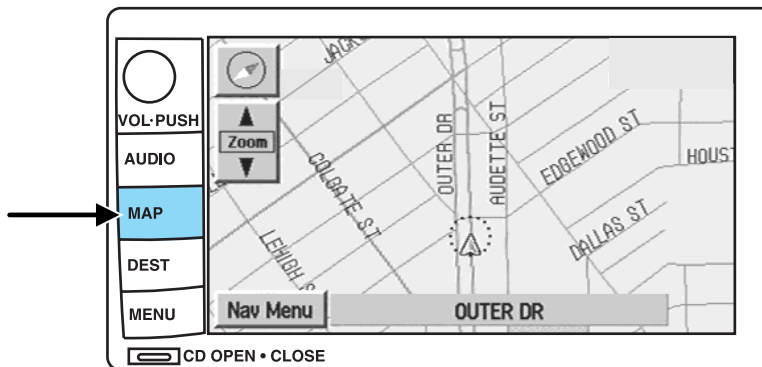

1. Press the MAP hard key.
2. Press “Nav. Menu”.

Entertainment Systems

3. Press “Stored Locations”.

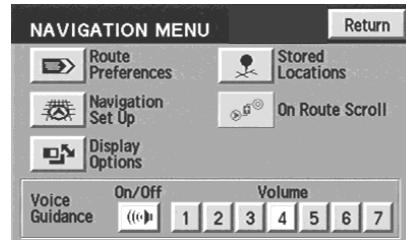

4. Press “Special Memory”.

5. Press “Delete”. The list will display.

6. Select the special memory point to delete.

7. Press “Del. all” to delete all entered special memory points.

8. Press “Yes” to confirm.

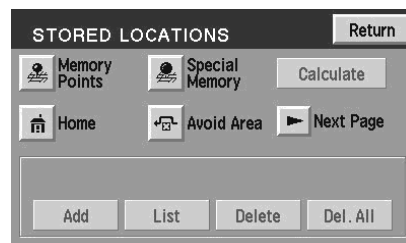

Detour options

You may engage the detour option once a route has already been calculated by the system. To access the detour option:

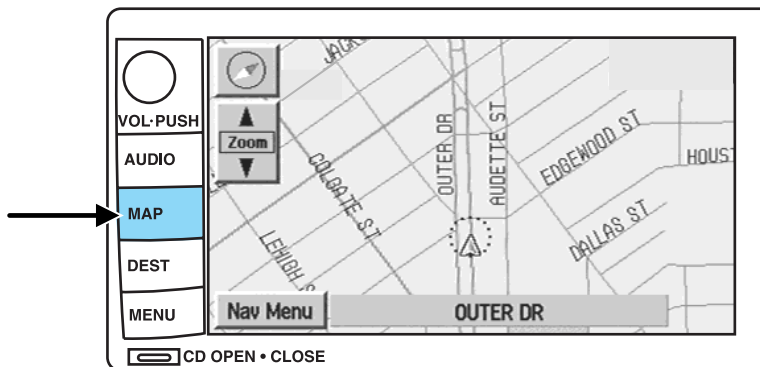

1. Press the MAP hard key

2. Press “Chg. Route”.

Entertainment Systems

Press DETOUR to activate. Use the soft controls to select and enter the number of miles you want to deviate off of the current road.

Press DETOUR to confirm the selection and to activate the detour around the specified areas.

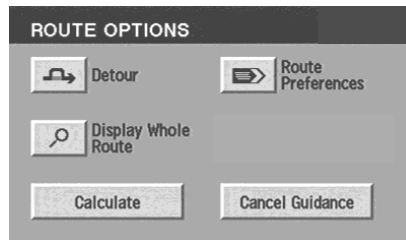

Press NEW ROUTE if you would like the system to plan a different route. The system may calculate an entirely new route, depending on what is available.

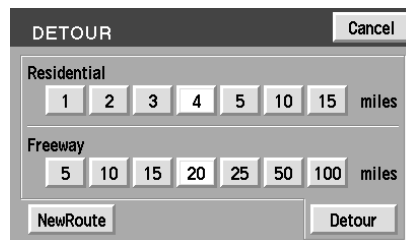

Route interruptions

In the course of your destination, you may decide to temporarily leave your planned route for gas, food, etc. If you turn off the ignition, the option to continue the route guidance will be displayed when the ignition is turned on again. The route can be accessed once again after you press "Agree" on the warning screen.

Route alterations or cancellations

To cancel or change your current route from the map, press DEST. You may then select from Detour, Display whole route, Route preferences, Destination Entry, Calculate or Cancel Guidance.

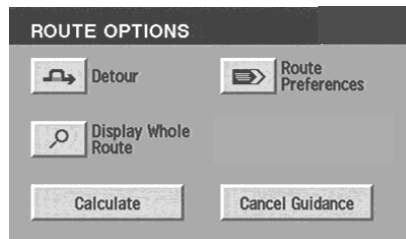

Entertainment Systems

Avoiding an area while under guidance

For one reason or another, you may choose to avoid a certain area while in route to your destination. To select the area to avoid:

- From the MAP screen, press Nav Menu.
- Select Route Options, then Display Whole Route
- Press Turn List
- Press Avoid next to the street to be avoided
- Choose OK to confirm
- Press Reroute to activate

The new area is added to the list of stored avoid areas.

Note: In some circumstances, it may not be possible to avoid all selected areas.

Listing areas to avoid

You can list all areas noted as “avoid”.

- Press “Nav Menu”.
- Press “Stored locations”.
- Press “Avoid area”.
- Press LIST to view all previously stored selections.
- Select the desired one. The map screen will be displayed, showing the location and address of the selected area.

Press Enlarge or Reduce to adjust the size of the visible area. Scroll the map as required.

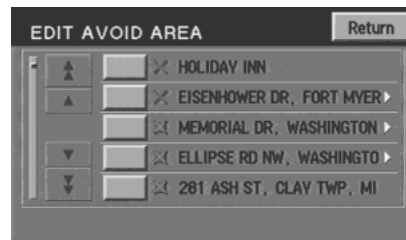
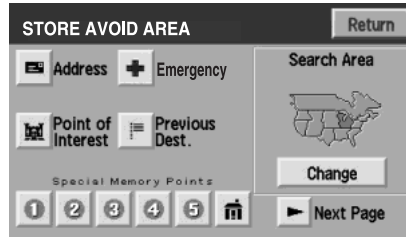

Entertainment Systems

Deleting areas to avoid

To delete a selection from the “Avoid area” list:

- From the stored locations menu, select “Avoid area”.
- Press DELETE
- Select the desired area to be deleted.
- Press DEL. ALL to delete all stored areas.
- Press YES to confirm.

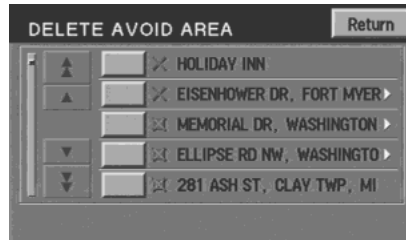

Destination menu

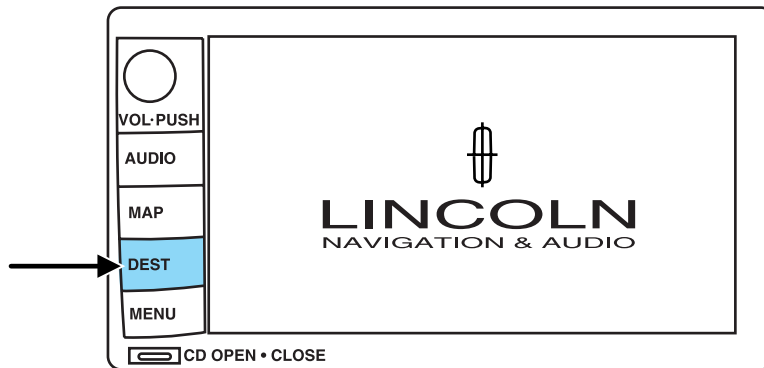

Press DEST on the main bezel to access the navigation mode.

Entertainment Systems

Initial map display

After pressing AGREE to the initial WARNING screen, you will move into the initial map screen which shows the current vehicle location. Pressing the globe icon will take you to the user settings — audible feedback, navigation units, language and clock (if equipped).

Note: There may be a slight time delay between the soft key and the hard key functions.



Destination entry

Search area

The mapped areas covered by your map DVD are reflected in the Search Area map that is displayed on the Destination Entry screen. Your navigation system uses a regional search area. This area is the area from which navigational directions will be used.

To check your area or reset, press CHANGE under the search area listing. The map will open and allow you to select another regional area. Ensure that your search area is correct prior to setting your destination.



Entertainment Systems

Selecting a destination

Press DEST to set a destination. From this menu, you may select from the following options:

- **Address**— Use to select a destination based on a known street address.
- **Point of Interest**— Use to select a destination that is a point of interest location (i.e., airport, restaurant, hospital).
- **Previous Destination** — Use to select a destination from among the last 20 entered destinations
- **Emergency** — Use to select the Emergency screen which will give you the location of the closest Hospital, Police Station and Dealer.

Press ► 'Next Page' to access more selections:

- **Memory point** — Use to select from a memory point.
- **Freeway exit/entrance** — Use to select a certain freeway exit or entrance.
- **Select from map** —Use to select a place on the map.
- **Special Memory Points** — Use to select a destination from previously stored entries.

Address

1. From the destination entry screen, select "Address".

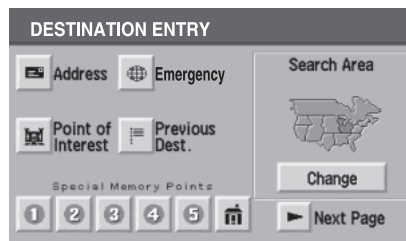
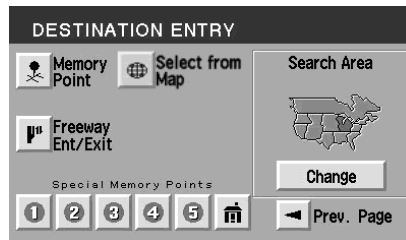
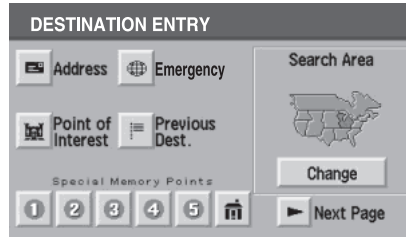

Entertainment Systems

2. Input the house/building number and press OK.

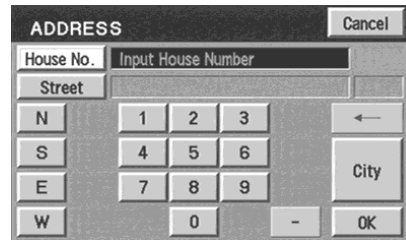

The screenshot shows the 'ADDRESS' screen with a 'Cancel' button in the top right. The 'House No.' field contains the text 'Input House Number'. Below it is the 'Street' field. A numeric keypad is displayed with buttons for digits 1-9, 0, and a left arrow. To the right of the keypad is a 'City' button. At the bottom right are '-' and 'OK' buttons.

3. Use the keyboard to type in the street name. When you are typing the street name, the system may bring up possible roads that you can select from. Use the arrows to scroll up or down to select the desired street.

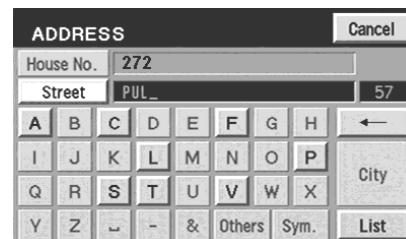

The screenshot shows the 'ADDRESS' screen with a 'Cancel' button in the top right. The 'House No.' field contains '272'. The 'Street' field contains 'PUL' and '57'. A keyboard is displayed with buttons for letters A-Z, a left arrow, and a 'City' button. At the bottom right are '&', 'Others', 'Sym.', and 'List' buttons.

4. Once the address is entered, the system will pull up some possible city and state matches. If one of those is correct, select it. If not, you may press either "5 near cities" for another listing of five possible cities and states (if available). Or, press "Input City Name".



The screenshot shows the 'ADDRESS' screen with a 'Return' button in the top right. A list of city and state matches is displayed: PIONEER VILLAGE, KY; PIONEER TWP, MI; ZEELAND, MI; LANSING, MI; DEARBORN, MI. At the bottom are '5 near Cities' and 'Input City Name' buttons.

Entertainment Systems

5. You may use the keyboard to input the desired city.

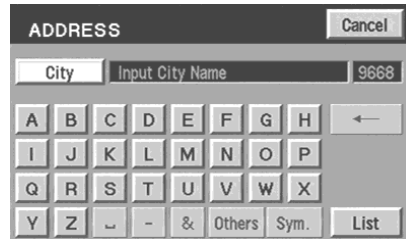

Points of interest (POI)

Select “Point of Interest” from the Destination Entry Menu. In this next menu, you will have the following options:

- **By Name**— Enter POI name on the keyboard. Touch “List” to display the list of matching points of interest. If there are too many matches being listed, try entering the town name first.
- **By Category** — Press “Category”. Scroll down the list to select the category, then sub-category desired. Once you have selected a category, your entry of the POI will be restricted to that category.

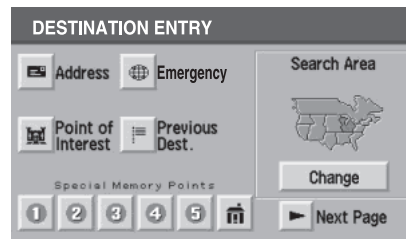

Previous destination

Press “Previous Destination” on the Destination Entry Menu.

1. Select (touch) the desired item from the list of destinations previously reached. The item details will be listed.
2. Confirm destination details.



Entertainment Systems

Deleting stored locations

Your navigation system allows you to delete any stored locations (previous destinations, memory points, special memory points, home, avoid areas, destination and way points, etc.) To delete any of these stored locations:

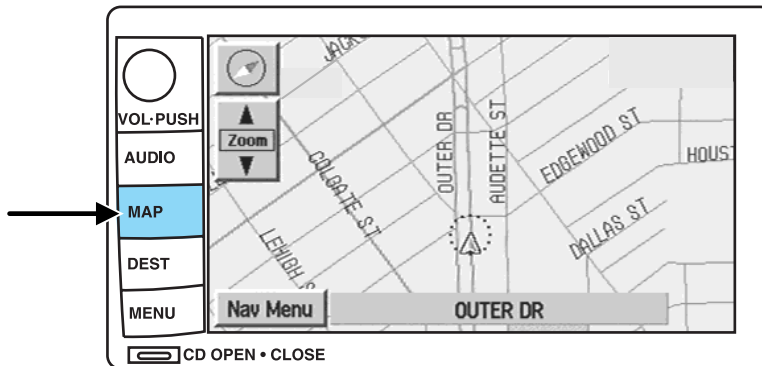

1. Press the MAP hard key.
2. Press “Nav Menu” in the bottom left hand corner of the screen.
3. Press “Stored locations”.

Nav Menu

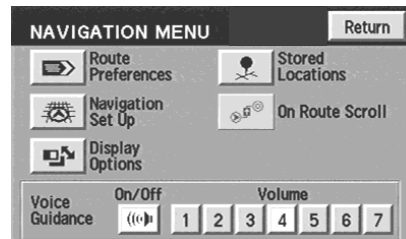

Entertainment Systems

4. Select the desired item you wish to delete (previous destination, memory point, etc.).
5. Press “Delete” at the bottom of the screen.



6. The list of stored locations will be displayed.
7. Select (touch) the entry to be deleted. The item details will be listed.
8. Press YES to confirm the deletion.



9. Press DELETE ALL to delete all stored locations.

Del. All

Emergency

Your navigation system is equipped with a separate Emergency screen. To access the Emergency screen, press “Emergency”.

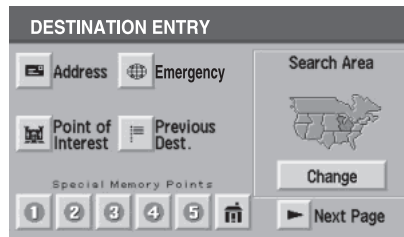

Entertainment Systems

This screen will list the closest police station, hospital and dealer to your current location.

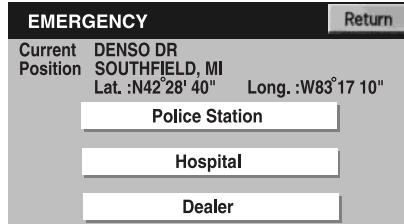

Memory point

Your navigation system allows you to go to special destinations you may wish to again visit. To view any of these “memory points” without a route calculated:

1. Press the DEST hard control.
2. Press “▶ Next page” on the Destination Entry screen.
3. Select “Memory Point”.
4. Select the desired item.
5. Confirm the details.
6. Press “Destination” to calculate a route to that memory point.

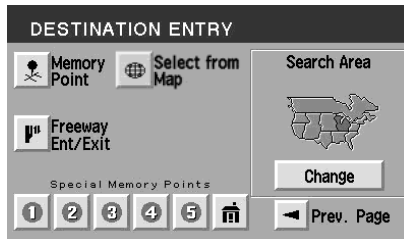

Note: The list can be sorted by date, name or icon by pressing the appropriate button.

Adding a memory point

You may add more memory points to be stored in the system.

1. With the map displayed, touch your finger to the screen to scroll to the desired location. When you reach the desired location, remove your finger from the screen and the map will stop scrolling. STORE will appear on the screen.

2. Press STORE to add the location to the memory point list.

You may also add a memory point via the Navigation menu.

Entertainment Systems

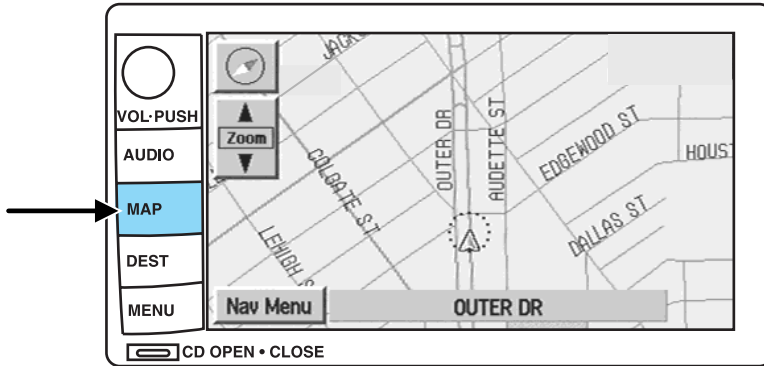

1. Press the MAP hard key.
2. Press “Nav Menu” in the bottom left hand corner of the screen.



3. Press “Stored locations”.

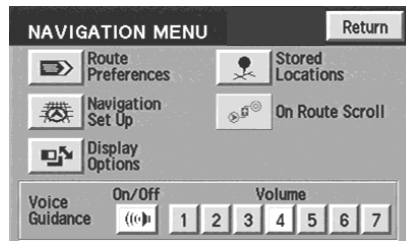

4. Select “Memory Point”.
5. Press “Add” at the bottom of the screen.
6. Select the desired menu item.
7. Enter/select any required details. The new point will be added to the stored list of memory points.
8. Press OK. The new point will be added to the list of stored memory points.

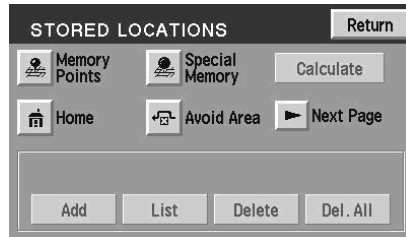

Entertainment Systems

To give the new memory point a name:

1. Select it from the list.
2. Press NAME.
3. Enter the desired name.

Accessing memory point lists

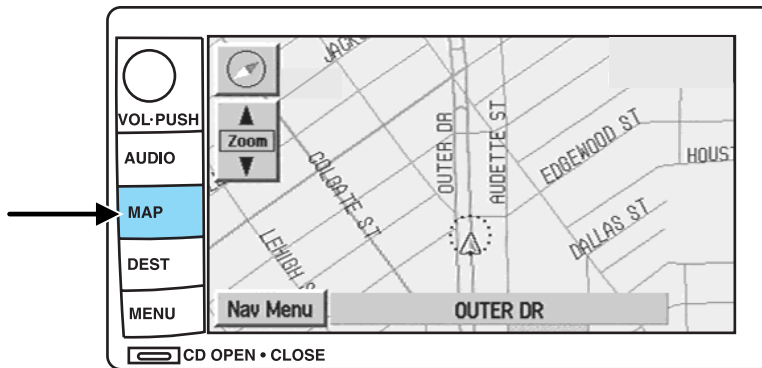

1. Press the MAP hard key.
2. Press “Nav Menu” in the bottom left hand corner of the screen.
3. Press “Stored locations”.

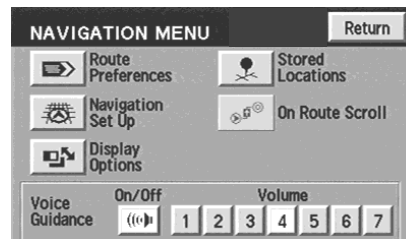

Entertainment Systems

4. Press “Memory Point”.
5. Press LIST



6. Select the desired entry to view its location details.

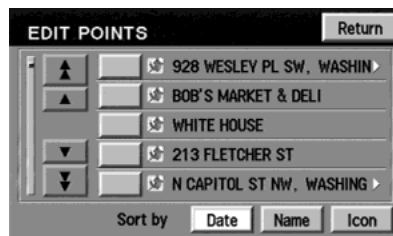

Sorting memory point lists

1. Access the desired list.
2. Press the button to sort the list as desired (i.e. date, name, or icon).

When sorted by distance, the points are ordered by distance from the current vehicle location. When sorting by icon, the icons are listed in the order they appear on the icon selection screen.

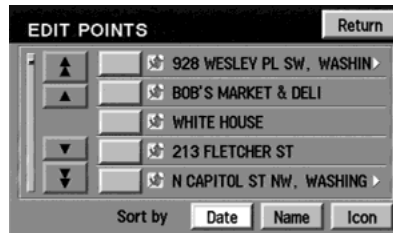

Entertainment Systems

Choosing from the icon list

After selecting a location, press ICON to edit. There will be 15 normal and three sound icons displayed. Press the icon you wish to use.

The normal icons will be displayed on the map to indicate the map location identified with that icon. The audible icon will sound a distinctive chime when the vehicle is approaching the memory point associated with that icon.

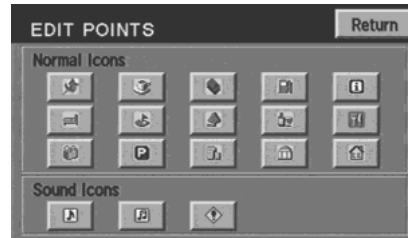

Deleting a memory point

- In the Memory Point Menu, press DELETE.
- Select the entry to be deleted.
- The system will ask you to confirm deletion. Press YES to confirm.

The screen will briefly show “Memory Point Deleted”.

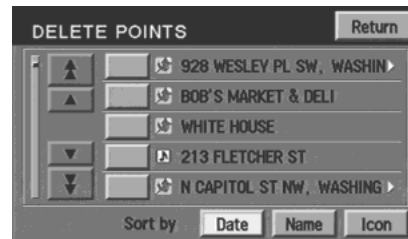

Deleting all memory points

- In the Memory Point Menu, press DELETE ALL.

Del. All

- The system will ask you to confirm deletion. Press YES to confirm.

The screen will briefly show “All Memory Points Deleted”.

Entertainment Systems

Freeway Entrance/Exit

To set a freeway entrance or exit as a destination:

1. Press the DEST hard key.
2. Press “▶ Next page” to access the second page of the Destination Entry menu.
3. Select “Freeway Entrance/Exit”.

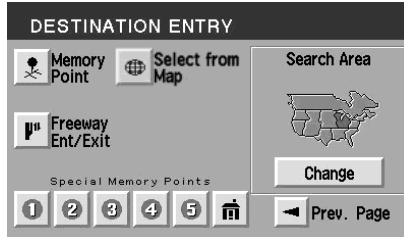

1. **Enter freeway name**— Enter the freeway name using the keyboard. Press “List” to select a freeway from those displayed.

To enter numbers in the freeway name, press “Sym”.



2. **Select entrance/exit**— Press “Entrance” if you wish to join the freeway at this junction. Press “Exit” if you wish to leave the freeway at this junction.

3. **Select Junction**— The screen will display a list of junctions on the freeway. They can be listed either by distance, (from the current vehicle location), by pressing the “Dist” button or alphabetically by pressing the “A-Z” button. Select the desired entrance or exit.

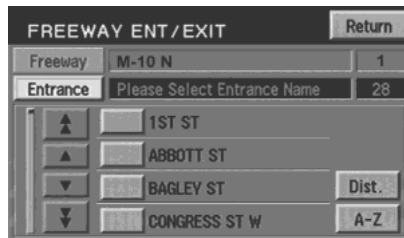

The destination details are displayed for confirmation.

Entertainment Systems

Destination and way points

The Store Dest. & Way Point menu is used after a destination or way point has been entered for the first time using the Destination Entry menu. You can store and delete destinations and way points (locations you wish to visit in route to your ultimate destination). You can also select the order in which you visit them.



Adding (storing) a destination or way point

- Once a destination is entered, press ADD to store the location. The Store Dest. & Way Point menu is displayed.
- Select whether you want to store an Address, Point of Interest or Previous Destination.
- Enter the necessary details for the selection.
- If a destination was entered, it will be stored as the current location. If a way point was entered, it will be added to the list of way points.

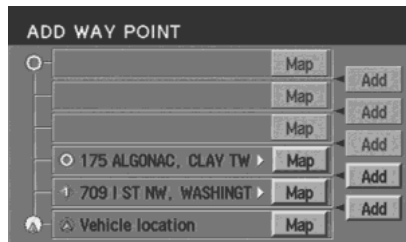

Listing destinations and way points

Press LIST to display the stored way points and destination (if entered).

The first way point to be visited is at the bottom of the list and the destination is at the top.

You may view the map location of any entry. On the map, location details for the entry are displayed at the top of the screen.

To adjust the position of the way point (or destination), scroll the map as required.

Press OK.

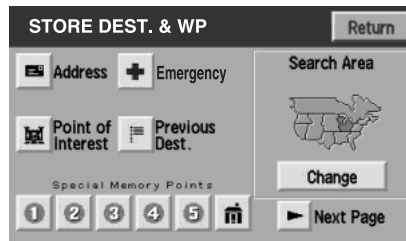

Entertainment Systems

Editing and changing order of way points and destination

Press “Chg. Order” to change the order in which the way points are visited. The points are listed chronologically from bottom up, the destination being on the top.

Press the MAP button to edit the way point location on the map display.

Press OK to confirm.



Deleting way points and destination

After pressing DELETE, the list of way points and the destination (if entered) is displayed, showing the 'Delete Dest. &Way Pt.' menu.

Select the entry to be deleted. Press YES to confirm.

Press DELETE ALL to delete all way points. Press YES to confirm.



Selecting route criteria

Once you have selected a destination, you may change the routing criteria by pressing “Change” in the route preferences screen. Refer to *Route preferences* for further information.

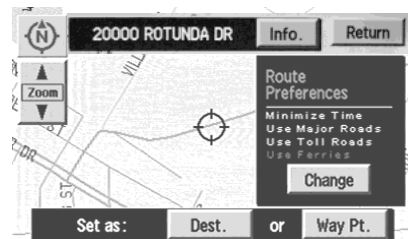

Entertainment Systems

Route calculation

Once the route criteria is selected, the navigation system automatically calculates the selected destination. The route appears on the display screen and a voice prompt provides instructions.

The system may calculate up to four routes for the desired destination. Press "Next" to scroll through the various planned routes. Press "Start" to confirm the route selection and begin route guidance.

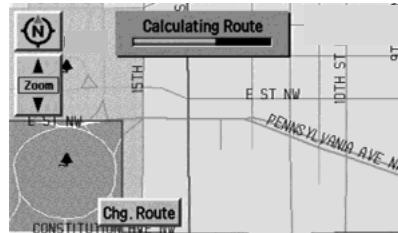

Next route

Your navigation system may map more than one route to the same destination. After the destination has been calculated, it will appear on the map screen. Press NEXT in the upper right hand corner to scroll through other possible routes to the same destination.

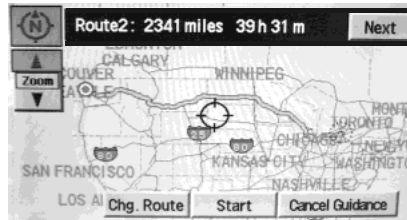

Menu mode

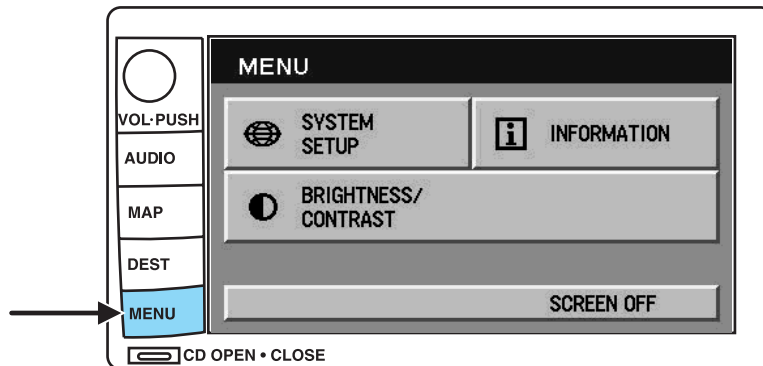

Entertainment Systems

To access menu mode, press the MENU hard control.

Menu mode allows you to access:

- System Set-up
- Information — Gives you the Lincoln Customer Assistance Center information.

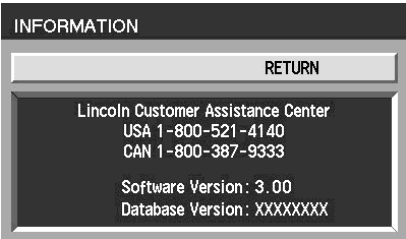

- Brightness/Contrast — Allows you to adjust the brightness and contrast on the screen.

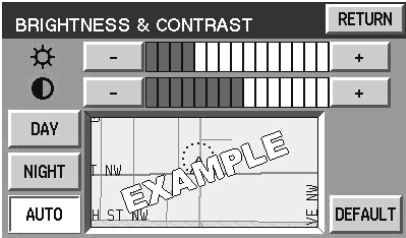

- Screen off — Allows you to turn off the navigation screen.

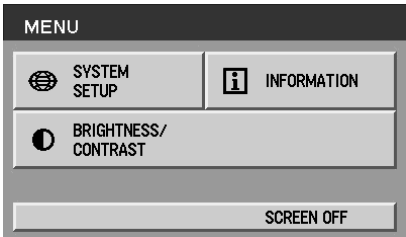

Entertainment Systems

System setup

The system set up menu contains the following user settings:

- Audible Feedback — Press to activate audible voice navigation commands. Press again to deactivate.
- Navigation Units — Press to toggle between Metric/English units.
- Language — Press to toggle between English, French, or Spanish.

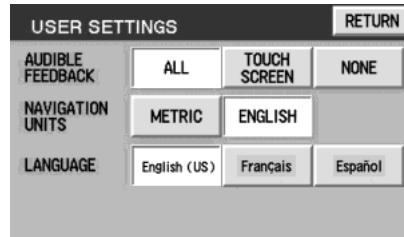

General information

Safety information

Please read and follow all stated safety precautions. Failure to do so may increase your risk of collision and personal injury. Ford Motor Company shall not be liable for any damages of any type arising from failure to follow these guidelines.

Do not attempt to service, repair or modify the system. See your Ford or Lincoln Mercury dealer.



The driver must not attempt to operate any detailed operation of the navigation system while the vehicle is in motion. Give full attention to driving and to the road. Pull off the road and park in a safe place before performing detailed operations.

If the system is used for an extended period of time with the vehicle stationary, ensure that the engine is running to avoid draining the battery.

Do not apply pressure to the display screen.

The navigation system is not a substitute for your personal judgement.

Route suggestions should not supersede local traffic regulations or safe driving practices.

Do not follow route suggestions if they direct you to perform an unsafe or illegal maneuver, would place you in an unsafe situation, or would route you into an area that you consider unsafe.

Drivers should not rely on screen displays while their vehicle is in motion. Let the voice guide you. If viewing is necessary, pull off the road to a safe location.

Entertainment Systems

Do not use the navigation system to locate emergency services.

For road safety reasons, the driver should program the system only when the vehicle is stationary. Certain functions will therefore not operate while the vehicle is in motion.

The map database DVD does not reflect road detours, closures or construction, road characteristics such as rough road surface, slope or grade, weight or height restrictions, traffic congestion, weather or similar conditions.

To use the system as effectively and safely as possible, obtain an up-to-date map database DVD whenever they become available.

Set the volume level so that you can hear directions clearly.

Do not disassemble or modify the system as this may lead to damage and void your warranty. If a problem occurs, stop using the system immediately and contact your Ford or Lincoln Dealer.

Federal Communication Commission (FCC) Compliance

Changes or modifications not approved by Ford Lincoln Mercury could void user's authority to operate the equipment. This equipment has been tested and found to comply with the limits for a Class B digital device, pursuant to Part 15 of the FCC Rules. These limits are designed to provide reasonable protection against harmful interference in a residential installation. This equipment generates, uses and can radiate radio frequency energy and, if not installed and used in accordance with the instructions, may cause harmful interference to radio communications.

However, there is no guarantee that interference will not occur in a particular installation. If this equipment does cause harmful interference to radio or television reception, which can be determined by turning the equipment off and on, the user is encouraged to consult the dealer or an experienced radio/TV technician for help.

The database reflects reality as existing before you received the database and it comprises data and information from government and other sources, which may contain errors and omissions. Accordingly, the database may contain inaccurate or incomplete information due to the passage of time, changing circumstances, and due to the nature of the sources used. The database does not include or reflect information on neighborhood safety, law enforcement, emergency assistance, construction work, road or lane closures, vehicle or speed restrictions, road slope or grade, bridge height, weight or other limits, road or traffic conditions, special events, traffic congestion, or travel time.

Entertainment Systems

Radio reception factors

There are certain factors that may effect your radio reception.

- **Distance/strength.** The further an FM signal travels, the weaker it is. The listenable range of the average FM station is approximately 40 km (24 miles). This range can be affected by “signal modulation.” Signal modulation is a process radio stations use to increase their strength/volume relative to other stations.
- **Terrain.** Hills, mountains and tall buildings between your vehicle’s antenna and the radio station signal can cause FM reception problems. Static can be caused on AM stations by power lines, electric fences, traffic lights and thunderstorms. Moving away from an interfering structure (out of its “shadow”) returns your reception to normal.
- **Station overload.** Weak signals are sometimes captured by stronger signals when you pass a broadcast tower. A stronger signal may temporarily overtake a weaker signal and play while the weak station frequency is displayed.

Principles of GPS (global positioning system) operation

Your system directs you based on information derived from global positioning satellites, road maps stored on the DVD, sensors in your vehicle and the desired destination. The system compiles all necessary information to guide you to your selected destination. Space satellites determine the vehicle’s current location and transmit position and time signals to your car.

If the vehicle has been parked for a long period of time, the navigation function may be temporarily unresponsive. The navigation system will operate reliably again once GPS reception is available for a few minutes.

Limited GPS reception

System performance may be adversely affected if GPS reception is interrupted or interference occurs over a distance of several miles. The following are possible causes for GPS reception being interrupted. If the vehicle is:

- in multi-story parking garages
- in tunnels and under bridges
- inside or in between buildings
- by forests or tree-lined avenues
- in heavy rain showers and thunderstorms
- in valleys and in mountainous regions

Entertainment Systems

- roads under cliffs

Ensure that you do not have any metal objects on the rear parcel shelf. If your windows are tinted, ensure that you use non-metal tinting instead of metal oxide tinting. Both of these factors can interrupt GPS reception.

Cleaning the display

Do not spray cleaning fluid directly onto the unit. Instead, spray onto a soft cloth and gently wipe the unit. Only recommended products should be used.

- Recommended products- Rubbing alcohol based cleaner (i.e., methyl alcohol) or a damp clean cloth.
- Not harmful but not recommended- ammonia cleaner, neutral detergent.
- Harmful to system and not recommended- acid cleaner, alkali cleaner, benzene cleaner.

Do not clean any part of the system with benzene, paint thinner or any other solvent.

Do not spill liquids of any kind onto the unit.

Loading the map DVD

- Your navigation DVD unit is located in the trunk (mounted under the rear window or in a left side compartment with access door).
- Ensure that the vehicle ignition is ON.
- If a DVD is already loaded in the Navigation unit, push the eject button.
- Load the DVD with the printed side up. Do not allow moisture or foreign objects to enter the slot.

The navigation system utilizes a database stored in a special format on a DVD. It is recommended always to use the latest update of this map DVD.

- The navigation system will only work with DVDs specifically intended for your navigation system.
- Always store the map DVDs in their protective cases when not in use.

Entertainment Systems

Ordering additional map DVDs

If you wish to order a replacement or additional map, please call 1-888-NAV-MAPS (1-888-628-6277) or to log onto www.navtech.com.

Latest map DVDs

The map content is constantly changing due to new roads, traffic restrictions, etc. . Therefore, it is not always possible to exactly match the DVD map with the current roadways. For best results, always use the latest version of the map DVD. Map information is regularly updated, but all areas are not necessarily covered to the same level of detail. Some areas, in particular private roads, may not be included on the database. To help with accuracy, always use the latest DVD version for navigation.

Customer service

If you need help operating your navigation/audio system, want to report a map database error or want to obtain a map DVD, please call 1 (888) 628-6277 (NAV-MAPS) or log onto www.navtech.com.

Climate Controls

DUAL ELECTRONIC AUTOMATIC TEMPERATURE CONTROL (DEATC) SYSTEM

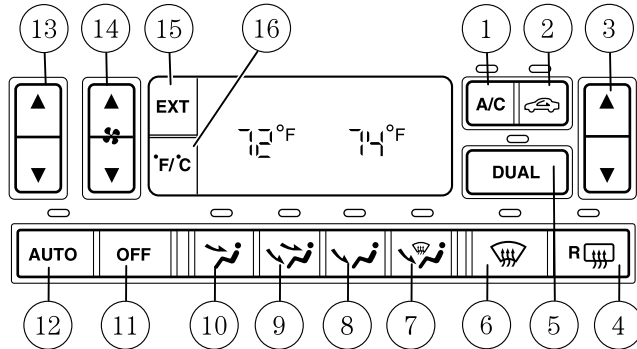

1. **A/C control:** Cools the vehicle and is used to reduce humidity in the vehicle. Press to turn on/off.



2. **Recirculation control:** Cools the vehicle more quickly by recirculating the cabin air instead of using outside air and helps prevent unpleasant outside odors or fumes from entering the vehicle. Press to turn on/off in all modes except .



3. **Passenger side temperature control:** Controls the temperature on the passenger side of the vehicle when in dual zone mode. To enter dual zone, press the passenger temperature control or DUAL. The passenger temperature will appear in the display.







4. **Rear defroster control:** Removes ice and fog from the rear window. Press to turn on/off.



5. **DUAL** (Single/dual temperature control): Allows the driver to have full control of the cabin temperature settings (single zone) or allows the passenger to have control of their individual temperature settings (dual zone). Press to turn on dual zone mode, press again to return to single zone.



Climate Controls

6.  : Distributes air through the windshield defroster vents and the side window demisters.
7.  : Distributes air through the windshield defroster vents, the side window demisters and floor vents.
8.  : Distributes air through the floor vents.
9.  : Distributes air through the instrument panel vents and the floor vents.
10.  : Distributes air through the instrument panel vents.

Manual override controls: Allows you to manually determine where airflow is directed. To return to fully automatic control, press AUTO.



11. **OFF:** Outside air is shut out and the fan will not operate.



12. **AUTO:** Press and select the desired temperature. The system will automatically determine the fan speed, airflow location, outside or recirculated air to heat or cool the vehicle to the selected temperature. If unusual conditions exist, (i.e., window fogging, etc.), manual overrides allow you to select airflow locations and fan speed.



13. **Driver's side temperature control:** Controls the temperature on the driver side of the vehicle.



14. **Fan Speed:** Used to manually enable or disable the fan speed.



15. **EXT:** Displays the outside air temperature. It will remain displayed until the EXT control is pressed again. The external temperature will be most accurate when the vehicle has been moving for a period of time.



Climate Controls

16. **Temperature conversion:**

Press to toggle between Fahrenheit and Celsius temperature on the DEATC display only. The set point temperatures in Celsius will be displayed in half-degree increments.



OPERATING TIPS

- To reduce fog build up on the windshield during humid weather, place the air flow selector in the  position.
- To reduce humidity build up inside the vehicle: do not drive with the recirculation control on or the system turned off.
- Do not put objects under the front seats that will interfere with the airflow to the back seats.
- Remove any snow, ice or leaves from the air intake area at the base of the windshield.

To aid in side window defogging/demisting in cold weather:

1. Select .
2. Select A/C.
3. Adjust the temperature control to maintain comfort.
4. Set the fan to the highest speed.
5. Direct the outer instrument panel vents towards the side windows.

To increase airflow to the outer instrument panel vents, close the vents located in the middle of the instrument panel.



Do not place objects on top of the instrument panel as these objects may become projectiles in a collision or sudden stop.

Climate Controls

REAR CONSOLE CLIMATE CONTROLS (IF EQUIPPED)

- **TEMP:** Press to increase or decrease airflow temperature.
- **FAN:** Press to increase or decrease the fan speed.

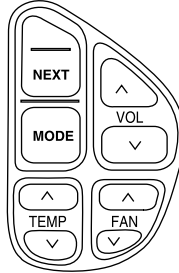

REAR WINDOW DEFROSTER

The rear defroster control is located on the instrument panel.

Press the rear defroster control to clear the rear window of thin ice and fog. A small LED will illuminate when the rear defroster is activated.

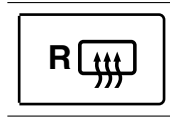



The ignition must be in the ON position to operate the rear window defroster.

The defroster turns off automatically after a predetermined amount of time or when the ignition is turned to the OFF position. To manually turn off the defroster, press the control again.

Do not use razor blades or other sharp objects to clean the inside of the rear window or to remove decals from the inside of the rear window. This may cause damage to the heated grid lines and will not be covered by your warranty.

Lights

HEADLAMP CONTROL

-  Turns the lamps off.
-  Turns on the parking lamps, instrument panel lamps, license plate lamps and tail lamps.
-  Turns the headlamps on.

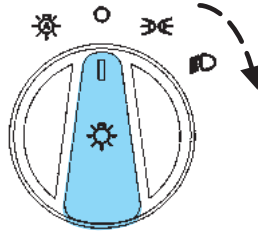

Autolamp control

The autolamp system provides light sensitive automatic on-off control of the exterior lights normally controlled by the headlamp control.

The autolamp system also keeps the lights on for a preselected period of time after the ignition switch is turned to OFF.

The autolamps are turned on at night or when the front wipers are turned on.

- To turn autolamps on, rotate the control counterclockwise. The preselected time lapse is adjustable up to approximately three minutes. See the programming procedure following.
- To turn autolamps off, rotate the control clockwise to the off position (O).

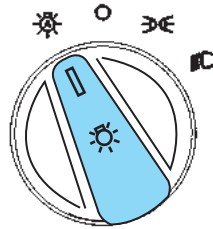

The amount of time the autolamps stay on can be programmed by doing the following:

1. Turn the ignition to OFF.
2. Turn the headlamp switch to the Autolamp position.
3. Turn the headlamp switch to OFF.
4. Turn the ignition to RUN and then back to OFF.
5. Turn the headlamp switch to the Autolamp position.
6. Wait the desired amount of time for delay, then turn the headlamp switch to OFF.

Lights

7. Steps 3 through 5 need to be performed within 10 seconds.

Daytime running lamps (DRL) (if equipped)

The daytime running light system turns the headlamps on, with a reduced light output, when:

- the ignition is in RUN,
- the transmission is not in P (Park),
- the high beams are not in the flash to pass position and
- the headlamp system is not turned on by another feature such as using the headlamp control or Autolamp.



Always remember to turn on your headlamps at dusk or during inclement weather. The Daytime Running Light (DRL) System does not activate the tail lamps and generally may not provide adequate lighting during these conditions. Failure to activate your headlamps under these conditions may result in a collision.

High beams

Push the lever toward the instrument panel to activate. Pull the lever towards you to deactivate.

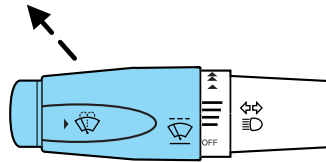

Flash to pass

Pull toward you slightly to activate and release to deactivate.

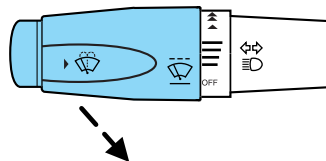

PANEL DIMMER CONTROL

Use to adjust the brightness of the instrument panel during headlight and parklamp operation.

- Rotate the thumbwheel from left to right to brighten the instrument panel.
- Rotate the thumbwheel from right to left to dim the instrument panel.

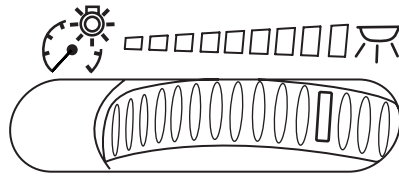

During full daylight, the instrument panel will still be visible with the headlamps operating.

Domelamp Control

The panel dimmer control also controls the domelamp operation.

- Rotate the thumbwheel fully to the right, past detent to activate the domelamp.
- In order to turn off the domelamp, rotate the thumbwheel to the left.

AIMING THE HEADLAMPS

The headlamps on your vehicle are properly aimed at the assembly plant. If your vehicle has been in an accident the alignment of your headlamps should be checked by a qualified service technician.

Vertical aim adjustment

1. Park the vehicle directly in front of a wall or screen on a level surface, approximately 25 feet (7.6 meters) away.

- (1) 8 feet (2.4 meters)
- (2) Center height of lamp to ground
- (3) 25 feet (7.6 meters)
- (4) Horizontal reference line

2. Measure the height of the headlamp bulb center from the ground and mark an 8 foot (2.4 meter) horizontal reference line on the vertical wall or screen at this height (a piece of masking tape works well).

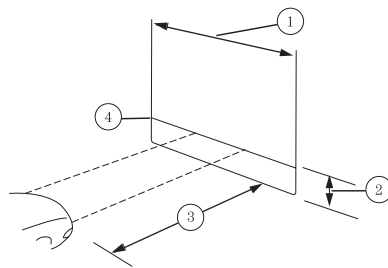

Lights

3. Turn on the low beam headlamps to illuminate the wall or screen and open the hood.

4. On the wall or screen you will observe an area of high intensity light. The top of the high intensity area should touch the horizontal reference line, if not, the beam will need to be adjusted.

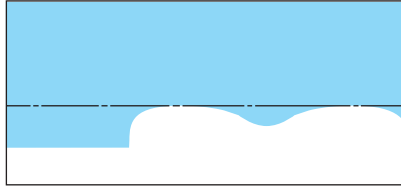

To see a clearer light pattern for adjusting, you may want to block the light from one headlamp while adjusting the other.

5. Locate the vertical adjuster on each headlamp. Using a 4 mm wrench, turn the adjuster either clockwise (to adjust down) or counterclockwise (to adjust up). The horizontal edge of the brighter light should touch the horizontal reference line.

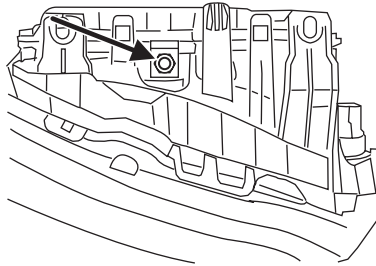

6. HORIZONTAL AIM IS NOT REQUIRED FOR THIS VEHICLE AND IS NON-ADJUSTABLE.

7. Close the hood and turn off the lamps.

TURN SIGNAL CONTROL ⇄

- Push down to activate the left turn signal.
- Push up to activate the right turn signal.

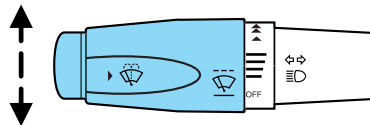

INTERIOR LAMPS

Map/Courtesy lamps

To turn on the map lamps, press the map lamp control.

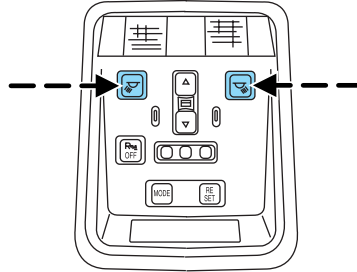

Rear courtesy/reading lamps

The courtesy lamp lights when:

- any door is opened.
- any of the remote entry controls are pressed and the ignition is OFF.

With the ignition key in the ACC or ON position, the reading lamp can be turned on by pressing the rocker control.

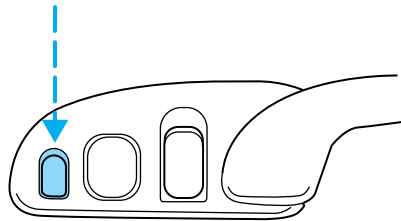

BULBS

Headlamp Condensation

The headlamps are vented to equalize pressure. When moist air enters the headlamp(s) through the vents, there is a possibility that condensation can occur. This condensation is normal and will clear within 45 minutes of headlamp operation.

Replacing exterior bulbs

Check the operation of all the bulbs frequently.

Lights

Using the right bulbs

Replacement bulbs are specified in the following chart. Headlamp bulbs must be marked with an authorized "D.O.T." for North America and an "E" for Europe to assure lamp performance, light brightness and pattern and safe visibility. The correct bulbs will not damage the lamp assembly or void the lamp assembly warranty and will provide quality bulb burn time.

Function	Trade Number
Headlamp (HI beam)	9005
Headlamp (LOW beam)*	H7
Park and turn lamp (front)	3457 AK
Sidemarker (front)	168
Backup lamp	3156 K
Stop, tail, turn and sidemarker lamp (rear)	3157 K
Cornering lamp	3156 K
License plate lamp	168
High-mount brakelamp - Stop**	20 (LEDS)
Luggage compartment lamp	212-2
Map lamp	906
Visor vanity lamp - Slide on Rail system (SOR)	37
Rear grab handle reading lamps	578
Door courtesy lamp	904
Glove compartment	194
All replacement bulbs are clear in color except where noted.	
To replace all instrument panel lights - see your dealer.	

* For vehicles with HID lamps, see your dealer for service.

**When replacing the center high mount stop lamp, see your dealer for replacement bulbs.

Replacing the interior bulbs

Check the operation of all bulbs frequently.

Lights

Replacing headlamp bulbs

To remove the headlamp bulb:

1. Make sure headlamp switch is in OFF position.
2. Remove the protective bulb cover by loosening and removing the five screws.
3. Rotate the light bulb socket counter clockwise and pull it straight out from the assembly.
4. Remove the old bulb from the lamp assembly by pulling it straight out of the bulb socket.

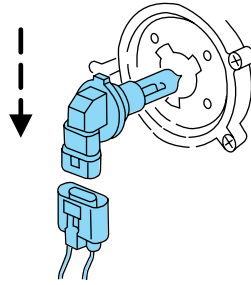

Handle a halogen headlamp bulb carefully and keep out of children's reach. Grasp the bulb only by its plastic base and do not touch the glass. The oil from your hand could cause the bulb to break the next time the headlamps are operated.

5. To complete installation, follow the removal procedure in reverse order.

Note: To ensure a good seal, attach the bulb cap and partially tighten the screws. Check to ensure the gasket is fully centered. Finish tightening the screws in a criss-cross pattern (upper-left, lower right etc.)

Replacing HID headlamp bulbs (if equipped)

The low beam headlamps on your vehicle use a “high intensity discharge” source. These lamps operate at a high voltage. When the bulb is burned out, the bulb and starter capsule assembly must be replaced by your dealer or a qualified technician.

Replacing front parking lamp/turn signal/ sidemarker bulbs

The park/turn lamp bulbs can be replaced without removing the headlamp assembly.

1. Make sure headlamp switch is in OFF position, then open the hood.
2. Remove the protective bulb cover by removing the three retaining bolts.

Lights

3. Rotate the bulb socket counterclockwise and remove from lamp assembly.
4. Carefully pull bulb straight out of the socket and push in the new bulb until it snaps, locking it into position.
5. To complete installation, follow the removal procedure in reverse order.

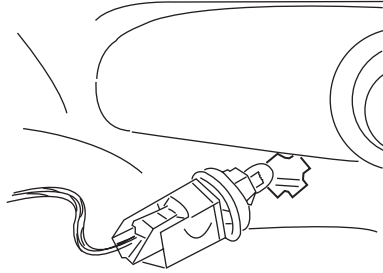

Replacing tail lamp/brake/turn lamp bulbs

The tail lamp, the brake lamp and the turn signal lamp bulbs are located in the tail lamp assembly. Follow the same steps to replace either bulb.

1. Make sure headlamp switch is in OFF position, then open the trunk and carefully pull the carpet away to expose the plastic retainer.
2. Remove plastic retainer to expose the lamp assembly hardware.
3. Remove three nut and washer assemblies and the lamp assembly from the vehicle.
4. Remove the bulb socket by rotating it counterclockwise, then pulling it out of the lamp assembly.

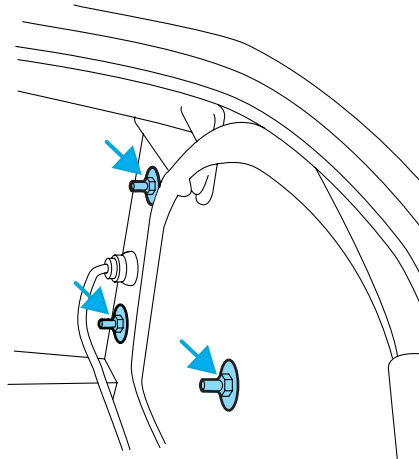

5. Pull the bulb from the socket and push in the new bulb.
6. Install the bulb socket into the lamp assembly by rotating it clockwise.
7. Install the lamp assembly on the vehicle with three nut and washer

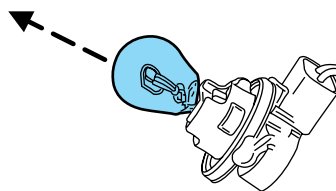

Lights

assemblies ensuring the washers on the nuts are flush with the body to prevent water from entering the trunk.

8. Install the plastic retainer and carefully push the carpet back into place.

Replacing license plate lamp bulbs

1. Make sure headlamp switch is in OFF position, then remove two screws, grommets and the license plate lamp assembly from the trunk lid.

2. Carefully pull the bulb from the socket and push in the new bulb.

3. Install the lamp assembly on trunk lid with two grommets, ensuring the grommets are pushed all the way in to the trunk lid and secure with two screws.

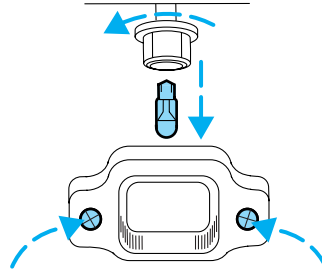

Replacing backup lamp bulbs

1. Make sure headlamp switch is in OFF position, then open trunk and remove bulb socket from the trunk lid by turning counterclockwise.

2. Pull the bulb straight out of the socket and push in the new bulb.

3. Install the bulb socket in trunk lid by turning clockwise.

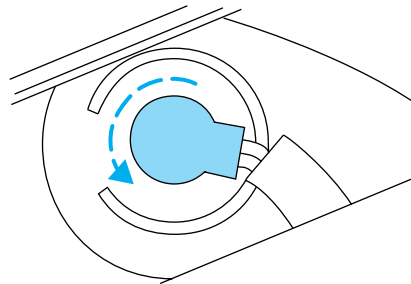

Replacing high-mount brakelamp bulbs

To change the high-mount brake lamp assembly:

1. Make sure headlamp switch is in OFF position, then pry the light assembly away from its housing to disengage it from the retaining clips.

2. Remove the light assembly from the headliner.

3. Disconnect the light assembly wiring and replace the light assembly.



Lights

Overhead console lamps

To remove and replace the lamps in the overhead console:

1. Make sure the headlamp switch is in the OFF position and remove the overhead console from the headliner by pulling it straight down.
2. Remove the bulb socket from the back of the lamp housing by pulling it straight out.
3. Remove the bulb from the socket by pulling straight out.

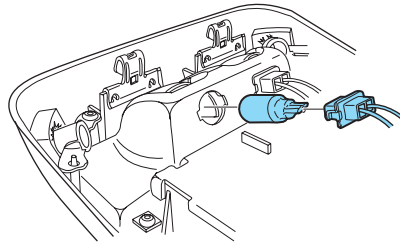

Install the new bulb in reverse order.

Rear courtesy/reading lamps

To replace the rear courtesy/reading lamp bulbs in the rear assist handle:

1. Make sure the headlamp control is in the OFF position and remove the lamp and assist handle from the headliner by removing the two retaining screws.

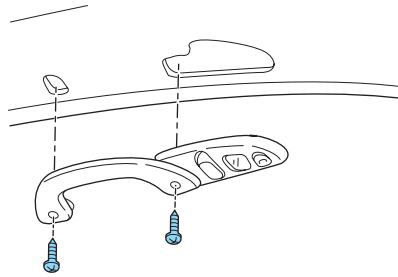

2. Disconnect the electrical connector from the lamp assembly.
3. Remove the two screws on the lamp assembly.
4. Pull the bulb straight out.

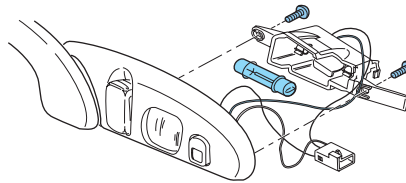

Install the new bulb in reverse order.

Driver Controls

MULTI-FUNCTION LEVER

Windshield wiper: Rotate the end of the control away from you to increase the speed of the wipers; rotate towards you to decrease the speed of the wipers.

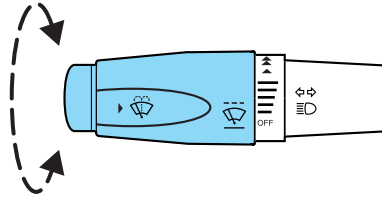

Windshield washer: Push the end of the stalk:

- briefly: causes a single swipe of the wipers without washer fluid.
- a quick push and hold: the wipers will swipe three times with washer fluid.
- a long push and hold: the wipers and washer fluid will be activated for up to ten seconds.

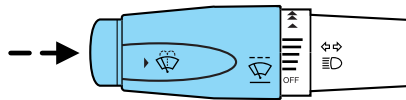

Windshield wiper/washer features

The exterior lamps will turn on with the ignition on, Headlamp control in the Autolamp position and the windshield wipers are turned on.

Changing the wiper blades

1. Pull the wiper arm away from the vehicle. Turn the blade at an angle from the wiper arm. Push the lock pin manually to release the blade and pull the wiper blade down toward the windshield to remove it from the arm.

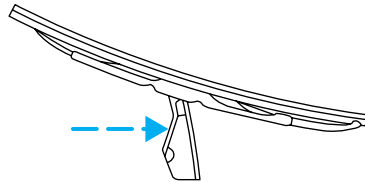

2. Attach the new wiper to the wiper arm and press it into place until a click is heard.

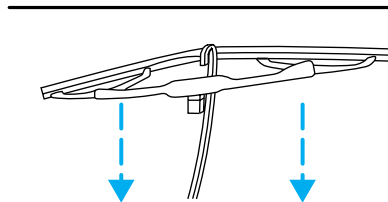

Replace wiper blades at least once per year for optimum performance.

Poor wiper quality can sometimes be improved by cleaning the wiper blades, refer to *Windows and wiper blades* in the *Cleaning* chapter.

Driver Controls

To prolong the life of the wiper blades, it is highly recommended to scrape off the ice on the windshield before turning on the wipers. The layer of ice has many sharp edges and can damage the micro edge of the wiper rubber element.

TILT STEERING WHEEL

To adjust the steering wheel:

1. Pull and hold the steering wheel release control toward you.
2. Move the steering wheel up or down until you find the desired location.
3. Release the steering wheel release control. This will lock the steering wheel in position.

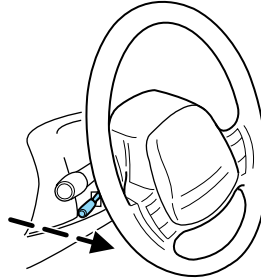

Never adjust the steering wheel when the vehicle is moving.

ILLUMINATED VISOR MIRROR (IF EQUIPPED)

Lift the mirror cover to turn on the visor mirror lamp.

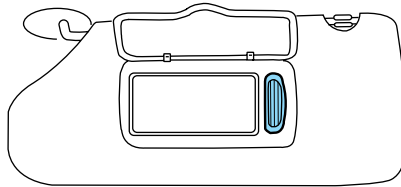

Driver Controls

Slide on rod feature (if equipped)

Rotate the visor towards the side window and extend it rearward for additional sunlight coverage.

Note: To stow the visor back into the headliner, visor must be retracted before moving it back towards the windshield.

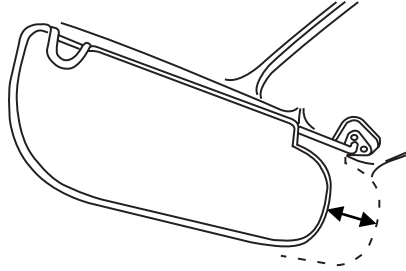

OVERHEAD CONSOLE (IF EQUIPPED)

The appearance of your vehicle's overhead console will vary according to your option package. Some of the features in the overhead console include Compass, Homelink, Oil minder and Park assist deactivation.

Normal mode

There are three normal modes; Compass, Oil Minder and Off. To select one of these:

1. From a blank display (OFF), press and release the MODE button once to enter the compass mode.
2. Press and release the MODE button again to enter the oil minder mode.
3. Press and release the MODE button again to return to OFF.

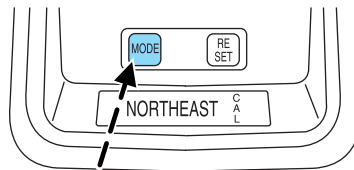

Warning mode

A system warning will display for oil minder, park assist and alarm system related warnings. A higher priority active warning message will overwrite the lower message. Press the RESET button to acknowledge the warning, the warning message is cleared and a normal mode message or another warning message will be displayed.

- The park assist de-activation cannot be cleared by the RESET button and will remain displayed until the system is reactivated.
- The oil minder has a two-level warning. The first level messages disappear from the display when the RESET button is pressed. The second level messages return on the display after a period of time.
- The alarm system warning will be displayed when you first start the vehicle and can be cleared by pressing the RESET button.

Driver Controls

Compass mode

The compass reading may be affected when you drive near large buildings, bridges, power lines and powerful broadcast antenna. Magnetic or metallic objects placed in, on or near the vehicle may also affect compass accuracy.

1. Turn ignition to the ON position.
2. Start the engine.
3. From a blank display press and release the MODE button once. The directional heading will be displayed.

Note: If the compass is de-calibrated, CAL will be displayed in the right corner of the display. Refer to “*Calibration mode*” in this section for more details.

4. The overhead console displays the compass heading in one of eight directions: NORTH, NORTHEAST, EAST, SOUTHEAST, SOUTH, SOUTHWEST, WEST, and NORTHWEST.

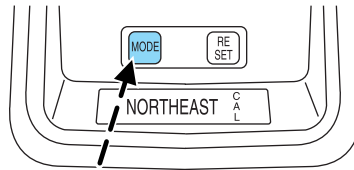

Zone variation mode

Most geographic areas (zones) have a magnetic north compass point that varies slightly from the northerly direction on maps. A correct zone setting will eliminate compass heading error.

To set the compass zone:

1. Press and release the MODE button until the compass directional heading is displayed.

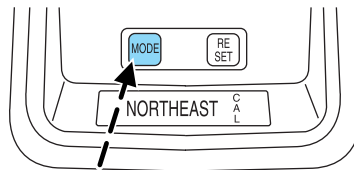

Driver Controls

2. Hold down the MODE button for 5 seconds to enter zone mode. The display will read PRESS RESET TO SET ZONE XX where XX is the current zone.

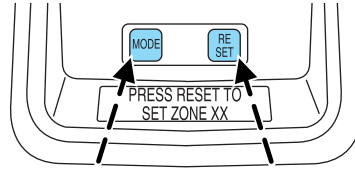

3. Release the MODE button.

4. Determine which magnetic zone you are in by referring to the zone map.

5. Repeatedly press and release the RESET button to scroll through the zones 1–15 until the desired zone is displayed.

6. Press the MODE button to save the new zone setting and return to the compass normal mode.

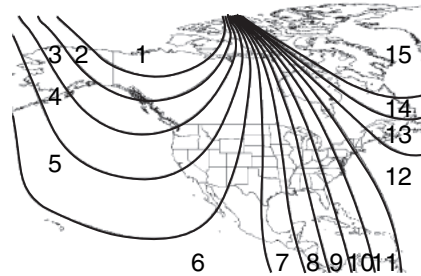

Note: The compass exits the zone setting mode and returns to its previous setting after one minute of no activity.

Note: If power is interrupted during the zone setting process, the compass resets to the same zone it was set to before the zone change process was started.

Calibration mode

For optimum calibration, turn off all electrical accessories (heater/air conditioning, wipers, etc.) and make sure all vehicle doors are shut.

To calibrate the compass:

1. Press and release the MODE button until the compass directional heading is displayed.

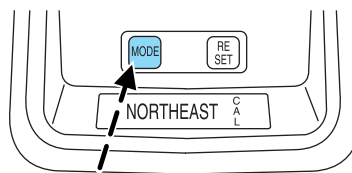

Driver Controls

2. Hold down the MODE button for 10 seconds to enter the calibration mode. The display will read PRESS RESET TO DECAL.
3. Release the MODE button.

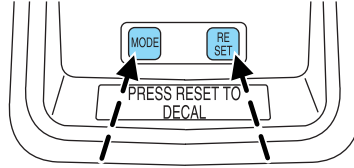

4. Press the RESET button to de-calibrate the compass. The display will read CIRCLE SLOWLY TO CALIBRATE for a few seconds and then display a direction with CAL displayed on the right side.
5. Drive the vehicle in a tight circle in a magnetically clean area such as an open parking lot.

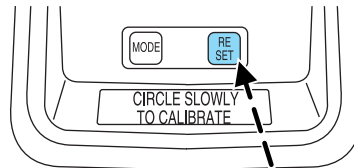

6. Slowly drive the vehicle in a circle (less than 3 mph [5 km/h]). This will take up to three circles to complete calibration.
7. The correct compass heading will be displayed when the compass is calibrated.

Note: If the RESET button is not pressed, the compass will exit calibration mode after three minutes of no activity and the original calibration data will be restored.

Note: If power is interrupted during the calibration process, the compass resets to the original calibration data from before the calibration process started.

HomeLink® wireless control system (if equipped)

The HomeLink® Wireless Control System, located on the overhead console, provides a convenient way to replace up to three hand-held transmitters with a single built-in device. This feature will learn the radio frequency codes of most transmitters to operate garage doors, entry gate operators, security systems, entry door locks, and home or office lighting. When programming your HomeLink® Wireless Control System to a garage door or gate, be sure that people and objects are out of the way to prevent potential harm or damage. Do not use the HomeLink® Wireless Control System with any garage door opener that lacks safety stop and reverse features as required by U.S. federal safety standards (this includes any garage door opener model manufactured before April 1, 1982). A garage door which cannot detect an object, signaling the

Driver Controls

door to stop and reverse, does not meet current U.S. federal safety standards. For more information, contact HomeLink® at: **www.homelink.com** or **1-800-355-3515**. Retain the original transmitter for use in other vehicles as well as for future programming procedures (i.e. new HomeLink® equipped vehicle purchase). It is also suggested that upon the sale of the vehicle, the programmed HomeLink® buttons be erased for security purposes, refer to *Programming* in this section.

Programming

Do not program the HomeLink® with the vehicle parked in the garage.

Note: Some vehicles may require the ignition switch to be turned to the second (or “ACC”) position for programming and/or operation of the HomeLink®. It is also recommended that a new battery be placed in the hand-held transmitter of the device being programmed to HomeLink® for quicker training and accurate transmission of the radio-frequency signal.

1. Press and hold the two outside buttons. The message CLEARING CHANNELS will appear on the HomeLink® display.

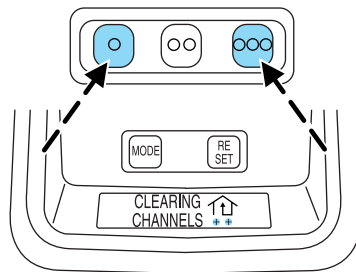

- After about 20 seconds, the message CHANNELS CLEARED will appear.

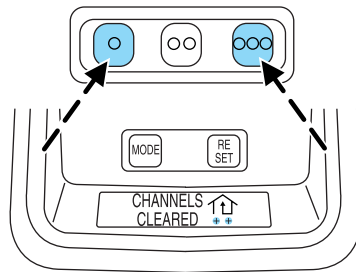

Do not repeat step one to program additional hand-held transmitters to the remaining two HomeLink® buttons. This will erase previously programmed hand-held transmitter signals into HomeLink®.

Driver Controls

2. Position the end of your hand-held transmitter 1–3 inches (2–8 cm) away from the HomeLink® button you wish to program (located on your overhead console) while keeping the display in view.

3. Simultaneously press and hold both the HomeLink® and hand-held transmitter button. The message CHANNEL “X” (1,2 or 3) TRAINING will appear on the display. **Do not release the buttons until step 4 has been completed.**

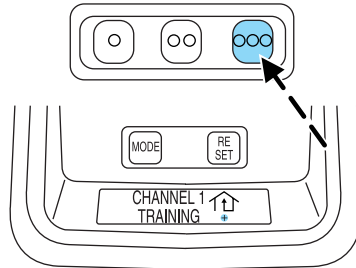

Some entry gates and garage door openers may require you to replace step 3 with procedures noted in the “Gate Operator and Canadian Programming” section for Canadian residents.

4. When the message CHANNEL “X” (1,2 or 3) TRAINED appears on the display, release both the HomeLink® and hand held transmitter buttons.

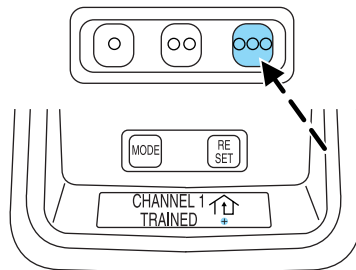

- DID NOT TRAIN will be displayed if the channel did not properly train.

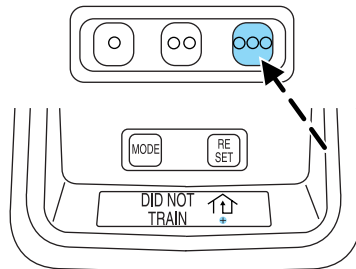

5. Press and hold the just-trained HomeLink® button and observe the HomeLink® house icon on the display. If the indicator light(s)

Driver Controls

underneath the house icon are constant, programming is complete and your device should activate when the HomeLink® button is pressed and released. **Note:** To program the remaining two HomeLink® buttons, begin with step 2 in the “Programming” section — **do not** repeat step 1.

If the indicator light(s) underneath the house icon blink rapidly for two seconds and then turn to a continuous light, proceed with steps 6 through 8 to complete programming of a rolling code equipped device.

6. At the garage door opener receiver (motor-head unit) in the garage, locate the “learn” or “smart” button (usually near where the hanging antenna wire is attached to the unit).

7. Press and release the “learn” or “smart” button. (The name and color of the button may vary by manufacturer.)

Note: There are 30 seconds in which to initiate step eight.

8. Return to the vehicle and firmly press, hold for two seconds and release the HomeLink® button. Repeat the press/hold/release sequence again, and, depending on the brand of the garage door opener (or other rolling code equipped device), repeat this sequence a third time to complete the programming.

HomeLink® should now activate your rolling code equipped device. To program additional HomeLink® buttons begin with step 2 in the “Programming” section. For questions or comments, please contact HomeLink at **www.homelink.com** or **1-800-355-3515**.

Gate operator & Canadian programming

During programming, your hand-held transmitter may automatically stop transmitting — not allowing enough time for HomeLink® to accept the signal from the hand-held transmitter.

After completing steps 1 and 2 outlined in the “Programming” section, replace step 3 with the following:

Note: If programming a garage door opener or gate operator, it is advised to unplug the device during the “cycling” process to prevent overheating.

Driver Controls

- Continue to press and hold the HomeLink® button (note step 3 in the “Programming” section) while you press and release — **every two seconds** (“cycle”) your hand-held transmitter until the frequency signal has been accepted by the HomeLink®. The message CHANNEL “X” (1,2 or 3) TRAINING will appear on the display.

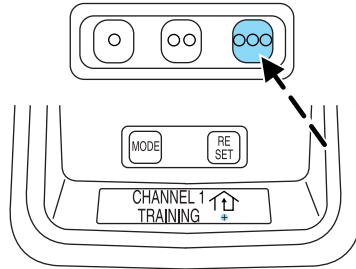

- Proceed with step 4 in the “Programming” section.

Operating the HomeLink® Wireless Control System

To operate, simply press and release the appropriate HomeLink® button. Activation will now occur for the trained product (garage door, gate operator, security system, entry door lock, or home or office lighting etc.). For convenience, the hand-held transmitter of the device may also be used at any time. In the event that there are still programming difficulties, contact HomeLink® at www.homelink.com or **1-800-355-3515**.

Erasing HomeLink® buttons

To erase the three programmed buttons (individual buttons cannot be erased):

- Press and hold the two outside buttons. The message CLEARING CHANNELS will appear on the HomeLink® display.

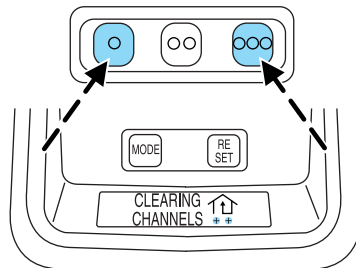

Driver Controls

- After about 20 seconds, the message CHANNELS CLEARED will appear on the display. Do not hold for longer than 30 seconds. HomeLink® is now in the train (or learning) mode and can be programmed at any time beginning with step 2 in the “Programming” section.

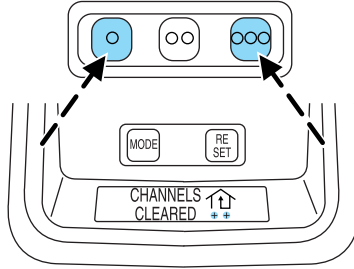

Reprogramming a single HomeLink® button

To program a device to HomeLink® using a HomeLink® button previously trained, follow these steps:

1. Press and hold the desired HomeLink® button. **DO NOT** release the button. The display will read CHANNEL “X” (1,2 or 3) TRANSMIT

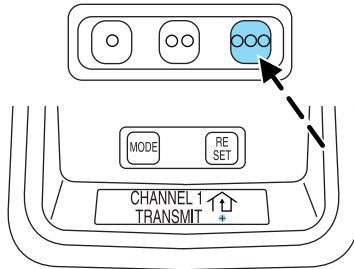

2. The display will change to CHANNEL “X” (1,2, or 3) TRAINING after 20 seconds. Without releasing the HomeLink® button, follow step 2 in the “Programming” section.

For questions or comments, contact HomeLink® at www.homelink.com or **1-800-355-3515**.

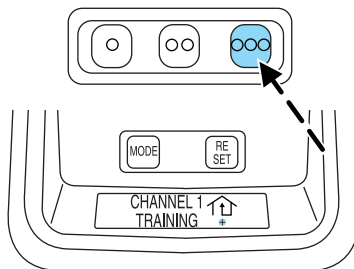

Driver Controls

Oil minder mode

Normal mode

To enter oil minder mode, press the MODE button repeatedly until OIL LIFE XX% is displayed. XX will be 6–100 when oil life is OK.

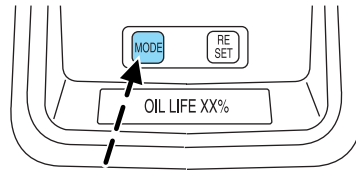

Change oil soon

The overhead console will warn the user that it is time to change the oil based on the number of engine revolution counts, number of miles driven or the calendar time since the last “Oil Life” reset. These values are constantly updated while the vehicle is running. When CHANGE OIL SOON is displayed as a warning, it will be displayed until the RESET button is pressed and revert back to the previous mode.

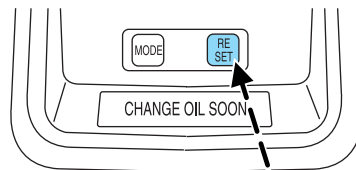

Change oil now

The overhead console will warn the user that the oil needs changing when CHANGE OIL NOW is displayed. This warning will remain on until the oil life is reset in oil minder mode (unless a higher priority message is requested). In any other mode, the CHANGE OIL NOW warning can be cleared by pressing RESET button but will return after a period of time.

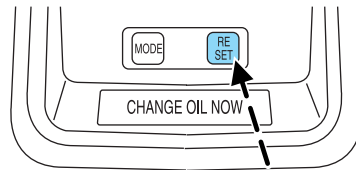

Reset oil life mode

To reset oil minder when the vehicle oil is changed:

Driver Controls

1. Press the MODE button repeatedly until one of these three messages is displayed; OIL LIFE XX%, CHANGE OIL SOON or CHANGE OIL NOW.

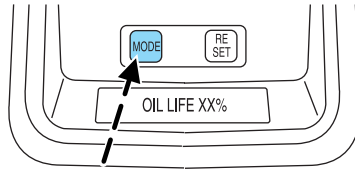

2. Press and hold the MODE button for 5 seconds until RESET FOR NEW OIL LIFE is displayed.

3. Press and hold the RESET button for 2 seconds. The oil life value will be reset to 100%

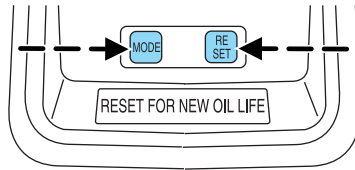

Note: If the RESET button is not pressed after one minute of no activity, the original oil life will be restored.

Note: If power is interrupted during the reset oil life mode, the overhead console resets the oil life to the original value.

Park assist de-activation (if equipped)

Park assist can be de-activated/re-activated with the transmission in R (reverse) by pressing the control on the overhead console. The system will re-activate every time the ignition key is turned ON.

To de-activate park assist:

1. Press the **P** OFF button to de-activate. PARK ASSIST DISABLED will be displayed and the button will be backlit **amber**.

2. Press the **P** OFF button again to re-activate. The button will be backlit **green** at night time when the headlamps are ON.

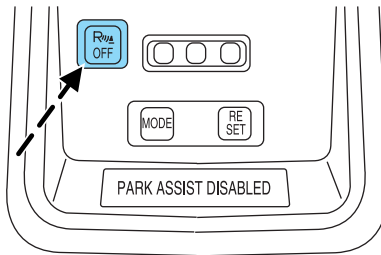

Driver Controls

CLOCK

Press the right control to move the time display forward.

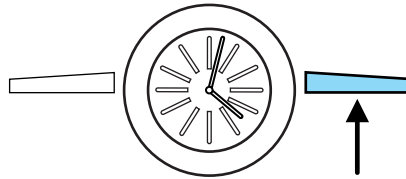

Press the left control to move the time display backwards.

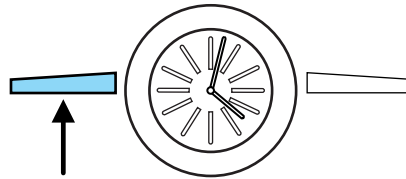

AUXILIARY POWER POINT (12VDC)

Power outlets are designed for accessory plugs only. Do not hang any type of accessory or accessory bracket from the plug. Improper use of the power outlet can cause damage not covered by your warranty.

Do not plug optional electrical accessories into the cigarette lighter. Use the power point.

Do not use the power point for operating the cigarette lighter element.

The maximum power each power point can supply depends on the fuse rating. For example: a 20A fuse should supply a maximum of 240 Watts, a 15A fuse should supply a maximum of 180 Watts and a 10A fuse should supply a maximum of 120 Watts. Exceeding these limits will result in a blown fuse.

Always keep the power point caps closed when not being used.

The auxiliary power point is located under the instrument panel.

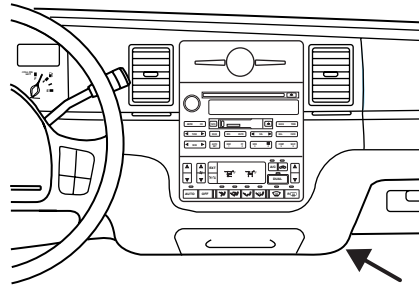

Driver Controls

POWER WINDOWS



Do not leave children unattended in the vehicle and do not let children play with the power windows. They may seriously injure themselves.



When closing the power windows, you should verify they are free of obstructions and ensure that children and/or pets are not in the proximity of the window openings.

Press and hold the rocker switches to open and close windows.

- Press the top portion of the rocker switch to close.
- Press the bottom portion of the rocker switch to open.

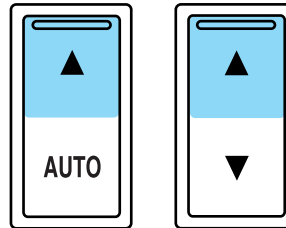

One touch down

- Press AUTO completely down and release quickly. The driver's window will open fully. Depress again to stop window operation.

One touch down can be deactivated during operation by pushing down on the top part of the driver power window control.

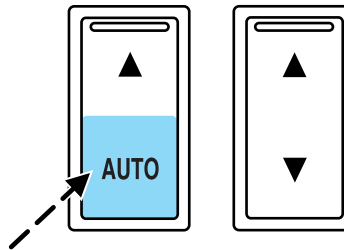

Driver Controls

Window lock

The window lock feature allows only the driver to operate the power windows.

To lock out all the window controls except for the driver's press the left side of the control. Press the right side to restore the window controls.

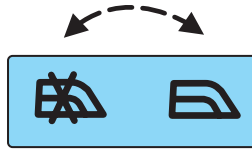

Accessory delay (if equipped)

With accessory delay, the window switches, radio, and moonroof may be used for up to ten minutes after the ignition switch is turned to the OFF position or until any door is opened.

MIRRORS

Automatic dimming inside rear view mirror (if equipped)

Your vehicle may be equipped with an inside rear view mirror which has an auto-dimming function (available as an option on the outside driver's side mirror). The electronic day/night mirror will change from the normal (high reflective) state to the non-glare (darkened) state when bright lights (glare) reach the mirror. When the mirror detects bright light from behind the vehicle, it will automatically adjust (darken) to minimize glare.

The mirror will automatically return to the normal state whenever the vehicle is placed in R (Reverse)(when the mirror is on) to ensure a bright clear view when backing up.

Do not block the sensor on the backside of the mirror since this may impair proper mirror performance.

Without Navigation System

The mirror automatically adjust (darken) to minimize glare.

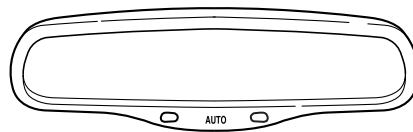

Driver Controls

With Navigation System

The illuminated LED to the right of the AUTO button indicates if the mirror is in the auto-dimming function. To turn the mirror off push the OFF button until the LED goes out.

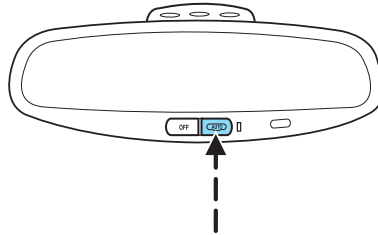

Power side view mirrors

To adjust your mirrors:

1. Select **L** to adjust the left mirror or **R** to adjust the right mirror.
2. Move the control in the direction you wish to tilt the mirror.
3. Return to the center position to disable the adjust function.



Heated outside mirrors (if equipped)

Both mirrors are heated automatically to remove ice, mist and fog when the rear window defrost is activated.

Do not remove ice from the mirrors with a scraper or attempt to readjust the mirror glass if it is frozen in place.

These actions could cause damage to the glass and mirrors.

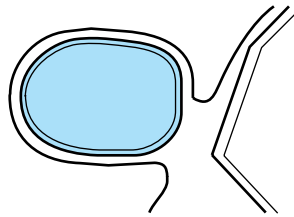

Driver Controls

Fold-away mirrors

Pull the side mirrors in carefully when driving through a narrow space, like an automatic car wash.

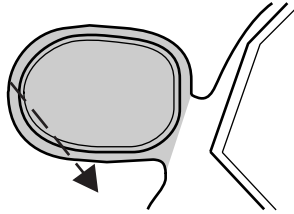

POWER ADJUSTABLE FOOT PEDALS (IF EQUIPPED)

The accelerator and brake pedal should only be adjusted when the vehicle is stopped and the gearshift lever is in the P (Park) position.

Press and hold the rocker control to adjust accelerator and brake pedal.

- Press the bottom of the control to adjust the pedals toward you.
- Press the top of the control to adjust the pedals away from you.

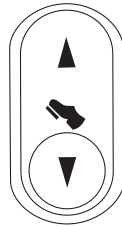

The adjustment allows for approximately 2.5 inches (65 mm) of maximum travel.



Never adjust the accelerator and brake pedal with feet on the pedals while the vehicle is moving.

SPEED CONTROL

With speed control set, you can maintain a speed of 30 mph (48 km/h) or more without keeping your foot on the accelerator pedal. Speed control does not work at speeds below 30 mph (48 km/h).



Do not use the speed control in heavy traffic or on roads that are winding, slippery or unpaved.

Driver Controls

Setting speed control

The controls for using your speed control are located on the steering wheel for your convenience.

1. Press the ON control and release it.
2. Accelerate to the desired speed.

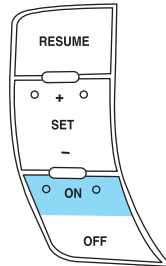

3. Press the SET + control and release it.
4. Take your foot off the accelerator pedal.
5. The message “SPEED CONTROL” will be displayed in the message center.

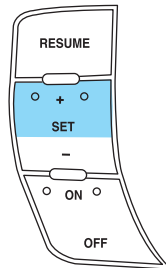

Note:

- Vehicle speed may vary momentarily when driving up and down a steep hill.
- If the vehicle speed increases above the set speed on a downhill, you may want to apply the brakes to reduce the speed.
- If the vehicle speed decreases more than 10 mph (16 km/h) below your set speed on an uphill, your speed control will disengage.

Disengaging speed control

To disengage the speed control:

- Depress the brake pedal

Disengaging the speed control will not erase previous set speed.

Driver Controls

Resuming a set speed

Press the RESUME control and release it. This will automatically return the vehicle to the previously set speed. The RESUME control will not work if the vehicle speed is not faster than 30 mph (48 km/h).

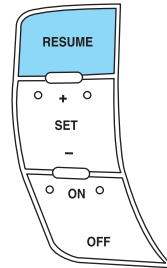

Increasing speed while using speed control

There are two ways to set a higher speed:

- Press and hold the SET + control until you get to the desired speed, then release the control. You can also use the SET + control to operate the Tap-Up function. Press and release this control to increase the vehicle set speed in small amounts by 1 mph (1.6 km/h).
- Use the accelerator pedal to get to the desired speed. When the vehicle reaches that speed press and release the SET + control.

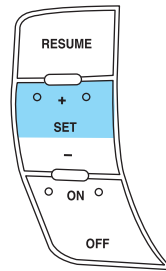

Reducing speed while using speed control

There are two ways to reduce a set speed:

- Press and hold the SET - control until you get to the desired speed, then release the control. You can also use the SET - control to operate the Tap-Down function. Press and release this control to decrease the vehicle set speed in small amounts by 1 mph (1.6 km/h).

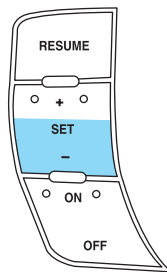

Driver Controls

- Depress the brake pedal until the desired vehicle speed is reached, press the SET + control.

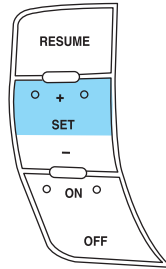

Turning off speed control

There are two ways to turn off the speed control:

- Depress the brake pedal. This will not erase your vehicle's previously set speed.
- Press the speed control OFF control.

Note: When you turn the speed control or the ignition off, your speed control set speed memory is erased.

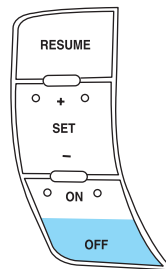

STEERING WHEEL CONTROLS (IF EQUIPPED)

These controls allow you to operate some radio and climate control features.

Audio control features

In Radio mode:

- Press NEXT to select the next preset station within the current radio band.

In Tape mode:

- Press NEXT to listen to the next selection on the tape.

In CD mode:

- Press NEXT to listen to the next track on the disc.

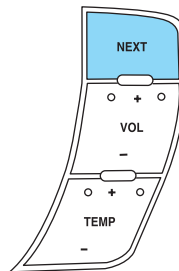

Driver Controls

In any mode:

- Press VOL + or - to adjust the volume.

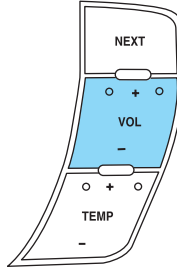

Climate control features (if equipped)

- Press TEMP + or - to adjust temperature.

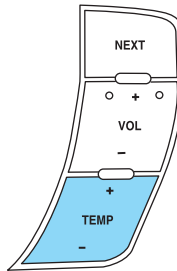

Navigation control features (if equipped)

Press and hold VOICE briefly until the voice  icon appears on the Navigation display to use the Navigation voice command.

Press the top portion of the control to hear previous command repeated from the navigation system.

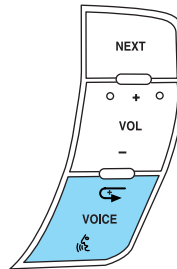

Rear console radio/climate controls (if equipped)

Refer to *Entertainment Systems and Climate Controls* chapters for operation instructions.

Driver Controls

Rear radio/climate controls lockout

The rear radio/climate control feature can be locked out by pressing the 3 and the 5 buttons on the radio simultaneously while the radio is on. To enable the rear radio/climate controls, press the 3 and the 5 buttons again.

MOON ROOF (IF EQUIPPED)

To open the moon roof:

- Press and release the control.
- For one-touch operation, press and release the rear portion of the control; this will fully open the moon roof.
- To stop one-touch operation at the desired position, press and release the forward portion of the control.

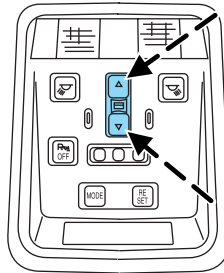

To close the moon roof:

- Press and hold the front portion of the control.
- To close from the vent position, press and hold the rear portion of the control.



Do not let children play with the moon roof or leave children unattended in the vehicle. They may seriously hurt themselves.



When closing the moon roof, you should verify that it is free of obstructions and ensure that children and/or pets are not in the proximity of the moon roof opening.

CELL PHONE USE

The use of Mobile Communications Equipment has become increasingly important in the conduct of business and personal affairs. However, drivers must not compromise their own or others' safety when using such equipment. Mobile Communications can enhance personal safety and security when appropriately used, particularly in emergency situations. Safety must be paramount when using mobile communications equipment to avoid negating these benefits.

Mobile Communication Equipment includes, but is not limited to cellular phones, pagers, portable email devices, in-vehicle communications systems, telematics devices and portable two-way radios.

Driver Controls



A driver's first responsibility is the safe operation of the vehicle. The most important thing you can do to prevent a crash is to avoid distractions and pay attention to the road. Wait until it is safe to operate Mobile Communications Equipment.

ELECTRONIC MESSAGE CENTER

The electronic message center only works when the ignition is in the ON position.

The message center allows you to:

- see problems such as door ajar and trunk ajar.
- check the on/off status of air suspension and speed control systems.

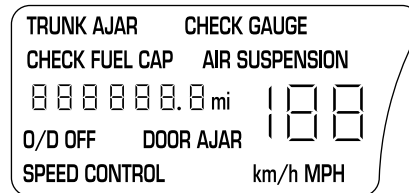

- see a more accurate speed while driving (this may not show the same speed as your analog speedometer).
- see how many miles/kilometers you can drive before running out of fuel.
- monitor the average fuel economy.
- monitor the average speed.
- check the distance traveled during a trip on either Trip A or Trip B.

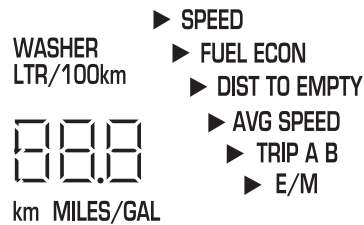

You can select different features for the message center to display by using the message center controls located in the center of the instrument panel.

Driver Controls

Selectable features

Select

Each press of the SELECT control will select a different feature as follows:

- SPEED
- FUEL ECON
- DIST TO EMPTY
- AVG SPEED
- TRIP A/TRIP B
- E/M

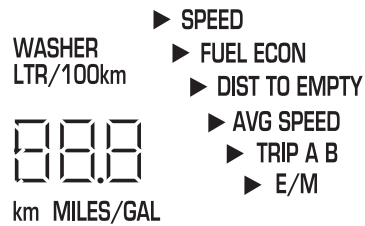

For descriptions of the SELECT features, refer to “Message center functions” later in this chapter.

Reset

Press this control to reset the selected message center function to zero. (The only functions which can be reset are FUEL ECON and TRIP A or B.)

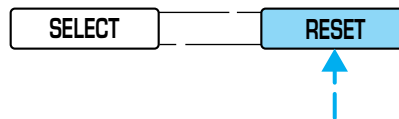

Message center functions

Speed

To use this function, select SPEED and press the RESET control. Your speed from that point will be displayed on the left side of the cluster until RESET is pressed again.

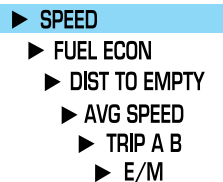

Driver Controls

Fuel econ (average fuel economy)

Select this function to display your average fuel economy in miles/gallon or liters/100 km.

If you calculate your average fuel economy by dividing gallons of fuel used by 100 miles traveled (kilometers traveled by liters used), your figure may be different than displayed for the following reasons:

- your vehicle was not perfectly level during fill-up
- differences in the automatic shut-off points on the fuel pumps at service stations
- variations in top-off procedure from one fill-up to another
- rounding of the displayed values to the nearest 0.1 gallon (liter)

Checking your highway fuel economy using the electronic message center display

The following procedure will allow you to accurately monitor your actual highway fuel economy. Since this procedure requires the vehicle speed control system to be set to highway speeds, it must be run only on suitable roadways where long distance speed control can be safely maintained.

You may notice gradual improvement in fuel economy over the course of your vehicle's break-in period (approximately 1 000 miles [1 600 kilometers]).

1. Set the speed control. Refer to *Speed control* in this chapter.
2. Select FUEL ECON

- ▶ SPEED
- ▶ FUEL ECON
- ▶ DIST TO EMPTY
- ▶ AVG SPEED
- ▶ TRIP A B
- ▶ E/M

- ▶ SPEED
- ▶ FUEL ECON
- ▶ DIST TO EMPTY
- ▶ AVG SPEED
- ▶ TRIP A B
- ▶ E/M

Driver Controls

3. Press the RESET control to clear the system memory.

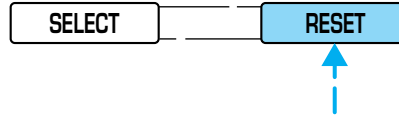

- *Actual highway fuel economy is now displayed.* This current average measure will change as the speed control system changes the engine speed to maintain a constant vehicle speed. This is most noticeable in hilly environments.

4. Drive the vehicle at least 5 miles (8 km) with the speed control system engaged to display a stabilized average.

5. Record the highway fuel economy for future reference.

It is important to press the RESET control after setting the speed control to get accurate highway fuel economy readings.

Dist to empty (DTE)

This function estimates approximately how far you can drive with the fuel remaining in your tank under normal driving conditions. Remember to turn the ignition OFF when refueling to allow this feature to correctly detect the added fuel.

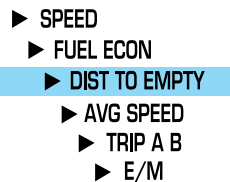

The DTE function will flash for 5 seconds and sound a tone for 1 second when you have approximately:

- 50 miles (80 km) left before you run out of fuel
- 25 miles (40 km)
- 10 miles (16 km)

DTE is calculated using a running average fuel economy, which is based on your recent driving history of 500 miles (800 km). This value is not the same as the average fuel economy display. The running average fuel economy is reinitialized to a factory default value if the battery is disconnected.

If “CO” or “CS” is displayed, there is a problem with the fuel indication system and you should contact your dealer for service as soon as possible.

Driver Controls

AVG speed

To use this function, select AVG SPEED and press the RESET control. Your average speed from that point will be displayed until RESET is pressed again.

- ▶ SPEED
- ▶ FUEL ECON
- ▶ DIST TO EMPTY
- ▶ **AVG SPEED**
- ▶ TRIP A B
- ▶ E/M

Trip A B

These two functions allow you to see how far you have traveled since you last reset. Trip A and Trip B are completely independent and must be reset individually.

- ▶ SPEED
- ▶ FUEL ECON
- ▶ DIST TO EMPTY
- ▶ AVG SPEED
- ▶ **TRIP A B**
- ▶ E/M

To reset either trip feature to zero, press the RESET control while the appropriate trip distance feature (A or B) is displayed.

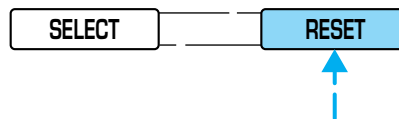

E/M

When this function is displayed, press the RESET control to change the message center display from metric to English units or from English to metric units.

- ▶ SPEED
- ▶ FUEL ECON
- ▶ DIST TO EMPTY
- ▶ AVG SPEED
- ▶ TRIP A B
- ▶ **E/M**

Driver Controls

POWER TRUNK (IF EQUIPPED)

Your vehicle may be equipped with a power trunk controlled by the interior trunk control, the key fob or the keypad on the door.

If anything obstructs the power trunk while it is closing, the trunk will automatically reverse to the open position, provided it meets sufficient resistance. Resistance must be as strong as the force of the closing trunk, or stronger. The force of the closing trunk increases as the trunk approaches the latched position. The trunk will close with the next press of the interior trunk control or key fob button.



Make sure all persons are clear of the luggage compartment area before using the power trunk control.

If the battery is disconnected, discharged, or a new battery is installed, the power trunk needs to be reset. To reset the power trunk:

- Reconnect the battery with the trunk closed
- Power activate the trunk with the power interior trunk release, the key fob or the keypad on the door to the full open position, then power activate the same power source and fully close the trunk. The power trunk is now reset.

INTERIOR TRUNK CONTROL

The remote trunk release control is located on the driver's door trim panel and can be operated at any time except when your perimeter alarm system is armed.

If your vehicle is equipped with a power trunk, press the button once to open the trunk, press it again to close.

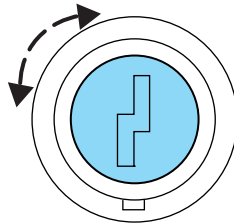

You can render the switch inoperable by locking the button with your master key.

The remote trunk release control and power door locks will be disabled when the vehicle perimeter alarm system is armed. This control will not work until the vehicle perimeter alarm system is disarmed. Refer to *Perimeter Alarm System* in the *Locks and Security* chapter.

Driver Controls

FUEL DOOR RELEASE

Your vehicle is equipped with a locking fuel door. To open the door, press the control located on the door.

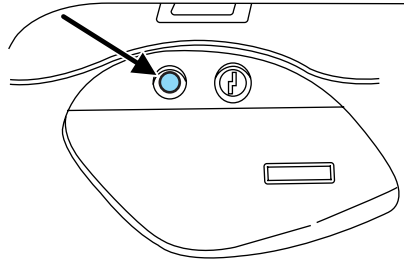

Fuel filler door override release

If the remote release is inoperative, open the trunk, then pull the override release handle located inside the trunk to open the fuel filler door.

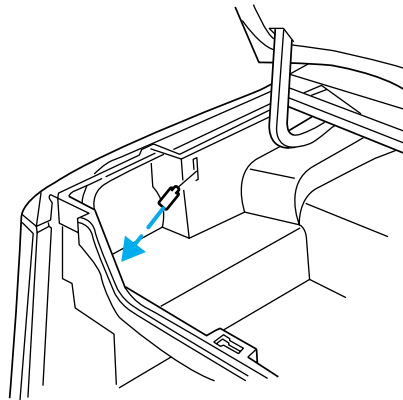

REAR CENTER CONSOLE FEATURES (IF EQUIPPED)

The rear center console incorporates the following features:

- utility compartment
- auxiliary power point (if equipped)
- remote radio/climate controls (if equipped)
- remote seat adjustment (if equipped)

Driver Controls

Remote seat adjustment

The rear passenger can move the front passenger seat forward or backward using the control located in the rear center console.

Move the control forward or backward to move front passenger seat.

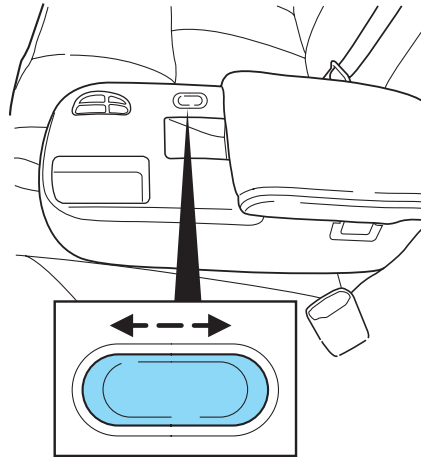

Remote seat adjustment lockout

The window lockout control, located on the drivers door, will also lockout the remote seat adjustment. To lock out the remote seat adjustment feature, press the right side of the control. Press the left side to restore the remote seat adjustment control.

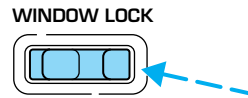

POSITIVE RETENTION FLOOR MAT

Position the driver floor mat so that the eyelet is over the pointed end of the retention post and rotate forward to lock in. Make sure that the mat does not interfere with the operation of the accelerator or the brake pedal. To remove the floor mat, reverse the installation procedure.

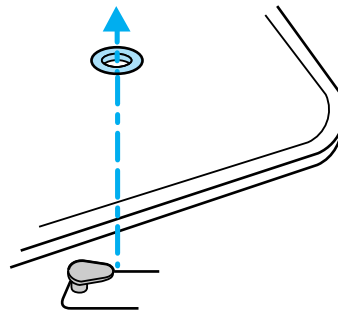

Locks and Security

KEYS

Your vehicle is equipped with a master key and a valet (identified with the word VALET) key lock system. The master key will access:

- the driver's door,
- the trunk,
- the glove box,
- the ignition, and
- the interior trim remote trunk release.

The valet key will access:

- the driver's door,
- the ignition.

Before handing over the valet key to a valet attendant, lock the interior remote trunk release control and the glove box with the master key. Do not hand over the remote entry transmitter or the master key to the valet attendant.

POWER DOOR LOCKS

Press control to unlock all doors.

Note: When the perimeter alarm is armed, the power door locks are disabled.



Press control to lock all doors.



Smart locks

With the key in the ignition, in any switch position, and either the driver's or passenger's door open, the doors cannot be locked using the power door lock switches.

Central locking/unlocking

- All doors are locked when the key is inserted into the driver door key cylinder and turned to the lock position.
- The driver's door is unlocked when the key is inserted into the driver door key cylinder and turned to the unlock position.

Locks and Security

- If the key is turned a second time to the unlock position within 5 seconds, all vehicle doors will unlock.

Power door trim switch inhibit

This feature disables the power door locks and trunk interior release switches if all doors are closed and the perimeter alarm becomes armed.

Once the power door trim switches are disabled, they can only become active when perimeter alarm is disarmed.

Childproof door locks

- When these locks are set, the rear doors cannot be opened from the inside.
- The rear doors can be opened from the outside when the doors are unlocked.

The childproof locks are located on rear edge of each rear door and must be set separately for each door. Setting the lock for one door will not automatically set the lock for both doors.



- Move lock control up to engage the childproof lock.
- Move control down to disengage childproof locks.

INTERIOR LUGGAGE COMPARTMENT RELEASE

Your vehicle is equipped with a mechanical interior luggage compartment release handle that provides a means of escape for children and adults in the event they become locked inside the luggage compartment.

Adults are advised to familiarize themselves with the operation and location of the release handle.

Locks and Security

To open the luggage compartment door (lid) from within the luggage compartment, pull the illuminated “T” shaped handle and push up on the trunk lid. The handle is composed of a material that will glow for hours in darkness following brief exposure to ambient light.

The “T” shaped handle will be located either on the luggage compartment door (lid) or inside the luggage compartment near the tail lamps.



 Keep vehicle doors and luggage compartment locked and keep keys and remote transmitters out of a child's reach. Unsupervised children could lock themselves in the trunk and risk injury. Children should be taught not to play in vehicles.

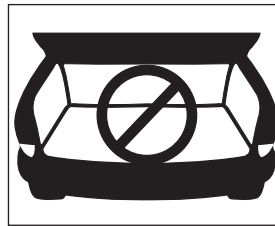

 On hot days, the temperature in the trunk or vehicle interior can rise very quickly. Exposure of people or animals to these high temperatures for even a short time can cause death or serious heat-related injuries, including brain damage. Small children are particularly at risk.

REMOTE ENTRY SYSTEM

This device complies with part 15 of the FCC rules and with RS-210 of Industry Canada. Operation is subject to the following two conditions: (1) This device may not cause harmful interference, and (2) This device must accept any interference received, including interference that may cause undesired operation.

Locks and Security

Changes or modifications not expressly approved by the party responsible for compliance could void the user's authority to operate the equipment.

The typical operating range for your remote entry transmitter is approximately 33 feet (10 meters). A decrease in operating range could be caused by:

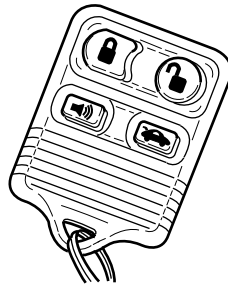

- weather conditions,
- nearby radio towers,
- structures around the vehicle, or
- other vehicles parked next to your vehicle.

The remote entry system allows you to lock or unlock all vehicle doors without a key. **Note:** The remote entry features operate with the ignition in any position except in the 3 (ON) position, when the transmission is in any gear other than P (Park) or N (Neutral).



If there are problems with the remote entry system, make sure to take **ALL remote entry transmitters** with you to the dealership in order to aid in troubleshooting the problem.

Unlocking the doors

1. Press  and release to unlock the driver's door. **Note:** The interior lamps will illuminate.
2. Press  and release again within five seconds to unlock all the doors.

Security lighting

Your vehicle's headlamps and park lamps will illuminate if:

- it is dark outside (evening),
- the headlamp control is in the autolamp position, and
- the unlock control is pressed on the remote entry transmitter.

The headlamps and parklamps remain illuminated:

- for 25 seconds, or
- until you turn the ignition from the 1 (OFF/LOCK) position, or

Locks and Security

- until the vehicle doors are locked using the remote entry transmitter or the power door unlock control.

Locking the doors

Press  and release to lock all the doors. **Note:** The interior lamps will turn off and the parklamps will flash, if all the closures (doors, trunk, hood) are closed. If any closure is not closed, the parklamps will **not** flash.

Press  and release again within five seconds to confirm that all the doors are closed. **Note:** The doors will lock again, the horn will chirp once and the parklamps will flash, if all the closures are closed. If any closure is not closed, the horn will chirp twice and the parklamps will **not** flash.

Deactivating/activating the horn chirp feature

The horn chirp feature can be turned on/off through the following procedure:

Complete Steps 1-7 within 30 seconds or you must repeat the procedure. Wait 30 seconds before repeating the procedure.

1. Turn the ignition to the 3 (ON) position.
2. Press the power door unlock control on the door panel 3 times.
3. Cycle the ignition from the 3 (ON) to the 1 (OFF/LOCK) position.
4. Press the power door unlock control 3 times.
5. Turn the ignition to the 3 (ON) position. The doors will lock and unlock.
6. Press the unlock control twice within 5 seconds. The horn will chirp twice to indicate a successful activation/deactivation of the horn chirp feature.
7. Turn the ignition to the 1 (OFF/LOCK) position.

Sounding a panic alarm

Press  on the remote transmitter to activate the alarm. **Note:** The panic alarm only works with the ignition in the 1 (OFF/LOCK) position.

Press  a second time to deactivate the alarm. You may also deactivate the alarm in the following ways:

- Turn the ignition to the 2 (ACCESSORY), 3 (ON) or 4 (START) positions.

Locks and Security

- Wait 2 minutes and 45 seconds for the alarm to time-out.

Opening the trunk

Press  once to open the trunk.

If your vehicle is fitted with the optional power decklid, press  twice to open the trunk and twice to close it.



Before operating the power decklid, be sure that no one, particularly a child, is in a position where he or she can be injured by the trunk lid. NEVER leave the remote entry transmitter where it can be inadvertently activated, as someone could be seriously injured by a moving decklid.

- Ensure that the trunk is closed and latched before driving your vehicle. Failure to properly latch the trunk may cause objects to fall out or block the driver's rear view.

The remote entry system allows you to open the trunk while the ignition is in any position. However, if the ignition is in the 3 (ON) position and the gearshift is in D (Drive), the trunk will only open if the vehicle is moving 5 km/h (3 mph) or slower.

Replacing the battery

The remote entry transmitter uses one coin type three-volt lithium battery CR2032 or equivalent.

To replace the battery:

1. Twist a thin coin between the two halves of the remote entry transmitter near the key ring. DO NOT TAKE THE RUBBER COVER AND CIRCUIT BOARD OFF THE FRONT HOUSING OF THE REMOTE ENTRY TRANSMITTER.

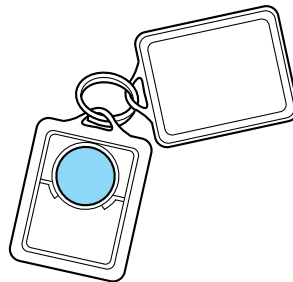

Locks and Security

2. Do not wipe off any grease on the battery terminals on the back surface of the circuit board.

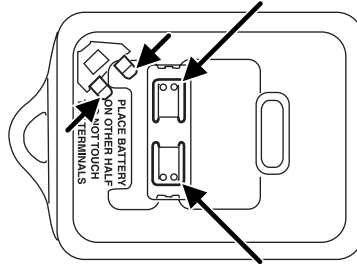

3. Remove the old battery. **Note:** Please refer to local regulations when disposing of transmitter batteries.

4. Insert the new battery. Refer to the diagram inside the remote entry transmitter for the correct orientation of the battery. Press the battery down to ensure that the battery is fully seated in the battery housing cavity.

5. Snap the two halves back together.

Note: Replacement of the battery will **not** cause the remote transmitter to become deprogrammed from your vehicle. The remote transmitter should operate normally after battery replacement.

Replacing lost remote entry transmitters

If you would like to have your remote entry transmitter reprogrammed because you lost one, or would like to buy additional remote entry transmitters, you can either reprogram them yourself, or take **all remote entry transmitters** to your authorized dealer for reprogramming.

How to reprogram your remote entry transmitters

You must have **all remote entry transmitters** (maximum of four) available before beginning this procedure.

Locks and Security

To reprogram the remote entry transmitters:

1. Ensure the vehicle is electronically unlocked.
2. Put the key in the ignition.
3. Cycle eight times rapidly (within 10 seconds) between the 1 (OFF/LOCK) position and the 3 (ON) position. **Note:** The eighth turn must end in the 3 (ON) position.
4. The doors will lock, then unlock, to confirm that the programming mode has been activated.
5. Within 20 seconds press any button on the remote entry transmitter. **Note:** If more than 20 seconds have passed you will need to start the procedure over again.
6. The doors will lock, then unlock, to confirm that this remote entry transmitter has been programmed.
7. Repeat Step 6 to program each additional remote entry transmitter.
8. Turn the ignition to the 1 (OFF/LOCK) position after you have finished programming all of the remote entry transmitters. **Note:** After 20 seconds, you will automatically exit the programming mode.
9. The doors will lock, then unlock, to confirm that the programming mode has been exited.

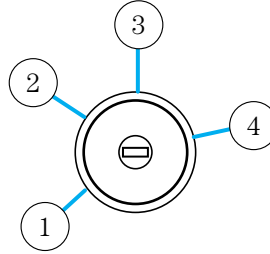

Illuminated entry

The interior lamps illuminate when the remote entry system is used to unlock the door(s) or sound the personal alarm.

The illuminated entry system will turn off the interior lights if:

- the ignition switch is turned to the 3 (ON) or the 2 (ACCESSORY) position, or
- the remote transmitter lock control is pressed, or
- after 25 seconds of illumination.

The dimmer panel control must **not** be set to the **off** position for the illuminated entry system to operate.

The inside lights will not turn off if:

- they have been turned on with the dimmer control, or

Locks and Security

- any door is open.

The battery saver will shut off the interior lamps 30 minutes after the last door is closed, or after 10 minutes if the last door is left open.

Autolock

This feature automatically locks all vehicle doors when the following conditions are met:

- all the doors are closed,
- the engine is running,
- you shift into gear, putting the vehicle in motion, and.
- the vehicle's speed is greater than 3 mph (5 km/h).

Relock

The autolock feature repeats when the following conditions are met:

- any door is opened then closed while the engine is running, and
- you shift into gear, putting the vehicle in motion, and.
- the vehicle's speed is greater than 3 mph (5 km/h).

To deactivate/reactivate the autolock feature using the power door unlock control

You must complete Steps 1-7 within 30 seconds or the procedure will have to be repeated. If the procedure needs to be repeated, you must wait 30 seconds.

1. Turn the ignition to the 3 (ON) position.
2. Press the power door unlock control three times.
3. Turn the ignition from the 3 (ON) to the 1 (OFF/LOCK) position.
4. Press the power door unlock control three times.
5. Turn the ignition back to the 3 (ON) position. The door locks will cycle to lock and unlock.
6. Press the unlock control. After five seconds, the horn will chirp once to indicate the enabling/disabling of the autolock feature.
7. Turn the ignition to the 1 (OFF/LOCK) position.

Memory seat/mirrors/adjustable pedals feature (if equipped)

The remote keyless entry system can also control the memory seats/mirrors/adjustable pedals feature. With this feature, the first two programmed transmitters will recall a different memory position.

Locks and Security

Press  once to unlock the driver's door and move the memory features to the corresponding memory position, just as if you had pressed the memory control in the vehicle.

Activating the memory seat/mirrors/adjustable pedals feature

To activate this feature:

1. Position the seat, mirrors and adjustable pedals to the position desired.
2. Press the SET control on the driver's door panel.
3. Within five seconds, press one control on the remote transmitter and then press the 1 or 2 button on the driver's door panel to which you would like to associate with the memory positions and Driver 1 or Driver 2 positions.
4. Repeat this procedure for another remote transmitter, if desired.

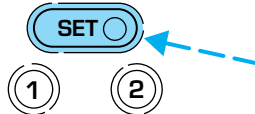

Deactivating the memory seat/mirrors/adjustable pedals feature

To deactivate this feature:

1. Press the SET control on the driver's door panel.
2. Within five seconds, press one control on the remote transmitter which you would like to deactivate and then press the SET control on the driver's door panel .
3. Repeat this procedure for another remote transmitter, if desired.

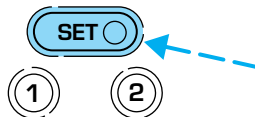

KEYLESS ENTRY SYSTEM (IF EQUIPPED)

You can use the keyless entry keypad to:

- lock or unlock the doors without using a key.
- open the trunk.

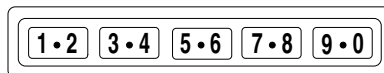

The keypad can be operated with the factory set 5-digit entry code; this code is located on the owner's wallet card in the glove box, is marked on the computer module, and is available from your authorized dealer. You can also create your own 5-digit personal entry code.

When pressing the controls on the keypad, press the middle of the controls to ensure a good activation.

Locks and Security

Programming a personal entry code

To create your own personal entry code:

1. Enter the factory set code.
2. Within five seconds press the 1 • 2 on the keypad.
3. Enter your personal 5-digit code. Each number must be entered within five seconds of each other.
4. Enter a sixth digit to indicate which personality feature should be recalled by the personal code.
 - 1 • 2 recalls driver personality 1.
 - 3 • 4 recalls driver personality 2.
 - 5 • 6, 7 • 8 and 9 • 0 do not recall a driver personality.

All of the vehicle doors will lock and unlock to confirm programming of the new code. Each driver personality profile (personality 1 or personality 2) can be associated with only one personal code. The factory-set code cannot be associated with a personality code.

You can program up to three personal codes to unlock your vehicle. These codes do not replace the permanent code that was provided by your dealer.

Tips for setting codes:

- Do not set a code that uses five of the same number.
- Do not use five numbers in sequential order.

Erasing personal codes

1. Enter the factory set 5-digit code. The keyless entry keypad and interior lights will illuminate and the driver's door will unlock.
2. Press and release the 1 • 2 within five seconds of completing Step 1.
3. Press and hold the 1 • 2 for two seconds to erase the customer programmed codes.

All personal codes are now erased and only the factory set 5-digit code will work.

Note: To exit programming mode, either wait 5 seconds after pressing 1 • 2 on the keypad, or press the 7 • 8 and 9 • 0 pads simultaneously to lock all vehicle doors and end programming mode.

Locks and Security

Unlocking and locking the doors using keyless entry keypad

To unlock the driver's door, enter the factory set 5-digit code or your personal code. Each number must be pressed within five seconds of each other. **Note:** The driver's door will unlock and the interior lamps will illuminate after the factory set 5-digit code or your personal code are correctly entered.

To unlock all doors, press the 3 • 4 control within five seconds.

To lock all doors, press the 7 • 8 and the 9 • 0 at the same time. You **do not** need to enter the keypad code first. **Note:** The interior lamps will turn off.

Releasing the trunk with the keyless entry system

To release/open the trunk, enter the factory-set code or personal code (driver door unlocks) and press 5 • 6 within five seconds.

If your vehicle is equipped with the optional power decklid, pressing 5 • 6 again will close it (you may need to reenter the keypad code again).



Before operating the power decklid, be sure that no one, particularly a child, is in a position where he or she can be injured by the trunk lid. NEVER leave the remote entry transmitter where it can be inadvertently activated, as someone could be seriously injured by a moving decklid.

SECURILOCK™ PASSIVE ANTI-THEFT SYSTEM

SecuriLock™ passive anti-theft system is an engine immobilization system. This system is designed to help prevent the engine from being started unless a **coded key programmed to your vehicle** is used. The use of the wrong type of coded key may lead to a “no-start” condition.

Your vehicle comes with three coded keys; additional coded keys may be purchased from your dealer. The dealer can program your spare keys to your vehicle or you can program the keys yourself. Refer to *Programming spare keys* for instructions on how to program the coded key.

Note: The SecuriLock™ passive anti-theft system is not compatible with non-Ford aftermarket remote start systems. Use of these systems may result in vehicle starting problems and a loss of security protection.

Locks and Security

Note: Large metallic objects, electronic devices that are used to purchase gasoline or similar items, or a second coded key on the same key chain may cause vehicle starting issues. You need to prevent these objects from touching the coded key while starting the engine. These objects will not cause damage to the coded key, but may cause a momentary issue if they are too close to the key when starting the engine. If a problem occurs, turn the ignition off, remove all objects on the key chain away from the coded key and restart the engine.

Theft indicator

The theft indicator is located on top of the instrument panel.

- When the ignition is in the 1 (OFF/LOCK) position, the indicator will flash once every 2 seconds to indicate the SecuriLock[™] system is functioning as a theft deterrent.
- When the ignition is in the 3 (ON) position, the indicator will glow for 3 seconds to indicate normal system functionality.

If a problem occurs with the SecuriLock[™] system, the indicator will flash rapidly or glow steadily when the ignition is in the 3 (ON) position. If this occurs, the vehicle should be taken to an authorized dealer for service.

Automatic arming

The vehicle is armed immediately after switching the ignition to the 1 (OFF/LOCK) position.

The theft indicator will flash every two seconds when the vehicle is armed.

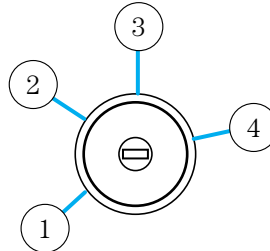

Automatic disarming

Switching the ignition to the 3 (ON) position with a **coded key (programmed to your vehicle)** disarms the vehicle and allows the engine to start. The indicator on the instrument panel will illuminate for three seconds and then go out. If the indicator stays on for an extended period of time or flashes rapidly, have the system serviced by your dealership or a qualified technician.

Locks and Security

Replacement keys

If your keys are lost or stolen and you don't have an extra coded key, you will need to have your vehicle towed to a dealership. The key codes need to be erased from your vehicle and new coded keys will need to be programmed.

Replacing coded keys can be very costly. Store an extra programmed key away from the vehicle in a safe place to help prevent any inconveniences. Please visit an authorized dealer to purchase additional spare or replacement keys.

Programming spare keys

You can program your own coded keys to your vehicle. Please read and understand the entire procedure before you begin.

Tips:

- A maximum of eight keys can be coded to your vehicle.
- Only use SecuriLock[™] keys.
- You must have two previously programmed coded keys (keys that already operate your vehicle's engine) and the new unprogrammed key(s) readily accessible.
- If no previously programmed coded keys are available, you must take your vehicle to your dealer to have the spare key(s) programmed.

1. Insert a previously programmed coded key into the ignition.
2. Turn the ignition from the 1 (OFF/LOCK) position to the 3 (ON) position. Keep the ignition in the 3 (ON) position for at least one second, but no more than 10 seconds.
3. Turn the ignition to the 1 (OFF/LOCK) position, and remove the coded key from the ignition.
4. Within ten seconds of removing the previously programmed coded key, insert the other previously programmed coded key into the ignition.
5. Turn the ignition from the 1 (OFF/LOCK) position to the 3 (ON) position. Keep the ignition in the 3 (ON) position for at least one second but not more than 10 seconds.
6. Turn the ignition to the 1 (OFF/LOCK) position, and remove the second key from the ignition.

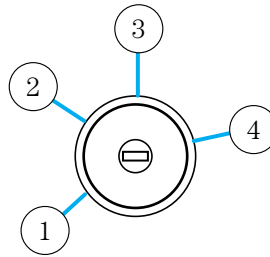

Locks and Security

7. Within twenty seconds of removing the previously programmed coded key, insert the unprogrammed key (new/valet key) into the ignition.
8. Turn the ignition from the 1 (OFF/LOCK) position to the 3 (ON) position. Keep the ignition in the 3 (ON) position for at least one second.
9. Your new unprogrammed key is now programmed.

If the key has been successfully programmed it will start the vehicle's engine and the theft indicator light will illuminate for three seconds and then go out. If the key was not successfully programmed, it will not start your vehicle's engine and the theft indicator light will flash on and off rapidly. If failure repeats, bring your vehicle to your dealer to have the new key(s) programmed.

To program additional new unprogrammed key(s), repeat this procedure from Step 1 for each additional key.

PERIMETER ALARM SYSTEM (IF EQUIPPED)

The perimeter anti-theft system will warn you in the event of an unauthorized entry to your vehicle.

If there is any potential perimeter anti-theft problem with your vehicle, ensure **ALL remote entry transmitters** are taken to the dealership to aid in troubleshooting.

Arming the system

When armed, the perimeter alarm will notify you of an unauthorized entry. When unauthorized entry occurs, the system will flash the park lamps and will sound the horn.

The system is ready to arm whenever the key is out of the ignition. Any of the following actions will arm the alarm system:

- Press the remote transmitter lock control one time to arm the system.
- Lock all doors using the keypad.
- Lock all doors using the interior power lock switch while the driver or passenger door is open and then closed.
- Lock all doors with the key in the key lock cylinder.

Locks and Security

If all the closures (doors, trunk, hood) are closed, the park lamps will flash once and the horn will chirp once when the  on the remote entry transmitter is pressed a second time within five seconds.

If any closure is not properly closed, the park lamps will not flash and the horn will chirp twice.

The system will wait 20 seconds after one of the actions is performed before allowing an alarm to go off. After the 20-second pre-arm phase, the interior trim remote trunk release control and the power door unlock control are disabled, in order to further protect your vehicle.

Disarming the system

You can disarm the system by any of the following actions:

- Unlock the doors by using the remote entry transmitter.
- Unlock the doors using a valid code on the keypad.
- Unlock the doors with the key in the key lock cylinder.
- Turn the ignition to the 3 (ON) position with a programmed coded ignition key.

Seating and Safety Restraints

SEATING

Adjustable head restraints

Your vehicle's seats are equipped with head restraints which are vertically adjustable. The purpose of these head restraints is to help limit head motion in the event of a rear collision. To properly adjust your head restraints, lift the head restraint so that it is located directly behind your head or as close to that position as possible. Refer to the following to raise and lower the head restraints.

The head restraints can be moved up and down.

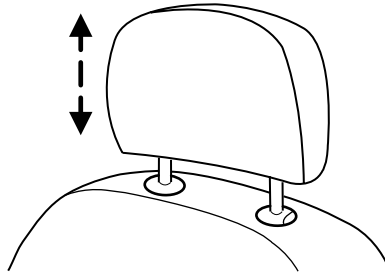

Push control to lower head restraint.

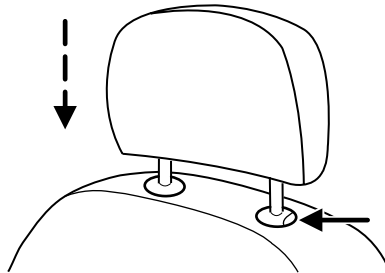

Using the manual recline function (if equipped)



Never adjust the driver's seat or seatback when the vehicle is moving.



Do not pile cargo higher than the seatbacks to avoid injuring people in a collision or sudden stop.



Always drive and ride with your seatback upright and the lap belt snug and low across the hips.

Seating and Safety Restraints



Reclining the seatback can cause an occupant to slide under the seat's safety belt, resulting in severe personal injuries in the event of a collision.

To adjust the front seatback using the manual recliner:

- Lift and hold the handle located on the side of the seat.
- Lean against the seatback to adjust it to your desired position. You can recline the seat back or bring it forward.
- Release the handle when the desired position has been reached.

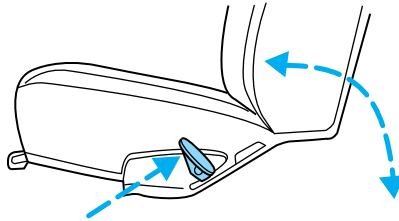

Front seat armrest

The front seat armrest has a locking feature which is engaged when the armrest is in the up position and a collision with sufficient forward deceleration causes a locking pin to activate. To disengage this locking pin, the armrest must be inspected and serviced by a qualified technician in accordance with the vehicle service manual.

Using the power lumbar support (if equipped)

The power lumbar control is located on the front inboard side of the seat.

Press the top side of the control to adjust firmness.

Press the bottom side of the control to adjust softness.

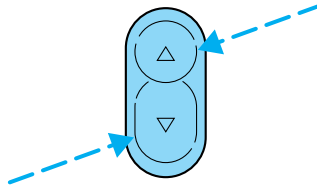

Adjusting the power front seats – door mounted controls (if equipped)

The controls for the power seats are located on the inside of each front door.



Never adjust the driver's seat or seatback when the vehicle is moving.

Seating and Safety Restraints



Do not pile cargo higher than the seatbacks to avoid injuring people in a collision or sudden stop.



Always drive and ride with your seatback upright and the lap belt snug and low across the hips.



Reclining the seatback can cause an occupant to slide under the seat's safety belt, resulting in severe personal injuries in the event of a collision.

Press the control to recline the seatback forward or backward.

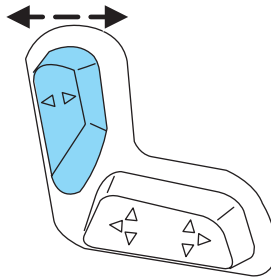

Press to move the seat forward or backward.

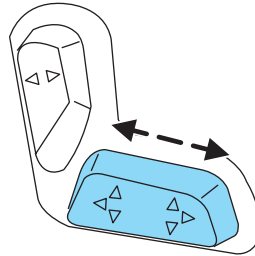

Seating and Safety Restraints

Press to move the front portion of the seat cushion up or down.

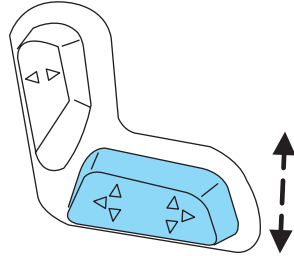

Press to move the rear portion of the seat cushion up or down.

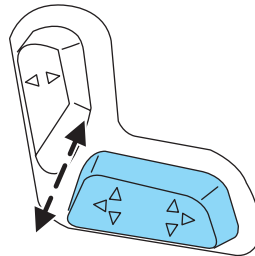

Heated seats (if equipped)

To operate the heated seats:

- Push the indicated side of the control for maximum heat.
- Push again to deactivate.

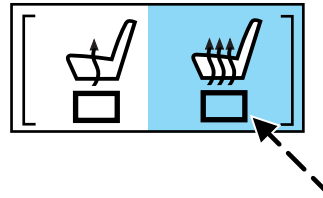

- Push the indicated side of the control for minimum heat.
- Push again to deactivate.

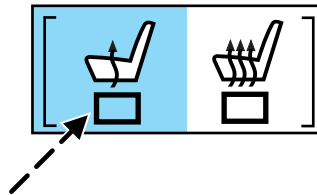

Seating and Safety Restraints

The heated seat module resets at every ignition run cycle. While the ignition is in the ON position, activating the high or low heated seat switch enables heating mode. When activated, they will turn off automatically when the ignition is turned to the OFF position.

The indicator light will illuminate when the heated seats have been activated.

Rear heated seats (if equipped)

The rear seat heat controls are located on the rear door panels and operate like the front heated seats. Refer to the *Heated Seats* section in this chapter for instructions on operating the rear heated seats.

Easy-access/easy-out feature (if equipped)

This feature automatically moves the driver's seat backward when:

- the transmission is in N (Neutral) or P (Park)
- the key is removed from the ignition cylinder

The seat will move 2 inches (5 cm) forward (to the original position) when:

- the transmission is in N (Neutral) or P (Park)
- the key is placed in the ignition cylinder

Seat mounted cup holders

Your vehicle may be equipped with cupholders in the cushion of the front center seat and the rear seat . The rear seat cupholder is designed to over rotate from the seat when subjected to a heavy load. The rear seat cupholder can be reset by rotating to the closed position.



Use only soft cups in the cupholder. Hard objects can injure you in a collision.

Memory seats/rearview mirrors/adjustable pedals (if equipped)

This system allows automatic positioning of the driver seat, outside rearview mirrors, and adjustable pedals to three programmable positions.

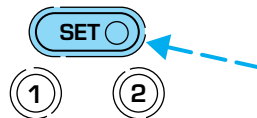

The memory seat control is located on the driver door.

- To program position one, move the driver seat to the desired position using the seat controls. Press the SET control. The SET control indicator light will briefly illuminate. While the light is illuminated, press control 1.

Seating and Safety Restraints

- To program position two, repeat the previous procedure using control 2.
- To program position three, repeat the previous procedure but press controls 1 and 2 simultaneously.

A position can only be recalled when the transmission gearshift is in Park. A memory seat position may be programmed at any time.

The memory seat positions are also recalled when you press your remote entry transmitter UNLOCK control.

To program the memory seat to remote entry transmitter, refer to *Remote entry system* in the *Locks and security chapter*.

SAFETY RESTRAINTS

Personal Safety System

The Personal Safety System provides an improved overall level of frontal crash protection to front seat occupants and is designed to help further reduce the risk of airbag-related injuries. The system is able to analyze different occupant conditions and crash severity before activating the appropriate safety devices to help better protect a range of occupants in a variety of frontal crash situations.

Your vehicle's Personal Safety System consists of the following items:

- Driver and passenger dual-stage airbag supplemental restraints
- Driver and front passenger side airbags
- Front safety belts with pretensioners, energy management retractors, and safety belt usage sensors
- Driver's seat position sensor
- Front passenger sensing system
- Front crash severity sensor
- Restraints Control Module (RCM) with impact and safing sensors
- Restraint system warning light and back-up tone
- The electrical wiring for the airbags, crash sensor(s), safety belt pretensioners, front safety belt usage sensors, driver seat position sensor, and indicator lights

Seating and Safety Restraints

How does the Personal Safety System work?

The Personal Safety System can adapt the deployment strategy of your vehicle's safety devices according to crash severity and occupant conditions. A collection of crash and occupant sensors provides information to the Restraints control module (RCM). During a crash, the RCM activates the safety belt pretensioners and/or either one or both stages of the dual-stage airbag supplemental restraints based on crash severity and occupant conditions.

The fact that the pretensioners or airbags did not activate for both front seat occupants in a collision does not mean that something is wrong with the system. Rather, it means the Personal Safety System determined the accident conditions (crash severity, belt usage, etc.) were not appropriate to activate these safety devices. Front airbags and pretensioners are designed to activate only in frontal and near-frontal collisions, not rollovers, side-impacts, or rear-impacts unless the collision causes sufficient longitudinal deceleration.

Driver and passenger dual-stage airbag supplemental restraints

The dual-stage airbags offer the capability to tailor the level of airbag inflation energy. A lower, less forceful energy level is provided for more common, moderate-severity impacts. A higher energy level is used for the most severe impacts. Refer to *Airbag supplemental restraints* section in this chapter.

Front crash severity sensor

The front crash severity sensor enhances the ability to detect the severity of an impact. Positioned up front, it provides valuable information early in the crash event on the severity of the impact. This allows your Personal Safety System to distinguish between different levels of crash severity and modify the deployment strategy of the dual-stage airbags and safety belt pretensioners.

Driver's seat position sensor

The driver's seat position sensor allows your Personal Safety System to tailor the deployment level of the driver dual-stage airbag based on seat position. The system is designed to help protect smaller drivers sitting close to the driver airbag by providing a lower airbag output level.

Seating and Safety Restraints

Front passenger sensing system

For airbags to do their job they must inflate with great force, and this force can pose a potentially deadly risk to occupants that are very close to the airbag when it begins to inflate. For some occupants, like infants in rear-facing child seats, this occurs because they are initially sitting very close to the airbag. For other occupants, this occurs when the occupant is not properly restrained by seat belts or child safety seats and they move forward during pre-crash braking. The most effective way to reduce the risk of unnecessary injuries is to make sure all occupants are properly restrained. Accident statistics suggest that children are much safer when properly restrained in the rear seating positions than in the front.



Air bags can kill or injure a child in a child seat. **NEVER** place a rear-facing child seat in front of an active air bag. If you must use a forward-facing child seat in the front seat, move the seat all the way back.



Always transport children 12 years old and under in the back seat and always properly use appropriate child restraints.

The front passenger sensing system can automatically turn off the front passenger front airbag when a rear facing child seat, a forward facing child seat, or a booster seat is detected. Even with this technology, parents are **STRONGLY** encouraged to always properly restrain children in the rear seat. The sensor also turns off the airbag when the passenger seat is empty to prevent unnecessary replacement of the airbag(s) after a collision.

When the front passenger seat is occupied and the sensing system has turned off the passenger's frontal airbag, the "pass airbag off" indicator will light and stay lit to remind you that the front passenger frontal airbag is off. See *Front passenger sensing system* in the airbags section of this chapter.

Front safety belt usage sensors

The front safety belt usage sensors detect whether or not the driver and front outboard passenger safety belts are fastened. This information allows your Personal Safety System to tailor the airbag deployment and safety belt pretensioner activation depending upon safety belt usage. Refer to *Safety belt* section in this chapter.

Seating and Safety Restraints

Front safety belt pretensioners

The safety belt pretensioners at the front outboard seating positions are designed to tighten the safety belts firmly against the occupant's body during a frontal or near-frontal collision. This maximizes the effectiveness of the safety belts and helps properly position the occupant relative to the airbag to improve protection. The safety belt pretensioners can be either activated alone or, if the collision is of sufficient severity, together with the airbags.

Front safety belt energy management retractors

The front outboard safety belt energy management retractors allow webbing to be pulled out of the retractor in a gradual and controlled manner in response to the occupant's forward momentum. This helps reduce the risk of force-related injuries to the occupant's chest by limiting the load on the occupant. Refer to *Energy management feature* section in this chapter.

Determining if the Personal Safety System is operational

The Personal Safety System uses a warning light in the instrument cluster or a back-up tone to indicate the condition of the system. Refer to the *Warning light* section in the *Instrument cluster* chapter. Routine maintenance of the Personal Safety System is not required.

The Restraints control module (RCM) monitors its own internal circuits and the circuits for the airbag supplemental restraints, crash sensor(s), safety belt pretensioners, front safety belt buckle sensors, and the driver seat position sensor. In addition, the RCM also monitors the restraints warning light in the instrument cluster. A difficulty with the system is indicated by one or more of the following.

- The warning light will either flash or stay lit.
- The warning light will not illuminate immediately after ignition is turned on.
- A series of five beeps will be heard. The tone pattern will repeat periodically until the problem and warning light are repaired.

If any of these things happen, even intermittently, have the Personal Safety System serviced at your dealership or by a qualified technician immediately. Unless serviced, the system may not function properly in the event of a collision.

Safety restraints precautions



Always drive and ride with your seatback upright and the lap belt snug and low across the hips.

Seating and Safety Restraints



To reduce the risk of injury, make sure children sit in the back seat where they can be properly restrained.



Never let a passenger hold a child on his or her lap while the vehicle is moving. The passenger cannot protect the child from injury in a collision.



All occupants of the vehicle, including the driver, should always properly wear their safety belts, even when an airbag supplemental restraint system (SRS) is provided.



It is extremely dangerous to ride in a cargo area, inside or outside of a vehicle. In a collision, people riding in these areas are more likely to be seriously injured or killed. Do not allow people to ride in any area of your vehicle that is not equipped with seats and safety belts. Be sure everyone in your vehicle is in a seat and using a safety belt properly.



In a rollover crash, an unbelted person is significantly more likely to die than a person wearing a safety belt.



Each seating position in your vehicle has a specific safety belt assembly which is made up of one buckle and one tongue that are designed to be used as a pair. 1) Use the shoulder belt on the outside shoulder only. Never wear the shoulder belt under the arm. 2) Never swing the safety belt around your neck over the inside shoulder. 3) Never use a single belt for more than one person.



Always transport children 12 years old and under in the back seat and always properly use appropriate child restraints.



Safety belts and seats can become hot in a vehicle that has been closed up in sunny weather; they could burn a small child. Check seat covers and buckles before you place a child anywhere near them.

Seating and Safety Restraints

Combination lap and shoulder belts

1. Insert the belt tongue into the proper buckle (the buckle closest to the direction the tongue is coming from) until you hear a snap and feel it latch. Make sure the tongue is securely fastened in the buckle.

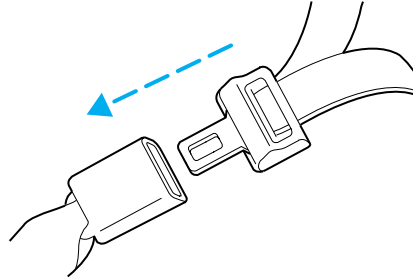

2. To unfasten, push the release button and remove the tongue from the buckle.

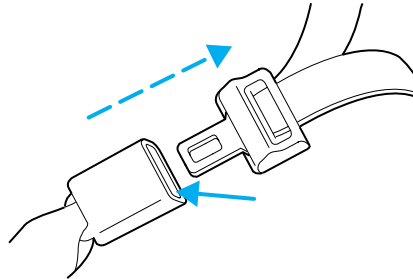

Energy management feature

- This vehicle has a seat belt system with an energy management feature at the front outboard seating positions to help further reduce the risk of injury in the event of a head-on collision.
- This seat belt system has a retractor assembly that is designed to pay out webbing in a controlled manner. This feature is designed to help reduce the belt force acting on the occupant's chest.

The front outboard and rear safety restraints in the vehicle are combination lap and shoulder belts. The front outboard passenger and rear seat safety belts have three types of locking modes described below:

Vehicle sensitive mode

This is the normal retractor mode, which allows free shoulder belt length adjustment to your movements and locking in response to vehicle movement. For example, if the driver brakes suddenly or turns a corner sharply, or the vehicle receives an impact of approximately 5 mph (8 km/h) or more, the combination safety belts will lock to help reduce forward movement of the driver and passengers.

Seating and Safety Restraints

Webbing extraction sensitive mode

The webbing sensitive locking mode locks the webbing and prevents more belt from being pulled out if the belt is pulled out too quickly. The belt will unlock when you stop pulling on it.

Automatic locking mode

In this mode, the shoulder belt is automatically pre-locked. The belt will still retract to remove any slack in the shoulder belt. The automatic locking mode is not available on the driver safety belt.

This mode should be used **any time** a child safety seat is installed in the vehicle. Children 12 years old and under should be properly restrained in the rear seat whenever possible. Refer to *Safety restraints for children* or *Safety seats for children* later in this chapter.

How to use the automatic locking mode

- Buckle the combination lap and shoulder belt.

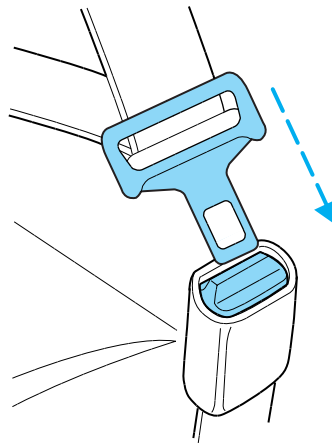

Seating and Safety Restraints

- Grasp the shoulder portion and pull downward until the entire belt is pulled out.



- Allow the belt to retract. As the belt retracts, you will hear a clicking sound. This indicates the safety belt is now in the automatic locking mode.

How to disengage the automatic locking mode



Ford Motor Company recommends that all passenger safety belt assemblies and attaching hardware should be inspected by a qualified technician after any collision to verify that the "automatic locking retractor" feature for child seats is still working properly. Safety belt assemblies should be inspected according to the procedures in the Workshop Manual and must be replaced if either damage or improper operation is noted. Failure to replace the belt and retractor assembly could increase the risk of injury in a collision.

Unbuckle the combination lap/shoulder belt and allow it to retract completely to disengage the automatic locking mode and activate the vehicle sensitive (emergency) locking mode.

Seating and Safety Restraints

Front safety belt height adjustment

Your vehicle has safety belt height adjustments for the driver and front outboard passenger. Adjust the height of the shoulder belt so the belt rests across the middle of your shoulder.

To lower the shoulder belt height, push the button and slide the height adjuster down. To raise the height of the shoulder belt, push the button and slide the height adjuster up. Pull down on the height adjuster to make sure it is locked in place.

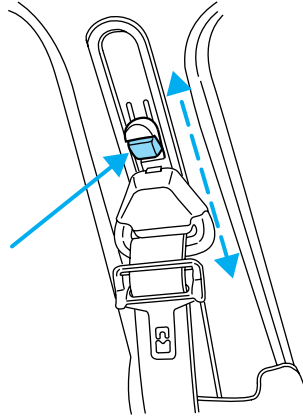

 Position the safety belt height adjusters so that the belt rests across the middle of your shoulder. Failure to adjust the safety belt properly could reduce the effectiveness of the seat belt and increase the risk of injury in a collision.

Lap belts

Adjusting the front center seat lap belt

 The lap belt should fit snugly and as low as possible around the hips, not across the waist.

Seating and Safety Restraints

The lap belt does not adjust automatically. Insert the tongue into the correct buckle (the buckle closest to the direction the tongue is coming from). To lengthen the belt, turn the tongue at a right angle to the belt and pull across your lap until it reaches the buckle. To tighten the belt, pull the loose end of the belt through the tongue until it fits snugly across the hips.

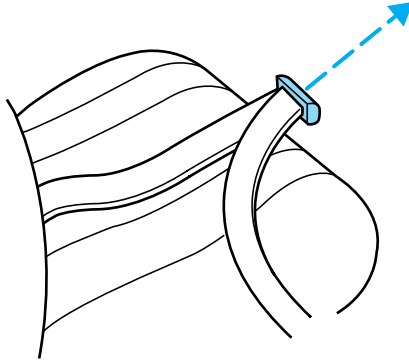

Shorten and fasten the belt when not in use.

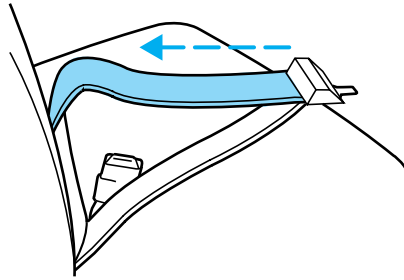

Safety belt warning light and indicator chime

The safety belt warning light illuminates in the instrument cluster and a chime sounds to remind the occupants to fasten their safety belts.

Seating and Safety Restraints

Conditions of operation

If...	Then...
The driver's safety belt is not buckled before the ignition switch is turned to the ON position...	The safety belt warning light illuminates 1-2 minutes and the warning chime sounds 4-8 seconds.
The driver's safety belt is buckled while the indicator light is illuminated and the warning chime is sounding...	The safety belt warning light and warning chime turn off.
The driver's safety belt is buckled before the ignition switch is turned to the ON position...	The safety belt warning light and indicator chime remain off.

BeltMinder™

The BeltMinder™ feature is a supplemental warning to the safety belt warning function. This feature provides additional reminders by intermittently sounding a chime and illuminating the safety belt warning lamp in the instrument cluster when the driver's and front passenger's safety belt is unbuckled.

The BeltMinder™ feature uses information from the passenger occupant classification sensor to determine if a front seat passenger is present and therefore potentially in need of a warning. To avoid activating the BeltMinder™ feature for objects placed in the front passenger seat, warnings will only be given to large front seat occupants as determined by the passenger occupant classification sensor.

Both the driver's and passenger's safety belt usages are monitored and either may activate the BeltMinder™ feature. The warnings are the same for the driver and the front passenger. If the BeltMinder™ warnings have expired (warnings for approximately 5 minutes) for one occupant (driver or front passenger), the other occupant can still activate the BeltMinder™ feature.

Seating and Safety Restraints

If...	Then...
The driver's and front passenger's safety belts are buckled before the ignition switch is turned to the ON position or less than 1-2 minutes have elapsed since the ignition switch has been turned ON...	The BeltMinder [™] feature will not activate.
The driver's or front passenger's safety belt is not buckled when the vehicle has reached at least 3 mph (5 km/h) and 1-2 minutes have elapsed since the ignition switch has been turned to ON...	The BeltMinder [™] feature is activated - the safety belt warning light illuminates and the warning chime sounds for 6 seconds every 30 seconds, repeating for approximately 5 minutes or until the safety belts are buckled.
The driver's or front passenger's safety belt becomes unbuckled for approximately 1 minute while the vehicle is traveling at least 3 mph (5 km/h) and more than 1-2 minutes have elapsed since the ignition switch has been turned to ON...	The BeltMinder [™] feature is activated - the safety belt warning light illuminates and the warning chime sounds for 6 seconds every 30 seconds, repeating for approximately 5 minutes or until the safety belts are buckled.

Seating and Safety Restraints

The following are reasons most often given for not wearing safety belts
(All statistics based on U.S. data):

Reasons given...	Consider...
"Crashes are rare events"	36700 crashes occur every day. The more we drive, the more we are exposed to "rare" events, even for good drivers. <i>1 in 4 of us will be seriously injured in a crash during our lifetime.</i>
"I'm not going far"	3 of 4 fatal crashes occur within 25 miles (40 km) of home.
"Belts are uncomfortable"	We design our safety belts to enhance comfort. If you are uncomfortable - try different positions for the safety belt upper anchorage and seatback which should be as upright as possible; this can improve comfort.
"I was in a hurry"	Prime time for an accident. BeltMinder [™] reminds us to take a few seconds to buckle up.
"Safety belts don't work"	Safety belts , when used properly, reduce risk of death to front seat occupants by 45% in cars , and by 60% in light trucks .
"Traffic is light"	Nearly 1 of 2 deaths occur in single-vehicle crashes , many when no other vehicles are around.
"Belts wrinkle my clothes"	Possibly, but a serious crash can do much more than wrinkle your clothes, particularly if you are unbelted.
"The people I'm with don't wear belts"	Set the example, teen deaths occur 4 times more often in vehicles with TWO or MORE people. Children and younger brothers/sisters imitate behavior they see.

Seating and Safety Restraints

Reasons given...	Consider...
"I have an airbag"	Airbags offer greater protection when used with safety belts. Frontal airbags are not designed to inflate in rear and side crashes or rollovers.
"I'd rather be thrown clear"	Not a good idea. People who are ejected are 40 times more likely to DIE. Safety belts help prevent ejection, WE CAN'T "PICK OUR CRASH".



Do not sit on top of a buckled safety belt to avoid the BeltMinder™ chime. Sitting on the safety belt will increase the risk of injury in an accident. To disable (one-time) or deactivate the BeltMinder™ feature please follow the directions stated below.

One time disable

If at any time the driver/front passenger quickly buckles then unbuckles the BeltMinder™ feature for that seating position, the BeltMinder™ is disabled for the current ignition cycle. The BeltMinder™ feature will re-enable during the same ignition cycle if the occupant buckles and remains buckled for approximately 30 seconds. Confirmation is not given for the one time disable.

Deactivating/activating the BeltMinder™ feature

The driver and front passenger BeltMinder™ are deactivated/activated independently. When deactivating/activating one seating position, do not buckle the other position as this will terminate the process.

Read Steps 1 - 4 thoroughly before proceeding with the deactivation/activation programming procedure.

Note: The driver and front passenger BeltMinder™ features must be disabled/enabled separately. Both cannot be disabled/enabled during the same key cycle.

The driver and front passenger BeltMinder™ features can be deactivated/activated by performing the following procedure:

Before following the procedure, make sure that:

- The parking brake is set

Seating and Safety Restraints

- The gearshift is in P (Park) (automatic transmission)
- The ignition switch is in the OFF position
- The driver and front passenger safety belts are unbuckled



To reduce the risk of injury, do not deactivate/activate the BeltMinder™ feature while driving the vehicle.

1. Turn the ignition switch to the RUN (or ON) position. (DO NOT START THE ENGINE)
2. Wait until the safety belt warning light turns off. (Approximately 1 minute)
 - Step 3 must be completed within 50 seconds after the safety belt warning light turns off.
3. For the seating position being disabled, at a moderate speed, buckle then unbuckle the safety belt 9 times, ending in the unbuckled state. (Step 3 must be completed within 50 seconds after the safety belt warning light turns off.)
 - After Step 3, the restraint system warning light (airbag light) will be turned on for three seconds.
4. Within 10 seconds of the light turning on, at a moderate speed, buckle then unbuckle the safety belt.
 - This will disable the BeltMinder™ feature for that seating position if it is currently enabled. As confirmation, the restraint system warning light will flash 4 times per second for 3 seconds.
 - This will enable the BeltMinder™ feature for that seating position if it is currently disabled. As confirmation, the restraint system warning light will flash 4 times per second for 3 seconds, followed by 3 seconds with the light off, then followed by the restraint system warning light flashing 4 times per second for 3 seconds again.

Safety belt extension assembly

If the safety belt is too short when fully extended, there is a 8 inch (20 cm) safety belt extension assembly that can be added (part number 611C22). This assembly can be obtained from your dealer at no cost.

Use only extensions manufactured by the same supplier as the safety belt. Manufacturer identification is located at the end of the webbing on the label. Also, use the safety belt extension only if the safety belt is too short for you when fully extended.

Seating and Safety Restraints



Do not use extensions to change the fit of the shoulder belt across the torso.

Safety belt maintenance

Inspect the safety belt systems periodically to make sure they work properly and are not damaged. Inspect the safety belts to make sure there are no nicks, tears or cuts. Replace if necessary. All safety belt assemblies, including retractors, buckles, front safety belt buckle assemblies, buckle support assemblies (slide bar-if equipped), shoulder belt height adjusters (if equipped), shoulder belt guide on seatback (if equipped), child safety seat LATCH and tether anchors, and attaching hardware, should be inspected after a collision. Ford Motor Company recommends that all safety belt assemblies in use in vehicles involved in a collision be replaced. However, if the collision was minor and a qualified technician finds that the belts do not show damage and continue to operate properly, they do not need to be replaced. Safety belt assemblies not in use during a collision should also be inspected and replaced if either damage or improper operation is noted.



Failure to inspect and if necessary replace the safety belt assembly under the above conditions could result in severe personal injuries in the event of a collision.

For proper care of soiled safety belts, refer to *Interior* in the *Cleaning* chapter.

AIRBAG SUPPLEMENTAL RESTRAINT SYSTEM (SRS)

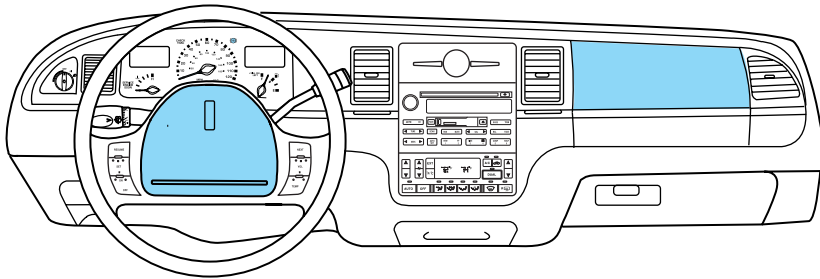



Seating and Safety Restraints

Important SRS precautions

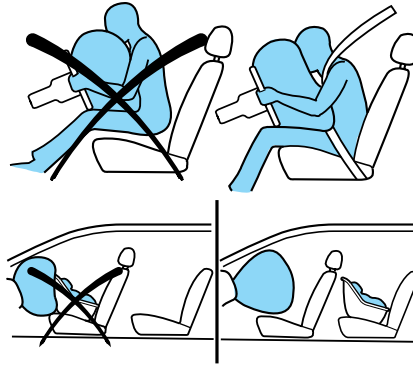
The SRS is designed to work with the safety belt to help protect the driver and right front passenger from certain upper body injuries. Airbags DO NOT inflate slowly; there is a risk of injury from a deploying airbag.



 All occupants of the vehicle, including the driver, should always properly wear their safety belts, even when an air bag supplemental restraint system (SRS) is provided.

 Always transport children 12 years old and under in the back seat and always properly use appropriate child restraints.

 The National Highway Traffic Safety Administration (NHTSA) recommends a minimum distance of at least 10 inches (25 cm) between an occupant's chest and the driver airbag module.

 Never place your arm over the air bag module as a deploying air bag can result in serious arm fractures or other injuries.

 Ford Motor Company recommends that a certified technician inspect all steering column assemblies in use in vehicles involved in a collision. Failure to inspect and if necessary replace the steering column assembly could result in severe injury or death in the event of a collision.

Seating and Safety Restraints



Do not attempt to service, repair, or modify the steering column, its adaptive module, or its fuses. See your Ford or Lincoln/Mercury dealer.

To properly position yourself away from the airbag:

- Move your seat to the rear as far as you can while still reaching the pedals comfortably.
- Recline the seat slightly one or two degrees from the upright position.



Do not put anything on or over the air bag module. Placing objects on or over the air bag inflation area may cause those objects to be propelled by the air bag into your face and torso causing serious injury.



Do not attempt to service, repair, or modify the airbag supplemental restraint systems or its fuses. See your Ford or Lincoln/Mercury dealer.



The front passenger airbag is not designed to offer protection to an occupant in the center front seating position.



Modifying or adding equipment to the front end of the vehicle (including frame, bumper, front end body structure and tow hooks) may affect the performance of the airbag system, increasing the risk of injury. Do not modify the front end of the vehicle.

Seating and Safety Restraints

Children and airbags

Children must always be properly restrained. Accident statistics suggest that children are safer when properly restrained in the rear seating positions than in the front seating position. Failure to follow these instructions may increase the risk of injury in a collision.

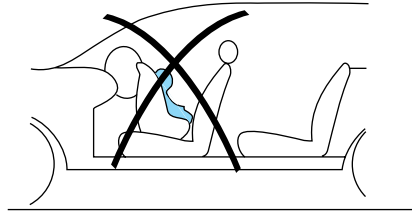

Airbags can kill or injure a child in a child seat.

NEVER place a rear-facing child seat in front of an active airbag. If you must use a forward-facing child seat in the front seat, move the seat all the way back.

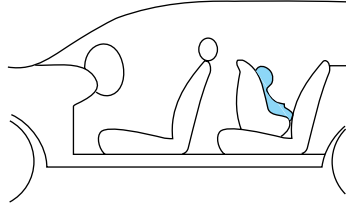

How does the air bag supplemental restraint system work?

The air bag SRS is designed to activate when the vehicle sustains longitudinal deceleration sufficient to cause the sensors to close an electrical circuit that initiates air bag inflation.

The fact that the air bags did not inflate in a collision does not mean that something is wrong with the system. Rather, it means the forces were not of the type sufficient to cause activation. Driver and passenger airbags are designed to inflate in frontal and near-frontal collisions, not rollover, side-impact, or rear-impacts unless the collision causes sufficient longitudinal deceleration.

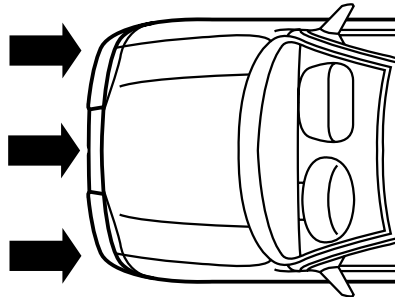

Seating and Safety Restraints

The air bags inflate and deflate rapidly upon activation. After air bag deployment, it is normal to notice a smoke-like, powdery residue or smell the burnt propellant. This may consist of cornstarch, talcum powder (to lubricate the bag) or sodium compounds (e.g., baking soda) that result from the combustion process that inflates the air bag. Small amounts of sodium hydroxide may be present which may irritate the skin and eyes, but none of the residue is toxic.



While the system is designed to help reduce serious injuries, contact with a deploying air bag may also cause abrasions, swelling or temporary hearing loss. Because air bags must inflate rapidly and with considerable force, there is the risk of death or serious injuries such as fractures, facial and eye injuries or internal injuries, particularly to occupants who are not properly restrained or are otherwise out of position at the time of air bag deployment. Thus, it is extremely important that occupants be properly restrained as far away from the air bag module as possible while maintaining vehicle control.

The SRS consists of the following items:

- Driver and passenger air bag modules (which include the inflators and air bags)
- Front passenger sensing system
- Driver and passenger side air bags (if equipped)
- One or more impact and safing sensors
- A readiness light and tone
- A diagnostic module
- The electrical wiring which connects the components

The diagnostic module monitors its own internal circuits as well as the supplemental air bag electrical system wiring (including the impact sensors), the system wiring, the air bag system readiness light, the air bag back up power and the air bag ignitors.

Seating and Safety Restraints



Several air bag system components get hot after inflation. Do not touch them after inflation.



If the air bag has deployed, **the air bag will not function again and must be replaced immediately.** If the air bag is not replaced, the unrepaired area will increase the risk of injury in a collision.



If the safety belt pretensioners deploy in an accident, they will not function again (belt will not extract or retract) and must be replaced immediately. Failure to replace the retractor assemblies will increase the risk of injury.

Front passenger sensing system

The front passenger sensing system will turn off the front passenger's frontal air bag under certain conditions. The driver's airbag is not part of the front passenger sensing system. The front passenger sensing system works with sensors that are part of the front passenger's seat and safety belt. The sensors are designed to detect the presence of a properly-seated occupant and determine if the front passenger's frontal airbag should be enabled (may inflate) or not.

The front passenger sensing system is designed to meet the regulatory requirements of Federal Motor Vehicle Safety Standard (FMVSS) 208 and is designed to turn off the front passenger's frontal airbag if:

- the front passenger seat is unoccupied, or has small/medium objects in the front seat,
- the system determines that an infant is present in a rear-facing infant seat that is installed according to the manufacturer's instructions,
- the system determines that a small child is present in a forward-facing child restraint that is installed according to the manufacturer's instructions,
- the system determines that a small child is present in a booster seat,
- a front passenger takes his/her weight off of the seat for a period of time,
- A smaller person, such as a child who has outgrown child restraints, or a small adult occupies the front passenger seat.

Seating and Safety Restraints



Even with the front passenger sensing system, children 12 and under should be properly restrained in the back seat.

When the front passenger seat is occupied and the sensing system has turned off the passenger's frontal airbag, the "passenger airbag off" or "pass airbag off" indicator will light and stay lit to remind you that



the front passenger frontal airbag is off. When the front passenger seat is not occupied (empty seat) or in the event that the front passenger frontal airbag is enabled (may inflate), the indicator light will be unlit.

The indicator light is located on the instrument panel to the right of the radio over the glove box.

The front passenger sensing system is designed to turn off the front passenger's frontal airbag when a rear facing infant seat, a forward-facing child restraint, or a booster seat is detected. If the child restraint has been installed and the indicator is not lit, then turn the vehicle off, remove the child restraint from the vehicle and reinstall the restraint following the child restraint manufacturer's directions.

The front passenger sensing system is designed to enable (may inflate) the right front passenger's frontal airbag anytime the system senses that a person of adult size is sitting properly in the front passenger seat. When the passenger sensing system has allowed the airbags to be enabled, the indicator will be unlit and stay unlit to remind you that the air bag is enabled (may inflate).

If a person of adult-size is sitting in the front passenger's seat, but the "passenger air bag off" or "pass air bag off" indicator is lit, it could be that the person isn't sitting properly in the seat. If this happens, turn the vehicle off and ask the person to place the seatback in the full upright position, then sit upright in the seat, centered on the seat cushion, with the person's legs comfortably extended. Restart the vehicle and have the person remain in this position for about two minutes. This will allow the system to detect that person and then enable the passenger's air bag. If the indicator lamp remains lit even after this, then the occupant should be advised to ride in the back seat.

After all occupants have adjusted their seats and put on safety belts, it's very important that they continue to sit upright, with their back against the seatback, with their feet comfortably extended on the floor while the vehicle is still in motion. Sitting improperly can increase the chance of

Seating and Safety Restraints

injury in a crash event. For example, if an occupant slouches, lies down, turns sideways, sits forward, leans forward or sideways, or puts one or both feet up, the chance of injury during a crash is greatly increased.



Sitting improperly out of position or with the seat back reclined too far can take off weight from the seat cushion and affect the decision of the passenger sensing system, resulting in serious injury or death in a crash. Always sit upright against your seatback, with your feet on the floor.

The front passenger sensing system may detect small or medium objects placed on the seat cushion. For most objects that are in the front passenger seat, the passenger airbag will be disabled. Even though the passenger airbag is disabled, the "pass airbag off" light may or may not be illuminated according to the table below.

Objects	Pass Airbag Off Indicator Light	Passenger Frontal Airbag
Empty seat	Unlit	Disabled
Small (i.e. 3 ring binder, small purse, bottled water)	Unlit	Disabled
Medium (i.e. heavy briefcase, fully packed luggage)	Lit	Disabled
Empty seat, Small or medium object with safety belt buckled	Lit	Disabled

In case there is a problem with the passenger sensing system, the airbag readiness light in the instrument cluster will stay lit. DO NOT attempt to repair or service the system; take your vehicle immediately to the dealer.

**AIR
BAG**

If it is necessary to modify an advanced front air bag system to accommodate a person with disabilities, contact the Ford Customer Relationship Center at the phone number shown in the Customer Assistance section of this Owner's Guide.

Seating and Safety Restraints



Any alteration/modification to the front passenger seat may affect the performance of the front passenger sensing system.

Determining if the system is operational

The SRS uses a readiness light in the instrument cluster or a tone to indicate the condition of the system. Refer to *Air bag readiness* section in the *Instrument Cluster* chapter. Routine maintenance of the air bag is not required.

A difficulty with the system is indicated by one or more of the following:

- The readiness light will either flash or stay lit.
- The readiness light will not illuminate immediately after ignition is turned on.
- A series of five beeps will be heard. The tone pattern will repeat periodically until the problem and/or light are repaired.

**AIR
BAG**

If any of these things happen, even intermittently, have the SRS serviced at your dealership or by a qualified technician immediately. Unless serviced, the system may not function properly in the event of a collision.

Side air bag system (if equipped)



Do not place objects or mount equipment on or near the air bag cover on the side of the seatbacks of the front seats or in front seat areas that may come into contact with a deploying air bag. Failure to follow these instructions may increase the risk of personal injury in the event of a collision.





Do not use accessory seat covers. The use of accessory seat covers may prevent the deployment of the side air bags and increase the risk of injury in an accident.



Do not lean your head on the door. The side air bag could injure you as it deploys from the side of the seatback.

Seating and Safety Restraints

 Do not attempt to service, repair, or modify the air bag SRS, its fuses or the seat cover on a seat containing an air bag. See your Ford or Lincoln/Mercury dealer.

 All occupants of the vehicle should always wear their safety belts even when an air bag SRS is provided.

How does the side air bag system work?

The design and development of the side airbag system included recommended testing procedures that were developed by a group of automotive safety experts known as the Side Airbag Technical Working Group. These recommended testing procedures help reduce the risk of injuries related to the deployment of side airbags.

The side air bag system consists of the following:

- An inflatable nylon bag (air bag) with a gas generator concealed behind the outboard bolster of the driver and front passenger seatbacks.
- A special seat cover designed to allow airbag deployment.
- The same warning light, electronic control and diagnostic unit as used for the front air bags.
- Two crash sensors located near the side of the vehicle.

Side air bags, in combination with seat belts, can help reduce the risk of severe injuries in the event of a significant side impact collision.

The side air bags are fitted on the outboard side of the seatbacks of the front seats. In certain lateral collisions, the air bag on the side affected by the collision will be inflated. The air bag was designed to inflate between the door panel and occupant to further enhance the protection provided occupants in side impact collisions.

The air bag SRS is designed to activate when the vehicle sustains lateral deceleration sufficient to cause the sensors to close an electrical circuit that initiates air bag inflation.

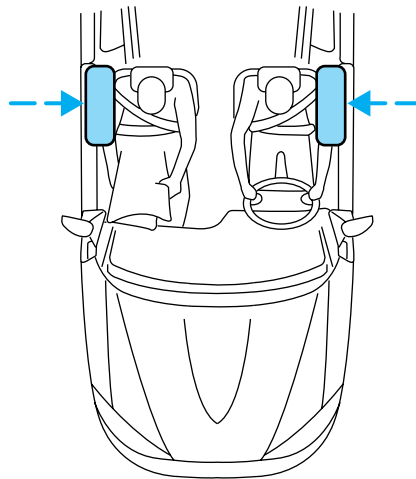

Seating and Safety Restraints

The fact that the air bags did not inflate in a collision does not mean that something is wrong with the system. Rather, it means the forces were not of the type sufficient to cause activation. Side air bags are designed to inflate in side-impact collisions, not roll-over, rear-impact, frontal or near-frontal collisions, unless the collision causes sufficient lateral deceleration.



Several air bag system components get hot after inflation. Do not touch them after inflation.



If the side air bag has deployed, **the air bag will not function again. The side air bag system (including the seat) must be inspected and serviced by a qualified technician in accordance with the vehicle service manual.** If the air bag is not replaced, the unrepaired area will increase the risk of injury in a collision.

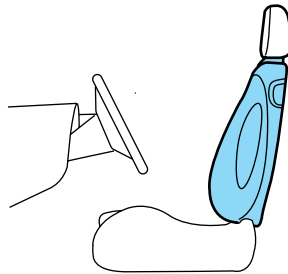

Determining if the system is operational

The SRS uses a readiness light in the instrument cluster or a tone to indicate the condition of the system. Refer to the *Air bag readiness* section in the *Instrument Cluster* chapter. Routine maintenance of the side air bag is not required.

A difficulty with the system is indicated by one or more of the following:

- The readiness light (same light as for front air bag system) will either flash or stay lit.
- The readiness light will not illuminate immediately after ignition is turned on.
- A series of five beeps will be heard. The tone pattern will repeat periodically until the problem and/or light are repaired.

If any of these things happen, even intermittently, have the SRS serviced at your dealership or by a qualified technician immediately. Unless serviced, the system may not function properly in the event of a collision.

Seating and Safety Restraints

Disposal of air bags and air bag equipped vehicles (including pretensioners)

See your local dealership or qualified technician. Air bags MUST BE disposed of by qualified personnel.

SAFETY RESTRAINTS FOR CHILDREN

See the following sections for directions on how to properly use safety restraints for children. Also see *Air bag supplemental restraint system (SRS)* in this chapter for special instructions about using air bags.

Important child restraint precautions

You are required by law to use safety restraints for children in the U.S. and Canada. If small children (generally children who are four years old or younger and who weigh 40 lb. [18 kg] or less) ride in your vehicle, you must put them in safety seats made especially for children. Many states require that children use approved booster seats until they are eight years old. Check your local and state or provincial laws for specific requirements regarding the safety of children in your vehicle. When possible, always place children under age 12 in the rear seat of your vehicle. Accident statistics suggest that children are safer when properly restrained in the rear seating positions than in the front seating position.



Never let a passenger hold a child on his or her lap while the vehicle is moving. The passenger cannot protect the child from injury in a collision.

Always follow the instructions and warnings that come with any infant or child restraint you might use.

Children and safety belts

If the child is the proper size, restrain the child in a safety seat.

Children who are too large for child safety seats (as specified by your child safety seat manufacturer) should always wear safety belts.

Follow all the important safety restraint and air bag precautions that apply to adult passengers in your vehicle.

If the shoulder belt portion of a combination lap and shoulder belt can be positioned so it does not cross or rest in front of the child's face or neck, the child should wear the lap and shoulder belt. Moving the child closer to the center of the vehicle may help provide a good shoulder belt fit.

Seating and Safety Restraints



Do not leave children, unreliable adults, or pets unattended in your vehicle.

Child booster seats

Children outgrow a typical convertible or toddler seat when they weigh 40 lb. (18 kg) and are around 4 years of age. Although the lap/shoulder belt will provide some protection, these children are still too small for lap/shoulder belts to fit properly, which could increase the risk of serious injury.

To improve the fit of both the lap and shoulder belt on children who have outgrown child safety seats, Ford Motor Company recommends use of a belt-positioning booster.

Booster seats position a child so that safety belts fit better. They lift the child up so that the lap belt rests low across the hips and the knees bend comfortably. Booster seats also make the shoulder belt fit better and more comfortably for growing children.

When children should use booster seats

Children need to use booster seats from the time they outgrow the toddler seat until they are big enough for the vehicle seat and lap/shoulder belt to fit properly. Generally this is when they weigh about 80 lb. (36 kg) (about 8 to 12 years old).

Booster seats should be used until you can answer YES to ALL of these questions:

- Can the child sit all the way back against the vehicle seat back with knees bent comfortably at the edge of the seat without slouching?

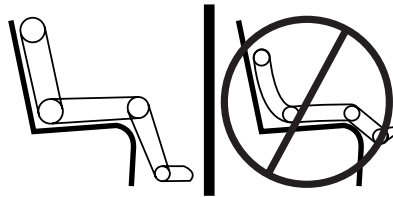

- Does the lap belt rest low across the hips?
- Is the shoulder belt centered on the shoulder and chest?
- Can the child stay seated like this for the whole trip?

Seating and Safety Restraints

Types of booster seats

There are two types of belt-positioning booster seats:

- Those that are backless.

If your backless booster seat has a removable shield, remove the shield and use the lap/shoulder belt. If a seating position has a low seat back and no head restraint, a backless booster seat may place your child's head (top of ear level) above the top of the seat. In this case, move the backless booster to another seating position with a higher seat back and lap/shoulder belts.



- Those with a high back.

If, with a backless booster seat, you cannot find a seating position that adequately supports your child's head, a high back booster seat would be a better choice.



Both can be used in any vehicle in a seating position equipped with lap/shoulder belts if your child is over 40 lb. (18 kg).

The shoulder belt should cross the chest, resting snugly on the center of the shoulder. The lap belt should rest low and snug across the hips, never up high across the stomach.

If the booster seat slides on the vehicle seat, placing a rubberized mesh sold as shelf or carpet liner under the booster seat may improve this condition.

The importance of shoulder belts

Using a booster without a shoulder belt increases the risk of a child's head hitting a hard surface in a collision. For this reason, you should never use a booster seat with a lap belt only. It is best to use a booster seat with lap/shoulder belts in the back seat- the safest place for children to ride.

Seating and Safety Restraints



Follow all instructions provided by the manufacturer of the booster seat.



Never put the shoulder belt under a child's arm or behind the back because it eliminates the protection for the upper part of the body and may increase the risk of injury or death in a collision.



Never use pillows, books, or towels to boost a child. They can slide around and increase the likelihood of injury or death in a collision.

SAFETY SEATS FOR CHILDREN

Child and infant or child safety seats

Use a safety seat that is recommended for the size and weight of the child. Carefully follow all of the manufacturer's instructions with the safety seat you put in your vehicle. If you do not install and use the safety seat properly, the child may be injured in a sudden stop or collision.

When installing a child safety seat:

- Review and follow the information presented in the *Air Bag Supplemental Restraint System* section in this chapter.
- Use the correct safety belt buckle for that seating position.
- Insert the belt tongue into the proper buckle until you hear a snap and feel it latch. Make sure the tongue is securely fastened in the buckle.
- Keep the buckle release button pointing up and away from the safety seat, with the tongue between the child seat and the release button, to prevent accidental unbuckling.
- Place seat back in upright position.
- Put the safety belt in the automatic locking mode. Refer to *Automatic locking mode*.

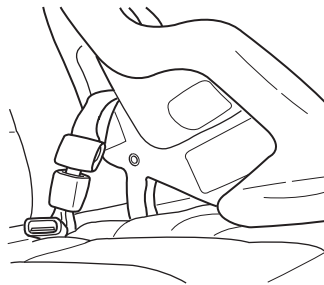

Seating and Safety Restraints

- LATCH lower anchors are recommended for use by children up to 48 pounds (22 kg) in a child restraint. Top tether anchors can be used for children up to 60 pounds (27 kg) in a child restraint, and to provide upper torso restraint for children up to 80 pounds (36 kg) using an upper torso harness and a belt-positioning booster.

Ford recommends the use of a child safety seat having a top tether strap. Install the child safety seat in a seating position with LATCH and tether anchors. For more information on top tether straps and anchors, refer to *Attaching safety seats with tether straps* in this chapter. For more information of LATCH anchors refer to *Attaching safety seats with LATCH (Lower Anchors and Tethers for Children) attachments* in this chapter.



Carefully follow all of the manufacturer's instructions included with the safety seat you put in your vehicle. If you do not install and use the safety seat properly, the child may be injured in a sudden stop or collision.



Rear-facing child seats or infant carriers should never be placed in the front seats.

Installing child safety seats with combination lap and shoulder belts



Air bags can kill or injure a child in a child seat. **NEVER** place a rear-facing child seat in front of an active air bag. If you must use a forward-facing child seat in the front seat, move the seat all the way back.



Children 12 and under should be properly restrained in the rear seat whenever possible.

Seating and Safety Restraints

1. Position the child safety seat in a seat with a combination lap and shoulder belt.

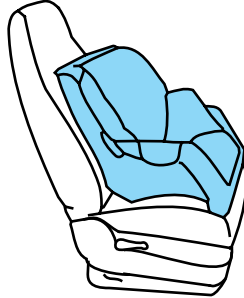

2. Pull down on the shoulder belt and then grasp the shoulder belt and lap belt together.

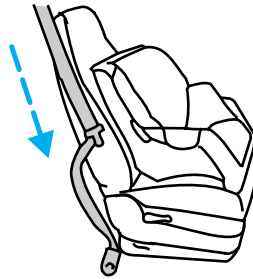

3. While holding the shoulder and lap belt portions together, route the tongue through the child seat according to the child seat manufacturer's instructions. Be sure the belt webbing is not twisted.

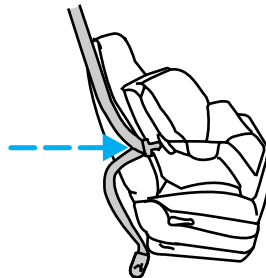

Seating and Safety Restraints

4. Insert the belt tongue into the proper buckle (the buckle closest to the direction the tongue is coming from) for that seating position until you hear a snap and feel the latch engage. Make sure the tongue is latched securely by pulling on it.

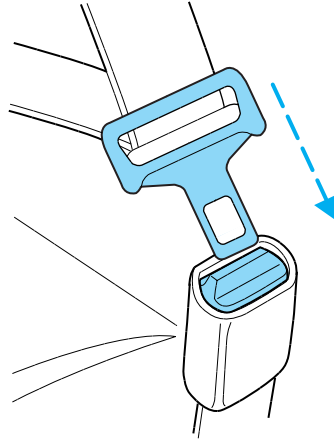

5. To put the retractor in the automatic locking mode, grasp the shoulder portion of the belt and pull downward until all of the belt is pulled out and a click is heard.

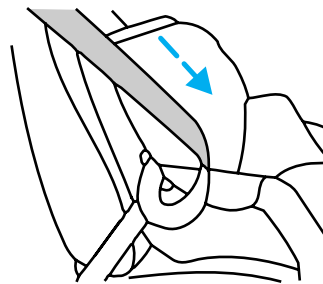

6. Allow the belt to retract. The belt will click as it retracts to indicate it is in the automatic locking mode.

7. Pull the lap belt portion across the child seat toward the buckle and pull up on the shoulder belt while pushing down with your knee on the child seat.

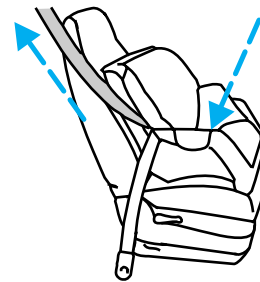

Seating and Safety Restraints

8. Allow the safety belt to retract to remove any slack in the belt.

9. Before placing the child in the seat, forcibly move the seat forward and back to make sure the seat is securely held in place. To check this, grab the seat at the belt path and attempt to move it side to side and forward. There should be no more than one inch of movement for proper installation.

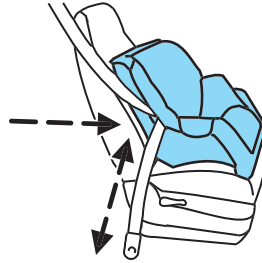

10. Try to pull the belt out of the retractor to make sure the retractor is in the automatic locking mode (you should not be able to pull more belt out). If the retractor is not locked, unbuckle the belt and repeat Steps 2 through 9.

Check to make sure the child seat is properly secured before each use.

Attaching child safety seats with tether straps

Most new forward-facing child safety seats include a tether strap which goes over the back of the seat and hooks to an anchoring point. Tether straps are available as an accessory for many older safety seats. Contact the manufacturer of your child seat for information about ordering a tether strap.

The rear seats of your vehicle are equipped with built-in tether strap anchors located behind the seats as described below.

The tether anchors in your vehicle are located under a cover marked with the tether anchor symbol (shown with title).

The tether strap anchors in your vehicle are in the following positions (shown from top view):

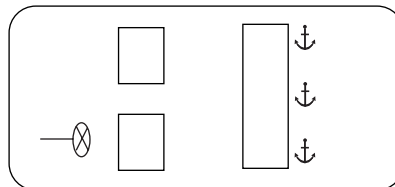

Attach the tether strap only to the appropriate tether anchor as shown. The tether strap may not work properly if attached somewhere other than the correct tether anchor.

1. Position the child safety seat on the seat cushion.

200

Seating and Safety Restraints

2. Route the child safety seat tether strap over the back of the seat.

For vehicles with adjustable head restraints, route the tether strap under the head restraint and between the head restraint posts, otherwise route the tether strap over the top of the seatback.

3. Locate the correct anchor for the selected seating position.



4. Open the tether anchor cover.

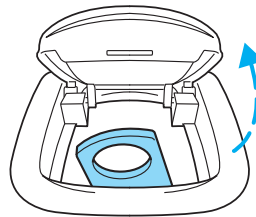

5. Clip the tether strap to the anchor as shown.



If the tether strap is clipped incorrectly, the child safety seat may not be retained properly in the event of a collision.

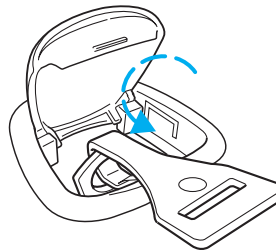

6. Install the child safety seat tightly using the LATCH anchors or safety belts. Follow the instructions in this chapter.

7. Tighten the child safety seat tether strap according to the manufacturer's instructions.



If the safety seat is not anchored properly, the risk of a child being injured in a collision greatly increases.

Seating and Safety Restraints

Attaching safety seats with LATCH (Lower Anchors and Tethers for Children) attachments

Some child safety seats have two rigid or webbing mounted attachments that connect to two anchors at certain seating positions in your vehicle. This type of child seat eliminates the need to use seat belts to attach the child seat. For forward-facing child seats, the tether strap must also be attached to the proper tether anchor. See *Attaching safety seats with tether straps* in this chapter.

Your vehicle has LATCH anchors for child seat installation at the seating positions marked with the child seat symbol.

The anchors on both sides of the center of the rear seat are provided for child seats at the outboard seats, and are further apart than the pairs of lower anchors for child seat installation at other seats. DO NOT install child seats with LATCH attachments (rigid or mounted on belt webbing) to the lower anchors at the center rear seat. If you install a child seat at the center rear position, use the vehicle belt and the top tether anchor.

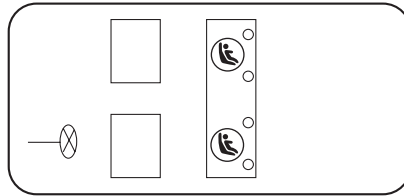

Never attach two LATCH child safety seats to the same anchor. In a crash, one anchor may not be strong enough to hold two child safety seat attachments and may break, causing serious injury or death.

Seating and Safety Restraints

Follow the child seat manufacturer's instructions to properly install a child seat with LATCH attachments. The lower anchors for child seat installation are located at the rear section of the rear seat between the cushion and seat back. The LATCH anchors are below the locator symbols on the seat back.

Two plastic LATCH guides can be obtained at no charge from any Ford or Lincoln/Mercury dealer. They snap onto the LATCH lower anchors in the seat to help attach a child seat with rigid attachments. The guides hold the seat trim away to expose the anchor and make it easier to attach some child seats.

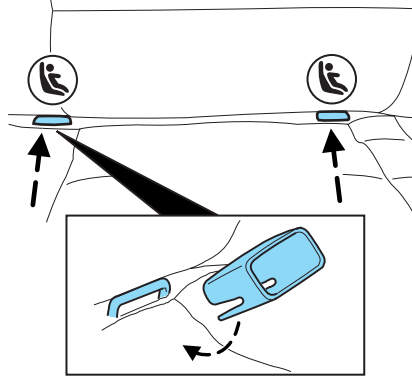

Attach LATCH lower attachments of the child seat only to the anchors shown.

If you install a child seat with rigid LATCH attachments, do not tighten the tether strap enough to lift the child seat off the vehicle seat cushion when the child is seated in it. Keep the tether strap just snug without lifting the front of the child seat. Keeping the child seat just touching the vehicle seat gives the best protection in a severe crash.

Each time you use the safety seat, check that the seat is properly attached to the lower anchors and tether anchor. Try to tilt the child seat from side to side. Also try to tug the seat forward. Check to see if the anchors hold the seat in place.



If the safety seat is not anchored properly, the risk of a child being injured in a crash greatly increases.

Tires, Wheels and Loading

INFORMATION ABOUT UNIFORM TIRE QUALITY GRADING

New vehicles are fitted with tires that have a rating on them called Tire Quality Grades. The Quality grades can be found where applicable on the tire sidewall between tread shoulder and maximum section width. For example:

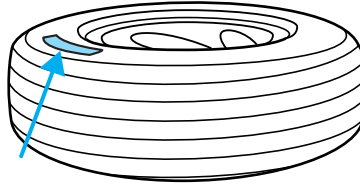

- **Treadwear 200 Traction AA Temperature A**

These Tire Quality Grades are determined by standards that the United States Department of Transportation has set.

Tire Quality Grades apply to new pneumatic tires for use on passenger cars. They do not apply to deep tread, winter-type snow tires, space-saver or temporary use spare tires, tires with nominal rim diameters of 10 to 12 inches or limited production tires as defined in Title 49 Code of Federal Regulations Part 575.104(c)(2).

U.S. Department of Transportation-Tire quality grades: The U.S. Department of Transportation requires Ford to give you the following information about tire grades exactly as the government has written it.

Treadwear

The treadwear grade is a comparative rating based on the wear rate of the tire when tested under controlled conditions on a specified government test course. For example, a tire graded 150 would wear one and one-half (1 1/2) times as well on the government course as a tire graded 100. The relative performance of tires depends upon the actual conditions of their use, however, and may depart significantly from the norm due to variations in driving habits, service practices, and differences in road characteristics and climate.

Traction AA A B C

The traction grades, from highest to lowest are AA, A, B, and C. The grades represent the tire's ability to stop on wet pavement as measured under controlled conditions on specified government test surfaces of asphalt and concrete. A tire marked C may have poor traction performance.

204

Tires, Wheels and Loading



The traction grade assigned to this tire is based on straight-ahead braking traction tests, and does not include acceleration, cornering, hydroplaning or peak traction characteristics.

Temperature A B C

The temperature grades are A (the highest), B and C, representing the tire's resistance to the generation of heat and its ability to dissipate heat when tested under controlled conditions on a specified indoor laboratory test wheel. Sustained high temperature can cause the material of the tire to degenerate and reduce tire life, and excessive temperature can lead to sudden tire failure. The grade C corresponds to a level of performance which all passenger car tires must meet under the Federal Motor Vehicle Safety Standard No. 109. Grades B and A represent higher levels of performance on the laboratory test wheel than the minimum required by law.



The temperature grade for this tire is established for a tire that is properly inflated and not overloaded. Excessive speed, underinflation, or excessive loading, either separately or in combination, can cause heat buildup and possible tire failure.

TIRES

Tires are designed to give many thousands of miles of service, but they must be maintained in order to get the maximum benefit from them.

Glossary of tire terminology

- **Tire label:** A label showing the OE (Original Equipment) tire sizes, recommended inflation pressure and the maximum weight the vehicle can carry.
- **Tire Identification Number (TIN):** A number on the sidewall of each tire providing information about the tire brand and manufacturing plant, tire size and date of manufacture.
- **Inflation pressure:** A measure of the amount of air in a tire.
- **Standard load:** A class of P-metric or Metric tires designed to carry a maximum load at 35 psi [37 psi (2.5 bar) for Metric tires]. Increasing the inflation pressure beyond this pressure will not increase the tire's load carrying capability.
- **Extra load:** A class of P-metric or Metric tires designed to carry a heavier maximum load at 41 psi [43 psi (2.9 bar) for Metric tires].

Tires, Wheels and Loading

Increasing the inflation pressure beyond this pressure will not increase the tire's load carrying capability.

- **kPa:** Kilopascal, a metric unit of air pressure.
- **PSI:** Pounds per square inch, a standard unit of air pressure.
- **Cold inflation pressure:** The tire pressure when the vehicle has been stationary and out of direct sunlight for an hour or more and prior to the vehicle being driven for 1 mile (1.6 km).
- **Recommended inflation pressure:** The cold inflation pressure found on the tire label located on the B-Pillar or the edge of the driver's door.
- **B-pillar:** The structural member at the side of the vehicle behind the front door.
- **Bead area of the tire:** Area of the tire next to the rim.
- **Sidewall of the tire:** Area between the bead area and the tread.
- **Tread area of the tire:** Area of the perimeter of the tire that contacts the road when mounted on the vehicle.
- **Rim:** The metal support (wheel) for a tire or a tire and tube assembly upon which the tire beads are seated.

INSPECTING AND INFLATING YOUR TIRES

Safe operation of your vehicle requires that your tires are properly inflated. Remember that a tire can lose up to half of its air pressure without appearing flat.

Every day before you drive, check your tires. If one looks lower than the others, use a tire gauge to check pressure of all tires, and adjust if required.

At least once a month and before long trips, inspect each tire and check the tire pressure with a tire gauge (including spare, if equipped). Inflate all tires to the inflation pressure recommended by Ford Motor Company.

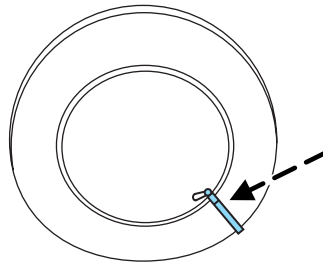

Tires, Wheels and Loading

Inspecting your tires

Periodically inspect the tire treads for uneven or excessive wear and remove stones, nails, glass or other objects that may be wedged in the tread grooves. Check for holes or cuts that may permit air leakage from the tire and make necessary repairs.

Also inspect the tire sidewalls for cuts, bruises and other damage. If internal damage to the tire is suspected, have the tire demounted and inspected in case it needs to be repaired or replaced. For your safety, tires that are damaged should not be used because they are more likely to blow out or fail. Tires can be damaged during off-road use, so inspection after off-road use is also recommended.

Inflating your tires

Use a tire gauge to check the tire inflation pressure, including the spare (if equipped), at least monthly and before long trips. You are strongly urged to buy a reliable tire pressure gauge, as automatic service station gauges may be inaccurate. Ford recommends the use of a digital or dial type tire pressure gauge rather than a stick type tire pressure gauge.

Use the recommended cold inflation pressure for optimum tire performance and wear. Under-inflation or over-inflation may cause uneven treadwear patterns.



Under-inflation is the most common cause of tire failures and may result in severe tire cracking, tread separation or "blowout", with unexpected loss of vehicle control and increased risk of injury. Under-inflation increases sidewall flexing and rolling resistance, resulting in heat buildup and internal damage to the tire. It also may result in unnecessary tire stress, irregular wear, loss of vehicle control and accidents. A tire can lose up to half of its air pressure and not appear to be flat!

Always inflate your tires to the Ford recommended inflation pressure even if it is less than the maximum inflation pressure information found on the tire. The Ford recommended tire inflation pressure is found on the tire label or certification label which is located on the B-Pillar or the edge of the driver's door. Failure to follow the tire pressure recommendations can cause uneven treadwear patterns and adversely affect the way your vehicle handles.

Tires, Wheels and Loading

Maximum Permissible Inflation Pressure is the tire manufacturer's maximum permissible pressure and/or the pressure at which the maximum load can be carried by the tire. This pressure is normally higher than the manufacturer's recommended cold inflation pressure which can be found on either the tire label or certification label which is located on the B-Pillar or the edge of the driver's door. The cold inflation pressure should never be set lower than the recommended pressure on the tire label or certification label.

When weather temperature changes occur, tire inflation pressures also change. A 10° F (6° C) temperature drop can cause a corresponding drop of 1 psi (7 kPa) in inflation pressure. Check your tire pressures frequently and adjust them to the proper pressure which can be found on the tire label or certification label.

If you are checking tire pressure when the tire is hot, (i.e. driven more than 1 mile [1.6 km]), never "bleed" or reduce air pressure. The tires are hot from driving and it is normal for pressures to increase above recommended cold pressures. A hot tire at or below recommended cold inflation pressure could be significantly under-inflated.

To check the pressure in your tire(s):

1. Make sure the tires are cool, meaning they are not hot from driving even a mile.

Note: If you have to drive a distance to get air for your tire(s), check and record the tire pressure first and add the appropriate air pressure when you get to the pump. It is normal for tires to heat up and the air pressure inside to go up as you drive. Never "bleed" or reduce air pressure when tires are hot.

2. Remove the cap from the valve on one tire, then firmly press the tire gauge onto the valve and measure the pressure with the tire gauge.

3. Add enough air to reach the recommended air pressure

Note: If you overfill the tire, release air by pushing on the metal stem in the center of the valve. Then recheck the pressure with your tire gauge.

4. Replace the valve cap.

5. Repeat this procedure for each tire, including the spare.

Note: Some spare tires require higher inflation pressure than the other tires. Check the tire label on the B pillar or the edge of the driver's door for the recommended spare tire pressure.

6. Visually inspect the tires to make sure there are no nails or other objects embedded that could poke a hole in the tire and cause an air leak.

Tires, Wheels and Loading

7. Check the sidewalls to make sure there are no gouges, cuts or bulges.

TIRE REPLACEMENT REQUIREMENTS

Your vehicle is equipped with tires designed to provide a safe ride and handling capability.



Only use replacement tires and wheels that are the same size and type (such as P-metric versus LT-metric or all-season versus all-terrain) as those originally provided by Ford. Use of any tire or wheel not recommended by Ford can affect the safety and performance of your vehicle, which could result in an increased risk of loss of vehicle control, vehicle rollover, personal injury and death. Additionally the use of non-recommended tires and wheels could cause steering, suspension, axle or transfer case/power transfer unit failure. If you have questions regarding tire replacement, see an authorized Ford or Lincoln/Mercury dealer.

Make sure all tires and wheels on the vehicle are of the same size, type, tread design, brand, load-carrying capacity and speed rating because it can affect the safety and performance of your vehicle, which could result in an increased risk of loss of vehicle control, vehicle rollover, personal injury and death.

Important: Remember to replace the spare tire when you replace the road tires at the end of their useful life. Even if it has never been used, the spare tire should be replaced because tires degrade over time.

Important: Remember to replace the wheel air valves when the road tires are replaced at the end of their useful life.

CHANGING THE TIRES

If you get a flat tire while driving:

- do not brake heavily.
- gradually decrease the vehicle's speed.
- hold the steering wheel firmly.
- slowly move to a safe place on the side of the road.



The use of tire sealants is not recommended and may damage your tires.

Tires, Wheels and Loading

T-Type/Mini-Spare Tire Information (if equipped)

Your vehicle may be equipped with a T-type/mini-spare tire. This tire will have the words "Temporary Use Only" molded into the tire sidewall. This spare tire is considered "temporary". Replace the T-type/mini-spare with a tire of the same size, speed rating and load carrying capacity as the other road tires as soon as possible.

When driving with the T-type/mini-spare tire **do not:**

- Exceed 50 mph (80 km/h)
- Load the vehicle beyond maximum vehicle load rating listed on the Safety Compliance Label
- Tow a trailer
- Use snow chains on the end of the vehicle with the T-type/mini spare tire
- Use more than one T-type/mini spare tire at a time
- Use commercial car washing equipment
- Try to repair the T-type/mini spare tire

Use of a T-type/mini spare tire at any one wheel location can lead to impairment of the following:

- Handling, stability and braking performance
- Comfort and noise
- Ground clearance and parking at curbs
- Winter weather driving capability
- Wet weather driving capability

Dissimilar spare tire/wheel information (if equipped)



Failure to follow these guidelines could result in an increased risk of loss of vehicle control, injury or death.

Your vehicle may be equipped with a dissimilar spare tire/wheel. A dissimilar spare tire/wheel is defined as a spare tire and/or wheel that is different in brand, size or appearance from the road tires and wheels. If you have a dissimilar spare tire/wheel, then it is intended for temporary use only. This means that if you need to use it, you should replace it as soon as possible with a road tire/wheel that is the same size and type as the road tires and wheels that were originally provided by Ford. If the dissimilar spare tire or wheel is damaged, it should be replaced rather than repaired.

Tires, Wheels and Loading

When driving with the dissimilar spare tire/wheel, **do not:**

- Exceed 70 mph (113 km/h)
- Use more than one dissimilar spare tire/wheel at a time
- Use commercial car washing equipment
- Use snow chains on the end of the vehicle with the dissimilar spare tire/wheel

The usage of a dissimilar spare tire/wheel can lead to impairment of the following:

- Handling, stability and braking performance
- Comfort and noise
- Ground clearance and parking at curbs
- Winter weather driving capability
- Wet weather driving capability
- All-Wheel driving capability (if applicable)
- Load leveling adjustment (if applicable)

When driving with the dissimilar spare tire/wheel additional caution should be given to:

- Towing a trailer
- Driving vehicles equipped with a camper body
- Driving vehicles with a load on the cargo rack

Drive cautiously when using a dissimilar spare tire/wheel and seek service as soon as possible.

Tire change procedure



To help prevent the vehicle from moving when you change a tire, be sure the parking brake is set, then block (in both directions) the wheel that is diagonally opposite (other side and end of the vehicle) to the tire being changed.



If the vehicle slips off the jack, you or someone else could be seriously injured.

Tires, Wheels and Loading

1. Park on a level surface, activate hazard flashers and set parking brake.

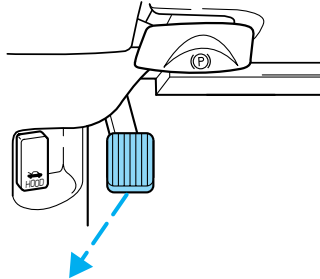

2. Place gearshift lever in P (Park), turn engine OFF and block the diagonally opposite wheel.

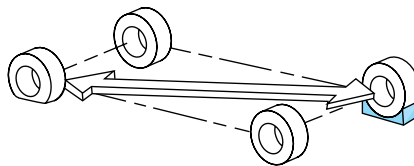

3. Remove the spare tire and the jack. The jack is located in the trunk (in a holder bracket), on the right-hand side, next to the wheel well.

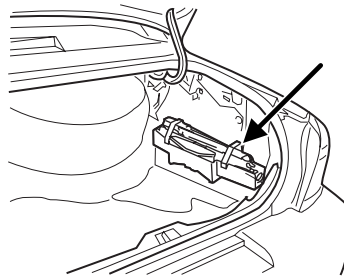

 On vehicles equipped with Air Suspension, turn OFF the Air Suspension switch prior to jacking, hoisting or towing your vehicle.

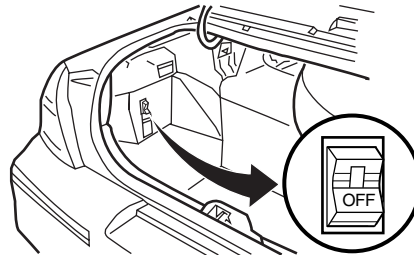

Refer to *Air suspension system* in the *Driving* chapter for more information.

Tires, Wheels and Loading

4. Remove the lug wrench (A) from the jack. Rotate the lug wrench socket out from the handle.

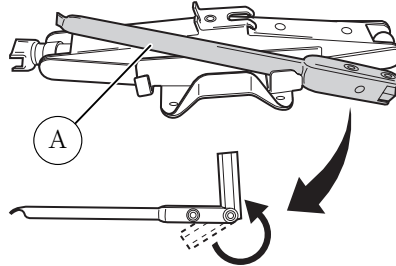

5. Locate pry off notch (if equipped) and remove the center ornament from the aluminum wheel with the tapered end of the wheel nut wrench that came with your vehicle. Insert and twist the handle, then pry against the wheel.

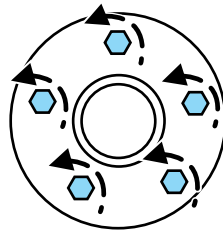

6. Loosen each wheel lug nut one-half turn counterclockwise but do not remove them until the wheel is raised off the ground.

STOP Before placing the jack under the vehicle, NOTE the jack location markings:

JACK LOCATION-FRONT

The jack location markings can be found **on the lower outer edge of the body**.

- Locate the jack locator mark (B - **semi-circle**) on the body (C) near the tire you are changing, then place the jack (D) **under the frame (A) of the vehicle** aligning it with the mark (B - **semi-circle**).

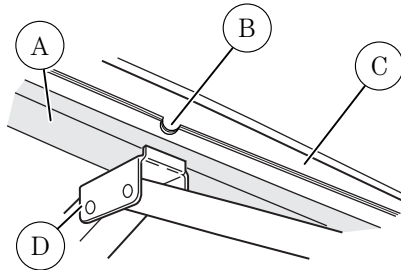

Tires, Wheels and Loading

JACK LOCATION-REAR

The jack location markings can be found **on the lower outer edge of the body**.

- Locate the jack locator mark (B - **triangle**) on the body (C) near the tire you are changing, then place the jack (D) **under the frame (A) of the vehicle** aligning it with the mark (B - **triangle**).
- Position the jack according to the following guides and turn the jack handle clockwise until the wheel is completely off the ground.

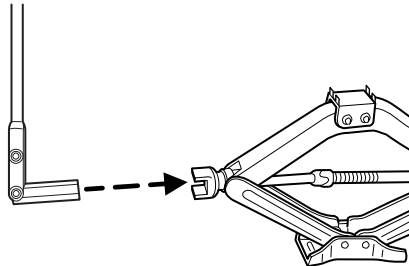
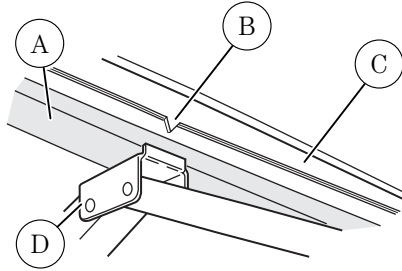

To lessen risk of personal injury, do not put any part of your body under the vehicle while changing a tire. Do not start the engine when your vehicle is on the jack. The jack is **ONLY** meant for changing the tire.

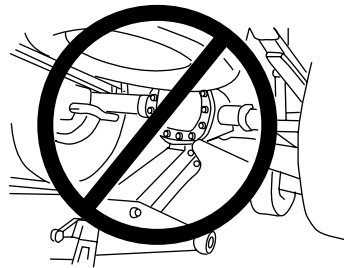

- **Never use the rear differential as a jacking point.**

7. Remove the lug nuts with the lug wrench.
8. Replace the flat tire with the spare tire, making sure the valve stem is facing outward. Reinstall lug nuts until the wheel is snug against the hub. Do not fully tighten the lug nuts until the wheel has been lowered.
9. Lower the vehicle by turning the jack handle counterclockwise.

214

Tires, Wheels and Loading

10. Remove the jack and fully tighten the lug nuts in the order shown. Refer to *Wheel lug nut torque specifications* later in this chapter for the proper lug nut torque specification.

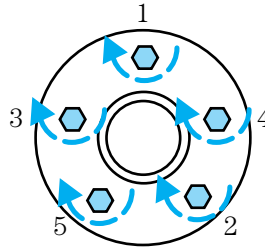

11. Put flat tire, jack and lug wrench away. Be sure to stow the jack properly in the holder bracket.

12. Turn on the air suspension switch.

WHEEL LUG NUT TORQUE SPECIFICATIONS

Retighten the lug nuts to the specified torque at 500 miles (800 km) after any wheel disturbance (tire rotation, changing a flat tire, wheel removal, etc.).

Bolt size	Wheel lug nut torque*	
	lb.ft.	N•m
½ x 20	100	135

* Torque specifications are for nut and bolt threads free of dirt and rust. Use only Ford recommended replacement fasteners.



When a wheel is installed, always remove any corrosion, dirt or foreign materials present on the mounting surfaces of the wheel or the surface of the front disc brake hub and rotor that contacts the wheel. Installing wheels without correct metal-to-metal contact at the wheel mounting surfaces can cause the wheel nuts to loosen and the wheel to come off while the vehicle is in motion, resulting in loss of control.

INFORMATION CONTAINED ON THE TIRE SIDEWALL

Federal law requires tire manufacturers to place standardized information on the sidewall of all tires. This information identifies and describes the fundamental characteristics of the tire and also provides a U.S. DOT Tire Identification Number for safety standard certification and in case of a recall.

Tires, Wheels and Loading

Information on “P” type tires

P215/65R15 95H is an example of a tire size, load index and speed rating. The definitions of these items are listed below. (Note that the tire size, load index and speed rating for your vehicle may be different from this example.)

1. **P:** Indicates a tire, designated by the Tire and Rim Association (T&RA), that may be used for service on cars, SUVs, minivans and light trucks.

Note: If your tire size does not begin with a letter this may mean it is designated by either ETRTO (European Tire and Rim Technical Organization) or JATMA (Japan Tire Manufacturing Association).

2. **215:** Indicates the nominal width of the tire in millimeters from sidewall edge to sidewall edge. In general, the larger the number, the wider the tire.

3. **65:** Indicates the aspect ratio which gives the tire’s ratio of height to width.

4. **R:** Indicates a “radial” type tire.

5. **15:** Indicates the wheel or rim diameter in inches. If you change your wheel size, you will have to purchase new tires to match the new wheel diameter.

6. **95:** Indicates the tire’s load index. It is an index that relates to how much weight a tire can carry. You may find this information in your *Owner’s Guide*. If not, contact a local tire dealer.

Note: You may not find this information on all tires because it is not required by federal law.

7. **H:** Indicates the tire’s speed rating. The speed rating denotes the speed at which a tire is designed to be driven for extended periods of time under a standard condition of load and inflation pressure. The tires on your vehicle may operate at different conditions for load and inflation pressure. These speed ratings may need to be adjusted for the difference in conditions. The ratings range from 81 mph (130 km/h) to 186 mph (299 km/h). These ratings are listed in the following chart.

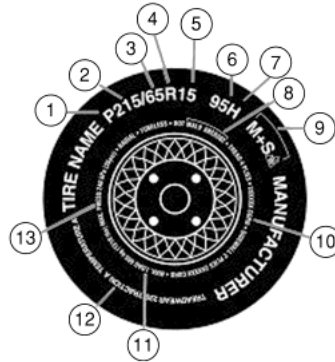

Tires, Wheels and Loading

Note: You may not find this information on all tires because it is not required by federal law.

Letter rating	Speed rating - mph (km/h)
M	81 mph (130 km/h)
N	87 mph (140 km/h)
Q	99 mph (159 km/h)
R	106 mph (171 km/h)
S	112 mph (180 km/h)
T	118 mph (190 km/h)
U	124 mph (200 km/h)
H	130 mph (210 km/h)
V	149 mph (240 km/h)
W	168 mph (270 km/h)
Y	186 mph (299 km/h)

Note: For tires with a maximum speed capability over 149 mph (240 km/h), tire manufacturers sometimes use the letters ZR. For those with a maximum speed capability over 186 mph (299 km/h), tire manufacturers always use the letters ZR.

8. U.S. DOT Tire Identification Number (TIN): This begins with the letters "DOT" and indicates that the tire meets all federal standards. The next two numbers or letters are the plant code designating where it was manufactured, the next two are the tire size code and the last four numbers represent the week and year the tire was built. For example, the numbers 317 mean the 31st week of 1997. After 2000 the numbers go to four digits. For example, 2501 means the 25th week of 2001. The numbers in between are identification codes used for traceability. This information is used to contact customers if a tire defect requires a recall.

9. M+S or M/S: Mud and Snow, or

AT: All Terrain, or

AS: All Season.

10. Tire Ply Composition and Material Used: Indicates the number of plies or the number of layers of rubber-coated fabric in the tire tread and sidewall. Tire manufacturers also must indicate the ply materials in the tire and the sidewall, which include steel, nylon, polyester, and others.

11. Maximum Load: Indicates the maximum load in kilograms and pounds that can be carried by the tire. Refer to the tire label or the safety certification label, which is located on the B-Pillar or the edge of the driver's door, for the correct tire pressure for your vehicle.

Tires, Wheels and Loading

12. Treadwear, Traction and Temperature Grades

- **Treadwear:** The treadwear grade is a comparative rating based on the wear rate of the tire when tested under controlled conditions on a specified government test course. For example, a tire graded 150 would wear one and one-half (1½) times as well on the government course as a tire graded 100.
- **Traction:** The traction grades, from highest to lowest are AA, A, B, and C. The grades represent the tire's ability to stop on wet pavement as measured under controlled conditions on specified government test surfaces of asphalt and concrete. A tire marked C may have poor traction performance.
- **Temperature:** The temperature grades are A (the highest), B and C, representing the tire's resistance to the generation of heat and its ability to dissipate heat when tested under controlled conditions on a specified indoor laboratory test wheel.

13. **Maximum Permissible Inflation Pressure:** Indicates the tire manufacturers' maximum permissible pressure and/or the pressure at which the maximum load can be carried by the tire. This pressure is normally higher than the manufacturer's recommended cold inflation pressure which can be found on either the tire label or certification label which is located on the B-Pillar or the edge of the driver's door. The cold inflation pressure should never be set lower than the recommended pressure on the vehicle label.

The tire suppliers may have additional markings, notes or warnings such as standard load, radial tubeless, etc.

Tires, Wheels and Loading

Additional information contained on the tire sidewall for “LT” type tires

“LT” type tires have some additional information beyond those of “P” type tires; these differences are described below:

1. **LT:** Indicates a tire, designated by the Tire and Rim Association (T&RA), that is intended for service on light trucks.

2. **Load Range/Load Inflation Limits:** Indicates the tire’s load-carrying capabilities and its inflation limits.

3. **Maximum Load Dual lb. (kg) at psi (kPa) cold:** Indicates the maximum load and tire pressure when the tire is used as a dual; defined as four tires on the rear axle (a total of six or more tires on the vehicle).

4. **Maximum Load Single lb. (kg) at psi (kPa) cold:** Indicates the maximum load and tire pressure when the tire is used as a single; defined as two tires (total) on the rear axle.

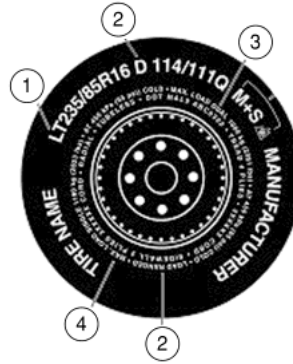

Tires, Wheels and Loading

Information on “T” type tires

“T” type tires have some additional information beyond those of “P” type tires; these differences are described below:

T145/80D16 is an example of a tire size.

Note: The temporary tire size for your vehicle may be different from this example.

1. **T:** Indicates a type of tire, designated by the Tire and Rim Association (T&RA), that is intended for temporary service on cars, SUVs, minivans and light trucks.

2. **145:** Indicates the nominal width of the tire in millimeters from sidewall edge to sidewall edge. In general, the larger the number, the wider the tire.

3. **80:** Indicates the aspect ratio which gives the tire’s ratio of height to width. Numbers of 70 or lower indicate a short sidewall.

4. **D:** Indicates a “diagonal” type tire.

R: Indicates a “radial” type tire.

5. **16:** Indicates the wheel or rim diameter in inches. If you change your wheel size, you will have to purchase new tires to match the new wheel diameter.

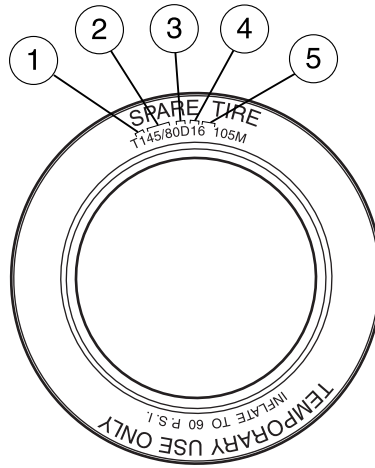

Location of the tire label

You will find a tire label containing tire inflation pressure by tire size and other important information located on the B-Pillar or the edge of the driver’s door. Refer to the payload description and graphic in the *Vehicle loading — with and without a trailer* section.

TIRE CARE

Improper or inadequate vehicle maintenance can also cause tires to wear abnormally. Here are some of the important maintenance items:

Tire wear

Measure and inspect the tire tread on all your tires periodically. Advanced and unusual tire wear can reduce the ability of tread to grip

Tires, Wheels and Loading

the road in adverse (wet, snowy, etc.) conditions. Visually check your tires for uneven wear, looking for high and low areas or unusually smooth areas. Also check for signs of tire damage.

When the tread is worn down to 1/16th of an inch (2 mm), tires must be replaced to prevent your vehicle from skidding and hydroplaning. Built-in treadwear indicators, or “wear bars”, which look like narrow strips of smooth rubber across the tread will appear on the tire when the tread is worn down to 1/16th of an inch (2 mm). When the tire tread wears down to the same height as these “wear bars”, the tire is worn out and should be replaced.

Inspect your tires frequently for any of the following conditions and replace them if one or more of the following conditions exist:

- Fabric showing through the tire rubber
- Bulges in the tread or sidewalls
- Cracks or cuts on the sidewalls
- Cracks in the tread groove
- Impact damage resulting from use
- Separation in the tread
- Separation in the sidewall
- Severe abrasion on the sidewall

If your vehicle has a leak in the exhaust system, a road tire or the spare tire may be exposed to hot exhaust temperatures requiring the tire to be replaced.

Safety practices

Driving habits have a great deal to do with your tire mileage and safety.

- Observe posted speed limits
- Avoid fast starts, stops and turns

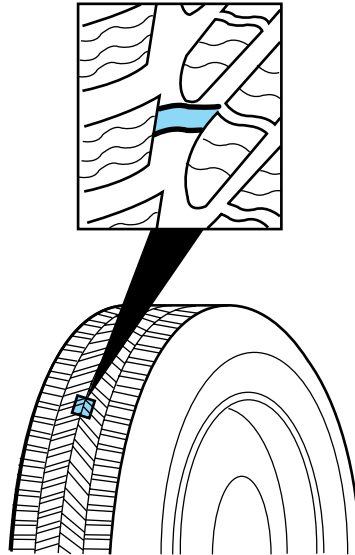

Tires, Wheels and Loading

- Avoid potholes and objects on the road
- Do not run over curbs or hit the tire against a curb when parking



If your vehicle is stuck in snow, mud, sand, etc., **do not** rapidly spin the tires; spinning the tires can tear the tire and cause an explosion. A tire can explode in as little as three to five seconds.



Never spin the tires in excess of the 35 mph (55 km/h) point indicated on the speedometer.

Highway hazards

No matter how carefully you drive there's always the possibility that you may eventually have a flat tire on the highway. Drive slowly to the closest safe area out of traffic. This may further damage the flat tire, but your safety is more important.

If you feel a sudden vibration or ride disturbance while driving, or you suspect your tire or vehicle has been damaged, immediately reduce your speed. Drive with caution until you can safely pull off the road. Stop and inspect the tires for damage. If a tire is under-inflated or damaged, deflate it, remove wheel and replace it with your spare tire and wheel. If you cannot detect a cause, have the vehicle towed to the nearest repair facility or tire dealer to have the vehicle inspected.

Tire and wheel alignment

A bad jolt from hitting a curb or pothole can cause the front end of your vehicle to become misaligned or cause damage to your tires. If your vehicle seems to pull to one side when you're driving, the wheels may be out of alignment. Have a qualified technician at a Ford or Lincoln/Mercury dealer check the wheel alignment periodically.

Wheel misalignment in the front or the rear can cause uneven and rapid treadwear of your tires and should be corrected by a qualified technician at a Ford or Lincoln/Mercury dealer. Front wheel drive (FWD) vehicles and those with an independent rear suspension (if equipped) may require alignment of all four wheels.

The tires should also be balanced periodically. An unbalanced tire and wheel assembly may result in irregular tire wear.

Tires, Wheels and Loading

Tire rotation

Rotating your tires at the recommended interval (as indicated in the *scheduled maintenance information* that comes with your vehicle) will help your tires wear more evenly, providing better tire performance and longer tire life. Unless otherwise specified, rotate the tires approximately every 5,000 miles (8,000 km).

- Front Wheel Drive (FWD) vehicles (front tires at top of diagram)

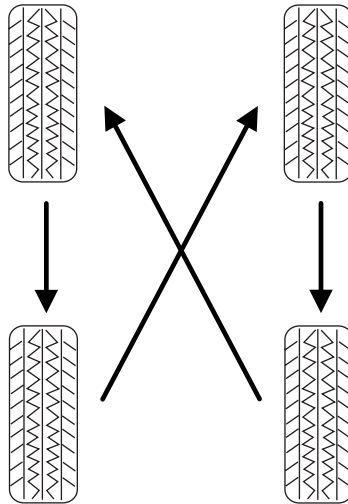

Tires, Wheels and Loading

- Rear Wheel Drive (RWD) vehicles/Four Wheel Drive (4WD)/ All Wheel Drive (AWD) vehicles (front tires at top of diagram)

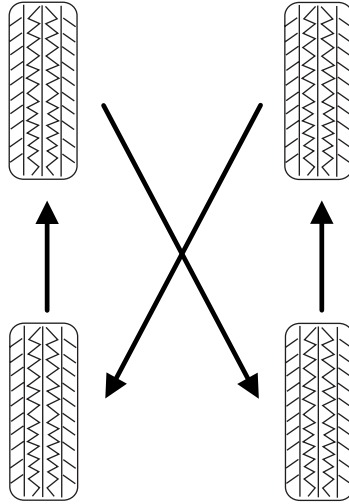

Sometimes irregular tire wear can be corrected by rotating the tires.

Note: If your tires show uneven wear ask a qualified technician at a Ford or Lincoln/Mercury dealership to check for and correct any wheel misalignment, tire imbalance or mechanical problem involved before tire rotation.

Note: Your vehicle may be equipped with a dissimilar spare tire/wheel. A dissimilar spare tire/wheel is defined as a spare tire and/or wheel that is different in brand, size or appearance from the road tires and wheels. If you have a dissimilar spare tire/wheel it is intended for temporary use only and should not be used in a tire rotation.

Note: After having your tires rotated, inflation pressure must be checked and adjusted to the vehicle requirements.

SNOW TIRES AND CHAINS



Snow tires must be the same size and grade as the tires you currently have on your vehicle.

The tires on your vehicle have all weather treads to provide traction in rain and snow. However, in some climates, you may need to use snow tires and chains.

Tires, Wheels and Loading

Follow these guidelines when using snow tires and chains:

- Use only cable type chains offered by Ford as an accessory or equivalent. Using SAE class S or other conventional link type chains may cause damage to the vehicle's wheel house and/or body.
- Install chains securely, verifying that the chains do not touch any wiring, brake lines or fuel lines.
- Drive cautiously. If you hear the chains rub or bang against your vehicle, stop and re-tighten the chains. If this does not work, remove the chains to prevent damage to your vehicle.
- If possible, avoid fully loading your vehicle.
- Remove the tire chains when they are no longer needed. Do not use tire chains on dry roads.
- The suspension insulation and bumpers will help prevent vehicle damage. Do not remove these components from your vehicle when using snow tires and chains.

VEHICLE LOADING – WITH AND WITHOUT A TRAILER

This section will guide you in the proper loading of your vehicle and/or trailer, to keep your loaded vehicle weight within its design rating capability, with or without a trailer. Properly loading your vehicle will provide maximum return of vehicle design performance. Before loading your vehicle, familiarize yourself with the following terms for determining your vehicle's weight ratings, with or without a trailer, from the vehicle's Safety Certification Label and Tire Label:

Base Curb Weight – is the weight of the vehicle including a full tank of fuel and all standard equipment. It does not include passengers, cargo, or optional equipment.

Vehicle Curb Weight – is the weight of your new vehicle when you picked it up from your dealer plus any aftermarket equipment.

Tires, Wheels and Loading

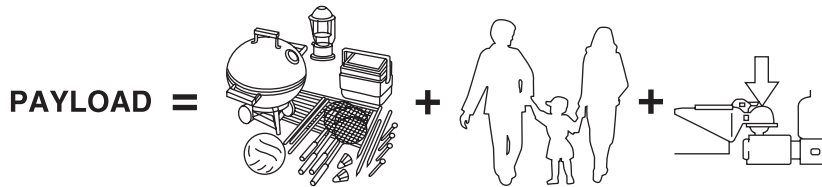

Payload – is the combined weight of cargo and passengers that the vehicle is carrying. The maximum payload for your vehicle can be found on the Tire Label on the B-Pillar or the edge of the driver's door. Look for **“THE COMBINED WEIGHT OF OCCUPANTS AND CARGO SHOULD NEVER EXCEED XXX kg OR XXX lb.”** for maximum payload. The payload listed on the tire label is the maximum payload for the vehicle as built by the assembly plant. If any aftermarket or dealer installed equipment has been installed on the vehicle, the weight of the equipment must be subtracted from the payload listed on the tire label in order to determine the new payload.

 The appropriate loading capacity of your vehicle can be limited either by volume capacity (how much space is available) or by payload capacity (how much weight the vehicle should carry). Once you have reached the maximum payload of your vehicle, do not add more cargo, even if there is space available. Overloading or improperly loading your vehicle can contribute to loss of vehicle control and vehicle rollover.

Tires, Wheels and Loading

Example only:

TIRE AND LOAD INFORMATION			
SEE OWNERS MANUAL FOR ADDITIONAL INFORMATION			
The combined weight of occupants and cargo should never exceed XXX kg or XXX lbs.			
SEATING CAPACITY	TOTAL: 5	FRONT: 2	REAR: 3
ORIGINAL TIRE SIZE		COLD TIRE INFLATION PRESSURE	
FRONT	P195 / 70R14	FRONT	200KPA, 29PSI
REAR	P195 / 70R14	REAR	200KPA, 29PSI
SPARE TIRE SIZE		COLD TIRE INFLATION PRESSURE	
T125/70D15		420KPA, 50PSI	

TIRE AND LOAD INFORMATION			
SEE OWNERS MANUAL FOR ADDITIONAL INFORMATION			
RENSEIGNEMENTS RELATIFS AUX PNEUS ET À LA CHARGE			
CONSULTER LE GUIDE DU PROPRIÉTAIRE POUR DE PLUS AMPLES RENSEIGNEMENTS			
The combined weight of occupants and cargo should never exceed ^{kg or} XXX kg or XXX lbs.			
La charge du véhicule (occupants et bagages) ne doit jamais dépasser ^{PM, kg ou} PM, kg ou			
SEATING CAPACITY	TOTAL: TS	FRONT: FS	REAR: RS
NOMBRE DE PLACES	TOTAL:	AVANT:	ARRIÈRE:
ORIGINAL TIRE SIZE		COLD TIRE INFLATION PRESSURE	
DIMENSIONS DES PNEUS D'ORIGINE		PRESSION DE GONFLAGE À FROID	
FRONT/ AVANT	FTIREXXXXXE	FRONT/ AVANT	FKPA KPA, FPS PSI
REAR/ ARRIÈRE	RTIREXXXXXE	REAR/ ARRIÈRE	RKPA KPA, RPS PSI
SPARE TIRE SIZE		COLD TIRE INFLATION PRESSURE	
DIMENSION DU PNEU SECOURS		PRESSION DE GONFLAGE À FROID	
STIREXXXXXE		SKP KPA, SPS PSI	

CARGO =

=



+

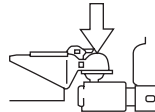

Cargo Weight – includes all weight added to the Base Curb Weight, including cargo and optional equipment. When towing, trailer tongue load or king pin weight is also part of cargo weight.

Tires, Wheels and Loading

GAW (Gross Axle Weight) – is the total weight placed on each axle (front and rear) – including vehicle curb weight and all payload.

GAWR (Gross Axle Weight Rating) – is the maximum allowable weight that can be carried by a single axle (front or rear). **These numbers are shown on the Safety Compliance Certification Label located on the B-Pillar or the edge of the driver's door. The total load on each axle must never exceed its GAWR.**



Exceeding the Safety Certification Label axle weight rating limits could result in substandard vehicle handling or performance, engine, transmission and/or structural damage, serious damage to the vehicle, loss of control and personal injury.

Note: For trailer towing information refer to *Trailer towing* found in this chapter or the *RV and Trailer Towing Guide* provided by your dealership.

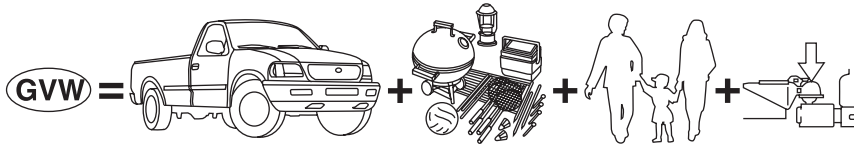

GVW (Gross Vehicle Weight) – is the Vehicle Curb Weight + cargo + passengers.

Tires, Wheels and Loading

GVWR (Gross Vehicle Weight Rating) – is the maximum allowable weight of the fully loaded vehicle (including all options, equipment, passengers and cargo). **The GVWR is shown on the Safety Compliance Certification Label located on the B-Pillar or the edge of the driver's door. The GVW must never exceed the GVWR.**

Sample Safety Compliance Certification Label <small>(Refer to actual label on your vehicle)</small>			
Front GAWR	GVWR	Rear GAWR	
MFD. BY FORD MOTOR CO. IN U.S.A.			
DATE: 06/95	GVWR: 6250 LB/2834 KG		
FRONT GAWR: 3450 LB 1584KG	WITH TIRES RIMS	REAR GAWR: 3777 LB 1713KG	WITH TIRES RIMS
P265/75R15SL 15X7.5J		P265/75R15SL 15X7.5J	
AT 30 PSI COLD		AT 30 PSI COLD	
THIS VEHICLE CONFORMS TO ALL APPLICABLE FEDERAL MOTOR VEHICLE SAFETY STANDARDS IN EFFECT ON THE DATE OF MANUFACTURE SHOWN ABOVE.			
XXXXXXXXXXXXX VIN: 1FTEX14H 0 SKB 00000			F0018
TYPE: XXXXXXXXXXXXXXXX			TC183
			
EXT PNT: XXXXXX XXXXXX			
WD	TYPE:GVW	BODY	TRANS
155	REM	E	HB
			DAO
			SPRINGS
			M4

 Exceeding the Safety Certification Label vehicle weight rating limits could result in substandard vehicle handling or performance, engine, transmission and/or structural damage, serious damage to the vehicle, loss of control and personal injury.

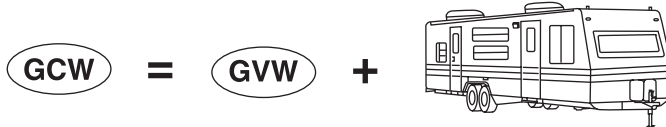

GCW (Gross Combined Weight) – is the weight of the loaded vehicle (GVW) plus the weight of the fully loaded trailer.

GCWR (Gross Combined Weight Rating) – is the maximum allowable weight of the vehicle and the loaded trailer – including all cargo and passengers – that the vehicle can handle without risking damage.

(Important: The towing vehicles' braking system is rated for operation at GVWR, not at GCWR. Separate functional brakes should be used for safe control of towed vehicles and for trailers where the GCW of the towing vehicle plus the trailer exceed the GVWR of the towing vehicle. **The GCW must never exceed the GCWR.**

Tires, Wheels and Loading

Maximum Loaded Trailer Weight – is the highest possible weight of a fully loaded trailer the vehicle can tow. It assumes a vehicle with only mandatory options, no cargo (internal or external), a tongue load of 10–15% (conventional trailer) or king pin weight of 15–25% (fifth wheel trailer), and driver only (150 lb. [68 kg]). **Consult your dealership (or the *RV and Trailer Towing Guide* provided by your dealership) for more detailed information.**



Do not exceed the GVWR or the GAWR specified on the certification label.



Do not use replacement tires with lower load carrying capacities than the originals because they may lower the vehicle's GVWR and GAWR limitations. Replacement tires with a higher limit than the originals do not increase the GVWR and GAWR limitations.



Exceeding any vehicle weight rating limitation could result in serious damage to the vehicle and/or personal injury.

Steps for determining the correct load limit:

1. Locate the statement “The combined weight of occupants and cargo should never exceed XXX kg or XXX lbs.” on your vehicle's placard.
2. Determine the combined weight of the driver and passengers that will be riding in your vehicle.
3. Subtract the combined weight of the driver and passengers from XXX kg or XXX lbs.
4. The resulting figure equals the available amount of cargo and luggage load capacity. For example, if the “XXX” amount equals 1,400 lbs. and there will be five 150 lb. passengers in your vehicle, the amount of available cargo and luggage load capacity is 650 lbs. (1400–750 (5 x 150) = 650 lb.). In metric units (635–340 (5 x 68) = 295 kg.)
5. Determine the combined weight of luggage and cargo being loaded on the vehicle. That weight may not safely exceed the available cargo and luggage load capacity calculated in Step 4.
6. If your vehicle will be towing a trailer, load from your trailer will be transferred to your vehicle. Consult this manual to determine how this reduces the available cargo and luggage load capacity of your vehicle.

The following gives you a few examples on how to calculate the available amount of cargo and luggage load capacity:

230

Tires, Wheels and Loading

- Another example for your vehicle with 1400 lb. (635 kg) of cargo and luggage capacity. You decide to go golfing. Is there enough load capacity to carry you, 4 of your friends and all the golf bags? You and four friends average 220 lb. (99 kg) each and the golf bags weigh approximately 30 lb. (13.5 kg) each. The calculation would be: $1400 - (5 \times 220) - (5 \times 30) = 1400 - 1100 - 150 = 150$ lb. Yes, you have enough load capacity in your vehicle to transport four friends and your golf bags. In metric units, the calculation would be: $635 \text{ kg} - (5 \times 99 \text{ kg}) - (5 \times 13.5 \text{ kg}) = 635 - 495 - 67.5 = 72.5$ kg.
- A final example for your vehicle with 1400 lb. (635 kg) of cargo and luggage capacity. You and one of your friends decide to pick up cement from the local home improvement store to finish that patio you have been planning for the past 2 years. Measuring the inside of the vehicle with the rear seat folded down, you have room for 12-100 lb. (45 kg) bags of cement. Do you have enough load capacity to transport the cement to your home? If you and your friend each weigh 220 lb. (99 kg), the calculation would be: $1400 - (2 \times 220) - (12 \times 100) = 1400 - 440 - 1200 = -240$ lb. No, you do not have enough cargo capacity to carry that much weight. In metric units, the calculation would be: $635 \text{ kg} - (2 \times 99 \text{ kg}) - (12 \times 45 \text{ kg}) = 635 - 198 - 540 = -103$ kg. You will need to reduce the load weight by at least 240 lb. (104 kg). If you remove 3-100 lb. (45 kg) cement bags, then the load calculation would be:
 $1400 - (2 \times 220) - (9 \times 100) = 1400 - 440 - 900 = 60$ lb. Now you have the load capacity to transport the cement and your friend home. . In metric units, the calculation would be: $635 \text{ kg} - (2 \times 99 \text{ kg}) - (9 \times 45 \text{ kg}) = 635 - 198 - 405 = 32$ kg.

The above calculations also assume that the loads are positioned in your vehicle in a manner that does not overload the Front or the Rear Gross Axle Weight Rating specified for your vehicle on the Certification label found on the edge of the driver's door.

TRAILER TOWING

Your vehicle is classified as a light duty towing vehicle. Do not tow a trailer until your vehicle has been driven at least 2,000 miles (3,200 km).

Towing a trailer places an additional load on your vehicle's engine, transmission, brakes, tires and suspension. Inspect these components carefully after towing.

Your loaded trailer should weigh no more than 2,000 lb. (907 kg). **Do not exceed the GVWR specified on the certification label.**

Tires, Wheels and Loading



Towing trailers beyond the maximum recommended gross trailer weight exceeds the limit of the vehicle and could result in engine damage, transmission damage, structural damage, loss of vehicle control, vehicle rollover and personal injury.

The GCW of your vehicle and trailer should not exceed 6,600 lb. (2,993 kg).

Preparing to tow

Use the proper equipment for towing a trailer and make sure it is properly attached to your vehicle. See your dealer or a reliable trailer dealer if you require assistance.

Hitches

Do not use hitches that clamp onto the vehicle bumper. Use a load carrying hitch. You must distribute the load in your trailer so that 10–15% of the total weight of the trailer is on the tongue.

Safety chains

Always connect the trailer's safety chains to the frame or hook retainers of the vehicle hitch. To connect the trailer's safety chains, cross the chains under the trailer tongue and allow slack for turning corners.

If you use a rental trailer, follow the instructions that the rental agency gives to you.

Do not attach safety chains to the bumper.

Trailer brakes

Electric brakes and manual, automatic or surge-type trailer brakes are safe if installed properly and adjusted to the manufacturer's specifications. The trailer brakes must meet local and Federal regulations.



Do not connect a trailer's hydraulic brake system directly to your vehicle's brake system. Your vehicle may not have enough braking power and your chances of having a collision greatly increase.

The braking system of the tow vehicle is rated for operation at the GVWR not GCWR.

Tires, Wheels and Loading

Trailer lamps

Trailer lamps are required on most towed vehicles. Make sure all running lights, brake lights, turn signals and hazard lights are working. See your dealer or trailer rental agency for proper instructions and equipment for hooking up trailer lamps.

Driving while you tow

When towing a trailer:

- Turn off the speed control. The speed control may shut off automatically when you are towing on long, steep grades.
- Consult your local motor vehicle speed regulations for towing a trailer.
- To eliminate excessive shifting, use a lower gear. This will also assist in transmission cooling. (For additional information, refer to *Understanding the gearshift positions of the 4-speed automatic transmission* in the *Driving chapter*.)
- Anticipate stops and brake gradually.
- Do not exceed the GCWR rating or transmission damage may occur.

Servicing after towing

If you tow a trailer for long distances, your vehicle will require more frequent service intervals. Refer to your *Scheduled Maintenance Information* for more information.

Trailer towing tips

- Practice turning, stopping and backing up before starting on a trip to get the feel of the vehicle trailer combination. When turning, make wider turns so the trailer wheels will clear curbs and other obstacles.
- Allow more distance for stopping with a trailer attached.
- If you are driving down a long or steep hill, shift to a lower gear. Do not apply the brakes continuously, as they may overheat and become less effective.
- The trailer tongue weight should be 10–15% of the loaded trailer weight.
- After you have traveled 50 miles (80 km), thoroughly check your hitch, electrical connections and trailer wheel lug nuts.
- To aid in engine/transmission cooling and A/C efficiency during hot weather while stopped in traffic, place the gearshift lever in P (Park).
- Vehicles with trailers should not be parked on a grade. If you must park on a grade, place wheel chocks under the trailer's wheels.

Tires, Wheels and Loading

Launching or retrieving a boat

Disconnect the wiring to the trailer before backing the trailer into the water. Reconnect the wiring to the trailer after the trailer is removed from the water.

When backing down a ramp during boat launching or retrieval:

- do not allow the static water level to rise above the bottom edge of the rear bumper.
- do not allow waves to break higher than 6 inches (15 cm) above the bottom edge of the rear bumper.

Exceeding these limits may allow water to enter vehicle components:

- causing internal damage to the components.
- affecting driveability, emissions and reliability.

Replace the rear axle lubricant any time the axle has been submerged in water. Rear axle lubricant quantities are not to be checked or changed unless a leak is suspected or repair required.

RECREATIONAL TOWING (ALL WHEELS ON THE GROUND)

Follow these guidelines for your specific powertrain combination to tow your vehicle with all four wheels on the ground (such as behind a recreational vehicle).

These guidelines are designed to ensure that your transmission is not damaged due to insufficient lubrication.

All Rear Wheel Drive (RWD) vehicles:

This applies to all cars and 4x2 trucks/sport utilities with rear wheel drive capability.

- Place the transmission in N (Neutral)
- Maximum speed is 35 mph (56 km/h)
- Maximum distance is 50 miles (80 km)

If a distance of 50 miles (80 km) or a speed of 35 mph (56 km/h) must be exceeded, you must disconnect the driveshaft. Ford recommends the driveshaft be removed/installed only by a qualified technician. See your local dealer for driveshaft removal/installation.

Improper removal/installation of the driveshaft can cause transmission fluid loss, damage to the driveshaft and internal transmission components.

STARTING

Positions of the ignition

1. OFF/LOCK, shuts off the engine and all accessories/locks the gearshift lever and allows key removal.
2. ACC, allows the electrical accessories such as the radio to operate while the engine is not running.
3. ON, all electrical circuits operational. Warning lights illuminated. Key position when driving.
4. START, cranks the engine. Release the key as soon as the engine starts.

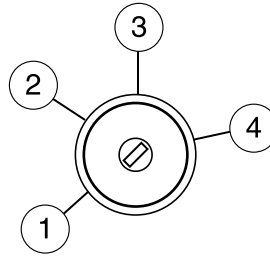

Refer to the *Securilock™ passive anti-theft system* section in the *Locks and Security* chapter for information on Securilock™ keys.

Preparing to start your vehicle

Engine starting is controlled by the powertrain control system. This system meets all Canadian Interference-Causing Equipment standard requirements regulating the impulse electrical field strength of radio noise.

When starting a fuel-injected engine, avoid pressing the accelerator before or during starting. Only use the accelerator when you have difficulty starting the engine. For more information on starting the vehicle, refer to *Starting the engine* in this chapter.





Extended idling at high engine speeds can produce very high temperatures in the engine and exhaust system, creating the risk of fire or other damage.



Do not park, idle, or drive your vehicle in dry grass or other dry ground cover. The emission system heats up the engine compartment and exhaust system, which can start a fire.

Driving

 Do not start your vehicle in a closed garage or in other enclosed areas. Exhaust fumes can be toxic. Always open the garage door before you start the engine. See *Guarding against exhaust fumes* in this chapter for more instructions.

 If you smell exhaust fumes inside your vehicle, have your dealer inspect your vehicle immediately. Do not drive if you smell exhaust fumes.

Important safety precautions

A computer system controls the engine's idle revolutions per minute (RPM). When the engine starts, the idle RPM runs higher than normal in order to warm the engine. If the engine idle speed does not slow down automatically, have the vehicle checked. Do not allow the vehicle to idle for more than 10 minutes at the higher engine RPM.

Before starting the vehicle:

1. Make sure all vehicle occupants have buckled their safety belts. For more information on safety belts and their proper usage, refer to the *Seating and Safety Restraints* chapter.
2. Make sure the headlamps and vehicle accessories are off.
3. Make sure the gearshift is in P (Park).



4. Make sure the parking brake is set.

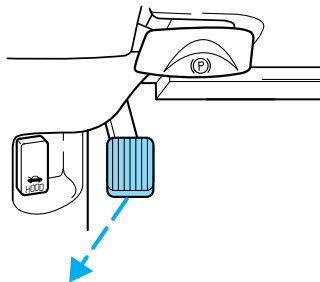

Driving

5. Turn the key to 3 (ON) without turning the key to 4 (START).

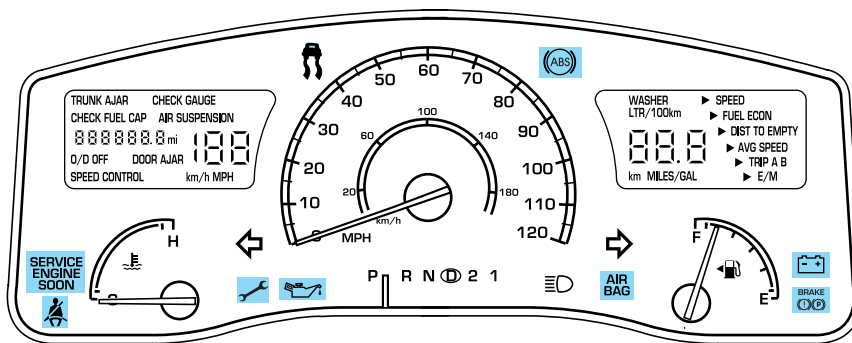
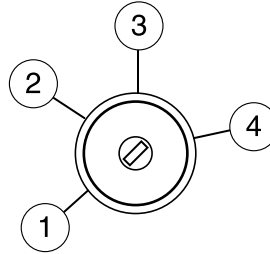

Make sure the corresponding lights illuminate or illuminate briefly. If a light fails to illuminate, have the vehicle serviced.

- If the driver's safety belt is fastened, the  light may not illuminate.

Starting the engine

1. Turn the key to 3 (ON) without turning the key to 4 (START).
2. Turn the key to 4 (START), then release the key as soon as the engine starts. Excessive cranking could damage the starter.

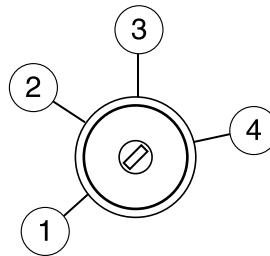

Driving

Note: If the engine does not start within five seconds on the first try, turn the key to OFF, wait 10 seconds and try again. If the engine still fails to start, press the accelerator to the floor and try again; this will allow the engine to crank with the fuel shut off in case the engine is flooded with fuel.

Using the engine block heater (if equipped)

Use of an engine block heater is strongly recommended if you live in a region where temperatures reach -10°F (-23°C) or below. For best results, plug the heater in at least three hours before starting the vehicle. The heater can be plugged in the night before starting the vehicle.



To reduce the risk of electrical shock, do not use your heater with ungrounded electrical systems or two-pronged (cheater) adapters.

Guarding against exhaust fumes

Carbon monoxide is present in exhaust fumes. Take precautions to avoid its dangerous effects.



If you smell exhaust fumes inside your vehicle, have your dealer inspect your vehicle immediately. Do not drive if you smell exhaust fumes.

Important ventilating information

If the engine is idling while the vehicle is stopped for a long period of time, open the windows at least one inch (2.5 cm) or adjust the heating or air conditioning to bring in fresh air.

BRAKES

Occasional brake noise is normal. If a metal-to-metal, continuous grinding or continuous squeal sound is present, the brake linings may be worn-out and should be inspected by a qualified service technician. If the vehicle has continuous vibration or shudder in the steering wheel while braking, the vehicle should be inspected by a qualified service technician.

Refer to *Brake system warning light* in the *Instrument Cluster* chapter for information on the brake system warning light.



Four-wheel anti-lock brake system (ABS)

Your vehicle is equipped with an Anti-lock Braking System (ABS). This system helps you maintain steering control during emergency stops by keeping the brakes from locking. Noise from the ABS pump motor and brake pedal pulsation may be observed during ABS braking and the brake pedal may suddenly travel a little farther as soon as ABS braking is done and normal brake operation resumes. These are normal characteristics of the ABS and should be no reason for concern.

Using ABS

When hard braking is required, apply continuous force on the brake pedal; do not pump the brake pedal since this will reduce the effectiveness of the ABS and will increase your vehicle's stopping distance. The ABS will be activated immediately, allowing you to retain full steering control during hard braking and on slippery surfaces. However, the ABS does not decrease stopping distance.

ABS warning lamp

The ABS lamp in the instrument cluster momentarily illuminates when the ignition is turned on. If the light does not illuminate during start up, remains on or flashes, the ABS may be disabled and may need to be serviced.



Even when the ABS is disabled, normal braking is still effective. (If your BRAKE warning lamp illuminates with the parking brake released, have your brake system serviced immediately.)



Driving

Parking brake with auto-release

Apply the parking brake whenever the vehicle is parked.

To set the parking brake:

1. Move the gearshift to P (Park).
2. Push pedal downward.

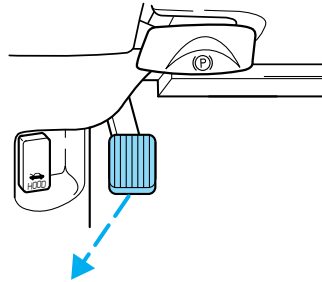

The BRAKE warning lamp in the instrument cluster illuminates and remains illuminated (when the ignition is turned ON) until the parking brake is fully released.



Always set the parking brake fully and make sure the gearshift is latched in P (Park). Turn the ignition to the OFF/LOCK position and remove the key whenever you leave your vehicle.

The parking brake is not recommended to stop a moving vehicle. However, if the normal brakes fail, the parking brake can be used to stop your vehicle in an emergency. Since the parking brake applies only the rear brakes, the vehicle's stopping distance will increase greatly and the handling of your vehicle will be adversely affected.

Your vehicle has an automatic parking brake release. To release the parking brake:

1. Start the vehicle.
2. Press the brake pedal.
3. Move the gearshift from the P (Park) position to one of the forward gears (the parking brake will not release automatically when you shift into reverse). The brake pedal must remain pressed while the gearshift is moved.

If the parking brake fails to release after completing this procedure, use the manual parking brake release lever.

Pull the lever to manually release the parking brake.

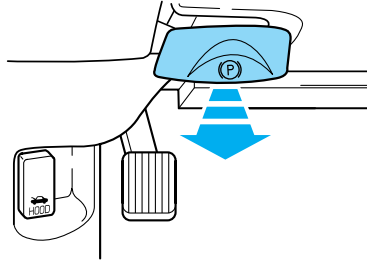

TRACTION CONTROL™

For Traction Control™ warning lights refer to *Warning Lights* in the *Instrument cluster* chapter.

Your vehicle is equipped with a Traction Control™ system (except on commercial conversion packages). This system helps you maintain the stability and steerability of your vehicle, especially on slippery road surfaces such as snow- or ice-covered roads and gravel roads. The system will allow your vehicle to make better use of available traction in these conditions.

During Traction Control™ operation, you may hear an electric motor type of sound coming from the engine compartment and the engine will not “rev-up” when you push further on the accelerator. This is normal system behavior and should be no reason for concern.

The Traction Control™ switch, located on the left side of the instrument panel, allows the driver to enable and disable the system. The Traction Control™ system will automatically turn on every time the ignition is turned OFF and RUN.



If you should become stuck in snow or ice or on a very slippery road surface, try switching the Traction Control™ system off. This may allow excess wheel spin to “dig” the vehicle out and enable a successful “rocking” maneuver.

Driving



Aggressive driving in any road conditions can cause you to lose control of your vehicle increasing the risk of severe personal injury or property damage. The occurrence of a Traction Control[®] event is an indication that at least some of the tires have exceeded their ability to grip the road; this may lead to an increased risk of loss of vehicle control, vehicle rollover, personal injury and death. If you experience a severe road event, SLOW DOWN.

STEERING

To prevent damage to the power steering system, never hold the steering wheel at its furthest turning points (until it stops) for more than a few seconds when the engine is running.

It is also important to maintain a proper power steering fluid level in the power steering fluid reservoir:

- Do not operate the vehicle with a low power steering pump fluid level (below the MIN mark on the reservoir).
- Some noise is normal during operation. If the noise is excessive, check for low power steering pump fluid level before seeking service by your dealer.
- Heavy or uneven steering efforts may be caused by low power steering pump fluid level. Check for low power steering pump fluid level before seeking service by your dealer.
- Do not fill the power steering pump reservoir above the MAX mark on the reservoir, as this may result in leaks from the reservoir.

If the power steering system breaks down (or if the engine is turned off), you can steer the vehicle manually, but it takes more effort.

If the steering wanders or pulls, check for:

- an improperly inflated tire
- uneven tire wear
- loose or worn suspension components
- loose or worn steering components
- improper steering alignment

Speed sensitive steering

The steering in your vehicle is speed sensitive. At high speeds, steering assist will decrease to improve steering feel. At lower speeds, maneuverability will be increased.

Driving

If the amount of effort required to steer your vehicle changes while driving at a constant vehicle speed, have the power steering system checked by your dealer or a qualified service technician.

AIR SUSPENSION SYSTEM

The air suspension system is designed to improve ride, handling and general vehicle performance during:

- Certain road conditions
- Steering maneuvers
- Braking
- Accelerations

This system keeps the rear of your vehicle at a constant level by automatically adding air or releasing air from the springs.

If you exceed the load limit, the rear air suspension may not operate.

The air suspension shut-off switch is located on the left side of the trunk. If this switch is in the OFF position, the rear air suspension will not operate.

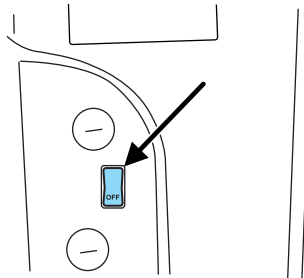

 On vehicles equipped with Air Suspension, turn OFF the Air Suspension switch prior to jacking, hoisting or towing your vehicle.

Normal vehicle operation does not require any action by the driver.

AUTOMATIC TRANSMISSION OPERATION

Brake-shift interlock

This vehicle is equipped with a brake-shift interlock feature that prevents the gearshift lever from being moved from P (Park) when the ignition is in the ON position unless brake pedal is depressed.

If you cannot move the gearshift lever out of P (Park) with ignition in the ON position and the brake pedal depressed, it is possible that a fuse has blown or the vehicle's brakelamps are not operating properly. Refer to *Fuses and relays* in the *Roadside Emergencies* chapter.

Driving

If the fuse is not blown, perform the following procedure:

1. Apply the parking brake, turn the ignition to 2 (ACC).
2. Locate the access plug on the underside of the steering column cover.

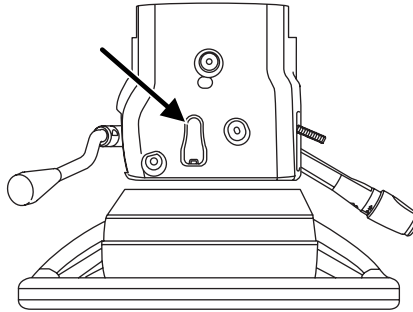

3. Remove the access plug using a flat head screwdriver, then push and hold the override button using a flat head screwdriver. Apply the brake pedal and shift the transmission into N (Neutral) while continuing to depress the override button.

4. Reinstall the access plug cover, start the vehicle and release the parking brake.



Do not drive your vehicle until you verify that the brakelamps are working.



Always set the parking brake fully and make sure the gearshift is latched in P (Park). Turn the ignition to the OFF/LOCK position and remove the key whenever you leave your vehicle.



If the parking brake is fully released, but the brake warning lamp remains illuminated, the brakes may not be working properly. See your dealer or a qualified service technician.

Driving with a 4-speed automatic transmission

Understanding the gearshift positions of the 4-speed automatic transmission



P (Park)

This position locks the transmission and prevents the rear wheels from turning.

To put your vehicle in gear:

- Start the engine
- Depress the brake pedal
- Move the gearshift lever into the desired gear

To put your vehicle in P (Park):

- Come to a complete stop
- Move the gearshift lever and securely latch it in P (Park)



Always set the parking brake fully and make sure the gearshift is latched in P (Park). Turn the ignition to the LOCK position and remove the key whenever you leave your vehicle.

R (Reverse)

With the gearshift lever in R (Reverse), the vehicle will move backward. Always come to a complete stop before shifting into and out of R (Reverse).

N (Neutral)

With the gearshift lever in N (Neutral), the vehicle can be started and is free to roll. Hold the brake pedal down while in this position.

Driving

D (Overdrive)

The normal driving position for the best fuel economy. Transmission operates in gears one through four.



Overdrive can be deactivated by pressing the transmission control switch on the gearshift lever.

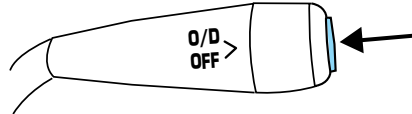

The transmission control indicator light (TCIL) will illuminate on the instrument cluster.

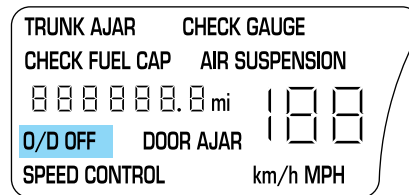

Drive (not shown)

Drive is activated when the transmission control switch is pressed.

- This position allows for all forward gears except overdrive.
- O/D OFF lamp is illuminated.
- Provides engine braking.
- Use when driving conditions cause excessive shifting from O/D to other gears. Examples: city traffic, hilly terrain, heavy loads, trailer towing and when engine braking is required.
- To return to O/D (overdrive mode), press the transmission control switch. The O/D OFF lamp will not be illuminated.
- O/D (Overdrive) is automatically returned each time the key is turned off.

2 (Second)

This position allows for second gear only.

- Provides engine braking.
- Use to start-up on slippery roads.
- To return to **D** (Overdrive), move the gearshift lever into the **D** (Overdrive) position.
- Selecting 2 (Second) at higher speeds will cause the transmission to downshift to second gear at the appropriate vehicle speed.

1 (First)

- Provides maximum engine braking.
- Allows upshifts by moving gearshift lever.
- Will not downshift into 1 (First) at high speeds; allows for 1 (First) when vehicle reaches slower speeds.

Forced downshifts

- Allowed in **D** (Overdrive) or Drive.
- Depress the accelerator to the floor.
- Allows transmission to select an appropriate gear.

If your vehicle gets stuck in mud or snow

If your vehicle gets stuck in mud or snow, it may be rocked out by shifting between forward and reverse gears, stopping between shifts in a steady pattern. Press lightly on the accelerator in each gear.

If necessary, try turning the Traction Control[™] system off. This will allow the wheels to spin, which may help to free your stuck vehicle. For more information, refer to *Traction Control[™] (if equipped)* in this chapter.

Do not rock the vehicle if the engine is not at normal operating temperature or damage to the transmission may occur.

Do not rock the vehicle for more than a minute or damage to the transmission and tires may occur, or the engine may overheat.

TRACTION-LOK AXLE (IF EQUIPPED)

This axle provides added traction on slippery surfaces, particularly when one wheel is on a poor traction surface. Under normal conditions, the Traction-Lok axle functions like a standard rear axle. The axle may exhibit a slight noise or vibration in tight turns with low vehicle speed. This is normal behavior and indicates the axle is working.

Driving

REVERSE SENSING SYSTEM

The extended rear park aid system sounds a tone to warn the driver of obstacles near the rear bumper when the R (Reverse) gear is selected.



To help avoid personal injury, please read and understand the limitations of the extended rear park assist system as contained in this section. The park assist is only an aid for some (generally large and fixed) objects when moving in reverse on a flat surface at “parking speeds”. Inclement weather may also affect the function of the RSS; this may include reduced performance or a false activation.



To help avoid personal injury, always use caution when in R (Reverse) and when using the extended rear park aid.



This system is not designed to prevent contact with small or moving objects. The system is designed to provide a warning to assist the driver in detecting objects to avoid damaging the vehicle. The system may not detect smaller objects, particularly those close to the ground.



Certain add-on devices such as large trailer hitches, bike or surfboard racks and any device that may block the normal detection zone of the extended rear park aid system may create false beeps.

The system will assist the driver in detecting certain objects while the vehicle slowly moves in reverse at speeds less than 6 mph (10 km/h). The system is not effective at speeds greater than 6 mph (10 km/h) and may not detect certain angular or moving objects.

Driving



The system detects obstacles within approximately 16 feet (five meters), at speeds above 2 mph (3 km/h) behind the rear bumper with a decreased coverage area at the outer corners of the bumper. If vehicle speed is below 2 mph (3 km/h), the system detects obstacles within approximately 10 feet (three meters) behind the rear bumper with a decreased coverage area at the outer corners of the bumper. In the figure, the smaller objects behind the vehicle represent the near-vehicle and bumper corner coverage area of the park aid system and the large object represents the extended coverage area. As you move closer to the obstacle, the rate of the tone increases. When the distance to the obstacle is less than 18 inches (45.0 cm), the tone will sound continuously. If the system detects an object that is approaching the vehicle at such a rate that rapid braking is required, a very high rate tone will sound. If this tone is heard while reversing, the driver is advised to slow down immediately until the tone either changes to a slower rate or stops.

The extended rear park aid is automatically enabled when the gear selector is placed in R (Reverse) and the ignition is ON. A park aid control allows the driver to disable the extended rear park aid only when the ignition is ON, and the gear selector is in R (Reverse).

The OFF indicator remains illuminated when the system is disabled. The system defaults to ON every time the ignition is turned on. Press the control to disable or enable the system.

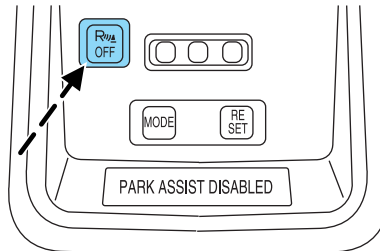

Driving

The indicator will remain illuminated to indicate a failure of the extended rear park aid.

Always keep the sensors (located on the rear bumper/fascia) free from snow, ice and large accumulations of dirt (do not clean the sensors with sharp objects). These elements may cause the system to operate inaccurately.

If the vehicle sustains damage to the rear bumper/fascia, leaving it misaligned or bent, the sensing zone may be altered causing inaccurate measurement of obstacles or false alarms.

DRIVING THROUGH WATER

If driving through deep or standing water is unavoidable, proceed very slowly especially when the depth is not known. Never drive through water that is higher than the bottom of the hubs (for trucks) or the bottom of the wheel rims (for cars). When driving through water, traction or brake capability may be limited. Also, water may enter your engine's air intake and severely damage your engine or your vehicle may stall. **Driving through deep water where the transmission vent tube is submerged may allow water into the transmission and cause internal transmission damage.**

Once through the water, always dry the brakes by moving your vehicle slowly while applying light pressure on the brake pedal.

Wet brakes do not stop the vehicle as quickly as dry brakes.

Roadside Emergencies

GETTING ROADSIDE ASSISTANCE

To fully assist you should you have a vehicle concern, Ford Motor Company offers a complimentary roadside assistance program. This program is separate from the New Vehicle Limited Warranty. The service is available:

- 24-hours, seven days a week
- for the New Vehicle Limited Warranty period of three years or 36,000 miles (60,000 km), whichever occurs first on Ford and Mercury vehicles, and four years or 50,000 miles (80,000 km) on Lincoln vehicles.

Roadside assistance will cover:

- a flat tire change with a good spare (except Ford GT which has a tire inflation kit)
- battery jump start
- lock-out assistance (key replacement cost is the customer's responsibility)
- fuel delivery (2.0 gallons [7.5L], maximum two occurrences within 12 month period)
- towing of your disabled vehicle to the nearest Ford Motor Company dealership, or your selling dealer if within 35 miles (56.3 km) of the nearest Ford Motor Company dealership (one tow per disablement). Even non-warranty related tows, like accidents, are covered (some exclusions apply, such as impound towing or repossession).

Canadian customers refer to your Owner Information Guide for information on:

- coverage period
- exact fuel amounts
- towing of your disabled vehicle
- emergency travel expense reimbursement
- travel planning benefits

USING ROADSIDE ASSISTANCE

Complete the roadside assistance identification card and place it in your wallet for quick reference. In the United States, this card is found in the Owner Guide portfolio in the glove compartment. In Canada, the card is found in the *Owner Information Guide* in the glove compartment.

U.S. Ford or Mercury vehicle customers who require roadside assistance, call 1-800-241-3673; Lincoln vehicle customers call 1-800-521-4140.

Roadside Emergencies

Canadian customers who require roadside assistance, call 1-800-665-2006.

If you need to arrange roadside assistance for yourself, Ford Motor Company will reimburse a reasonable amount. To obtain reimbursement information, U.S. Ford or Mercury vehicles customers call 1-800-241-3673; Lincoln vehicle customers call 1-800-521-4140.

Canadian customers who need to obtain reimbursement information, call 1-800-665-2006.

ROADSIDE COVERAGE BEYOND BASIC WARRANTY

In the United States, you may purchase additional roadside assistance coverage beyond this period through the Ford Auto Club by contacting your Ford or Lincoln Mercury dealer.

Similarly in Canada, for uninterrupted Roadside Assistance coverage, you may purchase extended coverage prior to your Basic Warranty's Roadside Assistance expiring. For more information and enrollment, contact 1-877-294-2582 or visit our website at www.ford.ca.

HAZARD FLASHER

The hazard flasher is located on the steering column, just behind the steering wheel. The hazard flashers will operate when the ignition is in any position or if the key is not in the ignition.

Push in the flasher control and all front and rear direction signals will flash. Press the flasher control again to turn them off. Use it when your vehicle is disabled and is creating a safety hazard for other motorists.

Note: With extended use, the flasher may run down your battery.

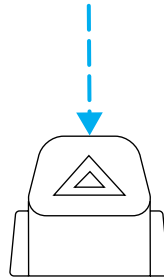

FUEL PUMP SHUT-OFF SWITCH FUEL RESET

The fuel pump shut-off switch is a device intended to stop the electric fuel pump when your vehicle has been involved in a substantial jolt.

After a collision, if the engine cranks but does not start, the fuel pump shut-off switch may have been activated.

252

Roadside Emergencies

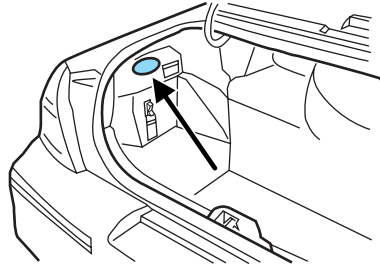

The fuel pump shut-off switch is located on a bracket inside of the luggage compartment.

Use the following procedure to reset the fuel pump shut-off switch.

1. Turn the ignition to the OFF position.
2. Check the fuel system for leaks.
3. If no fuel leak is apparent, reset the fuel pump shut-off switch by pushing in on the reset button.
4. Turn the ignition to the ON position. Pause for a few seconds and return the key to the OFF position.
5. Make a further check for leaks in the fuel system.

FUSES AND RELAYS

Fuses

If electrical components in the vehicle are not working, a fuse may have blown. Blown fuses are identified by a broken wire within the fuse. Check the appropriate fuses before replacing any electrical components.

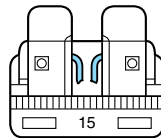

Note: Always replace a fuse with one that has the specified amperage rating. Using a fuse with a higher amperage rating can cause severe wire damage and could start a fire.

Roadside Emergencies

Standard fuse amperage rating and color

COLOR					
Fuse rating	Mini fuses	Standard fuses	Maxi fuses	Cartridge maxi fuses	Fuse link cartridge
2A	Grey	Grey	—	—	—
3A	Violet	Violet	—	—	—
4A	Pink	Pink	—	—	—
5A	Tan	Tan	—	—	—
7.5A	Brown	Brown	—	—	—
10A	Red	Red	—	—	—
15A	Blue	Blue	—	—	—
20A	Yellow	Yellow	Yellow	Blue	Blue
25A	Natural	Natural	—	—	—
30A	Green	Green	Green	Pink	Pink
40A	—	—	Orange	Green	Green
50A	—	—	Red	Red	Red
60A	—	—	Blue	—	Yellow
70A	—	—	Tan	—	Brown
80A	—	—	Natural	—	Black

Passenger compartment fuse panel

The fuse panel is located below and to the left of the steering wheel by the brake pedal. Remove the panel cover to access the fuses.

To remove a fuse use the fuse puller tool provided on the fuse panel cover.

Roadside Emergencies

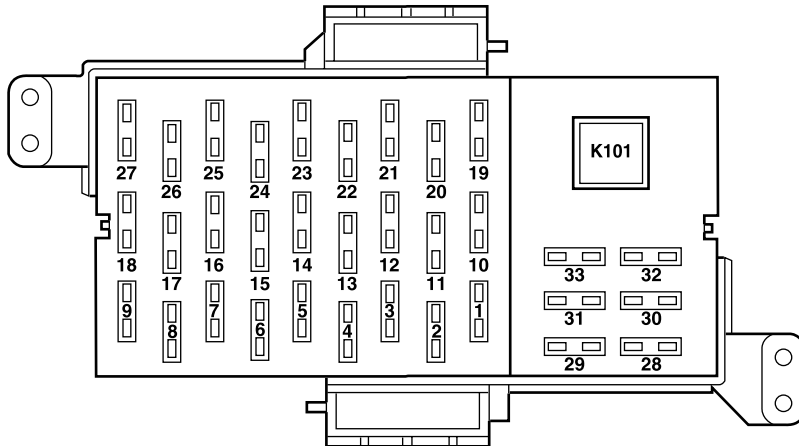

The fuses are coded as follows.

Fuse/Relay Location	Fuse Amp Rating	Passenger Compartment Fuse Panel Description
1	10A	Starter relay coil
2	10A	Restraint Control Module (RCM), Occupant Classification Sensor (OCS), Passenger Air bag Deactivation Indicator (PADI)
3	10A	Audio, Navigation control head
4	10A	Back-up lamps
5	10A	Audio
6	10A	Passive Anti-Theft System (PATS), Powertrain Control Module (PCM) relay coil, Ignition coil relay coil, Fuel relay coil
7	10A	Wiper module

Roadside Emergencies

Fuse/Relay Location	Fuse Amp Rating	Passenger Compartment Fuse Panel Description
8	10A	Power Decklid Module (PDM), Lighting Control Module (LCM), Overdrive cancel switch, Cluster, Rear defroster relay coil
9	7.5A	Mirror switch illumination, Door lock switch illumination, Rear audio control, Heated seat switch illumination, LCM, Electrochromatic mirror, Overhead console
10	15A	Hazards
11	10A	Rear Air Suspension Module (RASM)
12	10A	LCM (Illumination)
13	10A	Cluster, Extended rear park aide module
14	15A	Adjustable pedals
15	10A	Dual Automatic Temperature Control (DATC) module
16	20A	Cigar lighter, OBD II
17	10A	Anti-lock Brake System (ABS) module, Positive Crankcase Ventilation (PCV)
18	15A	LCM (Interior lighting)
19	10A	Driver's Door Module (DDM) switches, PDM, Power mirrors, DSM
20	10A	LCM (Right-hand low beam)
21	10A	PATS LED, Cluster, Analog clock, Overhead console
22	10A	LCM (Left-hand low beam)
23	10A	LCM

Roadside Emergencies

Fuse/Relay Location	Fuse Amp Rating	Passenger Compartment Fuse Panel Description
24	15A	LCM (High beams), Multi-function switch (Flash-to-pass)
25	10A	Brake-Transmission Shift Interlock (BTSI), Stop switch signal feed, Speed control deactivation switch
26	15A	LCM (Park lamps, cornering lamps)
27	10A	DATC module
28	10A	Center High-Mounted Stop Lamp (CHMSL)
29	15A	Turn signals
30	15A	Stop lamps
31	10A	A/C cycle switch, Heated seats module
32	10A	Mirror heaters
33	15A	Audio, Navigation
K101	—	Rear defroster relay

Power distribution box

The power distribution box is located in the engine compartment. The power distribution box contains high-current fuses that protect your vehicle's main electrical systems from overloads.



Always disconnect the battery before servicing high current fuses.



To reduce risk of electrical shock, always replace the cover to the Power Distribution Box before reconnecting the battery or refilling fluid reservoirs.

If the battery has been disconnected and reconnected, refer to the *Battery* section of the *Maintenance and Specifications* chapter.

Roadside Emergencies

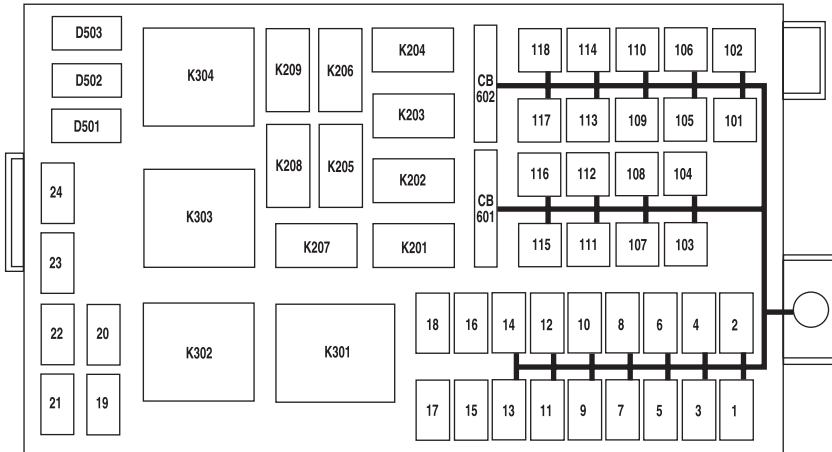

The high-current fuses are coded as follows.

Fuse/Relay Location	Fuse Amp Rating	Power Distribution Box Description
1	20A*	Ignition switch (Key in, RUN 1, RUN 2)
2	25A*	Ignition switch (RUN/START, RUN/ACC, START)
3	10A*	Powertrain Control Module (PCM) keep alive power
4	20A*	Fuel relay feed
5	20A*	Instrument panel power point
6	15A*	Alternator regulator
7	30A*	PCM relay feed
8	20A*	Driver's Door Module (DDM)
9	15A*	Ignition coil relay feed
10	20A*	Horn relay feed
11	15A*	A/C clutch relay feed
12	20A*	Audio

Roadside Emergencies

Fuse/Relay Location	Fuse Amp Rating	Power Distribution Box Description
13	20A*	Instrument panel fuse box feed #3
14	20A*	Stop lamp switch
15	15A*	Lumbar, Fuel door
16	20A*	Heated seats
17	–	Not used
18	–	Not used
19	15A*	Injectors
20	15A*	PCM, Mass Air Flow (MAF) sensor
21	15A*	Powertrain loads and sensors
22	10A*	Rear Air Suspension Module (RASM)
23	10A*	Delayed accessory (Moonroof, audio and navigation system)
24	–	Not used
101	40A**	Blower relay feed
102	50A**	Cooling fan
103	50A**	Instrument panel fuse box feed #1
104	40A**	Instrument panel fuse box feed #2
105	30A**	Starter relay feed
106	40A**	ABS module (Pump)
107	40A**	Rear defroster relay feed
108	40A**	Power Decklid Module (PDM)
109	20A**	ABS module (Valves)
110	30A**	Wiper module
111	20A**	Rear power point #1
112	30A**	RASM (Air compressor)
113	20A**	Rear power point #2
114	20A**	Moonroof
115	20A**	Rear cigar lighters
116	30A**	Pulldown module

Roadside Emergencies

Fuse/Relay Location	Fuse Amp Rating	Power Distribution Box Description
117	30A**	Driver seat module
118	20A**	Rear heated seats
K201	Micro relay	A/C clutch
K202	—	Not used
K203	Micro relay	Ignition coil
K204	Micro relay	PCM
K205	—	Not used
K206	Micro relay	Fuel
K207	—	Not used
K208	—	Not used
K209	Micro relay	Horn
K301	Mini relay	Starter
K302	Mini relay	RASM (Air compressor)
K303	Mini relay	Blower
K304	Mini relay	Delayed accessory
D501	Diode	A/C clutch
D502	Diode	Reverse battery
D503	Diode	Horn, Door latch
CB601	20A Circuit Breaker	Power seats
CB602	20A Circuit Breaker	Delayed accessory relay for windows, moonroof, audio and navigation system

* Mini Fuses ** Cartridge Fuses

JUMP STARTING YOUR VEHICLE



The gases around the battery can explode if exposed to flames, sparks, or lit cigarettes. An explosion could result in injury or vehicle damage.



Batteries contain sulfuric acid which can burn skin, eyes and clothing, if contacted.

Roadside Emergencies

Do not attempt to push-start your vehicle. Automatic transmissions do not have push-start capability; doing so may damage the catalytic converter.

Preparing your vehicle

When the battery is disconnected or a new battery is installed, the transmission must relearn its shift strategy. As a result, the transmission may have firm and/or soft shifts. This operation is considered normal and will not affect function or durability of the transmission. Over time, the adaptive learning process will fully update transmission operation.

1. **Use only a 12-volt supply to start your vehicle.**
2. Do not disconnect the battery of the disabled vehicle as this could damage the vehicle's electrical system.
3. Park the booster vehicle close to the hood of the disabled vehicle making sure the two vehicles **do not** touch. Set the parking brake on both vehicles and stay clear of the engine cooling fan and other moving parts.
4. Check all battery terminals and remove any excessive corrosion before you attach the battery cables. Ensure that vent caps are tight and level.
5. Turn the heater fan on in both vehicles to protect any electrical surges. Turn all other accessories off.

Connecting the jumper cables

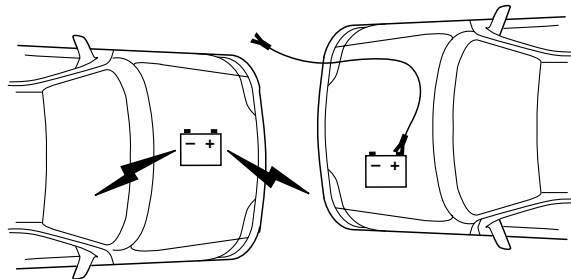

1. Connect the positive (+) jumper cable to the positive (+) terminal of the discharged battery.

Note: In the illustrations, *lightning bolts* are used to designate the assisting (boosting) battery.

Roadside Emergencies

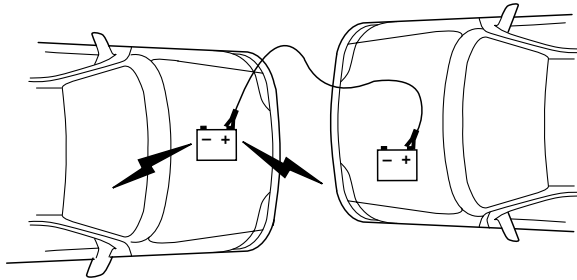

2. Connect the other end of the positive (+) cable to the positive (+) terminal of the assisting battery.

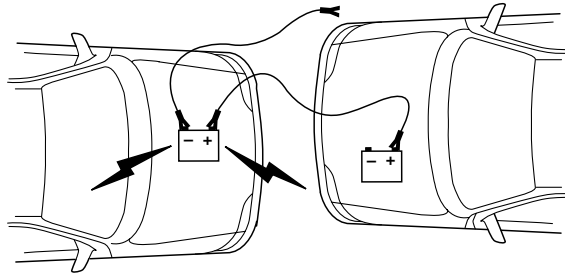

3. Connect the negative (-) cable to the negative (-) terminal of the assisting battery.

Roadside Emergencies

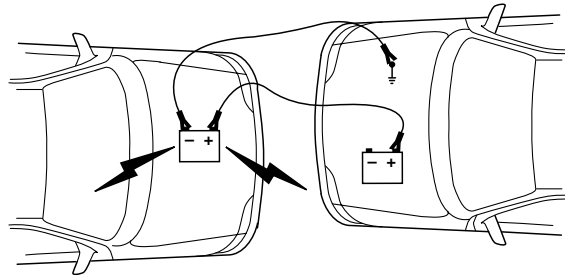

4. Make the final connection of the negative (-) cable to an exposed metal part of the stalled vehicle's engine, away from the battery and the carburetor/fuel injection system. **Do not** use fuel lines, engine rocker covers or the intake manifold as *grounding* points.



Do not connect the end of the second cable to the negative (-) terminal of the battery to be jumped. A spark may cause an explosion of the gases that surround the battery.

5. Ensure that the cables are clear of fan blades, belts, moving parts of both engines, or any fuel delivery system parts.

Jump starting

1. Start the engine of the booster vehicle and run the engine at moderately increased speed.
2. Start the engine of the disabled vehicle.
3. Once the disabled vehicle has been started, run both engines for an additional three minutes before disconnecting the jumper cables.

Roadside Emergencies

Removing the jumper cables

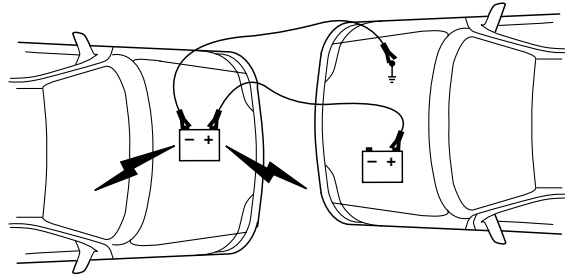

Remove the jumper cables in the reverse order that they were connected.

1. Remove the jumper cable from the *ground* metal surface.

Note: In the illustrations, *lightning bolts* are used to designate the assisting (boosting) battery.

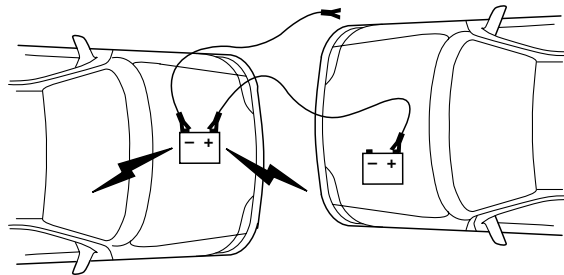

2. Remove the jumper cable on the negative (-) connection of the booster vehicle's battery.

Roadside Emergencies

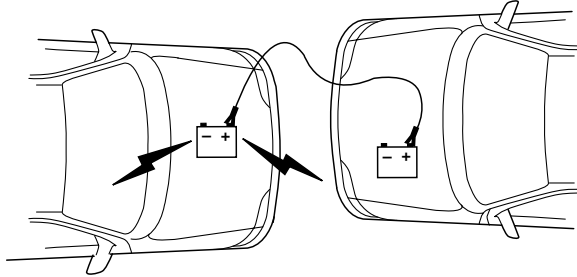

3. Remove the jumper cable from the positive (+) terminal of the booster vehicle's battery.

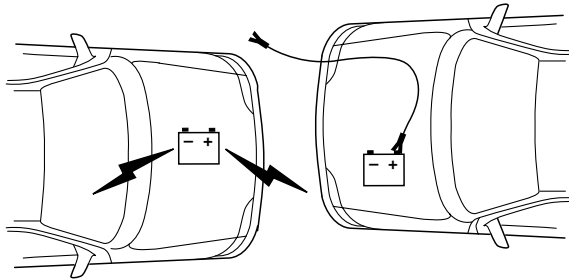

4. Remove the jumper cable from the positive (+) terminal of the disabled vehicle's battery.

After the disabled vehicle has been started and the jumper cables removed, allow it to idle for several minutes so the engine computer can *relearn* its idle conditions.

Roadside Emergencies

WRECKER TOWING

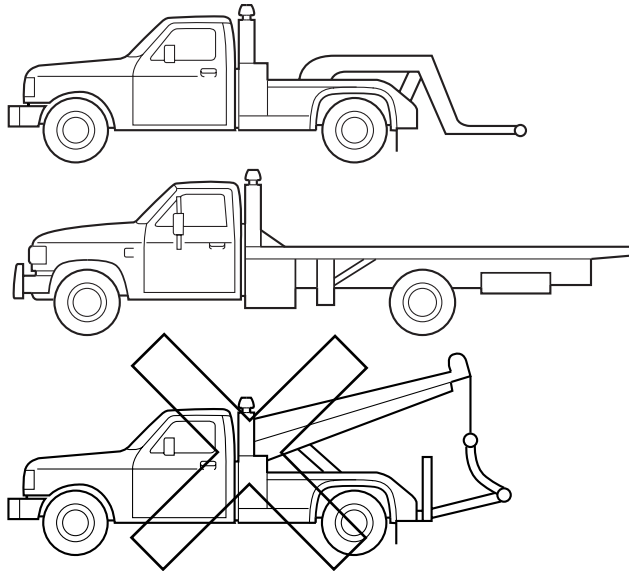

If you need to have your vehicle towed, contact a professional towing service or, if you are a member of a roadside assistance program, your roadside assistance service provider.

It is recommended that your vehicle be towed with a wheel lift or flatbed equipment. Do not tow with a slingbelt. Ford Motor Company has not approved a slingbelt towing procedure.

Before your vehicle can be towed, the air suspension control in the luggage compartment must be turned to the OFF position (if equipped).

If the vehicle is towed by other means or incorrectly, vehicle damage may occur.

Ford Motor Company produces a towing manual for all authorized tow truck operators. Have your tow truck operator refer to this manual for proper hook-up and towing procedures for your vehicle.

Customer Assistance

GETTING THE SERVICES YOU NEED

At home

You must take your Lincoln or Mercury vehicle to an authorized Lincoln Mercury dealer for warranty repairs. While any Ford or Lincoln Mercury dealership handling your vehicle line will provide warranty service, we recommend you return to your selling dealer who wants to ensure your continued satisfaction. Please note that certain warranty repairs require special training and/or equipment, so not all dealers are authorized to perform all warranty repairs. This means that, depending on the warranty repair needed, you may have to take your vehicle to another dealer. A reasonable time must be allowed to perform a repair after taking your vehicle to the dealership. Repairs will be made using Ford or Motorcraft parts, or remanufactured or other parts that are authorized by Ford.

If you have questions or concerns, or are unsatisfied with the service you are receiving, follow these steps:

1. Contact your Sales Representative or Service Advisor at your selling/servicing dealership.
2. If your inquiry or concern remains unresolved, contact the Sales Manager, Service Manager or Customer Relations Manager.
3. If you require assistance or clarification on Ford Motor Company policies or procedures, please contact the Lincoln Mercury Customer Relationship Center at 1-800-521-4140.

Away from home

If you own a Ford or Mercury vehicle and are away from home when your vehicle needs service, or if you need more help than the dealership could provide, after following the steps described above, contact the Ford Customer Relationship Center to find an authorized dealership to help you.

In the United States:

Ford Motor Company
Customer Relationship Center
P.O. Box 6248
Dearborn, MI 48121
1-800-392-3673 (FORD)
(TDD for the hearing impaired: 1-800-232-5952)
www.customersaskford.com

In Canada:

Customer Relationship Centre

Customer Assistance

Ford Motor Company of Canada, Limited
P.O. Box 2000
Oakville, Ontario L6J 5E4
1-800-565-3673 (FORD)
www.ford.ca

If you own a Lincoln vehicle and are away from home when your vehicle needs service, or if you need more help than the dealership could provide, after following the steps described above, contact the Ford Customer Relationship Center to find an authorized dealership to help you.

In the United States:
Ford Motor Company
Customer Relationship Center
P.O. Box 6248
Dearborn, MI 48121
1-800-521-4140
(TDD for the hearing impaired: 1-800-232-5952)
www.customersaskford.com

In Canada:
Lincoln Centre
Ford Motor Company of Canada, Limited
P.O. Box 2000
Oakville, Ontario L6J 5E4
1-800-387-9333
www.lincolncanada.com

In order to help you service your Lincoln vehicle, please have the following information available when contacting the Lincoln Centre:

- Your telephone number (home and business)
- The name of the dealer and the city where the dealership is located
- The year and make of your vehicle
- The date of vehicle purchase
- The current odometer reading
- The vehicle identification number (VIN)

Additional Assistance

If you still have a complaint involving a warranty dispute, you may wish to contact the Dispute Settlement Board (U.S.).

In some states (in the U.S.) you must directly notify Ford in writing before pursuing remedies under your state's warranty laws. Ford is also allowed a final repair attempt in some states.

268

2005 Town Car (tow)
Owners Guide (post-2002-fmt)
USA_English (fus)

Customer Assistance

In the United States, a warranty dispute must be submitted to the Dispute Settlement Board before taking action under the Magnuson-Moss Warranty Act, or to the extent allowed by state law, before pursuing replacement or repurchase remedies provided by certain state laws. This dispute handling procedure is not required prior to enforcing state created rights or other rights which are independent of the Magnuson-Moss Warranty Act or state replacement or repurchase laws.

IN CALIFORNIA (U.S. ONLY)

California Civil Code Section 1793.2(d) requires that, if a manufacturer or its representative is unable to repair a motor vehicle to conform to the vehicle's applicable express warranty after a reasonable number of attempts, the manufacturer shall be required to either replace the vehicle with one substantially identical or repurchase the vehicle and reimburse the buyer in an amount equal to the actual price paid or payable by the consumer (less a reasonable allowance for consumer use). The consumer has the right to choose whether to receive a refund or replacement vehicle.

California Civil Code Section 1793.22(b) presumes that the manufacturer has had a reasonable number of attempts to conform the vehicle to its applicable express warranties if, within the first 18 months of ownership of a new vehicle or the first 18,000 miles (29,000 km), whichever occurs first:

1. Two or more repair attempts are made on the same non-conformity likely to cause death or serious bodily injury OR
2. Four or more repair attempts are made on the same nonconformity (a defect or condition that substantially impairs the use, value or safety of the vehicle) OR
3. The vehicle is out of service for repair of nonconformities for a total of more than 30 calendar days (not necessarily all at one time)

In the case of 1 or 2 above, the consumer must also notify the manufacturer of the need for the repair of the nonconformity at the following address:

Ford Motor Company
16800 Executive Plaza Drive
Mail Drop 3NE-B
Dearborn, MI 48126

THE DISPUTE SETTLEMENT BOARD (U.S. ONLY)

The Dispute Settlement Board is:

- an independent, third-party arbitration program for warranty disputes.

Customer Assistance

- available free to owners and lessees of qualifying Ford Motor Company vehicles.

The Dispute Settlement Board may not be available in all states. Ford Motor Company reserves the right to change eligibility limitations, modify procedures and/or to discontinue this service without notice and without incurring obligations per applicable state law.

What kinds of cases does the Board review?

Unresolved warranty repair concerns or vehicle performance concerns as on Ford and Lincoln Mercury cars and Ford and Lincoln Mercury light trucks which are within the terms of any applicable written new vehicle warranty are eligible for review, except those involving:

- a non-Ford product
- a non-Ford dealership
- sales disputes between customer and dealer except those associated with warranty repairs or concerns with the vehicle's performance as designed
- a request for reimbursement of consequential expenses unless a service or product concern is being reviewed
- items not covered by the New Vehicle Limited Warranty (including maintenance and wear items)
- alleged personal injury/property damage claims
- cases currently in litigation
- vehicles not used primarily for family, personal or household purposes (except in states where the Dispute Settlement Board is required to review commercial vehicles)
- vehicles with non-U.S. warranties

Concerns are ineligible for review if the New Vehicle Limited Warranty has expired at receipt of your application and, in certain states eligibility is dependent upon the customer's possession of the vehicle.

Eligibility may differ according to state law. For example, see the unique brochures for California, West Virginia, Georgia and Wisconsin purchasers/lessees.

Board membership

The Board consists of:

- Three consumer representatives

270

2005 Town Car (tow)
Owners Guide (post-2002-fmt)
USA_English (fus)

Customer Assistance

- A Ford or Lincoln Mercury dealership representative

Consumer candidates for Board membership are recruited and trained by an independent consulting firm. The dealership Board member is chosen from Ford and Lincoln Mercury dealership management, recognized for their business leadership qualities.

What the Board needs

To have your case reviewed you must complete the application in the DSB brochure and mail it to the address provided on the application form. Some states will require you to use certified mail, with return receipt requested.

Your application is reviewed and, if it is determined to be eligible, you will receive an acknowledgment indicating:

- The file number assigned to your application.
- The toll-free phone number of the DSB's independent administrator.

Your dealership and a Ford Motor Company representative will then be asked to submit statements.

To properly review your case, the Board needs the following information:

- Legible copies of all documents and maintenance or repair orders relevant to the case.
- The year, make, model, and Vehicle Identification Number (VIN) listed on your vehicle ownership license.
- The date of repair(s) and mileage at the time of occurrence(s).
- The current mileage.
- The name of the dealer(s) who sold or serviced the vehicle.
- A brief description of your unresolved concern.
- A brief summary of the action taken by the dealer(s) and Ford Motor Company.
- The names (if known) of all the people you contacted at the dealership(s).
- A description of the action you expect to resolve your concern.

You will receive a letter of explanation if your application does not qualify for Board review.

Oral presentations

If you would like to make an oral presentation, indicate YES to question 6 on the application. While it is your right to make an oral presentation

Customer Assistance

before the Board, this is not a requirement and the Board will decide the case whether or not an oral presentation is made. An oral presentation may be requested by the Board as well.

Making a decision

Board members review all available information related to each complaint, including oral presentations, and arrive at a fair and impartial decision. Board review may be terminated at any time by either party.

Every effort is made to decide the case within 40 days of the date that all requested information is received by the Board. Since the Board generally meets once a month, it may take longer for the Board to consider some cases.

After a case is reviewed, the Board mails you a decision letter and a form on which to accept or reject the Board's decision. The decisions of the Board are binding on Ford (and, in some cases, on the dealer) but not on consumers who are free to pursue other remedies available to them under state or federal law.

To request a DSB Brochure/Application

For a brochure/application, speak to your dealer or write/call the Board at the following address/phone number:

Dispute Settlement Board
P.O. Box 1424
Waukesha, WI 53187-1424
1-800-428-3718

You may also contact the North American Customer Relationship Center at 1-800-392-3673 (Ford), TDD for the hearing impaired: 1-800-232-5952 or by writing to the Center at the following address:

Ford Motor Company
Customer Relationship Center
P.O. Box 6248
Dearborn, Michigan 48121

UTILIZING THE MEDIATION/ARBITRATION PROGRAM (CANADA ONLY)

In those cases where you continue to feel that the efforts by Ford of Canada and the dealer to resolve a factory-related vehicle service concern have been unsatisfactory, Ford of Canada participates in an impartial third party mediation/arbitration program administered by the Canadian Motor Vehicle Arbitration Plan (CAMVAP).

272

2005 Town Car (tow)
Owners Guide (post-2002-fmt)
USA_English (fus)

Customer Assistance

The CAMVAP program is a straight-forward and relatively speedy alternative to resolve a disagreement when all other efforts to produce a settlement have failed. This procedure is without cost to you and is designed to eliminate the need for lengthy and expensive legal proceedings.

In the CAMVAP program, impartial third-party arbitrators conduct hearings at mutually convenient times and places in an informal environment. These impartial arbitrators review the positions of the parties, make decisions and, when appropriate, render awards to resolve disputes. CAMVAP decisions are fast, fair, and final as the arbitrator's award is binding both to you and Ford of Canada.

CAMVAP services are available in all territories and provinces. For more information, without charge or obligation, call your CAMVAP Provincial Administrator directly at 1-800-207-0685.

FORD EXTENDED SERVICE PLAN

You can get more protection for your new car or light truck by purchasing Ford Extended Service Plan (Ford ESP) coverage. It provides the following:

- Benefits during the warranty period depending on the plan you purchase (such as: reimbursement for rentals; coverage for certain maintenance and wear items).
- Protection against covered repair costs after your Bumper-to-Bumper Warranty expires.

You may purchase Ford ESP from any participating Ford and Lincoln Mercury and Ford of Canada dealer. There are several plans available in various time, distance and deductible combinations which can be tailored to fit your own driving needs. Ford ESP also offers reimbursement benefits for towing and rental coverage.

When you buy Ford ESP, you receive Peace-of-Mind protection throughout the United States and Canada, provided by a network of more than 4,600 participating Ford or Lincoln Mercury and Ford of Canada dealers.

If you did not take advantage of the Ford Extended Service Plan at the time of purchasing your vehicle, you may still be eligible. Since this information is subject to change, please ask your dealer for complete details about Ford Extended Service Plan coverage options, or visit the Ford ESP website at www.ford-esp.com.

Customer Assistance

GETTING ASSISTANCE OUTSIDE THE U.S. AND CANADA

Before exporting your vehicle to a foreign country, contact the appropriate foreign embassy or consulate. These officials can inform you of local vehicle registration regulations and where to find unleaded fuel.

If you cannot find unleaded fuel or can only get fuel with an anti-knock index lower than is recommended for your vehicle, contact a regional office or owner relations/customer relationship office.

The use of leaded fuel in your vehicle without proper conversion may damage the effectiveness of your emission control system and may cause engine knocking or serious engine damage. Ford Motor Company/Ford of Canada is not responsible for any damage caused by use of improper fuel. Using leaded fuel may also result in difficulty importing your vehicle back into the U.S.

If your vehicle must be serviced while you are traveling or living in Central or South America, the Caribbean, or the Middle East, contact the nearest Ford dealership. If the dealership cannot help you, write or call:

FORD MOTOR COMPANY
WORLDWIDE DIRECT MARKET OPERATIONS
1555 Fairlane Drive
Fairlane Business Park #3
Allen Park, Michigan 48101
U.S.A.
Telephone: (313) 594-4857
FAX: (313) 390-0804

If you are in another foreign country, contact the nearest Ford dealership. If the dealership employees cannot help you, they can direct you to the nearest Ford affiliate office.

If you buy your vehicle in North America and then relocate outside of the U.S. or Canada, register your vehicle identification number (VIN) and new address with Ford Motor Company Worldwide Direct Market Operations.

ORDERING ADDITIONAL OWNER'S LITERATURE

To order the publications in this portfolio, contact Helm, Incorporated at:

HELM, INCORPORATED
P.O. Box 07150
Detroit, Michigan 48207

Or call:

For a free publication catalog, order toll free: 1-800-782-4356

274

2005 Town Car (tow)
Owners Guide (post-2002-fmt)
USA_English (fus)

Customer Assistance

Monday-Friday 8:00 a.m. - 6:00 p.m. EST

Helm, Incorporated can also be reached by their website:
www.helminc.com.

(Items in this catalog may be purchased by credit card, check or money order.)

Obtaining a French owner's guide

French Owner's Guides can be obtained from your dealer or by writing to Ford Motor Company of Canada, Limited, Service Publications, P.O. Box 1580, Station B, Mississauga, Ontario L4Y 4G3.

REPORTING SAFETY DEFECTS (U.S. ONLY)

If you believe that your vehicle has a defect which could cause a crash or could cause injury or death, you should immediately inform the National Highway Traffic Safety



Administration (NHTSA) in addition to notifying Ford Motor Company.

If NHTSA receives similar complaints, it may open an investigation, and if it finds that a safety defect exists in a group of vehicles, it may order a recall and remedy campaign. However, NHTSA cannot become involved in individual problems between you, your dealer, or Ford Motor Company.

To contact NHTSA, you may either call the Auto Safety Hotline toll-free at 1-800-424-9393 (or 366-0123 in the Washington D.C. area) or write to:

NHTSA
400 Seventh Street
U.S. Department of Transportation
Washington, D.C. 20590

You can also obtain other information about motor vehicle safety from the Hotline.

Cleaning

WASHING THE EXTERIOR

Wash your vehicle regularly with cool or lukewarm water and a neutral pH shampoo, such as Motorcraft Detail Wash (ZC-3-A), which is available from your dealer.

- Never use strong household detergents or soap, such as dish washing or laundry liquid. These products can discolor and spot painted surfaces.
- Never wash a vehicle that is “hot to the touch” or during exposure to strong, direct sunlight.
- Always use a clean sponge or car wash mitt with plenty of water for best results.
- Dry the vehicle with a chamois or soft terry cloth towel in order to eliminate water spotting.
- It is especially important to wash the vehicle regularly during the winter months, as dirt and road salt are difficult to remove and cause damage to the vehicle.
- Immediately remove items such as gasoline, diesel fuel, bird droppings and insect deposits because they can cause damage to the vehicle’s paintwork and trim over time.
- Remove any exterior accessories, such as antennas, before entering a car wash.
- **Suntan lotions and insect repellents can damage any painted surface; if these substances come in contact with your vehicle, wash off as soon as possible.**

WAXING

Applying Motorcraft Paint Sealant (ZC-45) to your vehicle every six months will assist in reducing minor scratches and paint damage.

- Wash the vehicle first.
- Do not use waxes that contain abrasives; use Motorcraft Premium Liquid Wax (ZC-53-A), which is available from your dealer, or an equivalent quality product.
- Do not allow paint sealant to come in contact with any non-body (low-gloss black) colored trim, such as grained door handles, roof racks, bumpers, side moldings, mirror housings or the windshield cowl area. The paint sealant will “gray” or stain the parts over time.

PAINT CHIPS

Your dealer has touch-up paint and sprays to match your vehicle’s color. Take your color code (printed on a sticker in the driver’s door jamb) to your dealer to ensure you get the correct color.

276

Cleaning

- Remove particles such as bird droppings, tree sap, insect deposits, tar spots, road salt and industrial fallout before repairing paint chips.
- Always read the instructions before using the products.

ALUMINUM WHEELS AND WHEEL COVERS

Aluminum wheels and wheel covers are coated with a clearcoat paint finish. In order to maintain their shine:

- Clean weekly with Motorcraft Wheel and Tire Cleaner (ZC-37-A), which is available from your dealer. Heavy dirt and brake dust accumulation may require agitation with a sponge. Rinse thoroughly with a strong stream of water.
- Never apply any cleaning chemical to hot or warm wheel rims or covers.
- Some automatic car washes may cause damage to the finish on your wheel rims or covers. Chemical-strength cleaners, or cleaning chemicals, in combination with brush agitation to remove brake dust and dirt, could wear away the clearcoat finish over time.
- Do not use hydrofluoric acid-based or high caustic-based wheel cleaners, steel wool, fuels or strong household detergent.
- To remove tar and grease, use Motorcraft Bug and Tar Remover (ZC-42), available from your dealer.

ENGINE

Engines are more efficient when they are clean because grease and dirt buildup keep the engine warmer than normal. When washing:

- Take care when using a power washer to clean the engine. The high-pressure fluid could penetrate the sealed parts and cause damage.
- Do not spray a hot engine with cold water to avoid cracking the engine block or other engine components.
- Spray Motorcraft Engine Shampoo and Degreaser (ZC-20) on all parts that require cleaning and pressure rinse clean.

Cleaning

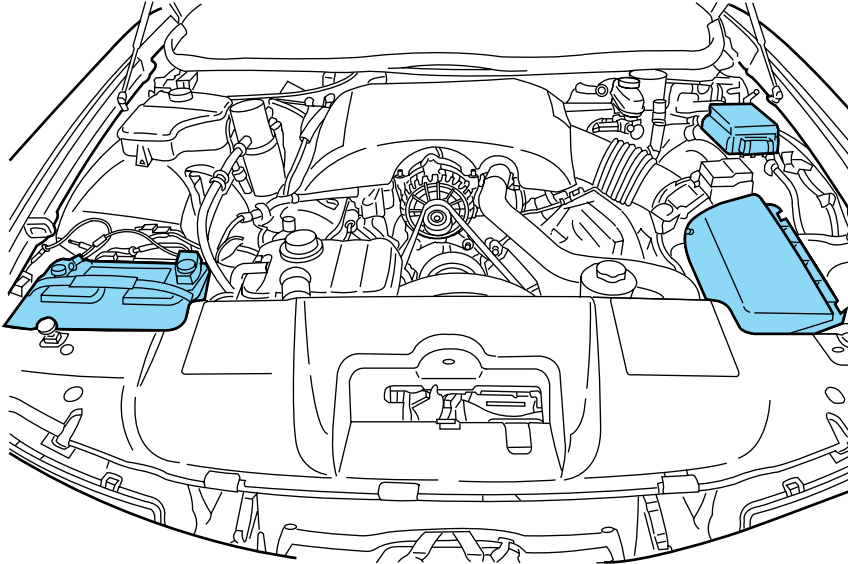

- Cover the highlighted areas to prevent water damage when cleaning the engine.
- Never wash or rinse the engine while it is running; water in the running engine may cause internal damage.

PLASTIC (NON-PAINTED) EXTERIOR PARTS

Use only approved products to clean plastic parts. These products are available from your dealer.

- For routine cleaning, use Motorcraft Detail Wash (ZC-3-A).
- If tar or grease spots are present, use Motorcraft Bug and Tar Remover (ZC-42).

WINDOWS AND WIPER BLADES

The windshield, rear and side windows and the wiper blades should be cleaned regularly. If the wipers do not wipe properly, substances on the vehicle's glass or the wiper blades may be the cause. These may include hot wax treatments used by commercial car washes, tree sap, or other organic contamination. To clean these items, please follow these tips:

- The windshield, rear windows and side windows may be cleaned with a non-abrasive cleaner such as Motorcraft Ultra-Clear Spray Glass Cleaner (ZC-23), available from your dealer.

Cleaning

- Do not use abrasives, as they may cause scratches.
- Do not use fuel, kerosene, or paint thinner to clean any parts.
- Wiper blades can be cleaned with isopropyl (rubbing) alcohol or windshield washer solution. Be sure to replace wiper blades when they appear worn or do not function properly.

Do not use sharp objects, such as a razor blade, to clean the inside of the rear window or to remove decals, as it may cause damage to the rear window defroster's heated grid lines.

INSTRUMENT PANEL AND CLUSTER LENS

Clean the instrument panel with a damp cloth, then with a clean, dry cloth, or use Motorcraft Dash & Vinyl Cleaner (ZC-38-A).

- Avoid cleaners or polish that increase the gloss of the upper portion of the instrument panel. The dull finish in this area helps protect the driver from undesirable windshield reflection.



Do not use chemical solvents or strong detergents when cleaning the steering wheel or instrument panel to avoid contamination of the air bag system.

- Be certain to wash or wipe your hands clean if you have been in contact with certain products such as insect repellent and suntan lotion in order to avoid possible damage to the interior painted surfaces.

INTERIOR

For fabric, carpets, cloth seats, safety belts and seats equipped with side air bags:

- Remove dust and loose dirt with a vacuum cleaner.
- Remove light stains and soil with Motorcraft Professional Strength Carpet & Upholstery Cleaner (ZC-54).
- If grease or tar is present on the material, spot-clean the area first with Motorcraft Spot and Stain Remover (ZC-14).
- Never saturate the seat covers with cleaning solution.
- Do not use household cleaning products or glass cleaners, which can stain and discolor the fabric and affect the flame retardant abilities of the seat materials.

Cleaning



Do not use cleaning solvents, bleach or dye on the vehicle's safety belts, as these actions may weaken the belt webbing.



Do not use chemical solvents or strong detergents when cleaning the seat-mounted side air bag. Such products could contaminate the side air bag system and affect performance of the side air bag in a collision.

LEATHER SEATS (IF EQUIPPED)

Your leather seating surfaces have a clear, protective coating over the leather.

- To clean, use a soft cloth with Motorcraft Deluxe Leather and Vinyl Cleaner (ZC-11-A). Dry the area with a soft cloth.
- To help maintain its resiliency and color, use the Motorcraft Deluxe Leather Care Kit (ZC-11-D), available from your authorized dealer.
- Do not use household cleaning products, alcohol solutions, solvents or cleaners intended for rubber, vinyl and plastics, or oil/petroleum-based leather conditioners. These products may cause premature wearing of the clear, protective coating.

Note: In some instances, color or dye transfer can occur when wet clothing comes in contact with leather upholstery. If this occurs, the leather should be cleaned immediately to avoid permanent staining.

UNDERBODY

Flush the complete underside of your vehicle frequently. Keep body and door drain holes free from packed dirt.

FORD AND LINCOLN MERCURY CAR CARE PRODUCTS

Your Ford or Lincoln Mercury dealer has many quality products available to clean your vehicle and protect its finishes. These quality products have been specifically engineered to fulfill your automotive needs; they are custom designed to complement the style and appearance of your vehicle. Each product is made from high quality materials that meet or exceed rigid specifications. For best results, use the following products or products of equivalent quality:

Motorcraft Bug and Tar Remover (ZC-42)

Motorcraft Car Care Kit (ZC-26)

280

Cleaning

Motorcraft Car Wash (Canada only) (CXC-21)
Motorcraft Custom Bright Metal Cleaner (ZC-15)
Motorcraft Custom Clear Coat Polish (ZC-8-A)
Motorcraft Custom Vinyl Protectant (U.S. only) (ZC-40-A)
Motorcraft Dash and Vinyl Cleaner (ZC-38-A)
Motorcraft Deluxe Leather and Vinyl Cleaner (U.S. only) (ZC-11-A)
Motorcraft Detail Wash (ZC-3-A)
Motorcraft Dusting Cloth (ZC-24)
Motorcraft Engine Shampoo and Degreaser (U.S. only) (ZC-20)
Motorcraft Engine Shampoo (Canada only) (CXC-66-A)
Motorcraft One Step Wash and Wax Concentrate (ZC-6-A)
Motorcraft Paint Sealant (ZC-45)
Motorcraft Premium Car Wash Concentrate (U.S. only) (ZC-17-B)
Motorcraft Premium Glass Cleaner (Canada only) (CXC-100)
Motorcraft Premium Liquid Wax (ZC-53-A)
Motorcraft Professional Strength Carpet & Upholstery Cleaner (ZC-54)
Motorcraft Spot and Stain Remover (U.S. only) (ZC-14)
Motorcraft Tire Clean and Shine (ZC-28)
Motorcraft Triple Clean (U.S. only) (ZC-13)
Motorcraft Ultra-Clear Spray Glass Cleaner (ZC-23)
Motorcraft Vinyl Cleaner (Canada only) (CXC-93)
Motorcraft Vinyl Conditioner (Canada only) (CXC-94)
Motorcraft Wheel and Tire Cleaner (ZC-37-A)

Maintenance and Specifications

SERVICE RECOMMENDATIONS

To help you service your vehicle:

- We highlight do-it-yourself items in the engine compartment for easy location.
- We provide *scheduled maintenance information* which makes tracking routine service easy.

If your vehicle requires professional service, your dealership can provide the necessary parts and service. Check your *Warranty Guide/Owner Information Guide* to find out which parts and services are covered.

Use only recommended fuels, lubricants, fluids and service parts conforming to specifications. Motorcraft parts are designed and built to provide the best performance in your vehicle.

PRECAUTIONS WHEN SERVICING YOUR VEHICLE

- Do not work on a hot engine.
- Make sure that nothing gets caught in moving parts.
- Do not work on a vehicle with the engine running in an enclosed space, unless you are sure you have enough ventilation.
- Keep all open flames and other burning (cigarettes) material away from the battery and all fuel related parts.

Working with the engine off

1. Set the parking brake and shift to P (Park).
2. Turn off the engine and remove the key.
3. Block the wheels.

Working with the engine on

1. Set the parking brake and shift to P (Park).
2. Block the wheels.

Note: Do not start your engine with the air cleaner removed and do not remove it while the engine is running.

Maintenance and Specifications

OPENING THE HOOD

1. Inside the vehicle, pull the hood release handle located under the instrument panel.

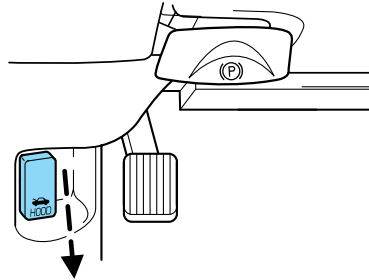

2. Go to the front of the vehicle and release the auxiliary latch that is located under the front of the hood in the grille.

3. Lift the hood until the lift cylinders hold it open.

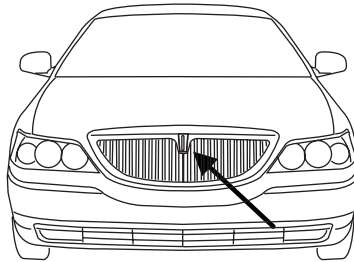

Maintenance and Specifications

IDENTIFYING COMPONENTS IN THE ENGINE COMPARTMENT

4.6L SOHC V8 engine

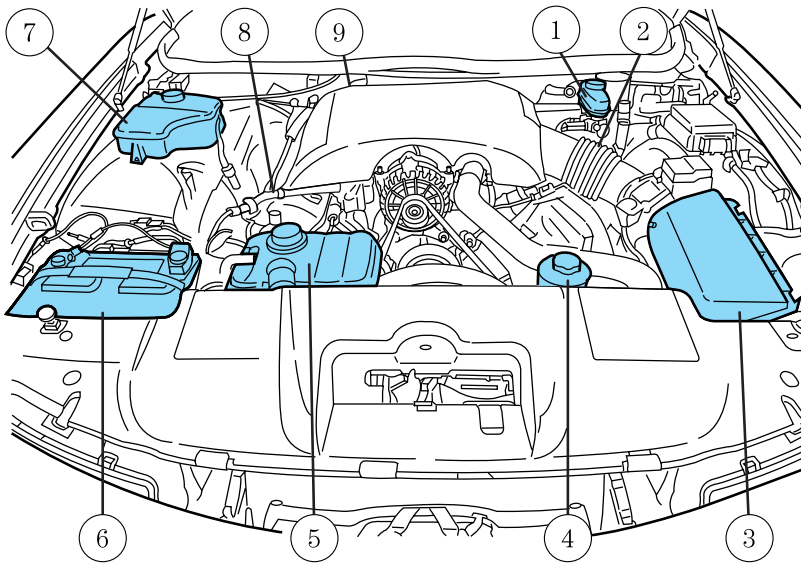

1. Brake fluid reservoir
2. Engine oil dipstick
3. Air filter assembly
4. Power steering fluid reservoir
5. Engine coolant reservoir
6. Battery
7. Windshield washer fluid reservoir
8. Engine oil filler cap
9. Automatic transmission fluid dipstick

Maintenance and Specifications

WINDSHIELD WASHER FLUID

Add fluid to fill the reservoir if the level is low. In very cold weather, do not fill the reservoir completely.

Only use a washer fluid that meets Ford specifications. Refer to *Refill capacities* in this chapter.

State or local regulations on volatile organic compounds may restrict the use of methanol, a common windshield washer antifreeze

additive. Washer fluids containing non-methanol antifreeze agents should be used only if they provide cold weather protection without damaging the vehicle's paint finish, wiper blades or washer system.

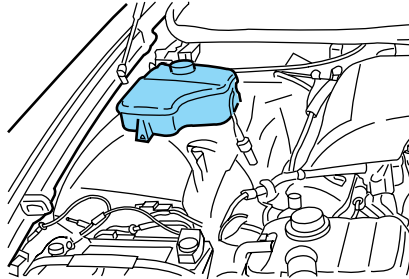

If you operate your vehicle in temperatures below 40° F (4.5°C), use washer fluid with antifreeze protection. Failure to use washer fluid with antifreeze protection in cold weather could result in impaired windshield vision and increase the risk of injury or accident.

Note: Do not put washer fluid in the engine coolant reservoir. Washer fluid placed in the cooling system may harm engine and cooling system components.

ENGINE OIL

Checking the engine oil

Refer to the *scheduled maintenance information* for the appropriate intervals for checking the engine oil.

1. Make sure the vehicle is on level ground.
2. Turn the engine off and wait up to 10 minutes for the oil to drain into the oil pan.
3. Set the parking brake and ensure the gearshift is securely latched in P (Park).
4. Open the hood. Protect yourself from engine heat.

Maintenance and Specifications

5. Locate and carefully remove the engine oil level indicator (dipstick).

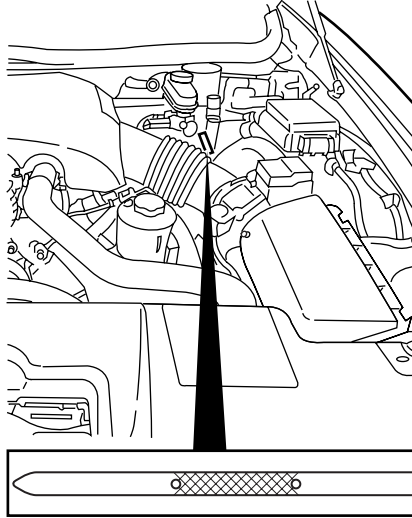

6. Wipe the indicator clean. Insert the indicator fully, then remove it again.

- If the oil level is **within this range**, the oil level is acceptable. **DO NOT ADD OIL.**

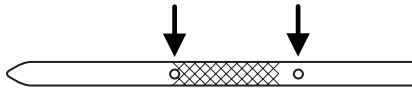

- If the oil level is **below this mark**, engine **oil must be added** to raise the level within the normal operating range.

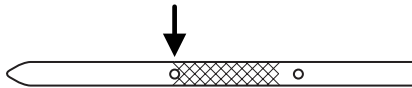

Maintenance and Specifications

- If required, add engine oil to the engine. Refer to *Adding engine oil* in this chapter.

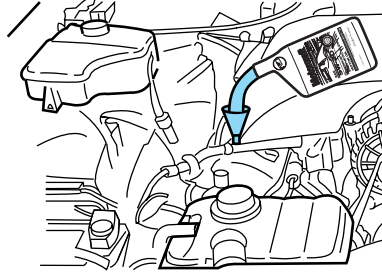

- **Do not overfill the engine with oil. Oil levels above this mark may cause engine damage.** If the engine is overfilled, some oil must be removed from the engine by a qualified service technician.

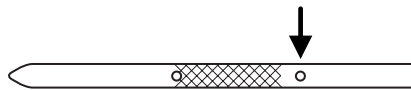

7. Put the indicator back in and ensure it is fully seated.

Adding engine oil

1. Check the engine oil. For instructions, refer to *Checking the engine oil* in this chapter.
2. If the engine oil level is not within the normal operating range, add only certified engine oil of the recommended viscosity. Remove the engine oil filler cap and use a funnel to pour the engine oil into the opening.
3. Recheck the engine oil level. Make sure the oil level is not above the normal operating range on the engine oil level indicator (dipstick).
4. Install the indicator and ensure it is fully seated.
5. Fully install the engine oil filler cap by turning the filler cap clockwise until three clicks can be heard.

To avoid possible oil loss, DO NOT operate the vehicle with the engine oil level indicator and/or the engine oil filler cap removed.

Maintenance and Specifications

Engine oil and filter recommendations

Look for this certification trademark.



Use SAE 5W-20 engine oil.

Only use oils “Certified For Gasoline Engines” by the American Petroleum Institute (API). An oil with this trademark symbol conforms to the current engine and emission system protection standards and fuel economy requirements of the International Lubricant Standardization and Approval Committee (ISLAC), comprised of U.S. and Japanese automobile manufacturers.

To protect your engine’s warranty use Motorcraft SAE 5W-20 or an equivalent 5W-20 oil meeting Ford specification WSS-M2C930-A. **SAE 5W-20 oil provides optimum fuel economy and durability performance meeting all requirements for your vehicle’s engine.**

Do not use supplemental engine oil additives, cleaners or other engine treatments. They are unnecessary and could lead to engine damage that is not covered by Ford warranty.

Change your engine oil and filter according to the appropriate schedule listed in *scheduled maintenance information*.

Ford production and aftermarket (Motorcraft) oil filters are designed for added engine protection and long life. If a replacement oil filter is used that does not meet Ford material and design specifications, start-up engine noises or knock may be experienced.

It is recommended you use the appropriate Motorcraft oil filter (or another brand meeting Ford specifications) for your engine application.

Maintenance and Specifications

BATTERY

Your vehicle is equipped with a Motorcraft maintenance-free battery which normally does not require additional water during its life of service.

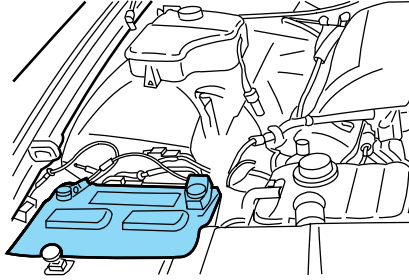

However, for severe usage or in high temperature climates, check the battery electrolyte level. Refer to *scheduled maintenance information* for the service interval schedules.

Keep the electrolyte level in each cell up to the “level indicator”. Do not overfill the battery cells.

If the electrolyte level in the battery is low, you can add plain tap water to the battery, as long as you do not use hard water (water with a high mineral or alkali content). If possible, however, try to only fill the battery cells with distilled water. If the battery needs water often, have the charging system checked.

If your battery has a cover/shield, make sure it is reinstalled after the battery has been cleaned or replaced.

For longer, trouble-free operation, keep the top of the battery clean and dry. Also, make certain the battery cables are always tightly fastened to the battery terminals.

If you see any corrosion on the battery or terminals, remove the cables from the terminals and clean with a wire brush. You can neutralize the acid with a solution of baking soda and water.

 Batteries normally produce explosive gases which can cause personal injury. Therefore, do not allow flames, sparks or lighted substances to come near the battery. When working near the battery, always shield your face and protect your eyes. Always provide proper ventilation.

Maintenance and Specifications



When lifting a plastic-cased battery, excessive pressure on the end walls could cause acid to flow through the vent caps, resulting in personal injury and/or damage to the vehicle or battery. Lift the battery with a battery carrier or with your hands on opposite corners.



Keep batteries out of reach of children. Batteries contain sulfuric acid. Avoid contact with skin, eyes or clothing. Shield your eyes when working near the battery to protect against possible splashing of acid solution. In case of acid contact with skin or eyes, flush immediately with water for a minimum of 15 minutes and get prompt medical attention. If acid is swallowed, call a physician immediately.



Battery posts, terminals and related accessories contain lead and lead compounds. **Wash hands after handling.**

Because your vehicle's engine is electronically controlled by a computer, some control conditions are maintained by power from the battery. When the battery is disconnected or a new battery is installed, the engine must relearn its idle and fuel trim strategy for optimum driveability and performance. To begin this process:

1. With the vehicle at a complete stop, set the parking brake.
2. Put the gearshift in P (Park), turn off all accessories and start the engine.
3. Run the engine until it reaches normal operating temperature.
4. Allow the engine to idle for at least one minute.
5. Turn the A/C on and allow the engine to idle for at least one minute.
6. Release the parking brake. With your foot on the brake pedal and with the A/C on, put the vehicle in D (Drive) and allow the engine to idle for at least one minute.
7. Drive the vehicle to complete the relearning process.
 - The vehicle may need to be driven 10 miles (16 km) or more to relearn the idle and fuel trim strategy.
 - **If you do not allow the engine to relearn its idle trim, the idle quality of your vehicle may be adversely affected until the idle trim is eventually relearned.**

If the battery has been disconnected or a new battery has been installed, the clock and radio settings must be reset once the battery is reconnected.

Maintenance and Specifications

- Always dispose of automotive batteries in a responsible manner. Follow your local authorized standards for disposal. Call your local authorized recycling center to find out more about recycling automotive batteries.

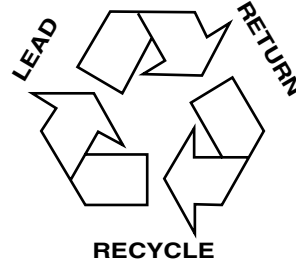

ENGINE COOLANT

Checking engine coolant

The concentration and level of engine coolant should be checked at the mileage intervals listed in *scheduled maintenance information*. The coolant concentration should be maintained at 50/50 coolant and distilled water, which equates to a freeze point of -34°F (-36°C). Coolant concentration testing is possible with a hydrometer or antifreeze tester (such as the Rotunda Battery and Antifreeze Tester, 014-R1060). The level of coolant should be maintained at the "FULL COLD" level or within the "COLD FILL RANGE" in the coolant reservoir. If the level falls below, add coolant per the instructions in the *Adding engine coolant* section.

Your vehicle was factory-filled with a 50/50 engine coolant and water concentration. If the concentration of coolant falls below 40% or above 60%, the engine parts could become damaged or not work properly. **A 50–50 mixture of coolant and water provides the following:**

- **Freeze protection down to -34°F (-36°C).**
- **Boiling protection up to 265°F (129°C).**
- **Protection against rust and other forms of corrosion.**
- **Enables calibrated gauges to work properly.**

Maintenance and Specifications

When the engine is cold, check the level of the engine coolant in the reservoir.

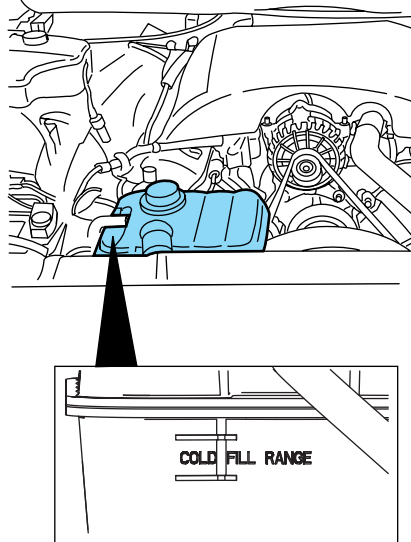

- The engine coolant should be at the “FULL COLD” level or within the “COLD FILL RANGE” as listed on the engine coolant reservoir (depending upon application).
- Refer to *scheduled maintenance information* for service interval schedules.
- Be sure to read and understand *Precautions when servicing your vehicle* in this chapter.

If the engine coolant has not been checked at the recommended interval, the engine coolant reservoir may become low or empty. If the reservoir is low or empty, add engine coolant to the reservoir. Refer to *Adding engine coolant* in this chapter.

Note: Automotive fluids are not interchangeable; do not use engine coolant, antifreeze or windshield washer fluid outside of its specified function and vehicle location.

Adding engine coolant

When adding coolant, make sure it is a 50/50 mixture of engine coolant and distilled water. Add the mixture to the coolant reservoir, **when the engine is cool**, until the appropriate fill level is obtained.

Maintenance and Specifications



Do not add engine coolant when the engine is hot. Steam and scalding liquids released from a hot cooling system can burn you badly. Also, you can be burned if you spill coolant on hot engine parts.



Do not put engine coolant in the windshield washer fluid container. If sprayed on the windshield, engine coolant could make it difficult to see through the windshield.

- **Add Motorcraft Premium Gold Engine Coolant (yellow-colored), VC-7-A (U.S., except CA, OR and NM), VC-7-B (CA, OR and NM), meeting Ford Specification WSS-M97B51-A1.**

Note: Use of Motorcraft Cooling System Stop Leak Pellets, VC-6, may darken the color of Motorcraft Premium Gold Engine Coolant from yellow to golden tan.

- **Do not add/mix an orange-colored, extended life coolant such as Motorcraft Speciality Orange Engine Coolant, VC-2 and VC-3 (US) or CXC-209 (Canada), meeting Ford specification WSS-M97B44-D with the factory-filled coolant.** Mixing Motorcraft Speciality Orange Engine Coolant or any orange-colored extended life product with your factory filled coolant can result in degraded corrosion protection.
- A large amount of water without engine coolant may be added, in case of emergency, to reach a vehicle service location. In this instance, the cooling system must be drained and refilled with a 50/50 mixture of engine coolant and distilled water as soon as possible. Water alone (without engine coolant) can cause engine damage from corrosion, overheating or freezing.
- **Do not use alcohol, methanol, brine or any engine coolants mixed with alcohol or methanol antifreeze (coolant).** Alcohol and other liquids can cause engine damage from overheating or freezing.
- **Do not add extra inhibitors or additives to the coolant.** These can be harmful and compromise the corrosion protection of the engine coolant.

For vehicles with overflow coolant systems with a non-pressurized cap on the coolant recovery system, add coolant to the coolant recovery reservoir when the engine is cool. Add the proper mixture of coolant and water to the "FULL COLD" level. For all other vehicles which have a

Maintenance and Specifications

coolant degas system with a pressurized cap, or if it is necessary to remove the coolant pressure relief cap on the radiator of a vehicle with an overflow system, follow these steps to add engine coolant.



To reduce the risk of personal injury, make sure the engine is cool before unscrewing the coolant pressure relief cap. The cooling system is under pressure; steam and hot liquid can come out forcefully when the cap is loosened slightly.

1. Before you begin, turn the engine off and let it cool.
2. When the engine is cool, wrap a thick cloth around the coolant pressure relief cap on the coolant reservoir (a translucent plastic bottle). Slowly turn cap counterclockwise (left) until pressure begins to release.
3. Step back while the pressure releases.
4. When you are sure that all the pressure has been released, use the cloth to turn it counterclockwise and remove the cap.
5. Fill the coolant reservoir slowly with the proper coolant mixture (see above), to within the “COLD FILL RANGE” or the “FULL COLD” level on the reservoir. If you removed the radiator cap in an overflow system, fill the radiator until the coolant is visible and radiator is almost full.
6. Replace the cap. Turn until tightly installed. (Cap must be tightly installed to prevent coolant loss.)

After any coolant has been added, check the coolant concentration (refer to *Checking engine coolant*). If the concentration is not 50/50 (protection to $-34^{\circ}\text{ F}/-36^{\circ}\text{ C}$), drain some coolant and adjust the concentration. It may take several drains and additions to obtain a 50/50 coolant concentration.

Whenever coolant has been added, the coolant level in the coolant reservoir should be checked the next few times you drive the vehicle. If necessary, add enough 50/50 concentration of engine coolant and distilled water to bring the liquid level to the proper level.

If you have to add more than 1.0 quart (1.0 liter) of engine coolant per month, have your dealer check the engine cooling system. Your cooling system may have a leak. Operating an engine with a low level of coolant can result in engine overheating and possible engine damage.

Recycled engine coolant

Ford Motor Company does NOT recommend the use of recycled engine coolant in vehicles originally equipped with Motorcraft Premium Gold Engine Coolant since a Ford-approved recycling process is not yet available.

Maintenance and Specifications



Used engine coolant should be disposed of in an appropriate manner. Follow your community's regulations and standards for recycling and disposing of automotive fluids.

Coolant refill capacity

To find out how much fluid your vehicle's cooling system can hold, refer to *Refill capacities* in this section.

Fill your engine coolant reservoir as outlined in *Adding engine coolant* in this section.

Severe climates

If you drive in extremely cold climates (less than -34°F [-36°C]):

- **It may be necessary to increase the coolant concentration above 50%.**
- **NEVER increase the coolant concentration above 60%.**
- **Increased engine coolant concentrations above 60% will decrease the overheat protection characteristics of the engine coolant and may cause engine damage.**
- **Refer to the chart on the coolant container to ensure the coolant concentration in your vehicle will provide adequate freeze protection at the temperatures in which you drive in the winter months.**

If you drive in extremely hot climates:

- **It is still necessary to maintain the coolant concentration above 40%.**
- **NEVER decrease the coolant concentration below 40%.**
- **Decreased engine coolant concentrations below 40% will decrease the corrosion protection characteristics of the engine coolant and may cause engine damage.**
- **Decreased engine coolant concentrations below 40% will decrease the freeze protection characteristics of the engine coolant and may cause engine damage.**
- **Refer to the chart on the coolant container to ensure the coolant concentration in your vehicle will provide adequate protection at the temperatures in which you drive.**

Vehicles driven year-round in non-extreme climates should use a 50/50 mixture of engine coolant and distilled water for optimum cooling system and engine protection.

Maintenance and Specifications

What you should know about fail-safe cooling

If the engine coolant supply is depleted, this feature allows the vehicle to be driven temporarily before incremental component damage is incurred. The “fail-safe” distance depends on ambient temperatures, vehicle load and terrain.

How fail-safe cooling works

If the engine begins to overheat:

- The engine coolant temperature gauge will move to the H (hot) area.
- The  symbol will illuminate.
- A tone will sound 3 times.
- The *Service engine soon* indicator light will illuminate.

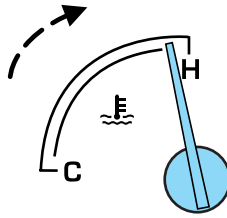

If the engine reaches a preset over-temperature condition, the engine will automatically switch to alternating cylinder operation. Each disabled cylinder acts as an air pump and cools the engine.

When this occurs the vehicle will still operate. However:

- The engine power will be limited.
- The air conditioning system will be disabled.

Continued operation will increase the engine temperature:

- The  symbol will begin to flash.
- A tone will sound 5 times.
- The engine will completely shut down, causing steering and braking effort to increase.

Once the engine temperature cools, the engine can be re-started. Take your vehicle to a service facility as soon as possible to minimize engine damage.

When fail-safe mode is activated

You have limited engine power when in the fail-safe mode, so drive the vehicle with caution. The vehicle will not be able to maintain high-speed operation and the engine will run rough. Remember that the engine is capable of completely shutting down automatically to prevent engine damage, therefore:

1. Pull off the road as soon as safely possible and turn off the engine.

Maintenance and Specifications

2. Arrange for the vehicle to be taken to a service facility.
3. If this is not possible, wait a short period for the engine to cool.
4. Check the coolant level and replenish if low.



Never remove the coolant reservoir cap while the engine is running or hot.

5. Re-start the engine and take your vehicle to a service facility.

Driving the vehicle without repairing the engine problem increases the chance of engine damage. Take your vehicle to a service facility as soon as possible.

WHAT YOU SHOULD KNOW ABOUT AUTOMOTIVE FUELS

Important safety precautions



Do not overfill the fuel tank. The pressure in an overfilled tank may cause leakage and lead to fuel spray and fire.



The fuel system may be under pressure. If the fuel filler cap is venting vapor or if you hear a hissing sound, wait until it stops before completely removing the fuel filler cap. Otherwise, fuel may spray out and injure you or others.



If you do not use the proper fuel filler cap, excessive pressure or vacuum in the fuel tank may damage the fuel system or cause the fuel cap to disengage in a collision, which may result in possible personal injury.



Automotive fuels can cause serious injury or death if misused or mishandled.



Gasoline may contain benzene, which is a cancer-causing agent.

Maintenance and Specifications

Observe the following guidelines when handling automotive fuel:

- Extinguish all smoking materials and any open flames before refueling your vehicle.
- Always turn off the vehicle before refueling.
- Automotive fuels can be harmful or fatal if swallowed. Fuel such as gasoline is highly toxic and if swallowed can cause death or permanent injury. If fuel is swallowed, call a physician immediately, even if no symptoms are immediately apparent. The toxic effects of fuel may not be visible for hours.
- Avoid inhaling fuel vapors. Inhaling too much fuel vapor of any kind can lead to eye and respiratory tract irritation. In severe cases, excessive or prolonged breathing of fuel vapor can cause serious illness and permanent injury.
- Avoid getting fuel liquid in your eyes. If fuel is splashed in the eyes, remove contact lenses (if worn), flush with water for 15 minutes and seek medical attention. Failure to seek proper medical attention could lead to permanent injury.
- Fuels can also be harmful if absorbed through the skin. If fuel is splashed on the skin and/or clothing, promptly remove contaminated clothing and wash skin thoroughly with soap and water. Repeated or prolonged skin contact with fuel liquid or vapor causes skin irritation.
- Be particularly careful if you are taking “Antabuse” or other forms of disulfiram for the treatment of alcoholism. Breathing gasoline vapors, or skin contact could cause an adverse reaction. In sensitive individuals, serious personal injury or sickness may result. If fuel is splashed on the skin, promptly wash skin thoroughly with soap and water. Consult a physician immediately if you experience an adverse reaction.



 When refueling always shut the engine off and never allow sparks or open flames near the filler neck. Never smoke while refueling. Fuel vapor is extremely hazardous under certain conditions. Care should be taken to avoid inhaling excess fumes.

 The flow of fuel through a fuel pump nozzle can produce static electricity, which can cause a fire if fuel is pumped into an ungrounded fuel container.

Maintenance and Specifications

Refueling



Fuel vapor burns violently and a fuel fire can cause bad injuries. To help avoid injuries to you and others:

- Read and follow all the instructions on the pump island;
- Turn off your engine when you are refueling;
- Do not smoke if you are near fuel or refueling your vehicle;
- Keep sparks, flames and smoking materials away from fuel;
- Stay outside your vehicle and do not leave the fuel pump unattended when refueling you vehicle — this is against the law in some places;
- Keep children away from the fuel pump; never let children pump fuel

Use the following guidelines to avoid static build-up when filling an ungrounded fuel container:

- Place approved fuel container on the ground.
- DO NOT fill a fuel container while it is in the vehicle (including the cargo area).
- Keep the fuel pump nozzle in contact with the fuel container while filling.
- DO NOT use a device that would hold the fuel pump handle in the fill position.

Fuel Filler Cap

Your fuel tank filler cap has an indexed design with a 1/4 turn on/off feature.

When fueling your vehicle:

1. Turn the engine off.
2. Carefully turn the filler cap counterclockwise 1/4 of a turn until it stops.
3. Pull to remove the cap from the fuel filler pipe.
4. To install the cap, align the tabs on the cap with the notches on the filler pipe.
5. Turn the filler cap clockwise 1/4 of a turn until it stops.

Maintenance and Specifications

If the “Check Fuel Cap” indicator comes on and stays on after you start the engine, the fuel filler cap may not be properly installed. Turn off the engine, remove the fuel filler cap, align the cap properly and reinstall it.

If you must replace the fuel filler cap, replace it with a fuel filler cap that is designed for your vehicle. The customer warranty may be void for any damage to the fuel tank or fuel system if the correct genuine Ford or Motorcraft fuel filler cap is not used.



The fuel system may be under pressure. If the fuel filler cap is venting vapor or if you hear a hissing sound, wait until it stops before completely removing the fuel filler cap. Otherwise, fuel may spray out and injure you or others.



If you do not use the proper fuel filler cap, excessive pressure or vacuum in the fuel tank may damage the fuel system or cause the fuel cap to disengage in a collision, which may result in possible personal injury.

Choosing the right fuel

Use only UNLEADED FUEL. The use of leaded fuel is prohibited by law and could damage your vehicle.

Your vehicle was not designed to use fuel or fuel additives with metallic compounds, including manganese-based additives. Studies indicate that these additives can cause your vehicle’s emission control system to deteriorate more rapidly. In Canada, premium grade fuel generally contains more metallic additives than regular fuel. We recommend using regular grade fuel. In Canada, many fuels contain metallic additives, but fuels free of such additives may be available; check with your local fuel dealer.

Do not use fuel containing methanol. It can damage critical fuel system components.

Repairs to correct the effects of using a fuel for which your vehicle was not designed may not be covered by your warranty.

Maintenance and Specifications

Octane recommendations

Your vehicle is designed to use “Regular” unleaded gasoline with pump (R+M)/2 octane rating of 87. We do not recommend the use of gasolines labeled as “Regular” that are sold with octane ratings of 86 or lower in high altitude areas.

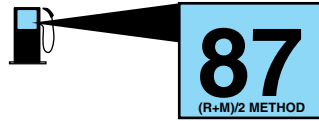

Do not be concerned if your engine sometimes knocks lightly. However, if it knocks heavily under most driving conditions while you are using fuel with the recommended octane rating, see your dealer or a qualified service technician to prevent any engine damage.

Fuel quality

If you are experiencing starting, rough idle or hesitation driveability problems during a cold start, try a different brand of gasoline. “Premium” unleaded gasoline should not be used (particularly in the United States) if “Regular” unleaded gasoline is recommended because it may cause these problems to become more pronounced. If the problems persist, see your dealer or a qualified service technician.

It should not be necessary to add any aftermarket products to your fuel tank if you continue to use high quality fuel of the recommended octane rating. Aftermarket products could cause damage to the fuel system. Repairs to correct the effects of using an aftermarket product in your fuel may not be covered by your warranty.

Cleaner air

Ford endorses the use of reformulated “cleaner-burning” gasolines to improve air quality.

Running out of fuel

Avoid running out of fuel because this situation may have an adverse affect on powertrain components.

If you have run out of fuel:

- You may need to cycle the ignition from OFF to ON several times after refueling, to allow the fuel system to pump the fuel from the tank to the engine.
- Your *Service engine soon* indicator may come on. For more information on the *Service engine soon* indicator, refer to the *Instrument Cluster* chapter.

Fuel Filter

For fuel filter replacement, see your dealer or a qualified service technician. Refer to *scheduled maintenance information* for the appropriate intervals for changing the fuel filter.

Maintenance and Specifications

Replace the fuel filter with an authorized Motorcraft part. The customer warranty may be void for any damage to the fuel system if an authorized Motorcraft fuel filter is not used.

ESSENTIALS OF GOOD FUEL ECONOMY

Measuring techniques

Your best source of information about actual fuel economy is you, the driver. You must gather information as accurately and consistently as possible. Fuel expense, frequency of fill-ups or fuel gauge readings are NOT accurate as a measure of fuel economy. We do not recommend taking fuel economy measurements during the first 1,000 miles (1,600 km) of driving (engine break-in period). You will get a more accurate measurement after 2,000 miles-3,000 miles (3,000 km-5,000 km).

Filling the tank

The advertised fuel capacity of the fuel tank on your vehicle is equal to the rated refill capacity of the fuel tank as listed in the *Refill capacities* section of this chapter.

The advertised capacity is the amount of the indicated capacity and the empty reserve combined. Indicated capacity is the difference in the amount of fuel in a full tank and a tank when the fuel gauge indicates empty. Empty reserve is the small amount of fuel remaining in the fuel tank after the fuel gauge indicates empty.

The amount of usable fuel in the empty reserve varies and should not be relied upon to increase driving range. When refueling your vehicle after the fuel gauge indicates empty, you might not be able to refuel the full amount of the advertised capacity of the fuel tank due to the empty reserve still present in the tank.

For consistent results when filling the fuel tank:

- Turn the engine/ignition switch to the off position prior to refueling, an error in the reading will result if the engine is left running.
- Use the same filling rate setting (low — medium — high) each time the tank is filled.
- Allow no more than 2 automatic click-offs when filling.
- Always use fuel with the recommended octane rating.
- Use a known quality gasoline, preferably a national brand.
- Use the same side of the same pump and have the vehicle facing the same direction each time you fill up.

Maintenance and Specifications

- Have the vehicle loading and distribution the same every time.

Your results will be most accurate if your filling method is consistent.

Calculating fuel economy

1. Fill the fuel tank completely and record the initial odometer reading (in miles or kilometers).
2. Each time you fill the tank, record the amount of fuel added (in gallons or liters).
3. After at least three to five tank fill-ups, fill the fuel tank and record the current odometer reading.
4. Subtract your initial odometer reading from the current odometer reading.
5. Follow one of the simple calculations in order to determine fuel economy:

Calculation 1: **Divide total miles traveled by total gallons used.**

Calculation 2: **Multiply liters used by 100, then divide by total kilometers traveled.**

Keep a record for at least one month and record the type of driving (city or highway). This will provide an accurate estimate of the vehicle's fuel economy under current driving conditions. Additionally, keeping records during summer and winter will show how temperature impacts fuel economy. In general, lower temperatures give lower fuel economy.

Driving style — good driving and fuel economy habits

Give consideration to the lists that follow and you may be able to change a number of variables and improve your fuel economy.

Habits

- Smooth, moderate operation can yield up to 10% savings in fuel.
- Steady speeds without stopping will usually give the best fuel economy.
- Idling for long periods of time (greater than one minute) may waste fuel.
- Anticipate stopping; slowing down may eliminate the need to stop.
- Sudden or hard accelerations may reduce fuel economy.
- Slow down gradually.
- Driving at reasonable speeds (traveling at 55 mph [88 km/h] uses 15% less fuel than traveling at 65 mph [105 km/h]).

Maintenance and Specifications

- Revving the engine before turning it off may reduce fuel economy.
- Using the air conditioner or defroster may reduce fuel economy.
- You may want to turn off the speed control in hilly terrain if unnecessary shifting between third and fourth gear occurs. Unnecessary shifting of this type could result in reduced fuel economy.
- Warming up a vehicle on cold mornings is not required and may reduce fuel economy.
- Resting your foot on the brake pedal while driving may reduce fuel economy.
- Combine errands and minimize stop-and-go driving.

Maintenance

- Keep tires properly inflated and use only recommended size.
- Operating a vehicle with the wheels out of alignment will reduce fuel economy.
- Use recommended engine oil. Refer to *Lubricant specifications* in this chapter.
- Perform all regularly scheduled maintenance items. Follow the recommended maintenance schedule and owner maintenance checks found in *scheduled maintenance information*.

Conditions

- Heavily loading a vehicle or towing a trailer may reduce fuel economy at any speed.
- Carrying unnecessary weight may reduce fuel economy (approximately 1 mpg [0.4 km/L] is lost for every 400 lb [180 kg] of weight carried).
- Adding certain accessories to your vehicle (for example bug deflectors, rollbars/light bars, running boards, ski/luggage racks) may reduce fuel economy.
- Using fuel blended with alcohol may lower fuel economy.
- Fuel economy may decrease with lower temperatures during the first 8–10 miles (12–16 km) of driving.
- Driving on flat terrain offers improved fuel economy as compared to driving on hilly terrain.
- Transmissions give their best fuel economy when operated in the top cruise gear and with steady pressure on the gas pedal.

Maintenance and Specifications

- Close windows for high speed driving.

EPA window sticker

Every new vehicle should have the EPA window sticker. Contact your dealer if the window sticker is not supplied with your vehicle. The EPA window sticker should be your guide for the fuel economy comparisons with other vehicles.

It is important to note the box in the lower left corner of the window sticker. These numbers represent the Range of MPG (L/100 km) expected on the vehicle under optimum conditions. Your fuel economy may vary depending upon the method of operation and conditions.

EMISSION CONTROL SYSTEM

Your vehicle is equipped with various emission control components and a catalytic converter which will enable your vehicle to comply with applicable exhaust emission standards. To make sure that the catalytic converter and other emission control components continue to work properly:

- Use only the specified fuel listed.
- Avoid running out of fuel.
- Do not turn off the ignition while your vehicle is moving, especially at high speeds.
- Have the items listed in *scheduled maintenance information* performed according to the specified schedule.

The scheduled maintenance items listed in *scheduled maintenance information* are essential to the life and performance of your vehicle and to its emissions system.

If other than Ford, Motorcraft or Ford-authorized parts are used for maintenance replacements or for service of components affecting emission control, such non-Ford parts should be equivalent to genuine Ford Motor Company parts in performance and durability.



Do not park, idle, or drive your vehicle in dry grass or other dry ground cover. The emission system heats up the engine compartment and exhaust system, which can start a fire.

Illumination of the *Service engine soon* light, charging system warning light or the temperature warning light, fluid leaks, strange odors, smoke or loss of engine power, could indicate that the emission control system is not working properly.

Maintenance and Specifications



Exhaust leaks may result in entry of harmful and potentially lethal fumes into the passenger compartment.

Do not make any unauthorized changes to your vehicle or engine. By law, vehicle owners and anyone who manufactures, repairs, services, sells, leases, trades vehicles, or supervises a fleet of vehicles are not permitted to intentionally remove an emission control device or prevent it from working. Information about your vehicle's emission system is on the Vehicle Emission Control Information Decal located on or near the engine. This decal identifies engine displacement and gives some tune up specifications.

Please consult your *Warranty Guide* for complete emission warranty information.

On board diagnostics (OBD-II)

Your vehicle is equipped with a computer that monitors the engine's emission control system. This system is commonly known as the On Board Diagnostics System (OBD-II). This OBD-II system protects the environment by ensuring that your vehicle continues to meet government emission standards. The OBD-II system also assists the service technician in properly servicing your vehicle. When the *Check engine/Service engine soon* light illuminates, the OBD-II system has detected a malfunction. Temporary malfunctions may cause your *Check engine/Service engine soon* light to illuminate. Examples are:

1. The vehicle has run out of fuel. (The engine may misfire or run poorly.)
2. Poor fuel quality or water in the fuel.
3. The fuel cap may not have been securely tightened. See *Fuel filler cap* in this chapter.

These temporary malfunctions can be corrected by filling the fuel tank with good quality fuel and/or properly tightening the fuel cap. After three driving cycles without these or any other temporary malfunctions present, the *Check engine/Service engine soon* light should turn off. (A driving cycle consists of a cold engine startup followed by mixed city/highway driving.) No additional vehicle service is required.

If the *Check engine/Service engine soon* light remains on, have your vehicle serviced at the first available opportunity.

Maintenance and Specifications

Readiness for Inspection/Maintenance (I/M) testing

In some localities, it may be a legal requirement to pass an I/M test of the on-board diagnostics system. If your *Check engine/Service engine soon* light is on, refer to the description in the *Warning lights and chimes* section of the *Instrument Cluster* chapter. Your vehicle may not pass the I/M test with the *Check engine/Service engine soon* light on.

If the vehicle's powertrain system or its battery has just been serviced, the on-board diagnostics system is reset to a "not ready for I/M test" condition. To ready the on-board diagnostics system for I/M testing, a minimum of 30 minutes of city and highway driving is necessary as described below:

- First, at least 10 minutes of driving on an expressway or highway.
- Next, at least 20 minutes driving in stop-and-go, city-type traffic with at least four idle periods.

Allow the vehicle to sit for at least eight hours without starting the engine. Then, start the engine and complete the above driving cycle. The engine must warm up to its normal operating temperature. Once started, do not turn off the engine until the above driving cycle is complete.

CHECKING AND ADDING POWER STEERING FLUID

Check the power steering fluid. Refer to the scheduled maintenance guide for the service interval schedules. **If adding fluid is necessary, use only MERCON® ATF.**

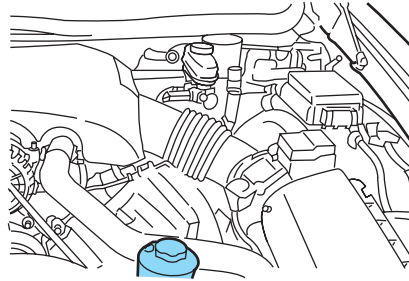

1. Start the engine and let it run until it reaches normal operating temperature (the engine coolant temperature gauge indicator will be near the center of the normal area between H and C).
2. While the engine idles, turn the steering wheel left and right several times.
3. Turn the engine off.

Maintenance and Specifications

4. Check the fluid level in the reservoir. It should be between the MIN and MAX lines. Do not add fluid if the level is in this range.

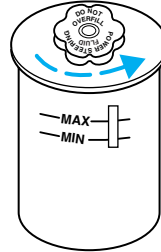

5. If the fluid is low, add fluid in small amounts, continuously checking the level until it reaches the range between the MIN and MAX lines. Be sure to put the cap back on the reservoir.

BRAKE FLUID RESERVOIR

The fluid level will drop slowly as the brakes wear, and will rise when the brake components are replaced. Fluid levels below the “MAX” line that do not trigger the brake system warning lamp are within the normal operating range, there is no need to add fluid. If the fluid levels are outside of the normal operating range, the performance of your brake system could be compromised, seek service from your dealer immediately.

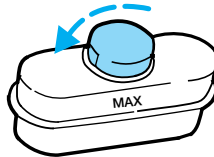

TRANSMISSION FLUID

Checking automatic transmission fluid (if equipped)

Refer to your *scheduled maintenance information* for scheduled intervals for fluid checks and changes. Your transmission does not consume fluid. However, the fluid level should be checked if the transmission is not working properly, i.e., if the transmission slips or shifts slowly or if you notice some sign of fluid leakage.

Automatic transmission fluid expands when warmed. To obtain an accurate fluid check, drive the vehicle until it is at normal operating temperature (approximately 20 miles [30 km]). If your vehicle has been operated for an extended period at high speeds, in city traffic during hot weather or pulling a trailer, the vehicle should be turned off for about 30 minutes to allow fluid to cool before checking.

1. Drive the vehicle 20 miles (30 km) or until it reaches normal operating temperature.

308

Maintenance and Specifications

2. Park the vehicle on a level surface and engage the parking brake.
3. With the parking brake engaged and your foot on the brake pedal, start the engine and move the gearshift lever through all of the gear ranges. Allow sufficient time for each gear to engage.
4. Latch the gearshift lever in P (Park) and leave the engine running.
5. Remove the dipstick, wiping it clean with a clean, dry lint free rag. If necessary, refer to *Identifying components in the engine compartment* in this chapter for the location of the dipstick.
6. Install the dipstick making sure it is fully seated in the filler tube.
7. Remove the dipstick and inspect the fluid level. The fluid should be in the designated area for normal operating temperature or ambient temperature.

Low fluid level

Do not drive the vehicle if the fluid level is at the bottom of the dipstick and the ambient temperature is above 50°F (10°C).

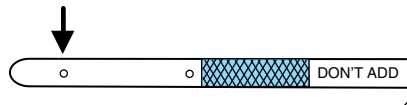

Correct fluid level

The transmission fluid should be checked at normal operating temperature 150°F-170°F (66°C-77°C) on a level surface. The normal operating temperature can be reached after approximately 20 miles (30 km) of driving.

You can check the fluid without driving if the ambient temperature is above 50°F (10°C). However, if fluid is added at this time, an overfill condition could result when the vehicle reaches normal operating temperature.

The transmission fluid should be in this range if at normal operating temperature (150°F-170°F [66°C-77°C]).

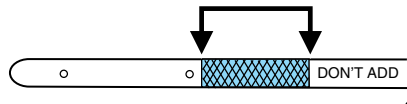

Maintenance and Specifications

The transmission fluid should be in this range if at ambient temperature (50°F-95°F [10°C-35°C]).

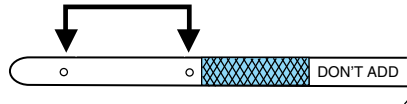

High fluid level

Fluid levels above the safe range may result in transmission failure. An overfill condition of transmission fluid may cause shift and/or engagement concerns and/or possible damage.

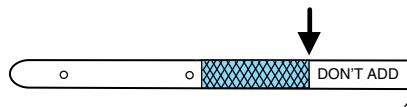

High fluid levels can be caused by an overheating condition.

Adjusting automatic transmission fluid levels

Before adding any fluid, make sure the correct type is used. The type of fluid used is normally indicated on the dipstick and also in the *Lubricant specifications* section in this chapter.

Use of a non-approved automatic transmission fluid may cause internal transmission component damage.

If necessary, add fluid in 1/2 pint (250 ml) increments through the filler tube until the level is correct.

If an overfill occurs, excess fluid should be removed by a qualified technician.

An overfill condition of transmission fluid may cause shift and/or engagement concerns and/or possible damage.

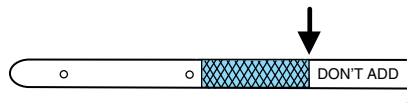

Do not use supplemental transmission fluid additives, treatments or cleaning agents. The use of these materials may affect transmission operation and result in damage to internal transmission components.

AIR FILTER MAINTENANCE

Refer to *scheduled maintenance information* for the appropriate intervals for changing the air filter element.

Maintenance and Specifications

When changing the air filter element, use only the Motorcraft air filter element listed. Refer to *Motorcraft part numbers* in this chapter.

Note: Do not start your engine with the air cleaner removed and do not remove it while the engine is running.

Changing the air filter element

1. Release the clamps that secure the air filter housing cover.
2. Carefully separate the two halves of the air filter housing.
3. Remove the air filter element from the air filter housing.
4. Wipe the air filter housing and cover clean to remove any dirt or debris and to ensure good sealing.
5. Install a new air filter element. Be careful not to crimp the filter element edges between the air filter housing and cover. This could cause filter damage and allow unfiltered air to enter the engine if not properly seated.

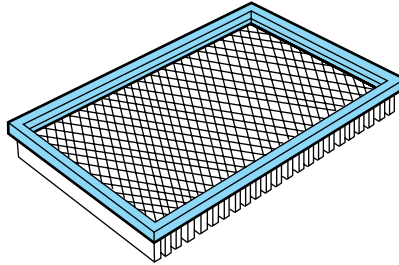

6. Replace the air filter housing cover and secure the clamps.
7. Replace the air inlet tube and secure the clamp.

Note: Failure to use the correct air filter element may result in severe engine damage. The customer warranty may be voided for any damage to the engine if the correct air filter element is not used.

MOTORCRAFT PART NUMBERS

Component	4.6L SOHC V8 engine
Air filter element	FA-1668
Fuel filter	FG-986B
Battery-standard	BXT-65-650
Battery-heavy duty ¹	BXT-65-750
Oil filter	FL-820-S
PCV valve	²
Spark plugs	³

¹Included in long wheelbase package.

Maintenance and Specifications

²The PCV valve is a critical emission component. It is one of the items listed in *scheduled maintenance information* and is essential to the life and performance of your vehicle and to its emissions system.

For PCV valve replacement, see your dealer or a qualified service technician. Refer to *scheduled maintenance information* for the appropriate intervals for changing the PCV valve.

Replace the PCV valve with one that meets Ford material and design specifications for your vehicle, such as a Motorcraft or equivalent replacement part. The customer warranty may be void for any damage to the emissions system if such a PCV valve is not used.

³For spark plug replacement, see your dealer or a qualified service technician. Refer to *scheduled maintenance information* for the appropriate intervals for changing the spark plugs.

Replace the spark plugs with ones that meet Ford material and design specifications for your vehicle, such as Motorcraft or equivalent replacement parts. The customer warranty may be void for any damage to the engine if such spark plugs are not used.

REFILL CAPACITIES

Fluid	Ford Part Name	Capacity
Engine oil (includes filter change) ⁷	Motorcraft SAE 5W-20 Premium Synthetic Blend Motor Oil (US) Motorcraft SAE 5W-20 Super Premium Motor Oil (Canada)	5.7L (6.0 quarts)
Brake fluid	Motorcraft High Performance DOT 3 Motor Vehicle Brake Fluid ¹	Fill to line on reservoir
Power steering fluid	Motorcraft MERCON® ATF	Fill to line on reservoir
Transmission fluid (4R70/75 E) ²	Motorcraft MERCON®V ATF	13.2L (13.9 quarts) ³

Maintenance and Specifications

Fluid	Ford Part Name	Capacity
Engine coolant ⁴	Motorcraft Premium Gold Engine Coolant (yellow-colored)	17.6L (18.6 quarts)
Fuel tank	N/A	71.9L (19.0 gallons)
Rear axle lubricant ⁵	Motorcraft SAE 80W-90 Premium Rear Axle Lubricant	2.4L (5.0 pints) ⁶
Windshield washer fluid	Motorcraft Premium Windshield Washer Concentrate	Fill to line on reservoir

¹Use only brake fluids certified to meet Ford specifications. Refer to *Lubricant Specifications* in this chapter. DOT 3 fluid is recommended. However, if DOT 3 is not available, DOT 4 fluid can be used.

²Ensure the correct automatic transmission fluid is used. MERCON® and MERCON® V are not interchangeable. DO NOT MIX MERCON® and MERCON® V. Refer to the *scheduled maintenance information* to determine the correct service interval.

³Indicates only approximate dry-fill capacity. Some applications may vary based on cooler size and if equipped with an in-tank cooler. The amount of transmission fluid and fluid level should be set by the indication on the dipstick's normal operating range.

⁴Add the coolant type originally equipped in your vehicle.

⁵Rear axles are considered lubricated for life when the vehicle is used for normal service. See your *scheduled maintenance information* for Severe Duty requirements.

⁶Add 118 ml (4 oz.) of Additive Friction Modifier XL-3 or equivalent meeting Ford specification EST-M2C118-A for complete refill of Traction-Lok rear axle.

For limousine, use 2.1-2.3L (4.50-4.75 pints) of Motorcraft SAE 75W-140 High Performance Rear Axle Lubricant or equivalent meeting Ford specification WSL-M2C192-A for complete refill of rear axle.

Service refill capacities are determined by filling the rear axle 6 mm to 14 mm (1/4 inch to 9/16 inch) below the bottom of the filler hole.

⁷Use of synthetic or synthetic blend motor oil is not mandatory. Engine oil need only meet the requirements of Ford specification WSS-M2C930-A and the API Certification mark.

Maintenance and Specifications

LUBRICANT SPECIFICATIONS

Item	Ford part name	Ford part number	Ford specification
Brake fluid	Motorcraft High Performance DOT 3 Motor Vehicle Brake Fluid ¹	PM-1	ESA-M6C25-A and DOT 3
Door weatherstrips	Silicone Lubricant	XL-6	ESR-M13P4-A
Engine coolant	Motorcraft Premium Gold Engine Coolant (yellow colored)	VC-7-A (U.S., except CA, OR and NM), VC-7-B (CA, OR and NM)	WSS-M97B 51-A1
Engine oil	Motorcraft SAE 5W20 Premium Synthetic Blend Motor Oil (US) Motorcraft SAE 5W-20 Super Premium Motor Oil (Canada)	XO-5W20-QSP (US) CXO-5W20-LSP12 (Canada)	WSS-M2C930-A with API Certification Mark

Maintenance and Specifications

Item	Ford part name	Ford part number	Ford specification
Hinges, latches, striker plates, fuel filler door hinge and seat tracks	Multi-Purpose Grease	XG-4 or XL-5	ESB-M1C93-B or ESR-M1C159-A
Lock cylinders	Penetrating and Lock Lubricant	Motorcraft XL-1	N/A
Power steering fluid	Motorcraft MERCON® ATF	XT-2-QDX	MERCON®
Automatic transmission (4R70/75 E-W) ³	Motorcraft MERCON®V ATF	XT-5-QM	MERCON®V
Rear Axle Lubricant ²	Motorcraft SAE 80W-90 Premium Rear Axle Lubricant	XY-80W90-QL	WSP-M2C197-A
Windshield washer fluid	Motorcraft Premium Windshield Washer Concentrate	ZC-32-A	WSB-M8B16-A2

¹Use only brake fluids certified to meet Ford specifications. DOT 3 fluid is recommended. However, if DOT 3 is not available, DOT 4 fluid can be used.

²Add 118 ml (4 oz.) of Additive Friction Modifier XL-3 or equivalent meeting Ford specification EST-M2C118-A for complete refill of Traction-Lok rear axles.

Maintenance and Specifications

For limousine, use 2.1-2.3L (4.50-4.75 pints) of Motorcraft SAE 75W-140 High Performance Rear Axle Lubricant XY-75W140-QL or equivalent meeting Ford Specification WSL-M2C192-A for complete refill of rear axles.

³Ensure the correct transmission fluid is used. Transmission fluid requirements are indicated on the dipstick or the dipstick handle. MERCON® and MERCON® V are not interchangeable. DO NOT mix MERCON® and MERCON® V. Refer to your *scheduled maintenance information* to determine the correct service interval.

ENGINE DATA

Engine	4.6L SOHC V8 engine
Cubic inches	281
Required fuel	87 octane
Firing order	1-3-7-2-6-5-4-8
Ignition system	Coil on plug
Spark plug gap	0.052–0.056 inch (1.32–1.42mm)
Compression ratio	9.4:1

VEHICLE DIMENSIONS

Vehicle dimensions	Inches (mm)
(1) Overall length	215.4 (5471)/221.4 (5623)*
(2) Overall width	78.5 (1993)
(3) Overall height	58.5 (1487)/58.7 (1490)*
(4) Wheelbase	117.7 (2990)/123.7 (3142)*
(5) Track - Front	63.4 (1611)
(5) Track - Rear	65.9 (1673)
* Denotes long wheel base	

Maintenance and Specifications

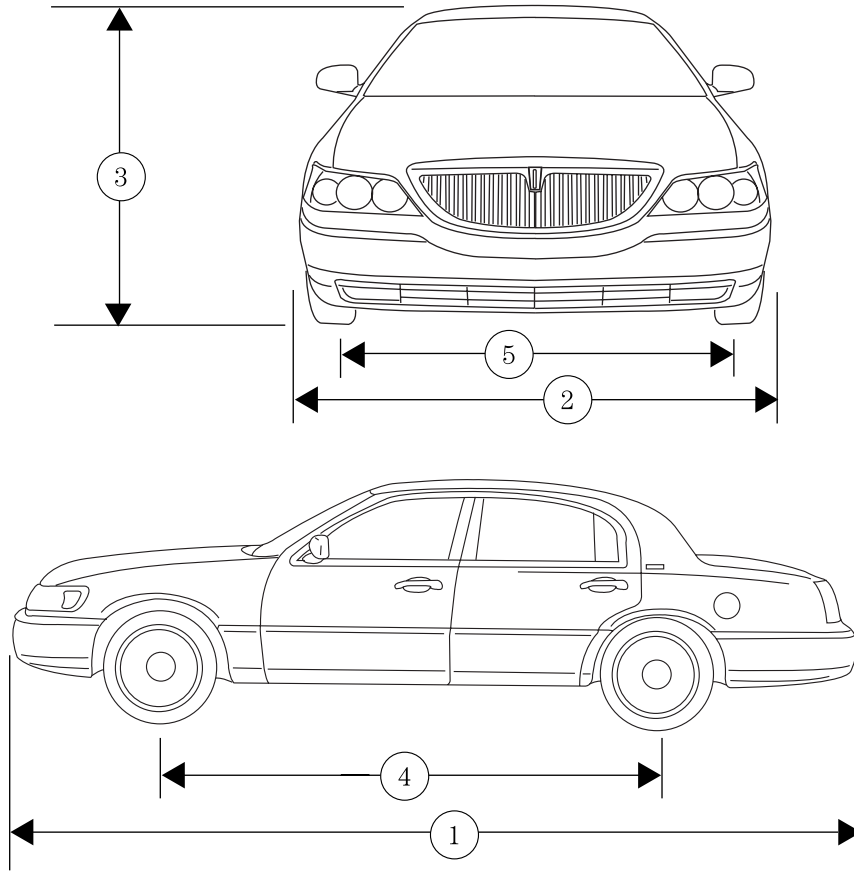

Maintenance and Specifications

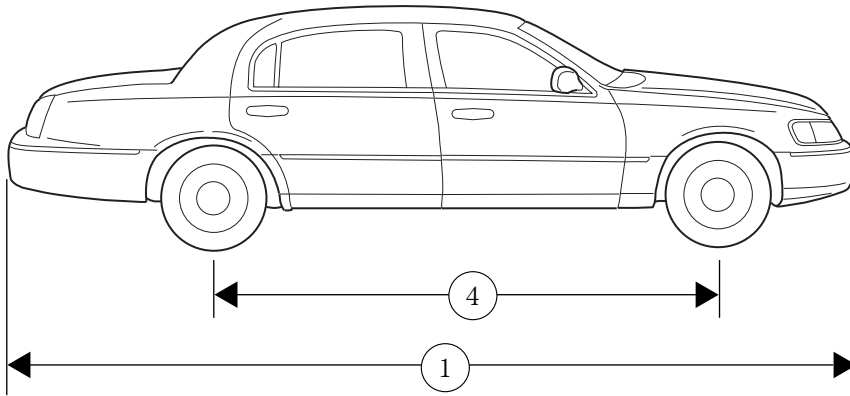

IDENTIFYING YOUR VEHICLE

Certification label

The National Highway Traffic Safety Administration Regulations require that a Certification label be affixed to a vehicle and prescribe where the Certification label may be located. The Certification label is located on the structure by the trailing edge of the driver's door or the edge of the driver's door.

MFD. BY FORD MOTOR CO. IN U.S.A.			
DATE: XXXXX	GVWR: XXXXX LB/ XXXXX KG		
FGAWR: XXXXX/XXXXXXXX	RGAWR: XXXXX/XXXXXXXX		
THIS VEHICLE CONFORMS TO ALL APPLICABLE FEDERAL MOTOR VEHICLE SAFETY STANDARDS IN EFFECT ON THE DATE OF MANUFACTURE SHOWN ABOVE.			
VIN: XXXXXXXXXXXXXXXX		TYPE: XXXXXXXXXXXXXXXX	
MAXIMUM LOAD=OCCUPANTS + LUGGAGE=XXXKG/XXXLB			
OCCUPANTS: X TOTAL X FR X 2ND X RR OCCUPANTS LUGGAGE			
TIRE: XXXX/XXXXX XXX		XX XXXKG/XXXLB	X XXXKG/XXXLB
PRESSURE (FR) XXX kPa/ XX PSI COLD			
PRESSURE (RR) XXX kPa/ XX PSI COLD			
TRAILER TOWING - SEE OWNER GUIDE			
EXT PNT: XXXXX XXXXX	RC: XX	DSQ: XXXX	F0000
BAR INT TR TP/PS R	AXLE TR SPR	T0000	
X XX XXX X	XX X XXX		
UTC VFOHT-15294A10-GA			

Maintenance and Specifications

Vehicle identification number (VIN)

The vehicle identification number is attached to a metal tag and is located on the driver side instrument panel. (Please note that in the graphic XXXX is representative of your vehicle identification number.)

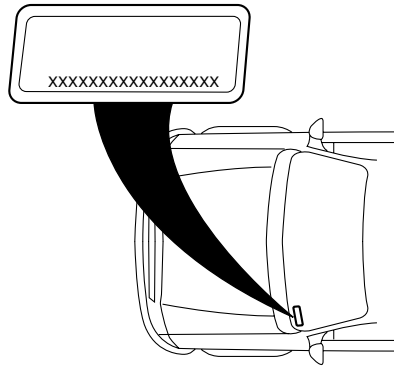

1. World manufacturer identifier
2. Brake type and gross vehicle weight rating (GVWR)
3. Vehicle line, series, body type
4. Engine type
5. Check digit
6. Model year
7. Assembly plant
8. Production sequence number

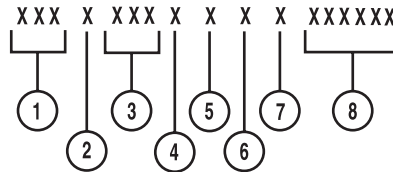

Engine number

The engine number (the last eight numbers of the vehicle identification number) is stamped on the engine block, transmission, frame and transfer case (if equipped).

Accessories

LINCOLN ACCESSORIES FOR YOUR VEHICLE

A wide selection of Genuine Lincoln Accessories are available for your vehicle through your local authorized Lincoln or Ford of Canada dealer. These quality accessories have been specifically engineered to fulfill your automotive needs; they are custom designed to complement the style and aerodynamic appearance of your vehicle. In addition, each accessory is made from high quality materials and meets or exceeds Lincoln's rigorous engineering and safety specifications. Ford Motor Company will repair or replace any properly dealer-installed Genuine Lincoln Accessory found to be defective in factory-supplied materials or workmanship during the warranty period, as well as any component damaged by the defective accessory. The accessory will be warranted for whichever provides you the greatest benefit:

- 12 months or 12,000 miles (20,000 km) (whichever occurs first), or
- the remainder of your new vehicle limited warranty.

This means that Genuine Lincoln Accessories purchased along with your new vehicle and installed by the dealer are covered for the full length of your New Vehicle's Limited Warranty — 4 years or 50,000 miles (80,000 km) (whichever occurs first). Contact your dealer for details and a copy of the warranty.

Not all accessories are available for all models.

Following is a list of several Genuine Lincoln Accessory products. Not all accessories are available for all models. To find out what accessories are available for your vehicle, please contact your dealer or visit our online store at: www.lincolnaccessories.com.

Exterior style

Bug shields
Deflectors
Front end covers
Headlamps, fog lights and Daytime Running Lamps (DRLs)
Splash guards
Wheels

Interior style

Electrochromatic compass/temperature interior mirrors
Floor mats

Accessories

Lifestyle

Bike racks

Cargo organization and management

Peace of mind

First aid and highway safety kits

Full vehicle covers

Locking gas cap

Remote start

Vehicle security systems

For maximum vehicle performance, keep the following information in mind when adding accessories or equipment to your vehicle:

- When adding accessories, equipment, passengers and luggage to your vehicle, do not exceed the total weight capacity of the vehicle or of the front or rear axle (GVWR or GAWR as indicated on the Safety Compliance Certification label). Consult your dealer for specific weight information.
- The Federal Communications Commission (FCC) and Canadian Radio Telecommunications Commission (CRTC) regulate the use of mobile communications systems — such as two-way radios, telephones and theft alarms - that are equipped with radio transmitters. Any such equipment installed in your vehicle should comply with FCC or CRTC regulations and should be installed only by a qualified service technician.
- Mobile communications systems may harm the operation of your vehicle, particularly if they are not properly designed for automotive use.
- To avoid interference with other vehicle functions, such as anti-lock braking systems, amateur radio users who install radios and antennas onto their vehicle should not locate the Amateur Radio Antennas in the area of the driver's side hood.
- Electrical or electronic accessories or components that are added to the vehicle by the dealer or the owner may adversely affect battery performance and durability.

Index

A

- Accessory delay130
 - Air bag supplemental restraint system182–183, 190
 - and child safety seats185
 - description183, 190
 - disposal193
 - driver air bag185, 191
 - indicator light190, 192
 - operation185, 191
 - passenger air bag185, 191
 - side air bag190
 - Air cleaner filter310–311
 - Air suspension243
 - description243
 - Antifreeze
 - (see Engine coolant)291
 - Anti-lock brake system
 - (see Brakes)239
 - Anti-theft system160
 - Audio system (see Radio)30
 - Automatic transmission
 - driving an automatic
 - overdrive245
 - fluid, adding308
 - fluid, checking308
 - fluid, refill capacities312
 - fluid, specification316
 - Auxiliary power point128
 - Axle
 - lubricant specifications ..314, 316
 - refill capacities312
 - traction lok247
- ### B
- Battery289
 - acid, treating emergencies289
 - jumping a disabled battery260
 - maintenance-free289
 - replacement, specifications ..311
 - servicing289
 - BeltMinder177
 - Brakes238
 - anti-lock239
 - anti-lock brake system (ABS)
 - warning light239
 - fluid, checking and adding308
 - fluid, refill capacities312
 - fluid, specifications314, 316
 - lubricant specifications ..314, 316
 - shift interlock243
 - Bulbs109

C

- Capacities for refilling fluids312
- CD changer36
- CD-single premium30
- Cell phone use137
- Certification Label318
- Changing a tire209
- Child safety restraints193
 - child safety belts193
- Child safety seats196
 - attaching with tether straps ..200
 - in front seat197
 - in rear seat197
- Cleaning your vehicle
 - engine compartment277
 - instrument panel279
 - interior279
 - plastic parts278
 - washing276
 - waxing276
 - wheels277

Index

- wiper blades278
- Climate control (see Air conditioning or Heating)101
- Clock128
- Compass, electronic
set zone adjustment118
- Console
overhead117
rear136, 144
- Controls
power seat163
steering column135
- Coolant
checking and adding291
refill capacities295, 312
specifications314, 316
- Cruise control
(see Speed control)132
- Customer Assistance251
 - Ford accessories for your vehicle280
 - Ford Extended Service Plan273
 - Getting assistance outside the U.S. and Canada274
 - Getting roadside assistance ...251
 - Getting the service you need267
 - Ordering additional owner's literature274
 - The Dispute Settlement Board269
 - Utilizing the Mediation/Arbitration Program272
- D**
- Daytime running lamps
(see Lamps)106
- Defrost
rear window104
- Dipstick
automatic transmission
fluid308
engine oil285
- Doors
lubricant specifications314
- Driving under special conditions247
through water250
- E**
- Emergencies, roadside
jump-starting260
- Emergency Flashers252
- Emission control system305
- Engine316
 - cleaning277
 - coolant291
 - fail-safe coolant296
 - idle speed control289
 - lubrication
specifications314, 316
 - refill capacities312
 - service points284
 - starting after a collision252
- Engine block heater238
- Engine oil285
 - change oil soon warning, message center285
 - checking and adding285
 - dipstick285
 - filter, specifications288, 311
 - recommendations288
 - refill capacities312
 - specifications314, 316
- Exhaust fumes238

324

Index

F

- Fail safe coolant296
- Floor mats145
- Fluid capacities312
- Fuel297
 - calculating fuel
 - economy120, 139, 302
 - cap299
 - capacity312
 - choosing the right fuel300
 - comparisons with EPA fuel
 - economy estimates305
 - detergent in fuel301
 - filling your vehicle with
 - fuel297, 299, 302
 - filter, specifications301, 311
 - fuel filler door override144
 - fuel filler door release144
 - fuel pump shut-off switch252
 - improving fuel economy302
 - octane rating301, 316
 - quality301
 - running out of fuel301
 - safety information relating to
 - automotive fuels297
- Fuses253–254

G

- Gas cap (see Fuel cap)299
- Gas mileage
(see Fuel economy)302
- Gauges15

H

- Hazard flashers252
- Head restraints162
- Headlamps105

- aiming107
 - autolamp system105
 - bulb specifications110
 - daytime running lights106
 - flash to pass106
 - high beam106
 - replacing bulbs111
 - turning on and off105
- Hood283

I

- Ignition235, 316
- Infant seats
(see Safety seats)196
- Inspection/maintenance (I/M)
testing307
- Instrument panel
 - clearing279
 - cluster10
 - lighting up panel and
 - interior107

J

- Jack209
 - positioning209
 - storage209
- Jump-starting your vehicle260

K

- Keyless entry system155
- Keys
 - positions of the ignition235

L

- Lamps
 - autolamp system105

Index

- bulb replacement
 - specifications chart110
 - daytime running light106
 - headlamps105
 - headlamps, flash to pass106
 - instrument panel, dimming ...107
 - interior lamps109–110, 114
 - replacing bulbs109, 111–113
- Lane change indicator
(see Turn signal)108
- Lights, warning and indicator10
 - anti-lock brakes (ABS)239
- Load limits225
- Locks
 - childproof147
 - doors146
- Lubricant specifications ...314, 316
- Lug nuts215
- Lumbar support, seats163
- M**
- Message center138
 - english/metric button142
 - reset button139
 - warning messages126
- Mirrors116, 130
 - automatic dimming rearview mirror130
 - fold away132
 - heated131
 - programmable memory154
 - side view mirrors (power)131
- Moon roof137
- Motorcraft parts301, 311
- N**
- Navigation system38
- cd functions56
- destination mode79
- DVD location99
- map mode60
- quick start40
- radio functions48
- O**
- Octane rating301
- Oil (see Engine oil)285
- P**
- Parking brake240
- Parts (see Motorcraft parts)311
- Passenger Occupant Classification Sensor169
- Pedals (see Power adjustable foot pedals)132
- Power adjustable foot pedals ...132
- Power distribution box (see Fuses)257
- Power door locks146
- Power mirrors131
- Power point128
- Power steering242
 - fluid, checking and adding ...307
 - fluid, refill capacity312
 - fluid, specifications314
- Power trunk143–144
- Power Windows129
- R**
- Radio30
- Rear window defroster104
- Relays253

Index

- Remote entry system
 illuminated entry153
 locking/unlocking doors150
 opening the trunk151
Reverse sensing system248
Roadside assistance251
- S**
- Safety Belt Maintenance182
Safety belts (see Safety restraints)167, 170, 172–175
Safety defects, reporting275
Safety restraints167, 170, 172–175
 belt minder177
 extension assembly181
 for adults172–174
 for children193
 lap belt175
 Occupant Classification
 Sensor169
 safety belt maintenance182
 warning light and chime 176–177
Safety seats for children196
Seat belts
 (see Safety restraints)167
Seats162
 child safety seats196
 easy access/easyout feature ..166
 memory seat154, 166
Servicing your vehicle282
Spark plugs, specifications311, 316
Specification chart,
 lubricants314, 316
Speed control132
Starting your vehicle235–237
 jump starting260
Steering
 speed sensitive242
Steering wheel
 controls135
 tilting116
- T**
- Tilt steering wheel116
Tires204–205, 209
 alignment222
 care220
 changing209, 211
 checking the pressure207
 inspecting and inflating206
 label220
 replacing209
 rotating223
 safety practices221
 sidewall information215
 snow tires and chains224
 spare tire210
 terminology205
 tire grades205
 treadwear204, 220
Towing231
 recreational towing234
 trailer towing231
 wrecker266
Traction control241
Traction-lok rear axle247
Transmission243
 brake-shift interlock (BSI)243
 fluid, checking and adding
 (automatic)308
 fluid, refill capacities312
 lubricant specifications ..314, 316
Trunk147
 remote release143, 151

Index

Turn signal108

V

Vehicle dimensions316

Vehicle Identification Number
(VIN)319

Vehicle loading225

Ventilating your vehicle238

W

Warning lights (see Lights)10

Water, Driving through250

Windows

power129

Windshield washer fluid and

wipers115

replacing wiper blades115

Wrecker towing266