

Audiodesign

Blu-ray Audio System
MediaVision 3D



Operating Manual

LOEWE.

34995022





Brief instructions



Preparation

- TV Mode 
- MediaVision Mode  press briefly
- Switch device on/off 
- Insert disc Sensor button  Insert disc 











Operating modes

- Select operating mode   Movie - Music - Photos -
Inputs - FM Radio - **OK**





















Sound

- Volume **V+/-**
- Sound Mode  (press several times)
- Sound mute/On 

Playback

- Playback 
- Pause 
- Stop (Continue) 
- Stop  
- Search forwards  press longer, then press several times
- Search backwards  press longer, then press several times
- Next/Previous chapter **P+/-**
- Single image  (press several times)
- Slow motion   / 
press longer, then press several times





Other functions

- Call up menu 
- Close menu 
- Title Menu  
- Pop-up menu (Blu-ray Disc™)  
- Disc Menu (DVD)  
- Source selection  
- Title recognition 
- Repeat  (press several times) **OK**
- Zoom Menu 
- Zoom out  
- Zoom in  
- Screen off/on (Music) 
- Set flag 
- Call up flag  long press  **OK**

BD-LIVE™

- Pop-up menu (Blu-ray Disc™)   Submenu/Menu BD-LIVE™
 **OK**

Radio

- FM Radio Mode   FM Radio **OK**
- Station search  long press
- Select station up/down. **P+/-**
- Select source **SRC**
- FM Radio Mode  long press

Index of key words

Symbols

3D Mode 19

A

Angle 30

Area Code 22, 27

Assist remote control 4

Audio 20

Audio channels 29

Automatic search 39

Auto Power Off 25

B

BD-LIVE™ 33

BD-LIVE™connection 24

Blu-ray disc memory 25

Brief instructions 3

C

Center-Kanalwiedergabe bei Loewe TV-Geräten 21

Chapter / Track selection 29

Cleaning 10

Connection options 8

Country code list 44

D

Default settings 25

Digital audio formats 29

Digital Link HD 16

Disc languages 18

Disc Menu 32

Disc playback 29

Display 19

DivX® VOD 25

DRC 20

E

Ejecting the disc 27

Environment 41

F

Film language 29

Flagging 30

Flagging the last scene 31

FM Radio 39

Freeze frame 28

Front / Rear view 7

G

Glossary 43

H

Handling discs 27

HDMI CEC 16

HDMI colour setting 19

I

Importing Audio CDs 40

Importing Music 40

Initialize 25

Inserting discs 27

Intended Use 10

iPod playback 38

L

Language 18

Language code list 44

Legal information 45

Lock 21

M

Main Menu 17, 34

Manual search 39

Media files 34

Movie Information 30

Music files 36

N

Navigation in the menu 17

Network 23

Night Mode 20

O

Operating Loewe Equipment 15

Optional extensions 9

P

Password set-up 22

Performance 8

Photo files 37

Picture format 19

Picture-for-picture playback 28

Picture Mode 30, 32

Playback in general 28

Playing discs 27

Preamplifier 21

Preconditions 27

R

Regional code 27

Repeat 28, 31

Resolution 19

S

Safety 10

Scope of supply 9

Searching 28

Setting radio stations 39

Settings 17

Set-up 9

Sleep Timer 41

Slide show 37

Slow motion 28

Sound functions 15

Source selection 41

Start-up 15

Subtitles 30, 35

Supervision 10

Switching on/off 16

Symbols 27

T

Technical Data 45

Time 29

Title selection 29

Trademark rights 46, 47

Troubleshooting 42

U

Updating software 26

USB Mode 35

V

Video files 34

W

Wireless Audio Link 20

Z

Zoom 31

Contents

| | |
|--|-----------|
| Brief instructions | 3 |
| Assist remote control – MediaVision 3D Mode | 4 |
| Front / Rear view | 7 |
| Performance Features | 8 |
| Welcome | 9 |
| Scope of supply | 9 |
| Optional extensions | 9 |
| Set-up | 9 |
| For your safety | 10 |
| About these operating instructions | 10 |
| Connection | 11 |
| MediaVision 3D as an audio system | 11 |
| MediaVision 3D as an audio system (SL155) | 12 |
| MediaVision 3D as an audio system (SL2xx) | 13 |
| MediaVision 3D as a Player | 14 |
| Startup | 15 |
| Using the Assist remote control | 15 |
| Operating Loewe Equipment | 15 |
| Connecting to the mains supply | 16 |
| Switching on/off | 16 |
| Digital Link HD | 16 |
| Digital Link HD (HDMI CEC) | 16 |
| Navigation in the menu | 17 |
| Main Menu | 17 |
| Setup Menu | 17 |
| Language Menu | 18 |
| Menu Display | 19 |
| Audio Menu | 20 |
| Dolby PL II Menu | 21 |
| Lock Menu | 22 |
| Network Menu | 23 |
| Others Menu | 25 |
| Software updating | 26 |
| Playing discs | 27 |
| Prerequisites | 27 |
| Playback in general | 28 |
| Disc playback | 29 |
| Flagging the last scene | 31 |
| Disc Menu | 32 |
| Picture Mode | 32 |
| BD-LIVE™ | 33 |
| Sound functions | 33 |
| Playing media files | 34 |
| Main Menu | 34 |
| Video files | 34 |
| USB Mode | 35 |
| Music files | 36 |
| Photo files | 37 |
| Playback from iPod | 38 |
| Connecting the iPod | 38 |
| iPod playback | 38 |
| Setting the radio stations | 39 |
| Listening to the radio | 39 |
| Importing Music | 40 |
| Importing Audio CDs | 40 |
| Sleep Timer | 41 |
| Source selection | 41 |
| Environment | 41 |
| Troubleshooting | 42 |
| Glossary | 43 |
| Language code list | 44 |
| Country code list | 44 |
| Technical data | 45 |
| Legal information | 45 |
| Trademark rights | 46 |
| Declaration of conformity | 47 |
| Service | 48 |

Front / Rear view

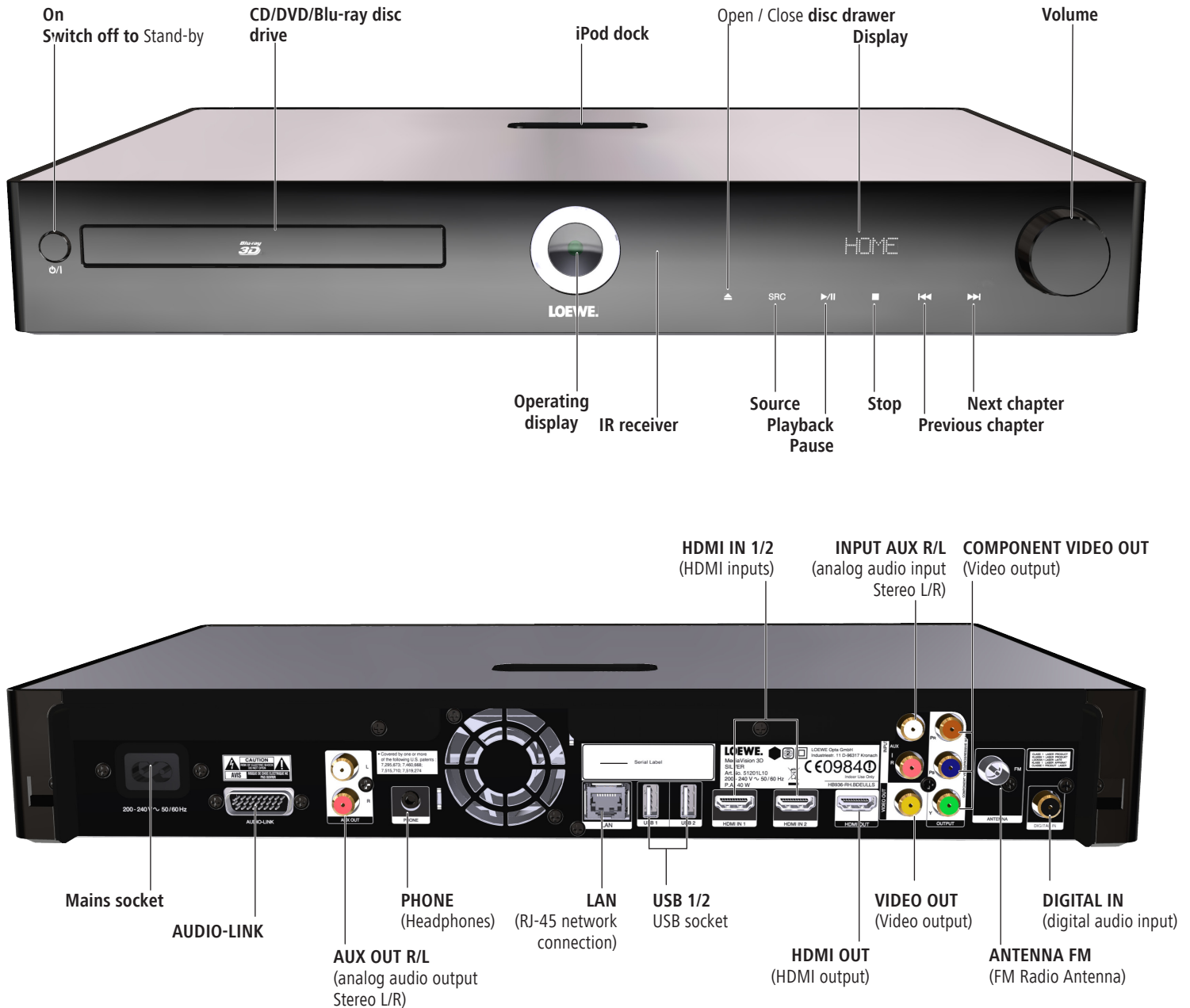

Performance Features

Your **Loewe MediaVision 3D** offers you convenient access to your media collection. It plays Blu-ray Discs™ in 2D/3D format, audio CDs and video DVDs. You can also play digital video, photo and music files from a USB stick and from data discs.

Connection options

2x USB 2.0 (connection from Flash memory or hard disc)
2x HDMI IN (HDMI input) without CEC
HDMI OUT (HDMI output) with CEC
VIDEO OUT (Video output)
COMPONENT VIDEO OUT (Component-video output)
AUX IN (Analog audio input stereo L/R)
AUX OUT L/R (Analog audio output stereo L/R)
DIGITAL IN (digital audio input)
LAN (Network connection)
PHONE (Headphone output)
ANTENNA FM (FM Radio Antenna)
AUDIO-LINK (cabled system connection to Loewe sound systems)
WIRELESS AUDIO-LINK (wireless system connection to Loewe sound systems)

Blu-ray™/CD/DVD Player

Playing Blu-ray™ 2D and 3D discs
Playing audio CDs, CD-R and CD-RW discs
Playing DVD video, DVD-ROM and DVD-RW discs
DVD upscaling (720p/1080p)
Operation via touch-sensitive sensor buttons on the device and **Assist** remote control

Media management

DLNA streaming client
BD/DVD/CD/File Title recognition via Internet databases
Displaying ID3v1 and ID3v2 meta data
Displaying album graphics
Importing meta data from the Internet
Importing audio CDs

Music playback

Integrated 5.1 Dolby Digital Decoder
Playing MP3, WMA, AAC audio files
Repeating titles, tracks or directories
Random playback
Playing wired audio sources at AUX IN

Video playback

Playing DivX(HD) video files
Displaying subtitles
Resume function

Photo display

Displaying JPEG, PNG photo files
Slide show with music

iPod support

iPod docking station
Audio playback
Easy control by remote control Loewe Assist
Charge battery

Radio

FM radio with RDS display via cable or terrestrial means
Memory for 50 radio stations

Use with other Loewe system components

Connection of Loewe flat TV sets via Digital Link HD (HDMI CEC) (from chassis L271x - a software update for the TV set might be required) and operation with a single **Assist** remote control - also for concealed set-up of the **MediaVision 3D**.

Welcome

Thank you,

for choosing a Loewe product. We are happy to have you as a customer. At Loewe we combine the highest requirements regarding technology, design and ease of use. This applies equally for TV, DVD, video, audio and accessories. Neither technology nor design is an end in itself, but both are intended to provide our customers with the best possible audio and visual experience. Our design is not influenced by short-term, fashionable trends. You have, after all, purchased a high-quality piece of equipment which you do not want to tire of tomorrow or the day after.

Scope of supply

- MediaVision 3D
- Assist remote control with 2 batteries
- HDMI cable
- Antenna
- Cinch cable for digital sound
- Stereo-Cinch cable
- Adapter cable for centre channel of the TV (art. no. 009-70784.001)
- Adapter cable for centre channel of the TV (art. no. 009-71387.001)
- Network cable
- Mains cable
- These instructions for use

Optional extensions

- Loewe TV set with HDMI input
- Loewe Individual Sound Subwoofer / Highline / Compact
- Loewe Individual Sound Speaker

Set-up

- Place unit on a stable, even surface.
- Do not set up the unit near strong heat sources or in direct sunlight.
- If setting up in a shelf or a closed cupboard: Leave at least 2.5 cm clearance around the unit, so that the air can circulate unhindered and there is no heat backup.
- The picture and sound of a TV set, a player or a radio in the vicinity can be distorted. If this is not the case, do not place the unit in the direct vicinity of these devices.
- Set up the device so that the infrared signal of the remote control can reach the display of the player without hindrance (or if this is not possible, see "Digital Link HD (HDMI CEC)" page 40).
- Do not place any strong artificial light source in front of the unit. This could have a detrimental effect on the infrared reception.
- Incorrect voltages can damage the unit. This device may only be connected to a powersupply with the voltage and frequency indicated on the type plate.
- Pull out the power cable during thunderstorms. A voltage surge caused by lightning conducted through the mains could damage the unit.
- If the unit is not to be used for an extended period, the plug should also be disconnected from the mains.
- The power plug of the TV set must be easily accessible so that the TV can be disconnected from the power supply at all times.
- Position the mains cable in such a way that it can not be damaged. The power cable may not be kinked or laid over sharp edges, stood on or exposed to chemicals; the latter also applies to the unit as a whole. A power cable with damaged insulation can cause electric shocks and poses a fire risk.
- When you want to unplug from the mains, pull on the plug housing rather than on the cable. The cables in the mains plug could otherwise be damaged and could cause a short-circuit when plugged in again.

Please note and follow the safety information on the following pages.

For your safety

For your safety, and to avoid unnecessary damage to your unit, please read and follow the safety advice below.

Please keep the safety information in a safe place.

Use for the intended purpose and ambient conditions

This unit is intended exclusively for playing visual and audio signals. It is designed for living or office rooms and may not be used in rooms with a high level of **humidity** (e.g. bathroom, sauna) or a high **dust concentration** (e.g. workshops).

The terms of the warranty only cover the intended use of the unit.

If the unit is used outdoors, make sure that it is protected from **moisture** (rain, drips, sprayed water or dew).

High humidity and dust concentrations lead to leakage currents in the device, this can result in a contact risk with voltages or a fire.

If you have moved the unit out of the **cold** into a warm environment, leave it switched off for about an hour to avoid the formation of **condensation**.

Ensure that your system (**MediaVision 3D**, TV set and other connected components, if any) are switched off before you connect or disconnect other devices or speakers.

Protect your device from:

- Water, dampness, dripping and sprayed water or steam.
- Knocks and mechanical stress.
- Magnetic and electric fields.
- Cold, heat, direct sunlight and high temperature fluctuations.
- Dust.
- Covers that inhibit ventilation.
- Interference with the internal workings of the unit.



Do not place objects containing liquids on top of the unit.



Candles and other open flames must be kept away from the unit at all times to prevent the spread of fire.

Do not cover ventilation slits with magazines or rugs. Pay attention to curtains etc. here, for example.



ATTENTION: TO PREVENT THE RISK OF AN ELECTRIC SHOCK, DO NOT REMOVE THE COVER. THERE ARE NO PARTS INSIDE THE UNIT THAT CAN BE REPAIRED BY THE USER. REPAIRS SHOULD ONLY BE CARRIED OUT BY A LOEWE DEALER.

Only use Original accessories and spare parts from Loewe.

Supervision

Do not let **children** loiter unsupervised around the device. Do not let children play in the immediate vicinity of the device. Do not operate your **MediaVision 3D** unsupervised. Disconnect the device from the mains if absent for a longer period.

Cleaning

Only clean your unit with a slightly damp, soft, clean cloth (without any aggressive or scouring cleaning agents).

Volume

Loud music can result in impaired hearing. Avoid extreme volumes, especially over longer periods and if you use headphones.

About these operating instructions

The information in these instructions refers to the Loewe product **MediaVision 3D**.

Unless stated otherwise, the instructions refer to the operating elements on the **Assist** remote control.

Paragraphs beginning with the **■** symbol indicate important hints, tips or conditions for perfect operation.

Terms which you will find in the menu or printed on the unit are printed in **bold** type.

In the functional descriptions, the necessary operating elements are arranged to the left of the text containing the handling instructions.

The diagrams in these operating instructions are only by way of example. However, the actual display can differ.

Connection

MediaVision 3D as an audio system

This is the recommended configuration in conjunction with all TV sets from Loewe or other manufacturers. The audio signals are processed via **MediaVision** in this configuration.

Connect the **HDMI OUT** socket of the **MediaVision 3D** to an **HDMI IN** socket on your Loewe TV set using the HDMI cable provided.

If your TV set does not have an HDMI IN socket, connect the three sockets **COMPONENT VIDEO OUT** of the **MediaVision 3D** with three video-compatible Cinch cables to the **COMPONENT IN** sockets on your TV set.

You can also make the connection to a TV set with a video-compatible Cinch cable via the **VIDEO OUT** socket.

Use an RJ-45 network cable to connect **MediaVision 3D** to a network connection (e.g. Switch or DSL router) with a connection to the Internet/Homenetwork.

Use an Audio-Link cable to connect the **AUDIO-LINK** socket of your **MediaVision 3D** to a compatible socket of the Loewe subwoofer. Should you wish to reproduce the centre channel through your TV set, use the adapter provided (art. no. 009-70784.001). Connect it to the **AUDIO-LINK** socket of **MediaVision 3D** and the AUDIO-LINK cable to the subwoofer, as well as the Centre-IN socket of the TV set. (see page 21).

To be able to reproduce the sound of the TV set, e.g. DVB radio, via your **MediaVision**/subwoofer system, create an audio connection between the TV set and **MediaVision 3D**. Where possible, you should use the cinch cable for digital sound; connect it to the **AUDIO DIGITAL OUT** socket on the TV set and to the **DIGITAL IN** socket on the **MediaVision**.

Alternatively, you can connect the analog stereo audio signal of the TV set via a stereo Cinch connection to the sockets **INPUT AUX R/L** on **MediaVision**.

Connect the **ANTENNA FM** socket of the **MediaVision 3D** to the antenna provided. Plug the small plug of the mains cable into the rear of the unit (page 7) and then plug the large plug of the mains cable into a 220-240V 50/60 Hz socket.

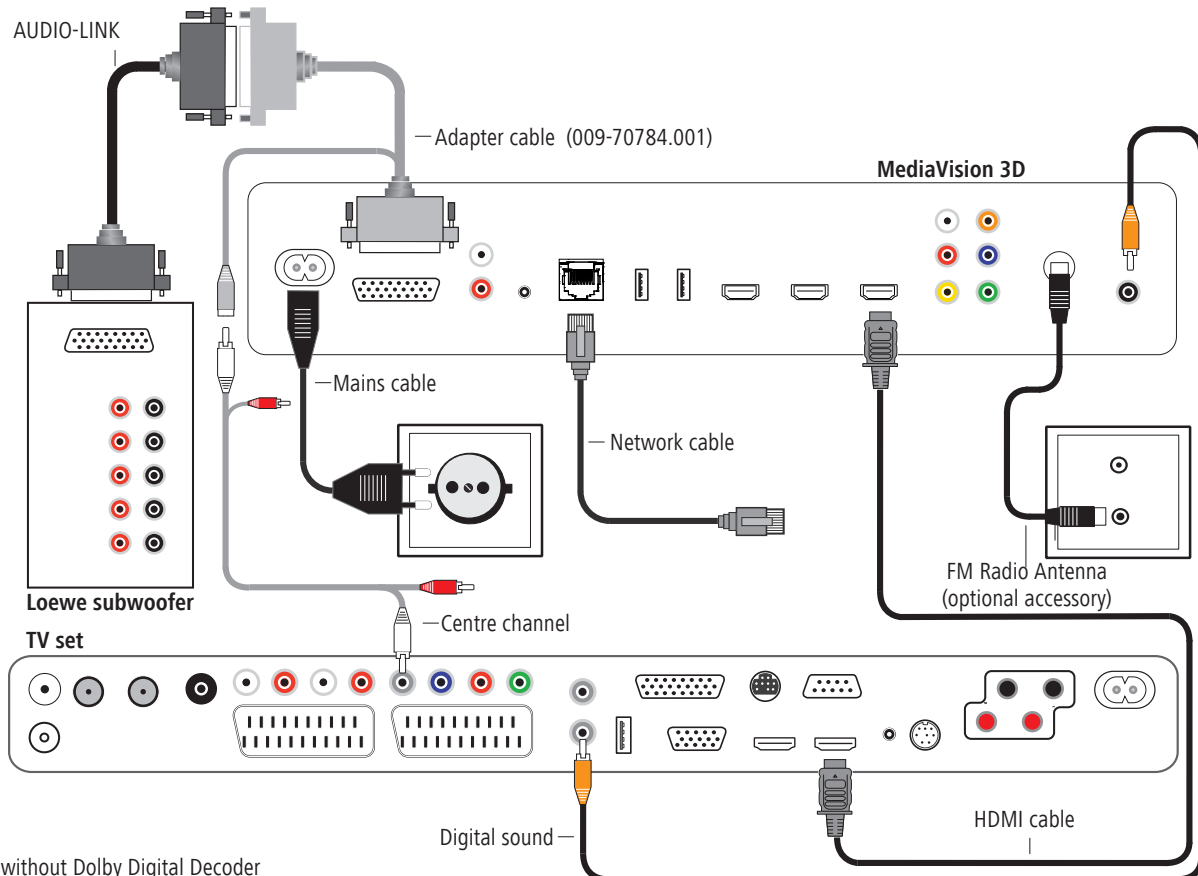

* for TV sets without Dolby Digital Decoder

Connection

MediaVision 3D as an audio system (SL155)

This is the recommended configuration with **MediaVision 3D** as an audio system in conjunction with Loewe **Connect ID** (chassis SL155; TV as centre and with HDMI-ARC: Audio Return Channel). The audio signals are processed via **MediaVision** in this configuration.

Connect the **HDMI OUT** socket of the **MediaVision 3D** to an **HDMI 1** socket on your Loewe TV set using the HDMI cable provided.

Use an RJ-45 network cable to connect **MediaVision 3D** to a network connection (e.g. Switch or DSL router) with a connection to the Internet/Homenetwork.

Connect the **ANTENNA FM** socket of the MediaVision 3D to the antenna provided.

Use an Audio-Link cable to connect the **AUDIO-LINK** socket of your **Media-Vision 3D** to a compatible socket of the Loewe subwoofer. Should you wish to reproduce the centre channel through your TV set, use the adapters provided (art. no. 009-70784.001 / 009-71387.001). Connect the adapter 009-70784.001 to the **AUDIO-LINK** socket of **MediaVision 3D** and the AUDIO-LINK cable to the subwoofer, as well as the Centre-IN socket of the adapter 009-71387.001 on the TV set. To be able to reproduce the sound of the TV set, e.g. DVB radio, via your **MediaVision**/subwoofer system, set the option **TV input to HDMI output -ARC** (page 21).

Plug the small plug of the mains cable into the rear of the unit (page 7) and then plug the large plug of the mains cable into a 220-240V 50/60 Hz socket.

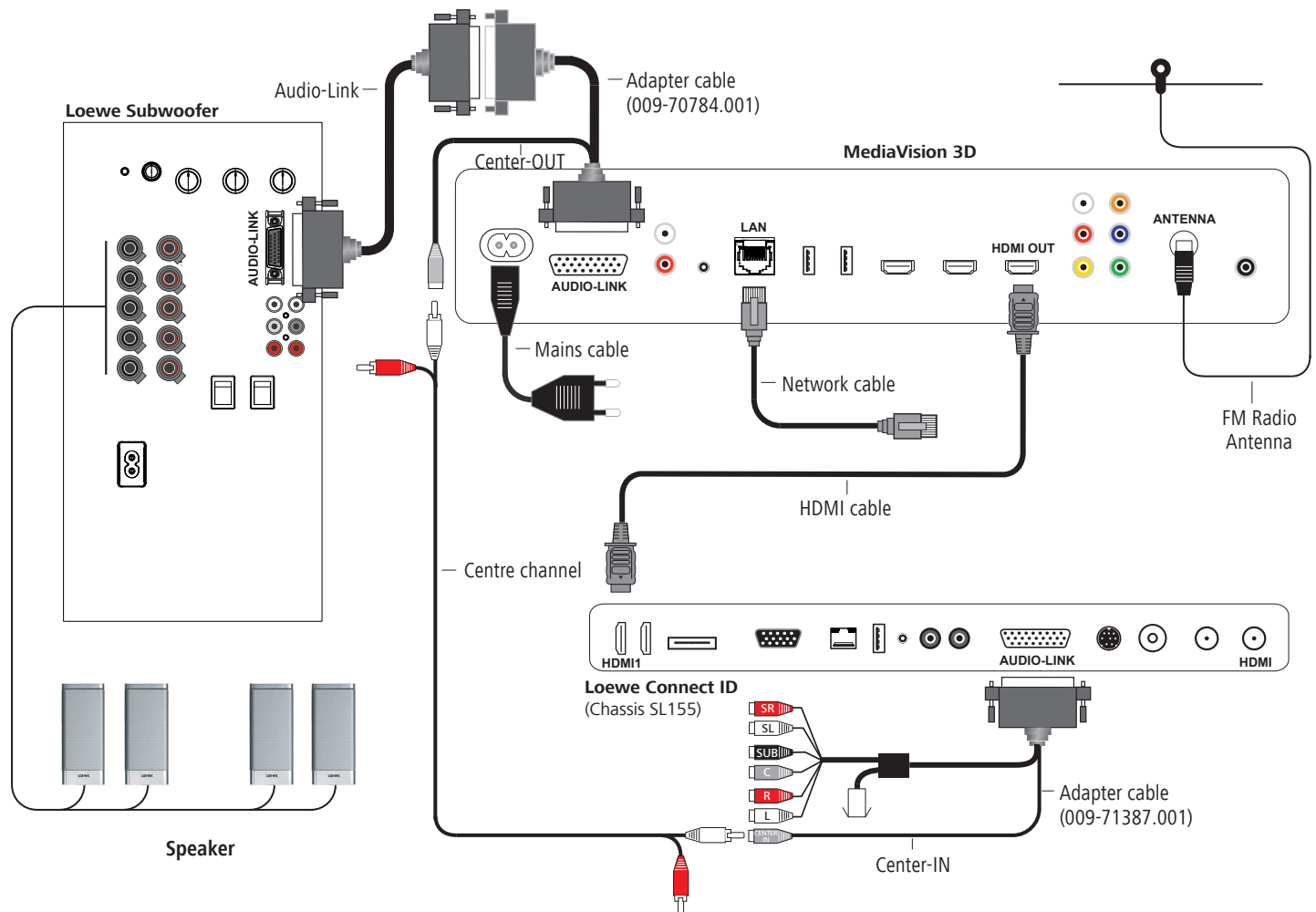

Connection

MediaVision 3D as an audio system (SL2xx)

This is the recommended configuration with **MediaVision 3D** as an audio system in conjunction with Loewe TV sets with chassis SL2xx (TV as centre and with HDMI-ARC: Audio Return Channel). The audio signals are processed via **MediaVision** in this configuration.

Connect the **HDMI OUT** socket of the **MediaVision 3D** to an **HDMI 1** socket on your Loewe TV set using the HDMI cable provided.

Use an RJ-45 network cable to connect **MediaVision 3D** to a network connection (e.g. Switch or DSL router) with a connection to the Internet/Homenetwork. Connect the **ANTENNA FM** socket of the MediaVision 3D to the antenna provided.

Use an Audio-Link cable to connect the **AUDIO-LINK** socket of your **MediaVision 3D** to a compatible socket of the Loewe subwoofer. Should you wish to reproduce the centre channel through your TV set, use the adapter provided (art. no. 009-70784.001). Connect it to the **AUDIO-LINK** socket of **MediaVision 3D** and the AUDIO-LINK cable to the subwoofer, as well as the Centre-IN socket of the TV set. (page 21).

To be able to reproduce the sound of the TV set, e.g. DVB radio, via your **MediaVision**/subwoofer system, set the option **TV input to HDMI output -ARC** (page 21).

Plug the small plug of the mains cable into the rear of the unit (page 7) and then plug the large plug of the mains cable into a 220-240V 50/60 Hz socket.

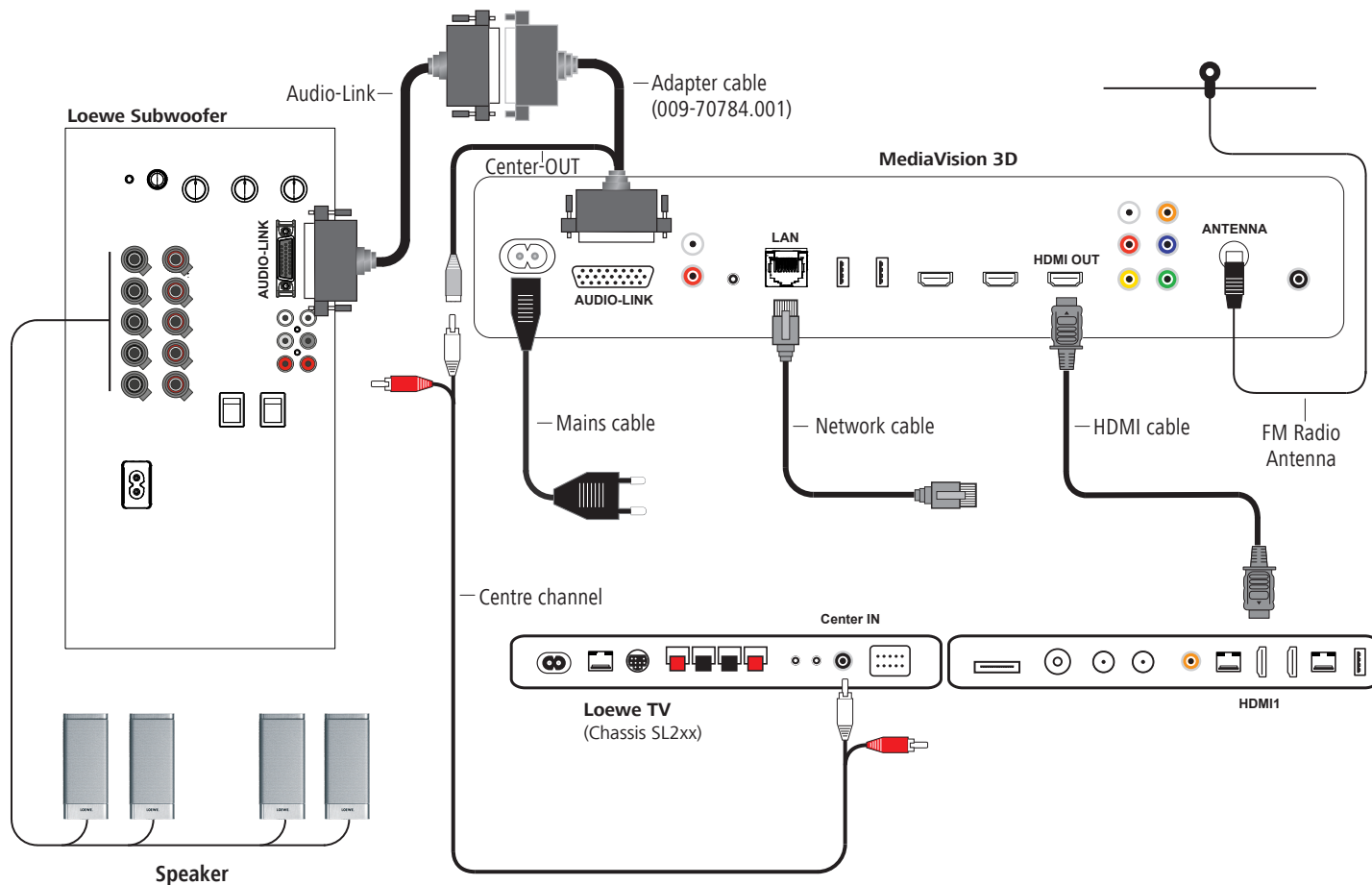

Connection

MediaVision 3D as a Player

The audio signals are processed via your TV set in this configuration. **MediaVision** serves as an audio and video source*.

Connect the **HDMI OUT** socket of the **MediaVision 3D** to an **HDMI IN** socket on your TV set using the HDMI cable provided.

Go to the **Audio** menu and set the option **Preamplifier** to **off** (page 21)

Use an RJ-45 network cable (available from your dealer) to connect **MediaVision 3D** to a network connection (e.g. Switch or DSL router) with a connection to the Internet/Homenetwork.

Connect the **ANTENNA FM** socket via an FM antenna cable (available from your dealer) to an antenna socket, or use the antenna provided at this socket.

Plug the small plug of the mains cable into the rear of the unit (page 7) and

then plug the large plug of the mains cable into a 220-240V 50/60 Hz socket.

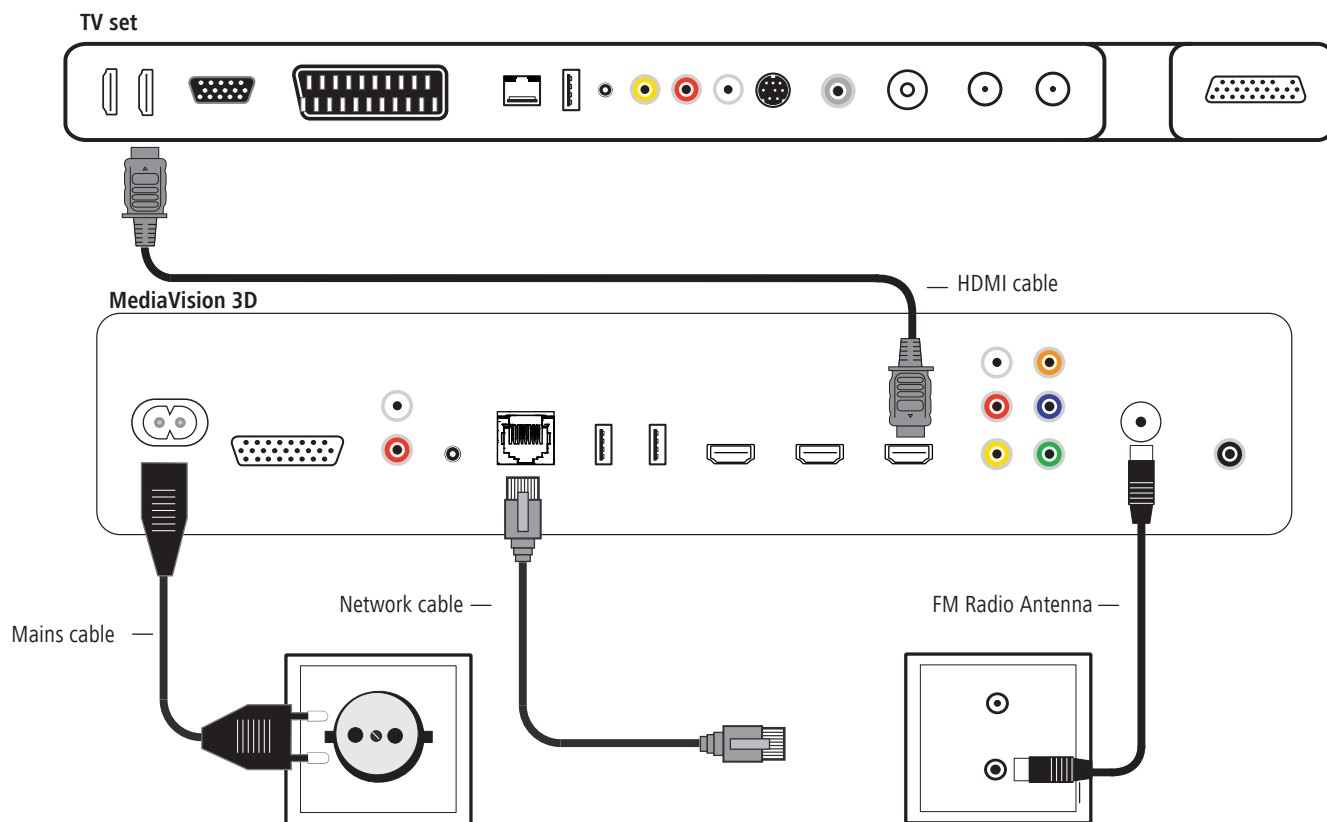

Startup

Using the Assist remote control



To insert or change the batteries, press where the arrow is embossed on the casing. While doing so, simply slide the battery compartment lid down and remove it. Insert alkaline manganese batteries LR 03 (AAA) and ensure the correct position of + and -. Slide the cover on again from the bottom.

- Do not insert rechargeable batteries in the battery compartment of the remote.
- The batteries used must not be exposed to excessive heat such as sunlight, fire or similar!

Setting up the Assist remote control

Other devices

You can operate various Loewe devices using the **Assist** remote control. The unit buttons **REC - DVD - AUDIO** can be set for this.

- AUDIO** Press the required unit button and the Stop button simultaneously for 5 sec. until the corresponding LED indicator light flashes twice.

Then select the two-digit unit code from the table:

| Device | Code | Factory setting |
|----------------------------|------|-----------------|
| Loewe ViewVision DR+ DVB-T | 13 | REC |
| Loewe BluTechVision | 15 | |
| Loewe TV Radio digital | 19 | |
| Loewe Mediacenter | 20 | |
| Loewe BluTechVision 3D | 21 | DVD |
| HDMI CEC Modus | 22 | |
| Loewe Sound Projector SL | 25 | |
| SoundBox | 28 | |
| SoundVision | 29 | |
| Air Speaker | 30 | |
| Loewe MediaVision 3D | 35 | AUDIO |
| Restore defaults | 99 | |

The corresponding LED indicator light flashes twice.

Sound functions

It is possible to set the devices with which the buttons with the sound functions (**V+/-**, **Mute** and **sound mode**) should work.

- TV** **3** def Press the device button **TV** and, at the same time, the button with the single digit function code from the list, for 5 sec. until the LED Display flashes twice.

| Function | Code | Figure |
|----------------------|------|----------------|
| Loewe MediaVision * | 3 | page 11, 12,13 |
| Loewe Mediacenter | 4 | |
| Loewe TV | 5 | page 14 |
| Loewe Soundprojector | 6 | |

* Default setting

Operating Loewe Equipment

Using the remote control for a Loewe TV set

- TV** Press **TV** button; the LED Display above it lights up for approx. 5 seconds

Using the remote control for a Loewe recorder

- REC** Press the **REC** button; the LED Display above it lights up for approx. 5 seconds

Using the remote control for BluTechVision 3D

- DVD** Press the **DVD** button; the LED Display above it lights up for approx. 5 seconds

Using the remote control for MediaVision 3D

- AUDIO** Press the **AUDIO** button; the LED Display above it lights up for approx. 5 seconds

Every time a button is pressed, the LED indicator lights up for the selected operating mode to allow you to check (**TV - REC - DVD - AUDIO**). Please refer to the respective operating instructions on how to operate the individual devices.

Start-up

Connecting to the mains supply

Plug the mains plug (page 7) into a mains socket 220-240V/50-60 Hz.

Switching on/off

AUDIO

Set the remote control for **MediaVision 3D** Mode by pressing the **AUDIO** button briefly.

Your **MediaVision 3D** switches on. If you have connected a Loewe TV set (L27xx/SL1xx/SL2xx) via HDMI, this will then switch on as well. Otherwise, switch your TV set on and set the respective AV programme slot.

➡ If necessary, you will have to set the operation of the **MediaVision 3D** for the AV socket used on your TV set (see, for example, under "Operating additional devices" in the relevant instructions for use of your TV set).

As soon as **MediaVision 3D** is ready for operation, the **operating display** lights up green (page 7).



To switch off the device, press the OFF/ON knob on the **MediaVision 3D** or once again on the **Assist** remote control .

Digital Link HD

With Digital Link HD, Loewe TV sets as well as other TV sets supporting the CEC standard send the remote control signals via the HDMI connection from the TV set to the **MediaVision 3D**. Select this function in the menu as described on page 20.

➡ The TV set must be switched on.



Select the AV programme slot for HDMI on the TV set.

As long as HDMI is selected as a programme slot, most TV remote control commands (**ASSIST** in TV Mode) are communicated to the connected HDMI device. However, the volume, sound ON/OFF and sound adjustment continue to respond to commands from the TV set. The AUDIO commands (**ASSIST** in AUDIO Mode) are not transmitted from the TV.

If you press the **TV button** for a longer time, you can toggle between HDMI and TV operation. Briefly pressing the **TV button** switches back to TV Mode.

TV

The **TV button** (press briefly) can be used to switch to the last station viewed in TV Mode and quit the device control.

➡ A software update might be necessary for your Loewe TV set. Please contact your dealer.

Digital Link HD (HDMI CEC)

With Digital Link HD, Loewe TV sets (chassis L271x, software \geq V9.2, SL 1xx, SL2xx) transmit the remote control signals via the HDMI connection from the Loewe TV set to compatible accessory units, e.g. **MediaVision 3D**. Digital Link HD is recommended if you wish to set up **MediaVision 3D** so that it is concealed and the complete device control is to occur via the Loewe TV set.

First set up the HDMI CEC function for the **Assist** remote control as described on page 15 with code 22 on the required device button (e.g. DVD).

Then assign the Digital Link HD function to the HDMI interface used on the TV set by pressing the button set above (e.g. DVD) for 5 seconds.

A selection menu appears.



▲ ▼ Select required unit (e.g. **MediaVision**).

Press **OK** to confirm.

The signals of the **Assist** remote control are now sent from the Loewe TV set to **MediaVision 3D**, if the relevant button on the unit (e.g. DVD) has been pressed beforehand.

➡ A software update might be necessary for your Loewe TV set. Please contact your dealer.

Start-up

Navigation in the menu

The arrow keys of the **Assist** remote control are shown as follows in these instructions for use:



The arrows correspond in the text: "▲▼◀▶".
The OK-button on the remote control is shown in the text as **OK**.



Call up the Main Menu.

◀▶▲▼ Select desired option.

◀ Move Back in the menu.



Close the menu.

Press **OK** to confirm.

Main Menu

The Main Menu of the **MediaVision 3D** is shown on the screen of the TV set connected. Here you can select the required functions.



Call up the Main Menu.

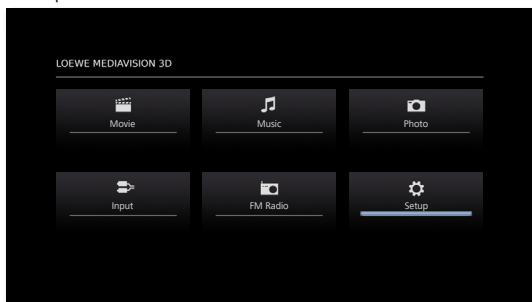

◀▶▲▼ Select the desired function.

Press **OK** to confirm.

Movie Display the **Movie** Menu (page 34) for playing video files or the Disc Menus

Music Display the **Music** Menu (page 36) for playing audio files

Photo Display the **Photo** Menu (page 37) for displaying photo files

Input Display the **Input** Menu (page 41) for playing wired audio sources

FM Radio Display the **FM Radio Menu** (page 39) for Radio Mode

Setup Display the **Setup** Menu (page 17), to make settings

➡ To call up the Main Menu, close any other menus that might be open with **END**.

➡ The menu items **Movie**, **Music**, **Photo** can be selected if a corresponding medium is available.

Setup Menu

The **Setup** Menu allows you to make any settings and adjustments that might be necessary to e.g. your TV set.

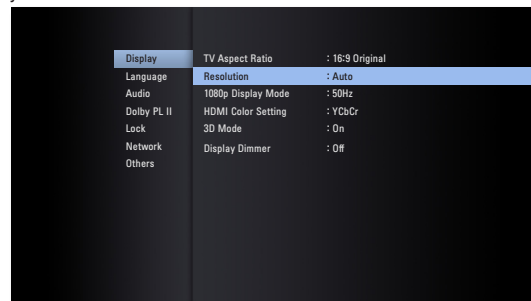

Call up the Main Menu.



◀▶▲▼ Select the **Setup** option.

▲▼◀▶▲▼ Select desired category.

▶▲▼ Select desired subcategory.

▲▼ Make desired setting.

Press **OK** to confirm.



Close the menu.

➡ If the blue bar for the menu selection appears in the first level (left), you will see the settings currently valid in the overview in the third level (right).

Start-up

Language Menu

Your **MediaVision 3D** attempts to automatically set the correct menu language via the HDMI-CEC connection to the same language as your Loewe TV set. You can also set the required menu language manually.

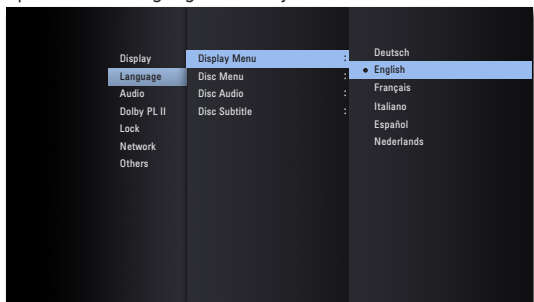

MEDIA

Call up the Main Menu.

◀ ▶ ▲ ▼ Select the **Setup** option.

▲ ▼ Select the **Language** option. Press **OK** to confirm.

▶ ▲ ▼ Select the **Display Menu** option.

Press **OK** to confirm.

▲ ▼ Select the required language.

Press **OK** to confirm.

END

Close the menu.

Disc languages

Select a language for the menu, the sound and the subtitles of the disc. If a language different to the "original" of the disc version is to be used, select this here if available on the disc.

▶ ▲ ▼ Select option **Disc Menu**, **Disc Audio** or **Disc Subtitle**.

▶ ▲ ▼ Select desired option.

OFF Switch off disc subtitles

Original The original language of the disc is selected.

Other Select another language (page 44).

Press **OK** to confirm.

END

Close the menu.

Start-up

Menu Display

In the **Display** Menu you can set the screen imaging of your **MediaVision 3D** on your TV set.

► These settings are automatically made by using the HDMI socket.

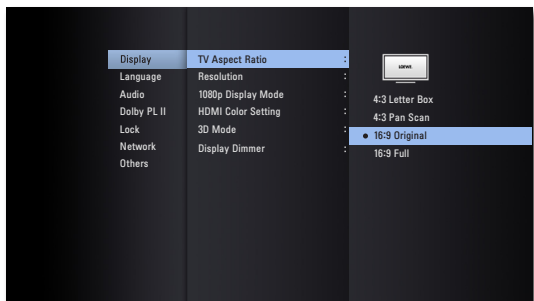

MEDIA

Call up the Main Menu.

◀ ▶ ▲ ▼ Select the **Setup** option.

▲ ▼ Select **Display** option.

Picture format

▶ ▲ ▼ Select **TV Aspect Ratio** option.

- 4:3 Letterbox** Select this setting if a standard TV set with 4:3 picture format is connected. Recordings in wide-screen format appear with a black bar at the top and bottom of the screen
- 4:3 Panscan** Select this setting if a standard TV set with 4:3 picture format is connected. The picture fills the entire screen, but crops the area on both sides if required.
- 16:9 Original** Select this settings if a wide-screen TV set with 16:9 picture format is connected. The 4:3 picture in the original picture format 4:3 is displayed with black bars on the left and right of the screen.
- 16:9 Full screen** Select this settings if a wide-screen TV set with 16:9 picture format is connected. The 4:3 picture is stretched horizontally so as to fill out the entire screen.

Press **OK** to confirm.

END

Close the menu.

Resolution

You can set the resolution of the video signal at the **HDMI OUT** and **COMPONENT VIDEO OUT** socket.

▶ ▲ ▼ Select the option **Resolution**.

- Auto** Recordings in wide-screen format appear with a black bar at the top and bottom of the screen
- 576i** Output in the 576 line Interlaced Mode (only component)
- 576p** Output in the 576 line Progressive Mode
- 720p** Output in the 720 line Progressive Mode
- 1080i** Output in the 1080 line Interlaced Mode
- 1080p** Output in the 1080 line Progressive Mode (only HDMI)

1080p display mode

Select the option **24Hz** to freely show Movies on HDMI-compatible TV sets with 1080 lines at 24Hz frame rate.

▶ ▲ ▼ Select the option **1080p display mode**.

24HZ Frame rate 24Hz for cinema Movies

50HZ Frame rate 50Hz for TV Movies

► Picture disturbances can occur when changing between video and Movie material in the **24Hz** setting. In this case, select the setting **50Hz**.

► Even if the option **1080p display** is set to **24Hz**, the actual frame rate of the video output will be specified at 50 Hz or 60 Hz depending on the format of the video source, if your TV set does not support the resolution 1080/24p.

HDMI colour setting

Select the video output signal depending on which video output socket you are using (page 11).

▶ ▲ ▼ Select the option **HDMI colour settings**.

YCbCr Socket **COMPONENT VIDEO OUT**

RGB Socket **HDMI OUT**

3D Mode

You can switch the 3D display of BD discs on/off.

▶ ▲ ▼ select the option **3D Mode**.

ON 3D playback at **HDMI OUT**

OFF 3D playback in 2D

Dimming the display

You can reduce the brightness of the display.

▶ ▲ ▼ Select the option **Display Dimmer**.

ON The display brightness is reduced

OFF The display brightness is normal

Start-up

Audio Menu

You can make various sound settings in the **Audio Menu**.

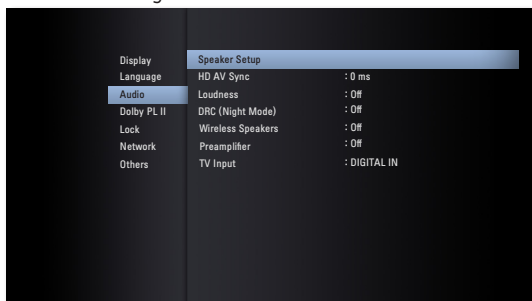

MEDIA

Call up the Main Menu.

- ◀ ▶ ▲ ▼ Select the **Setup** option.
- ▲ ▼ Select the **Audio** option.

Speaker set-up

If you have connected a speaker system to **MediaVision** (page 11), you can make the necessary settings here.

Press **OK** to confirm.

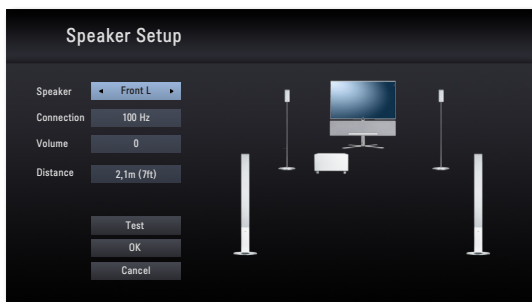

- ◀ ▶ ▲ ▼ Select desired option.

Speaker Select the speaker to be set

Connection Select the limit frequency of the selected speaker (see its technical data). To use the TV loudspeaker as the centre loudspeaker, select the option **Center** (page 21) in the **Speaker** settings and select the option **TV** in the **Connection** settings.

Volume Set the volume level of the selected speaker so that you can hear it at the listening position with the same volume as the other speaker

Distance Set the distance from the speaker to your listening position

Test Switch on the test signal for setting the volume off/on

Confirm with **OK**.

Audio delay (HD AV Sync)

If you use the HDMI socket, you can set an audio delay (for e.g. lip synchronous sound transmission).

- ▲ ▼ Set a value between **0** and **300 ms** (for the configuration shown in page 11 set 100 ms).

DRC (Night Mode)

You can use the DRC function to limit the dynamics (in other words, the difference between the loudest and quietest sounds). In this way, you can also play a Movie with lower volume differences (e.g. at night).

- Auto** Select this option if you wish to play audio signals with the coding Dolby True HD with reduced dynamics
- OFF** Audio signals are played with the full dynamic range
- ON** Select this option if you wish to play audio signals with the coding Dolby Digital or Dolby Digital Plus with reduced dynamics

Wireless Speaker

A system interface **Wireless Audio-Link** is integrated in your **MediaVision 3D**. You can use this to connect your compatible Loewe subwoofer to **MediaVision 3D** without any annoying cables. This connection must be registered once.

Call up the **Setup** Menu.

- ▲ ▼ Select the **Audio** option.
- ▶ ▲ ▼ Select the option **Wireless Speaker**. Press **OK**.

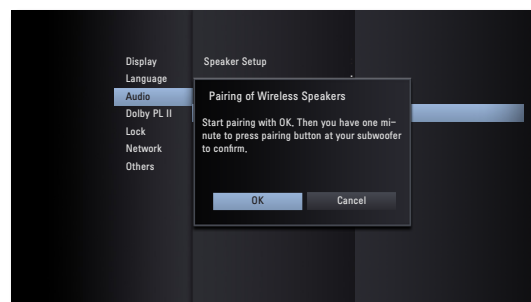

Select the **On** option. Press **OK** to confirm.

You now have a minute time in which you can press the button for the coupling mode for your compatible Loewe subwoofer. A notice will appear if the registration is successful. If the registration is not successful, please try again and reduce the distance between the subwoofer and **MediaVision**.

Start-up

Loudness

If you activate the setting, the frequency response will be corrected in relation to the volume (hearing compensated volume).

ON Hearing compensated volume adjustment on

OFF Linear frequency response

Preamplifier

This setting allows you to define how the audio signals are processed.

On, with HDMI Select this option if **MediaVision** is to process the audio signals (page 11 to 13). Control via the HDMI connection (CEC) is possible

On Select this option if **MediaVision** is to process the audio signals (page 11 to 13). Control via the HDMI connection (CEC) is **not** possible

Off Choose this option if the connected TV device processes the audio signals (page 14)

TV input

You can define the input for the TV sound used for the option **Preamplifier**:

On, with HDMI.

HDMI Out - ARC

Select this option if the sound signal is fed via the audio feedback channel of the HDMI connection. Your TV set must support this function (Loewe TV sets from chassis SL155 / SL2xx).

DIGITAL IN Select this option if the sound signal is fed in at the **DIGITAL IN** socket.

AUX IN Select this option if the sound signal is fed in at the **AUX IN** socket.

Centre channel reproduction with Loewe TV sets

| Loewe TV | Chassis | Center |
|-------------------------|---------|----------------------|
| Reference ID 40 - 55 | SL2xx | ok |
| Individual 40 - 55 | SL2xx | ok |
| Reference 52 | L2715 | ok |
| Loewe LCD-TV | L271x | ok |
| Individual 32 - 55 | SL15x | ok |
| Connect ID 32 - 55 | SL155 | via Adapter 71387001 |
| Connect 32 - 30 3D | SL15x | ok |
| Connect 22 - 26 SL | MB180 | - |
| Art 32 - 46 LED/3D | SL15x | ok |
| Xelos 32 - 40 LED/Media | SL1xx | - |
| Xelos 32 - 46 | MB180 | - |

Dolby PL II Menu

You can set the sound format for a stereo audio signal in Dolby-Pro Logic II Mode for surround sound. Use this option if you have connected a speaker system to **MediaVision** (page 11 to 13).

 MEDIA

Call up the Main Menu.

◀ ▶ ▲ ▼ Select the **Setup** option. Press **OK** to confirm.

▲ ▼ Select the **Dolby PL II** option. Press **OK** to confirm.

Dimension This allows you to set the stereophonic/Surround effect.

Center Width This allows you to set the width of the centre channel, or accentuation of the centre speaker.

Panorama This allows you to expand the stereo width of the front speaker.

Start-up

Lock Menu

You can specify playback restrictions in the **Lock Menu**.

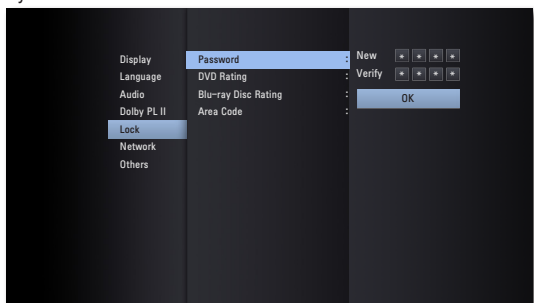

MEDIA

Call up the Main Menu.

- ◀ ▶ ▲ ▼ Select the **Setup** option.
- ▲ ▼ Select the option **Lock**.

Password set-up

Please set your personal password.



- ◀ ▶ ▲ ▼ Select the option **Password**.
- ▶ Select the option **New**.
- Use the numerical buttons to enter a four-digit password.
- Confirm the new password.
- Press **OK** to confirm.

⇒ If the entry is incorrect before you press **OK**, repeatedly press ◀ to delete the numbers.

Resetting the password

If you have forgotten the password or wish to deactivate the password function, you can reset it.

MEDIA

⇒ Remove every medium (disc, USB) and close all menus.

Call up the Main Menu.

- ◀ ▶ ▲ ▼ Select the **Setup** option.
- ▲ ▼ Select the option **Lock**.
- ▶ Select the option **Password**.

Use the numerical buttons to enter the code number (page 43).

The password protection is now deactivated. If necessary, set up a new password, as described under "Password set-up".

DVD Rating

This function restricts the playback of DVDs with adult-only content, if these contain a corresponding code. You will be prompted to enter the password to play the content in full.

◀ ▶ ▲ ▼ Select the option **DVD Rating**.

▶ Press button.



Use the numerical buttons to enter the current four-digit password.

Press **OK** to confirm.

▲ ▼ Select desired option.

Cancel The disc is not played completely

Level 1 to 8 Only the scenes of the inserted discs corresponding to the assigned security level or whose level value is below this are played. Level "1" has the most playback restrictions

⇒ Not all discs include a classification.

Blu-ray Disc Rating

This function restricts the playback of Blu-ray Discs™ with adult-only content, if these contain a corresponding code. You will be prompted to enter the password to play the content in full.

◀ ▶ ▲ ▼ Select the option **Blu-ray disc rating**.

▶ Press button.



Use the numerical buttons to enter the current four-digit password.

Press **OK** to confirm.

Use the numerical buttons to enter the three-digit code for the age rating (you can find this code on the Blu-ray Disc™ or on the accompanying material).

Press **OK** to confirm.

255 The disc is played fully

0 to 254 Only the scenes of the inserted discs corresponding to the assigned security level or whose level value is below this are played. Code "0" has the most playback restrictions

⇒ Not all discs include a classification

Area Code

To utilise the playback restrictions for the discs, enter the area code for the relevant country (for the list see page 44).

◀ ▶ ▲ ▼ select option **Area Code**.

▶ Press button.



Use the numerical buttons to enter the current four-digit password.

Press **OK** to confirm.

▲ ▼ Select the required code.

Press **OK** to confirm.

Start-up

Network Menu

Your **MediaVision 3D** can be connected via the **LAN** connection on the rear to a home network (LAN) with Internet connection (page 11 to 13). That means you can use the **BD-LIVE™** service, which provides you with optional accompanying material from the manufacturer of the Blu-ray Disc™.

In the **Network** Menu you can make the settings required for your home network.

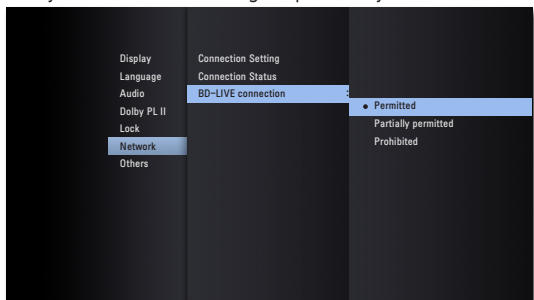

Set network connection automatically

If your home network has a DHCP server (e.g. a DSL router), your **MediaVision 3D** can automatically set all network parameters.

MEDIA

Call up the Main Menu.

- ◀ ▶ ▲ ▼ Select the **Setup** option.
- ▲ ▼ Select the **Network** option.
- ▶ ▲ ▼ Select the **Connection settings** s.

Press **OK** to confirm.

The **Connection Settings** Menu appears.

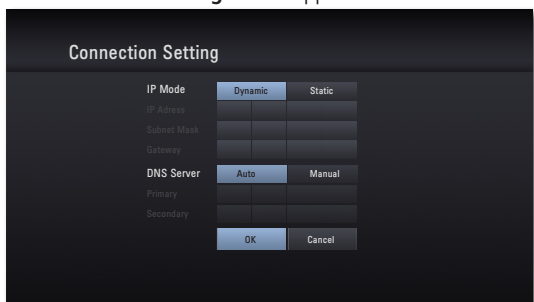

Press **OK** to confirm.

Your **MediaVision 3D** will now attempt to establish a connection to the Internet router in your home network. The standard setting shown above (IP Mode: Dynamic, DNS server: Auto) is used for the automatic search for the network parameters.

If a dynamic IP address has been assigned, a corresponding message will appear.

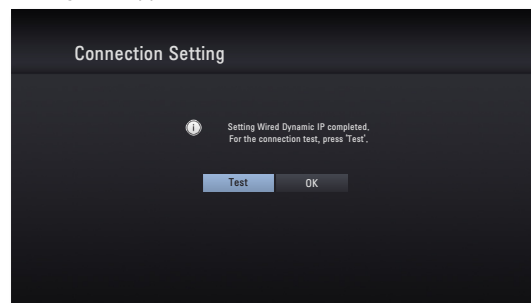

◀ ▶ Select the option **Test** to perform a connection test. Press **OK** to confirm.

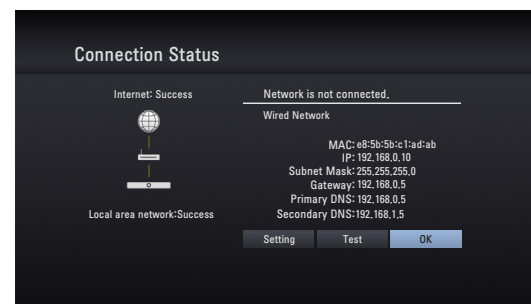

If the connection test was successful, a corresponding message will be displayed in the **Connection Status** Menu.

OK Close menu

Test Repeat connection test

Settings Call up the **Connection Settings** Menu

Connection Status Menu

You can display the network parameters currently set.

MEDIA

Call up the Main Menu.

- ◀ ▶ ▲ ▼ Select the **Setup** option.
- ▲ ▼ Select the **Network** option.
- ▶ ▲ ▼ Select the option **Connection status**.

Press **OK** to confirm.

The **Connection status** Menu appears.

Start-up

Set network connection manually

The network parameters can be set manually (e.g. if there is no DHCP server in your home network).

MEDIA

Call up the Main Menu.

◀ ▶ ▲ ▼ Select the **Setup** option.

▲ ▼ Select the **Network** option.

▶ ▲ ▼ Select the **Connection settings option**.

Press **OK** to confirm.

The **Connection Settings** Menu appears.

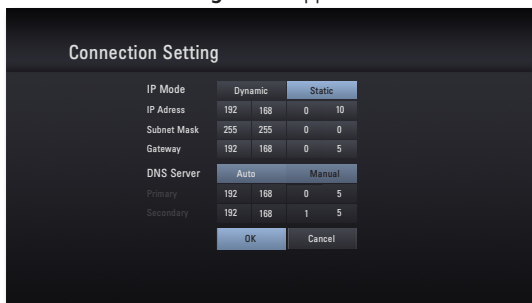

▲ ▼ ◀ ▶ Select the option **IP Mode: Static**.

Press **OK** to confirm.

▲ ▼ ◀ ▶ Enter the **IP address, Subnetwork Mask and gateway** using the numerical buttons on the **Assist** remote control.



▲ ▼ ◀ ▶ Select the option **DNS Server: Manual**.

Press **OK** to confirm.

▲ ▼ ◀ ▶ Enter the **Primary** and poss. **Secondary DNS server address** using the numerical buttons on the Assist remote control.

▲ ▼ ◀ ▶ Select the option **OK**.

Press **OK** to confirm.

Your **MediaVision 3D** will now attempt to establish a connection to the Internet router in your home network with the parameters set.

A message appears stating that a fixed IP address has been assigned.

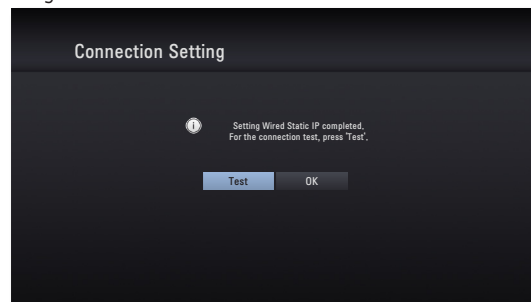

◀ ▶ Select the option **Test** to perform a connection test. Press **OK** to confirm.

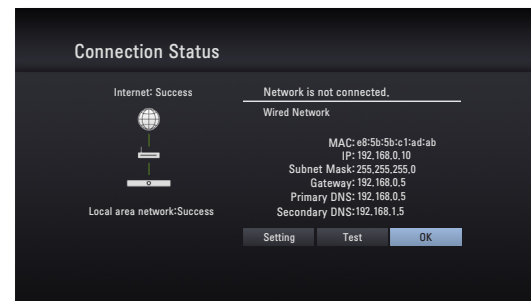

If the connection test was successful, a corresponding message will be displayed in the **Connection Status** Menu.

OK Close menu

Test Repeat connection test

Settings Call up the **Connection Settings** Menu

BD-LIVE™ connection

You can specify whether your **MediaVision 3D** may establish an Internet connection to the **BD-LIVE™ service** (page 33).

Call up the **Setup** Menu.

▲ ▼ Select the **Network** option.

▶ ▲ ▼ Select the option **BD-LIVE™ Link**.

Press **OK** to confirm.

Permitted **BD-LIVE™** is allowed for all contents

Partially permitted **BD-LIVE™** is only allowed for content for which a user certificate is available

Prohibited **BD-LIVE™** is locked



Start-up

Others Menu

Blu-ray Disc Storage Select

You can set whether you wish to use the integral memory in the device or a memory connected to the USB socket for the BD-LIVE function.

MEDIA

Call up the Main Menu.

◀ ▶ ▲ ▼ Select the **Setup** option.

▲ ▼ Select the option **Others**.

▶ ▲ ▼ Select the option **Blu-ray Disc Storage Select**.

Built-In Storage Memory integrated in the device

USB Storage Memory connected to the USB socket of the device

Press **OK** to confirm.

Blu-ray Disc Storage Clear

You can delete the memory used for the BD-LIVE function (page 33) so that more space is freed up for new files.

MEDIA

Call up the Main Menu.

◀ ▶ ▲ ▼ Select the **Setup** option.

▲ ▼ Select the option **Others**.

▶ ▲ ▼ Select the option **Blu-ray Disc Storage Clear**.

Press **OK** to confirm.

Built-In Storage Memory integrated in the device

USB Storage Memory connected to the USB socket of the device

◀ ▶ Confirm query prompt with **Yes**.

Press **OK** to confirm.

DivX® VOD

You will receive the DivX® VOD (Video On Demand) registration code for borrowing and buying Movies via the DivX® VOD service.

MEDIA

Call up the Main Menu.

◀ ▶ ▲ ▼ Select the **Setup** option.

▲ ▼ Select the option **Others**.

▶ ▲ ▼ Select the option **DivX® VOD**.

Register The registration code valid for your device is displayed. You can register for the VOD service in the Internet at:

<http://vod.divx.com>. You can also find further information on the use here.

Deregister The deactivation code valid for your device is displayed.

Press **OK** to confirm.

▶ All Movies purchased via DivX® VOD can only be played on this device.

Auto Power Off

To save energy, you can set the device so that it switches off automatically after a certain time without playback.

MEDIA

Call up the Main Menu.

◀ ▶ ▲ ▼ Select the **Setup** option.

▲ ▼ Select the option **Others**.

▶ ▲ ▼ Select the option **Auto Power Off**.

OFF The device also remains switched on after a longer period without use

ON After 30 minutes without function, the device will automatically switch off to Standby Mode

Press **OK** to confirm.

Initialize

You can reset the device to the default settings.

MEDIA

Call up the Main Menu.

◀ ▶ ▲ ▼ Select the **Setup** option.

▲ ▼ Select the option **Others**.

▶ ▲ ▼ Select the option **Initialize**.

Press **OK** to confirm.

◀ ▶ Confirm query prompt with **Yes**.

Confirm with **OK**.

Software updating

Display software status



Call up the Main Menu.

◀ ▶ ▲ ▼ Select the **Setup** option.



▲ ▼ Select the option **Others**.

▶ ▲ ▼ Select the option **Software**.

Press **OK** to confirm.

You can see the current software in the device on the right next to the entries **MAIN VER** and **SERVO VER**.

Press **OK** to confirm.

Downloading new software

You can download a software update suitable for your device from the Loewe Support Portal, if required.

- In the Internet browser of your computer, enter the address: <http://support.loewe.tv/de>
- If you still do not have an independent access to the Loewe Support Portal, set it up now. Click on [Register now](#). Fill out the information for your account and then click on [Create account](#). Please check whether all data is correct and then click on [Create account now](#). Shortly thereafter, you receive an email at the already specified address. Click on the link given above to confirm your registration. On successful registration, you receive an email for confirmation.
- Enter **your email address** and a **password** under **Access to your account**.
- Click on **Register Loewe product - System - MediaVision 3D** and entered the requested data for your device.

Download the file shown in the **Software** area.

Unzip the downloaded file (e.g. with 7-zip) and copy each of the unzipped files to a different USB stick. Carry out the update with the file „DSP_*.HEX“ last of all.

- ▣ The file system of the USB sticks must be formatted in the format FAT32 and only one partition may be present. Other file systems are not supported by the device for the software update.

Updating device software



Switch on your **MediaVision 3D** (and the TV set connected to it).



Remove an inserted disc.



Call up the Main Menu.

Insert the USB stick with the two update files in the USB socket of the **MediaVision 3D** and wait until the device has recognised the USB stick.

The software found on the USB stick is checked and a message appears. If the software is more recent than that on the device, you can then start the update.



◀ ▶ Select **Yes** to confirm the query prompt.

Press **OK** to confirm.

The update process starts and you can see a progress display.

- ▣ The USB stick or the mains cable must never be disconnected from the device during the updating process!

The device switches off after a successful update.

Then initialise the set as described on page 25.

- ▣ The firmware update is only intended for the Loewe **MediaVision 3D**, art. no. 51201!
- ▣ Only use the software approved by Loewe for your device!
- ▣ You can find the model designation on the rear of the device.
- ▣ If another device from Loewe or from a different manufacturer is loaded with software not intended for the device, this can lead to damage. Any guarantee and recourse claims for the device shall consequently lose their validity.
- ▣ The firmware update does not result in any significant changes to the technical functions of the device.
- ▣ You can download an up-to-date version of the instructions for use as a PDF file from the Loewe Website: <http://support.loewe.tv/de> – [Library Instructions for Use](#) This is especially recommended after a software update.

Playing discs

Prerequisites

Once you have carried out the relevant steps described in the chapters "Set-up", "Connection" and "Start-up", switch on **MediaVision 3D** and any connected devices. To reproduce 3D content, you require a 3D-compatible TV set with 3D glasses compatible with this, as well as Blu-ray 3D™ media.

Playable discs

Only use discs that conform with the current standards. You can recognise these from the logos attached.

| Disc type | | Recording format | Contents | Disc size |
|--------------------------|---------------------------|---------------------|-----------------------------|------------|
| Blu-ray™/ Blu-ray 3D™ | Regional code ** / ALL | Video Mode | Audio + Video (Movie) | 12 cm (5") |
| BD-RE/BD-R * | | - | | |
| DVD Video | Regional code ** / ALL | Video Mode | Audio + Video (Movie) | 12 cm (5") |
| DVD±RW/DVD±R * | | Video Mode | Audio + Video (Movie) | 12 cm (5") |
| Audio CD * | | Audio CD (CD-DA) | Audio | 12 cm (5") |
| CD-RW/CD-R * | | Audio CD (CD-DA) | Audio | |

* only finalised discs

** for the regional code applicable for your set, see the back of the set

Regional code (Country code)

The regional code of this player is printed on the rear of the unit. Only Blu-ray™ or DVD discs with this regional code or with the regional code "ALL" can be played. The regional code on the labels of some DVDs indicates what type of DVD-Player can play these discs. If you play other discs, an error message will be displayed on the TV screen. The label with the regional code is missing on some discs, although it cannot be played in all regions.

Symbols in these instructions for use

- BD* Blu-ray Disc™
- DVD-V* DVD video disc
- CD* Audio CD
- DivX* DivX files
- MP3* MP3 files
- WMA* WMA files
- JPEG* JPEG/PNG files



Handling discs

Do not touch the playing side of the disc. Hold the disc at the edges so as not to touch the surface with your fingers. Do not attach paper or adhesive tape onto either side of the disc.



- Discs may not play if the manufacturer of the disc has implemented new standards, technology or functions.
- Discs cannot be played if the disc is damaged or dirty or if the lens of the player is contaminated with condensation.
- If you write a disc with a PC, it may be the case that the disc cannot be played owing to the application software settings, even if your format is compatible. (You can obtain more information from your software provider).
- Depending on the recording device or the CD-R/RW- (or DVD±R/±RW-) disc itself, some CD-R/RW- (or DVD±R/±RW) discs cannot be played with this device.
- Do not use CDs with unusual shapes (e.g. heart shaped or octagonal). Otherwise malfunctions or damage cannot be ruled out.
- Finger prints and scratches on the disc can impair the playing quality. Handle the discs carefully.

Inserting discs

The disc drawer of your **MediaVision 3D** is located on the front (page 7). To open the disc drawer, press the sensor button  on the unit. Insert the disc in this drawer. The printed side of the disc should face upwards. Press the sensor button  again to close the disc drawer.



Ejecting the disc

Press the sensor button  again to remove the inserted disc.

Playing discs

Playback in general

Your **MediaVision 3D** attempts to read the disc. During this **READING** is shown in the display.

Depending on the medium, the playback starts automatically or a Disc menu is displayed. Follow the instructions on the screen or note the disc documentation.



▲ ▼ ◀ ▶ Select title.

OK Start play.



Play Start / Continue.



Pause Stop play.



Press briefly: Next chapter.



Press briefly: Start of the chapter.



Press briefly 2x: Previous chapter.



Stop 2x End play.



Display Title Menu *DVD-V BD*.



In the Title Menu you can - if this supports the disc currently being played - set a selection of options, e.g. title / chapter selection or subtitles (see also page 29).



▲ ▼ Select option.

◀ ▶ Set option.

Press **OK** to confirm.

➡ If the child protection level of the disc is set higher than that for the Movie classification, the password must be entered (see **Rating** on page 22).

Searching

BD DVD-V DivX CD

Select the search direction and speed:



Press longer: Rewind. Increase the playback speed backwards by pressing several times.



Press longer: Fast forwards. Increase the playback speed forwards by pressing several times.

The speed and direction are indicated as an arrow.



Quit Search Mode and continue play.

Freeze frame and picture-for-picture playback

BD DVD-V DivX



Pause Stop play.



Press Pause again: Browse forwards by frames.



Resume play

Slow motion

BD DVD-V DivX



Pause: Stop play.



Press longer: Activate Slow Motion Mode during pause.

Select the slow motion speed:



1/16, 1/8, 1/4, 1/2 (forwards).



Quit Slow Motion Mode and continue play.

Repeat

BD DVD-V CD MP3



Press several times to select the type of repeat.



Random play



Repeats the selected section (page 31)



Repeats the current chapter



Repeats the current title



Repeats the current track



Repeats all titles/tracks on the disc



No repeat

Playing discs

Disc playback

You can display various information on the inserted disc on the screen and set options for the playback.

INFO

Call up Title Menu during play.



▲ ▼ Select the desired function.

- Title** Current title (or track number)/total number of titles
- Chapter** Current chapter number/total number of chapters
- Time** Elapsed play time, go to time with **OK**
- Audio** Selected sound formats, Movie language and audio channels
- Subtitle** Selected subtitles
- Code Page** Code table for subtitles (page 35)
- Angle** Selected camera angle / Total number of camera angles
- TV Aspect Ratio** Selected picture format (e.g. aspect ratio 16:9)
- Picture Mode** Selected Picture Mode (e.g. optional colour setting - page 32)
- Movie Information** Title recognition by querying databases in the Internet

Title selection

BD DVD-V DivX

INFO

Call up Title Menu.



▲ ▼ Select **Title** .

◀ ▶ Select title number.

OK Start playing the selected title.

Title selection

CD DivX MP3 JPEG



P+ during play, in order to select the next title/the next photo or return with **P-** to the start of the current title.

Press **P-** briefly twice to return to the previous title.

Chapter / Track selection

BD DVD-V CD

If a title has several chapters/tracks, you can select another chapter/another track as follows:

P+ or **P-** during play, in order to select the next chapter/the next track or return with **P-** to the start of the current chapter/track.

Press **P-** briefly twice to return to the previous chapter/track.



Time (Play from ...)

BD DVD-V DivX

The **Time** function allows you to begin playing a disc from whichever point you like.

INFO

Call up Title Menu.

The elapsed play time for the current disc is shown in the **Time** field.



▲ ▼ Select **Time** .



Enter time in the format hh:mm:ss.

OK Start play from entered time point.

or

◀ ▶ Skip by minutes.

Digital sound formats, Movie language and audio channels

BD DVD-V DivX

Here you can select the digital sound format in conjunction with the Movie language.

INFO

Call up Title Menu.



▲ ▼ Select **Audio** .

◀ ▶ Select another Movie language or sound format (BD, DVD-V, DivX) - if available.

Playing discs

Subtitles

BD DVD-V DivX



Call up Title Menu.



▲ ▼ Select **Subtitle ABC** .

◀ ▶ Select subtitle language - if available.

Angle

BD DVD-V

If the disc contains scenes that have been recorded at different camera angles, you can change to another camera angle during play.



Call up Title Menu.



▲ ▼ Select **Angle**  .

◀ ▶ Select the desired camera angle - if available. The number of the current camera angle is shown.

⇒ A camera symbol is shown on the screen for scenes that have been recorded in different camera angles.

TV Aspect Ratio

BD DVD-V DivX



Call up Title Menu.



▲ ▼ Select **TV Aspect Ratio**  .

◀ ▶ Select picture format - if available.

Picture Mode

BD DVD-V DivX



Call up Title Menu.



▲ ▼ Select **Picture Mode**  .

◀ ▶ Select Picture Mode (page 32) - if available.

Movie information

BD DVD-V DivX



Call up Title Menu.



▲ ▼ Select **Movie Information**  . Confirm with **OK**.

If you are connected to the Internet, databases will now be queried in the Internet (e.g. Gracenote). If the query is successful, an album graphic along with possible supplementary information on the title will be shown.

Flagging

BD DVD-V DivX

You can start the playback from a saved flag. A maximum of nine flags can be saved.

⇒ The flags only remain saved while playing the current medium.



Blue button Press briefly during play: Set flag

Press longer: Open Flags display.



◀ ▶ Rewind / Fast forwards

▼, ◀ ▶ Select desired flag.

OK Start playback from selected flag

or

Start playback from desired flag.



Yellow button Delete selected flag.



Close Flags display.

Playing discs

Zoom

BD DVD-V JPG

You can use the zoom function to magnify the video image during play and navigate in the magnified image.



Open Zoom display.



Yellow button Zoom in



Green button Zoom out



Blue button Normal view

◀ ▶ ▲ ▼ Move picture detail.



Close Zoom window.

⇒ The Zoom function might not work for certain discs.

Title recognition

BD

EPG

If you are connected to the Internet, databases will now be queried in the Internet (e.g. Gracenote). If the query is successful, an album graphic along with possible supplementary information on the title will be shown.

Repeat section (A-B)

BD DVD-V



At the beginning of the section to be repeated, press the button several times until the symbol is displayed: A-



At the end of the section to be repeated press **OK**.

The selected section is repeated in an infinite loop



Press the button several times until the symbol is displayed: Off

Flagging the last scene

BD DVD-V

Your **MediaVision 3D** remembers the scene last played on the previous disc (Blu-ray Disc™, Video-DVD). The position of the last scene is saved in the memory, even when the device is switched off (or in Standby Mode). The next time you insert this disc, the saved scene will be played automatically.

- ⇒ The function "Flag last scene" is reset when inserting a new disc.
- ⇒ This function is not possible with certain discs.
- ⇒ The function "Flag last scene" is not possible for BD video discs with BD-J.
- ⇒ The settings for a disc are not saved if the device is switched off before playing the disc.

Playing discs

Disc Menu

BD DVD-V

Some discs contains menus for setting e.g. the language for the Movie sound or subtitles or selecting certain scenes. Accompanying Movie material can also be available. These menus have individual layouts, depending on the disc.

 Select Disc Menu *DVD*.

 Select pop-up menu *BD*.

Example:



Depending on the disc, there might not be any such menu. This button will not then have any function.



▲ ▼ ◀ ▶ Select menu item.

Press **OK** to confirm.

It may be possible to select menu functions with the coloured buttons.



Play Continue play *DVD*.



Quit Disc Menu *DVD*.



Quit pop-up menu *BD*.

Picture Mode

You can make various settings for the screen imaging during play.



Call up Title Menu during play.



▲ ▼ Select **Picture Mode** option.

◀ ▶ Select **User settings** option.

Press **OK** to confirm.

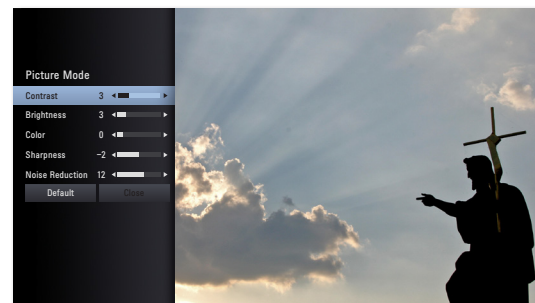

▲ ▼ ◀ ▶ Select/Set options.

Contrast Set contrast

Brightness Set screen brightness

Colour Set colour saturation

Sharpness Set contour definition of the picture

Noise Reduction Set noise suppression

Default restore default settings

Close Save settings and quit menu

Playing discs

BD-LIVE™

Your **MediaVision 3D** supports the **BD-LIVE™** function (Blu-ray™ Profile 2.0). This allows you to access interactive content provided via the Internet by some Blu-ray Discs™ providers.

Insert the Blu-ray Disc™ with the **BD-LIVE™** function.

- ➡ The **BD-LIVE™** function requires a broadband Internet connection. Set up the access to your home network as described from page 23.
- ➡ Activate the option whereby your **MediaVision 3D** can set up an online connection to the **BD-LIVE™** service (page 24).
- ➡ Ensure sufficient free memory space for the **BD-LIVE™ content** by deleting older saved data on the **BD-LIVE™** currently used (page 25). If the internal memory of your **MediaVision 3D** is insufficient, you can also connect an external USB storage medium with ≥ 1 GB free memory.

Select the die **BD-LIVE™** function in the Disc Menu of the Blu-ray Disc™.

The player establishes an Internet connection to the content provider and displays a selection menu. These menus have individual layouts, depending on the provider, and can contain diverse information and functions, e.g. trailers, games, up-to-date information etc.



▲ ▼ ◀ ▶ Select menu item.

Press **OK** to confirm.



It may be possible to select menu functions with the coloured buttons.

The selected media are loaded (this can take several minutes depending on the speed of the Internet connection) and a prompt to play or start the function appears.

- ➡ Do not remove a connected external USB stick while data is being transferred.



Stop 2x Quit **BD-LIVE™**.

Sound functions

The functions of button  differ depending on whether you are using **MediaVision** as an audio system (page 11 to 13) or as a player (page 14)

Audio system

MediaVision has a range of pre-set surround sound effects. The entries for the equaliser shown on the device display may vary depending on the sound sources and effects.



Open sound mode (press several times).



◀ ▶ Select option.

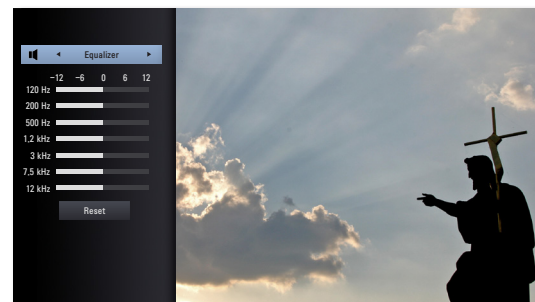

▲ ▼ ◀ ▶ Select/activate options

- Equaliser** The sound reproduction can be individually set up
- Personal** Set up bass and treble
- Bypass** Sound is not adapted
- Dialogue** The sound reproduction is optimised for dialogue
- Classic** The sound reproduction is optimised for classical music
- Pop** The sound reproduction is optimised for pop music
- Reset** Restore factory settings

As a player



Open listening mode (press several times)



◀ ▶ Select the number of loudspeakers that you'd like to hear.

Playing media files

You can use your **MediaVision 3D** to play digital media services that are saved on discs, USB storage media or on your home network.

Main Menu

MEDIA

Call up the Main Menu.

In the Main Menu you can select the desired operating mode **Movie**, **Music**, or **Photo** (page 17).

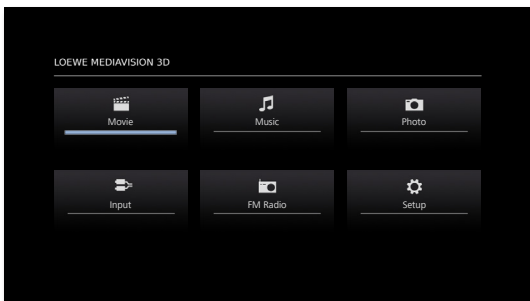

◀ ▶ ▲ ▼ Select desired operating mode.

Press **OK** to confirm.

A selection menu showing the various media sources appears.

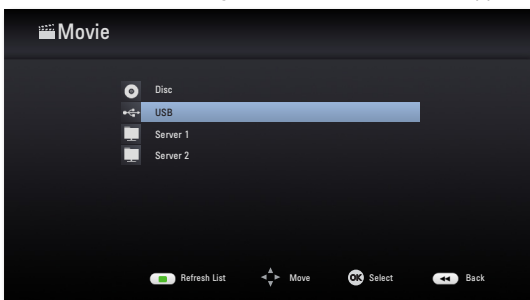

▲ ▼ Select required medium.

Press **OK** to confirm.

If several storage media are available when selecting **USB**, a further selection menu will appear.



◀ ▶ Select required storage medium.

Confirm with **OK**.

Video files

Playing video files

MEDIA



Call up the Main Menu.

◀ ▶ ▲ ▼ Select the **Movie** option in the Main Menu.

Press **OK** to confirm.

A selection menu showing the various media sources appears.

▲ ▼ Select required medium.

Press **OK** to confirm.

◀ ▶ Select file or folder.



P+ or **P-** browse forwards/backwards.

OK Start play or change to folder.



Play Start / Continue.

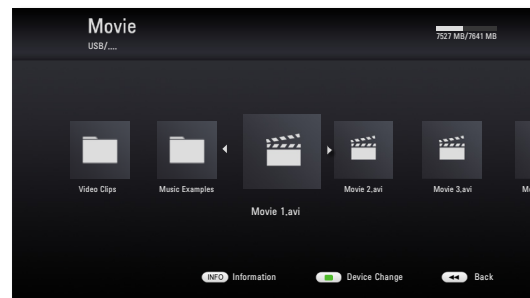

INFO

Display detailed information.



Call up the Main Menu.



In the menu: One level back.

➡ For controlling the play of media files see the chapter "Playback in general" (page 28).

Playing media files

DivX subtitles

Select the subtitles as described on page 29.



Green button Select code table for DivX subtitles by pressing several times.

Prerequisites for video files

- The maximum picture resolution of the DivX file is less than or equal to 1920 x 1080 (W x H) pixels.
- File name and path together shorter than 180 characters.
- Valid file endings for videos are: ".avi", ".divx", ".mpg", ".mpeg", ".mp4", ".mkv", ".asf", ".wmv", ".m4v" (without DRM).
- Playable subtitle formats: SubRip (*.srt/*.txt), SAMI (*.smi), SubStation Alpha (*.ssa/*.txt), MicroDVD (*.sub/*.txt), SubViewer 2.0 (*.sub/*.txt), TMPlayer (.txt), DVD subtitles (.txt).
- Playable video codecs: "DivX3.xx", "DivX4.xx", "DivX5.xx", "DivX6.xx" (only standard playback), "Xvid.xx", "H.264/MPEG-4 AVC", "MPEG2 TS", VC-1 SM (WMV3).
- Playable audio codecs: "Dolby Digital", "MP3", "DTS", "WMA", "AAC".
- Scanning frequency: MP3: 16 - 48 kHz, WMA: 32 - 48 kHz.
- Bit rates: MP3: 32 - 320 kbps, WMA: 20 - 320 kbps.
- If the video file and the subtitles have different file names, the subtitles might not be displayed when playing a DivX file.
- If the sound and image trace are not synchronous, either sound or a picture will be reproduced.
- HD Movie files contained on CDs or USB 1.x memory sticks might not be played without fault, as the bandwidth for the data transfer is too low. Use Blu-ray™, DVD or USB 2.0 storage media instead.
- This device supports the H.264/MPEG-4 AVC - Main, High Level 4.1 Profile. A warning note will be displayed for media belonging to a profile above this.
- This device does not support the MPEG4/DivX6.xx functions GMC*1 (Global Motion Compensation) or Qpel*2 (Quarter pixel).

USB Mode

- You can connect a USB storage medium directly to each of the USB sockets.
- The standard USB 1.1 and 2.0 is supported.
- The USB device must not be disconnected during a data transfer.
- The file systems FAT16, FAT32 and NTFS are supported.
- The maximum number of files and folders is ≤ 2000. The search can take longer than 1 minute.
- Devices requiring an additional software installation for connection to a computer are not supported.
- USB connection options other than those indicated above are not supported.

Playing media files

Music files

Playing music files

MEDIA



Call up the Main Menu.

◀ ▶ ▲ ▼ Select the **Music** option in the Main Menu.

Press **OK** to confirm.

A selection menu showing the various media sources appears.

▲ ▼ Select required medium.

Press **OK** to confirm.

◀ ▶ Select file or folder.



P+ or **P-** browse forwards/backwards.

OK Start play or change to folder.



Play Start / Continue.

➡ For controlling the play of media files see the chapter "Playback in general" (page 28).

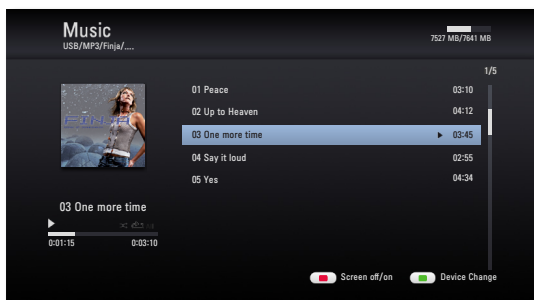

Select type of repeat (page 28).



Red button Screen OFF/ON (from chassis L271x, software \geq V9.2 - a software update might be necessary for the TV set).

EPG

Title recognition.

If you are connected to the Internet, databases will now be queried in the Internet (e.g. Gracenote). If the query is successful, an album graphic along with possible supplementary information on the title will be shown.

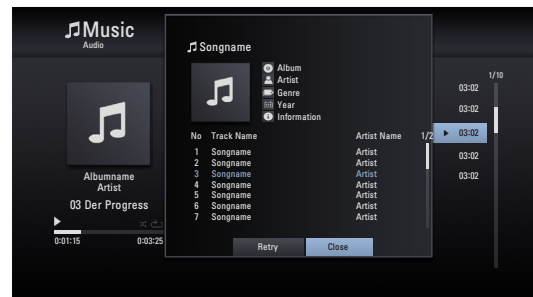

Prerequisites for music files

- Scanning frequency: MP3: 16 - 48 kHz, WMA: 32 - 48 kHz.
- Bit rates: MP3: 32 - 320 kbps, WMA: 20 - 320 kbps.
- The maximum number of files and folders is \leq 2000. The search can take longer than 1 minute.
- File extensions: ".mp3" / ".wma" / ".wav" / ".m4a" (without DRM).
- CD/DVD/Blu-ray Disc™ format: ISO9660 / JOLIET / UDF (Bridge).

Showing media files

Photo files

Showing photo files



Call up the Main Menu.



◀ ▶ ▲ ▼ Select the **Photo** option in the Main Menu.

Press **OK** to confirm.

A selection menu showing the various media sources appears.

▲ ▼ Select required medium.

Press **OK** to confirm.

◀ ▶ Select file or folder.

OK Show photo or change to folder.

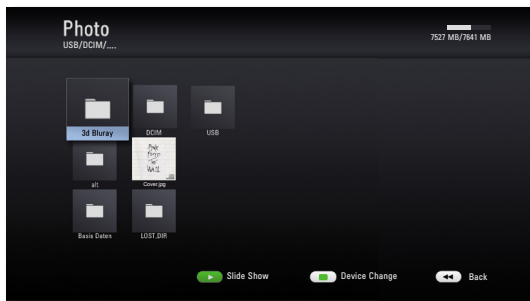

Slide show

You can automatically display your photo files as a slide show.



Play Start / Continue slide show.



Pause Stop slide show.



Stop Quit slide show/photo display/Zoom Mode.



INFO Show/Hide Info Menu.

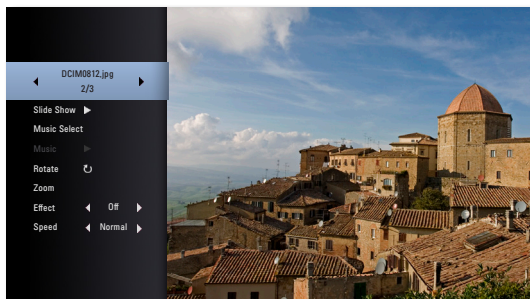

▲ ▼ ◀ ▶ Select/Set options.

Uppermost line Select photo with ◀ ▶

Slide show Pause/Play slide show with **OK**

Music select Select music for slide show

Music Pause/Play music with **OK**

Rotate Rotate image 90° to the right

Zoom Call up Zoom Mode with **OK** (page 31)

Effect Set transition effects

Speed Anzeigedauer einstellen

Music selection

You can play music to accompany the slide show.

▲ ▼ ◀ ▶ Select **Music Select** option in the Info Menu

Press **OK** to confirm.

◀ ▶ ▲ ▼ Select medium and **music album**.

➡ Folders containing music are marked with the symbol  gekennzeichnet.

▶ Select **OK** button.

Press **OK** to confirm.

if necessary, go to the Info Menu and start play in the **Music** option with **OK**.

Prerequisites for photo files

- Max. pixel width: 4000 x 3000 pixels /24bit/pixel
- Max. pixel width: 3000 x 3000 pixels /32bit/pixel
- Max. file size 4 Mbyte
- The maximum number of files and folders is ≤ 2000. The search can take longer than 1 minute.
- File extensions: ".jpg", ".jpeg", ".png"
- Photo files that are compressed progressively or without loss cannot be displayed.

Playback from iPod

You can connect your Apple iPod to **MediaVision** allowing you to enjoy your music with the highest quality of reproduction. Your **MediaVision** has an integrated iPod dock. If **MediaVision** is switched on, the battery of the connected iPods will be charged. You can find a list showing which Apple models are compatible with **MediaVision** on page 45.

Connecting the iPod

Insert the dock adapter supplied with your iPod in the loading recess of the iPod dock. Then place your iPod in the dock.

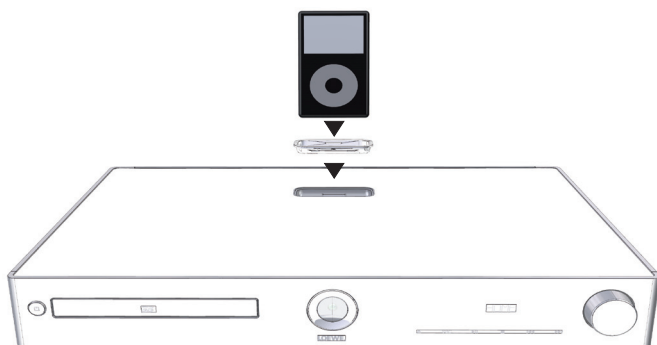

- Use the corresponding Apple Dock Adapter of your Apple iPod/iPhone to avoid damaging your iPod plug.
- When inserting and handling the iPod in the dock, only apply gentle force so as not to damage any sensitive plug-in connections.

iPod playback



Call up the Main Menu.



◀ ▶ ▲ ▼ Select the Music option in the **Main Menu**.

Press **OK** to confirm.

A selection menu showing the various media sources appears.

▲ ▼ Select **iPod**.

Press **OK** to confirm.

▲ ▼ Select desired option, e.g. **Albums**

Press **OK** to confirm.

▲ ▼ Select desired Album.



Play Start / Continue.



Pause Stop play.

For controlling the play of media files see the chapter "Playback in general" (page 28).



Press briefly: Select title up/down.



Press longer: Search up/down.



Press briefly twice to return to the previous title.



Stop End play.



Select type of repeat (page 28).

- Depending on the software version, your iPod might not be able to be operated via **MediaVision**. We recommend updating the software of your iPod to the latest version.
- The compatibility with your iPod can vary depending on the model. For Apple devices supported see page 45.
- Faults can occur depending on the iPod device.
- Do not disconnect your iPod from **MediaVision** until it is no longer being accessed.

FM Radio

Setting the radio stations

You can save up to 50 FM radio stations.

►► For a perfect radio reception, the unit must be connected to a suitable FM Radio antenna (page 7).

Automatic search

MEDIA

Call up the Main Menu.



◀ ▶ ▲ ▼ Select the **FM Radio** option in the Main Menu.

Press **OK** to confirm.



Press the **yellow button** for a longer period

The automatic search starts. All radio stations previously selected are deleted and overwritten by new ones (max. 50 stations).

Manual search

MEDIA

Call up the Main Menu.



◀ ▶ ▲ ▼ Select the **FM Radio** option in the Main Menu.

Press **OK** to confirm.



Press long: ◀ ▶ Start search backwards/forwards.

Press briefly: ◀ ▶ Set frequency incrementally.

Press **OK** to confirm.

The numerical display of the next free station memory flashes briefly on the unit display.

▲ ▼ If necessary, set desired station memory.

Press **OK** to confirm.

The current radio station is accepted in the selected station memory.

Listening to the radio

Select saved radio station

AUDIO

Press and hold for FM Radio Mode

or

MEDIA

Call up the Main Menu.



◀ ▶ ▲ ▼ Select the **FM Radio** option in the Main Menu.

Press **OK** to confirm.

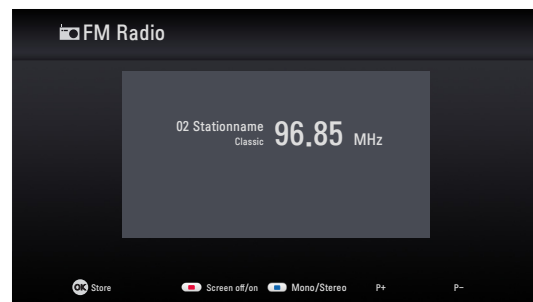

P+ / P- Radio station up/down.

Set radio station manually



◀ ▶ Press briefly repeatedly: Set frequency incrementally.

◀ ▶ Press longer: Search run.



Red button Screen OFF/ON (from chassis L271x, software ≥ V9.2 - a software update might be necessary for the TV set).



Blue button: Mono/Stereo

SRC sensor surface: select the source on the device (without switching off the TV set).

Importing Music

Importing Audio CDs

You can convert the titles (tracks) on your audio CDs to digital music files and then access them easily with **MediaVision**. The music files are saved on a connected USB memory stick.

Connect a USB memory stick with enough free memory space to **MediaVision** (page 7).

Insert the audio CD in the drive (page 27).

Start playing the disc (page 28).

INFO

Show menu.

▲ ▼ Select **CD Recording** option.

Press **OK** to confirm.

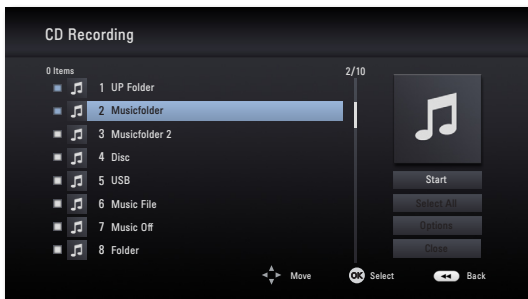

▲ ▼ Select desired tracks.

Highlight selected tracks with **OK**.

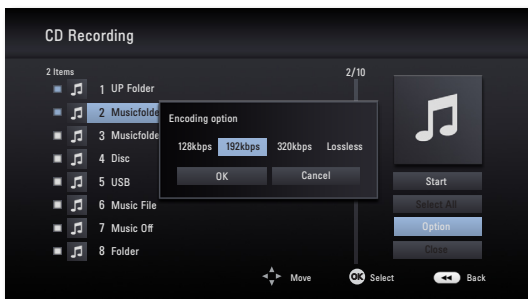

▶ Select the right menu.

▲ ▼ If necessary, select the bit rate in the **Options** Menu.

Start Selected tracks are converted

Select All All tracks of the CD are selected

Option You can set the bit rate and hence the sound quality

Close Cancel

▲ ▼ Select **Start**.

Press **OK** to confirm.

▲ ▼ Select a storage medium and a potential **destination folder** on this or create a new folder with **New Folder**. You can name the new folder using the keypad that is shown.

▶ Select the right menu.

Press **OK** to confirm.



The conversion of the selected tracks now starts. The process lasts several minutes. The progress is displayed during this time.

A message is displayed after the process is completed.

Press **OK** to confirm.

The finished music files are located in a new folder on the USB memory stick, which has the name of the CD album.

▮ Do not disconnect the USB memory stick from **MediaVision** until it is no longer being accessed.

▮ The music titles must be minimum 20 seconds long.

Further functions

Sleep Timer

You can use the Sleep Timer to set the unit so that it automatically switches off after a time set by you.



Press button.

The following appears on the display: **SLEEP 180**.

The time is reduced in specified increments until the automatic switch-off each time you press the **SLEEP** button again.



To reactivate the Sleep Timer, press the button until the normal display appears.

Source selection

You can also use **MediaVision** to play visual and audio sources from connected devices (page 7) and network media (DLNA).



Press the **PIP** button or sensor button **SRC** on the unit.

or



Call up the Main Menu.



◀ ▶ ▲ ▼ Select **Inputs** option in the Main Menu.

Press **OK** to confirm.

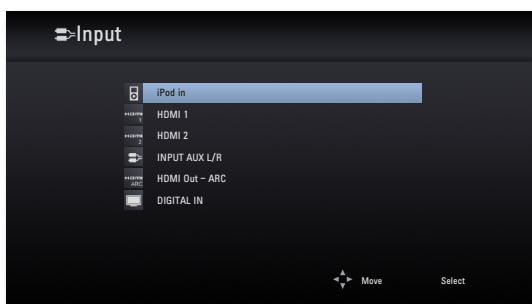

Environment

Cardboard box and packaging

In line with national regulations regarding the disposal of packaging materials, we pay a fee to authorised recyclers who collect packaging from dealers. Nevertheless, we recommend that you keep the original cardboard box and the rest of the packaging materials so that the unit can, if necessary, be transported in the safest possible conditions.

The unit



Attention: The EU Directive 2002/96/EC governs the proper return, handling and recycling of used electronic appliances. Old electronic appliances must therefore be disposed of separately. Never dispose of this unit in normal domestic waste! You can hand in your old unit free of charge at identified collection points or to your dealer if you buy a similar new unit.

Other details about return (also for non-EU countries) are available from your local authorities.

Remote control batteries



The batteries provided contain no harmful materials such as cadmium, lead or mercury.

Regulations concerning used batteries mean that batteries may no longer be disposed of in household waste. You can dispose of used batteries free of charge at the collection points in commercial outlets. Your dealer will also have a collection point for used batteries.

Troubleshooting

| Problem | Possible cause | Remedy |
|--|--|--|
| Not working at all. | Mains cable not plugged in. | Plug the mains cable into a socket 220-240 V 50/60 Hz. |
| No picture | The device is not connected correctly. | Make the connections as described on page 11 and page 14. |
| | The TV set is not set for the reception of video signals. | Select the correct AV programme slot on the TV set. |
| | The video cable is not connected correctly. | Check the two plugs of the cable for firm fitting in the sockets. |
| No sound. | Faulty connections of input or output cables. | Connect the cables properly (page 11 and page 14). If the problem persists, it is possible that the cables are faulty. |
| | The volume is set at minimum. | Turn up the volume. |
| | The sound is set to mute. | Press  or V+ on the remote control to reactivate the audio output and then set the volume level. |
| Playback not possible. | No disc inserted. | Insert a disc. |
| | A disc that cannot be played has been inserted. | Insert a playable disc. (Check the disc type, the colour system and the regional code). |
| | The disc is dirty. | Clean the disc. |
| | The disc is not inserted with the playback side facing downwards. | Insert the disc with the playback side facing downwards. |
| | The disc has not been placed in the guide. | Place the disc correctly inside the guide in the disc compartment. |
| A displayed media file cannot be played. | The file format is not supported. | Convert the file to a supported format on a computer with a converter program. |
| The BD-LIVE™ function is not working properly. | The internal memory is not sufficient. | Delete the internal memory (page 25) or connect an external USB stick (>1 GB). |
| | The Internet connection is not working properly. | Set up the Internet connection as described from page 23 and make sure that you have a broadband connection. |
| | BD-LIVE™ is deactivated. | Activate the BD-LIVE™ function (page 24). |
| The unit is not working properly. | | Unplug the mains plug from the mains socket and then try plugging it in again after 30 seconds. |
| | The software of your Loewe TV set is not compatible with MediaVision 3D. | Please contact your dealer. |
| The remote control is not working properly. | The batteries in the remote control are dead. | Replace the batteries with new ones. |

Glossary

24p Cinema Movie viewing: Today's Movie makers shoot their Movies with 24 images per second (24p); conventional televisions (and also most DVDs) show 50 images per second (50 Hz). In order to play the Movie, the original number of images is doubled and the Movie accelerated. That is optimum for sports broadcasts, but it distorts the picture quality for calmer movies. The new Loewe TV sets automatically reproduce 24p Movies in the original 24p format.

B

Blu-ray Disc™: (BD) Disc format for recording/playing high-resolution video material (HD) for HDTV devices and for saving large volumes of data.

BD-LIVE™: Extra service offered by some Blu-ray Disc™ providers. Current trailers, additional information as well as interactive media and applications (e.g. games) can be loaded via a broadband Internet connection with this.

BD-J: The BD-ROM format supports the programming language Java for interactive functions. "BD-J" gives content providers a greater variety of functions when creating interactive BD-ROM titles.

BD-ROM: BD-ROM discs allows up to 25 GB (single layer) or 50 GB (dual layer) of data to be saved in a single disc.

C

CEC: Abbreviation for Consumer Electronics Control. CEC makes overall component control functions available for consumer electronics devices (e.g. System Standby, One Touch Play). CEC is referred to Loewe as Digital Link HD.

COMPONENT OUT: Connection via which the video signal is transmitted using three separate cinch connections. It is made up of the brightness signal "Y" and the colour difference signals "Pb" and "Pr". YPbPr is the original analogue version of digital YCbCr, which colour codes the video data saved on the DVD or transmitted with DVB per Sat, cable or antenna.

D

Digital Link HD: System for controlling units via the HDMI connection of the Loewe TV set when they have been set up in a covered position.

Dolby Digital: Digital multi-channel sound.

Dolby Pro Logic: Analog multi-channel sound.

DHCP: Abbreviation for Dynamic Host Configuration Protocol. DHCP allows automatic assignment of IP addresses with the aid of a DHCP server.

DHCP server: Network service which takes care of automatic assignment of IP addresses to clients.

DRM: Digital Rights Management. Processes to control copyright protected data. To be used correctly, DRM protected contents require not only a DRM capable device but also the possession of a license issued by the provider (to be paid for).

DTS: Digital multi-channel sound.

DVD: Abbreviation for Digital Video Disc and later Digital Versatile Disc.

H

HDMI: High Definition Multimedia Interface, represents a newly developed interface for the fully digital transfer of audio and video files.

HDTV (HD): High Definition Television is a collective term, designating a series of high-resolution television standards.

I

Interlaced Mode: Technology for image formation in interlaced scanning for flicker-free reproduction of frames with double frame rate.

IP-Address: IP addresses (Internet Protocol Addresses) are used to identify devices in an Internet Protocol (IP) network. IP addresses are made up of four groups of numbers of three digits each.

J

JPEG/JPG: Joint Photographic Experts Group is a committee, which has developed a standardised method for the compression of digital images. This JPEG method (in short JPG), named after the committee, is an international graphics format for photos.

L

LAN: Abbreviation for Local Area Network. Mainly used as a name for networks with cabling (Ethernet).

M

MPEG: Digital compression method for video.

MP3: Data format for compressed audio files.

P

PCM: Pulse Code Modulation for digital sound.

Progressive Mode: Technology for image formation with real full frames for flicker-free reproduction.

R

RGB: Colour signals Red, Green and Blue.

U

USB: Universal Serial Bus. Serial bus system for connecting external devices (USB card reader, USB stick).

W

WMA: Abbreviation for Windows Media Audio, Microsoft own audio data format. As with MP3 files, the content is compressed here as well.

Y

YCbCr: digital colour model, see COMPONENT OUT.

YPbPr: analog colour model, see COMPONENT OUT.

 The code number **210499** cancels the pass-word and hence the lock. Please keep in a safe place.

Language code list

Enter the corresponding code for the initial setting of "Disc Audio", "Disc Subtitles" and/or "Disc Menu". (page 18).

| | | | |
|-----------------|------|-------------------|------|
| Afar | 6565 | Maori | 7773 |
| Afrikaans | 6570 | Marathi | 7782 |
| Albanian | 8381 | Macedonian | 7775 |
| Amharic | 6577 | Moldavian | 7779 |
| Arabic | 6582 | Mongolian | 7778 |
| Armenian | 7289 | Burmese | 7789 |
| Azerbaijani | 6590 | Nauru | 7865 |
| Assamese | 6583 | Nepalese | 7869 |
| Aymara | 6588 | Dutch | 7876 |
| Bashkir | 6665 | Norwegian | 7879 |
| Basque | 6985 | Oriya | 7982 |
| Bengali, Bangla | 6678 | Panjabi | 8065 |
| Bhutanese | 6890 | Pashtu | 8083 |
| Bihari | 6672 | Persian | 7065 |
| Breton | 6682 | Polish | 8076 |
| Bulgarian | 6671 | Portuguese | 8084 |
| Chinese | 9072 | Quechua | 8185 |
| Danish | 6865 | Rhaeto-Romance | 8277 |
| German | 6869 | Romanian | 8279 |
| English | 6978 | Russian | 8285 |
| Esperanto | 6979 | Samoan | 8377 |
| Estonian | 6984 | Sanskrit | 8365 |
| Faroese | 7079 | Scottish (Gaelic) | 7168 |
| Fiji | 7074 | Swedish | 8386 |
| Finnish | 7073 | Serbian | 8382 |
| French | 7082 | Serbo-Croatian | 8372 |
| Friesian | 7089 | Shona | 8378 |
| Galician | 7176 | Sindhi | 8368 |
| Georgian | 7565 | Sinhala | 8373 |
| Greek | 6976 | Slovakian | 8375 |
| Greenlandic | 7576 | Slovenian | 8376 |
| Guarani | 7178 | Spanish | 6983 |
| Gujarati | 7185 | Sudanese | 8385 |
| Hausa | 7265 | Swahili | 8387 |
| Hebrew | 7387 | Tajik | 8471 |
| Hindi | 7273 | Tagalog | 8476 |
| Indonesian | 7378 | Tamil | 8465 |
| Interlingua | 7365 | Telugu | 8469 |
| Irish | 7165 | Thai | 8472 |
| Icelandic | 7383 | Tongalese | 8479 |
| Italian | 7384 | Czech | 6783 |
| Javanese | 7487 | Turkish | 8482 |
| Yiddish | 7473 | Turkmen | 8475 |
| Canadian | 7578 | Twi | 8487 |
| Kazakh | 7575 | Ukrainian | 8575 |
| Kashmiri | 7583 | Hungarian | 7285 |
| Kirghiz | 7589 | Urdu | 8582 |
| Korean | 7579 | Uzbek | 8590 |
| Croatian | 7282 | Vietnamese | 8673 |
| Kurdish | 7585 | Volapük | 8679 |
| Lao | 7679 | Welsh | 6789 |
| Latin | 7665 | Belarusian | 6669 |
| Latvian | 7686 | Wolof | 8779 |
| Lingala | 7678 | Xhosa | 8872 |
| Lithuanian | 7684 | Yoruba | 8979 |
| Malagasy | 7771 | Zulu | 9085 |
| Malaysian | 7783 | | |
| Malajalam | 7776 | | |

Country code list

Enter the corresponding code for the initial setting of "Country Code" (page 22).

| | | | |
|----------------|----|--------------------|----|
| Afghanistan | AF | Republic of Congo | CG |
| Egypt | EG | Slovakia | SK |
| Antilles | AN | Romanian | RO |
| Argentina | AR | Russian Federation | RU |
| Ethiopia | ET | Saudi Arabia | SA |
| Australia | AU | Sweden | SE |
| Belgium | BE | Switzerland | CH |
| Bhutan | BT | Senegal | SN |
| Bolivia | BO | Zimbabwe | ZW |
| Brazil | BR | Singapore | SG |
| Chile | CL | Slovenia | SI |
| China | CN | Spain | ES |
| Costa Rica | CR | Sri Lanka | LK |
| Denmark | DK | South Africa | ZA |
| Germany | DE | South Korea | KR |
| Ecuador | EC | Taiwan | TW |
| El Salvador | SV | Thailand | TH |
| Fiji | FJ | Turkey | TR |
| Finland | FI | Uganda | UG |
| France | FR | Ukraine | UA |
| Greece | GR | Hungary | HU |
| Greenland | GL | Uruguay | UY |
| Great Britain | GB | USA | US |
| Hong Kong | HK | Uzbekistan | UZ |
| India | IN | Vietnam | VN |
| Indonesia | ID | Zimbabwe | ZW |
| Israel | IL | | |
| Italy | IT | | |
| Jamaica | JM | | |
| Japan | JP | | |
| Cambodia | KH | | |
| Canada | CA | | |
| Kenya | KE | | |
| Columbia | CO | | |
| Croatia | HR | | |
| Kuwait | KW | | |
| Libya | LY | | |
| Luxembourg | LU | | |
| Malaysia | MY | | |
| Maldives | MV | | |
| Morocco | MA | | |
| Mexico | MX | | |
| Monaco | MC | | |
| Mongolia | MN | | |
| Nepal | NP | | |
| New Zealand | NZ | | |
| Netherlands | NL | | |
| Nigeria | NG | | |
| Norway | NO | | |
| Oman | OM | | |
| Austria | AT | | |
| Pakistan | PK | | |
| Panama | PA | | |
| Paraguay | PY | | |
| Philippines | PH | | |
| Poland | PL | | |
| Portugal | PT | | |
| Czech Republic | CZ | | |

Technical data

General

| | |
|--------------------------------|-------------------|
| MediaVision 3D Art.No. | 51201 |
| Operating temperature [°C] | 5 ... 35 |
| Humidity [%] (no condensation) | 30 ... 85 |
| Dimensions [W x H x D in cm] | 43,9 x 6,8 x 31,3 |
| Weight [kg] | 3,4 |

Electrical data

| | |
|--|--|
| Mains voltage [Volt 50/60 Hz] | 200 - 240V |
| Power consumption [Watt] | 40 W |
| Power consumption in Standby [Watt] (Energy Saving Mode) | < 0.5 W |
| Laser | Laser class 1, wavelength: 405nm/650nm |
| Memory for BD-LIVE™ | 1 GByte |

Interfaces

| | |
|---------------------|--|
| AUX OUT L/R | Analog, Stereo, 2 V, 600 Ohm, RCA socket x 2 |
| AUX IN | Analog, Stereo, 2 V, 600 Ohm, RCA socket x 2 |
| DIGITAL IN | 0,5 V (p-p), 75 Ohm, 44,1 kHz, RCA-Buchse (Y) 1.0 V (p-p), 75 Ohm |
| COMPONENT VIDEO OUT | (Pb)/(Pr) 0.7 V (p-p), 75 Ohm, RCA socket x 3 |
| HDMI IN | 2x Type A, 19 pin, TMDS digital, V1.4 |
| HDMI OUT | Type A, 19 pin, TMDS digital, V1.4 |
| VIDEO OUT | (FBAS) 1.0 V (p-p), RCA socket |
| USB | 2x V 2.0, type A |
| LAN | Wired network RJ-45 |
| PHONE | Jack socket 3.5 mm |
| ANTENNA FM | FM antenna input, 75 Ohm |
| AUDIO-LINK | 26-pole D-SUB, Loewe System |

Playback

| | |
|------------------------|--|
| Playback formats | Blu-ray Disc™, Blu-ray 3D™ DVD-Video, DVD+/-R, DVD+/-RW (Video Mode) CD, CD-R, CD-RW |
| Video standards | TV standard PAL / NTSC Picture format 16:9, Letterbox 4:3, Panscan 4:3 |
| Audio standards | Dolby Digital, DTS, MPEG, PCM over HDMI: PCM, PCM multi-channel |
| Frequency range | 20 Hz to 20 kHz (48 kHz-, 96 kHz-, 192 kHz sampling) |
| Weighted noise voltage | > 100 dB (2CH AUDIO OUT) |
| Dynamic scope (1 kHz) | > 95 dB (DVD/Blu-ray Disc™) |
| Harmonic distortions | < 0.008 % (DVD/Blu-ray Disc™) |

File formats supported

| | |
|-------|---|
| Audio | MP3, WMA (without DRM), AAC (without DRM) |
| Photo | JPEG, PNG |
| Video | DivX, AVI, MPG, MKV, ASF, WMV, M4V |

Wired network

| | |
|---------------------|--|
| Standards supported | 10 Mbit/s Ethernet (10Base-T), 100 Mbit/s Fast Ethernet (100Base-T) |
|---------------------|--|

Radio

| | |
|-----------------|------------------|
| Type | PLL, RDS |
| FM band | 87,5 - 108,0 MHz |
| Stations memory | 50 |

Supported Apple devices - Made for

(only for audio playback)

| |
|--|
| iPod touch (4th generation), iPod touch (3rd generation) |
| iPod touch (2nd generation), iPod touch (1st generation) |
| iPod classic |
| iPod nano (5th generation) , iPod nano (4th generation) |
| iPod nano (3rd generation), iPod nano (2nd generation) |
| iPhone 4, iPhone 3GS, iPhone 3G |

Legal information

Loewe Opta GmbH is a public limited company of German law with its Head Office in Kronach.

Industriestrasse 11, 96317 Kronach

Telephone: +49 9261 99-500

Fax: +49 9261 99-515

Email: ccc@loewe.de

Commercial Register: Municipal Court Coburg, No. HRB 42243

VAT ID-No.: DE 193216550

WEEE registration number: DE 41359413

Editorial date 10.12. 4th issue

© Loewe Opta GmbH, Kronach

All rights reserved including translation.

Design and technical specifications are subject to change without notice.

Trademark rights

Blu-ray Disc™, Blu-ray™, Blu-ray 3D™, BD-Live™, BONUSVIEW™ as well as the logos and brands are trademarks of the Blu-ray Disc Association.

ABOUT DIVX VIDEO: DivX® is a digital video format created by DivX, Inc. This is an official DivX Certified® device that plays DivX video. Visit www.divx.com for more information and software tools to convert your files into DivX video.

ABOUT DIVX VIDEO-ON-DEMAND: This DivX Certified® device must be registered for playing purchased DivX Video-on-Demand (VOD) Movies. A registration code can be compiled in the section DivX VOD in the Settings Menu of the unit. You can find further information on the registration at vod.divx.com. DivX®, DivX Certified® and the associated logos are trademarks of DivX, Inc. and are licensed.

HDMI, the HDMI logo and High-Definition Multimedia Interface are trademarks or registered trademarks of HDMI licensing LLC.

Manufactured under licence from Dolby Laboratories. Dolby, ProLogic and the double-D symbol are trademarks of Dolby Laboratories .

Manufactured under license under U.S. patents: 5,451,942; 5,956,674; 5,974,380; 5,978,762; 6,226,616; 6,487,535; 7,212,872; 7,333,929; 7,392,195; 7,272,567 and further US and international patents issued and filed. DTS and the symbol are registered trademarks, & DTS-HD, DTS-HD Master Audio and the DTS logos are trademarks of DTS, Inc. This product contains software.

© DTS, Inc. Alle Rechte vorbehalten.

"AVCHD" and the "AVCHD" logo are trademarks of Panasonic Corporation and Sony Corporation.

Java and all Java-based trademarks and logos are trademarks or registered trademarks of Sun Microsystems, Inc. in the United States and in other countries.



"Made for iPod" and "Made for iPhone" mean that an electronic accessory has been designed to connect specifically to iPod or iPhone, respectively, and has been certified by the developer to meet Apple performance standards.

Apple is not responsible for the operation of this device or its compliance with safety and regulatory standards. Please note that the use of this accessory with iPod or iPhone may affect wireless performance.

iPod and iPhone is a registered trademark of Apple Inc. in the USA and other countries.

Gracenote® End User License Agreement

This application or device contains software of Gracenote, Inc., with head office in Emeryville, California, USA (hereinafter referred to as "Gracenote").

The software provided by Gracenote ("Gracenote software") enables this application to identify music albums and/or files online and access music-related data from online servers or integral databases (summarised under the designation "Gracenote servers"), including information on the name, artist, track and title ("Gracenote data"), as well as execute further functions. You may only use the Gracenote data as intended for the end user functions of the application or device.

You hereby assure that you shall only utilise Gracenote data, the Gracenote software and the Gracenote servers for your personal and non-commercial use. You assure that you shall not make the Gracenote software or any Gracenote data available to third parties, copy such for third parties or transfer or send such to third parties. YOU HEREBY ASSURE THAT YOU SHALL ONLY UTILISE GRACENOTE DATA, THE GRACENOTE SOFTWARE AND GRACENOTE SERVERS AS EXPRESSLY PERMITTED IN THIS DOCUMENT.

You hereby accept that your non-exclusive licence for the use of Gracenote data, the Gracenote software and the Gracenote server shall expire if you violate the above restrictions. You assure that you shall cease to use the Gracenote data, the Gracenote software and Gracenote servers in any way whatsoever after expiry of your licence. Gracenote reserves all rights to Gracenote data, the Gracenote software and the Gracenote servers, in particular all rights of ownership. On no account is Gracenote obliged to make payments to you for information which you make available to Gracenote. You accept that Gracenote, Inc., may enforce its rights resulting from this agreement directly and on its own behalf against you. Der Gracenote-Dienst nutzt einen speziellen Identifikationsmechanismus, um Abfragen zu statistischen Zwecken zu erfassen. Diese zufällig zugewiesene numerische Identifikation dient dazu, dem Gracenote-Dienst das Zählen von Abfragen zu ermöglichen, ohne dass dabei Daten über Sie bekannt werden. Weitere Informationen finden Sie auf der Webseite mit Gracenotes Datenschutzrichtlinie („Privacy Policy“) für den Gracenote-Dienst.

You shall receive a licence for the Gracenote software and all Gracenote data as issued. Gracenote does not make any explicit or implicit statements or promises in respect to the correctness of the Gracenote data on the Gracenote servers. Gracenote reserves the right to delete data from the Gracenote servers or change data categories for reasons that are reasonable in the opinion of Gracenote. Gracenote does not provide any assurance that the Gracenote software or the Gracenote servers are fault-free or that the Gracenote software and the Gracenote-Server will function without interruption. Gracenote is not obliged to provide you with new, improved or additional data types or categories which Gracenote might offer in the future, and Gracenote is entitled to stop its services at any time.

GRACENOTE EXCLUDES ALL EXPRESS OR IMPLICIT GUARANTEES, IN PARTICULAR IMPLICIT GUARANTEES CONCERNING STANDARD QUALITY, SUITABILITY FOR A DEFINITE PURPOSE, OWNERSHIP AND THE NON-VIOLATION OF RIGHTS. GRACENOTE DOES NOT PROVIDE ANY GUARANTEE FOR THE RESULTS YOU ATTAIN THROUGH USING THE GRACENOTE SOFTWARE OR FROM GRACENOTE SERVERS. GRACENOTE IS ON NO ACCOUNT LIABLE FOR CONSEQUENTIAL OR ACCIDENTAL DAMAGE, FOR LOST PROFIT OR LOST REVENUE.

© Gracenote, Inc. 2009



Trademark rights

This product contains software which has been developed by third parties and/or software covered by the GNU General Public License (GPL) and/or the GNU Lesser General Public License (LGPL) and/or other open source licenses.

The publication of this program by Loewe is carried out WITHOUT ANY GUARANTEE OR SUPPORT, particularly without an implicit guarantee concerning MARKET MATURITY or the USABILITY FOR A SPECIFIC PURPOSE. Details can be found in the GNU General Public License. You can obtain the software via the Loewe customer service department. You can download the GNU General Public License here: <http://www.gnu.org/licenses/>.

Cinavia Notice

This product uses Cinavia technology to limit the use of unauthorized copies of some commercially-produced film and videos and their soundtracks.

When a prohibited use of an unauthorized copy is detected, a message will be displayed and playback or copying will be interrupted.

More information about Cinavia technology is provided at the Cinavia Online Consumer Information Center at <http://www.cinavia.com>.

To request additional information about Cinavia by mail, send a postcard with your mailing address to: Cinavia Consumer Information Center, P.O. Box 86851, San Diego, CA, 92138, USA.

This product incorporates proprietary technology under license from Verance Corporation and is protected by U.S. Patent 7,369,677 and other U.S. and worldwide patents issued and pending as well as copyright and trade secret protection for certain aspects of such technology. Cinavia is a trademark of Verance Corporation. Copyright 2004-2010 Verance Corporation. All rights reserved by Verance.

Reverse engineering or disassembly is prohibited.

Declaration of conformity



This equipment is in compliance with the essential requirements and other relevant provisions of **Directive 1999/5/EC**. It may be operated in all countries in the **EU** and also in **Iceland, Norway and Switzerland**. In **France and Italy** it may only be used **indoors**.

The set is CE marked and complies to EU directives. The complete declaration of conformity is included in the detailed operating manual, which you can download from our homepage.



Service

(A) Loewe Austria GmbH
Parkring 12
1010 Wien, Österreich
Tel +43 - 810 0810 24
Fax +43 - 1 22 88 633 - 90
E-mail: loewe@loewe.co.at

(AUS)
Audio Products Group Pty Ltd
67 O'Riordan St
Alexandria NSW 2015, Australia
Tel +61 - 1300 130 492
Fax +61 - 02 9578 0140
E-mail: help@audioproducts.com.au

(B NL L)
Loewe Opta Benelux NV/SA
Uilenbaan 84
2160 Wommelgem, België
Tel +32 - 3 - 2 70 99 30
Fax +32 - 3 - 2 71 01 08
E-mail: ccc@loewe.be

(BG) Darlington Service
193 Kn. Klementina St.
1612 Sofia, Bulgaria
Tel +359 - 2 9556399
E-mail: darlington@psp-bg.com

(CH) Telion AG
Rütistrasse 26
8952 Schlieren, Schweiz
Tel +41 - 44 732 15 11
Fax +41 - 44 732 15 02
E-mail: infoKD@telion.ch

(CY) Hadjikyriakos & Sons Ltd.
121 Prodromos Str., P.O Box 21587
1511 Nicosia, Cyprus
Tel +357 - 22 87 21 11
Fax +357 - 22 66 33 91
E-mail: savvas@hadjikyriakos.com.cy

(CZ) BaSys CS s.r.o.
Sodomkova 1478/8
10200 Praha 10 - Hostivar,
Česká republika
Tel +420 234 706 700
Fax +420 234 706 701
E-mail: office@basys.cz

(D) Loewe Opta GmbH,
Customer Care Center
Industriestraße 11
96317 Kronach, Deutschland
Tel +49 9261 99-500
Fax +49 9261 99-515
E-mail: ccc@loewe.de

(DK) Kjaerulff1 Development A/S
C.F. Tietgens Boulevard 19
5220 Odense SØ, Denmark
Tel +45 - 66 13 54 80
Fax +45 - 66 13 54 10
E-mail: info@loewe.dk

(E) Gaplasa S.A.
Conde de Torroja, 25
28022 Madrid, España
Tel +34 - 917 48 29 60
Fax +34 - 913 29 16 75
E-mail: loewe@maygap.com

(F) Loewe France SAS
Rue du Dépôt,
13 Parc de l'Europe, BP 10010
67014 Strasbourg Cédex, France
Tel +33 - 3 - 88 79 72 50
Fax +33 - 3 - 88 79 72 59
E-mail: loewe.france@loewe-fr.com

(FIN) Karevox Oy
Museokatu 36
00100 Helsinki, Finland
Tel +358 - 9 44 56 33
E-mail: kare@haloradio.fi

(GB IRL) Loewe UK Limited
1st Floor, 237A Kensington High St
London
W8 6SA, UK
Tel +44 - (0) 207 368 1100
Fax +44 - (0) 207 368 1101
E-mail: enquiries@loewe-uk.com

(GR RO) Issagogiki Emboriki
Ellados S.A.
321 Mesogion Av.
152 31 Chalandri-Athens, Hellas
Tel +30 - 210 672 12 00
Fax +30 - 210 674 02 04
E-mail: christina_argyropoulou@
isembel.gr

(H) Basys Magyarorszagi KFT
Tó park u.9.
2045 Törökbálint, Magyar
Tel +36 - 2341 56 37 (121)
Fax +36 - 23 41 51 82
E-mail: ertekezesites@basys.hu

(HK CN) Galerien Und PartnerPlus
King's Tower 28/F, 111 King Lam Street
Kowloon, Hong Kong
Tel +852 - 27 77 89 88
Fax +852 - 23 10 08 08
E-mail: service@loewe-cn.com

(HR) Plug&Play Ltd.
Bednjanska 8, 10000 Zagreb
Hrvatska (Kroatia)
Tel +385 1 4929 683
Fax +385 1 4929 682
E-mail: info@loewe.hr
(I) Loewe Italiana S.r.l.
Via Monte Baldo, 14/P - 14/N
37069 Dossobuono di Villafranca di
Verona
Tel +39 - 045 82 51 690
Fax +39 - 045 82 51 622
E-mail: info@loewe.it

(IL)
Clear electronic entertainment Ltd
13 Noah Mozes St.
Agish Ravad Building
Tel Aviv 67442, Israel
Tel +972 - 3 - 6091100
Fax +972 - 3 - 6092200
E-mail: info@loewe.co.il

(IND) Navshiv Retail Pvt. Ltd.
Block D, Plot No. 7 Shanti Kunj
Vasant Kunj
New Delhi - 110070, India
Tel +91 11 47 65 55 00
Fax +91 11 47 67 67 15
E-Mail: admin@navshiv.com

(IR) MiMoRa HOLDING CO.
N0 1001, Afra Tower
Parsa St. Fereshteh
Tehran, Iran
Tel + 98 921 344 0521
E-Mail: s.zarandooz@gmail.com

(KSA) Salem Agencies & Services Co.
Hamad Al Haqueel Street, Rawdah,
Jeddah 21413
Kingdom of Saudi Arabia
Tel +966 (2) 665 4616
Fax +966 (2) 660 7864
E-mail: hkurkjian@aol.com

(LV EST) Kpartners, SIA
A.Čaka iela 80
Rīga, LV-1011, Latvia
Tel +3 71 - 67 29 29 59
Fax +3 71 - 67 31 05 68
E-mail: olga@dom332.lv

(LT) A Cappella Ltd.
Ausros Vartu 5, Pasazo skg.
01129 Vilnius, Lithuania
Tel +370 - 52 12 22 96
Fax +370 - 52 62 66 81
E-mail: info@loewe.lt

(M) Doneo Co. Ltd
34/36 Danny Cremona Street
Hamrun, HMR1514, Malta
Tel +356 - 21 - 22 53 81
Fax +356 - 21 - 23 07 35
E-mail: service@doneo.com.mt

(MA) Somara S.A.
377, Rue Mustapha El Maani
20000 Casablanca, Morocco
Tel +212 - 22 22 03 08
Fax +212 - 22 26 00 06
E-mail: somara@somara.ma

(N) Premium Consumer Electronics as
Østre Kullerød 5
3241 Sandefjord, Norge
Tel +47 - 33 29 30 40
Fax +47 - 33 44 60 44
E-mail: loewe@loewe.no

(NZ) Audio Products Group Pty Ltd
67 O'Riordan St
Alexandria NSW 2015, Australia
Tel 0800 174 781
Fax +61 - 02 9578 0140
E-mail: help@audioproducts.com.au

(P) Mayro Magnetics Portugal, Lda.
Rua Professor Henrique de Barros
Edifício Sagres, 2º. C
2685-338 Prior Velho, Portugal
Tel +351 - 21 942 78 30
Fax +351 - 21 940 00 78
E-mail: geral.loewe@mayro.pt

(PL) Tele Radio Video
Ul. Boh. Getta Warszawskiego 18
81-609 Gdynia
Tel. 58 624-50-09
E-Mail: loewe@trv.com.pl

(RUS) Service Center Loewe
Aptekarsky per.4 podjezd 5A
105005 Moscow, Russia
Tel +7 - 499 940 42 32 (ext. 454)
Fax +7 - 495 730 78 01
E-mail: service@loewe-cis.ru

(S) Kjaerulff 1 AB
Ridbanegatan 4, Box 9076
200 39 Malmö, Sverige
Tel +46 - 4 06 79 74 00
Fax +46 - 4 06 79 74 01
E-mail: loewe@loewe.se

(SG) Atlas Sound & Vision Pte Ltd
10 Winstedt Road #01-18
Singapore 227977
Tel +65 - 6334 9320
Fax +65 - 6339 1615
E-mail: service@atlas-sv.com

(SK) BaSys SK, s.r.o.
Stará Vajnorská 37/C
83104 Bratislava, Slovakia
Tel + 421 2 49 10 66 18
Fax + 421 2 49 10 66 33
E-mail: loewe@basys.sk

(TR) SERVISPLUS GENEL MERKEZ
ÖRNEK MAH. ATES SOK. NO:1
34704 ATASEHIR, ISTANBUL, TÜRKIYE
Tel +90 - 216 315 39 00
Fax +90 - 216 315 49 50
E-mail: info@servisplus.com.tr

(UAE) Dubai Audio Center
P.O. Box 32836, Sheikh Zayed Road
Dubai, UAE
Tel +971 - 4 343 14 41
Fax +971 - 4 343 77 48
E-mail: service@dubaiaudio.com