

**M-AUDIO**

**BX5a**  
**User Guide**

ENGLISH

---



CAUTION: TO REDUCE THE RISK OF ELECTRIC SHOCK, DO NOT REMOVE COVER (OR BACK). NO USER-SERVICEABLE PARTS INSIDE. REFER SERVICING TO QUALIFIED SERVICE PERSONNEL.



AFIN DEVIETER UN CHOC ELECTRIQUE ET LES CONSEQUENCES GRAVES QUI POURRAIENT EN RESULTER, TENEZ PAS D'OUVRIR L'APPAREIL ET DE TOUCHER AUX COMPOSANTS INTERNES SANS LA PRESENCE D'UNE PERSONNE QUALIFIEE.



PARA REDUCIR EL RIESGO DE SACUDIDAS ELECTRICAS, NO DEBERA QUITARSE LA TAPA (NI PARTE POSTERIOR). CONSULTESE AL PERSONAL CAPACITADO PARA LAS REPARACIONES INTERNAS.

**WARNING:** TO PREVENT FIRE OR ELECTRIC SHOCK, DO NOT EXPOSE THIS APPLIANCE TO RAIN OR MOISTURE.  
**ADVERTENCIA:** PARA EVITAR EL RIESGO DE INCENDIO O SACUDIDA ELECTRICA, NO DEBERA EXPONERSE ESTE APARATO A LA LLUVIA O HUMEDAD.

**CAUTION:** TO PREVENT ELECTRIC SHOCK DO NOT USE THIS (POLARISED) PLUG WITH AN EXTENSION CORD, RECEPTACLE OR OTHER OUTLET UNLESS THE BLADES CAN BE FULLY INSERTED TO PREVENT BLADE EXPOSURE.  
**ATTENTION:** POUR PREVENIR LES CHOCES ELECTRIQUES NE PAS UTILISER CETTE FICHE POLARISEE AVEC UN PROLONGATEUR. UNE PRISE DE COURANT OU UNE AUTRE SORTIE DE COURANT, SAUF SILES LAMES PEUVENT ETRE INSEREES A FOND SANS EN LAISSER AUCUNE PARTIE FOND SANS EN LAISSER AUCUNE PARTIE A DECOUVERT.  
**PRECAUCION:** PARA EVITAR SACUDIDAS ELECTRICAS, NO DEBERA UTILIZARSE ESTA CLAVIJA POLARIZADA CON UN CORDON DE PROLONGACION, RECEPTACULO U OTRO TIPO DE SALIDA A MENOS QUE SE HAYAN INSERTASO COMPLETAMENTE LAS LENGÜETAS PARA EVITAR SU EXPOSICION.

**NOTE:** Some products are equipped with dual or multi-voltage transformers (which is indicated on the back panel). If you wish to change the voltage, please bring your unit to an authorised service technician for internal conversion.  
**ATTENTION:** Quelques pièces sont munies de transformateurs à double ou à multi-voltage (indiqué au panneau arrière). Si vous voulez changer le voltage, veuillez apporter votre appareil au fournisseur de pour le transformer.  
**ZUR BEACHTUNG:** Einige Geräte sind mit Umschaltern für unterschiedliche Netzspannungen ausgerüstet (Ein Vermerk auf der Rückseite weist darauf hin). Die Anpassung, wenn notwendig, muß von einem qualifizieren Techniker in einer Servicestation vorgenommen werden.  
**NOTA:** Ciertos componentes de están dotados de transformadores de doble tensión o de varias tensiones (lo que se indica en el panel posterior). Si se desea cambiar la tensión, sírvanse llevar el aparato a un técnico autorizado por para su conversión interna.

**NOTE TO CATV systems installer:** This reminder is provided to call the CATV system installer's attention to Article 820-22 of the NEC that provides guidelines for proper grounding and, in particular, specifies that the cable ground shall be connected to the grounding system of the building, as close to the point of cable entry as practical.  
**NOTA PARA EL INSTALADOR DE ANTENAS DE TELEVISION COLECTIVAS:** La presente advertencia se provee para llamar la atención del instalador al Artículo 820-22 de NEC (Código Eléctrico Nacional) donde se facilitan las directrices para la pertinente puesta a tierra y que especifica en particular que el conductor a tierra del cable debe conectarse al sistema de conexión a tierra del edificio, lo más proximo posible al punto de entrada del cable.

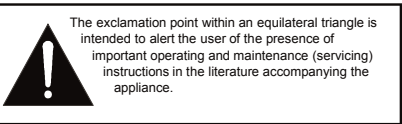
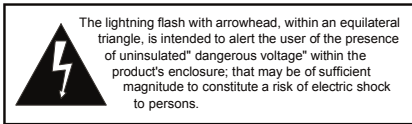

**Warning:** This speaker shall not be placed in the close area during the operation so that the mains switch can be easily accessed by the user.

# IMPORTANT SAFETY INSTRUCTION

## 1. READ INSTRUCTIONS

All the safety and operating instructions should be read before the appliance is operated.

## 2. RETAIN INSTRUCTIONS

The safety and operating instructions should be retained for future reference.

## 3. HEED WARNINGS

All warnings on the appliance and in the operating instructions should be adhered to.

## 4. FOLLOW INSTRUCTIONS

All operating and use instructions should be followed.

## 5. WATER AND MOISTURE

The appliance should not be used near water - for example, near a bathtub, washbowl, kitchen sink, laundry tub, in a wet basement, or near a swimming pool, etc.

## 6. CARTS AND STANDS

The appliance should be used only with a cart or stand that is recommended by the manufacturer.

- 6A. An appliance and cart combination should be moved with care. Quick stops, excessive force, and uneven surfaces may cause the appliance and cart combination to overturn.



## 7. WALL OR CEILING MOUNTING

This equipment is not designed for use mounted on a wall or a ceiling.

## 8. VENTILATION

The appliance should be situated so that its location or position does not interfere with its proper ventilation. For example, the appliance should not be situated on a bed, sofa, rug, or similar surface that may block the ventilation openings, or placed in a built-in installation, such as bookcase or cabinet that may impede the flow of air through the ventilation openings.

At least 30cm free space around the unit for normal ventilation is required.

## 9. HEAT

Do not install near any heat sources such as radiators, heat registers, stoves, or other apparatus (including amplifiers) that produce heat.

## 10. CLEANING

The appliance should be cleaned only with dry cloth.

## 11. POWER SOURCES

The appliance should be connected to a power supply only of the type described in the operating instructions or as marked on the appliance.

## 12. POWER CORD PROTECTION

Power-supply cords should be routed so that they are not likely to be walked on or pinched by items placed upon or against them, paying particular attention to cords at plugs, convenience receptacles, and the point where they exit from the appliance.

## 13. POLARIZED PLUG

Do not defeat the safety purpose of the polarized or grounding-type plug. A polarized plug has two blades with one wider than the other. A grounding type plug has two blades and a third grounding prong. The wide blade or the third prong are provided for your safety. When the provided plug does not fit into your outlet, consult an electrician for replacement of the obsolete outlet.

## 14. UNPLUG POWER CORD

Unplug this apparatus during lightning storms or when unused for long periods of time.

## 15. OBJECT AND LIQUID ENTRY

No object filled with liquids, such as vases, etc. shall be placed on the apparatus.

## 16. ACCESSORIES

Only use attachments/accessories specified by the manufacturer.

## 17. SERVICING

The user should not attempt to service the appliance beyond that described in the operating instructions. All other servicing should be referred to qualified service personnel.

## 18. DAMAGE REQUIRING SERVICE

The appliance should be serviced by qualified service personnel when:

- The power-supply cord or the plug has been damaged; or
- Objects have fallen, or liquid has been spilled into the appliance; or
- The appliance has been exposed to rain; or
- The appliance does not appear to operate normally or exhibits a marked change in performance; or
- The appliance has been dropped, or the enclosure is damaged.

## Introduction

Thank you for choosing the Studiophile Series BX5a bi-amplified studio near-field monitor speakers. M-Audio is well known for digital audio interface technology, digital converters, audio preamps and mixers. Now, after extensive research and development, M-Audio is proud to present the Studiophile BX5a.

The BX5a was designed and tested by veteran audio engineers to meet your needs in a studio monitoring environment. It is focused on the functional goal of delivering pure, original sound without any additional coloration. The BX5a monitor is self-powered, directly accepting a line-level signal from a variety of sources.

The Studiophile BX5a is designed to overcome all the limitations of conventional studio reference monitors within the digital audio environment. This system delivers a wide-range frequency response by employing two extraordinary drivers and unique crossover technology licensed by M-Audio. It boasts a stable and balanced low-mid frequency response along with a defined mid and high-frequency response as well. Both drivers are magnetically shielded for desktop music production.

For pro engineers at commercial studios to home studio owners, the Studiophile BX5a sets a new affordable standard in studio monitoring.

## What's in the Box?

Your Studiophile BX5a box contains:

- Two BX5a speakers
- Two detachable AC power cords
- This manual

## Studiophile BX5a Features

### 1. Woofer

The woofer unit is 5 inches in diameter with a magnetically shielded Kevlar cone, high-temperature voice coil and damped rubber surround. It is designed to deliver balanced mid and low-frequency response. M-Audio's new BX5a employs Kevlar for low-frequency driver construction. The same material used in bullet-proof vests, Kevlar's high resilience makes it ideal for use in speaker cones—although it is typically reserved for monitors with higher price tags than the BX5a. Needless to say, Kevlar represents a significant improvement over the polypropylene and paper used in most monitors at this price.

### 2. Tweeter

By employing a specially developed 1-inch silk dome with magnetic shielding, the tweeter can deliver distortion-free original sound and offer an extremely natural response. Its design minimizes reaction time by using a specially shaped silk dome for excellent delivery, and also minimizes resonance by adapting a unique internal damping technology.

### 3. Sub-Frequency Port

The air vent hole in the rear panel is called a Sub-Frequency Vent Port and is designed to allow the discharge of extremely low frequencies occurring below 60Hz.

## 4. Enclosure

Like the other components, the BX5a's enclosure has an important role in shaping the overall sonic response. In order to provide more stable performance, the BX5a's enclosure employs a special high acoustic efficiency MDF and unique interior reinforcement designed to absorb vibration and impact generated under extreme conditions. The custom design on the front panel will aid in diffraction and will benefit stereo imaging.

## 5. Network and Power Amplifiers

The active crossover network and power amplifiers for the BX5a are specially designed for its woofer and tweeter. The network properly distributes low, mid, and high frequencies to the driver components in order to reduce distortion and loss of sound, thus achieving a naturally balanced sound.

In order to generate powerful, ultra-crisp sound, there are two separate power amplifiers inside the BX5a for driving the woofer and tweeter separately in a high-end bi-amp structure. The power delivered to the woofer driver at a low-rated distortion is 40W, and 30W is also delivered to the tweeter.

# Front and Rear Panel Features

## Rear Panel Features

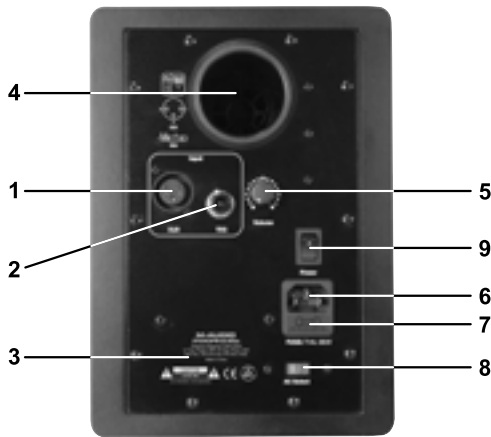

- XLR INPUT:** This jack accepts XLR input connections with either balanced or unbalanced wiring. The input wiring of an XLR connector should be as follows:
  - XLR PIN 1 . . . . . signal ground (shield)
  - XLR PIN 2 . . . . . signal positive (+)
  - XLR PIN 3 . . . . . signal negative (-)
- TRS INPUT:** This jack accepts 1/4" connections with either balanced or unbalanced wiring. For balanced wiring, a three-conductor TRS plug is necessary. The input wiring of a TRS connector should be as follows:
  - TRS TIP . . . . . signal positive (+)
  - TRS RING . . . . . signal negative (-)
  - TRS SLEEVE . . . . . signal ground (shield)

Unbalanced 1/4" wiring can be done with either a two- or three-conductor (TS or TRS) plug. A two-conductor (TS) plug automatically grounds the signal negative input, whereas a three-conductor (TRS) plug, wired unbalanced, provides the option of leaving the negative input open or grounded. We recommend that you ground the unused negative input (this can be done by wiring the ring and sleeve of the TRS plug together).

The TRS input is summed through a balanced input amplifier with the XLR input, allowing both inputs to be used simultaneously. Input specifications apply to both.

3. **PRODUCT SPECIFICATION:** This label contains the model and specification information.
4. **SUB-FREQUENCY VENT PORT:** This port aids in reproduction of very low frequencies by discharging frequencies below 60Hz.
5. **VOLUME CONTROL:** Use the volume control to set the output sound pressure from the BX5a to proper levels as required.
6. **POWER RECEPTACLE:** Accepts a detachable 3-circuit line cord in order to power the monitor.
7. **FUSE HOLDER:** Holds the external main fuse.
8. **VOLTAGE-SELECT SWITCH:** Provides two selections, 115V AC and 230V AC, and should be set to match the "house supply" (receptacle) voltage of the country or location in which the speaker is used. The 115V setting is correct for the USA, while the 230V setting is correct for most of the UK and Europe.
9. **POWER SWITCH:** This switch turns the monitor on and off.

## Front Panel Features

The front panel houses the Power LED, which indicates whether the speakers (amplifier) power is on or off.

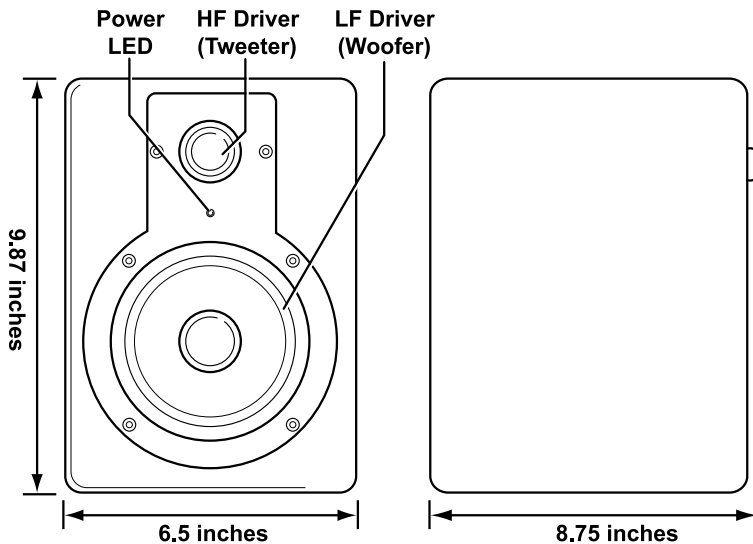

## Installation

For optimal performance of the BX5a, please read the following thoroughly and carefully prior to installation.

### Precautions

**Handling:** Please do not touch the speaker cones. The BX5a set is packaged in the box tightly, so your attention is required when taking the monitors out of the box. To avoid possible damage to the speaker units, hold both sides of the monitor in order to pull it out of the box. The speaker cones should not be touched in order to avoid damage even after they are out of the box.

**Correct Power Operation:** Since the BX5a contains its own amplifier, it must be connected to a power outlet using the detachable AC cable provided. Before connecting power, please make sure that the Voltage-Select Switch located on the speaker's rear panel is set to the appropriate position, as described in the rear-panel features list appearing earlier in this manual.

**WARNING! - Use of improper Voltage-Select Switch combinations may result in hazardous conditions and/or damage to speaker components not covered by speaker warranty.**

**Connections:** You can connect either an XLR balanced cable or TRS balanced/unbalanced cable from the input of each BX5a to your corresponding preamp, computer or game console outputs. We recommend that you use high-quality balanced or unbalanced cables for input connections. Also, ALWAYS turn off the power of the BX5a and turn the volume of the BX5a down to a minimum before making the necessary connections.

### XLR Balanced Connection

Assure that the power switch of the BX5a is turned off and that the volume control of the BX5a is turned down to a minimum. Connect the male end of an XLR balanced cable to the balanced input of the BX5a (refer to the following diagram for balanced connection).

### TRS Balanced/Unbalanced Connection

Assure that the power switch of the BX5a is turned to off and that the volume control of the BX5a is turned down to a minimum. Connect the male end of a TRS balanced or TS unbalanced cable to the TRS input of the BX5a (refer to the following diagram for TRS connection).

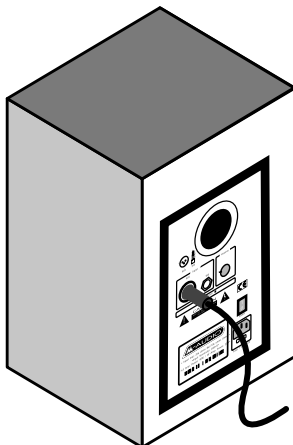

XLR Balanced Connection

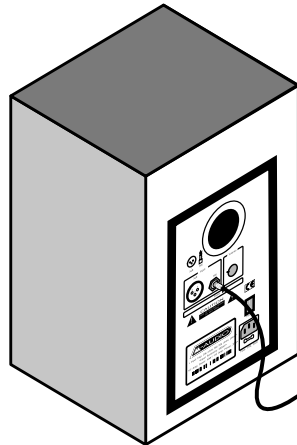

1/4" TRS Balanced or Unbalanced Connection

## Connecting to Preamp or Computer Outputs

Before connecting, make sure the output device's power has been turned off. Plug the XLR balanced, TRS balanced or TS unbalanced cable to the corresponding output connectors of a pre-amplifier, computer or game console.

## Placing the BX5a

Placing the speakers is one of the most important procedures in order to monitor sound accurately. To monitor with the BX5a's performing to their maximum capability, an appropriate listening environment and correct placement are required. Please refer to the following for correct BX5a placement.

1. The two units and the listener should basically align to form a regular triangle. Refer to the following diagram.
2. Position the monitors so that the top of the woofers are level with your ears in a normal listening environment. Refer to the following diagram.
3. Place the BX5a's vertically with the woofer on the bottom. Placing the BX5a's horizontally is not recommended.

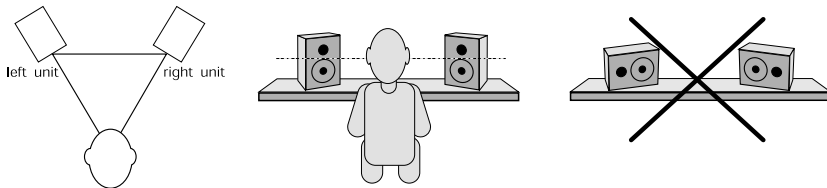

**Remarks: DO NOT place any obstacles that may block the flow of air in front or between the monitors. Also remove reflective materials such as glass, mirrors or metal from the monitoring environment. PLACE THOSE MATERIALS AWAY FROM THE PATH OF THE SOUND FROM THE BX5a's.**

## Contact Information

If you have any questions, comments or suggestions about this or any M-Audio product, we invite you to contact us by using the following information:

<p><b>M-AUDIO U.S. -</b> 5795 Martin Road, Irwindale, CA 91706-6211, U.S.A.</p> <p>Sales Information: ..... 626-633-9050            Sales (fax): ..... 626-633-9070            Sales Information (email): ..... info@m-audio.com            Tech Support (email): ..... techsupt@m-audio.com            Tech Support (fax): ..... 626-633-9060            Internet Home Page: ..... http://www.m-audio.com</p>	<p><b>M-AUDIO Deutschland (Germany) -</b> Kuhallmand 34, D-74613 Ohringen, Germany</p> <p>Sales Information: ..... +49 (0)7941 987000            Sales Information (email): ..... info@m-audio.de            Technical Support: ..... +49 (0)7941 9870030            Technical Support (email): ..... support@m-audio.de            Technical Support (fax): ..... +49 (0)7941 98 70070            Internet Home Page: ..... http://www.m-audio.de</p>
<p><b>M-AUDIO U.K. -</b> Floor 6, Gresham House, 53 Clarendon Road, Watford, WD17 1LA, United Kingdom</p> <p>Sales Information (phone): ..... 01923 204010            Sales Information (fax): ..... 01923 204039            Sales Information (email): ..... info@maudio.co.uk            Technical Support (PC): ..... 44 (0) 1309 671301            Technical Support (Mac): ..... 44 (0) 1765 650072            Technical Support (email): ..... support@maudio.co.uk            Internet Home Page: ..... http://www.maudio.co.uk</p>	<p><b>M-AUDIO Canada -</b> 1400 St-Jean Baptiste Ave. #150, Quebec City, Quebec G2E 5 B7, Canada</p> <p>Technical Support (e-mail): ..... techcanada@m-audio.com            Technical Support (PC): ..... (418) 872-0444            Technical Support (Mac): ..... 1-800-638-2120            Technical Support (fax): ..... (418) 872-0034            Sales (e-mail): ..... infocanada@m-audio.com            Sales (phone): ..... (866) 872-0444            Sales (fax): ..... (514) 396-7102            Internet Home Page: ..... http://www.m-audio.ca</p>
<p><b>M-AUDIO France -</b> Floor 6, Gresham House, 53 Clarendon Road, Watford, WD17 1LA, United Kingdom</p> <p><b>Assistance Technique (aucune questions reliées aux ventes)</b>            courriel (assistance PC): ..... support@m-audio-france.com            courriel (assistance Mac): ..... mac@m-audio-france.com            téléphone (assistance PC): ..... 0820 000 731            (0,12 Euros par minute)            téléphone (assistance Mac): ..... 0820 391 191            (0,12 Euros par minute)            télécopieur/fax: ..... 01 72 72 90 52</p> <p><b>Ventes (aucun appels d'assistance technique)</b>            téléphone: ..... 0810 001 105 (Numero Azur)            courriel: ..... info@m-audio-france.com            télécopieur/fax: ..... 01 72 72 90 52</p>	<p><b>M-AUDIO Japan -</b> (株式会社エムオーディオジャパン) 460-0002 愛知県名古屋市中区丸の内 2-18-10</p> <p>テクニカルサポート: ..... 052-218-0859            テクニカルサポート            (Macintosh): ..... mac-support@m-audio.co.jp            テクニカルサポート            (Windows): ..... win-support@m-audio.co.jp            Fax: ..... 052-218-0875            ホームページ: ..... http://www.m-audio.co.jp</p>



## Appendix A - Technical Specifications

<b>Type:</b>	<b>2-way near-field studio reference monitors</b>
<b>LF Driver:</b>	5-inch Kevlar curved cone with high temperature voice coil and damped rubber surround.
<b>HF Driver:</b>	1-inch magnetically shielded natural silk dome
<b>Frequency Response:</b>	56Hz - 22kHz
<b>Crossover Frequency:</b>	3kHz
<b>LF Amplifier Power:</b>	40W
<b>HF Amplifier Power:</b>	30W
<b>S/N Ratio:</b>	> 100dB typical A-weighted
<b>Input Connectors:</b>	1 x XLR balanced input connector 1 x TRS balanced/unbalanced input connector
<b>Polarity:</b>	positive signal at + input produce outward LF cone displacement
<b>Input Impedance:</b>	20k ohms balanced, 10k ohms unbalanced
<b>Input Sensitivity:</b>	85mV pink noise input produces 90dBA output SPL at one meter with volume control at maximum
<b>Protection:</b>	RF interference, output current limiting, over temperature, turn-on/off transient, subsonic filter, external mains fuse.
<b>Indicator:</b>	power on/off indicator on rear panel
<b>Power Requirements:</b>	factory programmed for either 115V ~50/60Hz, 230V~50/60Hz or 100V~50/60Hz
<b>Cabinet:</b>	vinyl-laminated high acoustic efficiency MDF
<b>Dimension:</b>	250 mm (H) x 176 mm (W) x 200 mm (D)
<b>Weight:</b>	5.0 kg/unit (without packing)

\* Above specifications subject to change without notice

## Your BX5a Warranty

### Warranty Terms

M-Audio warrants products to be free from defects in materials and workmanship, under normal use and provided that the product is owned by the original, registered user. Visit [www.m-audio.com/warranty](http://www.m-audio.com/warranty) for terms and limitations applying to your specific product.

### Warranty Registration

Thank you for registering your new M-Audio product. Doing so immediately both entitles you to full warranty coverage and helps M-Audio develop and manufacture the finest quality products available. Register online at [www.m-audio.com/register](http://www.m-audio.com/register) to receive FREE product updates and for the chance to win FREE M-Audio gear.

