

# PENTAX

ENG

Digital Camera

# Optio LS 465

## Operating Manual

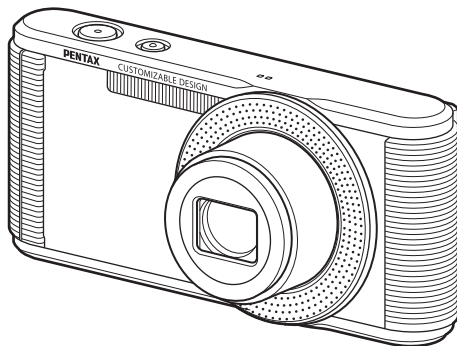

To ensure the best performance from your camera, please read the Operating Manual before using the camera.

Thank you for purchasing this PENTAX Digital Camera. Please read this manual before using the camera in order to get the most out of all the features and functions. Keep this manual safe, as it can be a valuable tool in helping you to understand all the camera's capabilities.

### **Regarding copyrights**

Images taken with the PENTAX Digital Camera that are for anything other than personal enjoyment cannot be used without permission according to the rights as specified in the Copyright Act. Please take care, as there are cases where limitations are placed on taking pictures even for personal enjoyment during demonstrations, performances or of items on display. Images taken with the purpose of obtaining copyrights also cannot be used outside the scope of use of the copyright as laid out in the Copyright Act, and care should be taken here also.

### **Regarding trademarks**

- SDXC Logo is a trademark of SD-3C, LLC.
- ArcSoft, and its logo are either the registered trademark or trademark of ArcSoft Inc. in the United States and/or other countries.
- Microsoft and Windows are registered trademarks of Microsoft Corporation in the United States and other countries. Windows Vista is either a registered trademark or trademark of Microsoft Corporation in the United States and/or other countries.
- Macintosh and Mac OS are trademarks of Apple Inc., registered in the U.S. and other countries.
- All other brands or product names are trademarks or registered trademarks of their respective companies. In this manual, the ™ and ® marks are not specified.
- This product supports PRINT Image Matching III. PRINT Image Matching enabled digital still cameras, printers and software help photographers to produce images more faithful to their intentions. Some functions are not available on printers that are not PRINT Image Matching III compliant. Copyright 2001 Seiko Epson Corporation. All Rights Reserved. PRINT Image Matching is a trademark of Seiko Epson Corporation. The PRINT Image Matching logo is a trademark of Seiko Epson Corporation.

### **Regarding Product Registration**

In order to better serve you, we request that you complete the product registration, which can be found on the CD-ROM supplied with the camera or the PENTAX website. Thank you for your cooperation. Refer to "Connecting to a Computer" (p.137) for more information.

## To users of this camera

- Do not use or store this device in the vicinity of equipment that generates strong electromagnetic radiation or magnetic fields.  
Strong static charges or the magnetic fields produced by equipment such as radio transmitters could interfere with the monitor, damage the stored data, or affect the product's internal circuitry and cause camera misoperation.
- The liquid crystal panel used for the display is manufactured using extremely high precision technology. Although the level of functioning pixels is 99.99% or better, you should be aware that 0.01% or fewer of the pixels may not illuminate or may illuminate when they should not. However, this has no effect on the recorded image.
- If you point the camera toward an object that is bright, a band of light may appear on the screen display. This phenomenon is referred to as "smear" and is not a malfunction of the camera.
- There is a possibility that the illustrations and the screen display in this manual are different from the actual ones.
- In this manual, SD Memory Cards, SDHC Memory Cards, and SDXC Memory Cards are referred to as SD Memory Cards hereafter.
- In this manual, the generic term "computer(s)" refers to either a Windows PC or a Macintosh hereafter.
- In this manual, the term "battery(ies)" refers to any type of batteries used for this camera and its accessories.

## Using Your Camera Safely

We have paid close attention to the safety of this product. When using this product, we request your special attention regarding items marked with the following symbols.



### Warning

This symbol indicates that violating this item could cause serious personal injuries.



### Caution

This symbol indicates that violating this item could cause minor or medium personal injuries, or loss of property.

## About the Camera

### **Warning**

- Do not disassemble or modify the camera. High voltage areas are present inside the camera, with the risk of electric shock.
- If the camera interior is exposed due to dropping or otherwise damaging the camera, never touch the exposed portion. There is a risk of electric shock.
- Wrapping the strap around your neck is dangerous. Take care that small children do not hang the strap around their necks.
- If any irregularities occur during use, such as smoke or a strange odor, stop use immediately, remove the battery, and contact your nearest PENTAX Service Center. Continuing to use the camera can cause a fire or electric shock.

### **Caution**

- Do not place your finger over the flash when discharging the flash. You may burn yourself.
- Do not cover the flash with clothes when discharging the flash. Discoloration may occur.
- Some portions of the camera heat up during use. There is a risk of low temperature burns when holding such portions for long periods.
- Should the monitor be damaged, be careful of glass fragments. Also, be careful not to allow the liquid crystal to get on your skin, in your eyes or mouth.
- Depending on your individual factors or physical condition, the use of the camera may cause itching, rashes or blisters. In case of any abnormality, stop using the camera and get medical attention immediately.

## About the Power Adapter

### **Warning**

- Always use the power adapter exclusively developed for this camera, with the specified power and voltage. Using a power adapter not exclusive to this camera, or using the exclusive power adapter with an unspecified power or voltage can cause a fire, electric shock, or camera breakdown. The specified voltage is 100 - 240V AC.

- Do not disassemble or modify the power adapter. This can cause a fire or electric shock.
- If the generation of smoke or strange odor from the power adapter or other abnormality occurs, immediately discontinue use and consult a PENTAX Service Center. Continuing to use the adapter can cause a fire or electric shock.
- If water should happen to get inside the power adapter, consult a PENTAX Service Center. Continuing to use the adapter can cause a fire or electric shock.
- If a thunder storm should occur while using the power adapter, unplug the adapter and discontinue use. Continuing to use the adapter can cause damage to the equipment, fire, or electric shock.
- Wipe off the plug of the power adapter if it becomes covered with dust. Accumulated dust on the plug may cause a fire.

### **Caution**

- Do not place or drop heavy objects on the power adapter. Doing so may damage the adapter. Should the power adapter be damaged, consult a PENTAX Service Center.
- Do not touch or short-circuit the terminal area of the power adapter while the cord is plugged in.
- Do not handle the power adapter with wet hands. This can cause an electric shock.
- Do not drop the power adapter, or subject it to violent impact. This can cause equipment breakdown.
- Do not use the power adapter to charge a battery other than a rechargeable lithium-ion battery D-LI108. This can cause an explosion, or heating, or may damage the power adapter.

## About the Battery

### **Warning**

- Be sure to store the battery out of the reach of small children. Placing it in their mouths may cause an electric shock.
- If any leakage from the battery should come in contact with your eyes, do not rub them. Flush your eyes with clean water and get medical attention immediately.

## **Caution**

- Only use the specified battery with this camera. Use of other batteries may cause an explosion or fire.
- Do not disassemble the battery. Disassembling the battery may cause an explosion or leakage.
- Remove the battery from the camera immediately if it becomes hot or begins to smoke. Be careful not to burn yourself during removal.
- Keep wires, hairpins, and other metal objects away from the + and - contacts of the battery.
- Do not short the battery or dispose of the battery in fire. This can cause an explosion or fire.
- If any leakage from the battery should come in contact with skin or clothes, wash the affected areas thoroughly with water.
- Precautions for D-LI108 Battery Usage:  
BATTERY MAY EXPLODE OR FIRE IF MISTREATED.
  - DO NOT DISASSEMBLE OR DISPOSE OF IN FIRE.
  - DO NOT CHARGE EXCEPT SPECIFIED CHARGING CONDITION.
  - DO NOT HEAT ABOVE 140°F / 60°C, OR SHORT CIRCUIT.
  - DO NOT CRUSH OR MODIFY.

## **Keep the Camera and its Accessories out of the Reach of Small Children**

## **Warning**

- Do not place the camera and its accessories within the reach of small children.
  1. If the product falls or is operated accidentally, it may cause serious personal injuries.
  2. Wrapping the strap around a neck may cause suffocation.
  3. To avoid the risk of a small accessory such as the battery or SD Memory Cards from being swallowed by mistake, keep them out of the reach of small children. Seek medical attention immediately if an accessory is accidentally swallowed.

## Care to be Taken During Handling

### Before Using Your Camera

- When traveling, take the Worldwide Service Network listing that is included in the package. This will be useful if you experience problems abroad.
- When the camera has not been used for a long time, make sure that it is still working properly, particularly prior to taking important pictures (such as at a wedding or when traveling). Contents of the recording cannot be guaranteed if recording, playback or transferring your data to a computer, etc. is not possible due to a malfunction of your camera or recording media (SD Memory Card), etc.

### About the Battery

- Storing the battery fully charged may decrease the battery performance. Avoid storing in high temperatures.
- If the battery is left inserted and the camera is not used for a long time, the battery will over-discharge and shorten the battery's life.
- Charging the battery a day before use or on the day of use is recommended.

### Precautions on Carrying and Using Your Camera

- Do not subject the camera to high temperatures or high humidity. Do not leave the camera in a vehicle, as the temperature can get very high.
- Do not subject the camera to strong vibrations, shocks, or pressure. Use a cushion to protect the camera from vibrations of motorcycles, automobiles, or ships.
- The temperature range for camera use is 0°C to 40°C (32°F to 104°F).
- The monitor may appear black at high temperatures, but will return to normal at normal temperatures.
- The monitor may respond more slowly at low temperatures. This is due to liquid crystal properties, and is not a malfunction.
- Sudden temperature changes will cause condensation on the inside and outside of the camera. Place the camera in your bag or a plastic bag, and remove it after the temperature of the camera and surroundings are equalized.

- Avoid contact with garbage, mud, sand, dust, water, toxic gases, or salt. These could cause the camera to breakdown. Wipe the camera to dry off any rain or water drops.
- Please do not press forcefully on the monitor. This could cause it to break or malfunction.
- Be careful not to sit down with the camera in your back pocket as this may damage the exterior of the camera or the display.
- Be careful not to overtighten the tripod screw when using a tripod.
- The lens on this camera is not interchangeable. The lens is not removable.

### **Cleaning Your Camera**

- Do not clean the camera with organic solvents such as thinner, alcohol or benzene.
- Use a lens brush to remove dust accumulated on the lens. Never use a spray blower for cleaning as it may damage the lens.

### **Storing Your Camera**

- Do not store the camera with preservatives or chemicals. Storage in high temperatures and high humidity can cause mold to grow on the camera. Remove the camera from its case and store it in a dry and well-ventilated location.
- Avoid using or storing the camera where it may be exposed to static electricity or electrical interference.
- Avoid using or storing the camera in direct sunlight or where it may be exposed to rapid changes in temperature or to condensation.

### **Other Precautions**

- Periodic inspections are recommended every one to two years to maintain high performance.
- Please note that deleting data, or formatting the SD Memory Cards or the built-in memory does not completely erase the original data. Deleted files can sometimes be recovered using commercially available software. It is user's responsibility to ensure the privacy of such data.

- The SD Memory Card is equipped with a write-protect switch. Setting the switch to LOCK prevents new data from being recorded on the card, the stored data from being deleted, and the card from being formatted by the camera or computer.

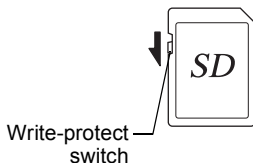

- The  appears on the display when the card is write-protected.
- Care should be taken when removing the SD Memory Card immediately after using the camera, as the card may be hot.
- Keep the battery/card cover closed and do not remove the SD Memory Card or turn the camera off while the data is being played back or saved to the card, or the camera is connected to a computer with the USB cable, as this may cause the data to be lost or the card to be damaged.
- Do not bend the SD Memory Card or subject it to violent impact. Keep it away from water and store away from high temperature.
- Do not remove the SD Memory Card during formatting as this may damage the card and render it unusable.
- The data on the SD Memory Card may be deleted in the following circumstances. We do not accept any liability for data that is deleted
  - (1) when the SD Memory Card is mishandled by the user.
  - (2) when the SD Memory Card is exposed to static electricity or electrical interference.
  - (3) when the SD Memory Card has not been used for a long time.
  - (4) when the SD Memory Card is ejected or the battery is removed while the data on the card is being recorded or accessed.
- If it is not used for a long time, the data on the card may become unreadable. Be sure to regularly make a backup of important data on a computer.
- When using an SD Memory Card with a slow recording speed, recording may stop while you are taking movies even when there is adequate space in the memory, or shooting and playback may take a long time.
- Be sure to format SD Memory Cards that are unused or have been used on another camera. Refer to "Formatting the Memory" (p.123).

# Contents

Using Your Camera Safely .....	1
Care to be Taken During Handling .....	5
Contents .....	8
Composition of the Operating Manual .....	13
<b>Camera Features</b> .....	<b>14</b>
Checking the Contents of the Package .....	17
Names of Parts .....	18
Names of Operating Parts .....	19
Monitor Indications .....	20
<b>Getting Started</b> .....	<b>26</b>
<b>Attaching the Strap</b> .....	<b>26</b>
<b>Dress-up the Camera</b> .....	<b>27</b>
<b>Powering the Camera</b> .....	<b>29</b>
Installing the Battery .....	29
Charging the Battery .....	31
<b>Installing an SD Memory Card</b> .....	<b>34</b>
<b>Turning the Camera On and Off</b> .....	<b>36</b>
<b>Initial Settings</b> .....	<b>37</b>
Setting the Display Language .....	37
Setting the Date and Time .....	40
<b>Common Operations</b> .....	<b>42</b>
<b>Understanding the Button Functions</b> .....	<b>42</b>
📷 Mode .....	42
▶ Mode .....	44
Switching Between 📷 Mode and ▶ Mode .....	46
<b>Setting the Camera Functions</b> .....	<b>47</b>
Operating the Menus .....	47
Menu List .....	50
<b>Taking Pictures</b> .....	<b>54</b>
<b>Taking Still Pictures</b> .....	<b>54</b>
Taking Pictures .....	54
Setting the Shooting Mode .....	57
Using the Face Detection Function .....	59
Taking Pictures Automatically (Auto Picture Mode) .....	60
Taking Pictures in the Custom Settings (Program Mode) .....	61

Taking Pictures in Basic Mode (Green Mode).....	61
Using the Zoom .....	63
Taking Pictures of Your Pet (Pet Mode).....	65
Framing Your Pictures (Frame Composite Mode).....	66
Taking Pictures of Text (Text Mode).....	67
Taking Pictures Using the Miniature/HDR Filter .....	68
<b>Setting the Shooting Functions.....</b>	<b>70</b>
Selecting the Flash Mode .....	70
Selecting the Drive Mode .....	71
Selecting the Focus Mode .....	73
Setting the [📷 Rec. Mode] Menu.....	74
To Set the Focusing Area.....	74
Selecting the Number of Recorded Pixels.....	75
Compensating for Exposure (EV Compensation).....	76
Adjusting the White Balance.....	77
Setting the Sensitivity .....	78
Switching the Face Detection Function .....	79
Setting the Image Sharpness (Sharpness).....	80
Setting the Color Saturation (Saturation).....	81
Setting the Image Contrast (Contrast).....	81
Setting the Date Imprint Function .....	81
Calling Up a Specific Function.....	82
<b>Recording Movies .....</b>	<b>84</b>
Recording a Movie.....	84
Setting the [🎥 Movie] Menu.....	85
Selecting the Recorded Pixels for Movies .....	86
Setting the Movie SR (Movie Shake Reduction) Function.....	86
<b>Saving the Settings (Memory) .....</b>	<b>87</b>
<b>Playing Back and Deleting Images .....</b>	<b>89</b>
<hr/>	
<b>Playing Back Images .....</b>	<b>89</b>
Playing Back Still Pictures .....	89
Playing Back a Movie .....	90
Multi-Image Display .....	91
Using the Playback Functions .....	93
Slideshow .....	94
Rotating an Image .....	96
Zoom Playback.....	97
<b>Deleting Images .....</b>	<b>98</b>
Deleting a Single Image .....	98
Deleting Selected Images.....	98
Deleting All Images.....	99

Protecting Images from Deletion (Protect) .....	100
<b>Connecting the Camera to AV Equipment</b> .....	<b>103</b>
<b>Editing and Printing Images</b>	<b>105</b>
<hr/>	
<b>Editing Images</b> .....	<b>105</b>
Changing the Image Size (Resize) .....	105
Cropping Images .....	106
Processing Images to Make a Face Look Smaller .....	107
Processing Images with the Miniature/HDR Filter .....	108
Processing Images with the Digital Filters .....	110
Compensating for an Unwanted Red-eye Effect .....	112
Adding a Frame (Frame Composite) .....	113
Editing Movies .....	116
Copying Images.....	118
<b>Setting the Printing Service (DPOF)</b> .....	<b>120</b>
Printing a Single Image .....	120
Printing All Images.....	122
<b>Settings</b>	<b>123</b>
<hr/>	
<b>Camera Settings</b> .....	<b>123</b>
Changing the [↖ Setting] Menu .....	123
Formatting the Memory .....	123
Changing the Sound Settings .....	124
Changing the Date and Time.....	125
Setting the World Time .....	127
Changing the Display Language .....	129
Changing the Naming System of the Folder.....	130
Changing the Video Output Format.....	131
Changing the Wallpaper of the Menu .....	131
Adjusting the Brightness of the Display .....	132
Using the Power Saving Function .....	133
Setting the Auto Power Off Function .....	133
Changing the Start-up Screen .....	134
Correcting Defective Pixels in the CCD Sensor (Pixel Mapping) .....	135
Starting-up in Playback Mode.....	136
Resetting to Default Settings (Reset) .....	136
<b>Connecting to a Computer</b>	<b>137</b>
<hr/>	
<b>Connecting to a Computer</b> .....	<b>137</b>
Setting the USB Connection Mode .....	137

Connecting the Camera and the Computer .....	138
Disconnecting the Camera from the Computer .....	139
<b>Using the Provided Software .....</b>	<b>140</b>
System Requirements .....	140
Installing the Software .....	141
Using MediaImpression on Windows .....	144
Using MediaImpression on Macintosh.....	146
<b>Appendix .....</b>	<b>148</b>
<hr/>	
<b>Functions Available for Each Shooting Mode.....</b>	<b>148</b>
<b>Messages.....</b>	<b>150</b>
<b>Troubleshooting.....</b>	<b>152</b>
<b>Default Settings.....</b>	<b>154</b>
<b>List of World Time Cities .....</b>	<b>159</b>
<b>Optional Accessories .....</b>	<b>160</b>
<b>Main Specifications .....</b>	<b>161</b>
<b>WARRANTY POLICY .....</b>	<b>165</b>
<b>Index.....</b>	<b>171</b>

In this manual, the method for operating the four-way controller is shown in illustrations, such as in the ones below.

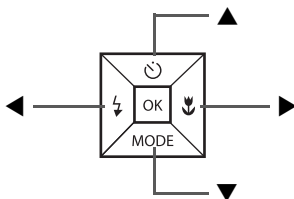

The meanings of the symbols used in this Operating Manual are explained below.

	indicates the reference page number for an explanation of the related operation.
	indicates information that is useful to know.
	indicates precautions to be taken when operating the camera.
mode	This is the mode for capturing still pictures and recording movies.
mode	This is the mode for viewing still pictures and playing back movies.

# Composition of the Operating Manual

This Operating Manual contains the following chapters.

## 1 Getting Started

This chapter explains what you need to do after purchasing the camera before you start taking pictures. Be sure to read this chapter and follow the instructions.

## 2 Common Operations

This chapter explains common operations such as the functions of the buttons and how to use the menus. For more details, refer to the respective chapters below.

## 3 Taking Pictures

This chapter explains the various ways of capturing images and how to set the relevant functions.

## 4 Playing Back and Deleting Images

This chapter explains how to view still pictures and movies on the camera or on a TV screen and how to delete them from the camera.

## 5 Editing and Printing Images

This chapter explains how to edit still pictures on the camera and how to print them.

## 6 Settings

This chapter explains how to set the camera-related functions.

## 7 Connecting to a Computer

This chapter explains how to connect the camera to a computer, and includes installation instructions and a general overview of the provided software.

## 8 Appendix

This chapter deals with troubleshooting and lists the optional accessories.

1

2

3

4

5

6

7

8

# Camera Features

In addition to basic picture-taking, this camera has a variety of shooting modes to suit different situations. This section describes how to make the most of the key features of your camera. For details of camera operations, refer to the pages for each function.

## Easy-to-Navigate Capture and Playback Functions!

The user-friendly design of this camera enables easy operation with only a few buttons. Simply by choosing the appropriate icon, you can select the shooting mode (p.57) and choose the optimal settings for the situation, or the playback mode (p.93, p.105) and enjoy the various playback and editing functions. A guide on the display lets you check the functions available in each mode and how to use them.



- **A shooting mode guide is displayed in the Capture Mode Palette and a playback mode guide in the Playback Mode Palette (p.57, p.93).**
- **Use the Green Mode to take pictures easily using standard settings (p.61).**

## Perfect for Portrait Shots!

This camera comes with a “Face Detection” function that spots the faces in your shot and automatically adjusts the focus and exposure for the faces. It can detect up to 16 people per shot, so it will help you take perfect group shots too. It will automatically release the shutter when one or more of the subjects are smiling, so you can take many shots from which you can choose the best.

- **Face Detection function (p.59)**
- **Modes for taking stunning pictures of people (p.58)**

## Add Fun Frames to Your Pictures!

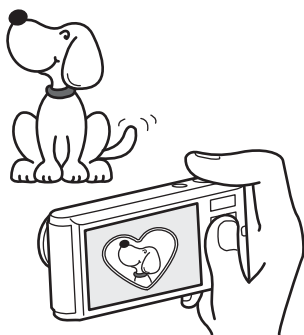

When you take a picture with this camera, you can choose from our original fun frames to create attractive framed shots (p.66). You can also add frames to pictures you have taken. Adjust the position of the subject in the picture or reduce or enlarge the picture size to match the frame shape and size. Now you no longer have to worry about the subject not fitting into the frame (p.113).

- **For decorating your pictures with a frame**

## Display Your Data in Calendar Format!

With this camera, you can display recorded images and movies by date in calendar format (p.92). This lets you quickly find the image or movie you want to play back.

## Advanced Movie Recording Functions

This camera has a “Movie SR” function to reduce camera shake during movie recording (p.86), and it enables you to record movies in 1280×720 pixel (16:9) HDTV format (\*) (p.86).

\* When connecting to and playing back images on AV equipment, the recorded data is output at normal screen resolution. To view movies in HDTV, transfer the data to a computer and play it back on the computer.

- **Use the camera to shoot fun-filled movies of your children or pets as a visual diary of their development (p.84).**

## A Multitude of Functions Inside the Camera for Enjoying Images Without a Computer!

This camera has a variety of functions to let you enjoy playing back and editing images without having to connect the camera to your computer. The camera is all you need to take and edit still pictures and movies (p.105).

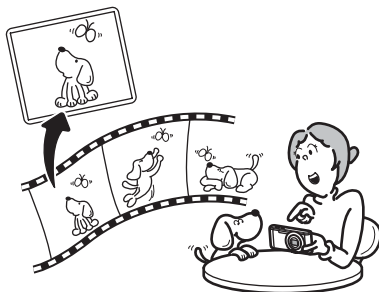

- **Image processing features such as Resize (p.105), Cropping (p.106), Digital Filter (p.110) and Red-eye Compensation (p.112) can be used.**
- **You can divide a movie into two or more segments and select a frame from a movie to save it as a still picture (p.116).**

## Checking the Contents of the Package

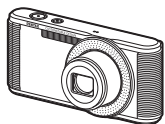

Camera  
Optio LS465

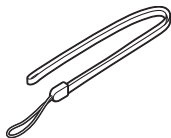

Strap  
O-ST116 (\*)

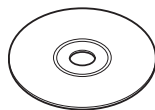

Software (CD-ROM)  
S-SW127

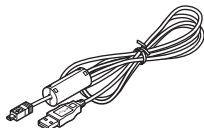

USB cable  
I-USB116 (\*)



Alternative Skins  
(10 types)

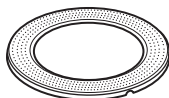

Lens Ring O-LR2  
(installed on camera)



Rechargeable lithium-ion  
battery D-LI108 (\*)

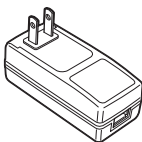

Power adapter  
D-PA116 (\*)



Quick Guide



Operating Manual  
(this manual)

Items marked with an asterisk (\*) are also available as optional accessories. For other optional accessories, refer to "Optional Accessories" (p.160).

## Names of Parts

### Front

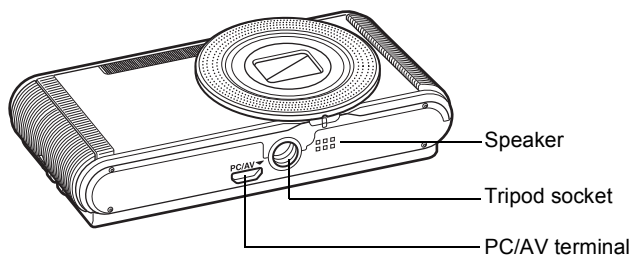
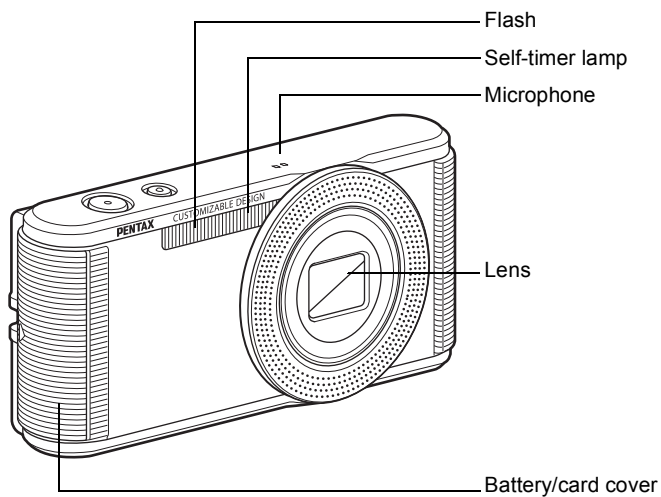

## Back



## Names of Operating Parts

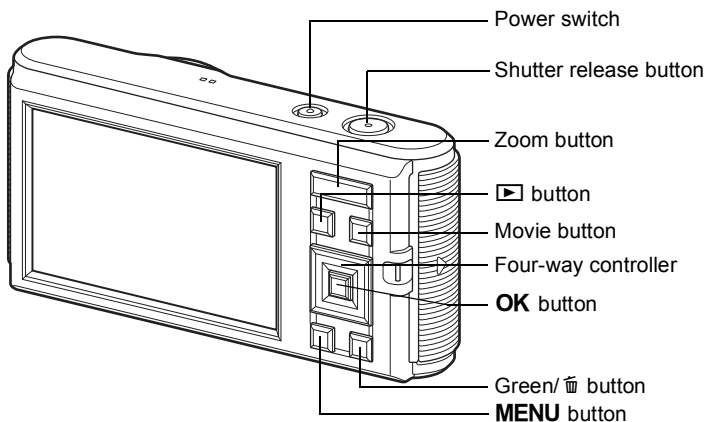



Refer to “Understanding the Button Functions” (p.42 - p.45) for an explanation of the function of each button.

# Monitor Indications

## Display in Mode

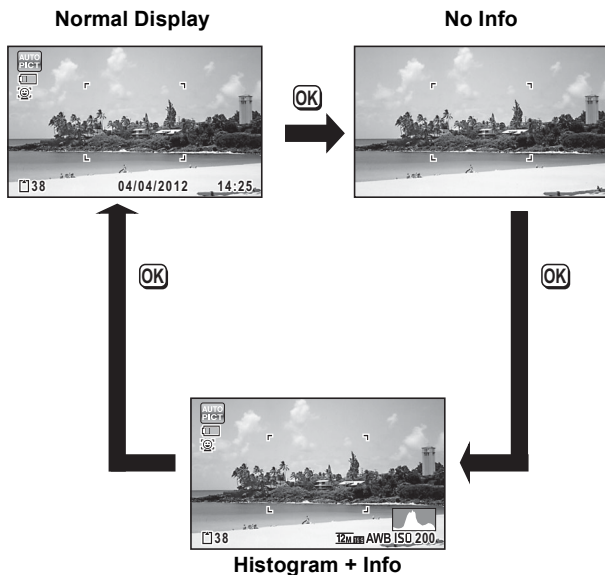
The display shows information such as the shooting conditions in capture mode. The display changes in the following sequence each time you press the **OK** button: “Normal Display”, “No Info” and “Histogram + Info”.



When the shooting mode is set to  (Green) mode, the monitor display is as shown on the right. You cannot change the information on the display by pressing the **OK** button (p.61).



## Still Picture Capture Mode

(All of the display items are displayed here for explanatory purposes.) A1 to A14 and B1 appear when “Normal Display” is selected. All the icons appear when “Histogram + Info” is selected. Only B1 appears when “No Info” is selected.

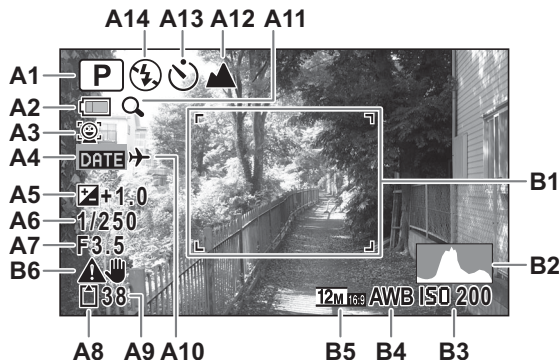

- |   |  |
|---|--|
| <b>A1</b> Shooting mode (p.57)                | <b>A11</b> Digital zoom/<br>Intelligent Zoom icon (p.63) |
| <b>A2</b> Battery level indicator (p.33)      | <b>A12</b> Focus Mode (p.73)                             |
| <b>A3</b> Face Detection mode (p.59)          | <b>A13</b> Drive Mode (p.71)                             |
| <b>A4</b> Date Imprint setting (p.81)         | <b>A14</b> Flash Mode (p.70)                             |
| <b>A5</b> EV Compensation (p.76)              | <b>B1</b> Focus frame (p.54)                             |
| <b>A6</b> Shutter speed                       | <b>B2</b> Histogram (p.24)                               |
| <b>A7</b> Aperture                            | <b>B3</b> Sensitivity (p.78)                             |
| <b>A8</b> Memory status (p.36)                | <b>B4</b> White Balance (p.77)                           |
| <b>A9</b> Remaining image storage<br>capacity | <b>B5</b> Recorded Pixels (p.75)                         |
| <b>A10</b> World Time setting (p.127)         | <b>B6</b> Shake Reduction icon                           |

\* A3 varies depending on the [Face Detection] setting in the [Rec. Mode] menu.

	When [Face Detection] is set to [On]
	When [Face Detection] is set to [Smile]

If set to [Off], nothing appears in A3.

\* A6 and A7 appear only when the shutter release button is pressed halfway.

- \* When the shooting mode is **AUTO PICT** (Auto Picture) and if you press the shutter release button halfway, the automatically selected shooting mode appears in A1 even when “No Info” is selected (p.60).
- \* The current date and time (p.20) appear instead of B3 to B5 for two seconds when “Normal Display” is selected.
- \* Some indications may not appear depending on the shooting mode.

## Display in Mode

The display shows the shooting information of the image in playback mode. The display changes in the following sequence each time you press the **OK** button: “Normal Display”, “No Info” and “Histogram + Info”.

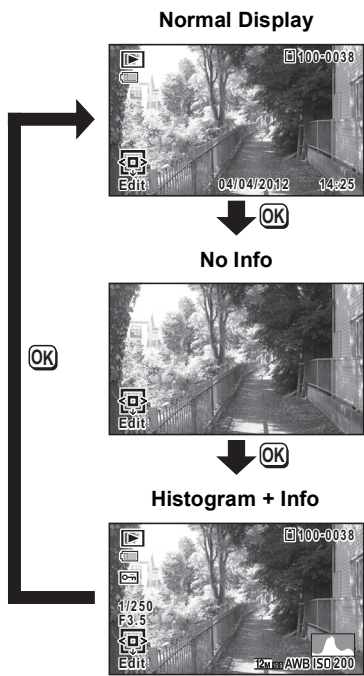

## Playback Mode

(All of the display items are displayed here for explanatory purposes.)

The display shows information such as the shooting conditions. A1 to A8 appear when “Normal Display” or “Histogram + Info” is selected. B1 to B6 appear only when “Histogram + Info” is selected.

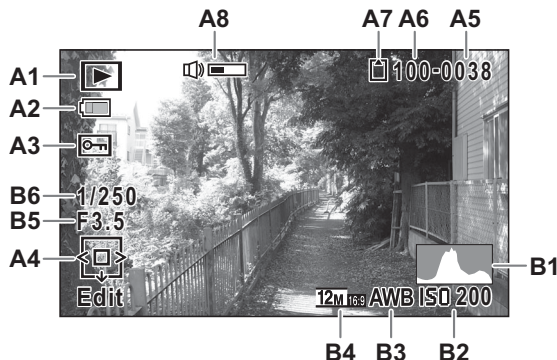





- |   |                                  |
|---|----------------------------------|
| <b>A1</b> Playback mode<br>▶ : Still picture (p.89)<br>▶ : Movie (p.90) | <b>A7</b> Memory status (p.36)   |
| <b>A2</b> Battery level indicator (p.33)                                | <b>A8</b> Volume icon            |
| <b>A3</b> Protect icon (p.100)  | <b>B1</b> Histogram (p.24)       |
| <b>A4</b> Four-way controller guide                                     | <b>B2</b> Sensitivity (p.78)     |
| <b>A5</b> File number   | <b>B3</b> White Balance (p.77)   |
| <b>A6</b> Folder number (p.130)   | <b>B4</b> Recorded Pixels (p.75) |
|   | <b>B5</b> Aperture               |
|   | <b>B6</b> Shutter speed          |

- \* In “Normal Display”, A2 disappear if no operation is performed for two seconds.
- \* A8 appears only when the volume is being adjusted during playback of movies (p.90).
- \* A4 appears even when “No Info” is selected, but disappears if no operation is performed for two seconds. When no operation is performed for two seconds in “Normal Display” or “Histogram + Info”, only “Edit” disappears.
- \* Captured date and time (p.89) appear instead of B2 to B4 for two seconds when “Normal Display” is selected.

## Guide Indications

A guide indication for each available button/key operation appears as follows on the display during operation.

▲	Four-way controller (▲)
▼	Four-way controller (▼)
◀	Four-way controller (◀)
▶	Four-way controller (▶)
	<b>MENU</b> button

	Zoom button
	<b>OK</b> button
	Shutter release button
	Green/🗑️ button

## Using the Histogram

A histogram shows the brightness distribution of an image. The horizontal axis represents brightness (dark at the left and bright at the right) and the vertical axis represents the number of pixels.

The shape of the histogram before and after shooting tells you whether the brightness and contrast are correct or not, and lets you decide if you need to adjust the exposure and take a picture again.

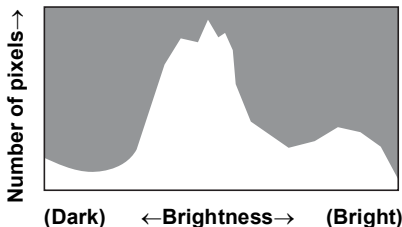

Compensating for Exposure (EV Compensation)  p.76

## Understanding Brightness

If the brightness is correct, the graph peaks in the middle. If the image is underexposed, the peak is on the left side, and if it is overexposed, the peak is on the right side.

Dark image

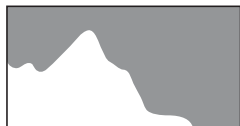

Correct image

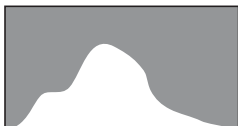

Bright image

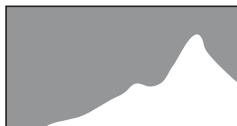

When the image is underexposed, the part to the left is cut off (dark portions) and when the image is overexposed, the part to the right is cut off (bright portions).

### **Understanding Contrast**

The graph peaks gradually for images in which contrast is balanced. The graph peaks on both sides but sinks in the middle for images with a large difference in contrast and low amounts of mid-level brightness.

# Attaching the Strap

Attach the strap supplied with the camera.

1

Getting Started

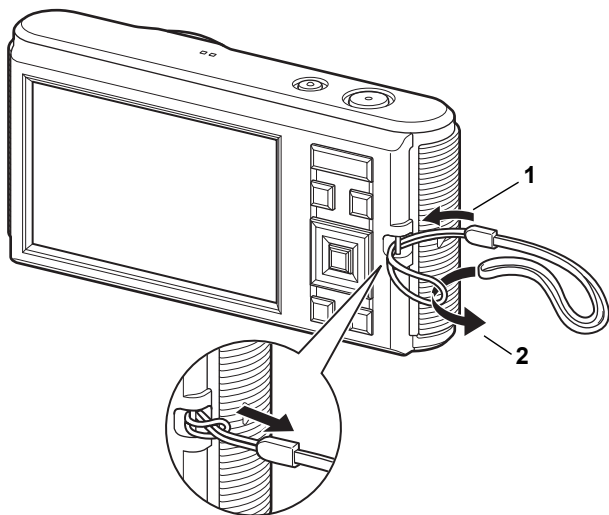

- 1** Pass the narrow end of the strap through the strap lug.
- 2** Pass the other end of the strap through the loop and pull tight.

# Dress-up the Camera

The Alternative Skins are supplied with the camera. You can choose a desired sheet and put it on the front of the camera to dress up.

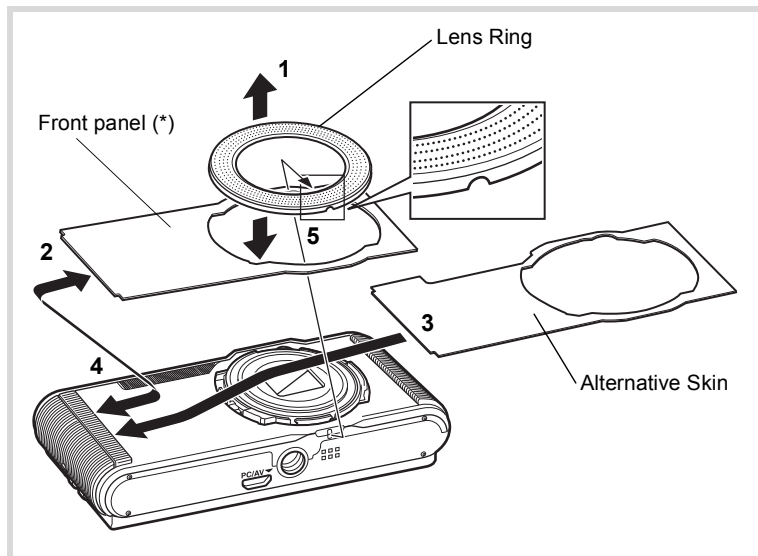

\* At shipment, a transparent film for protection is attached to the front panel. Peel off the film when you use the camera.

## 1 Remove the lens ring.

Put the camera on a flat surface and detach the lens ring following the direction of arrow 1.



Take care not to lose the lens ring.

## 2 Remove the front panel.

## 3 Put on an Alternative Skin.

---

#### 4 Put on the front panel.

---

#### 5 Attach the lens ring.

Replace the lens ring removed in Step1.

Put the camera on a flat surface, fit the lens ring to the camera in its designated position, snap the lens ring along the groove.

A starburst-shaped icon containing the word "Caution".

- Be sure to attach the front panel when you use the camera.
- When attaching the lens ring, take care not to press against the monitor with your hand. This may cause the monitor to crack.

# Powering the Camera

## Installing the Battery

Use the rechargeable lithium-ion battery D-LI108 that is provided with the camera.

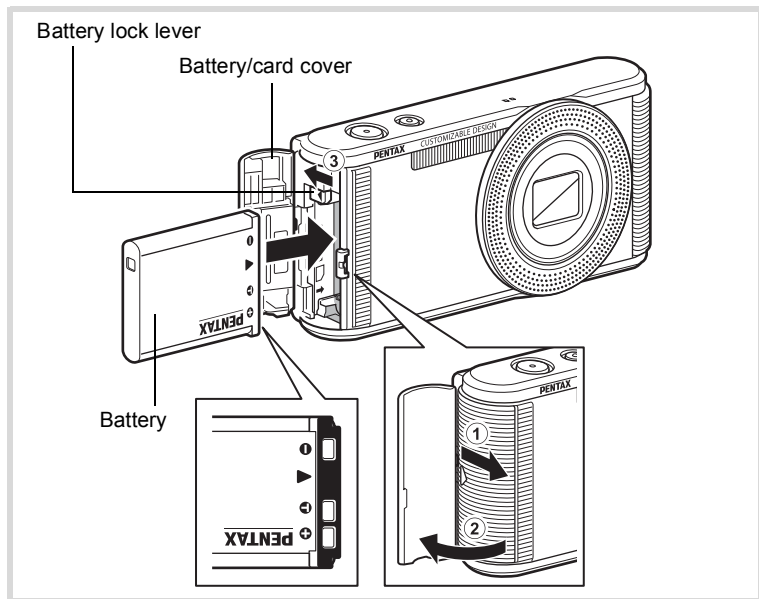

- 1 Make sure that the camera is turned off and open the battery/card cover.**  
Slide the battery/card cover in the direction indicated by the arrow ① and flip the cover open ②.
- 2 Push the battery lock lever in the direction of the arrow ③ and insert the battery so that the PENTAX logo is facing the lens side of the camera.**  
Match the marks on the battery to the marks inside the battery compartment and push the battery in until it is locked in place.

### 3 Close the battery/card cover.

Slide the battery/card cover in the opposite direction indicated by ①. When you hear a click, the cover is securely closed.

Charge the battery before using it in the camera for the first time. (p.31)

## To Remove the Battery

### 1 Make sure that the camera is turned off and open the battery/card cover.

### 2 Push the battery lock lever in the direction of the arrow ③.

The battery will be ejected. Take care not to drop the battery when removing it.



- This camera uses a rechargeable lithium-ion battery D-LI108. Use of any other type of battery may damage the camera and cause a malfunction.
- Insert the battery correctly. If the battery is incorrectly oriented, malfunction may result.
- When storing the battery for more than 6 months, charge the battery for 30 minutes and store the battery separately from the camera. Be sure to recharge the battery every 6 to 12 months. Storing the battery at or below room temperature is ideal. Avoid storing it at high temperature.
- The date and time may be returned to the default setting if the camera is left without the battery for a long time.
- Be careful as the camera or the battery may become hot when the camera is used continuously for a long period of time.

## Charging the Battery

Charge the battery from a power outlet using the provided power adapter (D-PA116) and USB cable (I-USB116) before using it for the first time, after a long period of non-use, or when the [Battery depleted] message appears.

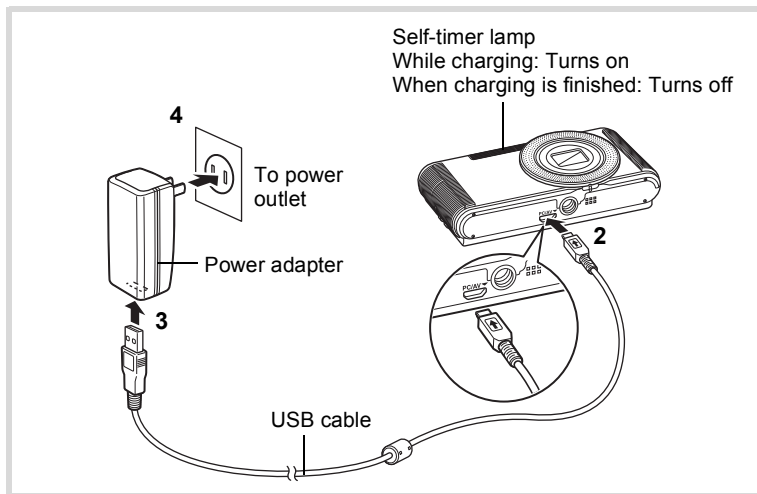

- 1 Make sure that the battery is installed in the camera.**
- 2 Face the  $\blacktriangleright$  mark on the USB cable towards the  $\blacktriangleleft$  mark on the camera, and connect the cable to the PC/AV terminal.**
- 3 Connect the other end of the USB cable to the power adapter.**
- 4 Plug the power adapter into the power outlet.**  
The self-timer lamp turns on while the battery is charging and turns off when charging is finished.
- 5 Unplug the power adapter from the power outlet, and disconnect the USB cable from your camera.**



- Do not use the power adapter D-PA116 to charge batteries other than the rechargeable lithium-ion battery D-LI108, as the adapter may overheat or be damaged.
- Make sure that the battery has been inserted correctly and the cable is connected properly if the self-timer lamp blinks.
- Replace the battery with a new one in the following cases:
  - If the battery starts to run down more quickly (the battery may have reached the end of its service life)
  - If the self-timer lamp does not light or blinks even after being charged (the battery may be faulty)



- The time required to fully charge the battery is about 130 minutes (at room temperature of 25°C). However, the charging time may vary depending on the ambient temperature and charging conditions. The appropriate ambient temperature for charging the battery is 0°C to 40°C (32°F to 104°F).
- The rechargeable lithium-ion battery D-LI108 can also be charged using the optional battery charger D-BC108.
- The battery cannot be charged using a computer or similar devices. Do not attempt to charge the battery by connecting the USB cable to a computer.

## • Image Storage Capacity, Movie Recording Time, and Playback Time (at 23°C with the display on and the battery fully charged)

Image Storage Capacity <sup>*1</sup> (flash used for 50% of shots)	Movie Recording Time <sup>*2</sup>	Playback Time <sup>*2</sup>
Approx. 200 pictures	Approx. 70 min.	Approx. 130 min.

\*1 Image Storage Capacity shows the approximate number of shots recorded during CIPA-compliant testing (with display on, flash used for 50% of the shots, and 23 degrees centigrade). Actual performance may vary according to operating conditions.





\*2 According to the result of in-house testing.



- In general, battery performance may temporarily deteriorate as the temperature decreases.
- Be sure to take a spare battery with you when traveling abroad or to a cold region, or if you intend to take a lot of pictures.

## • Battery Level Indicator

You can check the battery level by the indicator on the display.

Screen Display	Battery Status
 (green)	Adequate power remains.
 (green)	Battery is running low.
 (yellow)	Battery is running very low.
 (red)	Battery is exhausted.
[Battery depleted]	The camera will turn off after this message appears.

# Installing an SD Memory Card

1

Getting Started

This camera uses a commercially available SD Memory Card, SDHC Memory Card, or SDXC Memory Card. Captured images are saved on the SD Memory Card when a card is inserted in the camera. They are saved in the built-in memory when a card is not inserted (p.36).



**Be sure to use this camera to format (initialize) an SD Memory Card that is unused or has been used on other cameras or digital devices. Refer to “Formatting the Memory” (p.123) for instructions on formatting.**



- The number of still pictures that can be stored and movie recording time vary depending on the capacity of the SD Memory Card and the selected number of recorded pixels.
  - Choose the appropriate number of recorded pixels for still pictures on the [📷 Rec. Mode] menu. Refer to “Selecting the Number of Recorded Pixels” (p.75) for details.
  - Choose the appropriate number of recorded pixels for movies on the [🎥 Movie] menu. Refer to “Selecting the Recorded Pixels for Movies” (p.86) for details.
  - For an approximate guide to the number of still pictures or the length of recorded movies that can be saved on an SD Memory Card or in the built-in memory, see “Main Specifications” (p.162).
- The self-timer lamp blinks while the SD Memory Card is being accessed (data is being recorded or read).

## Backing Up Data

The camera may not be able to access data in the SD Memory Card or built-in memory in the case of a malfunction. Use a computer or other device to back up important data in another location.

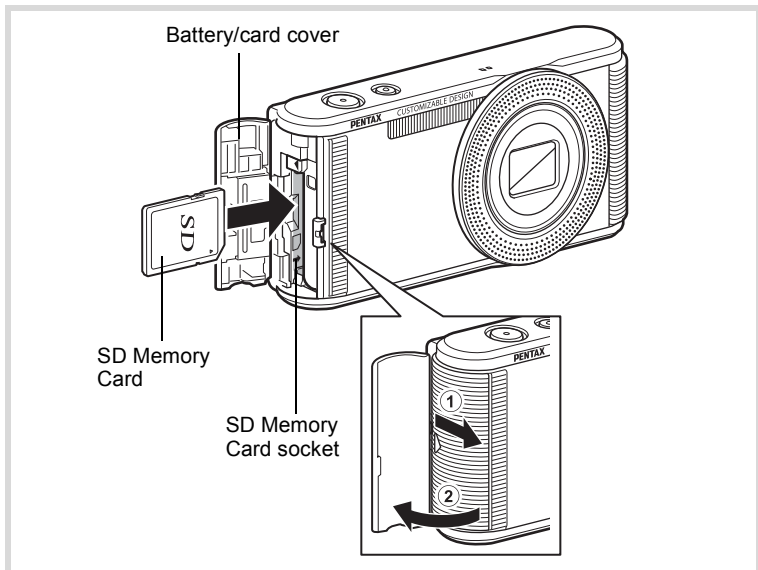

**1 Make sure that the camera is turned off and open the battery/card cover.**

Slide the battery/card cover in the direction indicated by the arrow ① and flip the cover open ②.

**2 Insert the SD Memory Card into the SD Memory Card socket so that the label is facing the lens side of the camera.**

Push the card in until it clicks. Data may not be recorded correctly if the card is not inserted all the way.

To remove the SD Memory Card, push it in once and then pull it out.

**3 Close the battery/card cover.**

Slide the battery/card cover in the opposite direction indicated by ①. When you hear a click, the cover is securely closed.

# Turning the Camera On and Off

1

Getting Started

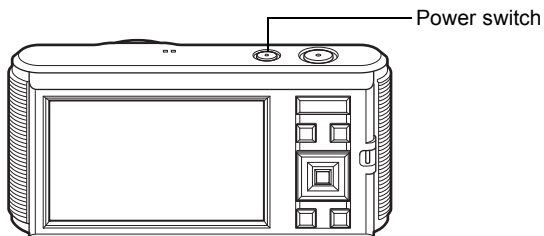

## 1 Press the power switch.

The camera turns on and the display turns on.

When you turn the camera on, the lens cover opens and the lens extends.

If the [Language/言語] screen or [Date Adjustment] screen appears when you turn the camera on, follow the procedure on p.37 to set the display language and/or current date and time.

## 2 Press the power switch again.

The display turns off, the lens closes, and the camera turns off.

Taking Still Pictures p.54

## Checking the SD Memory Card

The SD Memory Card is checked when the camera turns on and the memory status is displayed.

	The SD Memory Card is inserted. Images will be saved on the SD Memory Card.
	The SD Memory Card is not inserted. Images will be saved in the built-in memory.
	The write-protect switch on the SD Memory Card is in the LOCK position (p.6). Images cannot be recorded.



Memory status

# Initial Settings

1

Getting Started

The [Language/言語] screen appears when the camera is turned on for the first time. Perform the operations in “Setting the Display Language” below to set the language, and in “Setting the Date and Time” (p.40) to set the current date and time.

The language, date, and time can be changed later. Refer to the pages below for instructions.

- To change the language, follow the steps in “Changing the Display Language” (p.129).
- To change the date and time, follow the steps in “Changing the Date and Time” (p.125).

## Setting the Display Language

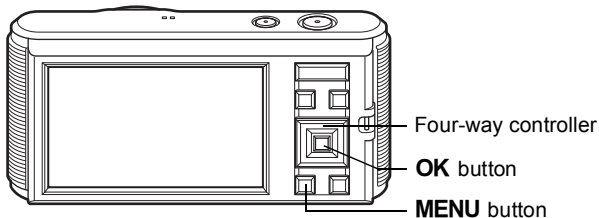

**1 Use the four-way controller (▲▼◀▶) to choose the desired display language.**

**2 Press the OK button.**

The [Initial Setting] screen appears in the selected language. If the desired settings for [Hometown] and [DST] (Daylight Saving Time) appear, proceed to Step 9. Proceed to Step 3 if the desired settings do not appear.

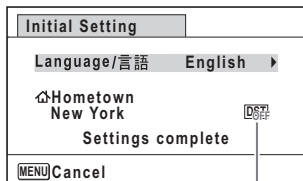

Daylight saving time

If you accidentally select the wrong language and proceed to the next procedure, perform the following operation to set the desired language.

● **When the Wrong Language Has Been Inadvertently Selected**

- 1 Press the four-way controller (▶).**
- 2 Use the four-way controller (▲ ▼ ◀ ▶) to select the desired language and press the OK button.**

The [Initial Setting] screen appears in the selected language.

● **When the Screen After Step 2 Appears in the Wrong Language**

- 1 Press the MENU button.**  
The setting screen is canceled and the camera is set to still picture capture mode.
- 2 Press the MENU button.**  
The [📷 Rec. Mode] menu appears.
- 3 Press the four-way controller (▶) twice.**  
The [↶ Setting] menu appears.
- 4 Use the four-way controller (▲ ▼) to select [Language/言語].**
- 5 Press the four-way controller (▶).**  
The [Language/言語] screen appears.
- 6 Use the four-way controller (▲ ▼ ◀ ▶) to select the desired language.**
- 7 Press the OK button.**  
The [↶ Setting] menu appears in the selected language.

To reset the Hometown city, date, and time, refer to the pages below for instructions.

- To change the Hometown city, follow the steps in “Setting the World Time” (p.127).
- To change the date and time, follow the steps in “Changing the Date and Time” (p.125).

**3 Press the four-way controller (▼).**

The frame moves to [Home Hometown].

**4 Press the four-way controller (▶).**

The [Home Hometown] screen appears.

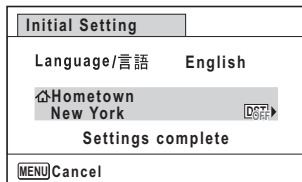
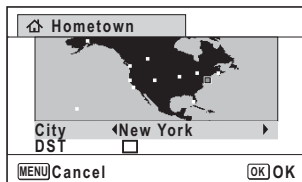
**5 Use the four-way controller (◀▶) to choose a city.****6 Press the four-way controller (▼).**

The frame moves to [DST] (Daylight Saving Time).

**7 Use the four-way controller (◀▶) to select  (On) or  (Off).****8 Press the OK button.**

The [Initial Setting] screen reappears.

**9 Press the four-way controller (▼) to select [Settings complete].****10 Press the OK button.**

The [Date Adjustment] screen appears. Next, set the date and time.

The video output format (NTSC/PAL) is set to the format of the city selected in [Hometown] on the [Initial Setting] screen. Refer to "List of World Time Cities" (p.159) for the video output format of each city that will be set at the time of initial setting, and "Changing the Video Output Format" (p.131) for changing the video output format.

## Setting the Date and Time

Set the current date and time and the display style.

### 1 Press the four-way controller (▶).

The frame moves to [mm/dd/yy].

### 2 Use the four-way controller (▲▼) to choose the date format.

Choose from [mm/dd/yy], [dd/mm/yy] or [yy/mm/dd].

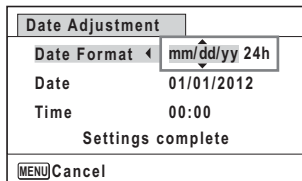

### 3 Press the four-way controller (▶).

The frame moves to [24h].

### 4 Use the four-way controller (▲▼) to select [24h] (24-hour display) or [12h] (12-hour display).

### 5 Press the four-way controller (▶).

The frame returns to [Date Format].

### 6 Press the four-way controller (▼).

The frame moves to [Date].

### 7 Press the four-way controller (▶).

The frame moves to the month.

### 8 Use the four-way controller (▲▼) to change the month.

Change the day and year in the same manner.

Next, change the time.

If you selected [12h] in Step 4, the camera automatically switches the display between am and pm corresponding to the time.

### 9 Press the four-way controller (▼) to select [Settings complete].

### 10 Press the OK button.

This confirms the date and time.



If you press the **OK** button in Step 10, the camera clock is reset to 0 seconds. To set the exact time, press the **OK** button when the time signal (on the TV, radio, etc.) reaches 0 seconds.



When the [Initial Setting] or [Date Adjustment] screen is displayed, you can cancel the settings made up to that point and switch to the capture mode by pressing the **MENU** button. In this case, the [Initial Setting] screen will appear again the next time you turn the camera on.

The language, date, time, Hometown city, and DST setting can be changed. Refer to the pages below for instructions.

- To change the language, follow the steps in “Changing the Display Language” (☞p.129).
- To change the date and time, follow the steps in “Changing the Date and Time” (☞p.125).
- To change the Hometown city or DST setting, follow the steps in “Setting the World Time” (☞p.127).

# Understanding the Button Functions

## Mode

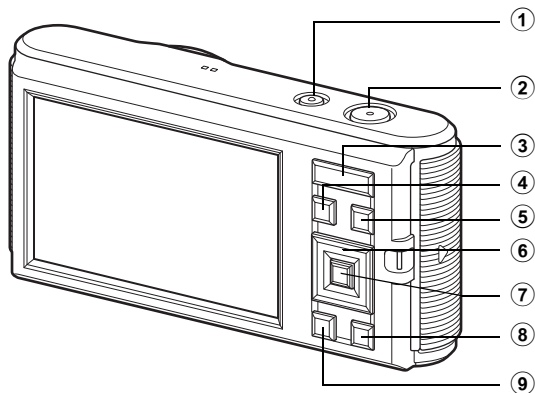

- ① **Power switch**  
Turns the camera on and off (p.36).
- ② **Shutter release button**  
Focuses the camera on the subject when pressed halfway in still picture capture mode (except in **PF** and **▲** modes).  
Takes a still picture when pressed down fully (p.55).
- ③ **Zoom button**  
Changes the area captured by the camera (p.63).  
Switches to the [📷 Rec. Mode] menu, [🎬 Movie] menu, or [⚙️ Setting] menu when a menu screen is displayed.
- ④ **▶ button**  
Switches to the ▶ mode (p.46).
- ⑤ **Movie button**  
Starts and stops movie recording (p.84).

**⑥ Four-way controller**

- ▲ Changes the drive mode (p.71).
- ▼ Displays the Capture Mode Palette (p.57).
- ◀ Changes the flash mode (p.70).
- ▶ Changes the focus mode (p.73).

**⑦ OK button**

Changes the information on the display (p.20).

**⑧ Green button**

Switches to the  (Green) mode (p.61).  
Calls up the assigned function (p.82).

**⑨ MENU button**

Displays the [ Rec. Mode] menu (p.47).

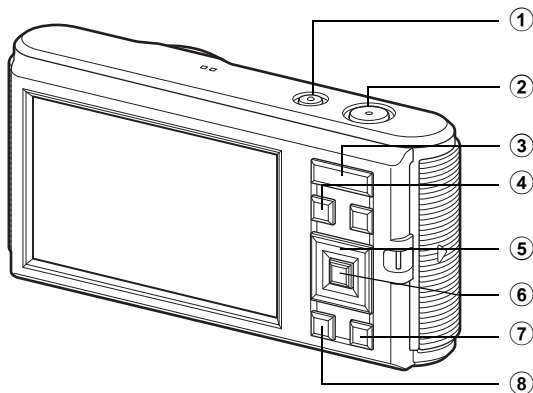

① **Power switch**

Turns the camera on and off (p.36).

② **Shutter release button**

Switches to mode (p.46).

③ **Zoom button**

Press towards the left () during single-image display to change to six-image display. Changes to twelve-image display when pressed towards the left again. Returns to the previous display when pressed towards the right () (p.91).

Enlarges the image when pressed towards the right () during single-image display. Returns to the previous display when pressed towards the left () (p.97).

Press towards the left () during twelve-image display to change to folder or calendar display (p.92).

Press towards the right () during folder/calendar display to change to twelve-image display (p.92).

Adjusts the volume during playback of movies (p.90).

④ **▶ button**

Switches to mode (p.46).

## ⑤ Four-way controller

- ▲ Plays back or pauses a movie (p.90).
- ▼ Displays the Playback Mode Palette (p.93).  
Stops a movie during playback (p.90).
- ◀▶ Displays the previous or next image during single-image display (p.89).  
Fast-forwards, fast-reverses, frame forwards, frame reverses, plays back a movie in forward and reverse during movie playback (p.90).
- ▲▼◀▶ Selects an image during six-/twelve-image display, a folder during folder display, and a date during calendar display (p.91, p.92).  
Moves the display area during zoom display (p.97).  
Moves the image when using the Frame Composite function (p.113).

## ⑥ OK button

- Changes the information on the display (p.22).
- Returns to single-image display during six-/twelve-image display or zoom display (p.91, p.97).
- Changes to twelve-image display of the selected folder during folder display (p.92).
- Changes to single-image display of the selected date during calendar display (p.92).



## ⑦ Green/ button

- Switches from single-image display to the Delete screen (p.98).
- Switches from six-/twelve-image display to the Select & Delete screen (p.98).
- Switches from folder display to the calendar display screen (p.92).
- Switches from calendar display to the folder display screen (p.92).

## ⑧ MENU button

- Displays the [ Setting] menu during single-image display (p.47).
- Returns to single-image display during Playback Mode Palette display (p.93).
- Returns to single-image display during six-/twelve-image display or zoom display (p.91).
- Changes to twelve-image display during folder or calendar display (p.92).

## Switching Between Mode and Mode

In this manual, the capture mode, such as for taking still pictures, is referred to as “ mode” (the capture mode). The playback mode, such as for viewing the captured images on the display, is referred to as “ mode” (the playback mode). In  mode, you can perform simple editing operations on the captured images.

Follow the procedure below to switch between  mode and  mode.

### To Switch from Mode to Mode

#### 1 Press the button.

The camera switches to  mode.

### To Switch from Mode to Mode

#### 1 Press the button or the shutter release button halfway.

The camera switches to  mode.

### Displaying the data stored in the built-in memory

When an SD Memory Card is inserted in the camera, images and movies stored on the SD Memory Card are displayed.

To display images and movies stored in the built-in memory, turn the camera off first, and then remove the SD Memory Card before proceeding.



Make sure that the camera is turned off before inserting or removing the SD Memory Card.

# Setting the Camera Functions

To change the camera settings, press the **MENU** button to display the menu screens. Functions for playing back and editing images are called up from the Playback Mode Palette (p.93).

## Operating the Menus

There are three menus available with the camera: [📷 Rec. Mode], [🎥 Movie], and [⚙️ Setting].

Press the **MENU** button in 📷 mode to display the [📷 Rec. Mode] menu. Press the **MENU** button in 🎥 mode to display the [⚙️ Setting] menu. Use the four-way controller (◀▶) or zoom button to switch between the menus.

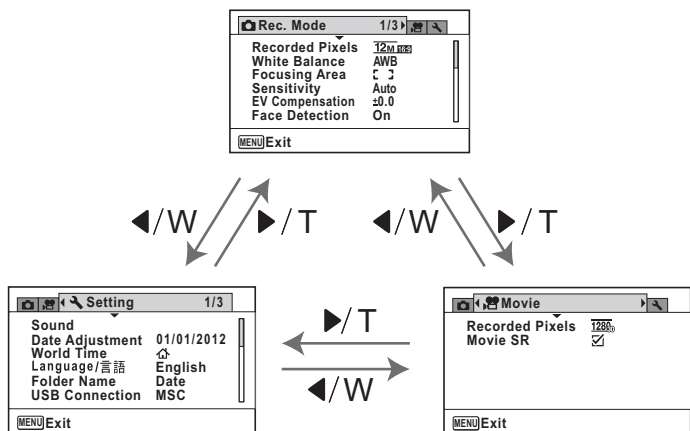

Available button operations appear on the display during menu operation (p.24).

## Ex.) To set [Focusing Area] on the [Rec. Mode] menu

### 1 Press the MENU button in mode.

The [ Rec. Mode] menu appears.

### 2 Press the four-way controller (▼).

The frame moves to [Recorded Pixels].

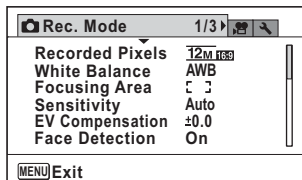

### 3 Press the four-way controller (▼) twice.

The frame moves to [Focusing Area].

### 4 Press the four-way controller (▶).

A pull-down menu appears only with the items that are available with the current camera settings.

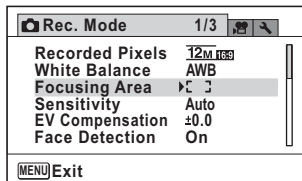

### 5 Use the four-way controller (▲▼) to change the setting.

The focusing area changes each time the four-way controller (▲▼) is pressed.

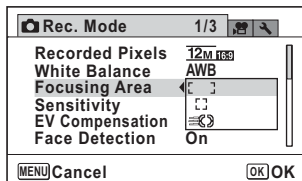

### 6 Press the OK button or the four-way controller (◀).

The setting is saved and then the camera is ready for setting the other functions.

To exit the setting operation, press the **MENU** button.

To perform another operation, refer to the following alternate Step 6 options.

## To Save the Setting and Start Taking Pictures

### 6 Press the shutter release button halfway.

The setting is saved and the camera returns to capture status. When the shutter release button is pressed fully, the picture is taken.



When the [ Setting] menu is displayed from mode, you can switch to mode by pressing the button.

## To Save the Setting and Start Playback of Images

### 6 Press the button.

When the [ Rec. Mode] menu is displayed from mode, the setting is saved and the camera returns to playback status.

## To Cancel the Changes and Continue with Menu Operations

### 6 Press the MENU button.

The changes are canceled and the screen shown in Step 3 reappears.



The **MENU** button function varies depending on the screen. Refer to the guide indications.

Exit	Exits the menu and returns to the original screen.
	Returns to the previous screen with the current setting.
Cancel	Cancels the current selection, exits the menu and returns to the previous screen.

## Menu List

This displays the items that can be set from the menus and provides descriptions of each item. See the list of default settings in the Appendix “Default Settings” (p.154) to check whether the settings are saved when the camera is turned off and whether the settings return to the defaults when the camera is reset.

### [📷 Rec. Mode] Menu

Item	Description	Page
Recorded Pixels	For choosing the number of recorded pixels for still pictures	p.75
White Balance	For adjusting the color balance according to the light conditions	p.77
Focusing Area	For changing the autofocus area	p.74
Sensitivity	For setting the sensitivity	p.78
EV Compensation	For adjusting the overall brightness of the picture	p.76
Face Detection	For spotting the faces in your shot and automatically adjusting the focus and exposure for the faces	p.79
Digital Zoom	For choosing whether or not to use the Digital Zoom function	p.64
Memory	For choosing whether to save the set values of the shooting function or return to the defaults when the camera is turned off	p.87
Green Button	For assigning a function to the Green button so that you can go straight to it in 📷 mode	p.82
Sharpness	For choosing sharp or soft outlines	p.80
Saturation	For setting the color saturation	p.81
Contrast	For setting the image contrast level	p.81
Date Imprint	For choosing whether to imprint the date and/or time when taking still pictures	p.81

## ● [📷 Rec. Mode] Menu 1

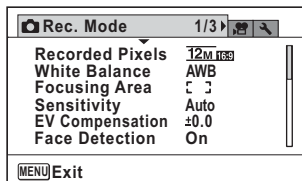

## ● [📷 Rec. Mode] Menu 2

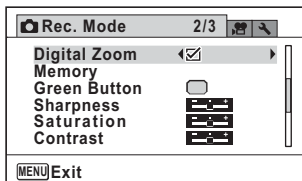

## ● [📷 Rec. Mode] Menu 3

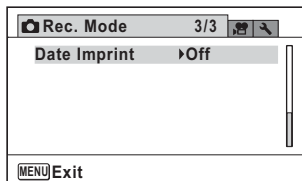

- Use the **Green** mode to enjoy easy picture-taking using standard settings, regardless of the settings in the [📷 Rec. Mode] menu (p.61).
- Assigning a frequently used function to the Green button enables you to go straight to the desired function (p.83).

## [🎬 Movie] Menu

Item	Description	Page
Recorded Pixels	For choosing the number of recorded pixels for movies	p.86
Movie SR	For choosing whether or not to use the Movie Shake Reduction function	p.86

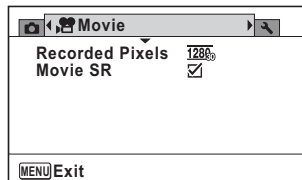

## [ Setting] Menu

Item	Description	Page
Sound	For adjusting the operation volume and playback volume, and setting the start-up sound, shutter sound, key operation sound and self-timer sound	p.124
Date Adjustment	For adjusting the date and time	p.125
World Time	For setting the Hometown city and Destination city	p.127
Language/言語	For setting the language in which menus and messages appear	p.129
Folder Name	For choosing the naming system for image folders	p.130
USB Connection	For setting the USB connection mode (MSC or PTP) when connected to a computer via the USB cable	p.137
Video Out	For setting the output format to AV equipment	p.131
Wallpaper	For changing the background of the menu screen	p.131
Brightness Level	For changing the brightness of the display	p.132
Power Saving	For setting the time until the camera enters the power-saving mode	p.133
Auto Power Off	For setting the time until the camera turns off automatically	p.133
Reset	For returning settings to their defaults	p.136
Delete All	For deleting all the saved images at once	p.99
Pixel Mapping	For mapping out and correcting any defective pixels in the CCD sensor	p.135
Playback Mode	For choosing whether pressing the  button will turn on the camera	p.136
Format	For formatting an SD Memory Card/built-in memory	p.123

- [↶ Setting] Menu 1

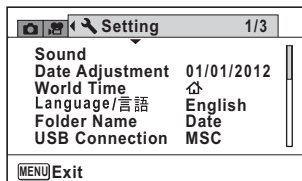

- [↶ Setting] Menu 2

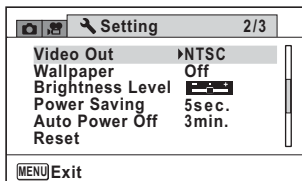

- [↶ Setting] Menu 3

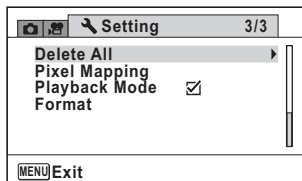

# Taking Still Pictures

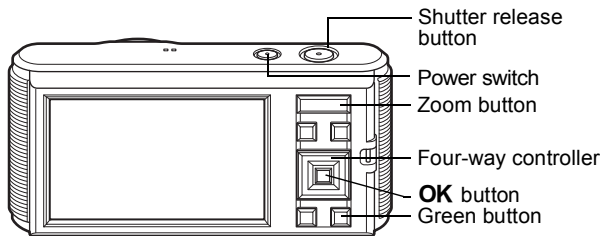

## Taking Pictures

This camera features a wide range of shooting modes and functions to suit almost any subject or scene. This chapter describes how to take pictures with the most commonly used standard settings (the factory default settings).

### 1 Press the power switch.

The camera turns on in “still picture capture mode”.

### 2 Check the subject and shooting information on the display.

The focus frame in the middle of the display indicates the zone of automatic focusing.



Focus frame

When the camera detects a person's face, the Face Detection function is activated and the face detection frame appears (p.59).

You can change the captured area by pressing the zoom button (p.63).

- Right (**T**) Enlarges the subject.
- Left (**W**) Widens the area that is captured by the camera.



Face detection frame

### 3 Press the shutter release button halfway.

The focus frame (or face detection frame) on the display turns green when the camera focuses on the subject at the correct distance.



### 4 Press the shutter release button fully.

The picture is taken.

The flash discharges automatically depending on the light conditions. The captured image appears on the display (Instant Review: p.57) and is saved to the SD Memory Card or the built-in memory.



Press the Green button to switch to the  (Green) mode and let the camera set all the shooting functions automatically (p.61).

## Using the Shutter Release Button

The shutter release button works in a two-step action as follows.

### Press halfway

This refers to pressing the shutter release button gently to the first position. This locks the focus setting and the exposure. The green focus frame is displayed on the monitor when the shutter release button is pressed halfway and the subject is in focus. If the subject is out of focus, the white focus frame appears.

3

### Press fully

This refers to pressing the shutter release button all the way down to the fully depressed position. This takes a picture.

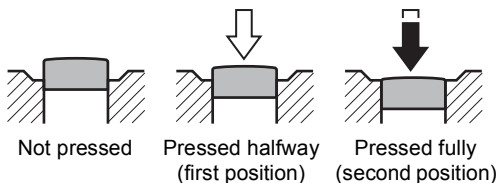

### Poor focusing conditions

The camera may not be able to focus under the following conditions. In these cases, lock the focus on an object the same distance away as the subject (by pressing and holding the shutter release button halfway), then aim the camera at your subject and press the shutter release button fully.

- Objects that lack contrast such as a blue sky or white wall
- Dark places or objects, or conditions that prevent light from being reflected back
- Intricate patterns
- Fast moving objects
- When there is an object in the foreground and an object in the background in the captured area
- Strongly reflected light or strong backlighting (bright background)

## Instant Review

Immediately after capturing an image, it appears on the screen display (Instant Review).

## Setting the Shooting Mode

This camera has a variety of shooting modes that let you take pictures in different situations simply by choosing the appropriate mode for the particular situation from the Capture Mode Palette.

**1 Press the four-way controller (▼) in  mode.**

The Capture Mode Palette appears.

**2 Use the four-way controller (▲▼◀▶) to choose a shooting mode.**



















When an icon is selected in the Capture Mode Palette, the guide for the selected shooting mode appears.







**3 Press the OK button.**

The shooting mode is fixed and the camera returns to capture status.











There are 23 shooting modes which can be selected from the Capture Mode Palette.

Shooting Mode	Description
 Auto Picture	Automatically selects the best capture mode. (☞p.60)
 Program	Used for basic shooting. Various functions can also be set with this mode. (☞p.61)
 Blue Sky	Emphasizes saturation of the sky to produce a bright image.
 Landscape	For capturing landscape views. Enhances colors of sky and foliage.
 Flower	For images of flowers. The outline of the flower is softened.
 Sunset	For images of sunsets and warm lighting.
 Night Scene	For night time images. Use of a tripod or other support is suggested.
 Night Scene Portrait	For images of people at night. Use of a tripod or other support is advised. When the flash mode is set to $\frac{1}{A}$ (Auto) and the camera detects a person's face, the flash mode automatically changes to $\frac{1}{A}$ (Flash On + Red-eye).
 Portrait	For capturing portraits. Reproduces a healthy and bright skin tone.
 Natural Skin Tone	For images of people. Enhances skin tones while smoothing blemishes.
 Food	For images of food and prepared dishes. Enhances saturation and contrast.
 Digital SR	Higher sensitivity reduces blur. The sensitivity is automatically set to [Auto] and the number of recorded pixels is fixed at [5M] for the 4:3 aspect ratio and [4M] for the 16:9 aspect ratio.
 Kids	For capturing moving kids. Reproduces a healthy and bright skin tone.
 Pet	For capturing moving pets. Select the color according to the pet's coat. (☞p.65)
 Sport	For a fast moving subject. Tracks the subject until the picture is taken.
 Surf & Snow	For bright images such as sand or snow. Accurately meters for bright scenes.
 Fireworks	For capturing fireworks. Use of a tripod or other support is suggested. The shutter speed is fixed at 4 seconds and the sensitivity is fixed at the minimum value.
 Frame Composite	For capturing images with a frame. (☞p.66)

Shooting Mode	Description
 Party	For capturing images at parties or in dim light. Increases ISO and clarity.
 Candlelight	For capturing scenes in candlelight.
 Text	Captures text in an easy to read manner. Text contrast can be adjusted. (p.67)
 Miniature Filter	For capturing an image with the subject looks like miniature objects. (p.68)
<b>HDR</b> HDR Filter	For capturing an image with HDR-like effect. (p.68)

\* In addition to the modes listed above,  (Green) mode (p.61) is also available.



- In shooting modes other than , , , ,  and **HDR**, saturation, contrast, sharpness, white balance, etc. are set to the optimal settings for the selected mode.
- In ,  or  mode, the camera tracks the subject and continues to focus on it. When [Focusing Area] (p.74) is set to  (Multiple) or  (Spot), focus can be locked by pressing the shutter release button halfway.
- Some functions may not be available or may not work fully depending on the selected shooting mode. For details, refer to “Functions Available for Each Shooting Mode” (p.148).

## Using the Face Detection Function

With this camera, the Face Detection function is available with all shooting modes.

When the camera detects a person's face in the image, the Face Detection function displays a yellow face detection frame around the face on the screen display, sets the focus (Face Detection AF) and compensates the exposure (Face Detection AE).

If the subject in the face detection frame moves, the frame also moves and changes its own size as it tracks the face.



Face detection frame

The Face Detection function can detect up to 16 people's faces. If it detects multiple faces, the camera displays a yellow frame over the main face and white frame(s) over the other face(s). The default setting is [On]. You can switch to the Smile Capture function that automatically releases the shutter when the subject smiles. Refer to "Switching the Face Detection Function" (p.79) for details.

When the multiple faces are detected

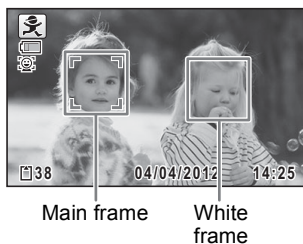

Main frame

White frame

## Taking Pictures Automatically (Auto Picture Mode)















**1 Use the four-way controller (▲▼◀▶) to select  (Auto Picture) from the Capture Mode Palette.**

**2 Press the OK button.**

The  mode is selected and the camera returns to capture status. When the camera detects a person's face, the Face Detection function is activated and the face detection frame appears (p.59).

**3 Press the shutter release button halfway.**

The selected shooting mode is displayed on the top left of the screen.

 Standard	 Night Scene	 Landscape
 Portrait	 Night Scene Portrait	 Flower
 Candlelight	 Blue Sky	 Portrait×Blue Sky
 Portrait×Backlight	 Sunset	 Portrait×Sunset
 Group Photograph	 Text	

The focus frame on the display turns green when the camera focuses on the subject at the correct distance.

**4 Press the shutter release button fully.**

The picture is taken.



The following restrictions apply in **AUTO PICT** mode:

- [Face Detection] cannot be set to [Off].
- The focusing area setting is fixed at [ ] (Multiple).
- The (Flower) mode cannot be selected when using digital zoom or Intelligent Zoom.
- If the (Night Scene Portrait) mode is selected when the flash mode is set to (Auto), the flash mode automatically changes to (Flash On + Red-eye) when the camera detects a face and determines that the flash is needed.

## Taking Pictures in the Custom Settings (Program Mode)

- 1 Use the four-way controller (▲▼◀▶) to select [P] (Program) from the Capture Mode Palette.**
- 2 Press the OK button.**

The [P] mode is selected and the camera returns to capture status. When the camera detects a person's face, the Face Detection function is activated and the face detection frame appears (p.59).
- 3 Change the settings as needed.**

Refer to "Setting the Shooting Functions" (p.70 - p.83) for details on how to set the functions.
- 4 Press the shutter release button halfway.**

The focus frame on the display turns green when the camera focuses on the subject at the correct distance.
- 5 Press the shutter release button fully.**

The picture is taken.



## Taking Pictures in Basic Mode (Green Mode)

In (Green) mode, you can enjoy easy picture-taking using standard settings, regardless of the settings in the [📷 Rec. Mode] menu. The mode settings are as shown below.

Flash Mode	$\frac{1}{2}$ A (Auto)
Drive Mode	<input type="checkbox"/> (Standard)
Focus Mode	<b>AF</b> (Standard)
Information Display	Normal
Recorded Pixels	16M
White Balance	<b>AWB</b> (Auto)
Focusing Area	<input type="checkbox"/> <input type="checkbox"/> (Multiple)
Sensitivity	Auto

EV Compensation	$\pm 0.0$
Face Detection	On
Digital Zoom	<input checked="" type="checkbox"/> (On)
Sharpness	<input type="checkbox"/> <input type="checkbox"/> <input type="checkbox"/> <input type="checkbox"/> <input type="checkbox"/> (Normal)
Saturation	<input type="checkbox"/> <input type="checkbox"/> <input type="checkbox"/> <input type="checkbox"/> <input type="checkbox"/> (Normal)
Contrast	<input type="checkbox"/> <input type="checkbox"/> <input type="checkbox"/> <input type="checkbox"/> <input type="checkbox"/> (Normal)
Date Imprint	Off

## 1 Press the Green button in mode.

The camera switches to  mode. Press the Green button again to return to the status before  mode was selected.

When the camera detects a person's face, the Face Detection function is activated and the face detection frame appears (p.59).













## 2 Press the shutter release button halfway.

The focus frame on the display turns green when the camera focuses on the subject at the correct distance.

## 3 Press the shutter release button fully.

The picture is taken.



- The  mode is available only when it is assigned to the Green button in [Green Button] of the [ Rec. Mode] menu (p.83). By default, the  mode is assigned to the Green button.
- In  mode, you cannot change the information on the display by pressing the **OK** button.
- If you press the **MENU** button in  mode, the [ Setting] menu appears. The [ Rec. Mode] and [ Movie] menus cannot be displayed.
- When the camera is turned off in  mode, it turns on in  mode next time the power switch is pressed.

## Using the Zoom

You can use the zoom to change the captured area.

### 1 Press the zoom button in mode.

- Right (**T**) Tele Enlarges the subject.
- Left (**W**) Wide Widens the area that is captured by the camera.

When you continue to press the button towards the right (**T**), the camera automatically switches from optical zoom to Intelligent Zoom and stops at the point where the zoom switches to digital zoom.

Once the button is released and pressed again, the camera switches to digital zoom.

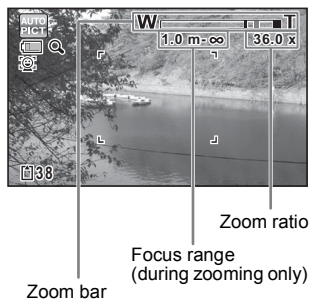

The zoom bar is displayed as follows.

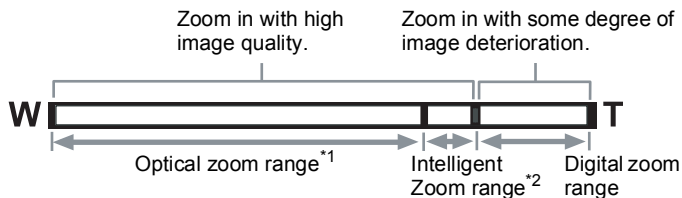

\*1 You can zoom in to a maximum of 5× optically.

\*2 The Intelligent Zoom range differs depending on the number of recorded pixels. See the following table.

## Recorded pixels and the maximum zoom ratio

Recorded Pixels	Intelligent Zoom	Digital zoom
16M	Not available (5× optical zoom only)	Equivalent to approx. 36.0×
12M 16M / 12M 16S	Not available (5× optical zoom only)	
7M	Approx. 7.5×	
2M 16S	Approx. 12.0×	
640	Approx. 36.0× (Same as digital zoom)	

3



- It is recommended to use a tripod or other support to prevent camera shake when taking pictures at high zoom.
- Pictures taken in the digital zoom range appear grainier than pictures taken in the optical zoom range.
- Intelligent Zoom is not available under the following conditions:
  - When the number of recorded pixels is set to 16M/12M 16M / 12M 16S (5× optical zoom is available)
  - In (👤) (Digital SR) mode
  - When the sensitivity is set to 3200 or 6400
- The image enlarged using Intelligent Zoom may appear rough on the display. This does not affect the quality of the recorded image.
- Only digital zoom is available while recording a movie.
- The focus range is not displayed when the focus mode is set to PF/▲ or the shooting mode is set to 🌈 (Fireworks), or while recording a movie.

### To Set the Digital Zoom

The Digital Zoom is set to  (On) in the default setting. To take pictures using only optical zoom and Intelligent Zoom, set the Digital Zoom to  (Off).

#### 1 Press the **MENU** button in **📷** mode.

The [📷 Rec. Mode] menu appears.

#### 2 Use the four-way controller (▲ ▼) to select [Digital Zoom].

### 3 Use the four-way controller (◀▶) to select or .

- Uses Digital Zoom
- Uses only optical zoom and Intelligent Zoom

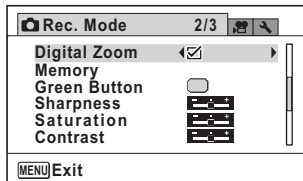

### 4 Press the MENU button.

The camera returns to capture status.

Saving the Digital Zoom Function setting p.87

## Taking Pictures of Your Pet (Pet Mode)

Use the  (Pet) mode to keep your moving pet in focus and capture the color of your pet's coat when you take a picture. Choose the appropriate icon depending on what color your pet is (closer to black or white or in between).

### 1 Use the four-way controller (▲▼◀▶) to select (Pet) from the Capture Mode Palette.

### 2 Press the OK button.

The  mode selection screen appears.

### 3 Use the four-way controller (▲▼) to select , , , , , or .

There are two types of icons: a dog and cat icon. Your choice of dog or cat icon does not affect the resulting picture, so you can choose whichever you prefer. Choose an icon (white, gray, or black) whose tone best matches your pet's coat or fur.



**4 Press the OK button.**

The selected icon appears and the camera returns to capture status. The camera tracks the subject and continues to focus on it. When the camera detects a person's face, the Face Detection function is activated and the face detection frame appears (p.59).

**5 Press the shutter release button fully.**

The picture is taken.

**Framing Your Pictures (Frame Composite Mode)**

In  (Frame Composite) mode, you can take pictures using the frames stored in the camera.

**1 Use the four-way controller (▲▼◀▶) to select  (Frame Composite) from the Capture Mode Palette.****2 Press the OK button.**

The 12-frame display of the frame selection screen appears.

**3 Use the four-way controller (▲▼◀▶) to choose the frame you want to use.****4 Press the zoom button towards the right (T).**

The selected frame appears in single-image display.

You can choose another frame using either of the following operations.

Four-way controller (◀▶)	Press to choose a different frame.
Zoom button towards the left (W)	Returns to the 12-frame display of the frame selection screen, and then lets you choose a different frame in the same way as Step 3.

**5 Press the OK button.**

The framed image appears on the display.

When the camera detects a person's face, the Face Detection function is activated and the face detection frame appears (p.59).

**6 Press the shutter release button halfway.**

The focus frame on the display turns green when the camera focuses on the subject at the correct distance.

**7 Press the shutter release button fully.**

The picture is taken.



- The number of recorded pixels is fixed at **3M** for the 4:3 aspect ratio and **2M** for the 16:9 aspect ratio.
- Frames cannot be added to movies.
- By default, three frames are built-in to the camera. These frames are not deleted even if the built-in memory is formatted.
- The CD-ROM supplied with the camera contains optional frames. To save the frames into the built-in memory, copy the files from the CD-ROM (p.115).

Adding a Frame to a captured image p.113

## Taking Pictures of Text (Text Mode)

The (Text) mode allows you to take clear pictures of written text. This is convenient for capturing a digital copy of an important document or enhancing the legibility of small print.

Color	Maintains the original color of the text.
Neg. Color	Reverses the color of the text.
B & W	Turns the color of the text into black and white.
Neg. B & W	Turns the color of the text into reversed black and white.

### 1 Use the four-way controller (▲▼◀▶) to select (Text) from the Capture Mode Palette.

**2 Press the OK button.**

The  mode selection screen appears.

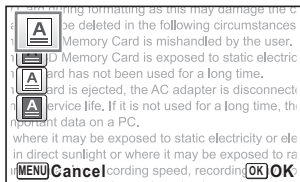
**3 Use the four-way controller (▲▼) to select , ,  or .****4 Press the OK button.**

The selected icon appears and the camera returns to capture status. If the camera detects a person's face when  (Color) is selected, the Face Detection function is activated and the face detection frame appears (p.59).

**5 Press the shutter release button halfway.**

The focus frame on the display turns green when the camera focuses on the subject at the correct distance.

**6 Press the shutter release button fully.**

The picture is taken.

## Taking Pictures Using the Miniature/HDR Filter

In  (Miniature)/HDR (HDR) Filter mode, you can take impressive pictures using the filter.

 Miniature Filter	For capturing an image with the subject looks like miniature objects. The number of recorded pixels is fixed at <b>5M</b> for the 4:3 aspect ratio and <b>4M</b> for the 16:9 aspect ratio.
<b>HDR</b> HDR Filter	For capturing an image with HDR-like effect.



**1 Use the four-way controller (▲▼◀▶) to select  (Miniature) or HDR (HDR) from the Capture Mode Palette.**

## 2 Press the OK button.

When the  mode is selected, the screen for selecting the area to be blurred is displayed.

When the **HDR** mode is selected, proceed to Step 5.

## 3 Use the four-way controller (◀▶) to select an option.

	Focuses on the bottom of the image and blurs the top.
	Focuses on the center of the image and blurs the top and bottom.
	Focuses on the top of the image and blurs the bottom.

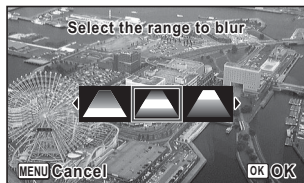

## 4 Press the OK button.

The  or **HDR** mode is selected and the camera returns to capture status.

When the camera detects a person's face, the Face Detection function is activated and the face detection frame appears (p.59).

## 5 Press the shutter release button halfway.

The focus frame on the display turns green when the camera focuses on the subject at the correct distance.

## 6 Press the shutter release button fully.

The picture is taken.

Processing the captured images by using the Miniature/HDR filter  p.108

# Setting the Shooting Functions

## Selecting the Flash Mode

Auto	The flash discharges automatically depending on the light conditions. If the Face Detection function is activated, the flash mode is automatically set to .
Flash Off	The flash does not discharge, regardless of the brightness. Use this mode to take pictures where flash photography is prohibited.
Flash On	The flash discharges regardless of the brightness.
Flash On + Red-eye	This mode reduces the phenomenon of red eyes caused by the light from the flash being reflected in the subject's eyes. The flash discharges regardless of the light conditions. A pre-flash discharges before the main flash.



- The flash mode is fixed at in the following situations:
  - When (Fireworks) is selected as the shooting mode
  - When recording a movie
  - When (Continuous Shooting) or (Burst Shooting) is selected as the drive mode
  - When (Infinity) is selected as the focus mode
- In (Green) mode, you can only select or .
- In (Night Scene) mode, you cannot select .



Using the flash when capturing images at a close distance may cause the light distribution to be uneven.

### 1 Press the four-way controller (◀) in mode.

The [Flash Mode] screen appears. The flash mode changes each time the button is pressed. You can also change the setting using the four-way controller (▲▼).



### 2 Press the OK button.







The setting is saved and the camera returns to capture status.

## About the red-eye phenomenon

Taking pictures using the flash may cause the subject's eyes to appear red in the resulting picture. This phenomenon occurs when the light from the flash is reflected in the subject's eyes. It can be reduced by illuminating the area around the subject or moving closer to the subject and zooming out to a wider angle. Setting the flash mode to  is also an effective way of reducing red eyes. If the subject's eyes appear red despite such precautions, they can be corrected by the red-eye compensation function (p.112).



Saving the Flash Mode setting  p.87





## Selecting the Drive Mode

 Self-timer	Use this mode when you want to be included in a group picture. The picture is taken approximately ten seconds after the shutter release button is pressed.
 2 sec. Self-timer	Use this mode to avoid camera shake. The picture is taken approximately two seconds after the shutter release button is pressed.
 Continuous Shooting	Each time an image is taken, it is saved in the memory before the next image is taken. The higher the image quality, the longer the interval between shots. You can continue shooting until the capacity of the SD Memory Card or the built-in memory is full.
 Burst Shooting	The number of recorded pixels is fixed at  for the 4:3 aspect ratio and  for the 16:9 aspect ratio.

### 1 Press the four-way controller () in mode.

The [Drive Mode] screen appears.

The drive mode changes each time the button is pressed. You can also change the mode using the four-way controller ( ) .

To select , press the four-way controller () after choosing , and then use the four-way controller ( ) .

### 2 Press the OK button.

The setting is saved and the camera returns to capture status.









- Focusing may be compromised if you move the camera while the self-timer lamp is blinking when taking still pictures.
- The flash does not discharge in or mode.
- In the following modes, you cannot select or .
  - (Green), (Fireworks), (Frame Composite), (Miniature Filter), or **HDR** (HDR Filter) mode or when recording a movie.
- Digital zoom and Intelligent Zoom are not available in mode.



3

- For movies using the self-timer, recording will start ten seconds or two seconds after the Movie button is pressed.
- Press the shutter release button halfway while the self-timer is running to stop the countdown and press fully to restart the countdown.
- cannot be selected while the ● (Green) mode settings remain as the default. However, it can be selected if you select in another shooting mode first, and then switch the shooting mode to ●.
- In or mode, the number of pictures that can be taken consecutively and the frame rate per second vary depending on the shooting condition.
- In or mode, the focus, exposure and white balance are locked with the first shot.
- When [Face Detection] is set to [On] (p.59) in or mode, the function works only for the first shot.
- When or is selected as the drive mode in (Auto Picture) mode, pictures are taken consecutively in shooting mode selected for the first shot.

## Selecting the Focus Mode

<b>AF</b> Standard	This mode is used when the distance to the subject is 40 cm (16 in.) or more. The camera is focused on the subject in the autofocus area when the shutter release button is pressed halfway. When the subject is close to the camera, the Auto-Macro function is activated and  appears on the display.
 Macro	This mode is used when the distance to the subject is approx. 10 cm to 50 cm (4 in. to 20 in.). The camera is focused on the subject in the autofocus area when the shutter release button is pressed halfway.
 Super Macro	This mode is used when the distance to the subject is approx. 5 cm to 20 cm (2 in. to 8 in.). The camera is focused on the subject in the autofocus area when the shutter release button is pressed halfway.
<b>PF</b> Pan Focus	This mode is used when you ask someone to take pictures for you, or when taking pictures of the scenery through the window of a car or train. The entire picture, from the front to the back, is focused.
 Infinity	This mode is used for taking distant objects. The flash is set to  (Flash Off).

### 1 Press the four-way controller (▶) in mode.



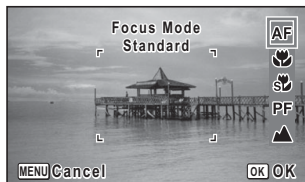

The [Focus Mode] screen appears. The focus mode changes each time the button is pressed. You can also change the setting using the four-way controller (▲▼).



### 2 Press the OK button.

The setting is saved and the camera returns to capture status.



- In  (Green) mode, you can only select **AF**,  or **PF**.
- The focus mode is fixed at  in  (Fireworks) mode.
- When shooting with  selected, if the subject is further than 50 cm away, the camera automatically focuses to  $\infty$  (Infinity). By pressing the shutter release button fully, you can also take a picture even when the focus is not set.

Saving the Focus Mode setting  p.87

## Setting the [📷 Rec. Mode] Menu

To set the main shooting functions, choose each function on the [📷 Rec. Mode] menu. Refer to the explanation of the respective functions for how to change the settings.

- 1 Press the MENU button in 📷 mode.**  
The [📷 Rec. Mode] menu appears.
- 2 Use the four-way controller (▲▼) to select an item and change its setting.**
- 3 Press the MENU button after changing the setting.**  
The 📷 mode screen reappears. The setting is saved and the camera returns to capture status.

## To Set the Focusing Area

You can change the autofocus area (Focusing Area).

[ ] Multiple	Normal autofocus area
[ ] Spot	The autofocus area becomes smaller.
👁️ Automatic Tracking AF	Keeps moving subjects in focus.

- 1 Use the four-way controller (▲▼) to select [Focusing Area] in the [📷 Rec. Mode] menu.**
- 2 Press the four-way controller (▶).**  
A pull-down menu appears.
- 3 Use the four-way controller (▲▼) to change the focusing area setting.**
- 4 Press the OK button.**  
The setting is saved.



In ● (Green), (Auto Picture) and (Fireworks) modes, the focusing area is fixed at [ ] [ ].

## Selecting the Number of Recorded Pixels

You can choose from six recorded pixels settings for still pictures. The larger the number of recorded pixels, the clearer the details will appear when you print your picture. As the quality of the printed picture also depends on the image quality, exposure control, resolution of the printer, and other factors, you do not need to select more than the required number of recorded pixels. The more pixels there are, the larger the picture and the bigger the file size.

Refer to the following table for the appropriate settings according to expected usage.

Recorded Pixels	Expected Usage
<b>16M</b> 4608×3456	↑ Clearer For printing high quality photos or A4-size or larger prints, or editing images on a computer.
<b>12M</b> 3456×3456	
<b>12M</b> 4608×2592	For making postcard-size prints.
<b>7M</b> 3072×2304	For posting on a website or attaching to e-mail.
<b>2M</b> 1920×1080	
<b>640</b> 640×480	

The default setting is **12M**.



If you select **16M**, **7M** or **640**, the aspect ratio of the image is 4:3 and the monitor display for recording and playback is as shown on the right.



- 1 Use the four-way controller (▲ ▼) to select [Recorded Pixels] in the [Rec. Mode] menu.**
- 2 Press the four-way controller (▶).**  
A pull-down menu appears.
- 3 Use the four-way controller (▲ ▼) to change the number of recorded pixels.**

## 4 Press the OK button.

The setting is saved.



- The number of recorded pixels in (Green) mode is fixed at **16M**.
- The number of recorded pixels in (Frame Composite) mode is fixed at **3M** for the 4:3 aspect ratio and **2M 16:9** for the 16:9 aspect ratio.
- The number of recorded pixels in (Miniature Filter), (Digital SR), or (Burst Shooting) mode is fixed at **5M** for the 4:3 aspect ratio and **4M 16:9** for the 16:9 aspect ratio.

3

## Compensating for Exposure (EV Compensation)

You can adjust the overall brightness of the picture.

Use this function to take pictures that are intentionally overexposed or underexposed.

### 1 Use the four-way controller (▲▼) to select [EV Compensation] in the [Rec. Mode] menu.

### 2 Use the four-way controller (◀▶) to select the EV value.

To brighten, select a positive (+) value. To darken, select a negative (-) value.

You can choose the EV setting in the range of -2.0 EV to +2.0 EV in 1/3 EV steps.







- When the histogram is displayed in still picture capture mode/playback mode, you can check the exposure (p.24).
- The EV compensation function cannot be used in (Green) or (Auto Picture) mode.
- If you change the [EV Compensation] setting frequently, you can save time by assigning it to the Green button (p.83).

Saving the EV Compensation value setting p.87

## Adjusting the White Balance

You can take pictures in natural colors by adjusting the white balance according to the light conditions at the time of shooting.

<b>AWB</b> Auto	The camera adjusts the white balance automatically.
 Daylight	Use this mode when taking pictures outside in sunlight.
 Shade	Use this mode when taking pictures outside in the shade.
 Tungsten Light	Use this mode when taking pictures under electric or other tungsten light.
 Fluores. Light	Use this mode when taking pictures under fluorescent light.
 Manual	Use this mode when adjusting the white balance manually.



- Set another white balance setting if you are not satisfied with the color balance of pictures taken with the [White Balance] set to **AWB**.
- Depending on the selected shooting mode, the white balance setting may not be changed. Refer to "Functions Available for Each Shooting Mode" (p.148) for details.

**1 Use the four-way controller (▲▼) to select [White Balance] in the [Rec. Mode] menu.**

**2 Press the four-way controller (▶).**  
The [White Balance] screen appears.

**3 Use the four-way controller (▲▼) to change the setting.**  
You can check the result of selected white balance setting on the preview image each time you press the four-way controller (▲▼).

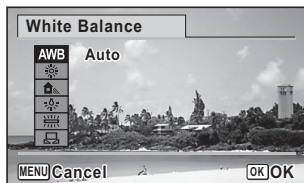

**4 Press the OK button.**  
The setting is saved.





If you change the [White Balance] setting frequently, you can save time by assigning it to the Green button (p.83).

Saving the White Balance setting  p.87

## To Set the White Balance Manually

Have a blank sheet of white paper or similar material ready.

- 1 In the [White Balance] screen, use the four-way controller (▲▼) to select  (Manual).**
- 2 Point the camera at the blank sheet of paper or other material so that it fills the frame displayed in the center of the screen.**
- 3 Press the shutter release button fully.**  
The white balance is automatically adjusted.
- 4 Press the OK button.**  
The setting is saved and the [ Rec. Mode] menu reappears.

## Setting the Sensitivity

You can select the sensitivity to suit the brightness of the surroundings.

Auto	The sensitivity is automatically adjusted by the camera. (Sensitivity 64 - 800)
64	 <p>The lower the sensitivity, the less noise that affects the image. The shutter speed will be slower in low light conditions.</p> <p>Higher sensitivity settings use faster shutter speeds in low light conditions to reduce camera shake, but the image may be affected by noise.</p>
100	
200	
400	
800	
1600	
3200	
6400	

- 1 Use the four-way controller (▲▼) to select [Sensitivity] in the [ Rec. Mode] menu.**
- 2 Press the four-way controller (▶).**  
A pull-down menu appears.
- 3 Use the four-way controller (▲▼) to change the sensitivity.**

## 4 Press the OK button.

The setting is saved.



- When the sensitivity is set to 3200 or 6400, the number of recorded pixels is fixed at **5M** for the 4:3 aspect ratio and **4M** for the 16:9 aspect ratio.
- In **(Green)** mode, only [Auto] (sensitivity 64 - 800) is available.
- In **(Digital SR)** mode, only [Auto] (sensitivity 64 - 6400) is available.
- When recording a movie, only [Auto] (sensitivity 512 - 4800) is available.
- In **(Fireworks)** mode, the sensitivity is fixed at the minimum value.
- When **(Burst Shooting)** is selected as the drive mode, only [Auto] (sensitivity 256 - 1600) is available.
- If you change the [Sensitivity] setting frequently, you can save time by assigning it to the Green button (p.83).

Saving the Sensitivity setting **p.87**

## Switching the Face Detection Function

The Face Detection function locates faces in the frame and automatically adjusts the focus and exposure for those faces. You can change the setting of the function so that the camera will automatically release the shutter when one or more of the subjects smile. The default setting is [On] for [Face Detection].

**1 Use the four-way controller (▲▼) to select [Face Detection] in the [Rec. Mode] menu.**

**2 Press the four-way controller (▶).**

A pull-down menu appears.



**3 Use the four-way controller (▲▼) to select an option.**

On	The camera detects a person's face.
Smile	The camera automatically release the shutter when your subject smiles.
Off	The camera does not detect a person's face.











## 4 Press the OK button.

The setting is saved.

The Face Detection icon appears on the display.

	When [Face Detection] is set to [On]
	When [Face Detection] is set to [Smile]





- Face Detection AF and AE may not work if the subject is wearing sunglasses, has part of their face covered or is not looking toward the camera.
- If the camera cannot detect the subject's face, the camera focuses using the setting currently selected in [Focusing Area].
- When [Face Detection] is set to [Smile], the shutter may not be released automatically because the Smile Capture function may not work in some situations, such as when the detected face is too small. If this happens, press the shutter release button to release the shutter.
- [Face Detection] cannot be set to [Off] in  (Auto Picture),  (Portrait),  (Night Scene Portrait),  (Natural Skin Tone) or  (Kids) mode.
- [Face Detection] is automatically set to [On] in  (Green),  (Auto Picture),  (Portrait),  (Night Scene Portrait),  (Natural Skin Tone) or  (Kids) mode. When switching to another mode from one of these modes, the Face Detection setting returns to the previous setting.
- For movies, the Face Detection function is activated before recording starts. The face detection frame is not displayed while recording a movie.

## Setting the Image Sharpness (Sharpness)

You can give the image sharp or soft outlines.



1 Use the four-way controller (▲▼) to select [Sharpness] in the [ Rec. Mode] menu.

2 Use the four-way controller (◀▶) to change the sharpness level.

-  Soft
-  Normal
-  Sharp



## Setting the Color Saturation (Saturation)

You can set the color saturation.

- 1 Use the four-way controller (▲▼) to select [Saturation] in the [📷 Rec. Mode] menu.
- 2 Use the four-way controller (◀▶) to change the saturation level.
  -  Low
  -  Normal
  -  High

## Setting the Image Contrast (Contrast)

You can set the image contrast level.

- 1 Use the four-way controller (▲▼) to select [Contrast] in the [📷 Rec. Mode] menu.
- 2 Use the four-way controller (◀▶) to change the contrast level.
  -  Low
  -  Normal
  -  High

## Setting the Date Imprint Function

You can choose whether to imprint the date and/or time when taking still pictures.

- 1 Use the four-way controller (▲▼) to select [Date Imprint] in the [📷 Rec. Mode] menu.
- 2 Press the four-way controller (▶).

A pull-down menu appears.

### 3 Use the four-way controller (▲▼) to select the Date Imprint details.

Choose from [Date], [Date & Time], [Time] or [Off].

### 4 Press the OK button.

The setting is saved.



- The date and/or time imprinted cannot be deleted.
- Note that if the printer or the image editing software is set to print the date and the images to be printed already have the date and/or time imprinted, the imprinted dates and/or times may overlap.



- **DATE** appears on the display in mode when [Date Imprint] is set.
- The date and/or time are imprinted on the picture in the format set in the [Date Adjustment] screen (p.40).

## Calling Up a Specific Function

You can assign a function to the Green button and recall it quickly by simply pressing the Green button. This is useful to save time to get to the frequently used function.

The following functions can be assigned to the Green button:

- (Green) Mode
- Sensitivity
- White Balance
- EV Compensation



- The Green button setting can be returned to its default value by selecting [Reset] on the [ Setting] menu.
- The functions other than the (Green) mode can be set in the usual manner on the [ Rec. Mode] menu.
- Although you can approach a function by assigning it to the Green button or selecting it from the [ Rec. Mode] menu, you cannot save different settings for each case.

## To Assign a Function to the Green Button

- 1 Use the four-way controller (▲▼) to select [Green Button] in the [📷 Rec. Mode] menu.
- 2 Press the four-way controller (▶).  
A pull-down menu appears.
- 3 Use the four-way controller (▲▼) to select a function you want to assign, and press the OK button.
- 4 Press the MENU button.  
The selected function is assigned to the Green button.

## To Use the Green Button

- 1 Press the Green button in 📷 mode.  
The function assigned to the Green button is called up.
- 2 Use the four-way controller (◀▶) to change the setting and press the OK button.  
The camera returns to capture status.

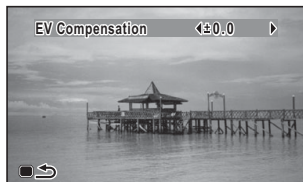

Taking Pictures in Basic Mode (Green Mode) ESPp.61



When a function other than the 🟢 (Green) mode is assigned to the Green button, the camera returns to the original screen if no operation is performed for one minute after the Green button is pressed.

# Recording Movies

## Recording a Movie

This mode enables you to record movies. Sound is recorded at the same time.

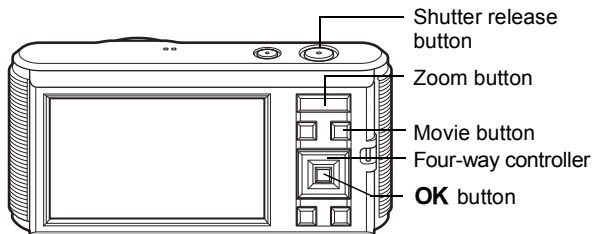

3

Taking Pictures

### 1 Point the camera at your subject in mode.

When the camera detects a person's face, the Face Detection function is activated and the face detection frame appears (p.59). (The frame disappears when recording starts.)

### 2 Press the Movie button.

The camera automatically focuses on the subject and compensates the exposure. Recording starts.

You can continue recording until the built-in memory or the SD Memory Card is full, or the size of the recorded movie reaches 2 GB.

The following information appears on the display.

- 1 Movie mode
- 2 Movie SR setting
- 3 Remaining recordable time
- 4 Recording (blinks)

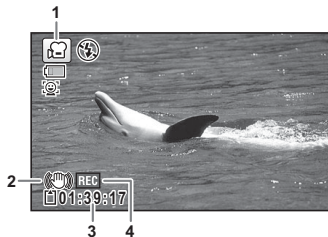

You can change the captured area by pressing the zoom button.

- Right (T) Enlarges the subject.
- Left (W) Widens the area that is captured by the camera.

### 3 Press the **Movie** button.

Recording stops.

Playing Back a Movie  p.90



- The flash does not discharge while recording a movie.
- The autofocus system does not operate while recording a movie.
- You can use optical zoom only before recording, while digital zoom is available both before and during recording.
- Recording does not start while a menu screen is being displayed or in playback mode even if the Movie button is pressed.

#### Keeping the Movie Button Pressed

If you keep the Movie button pressed for more than one second, recording will continue as long as you keep the button pressed. Shooting stops when you take your finger off the Movie button.

#### Setting the [ Movie] Menu

##### 1 Press the **MENU** button in mode.

The [ Rec. Mode] menu appears.

##### 2 Press the four-way controller () or zoom button towards the right (T).

The [ Movie] menu appears.



##### 3 Use the four-way controller ( ) to select an item and change its setting.

##### 4 Press the **MENU** button after changing the setting.

The  mode screen reappears. The setting is saved and the camera returns to capture status.

## Selecting the Recorded Pixels for Movies

You can choose from the following recorded pixels settings for movies. The more pixels there are, the clearer the details and the bigger the file size.

Setting	Recorded Pixels	Frame Rate	Use
	1280×720	30 fps	Records images in HDTV format (16:9). Movement is recorded smoothly. (default setting)
	640×480	30 fps	Suitable for viewing on a TV or computer screen. Movement is recorded smoothly.

\* The frame rate (fps) indicates the number of frames per second.

- 1 Use the four-way controller (▲▼) to select [Recorded Pixels] in the [ Movie] menu.**
- 2 Press the four-way controller (▶).**  
A pull-down menu appears.
- 3 Use the four-way controller (▲▼) to select the number of recorded pixels.**
- 4 Press the OK button.**  
The setting is saved.

## Setting the Movie SR (Movie Shake Reduction) Function

You can correct camera shake while you are recording a movie with the Movie SR (Movie Shake Reduction) function.

- 1 Use the four-way controller (▲▼) to select [Movie SR] in the [ Movie] menu.**
- 2 Use the four-way controller (◀▶) to select  or .**
  - Corrects camera shake.
  - Does not correct camera shake.

# Saving the Settings (Memory)

The Memory function is for saving the current camera settings when the camera is turned off.

For some camera settings, the Memory function is always set to  (On) (the settings are saved when the camera is turned off), while for others you can choose  or  (Off) (to choose whether the settings are saved or not when the camera is turned off). The items which can be set to  or  in the Memory function are shown in the table below. (For items which are not listed here, the selected settings are always saved when the camera is turned off.)

If you select , the settings will be saved in the status they are in immediately before the camera is turned off. If you select , the settings will be reset to the defaults when the camera is turned off. The table below also shows whether the Memory default setting for each item is  or .

Item	Description	Default Setting	Page
Flash Mode	The flash mode set with the four-way controller (◀)	<input checked="" type="checkbox"/>	p.70
Drive Mode	The drive mode set with the four-way controller (▲)	<input type="checkbox"/>	p.71
Focus Mode	The focus mode set with the four-way controller (▶)	<input type="checkbox"/>	p.73
Zoom Position	The zoom position set with the zoom button	<input type="checkbox"/>	p.63
White Balance	The [White Balance] setting on the [📷 Rec. Mode] menu	<input type="checkbox"/>	p.77
Sensitivity	The [Sensitivity] setting on the [📷 Rec. Mode] menu	<input type="checkbox"/>	p.78
EV Compensation	The [EV Compensation] setting on the [📷 Rec. Mode] menu	<input type="checkbox"/>	p.76
Digital Zoom	The [Digital Zoom] setting on the [📷 Rec. Mode] menu	<input checked="" type="checkbox"/>	p.64
Face Detection	The [Face Detection] setting on the [📷 Rec. Mode] menu	<input type="checkbox"/>	p.59
DISPLAY	The information display mode set with the <b>OK</b> button	<input type="checkbox"/>	p.20
File No.	If a new SD Memory Card is inserted when set to <input checked="" type="checkbox"/> (On), file numbers are assigned sequentially	<input checked="" type="checkbox"/>	—

- 1** Use the four-way controller (▲ ▼) to select [Memory] in the [📷 Rec. Mode] menu.
- 2** Press the four-way controller (▶).  
The [Memory] screen appears.
- 3** Use the four-way controller (▲ ▼) to choose an item.
- 4** Use the four-way controller (◀ ▶) to select  or .

# Playing Back Images

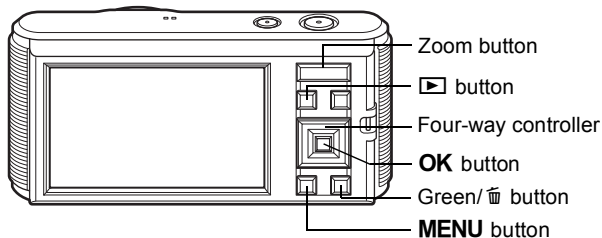

## Playing Back Still Pictures

- 1 Press the ▶ button after taking a picture.**

The camera enters the ▶ mode and the captured image appears on the display (single-image display).

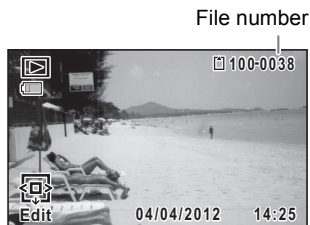

- 2 Press the four-way controller (◀▶).**

The previous or next image appears.

### To Delete the Displayed Image

Press the 🗑 button while the image is displayed to display the Delete screen. Press the four-way controller (▲) to select [Delete] and press the OK button.

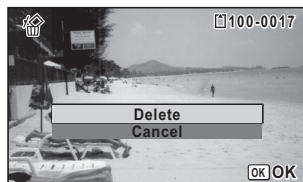

For information on other deletion procedures see p.98

## Playing Back a Movie

You can play back the movies you have taken. Recorded sound is played back at the same time.

- 1 In  mode, use the four-way controller (◀▶) to choose the movie you want to play back.
- 2 Press the four-way controller (▲).  
Playback starts.



### Available operations during playback

Zoom button towards the right (Q)	Increases the volume.
Zoom button towards the left (W)	Reduces the volume.
Four-way controller (▲)	Pauses playback.
Four-way controller (▶)	Fast-forwards playback while the button is held down.
Four-way controller (◀)	Plays back in reverse. Fast-reverses playback while the button is held down.

### Available operations while playback is paused

Four-way controller (▲)	Resumes playback.
Four-way controller (▶)	Forwards the frame.
Four-way controller (◀)	Reverses the frame.

- 3 Press the four-way controller (▼).  
Playback stops.

# Multi-Image Display











## Six-Image Display/Twelve-Image Display

You can display six or twelve thumbnails of images at a time.

**1** In  mode, press the zoom button towards the left ().

The six-image display appears showing with six thumbnails. Press the zoom button towards the left () again to switch to twelve-image display.

Six or twelve images appear page by page.

Use the four-way controller (   ) to move the frame. If there are too many images to display on one page, pressing the four-way controller ( ) while the image  is selected will display the previous page. Similarly, if you choose the image  and press the four-way controller ( ) , the next page appears.



Six-Image Display

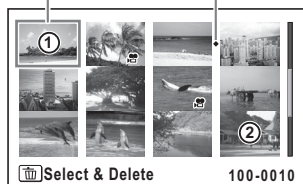

Breakpoint of folders

Frame





Twelve-Image Display

The icons that appear on the images indicate the following:

	Still picture
	Movie (the first frame appears)

Press the **OK** button to switch to single-image display of the selected image.

Press the  button to switch to  mode.

## Folder Display/Calendar Display

In twelve-image display, press the zoom button towards the left (⊞) to switch to folder display or calendar display. Press the Green button to switch between folder display and calendar display.

### 1 In mode, press the zoom button towards the left (⊞) three times.

The screen changes to folder display or calendar display.

#### Folder display

The folder list with recorded images appears on the screen display.

Four-way controller (▲▼◀▶)	Moves the frame.
Zoom button towards the right (Q)/OK button	Displays the images in the selected folder in twelve-image display.
<b>MENU</b> button	Returns to twelve-image display.

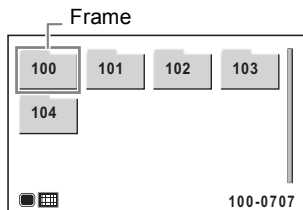

#### Calendar display

Images are displayed by date in calendar format.

A thumbnail of the first image recorded on each date is displayed on the calendar.

Four-way controller (▲▼◀▶)	Moves the frame.
Zoom button towards the right (Q)	Displays the images recorded on the selected date in twelve-image display.
<b>OK</b> button	Displays the first image recorded on the selected date in single-image display.
<b>MENU</b> button	Returns to twelve-image display.

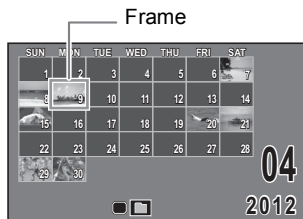

## Using the Playback Functions

### 1 Press the four-way controller (▼) in mode.

The Playback Mode Palette appears.

### 2 Use the four-way controller (▲▼◀▶) to choose a playback mode.



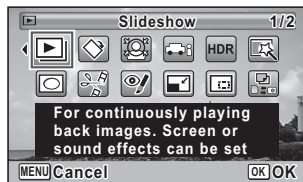





The guide for the selected function appears below.









### 3 Press the OK button.

The selected playback function is called up.



## Playback Mode Palette

Playback Mode	Description	Page
 Slideshow	For continuously playing back images. Screen or sound effects can be set.	p.94
 Image Rotation	Rotates captured images. Useful when viewing vertical images on a TV.	p.96
 Small Face Filter	Reduces the size of faces in the image, for well-proportioned portraits.	p.107
 Miniature Filter	Processes the subjects in the images to look like miniature objects.	p.108
<b>HDR</b> HDR Filter	Processes image into HDR-like image.	p.108
 Digital Filter	For modifying images with a Color filter or Soft filter.	p.110
 Frame Composite	For composing an image with a frame. Select Overwrite or Save as to save.	p.113
 Movie Editing	Save as Still Image	p.116
	Divide Movies	
 Red-eye Compensation	For compensating red-eye. May not work due to the condition of the image.	p.112

 Resize	Changes Recorded Pixels to make the file size smaller.	p.105
 Cropping	For cropping images to the size you like. Saved as a new image.	p.106
 Image Copy	To copy images between the built-in memory and an SD Memory Card.	p.118
 Protect	Protects images from delete function. Format function still erases all.	p.100
 DPOF	For the print settings. Useful when printing at a printing service.	p.120
 Start-up Screen	For setting a captured image as the Start-up Screen.	p.134

## Slideshow

You can play back recorded images one after another.

- 1 In  mode, use the four-way controller (◀▶) to choose the image to start the slideshow with.**
- 2 Use the four-way controller (▲▼◀▶) to select  (Slideshow) from the Playback Mode Palette.**
- 3 Press the OK button.**  
The slideshow setting screen appears.
- 4 Use the four-way controller (▲▼) to select [Start].**

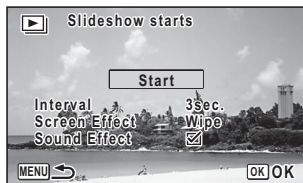

- 5 Press the OK button.**  
The slideshow starts.  
Pressing the **OK** button during the slideshow pauses the slideshow. To resume the slideshow, press the **OK** button again.
- 6 Press any button other than the OK button.**  
The slideshow stops.

## To Set the Slideshow Conditions

You can set the playback interval and also a screen effect and sound effect for when one image changes to the next.

**1 Use the four-way controller (▲▼) to select [Interval] in Step 4 on p.94.**

**2 Press the four-way controller (▶).**

A pull-down menu appears.

**3 Use the four-way controller (▲▼) to select the interval and press the OK button.**

Choose from [3sec.], [5sec.], [10sec.], [20sec.] or [30sec.].

**4 Use the four-way controller (▲▼) to select [Screen Effect].**

**5 Press the four-way controller (▶).**

A pull-down menu appears.

**6 Use the four-way controller (▲▼) to choose the screen effect and press the OK button.**

Wipe	The next image slides over the previous one from left to right
Checker	The next image appears in small square mosaic blocks
Fade	The current image gradually fades out and the next image fades in
Random	Various effects are used randomly
Off	No effect

**7 Use the four-way controller (▲▼) to select [Sound Effect].**

**8 Use the four-way controller (◀▶) to select  or .**

Except when the [Screen Effect] is set to [Off], you can choose  (On) or  (Off) for the sound that is played when one image changes to the next.

**9 Use the four-way controller (▲▼) to select [Start] and press the OK button.**

The slideshow starts using the selected interval and effect.



- The slideshow will continue until you press any button other than the **OK** button.
- Movies will be played through to the end before the next picture is played back, regardless of the interval setting. However, pressing the four-way controller (▶) while playing back a movie skips to the next image.
- When [Random] is selected for the screen effect, the interval is fixed and the sound effect is set to off.

Connecting the Camera to AV Equipment p.103

## Rotating an Image

4

### 1 Press the button after taking a picture.

The image appears on the display.

### 2 Use the four-way controller (▲▼◀▶) to select (Image Rotation) from the Playback Mode Palette.

### 3 Press the **OK** button.

The rotation selection screen (0°, Right 90°, Left 90°, or 180°) appears.

### 4 Use the four-way controller (▲▼◀▶) to choose the rotation direction and press the **OK** button.

The rotated image is saved.

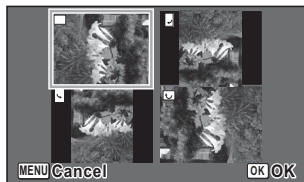

- Movies cannot be rotated.
- Protected images can be rotated, but they cannot be saved in a rotated state.

## Zoom Playback

You can magnify an image up to ten times.

**1** In  mode, use the four-way controller (◀▶) to choose the image you want to magnify.

**2** Press the zoom button towards the right (Q).

The image is magnified ( $\times 1.1$  to  $\times 10$ ). Continuing to press the zoom button towards the right (Q) changes the magnification continuously.

You can use the guide mark “+” that appears at the bottom left of the screen to check which portion of the image is magnified.

**Available operations while an image is magnified**

Four-way controller (▲▼◀▶)	Moves the position to be magnified.
Zoom button towards the right (Q)	Makes the image bigger (max. $\times 10$ ).
Zoom button towards the left (Q)	Makes the image smaller (min. $\times 1.1$ ).



Guide

**3** Press the OK button.

The image returns to single-image display.



Movies cannot be magnified.

# Deleting Images

You can delete images that you do not want to keep.

## Deleting a Single Image

You can delete a single image.



Protected images cannot be deleted (p.100).

**1** In mode, use the four-way controller (◀▶) to choose the image you want to delete.

**2** Press the button.  
A confirmation dialog appears.

**3** Use the four-way controller (▲▼) to select [Delete].

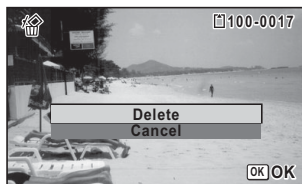

**4** Press the **OK** button.  
The image is deleted.

## Deleting Selected Images

You can delete several images selected from the six-/twelve-image display at once.







Protected images cannot be deleted (p.100).

**1** In mode, press the zoom button towards the left () once or twice.

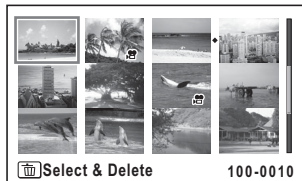
Six-image display or twelve-image display appears.

- 2 Press the  button.**  
 appears on the images.



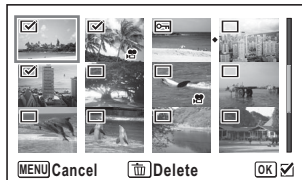

- 3 Use the four-way controller (   ) to choose the images that you want to delete, then press the OK button.**



appears on the selected images.

If you select an image and press the zoom button towards the right () , the selected image appears in single-image display as long as the button is pressed, enabling you to check whether you really want to delete it or not. (The display returns to six-/twelve-image display when you release the button.) However, protected images cannot be displayed in single-image display.

- 4 Press the  button.**  
 A confirmation dialog appears.
- 5 Use the four-way controller ( ) to select [Select & Delete].**
- 6 Press the OK button.**  
 The selected images are deleted.

## Deleting All Images

You can delete all the images at once.





Protected images cannot be deleted (p.100).

- 1 Press the MENU button in  mode.**  
 The [ Setting] menu appears.

- 2 Use the four-way controller (▲▼) to select [Delete All].
- 3 Press the four-way controller (▶).  
The [Delete All] screen appears.
- 4 Use the four-way controller (▲▼) to select [Delete All].
- 5 Press the OK button.  
All the images are deleted.

## Protecting Images from Deletion (Protect)

You can protect stored images from being accidentally deleted.

- 1 In  mode, use the four-way controller (◀▶) to choose the image you want to protect.
- 2 Use the four-way controller (▲▼◀▶) to select  (Protect) from the Playback Mode Palette.
- 3 Press the OK button.  
The screen for selecting [Single Image] or [All Images] appears.
- 4 Use the four-way controller (▲▼) to select [Single Image].  

- 5 Press the OK button.  
The message [Protects this image] appears.  
To protect another image, use the four-way controller (◀▶) to select the image.

- 6 Use the four-way controller (▲▼) to select [Protect].



- 7 Press the OK button.

The selected image is protected and the screen shown in Step 4 reappears.

To protect other images, repeat Steps 4 to 7.

Select [Cancel] to exit the Protect setting.



- To cancel the protection of the image, select [Unprotect] in Step 6.
-  appears on the protected images during playback.

## To Protect All Images

- 1 Select [All Images] in Step 4 on p.100.



- 2 Press the OK button.

- 3 Use the four-way controller (▲▼) to select [Protect].

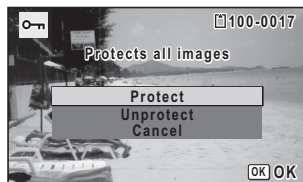

#### 4 Press the OK button.

All the images are protected and the screen shown in Step 1 reappears.

#### 5 Use the four-way controller (▲▼) to select [Cancel] and press the OK button.

The Playback Mode Palette reappears.



Protected images will be deleted when the SD Memory Card/built-in memory is formatted (p.123).



To cancel the protection of all your images, select [Unprotect] in Step 3.

# Connecting the Camera to AV Equipment

By using the optional AV cable (I-AVC116), you can capture and play back images on equipment with a video input terminal, such as a TV.

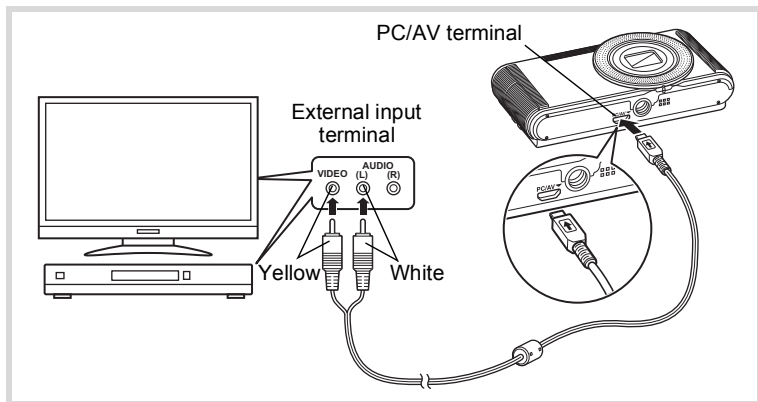

- 1 Turn the AV equipment and camera off.**
- 2 Face the ➔ mark on the AV cable towards the ◀ mark on the camera, and connect the cable to the PC/AV terminal.**
- 3 Connect the other ends of the AV cable to the video input terminal and audio input terminal of the AV equipment.**

When using stereo sound equipment, insert the sound terminal into the L (white) terminal.

- 4 Turn the AV equipment on.**

When the equipment that the camera is connected to and the equipment that plays back images are different, turn both on.

When viewing images on AV equipment with multiple video input terminals (such as a TV), refer to the operation manual of the equipment and select the video input terminal to which the camera is connected.

## 5 Turn the camera on.



- Depending on the country or region, images and sounds may fail to be played back if the video output format is set differently from the one in use there. If this happens, change the video output format setting (p.131).
- The camera display turns off and the volume cannot be adjusted by pressing the zoom button while the camera is connected to AV equipment.



When connecting to and playing back images on AV equipment, image data is output at normal screen resolution. To view movies recorded at  $\overline{1280}$  in HDTV, transfer the data to a computer and play it back on the computer (p.137).

## Changing the Image Size (Resize)

By changing the recorded pixels of a selected image, you can make the file size smaller than the original. You can use this function to continue taking pictures when the SD Memory Card or the built-in memory is full, by making the images smaller and overwriting the original images to make more space available.



- Images taken with the recorded pixels of 12M [181] / 2M [189] / 640 and movies cannot be resized.
- You cannot select a larger resolution than that of the original image.

- 1** In mode, use the four-way controller (◀▶) to choose the image you want to resize.
- 2** Use the four-way controller (▲▼◀▶) to select (Resize) from the Playback Mode Palette.
- 3** Press the OK button.  
The screen for choosing the number of recorded pixels appears.
- 4** Use the four-way controller (◀▶) to select the number of recorded pixels.  

- 5** Press the OK button.  
A confirmation dialog for overwriting the image appears. If the selected image is protected, the processed image is saved as a new image and the following confirmation dialog does not appear.
- 6** Use the four-way controller (▲▼) to select [Overwrite] or [Save as].

## 7 Press the OK button.

The resized image is saved.

## Cropping Images

You can delete the unwanted part of a picture and save the cropped image as a new image.



Images taken with the recorded pixels of 12M 191 / 2M 163 / 640 and movies cannot be cropped.

## 1 In mode, use the four-way controller (◀▶) to choose the image you want to crop.

## 2 Use the four-way controller (▲▼◀▶) to select (Cropping) from the Playback Mode Palette.

## 3 Press the OK button.

The cropping screen appears.

The largest size of cropped image is shown with a green frame on the screen. The cropped image cannot be larger than this cropping frame size.

## 4 Choose the cropping area.

Change the size and/or position of the cropping frame by the following operations.

Zoom button	Changes the size of the cropping frame.
Four-way controller (▲▼◀▶)	Moves the cropping frame up, down, left and right.
Green button	Rotates the cropping frame. <ul style="list-style-type: none"><li>• The button is displayed only when the cropping frame can be rotated.</li></ul>



## 5 Press the OK button.

The cropped image is saved with a new file name.

The number of recorded pixels is selected automatically according to the size of the cropped image.

## Processing Images to Make a Face Look Smaller

Images are processed to reduce the size of a person's face detected with the Face Detection function (p.59) when taking pictures so that the face looks smaller.



### 1 In mode, use the four-way controller (◀▶) to choose the image you want to edit.

### 2 Use the four-way controller (▲▼◀▶) to select (Small Face Filter) from the Playback Mode Palette.

### 3 Press the OK button.

After a face detection frame for a face that can be corrected is displayed, the correction screen appears.

### 4 Use the four-way controller (◀▶) to change the reduction ratio.

-  Approx. 5 %
-  Approx. 7 %
-  Approx. 10 %



### 5 Press the OK button.

A confirmation dialog for overwriting the image appears.

If the selected image is protected, the processed image is saved as a new image and the following confirmation dialog does not appear.

### 6 Use the four-way controller (▲▼) to select [Overwrite] or [Save as].

### 7 Press the OK button.

The camera returns to  mode and the processed image is displayed.



You may not be able to process images in the following situations:

- When the size of face taken in relation to an image is too large or too small
- When a face is not in the center of an image

## Processing Images with the Miniature/HDR Filter



This function lets you perform special processing on the selected image.

 Miniature Filter	Processes the subjects in the images to look like miniature objects. The processed image will be saved with the recorded pixels of <b>5M</b> for the 4:3 aspect ratio, and <b>4M.1920</b> for the 16:9 aspect ratio. Images of size <b>5M</b> or smaller with the 4:3 aspect ratio, and <b>4M.1920</b> or smaller with the 16:9 aspect ratio, cannot be processed.
<b>HDR</b> HDR Filter	Processes image into HDR-like image.

5





Movies and images taken with another camera cannot be processed using the Miniature/HDR Filter function.

- 1** In  mode, use the four-way controller (◀▶) to choose the image you want to edit.
- 2** Use the four-way controller (▲▼◀▶) to select  (Miniature) or HDR (HDR) from the Playback Mode Palette.
- 3** Press the OK button.

When the  mode is selected, the screen for selecting the area to be blurred is displayed.

When the **HDR** mode is selected, proceed to Step 6.

#### 4 Use the four-way controller (◀▶) to select an option.

	Processes the image so that the top of the image is blurred as if only the bottom of the image is in focus.
	Processes the image so that the top and bottom of the image is blurred as if only the center of the image is in focus.
	Processes the image so that the bottom of the image is blurred as if only the top of the image is in focus.



#### 5 Press the OK button.

A confirmation dialog for overwriting the image appears.

If the selected image is protected, the processed image is saved as a new image and the following confirmation dialog does not appear.

#### 6 Use the four-way controller (▲▼) to select [Overwrite] or [Save as].

#### 7 Press the OK button.

The camera returns to  mode and the processed image is displayed.

## Processing Images with the Digital Filters

This function lets you change the color tones and perform special processing on the selected image.

B&W	Processes the image into one that has the look of a black and white photograph.
Sepia	Processes the image into one that has the look of a sepia photograph.
Toy Camera	Processes the image that looks as though it was shot with a toy camera.
Retro	Processes the image into one that has the look of an old photo.
Color	Processes the image using the selected color filter. You can choose from six filters: red, pink, purple, blue, green, and yellow.
Extract Color	Extracts only a specific color and processes the rest of the image into black and white. You can choose from three filters: red, green, and blue.
Color Emphasis	There are four filters: Sky Blue/Fresh Green/Delicate Pink/Autumn Leaves.
Soft	Processes the image into one that appears soft overall.
Brightness	Adjusts the brightness of the image.

5



Movies and images taken with another camera cannot be processed using the Digital Filter function.

- 1** In mode, use the four-way controller (◀▶) to choose the image you want to edit.
- 2** Use the four-way controller (▲▼◀▶) to select (Digital Filter) from the Playback Mode Palette.
- 3** Press the OK button.

The filter selection screen appears.

- 1 B&W
- 2 Sepia
- 3 Toy Camera
- 4 Retro
- 5 Color
- 6 Extract Color
- 7 Color Emphasis
- 8 Soft
- 9 Brightness

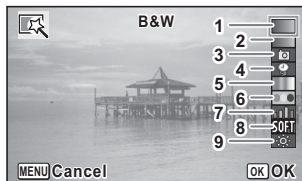

Subsequent steps vary depending on your selection.

## To Select a B&W, Sepia or Soft Filter

- 4 Use the four-way controller (▲▼) to choose a filter.**

The preview image of the result of the filter effect appears.
- 5 Press the OK button.**

A confirmation dialog for overwriting the image appears.  
If the selected image is protected, the processed image is saved as a new image and the following confirmation dialog does not appear.
- 6 Use the four-way controller (▲▼) to select [Overwrite] or [Save as].**
- 7 Press the OK button.**

The image processed with the filter is saved.

## To Select a Retro, Color, Extract Color or Color Emphasis Filter

- 4 Use the four-way controller (▲▼) to choose a filter.**

The preview image of the result of the filter effect appears.
- 5 Use the four-way controller (◀▶) to choose the color.**

The color filter changes in the following sequence each time the four-way controller (▶) is pressed.

Retro	Original image → Amber → Blue
Color	Red → Pink → Purple → Blue → Green → Yellow
Extract Color	Red → Green → Blue
Color Emphasis	Sky Blue → Fresh Green → Delicate Pink → Autumn Leaves
- 6 Press the OK button.**

A confirmation dialog for overwriting the image appears.  
If the selected image is protected, the processed image is saved as a new image and the following confirmation dialog does not appear.
- 7 Use the four-way controller (▲▼) to select [Overwrite] or [Save as].**
- 8 Press the OK button.**

The image processed with the filter is saved.

## To Select a Toy Camera or Brightness Filter

### 4 Use the four-way controller (▲▼) to choose a filter.

The preview image of the result of the filter effect appears.

### 5 Use the four-way controller (◀▶) to adjust the effect.

	Four-way controller (◀)	Default Setting	Four-way controller (▶)
Toy Camera	Weak	Standard	Strong
Brightness	Dark	Standard	Bright

### 6 Press the OK button.

A confirmation dialog for overwriting the image appears.

If the selected image is protected, the processed image is saved as a new image and the following confirmation dialog does not appear.

### 7 Use the four-way controller (▲▼) to select [Overwrite] or [Save as].

### 8 Press the OK button.

The image processed with the filter is saved.

## Compensating for an Unwanted Red-eye Effect

You can correct images where the flash has caused the subject to appear with red eyes.



The red-eye compensation function can only be used with still pictures taken with this camera. The red-eye compensation function cannot be used on movies and on images where red eyes cannot be detected on the camera.

### 1 In mode, use the four-way controller (◀▶) to choose the image you want to correct.

### 2 Use the four-way controller (▲▼◀▶) to select (Red-eye Compensation) from the Playback Mode Palette.

---

### 3 Press the OK button.

A confirmation dialog for overwriting the image appears. If the selected image is protected, the processed image is saved as a new image and the following confirmation dialog does not appear.

---

### 4 Use the four-way controller (▲▼) to select [Overwrite] or [Save as].

---

### 5 Press the OK button.

The processed image is saved.

## Adding a Frame (Frame Composite)

This function lets you add a decorative frame to still pictures. There are three frames already stored in the camera.



The Frame Composite function cannot be used on images taken with the recorded pixels of 12M 191 / 2M 169, images of size 3M or smaller with the 4:3 aspect ratio, images of size 2M 169 or smaller with the 16:9 aspect ratio, and movies.

---

### 1 In mode, use the four-way controller (◀▶) to choose the image to which you want to add a frame.

---

### 2 Use the four-way controller (▲▼◀▶) to select (Frame Composite) from the Playback Mode Palette.

---

### 3 Press the OK button.

The 12-frame display of the frame selection screen appears.

---

### 4 Use the four-way controller (▲▼◀▶) to choose a frame.



## 5 Press the zoom button towards the right (Q).

The selected frame appears in single-image display. You can choose another frame using either of the following operations.

Four-way controller (◀▶)	Press to choose a different frame.
Zoom button towards the left (Q)	Returns to the 12-frame display of the frame selection screen, and then lets you choose a different frame in the same way as Step 4.



## 6 Press the OK button.

The image position and size adjustment screen appears. You can adjust the image using the following operations.

Four-way controller (▲▼◀▶)	Press to adjust the position of the image
Zoom button	Makes the image larger or smaller.



## 7 Press the OK button.

A confirmation dialog for overwriting the image appears. If the selected image is protected, the processed image is saved as a new image and the following confirmation dialog does not appear.

## 8 Use the four-way controller (▲▼) to select [Overwrite] or [Save as].

## 9 Press the OK button.

The processed image will be saved with the recorded pixels of **3M** for the 4:3 aspect ratio, and **2M** for the 16:9 aspect ratio.

## Optional Frames

In addition to the built-in frames that come with this camera, there are optional frames included on the supplied CD-ROM. You can save the optional frames to the camera's built-in memory or an SD Memory Card. To save them to the built-in memory, first remove the SD Memory Card before proceeding.

### To Copy Frames

**1 Connect the camera to a computer using the provided USB cable.**

Refer to "Connecting to a Computer" (p.137) for instructions on connecting the camera to a computer.

**2 When the device detection window opens, click [Cancel].**

**3 Insert the CD-ROM into the CD/DVD drive.**

**4 When the installer window opens, click [EXIT].**

**5 Copy the desired files from the FRAME folder in the root directory of the CD-ROM to the FRAME folder on the camera (removable disk).**

For information on working with files on a computer, refer to the instruction manual supplied with the computer.

**6 Disconnect the USB cable from the computer and camera.**

Refer to "Connecting to a Computer" (p.137) for instructions on disconnecting the cable.

- Frames can be stored both in the built-in memory and on an SD Memory Card, but using large numbers of frames may slow down processing speed.

## To Use a New Frame

Frames downloaded from the PENTAX website or other source can be used for adding a frame to pictures.





- Extract the downloaded frame and copy it to the FRAME folder in the built-in memory or on the SD Memory Card.
- The FRAME folder is created when the SD Memory Card is formatted with this camera.
- For more information on downloading, refer to the PENTAX website.
- Up to a total of 90 frames including the three default frames can be stored, but using large numbers of frames may slow down processing speed.

## Editing Movies

You can extract a frame from the recorded movie to save as a still picture or divide a movie into two or more segments.

5

- 1** In  mode, use the four-way controller (◀▶) to choose the movie you want to edit.
- 2** Use the four-way controller (▲▼◀▶) to select  (Movie Editing) from the Playback Mode Palette.
- 3** Press the OK button.

The movie editing selection screen appears.  
Subsequent steps vary depending on your selection.



## To Save a Frame from a Movie as a Still Picture

- 4** Select [Save as Still Image] on the movie editing selection screen.
- 5** Press the OK button.

The screen appears for selecting a frame to be saved as a still picture.

**6 Use the four-way controller (▲▼◀▶) to choose the frame you want to save.**

- ▲ Plays or pauses the movie
- ▼ Stops the movie and returns to the first frame
- ◀ Reverses the movie frame by frame
- ▶ Forwards the movie frame by frame



**7 Press the OK button.**

The selected frame is saved as a still picture.

**To Divide a Movie**

**4 Select [Divide Movies] on the movie editing selection screen.**

**5 Press the OK button.**

The screen for choosing the dividing position appears.

**6 Use the four-way controller (▲▼◀▶) to determine the dividing position.**

- ▲ Plays or pauses the movie
- ▼ Stops the movie and returns to the first frame
- ◀ Reverses the movie frame by frame
- ▶ Forwards the movie frame by frame



**7 Press the OK button.**

A confirmation dialog appears.

- 8 Use the four-way controller (▲▼) to select [Divide].**

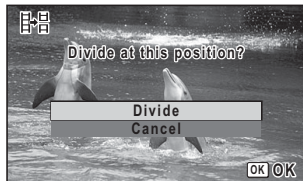

- 9 Press the OK button.**

The movie is divided at the specified position, each segment is saved as a new file, and the original movie is deleted.



Protected movies cannot be divided.

5

## Copying Images

You can copy images from the built-in memory to the SD Memory Card and vice versa. This function can be selected only when an SD Memory Card has been inserted in the camera.



Make sure that the camera is turned off before inserting or removing the SD Memory Card.

- 1 Use the four-way controller (▲▼◀▶) to select  (Image Copy) from the Playback Mode Palette.**

- 2 Press the OK button.**

The copying method selection screen appears. Subsequent steps vary depending on your selection.

### To Copy Files from the Built-in Memory to the SD Memory Card

All the images in the built-in memory are copied to the SD Memory Card at once. Before copying the images, make sure that there is enough space on the SD Memory Card.

- 3 Use the four-way controller (▲▼) to select [●→SD].**



- 4 Press the OK button.**

All the images are copied to the SD Memory Card.

### To Copy Files from the SD Memory Card to the Built-in Memory

Selected images from the SD Memory Card are copied to the built-in memory one by one.

- 3 Use the four-way controller (▲▼) to select [SD→●].**

- 4 Press the OK button.**

- 5 Use the four-way controller (◀▶) to select the image you want to copy.**



- 6 Press the OK button.**

The selected image is copied to the built-in memory.

To copy other images, repeat Steps 3 to 6. Select [Cancel] to exit the copy operation.



When a file is copied from the SD Memory Card to the built-in memory, it is assigned a new file name.

# Setting the Printing Service (DPOF)

DPOF (Digital Print Order Format) is the format for storing print order data on still pictures captured with a digital camera. Once the print order data has been stored, the pictures can be printed according to the DPOF settings by using a DPOF-compatible printer or at a photo processing lab.

## About printing

The following options are available for printing images taken with this camera.

- 1 Use a printing service.
- 2 Use your printer with an SD Memory Card slot to print directly from the SD Memory Card.
- 3 Use your computer's software to print images.

5



- The DPOF settings can be applied only to still pictures. Movies cannot be processed with the DPOF settings.
- If the picture already has the date and/or time imprinted on it (p.81), do not set [Date] to  (On) in DPOF setting. If you select  , the imprinted date and/or time may overlap.

## Printing a Single Image

Set the following items for each image.

Copies	Choose the number of copies up to 99.
Date	Specify whether to imprint the date on the pictures.

**1 Use the four-way controller (▲▼◀▶) to select  (DPOF) from the Playback Mode Palette.**

**2 Press the OK button.**

The DPOF setting method selection screen appears.

- 3 Use the four-way controller (▲▼) to select [Single Image].**



- 4 Press the OK button.**

The message [Applies DPOF settings to this image] appears.

- 5 Use the four-way controller (◀▶) to select an image.**

If DPOF settings have already been made for the selected image, the previous number of copies and date setting (☑ or ☐) will be displayed.

- 6 Use the four-way controller (▲▼) to choose the number of copies.**

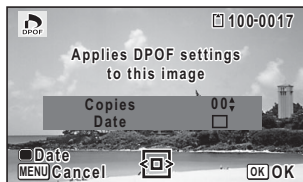

- 7 Press the Green button to switch ☑ or ☐ for [Date] setting.**

- The date will be imprinted.
- The date will not be imprinted.



To continue setting the DPOF print order data, repeat Steps 5 to 7.

- 8 Press the OK button.**

The settings are saved and the screen shown in Step 3 reappears.



Depending on the printer or printing equipment at the photo processing lab, the date may not be imprinted on the pictures even if ☑ (On) is selected for [Date] in DPOF setting.



To cancel DPOF settings, set the number of copies to [00] in Step 6 and press the **OK** button.

## Printing All Images

DPOF settings are applied to all the images stored in the camera.

**1** Select **[All Images]** in Step 3 on p.121.

**2** Press the **OK** button.

The message [Applies DPOF settings to all images] appears.

**3** Choose the number of copies and switch  or  for **[Date]** setting.

Refer to Steps 6 and 7 in “Printing a Single Image” (p.121) for details on how to make the settings.

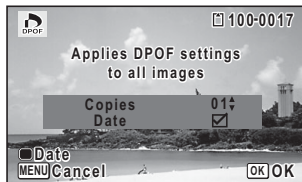

**4** Press the **OK** button.

The settings specified for all the images are saved and the DPOF setting method selection screen reappears.



- The number of copies specified in the [All Images] setting applies to all the images. Before printing, check that the number is correct.
- DPOF settings specified for single images are canceled when settings are made with [All Images].

## Changing the [Setting] Menu

To change the main camera settings, choose each setting on the [Setting] menu. Refer to the explanation of the respective functions for how to change the settings.

- 1 Press the MENU button in [Mode] mode.**  
The [Setting] menu appears.
- 2 Use the four-way controller (▲▼) to select an item and change its setting.**
- 3 Press the MENU button after changing the setting.**  
The setting is saved and the camera returns to [Mode] mode.

Switching Between [Mode] Mode and [Mode] Mode Ⓜp.46

## Formatting the Memory

Formatting deletes all the data on the SD Memory Card/built-in memory. Be sure to use this camera to format (initialize) an SD Memory Card that is unused or has been used on other cameras or digital devices.

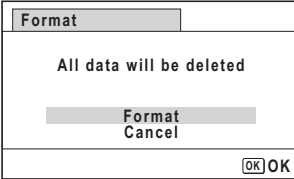

- Do not remove the SD Memory Card during formatting as this may damage the card and render it unusable.
- Formatting deletes all the data on the card, including protected images and images recorded with a computer or camera other than this camera.
- SD Memory Cards formatted on a computer or device other than this camera cannot be used. Be sure to format the card with this camera.
- When the SD Memory Card is inserted to the camera, the SD Memory Card will be formatted. To format the built-in memory, be sure to operate after taking out the SD Memory Card.
- The optional frames copied from the provided CD-ROM are deleted when the SD Memory Card or the built-in memory is formatted (3 default frames are not deleted).

- 1 Use the four-way controller (▲▼) to select [Format] in the [↖ Setting] menu.
- 2 Press the four-way controller (▶).  
The [Format] screen appears.
- 3 Use the four-way controller (▲▼) to select [Format].  

- 4 Press the OK button.  
Formatting starts.  
When formatting is completed, the camera returns to [▶] mode.

## Changing the Sound Settings

You can adjust the volume of operation sounds and change the type of sound.

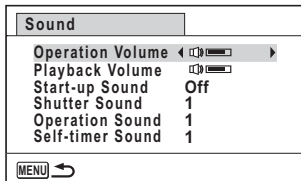
- 1 Use the four-way controller (▲▼) to select [Sound] in the [↖ Setting] menu.
- 2 Press the four-way controller (▶).  
The [Sound] screen appears.  
Subsequent steps vary depending on your selection.



### To Change the Operation Volume/Playback Volume

- 3 Use the four-way controller (▲▼) to select [Operation Volume].

- 4 Use the four-way controller (◀▶) to adjust the volume.**  
Set the volume to  to mute the start-up sound, shutter sound, operation sound, and self-timer sound.
- 5 Change [Playback Volume] in the same way as in Steps 3 and 4.**

### To Change the Sound Type

- 3 Use the four-way controller (▲▼) to select [Start-up Sound].**
- 4 Press the four-way controller (▶).**  
A pull-down menu appears.
- 5 Use the four-way controller (▲▼) to select the sound type.**  
Choose from [1], [2], [3] or [Off].
- 6 Press the OK button.**
- 7 Set [Shutter Sound], [Operation Sound] and [Self-timer Sound] in the same way as in Steps 3 to 6.**
- 8 Press the MENU button twice.**  
The camera returns to  mode.

### Changing the Date and Time

You can change the initial date and time settings (p.40). Also, you can change the format in which the date appears on the camera.

- 1 Use the four-way controller (▲▼) to select [Date Adjustment] in the [ Setting] menu.**
- 2 Press the four-way controller (▶).**  
The [Date Adjustment] screen appears.

### 3 Press the four-way controller (▶).

The frame moves to [mm/dd/yy]. Depending on the initial setting or previous setting, [dd/mm/yy] or [yy/mm/dd] may be displayed.

Date Adjustment	
Date Format ▶	mm/dd/yy 24h
Date	01/01/2012
Time	00:00
Settings complete	
[MENU] Cancel	

### 4 Use the four-way controller (▲ ▼) to choose the date format.

Choose from [mm/dd/yy], [dd/mm/yy] or [yy/mm/dd].

### 5 Press the four-way controller (▶).

The frame moves to [24h].

### 6 Use the four-way controller (▲ ▼) to select [24h] (24-hour display) or [12h] (12-hour display).

### 7 Press the four-way controller (▶).

The frame returns to [Date Format].

### 8 Press the four-way controller (▼).

The frame moves to [Date].

### 9 Press the four-way controller (▶).

The frame moves to one of the following items depending on the date format set in Step 4.

Month for [mm/dd/yy]

Day for [dd/mm/yy]

Year for [yy/mm/dd]

The following operations use [mm/dd/yy] as an example. The operations are the same even if another date format has been selected.

### 10 Use the four-way controller (▲ ▼) to change the month.

### 11 Press the four-way controller (▶).

The frame moves to the day field. Use the four-way controller (▲ ▼) to change the day. After changing the day, change the year in the same manner.

## 12 Change the time in the same way as in Steps 7 to 11.

If you select [12h] in Step 6, the camera automatically switches the display between am and pm corresponding to the time.

## 13 Press the four-way controller (▼) to select [Settings complete].

## 14 Press the OK button.

The date and time settings are saved.



When you press the **OK** button in Step 14, the camera clock is reset to 0 seconds. To set the exact time, press the **OK** button when the time signal (on the TV, radio, etc.) reaches 0 seconds.

## Setting the World Time

The date and time selected in “Setting the Date and Time” (p.40) and “Changing the Date and Time” (p.125) serve as the Hometown date and time. If you set the Destination city using the World Time function, you can display the Destination date and time when taking pictures in a different time zone.

### To Set the Destination

## 1 Use the four-way controller (▲▼) to select [World Time] in the [↶ Setting] menu.

## 2 Press the four-way controller (▶).

The [World Time] screen appears.

## 3 Use the four-way controller (▲▼) to select [→ Destination].

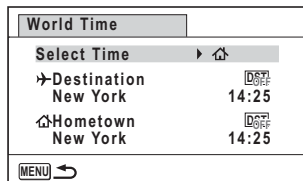

#### 4 Press the four-way controller (▶).

The [→ Destination] screen appears. The city that is currently selected blinks on the map.

#### 5 Use the four-way controller (◀▶) to change the Destination city.

The current time, location and time difference of the selected city appear.

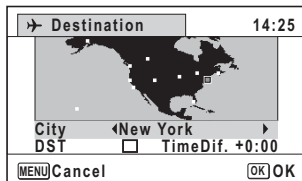

#### 6 Use the four-way controller (▲▼) to select [DST].

#### 7 Use the four-way controller (◀▶) to select (On) or (Off).

Select  if the Destination city uses daylight saving time.

#### 8 Press the OK button.

The settings are saved and the [World Time] screen reappears.

#### 9 Press the MENU button twice.

The camera returns to [▶] mode.



Select [🏠 Hometown] in Step 3 to set the city and DST setting for the Hometown city.

### To Display the Time of the Destination (Select Time)

#### 1 Use the four-way controller (▲▼) to select [World Time] in the [↶ Setting] menu.

#### 2 Press the four-way controller (▶).

The [World Time] screen appears.

- 3 Use the four-way controller (▲▼) to select [Select Time].**

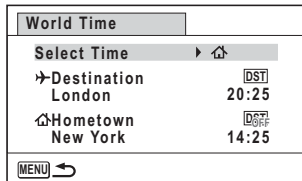

- 4 Press the four-way controller (▶).**

A pull-down menu appears.

- 5 Use the four-way controller (▲▼) to select ✈ or 🏠.**

- ✈ Displays the time of the Destination city
- 🏠 Displays the time of the Hometown city

- 6 Press the OK button.**

The setting is saved.

- 7 Press the MENU button twice.**

The camera returns to ▶ mode. When ✈ (Destination) is selected in Step 5, the ✈ icon appears on the display to indicate that the Destination date and time are displayed in 📷 mode.



## Changing the Display Language

You can change the language in which the menus, error messages, etc. are displayed.

- 1 Use the four-way controller (▲▼) to select [Language/言語] in the [⌂ Setting] menu.**

- 2 Press the four-way controller (▶).**

The [Language/言語] screen appears.

**3 Use the four-way controller (▲▼◀▶) to select the desired language.**

**4 Press the OK button.**

The menus and messages are displayed in the selected language.

## Changing the Naming System of the Folder

You can change the naming system of the folder for storing images. When the naming system is set to [Date], pictures are saved in separate folders by the date they were taken.

PENTX	xxxPENTX (where xxx is the 3-digit folder number)
Date	xxx_mmdd (3-digit folder number_month day) *xxx_ddmm (3-digit folder number_day month) when the [Date Format] is set to [dd/mm/yy]

Taken with the folder name setting [PENTX].  
(e.g. September 25)

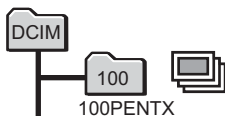

Taken with the folder name setting [Date].  
(e.g. September 25)

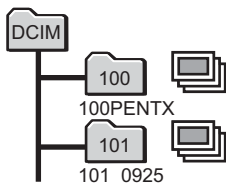

Next time, taken with the folder name setting [Date] again.  
(e.g. October 1)

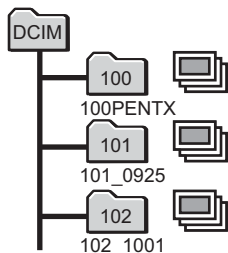

- Up to 900 folders can be created.
- Up to 9999 images can be saved in a folder.

**1 Use the four-way controller (▲▼) to select [Folder Name] in the [↵ Setting] menu.**

**2 Press the four-way controller (▶).**

A pull-down menu appears.

- 3 Use the four-way controller (▲ ▼) to select [PENTX] or [Date].**
- 4 Press the OK button.**  
The setting is saved.

## Changing the Video Output Format

When you take pictures and/or play them back with the camera connected to AV equipment, select an appropriate video output format (NTSC or PAL).

- 1 Use the four-way controller (▲ ▼) to select [Video Out] in the [↶ Setting] menu.**
- 2 Press the four-way controller (▶).**  
A pull-down menu appears.
- 3 Use the four-way controller (▲ ▼) to select a video output format.**  
Choose the video output format to match the input format of the AV equipment.
- 4 Press the OK button.**  
The setting is saved.



Depending on the country or region, images and sounds may fail to be played back if the video output format is set differently from the one in use there. If this happens, change the video output format setting.

Connecting the Camera to AV Equipment p.103  
Video Output Format of Each City p.159

## Changing the Wallpaper of the Menu

You can change the background of the menu screen.

- 1 Use the four-way controller (▲ ▼) to select [Wallpaper] in the [↶ Setting] menu.**

---

**2 Press the four-way controller (▶).**

A pull-down menu appears.

---

**3 Use the four-way controller (▲▼) to select the wallpaper type.**

Choose from [1], [2], [3], [USER] or [Off].

---

**4 Press the OK button.**

When [1], [2], [3] or [Off] is selected:

The setting is saved.

When [USER] is selected:

Use the four-way controller (◀▶) to select the wallpaper image.

After the selection, press the **OK** button to save the setting.



## Adjusting the Brightness of the Display

You can adjust the brightness of the display.

---

**1 Use the four-way controller (▲▼) to select [Brightness Level] in the [↖ Setting] menu.**

---

**2 Use the four-way controller (◀▶) to adjust the brightness.**

- — + Dark
- ■ + Normal
- — ■ + Bright

---

**3 Press the MENU button.**

The camera returns to  mode.

The display appears with the set brightness.

## Using the Power Saving Function

You can save battery power by setting the display to dim automatically when no operation is performed for a fixed time. After the power saving function has been activated, the display returns to the ordinary brightness if any button is pressed.

- 1 Use the four-way controller (▲▼) to select [Power Saving] in the [↖ Setting] menu.**
- 2 Press the four-way controller (▶).**  
A pull-down menu appears.
- 3 Use the four-way controller (▲▼) to select the time until the camera enters the power saving mode.**  
Choose from [2min.], [1min.], [30sec.], [15sec.], [5sec.] or [Off].
- 4 Press the OK button.**  
The setting is saved.



- Power Saving does not function in the following situations:
  - While taking pictures in (Continuous Shooting) or (Burst Shooting) mode
  - In playback mode
  - While recording a movie
  - While the camera is connected to a computer
  - While a menu is being displayed
- When no operation is performed after the camera is turned on, the Power Saving function is activated only after 15 seconds elapse even if [5sec.] is set.

## Setting the Auto Power Off Function

You can set the camera to turn off automatically when no operation is performed for a fixed time.

- 1 Use the four-way controller (▲▼) to select [Auto Power Off] in the [↖ Setting] menu.**

## 2 Press the four-way controller (▶).

A pull-down menu appears.

## 3 Use the four-way controller (▲▼) to select the time until the camera turns off automatically.

Choose from [5min.], [3min.] or [Off].

## 4 Press the OK button.

The setting is saved.



Auto Power Off does not function in the following situations:

- While taking pictures in (Continuous Shooting) or (Burst Shooting) mode
- While recording a movie
- During a slideshow or movie playback
- While the camera is connected to a computer

## Changing the Start-up Screen

You can choose the start-up screen displayed when the camera is turned on.

6

Settings

You can choose any of the following images as the start-up screen:

- The Guide Display Start-up Screen showing a guide for the shooting modes and buttons
- PENTAX logo
- One of your own images (compatible images only)

## 1 Use the four-way controller (▲▼◀▶) to select (Start-up Screen) from the Playback Mode Palette.

## 2 Press the OK button.

The image selection screen appears.

## 3 Use the four-way controller (◀▶) to choose the image for the start-up screen.

Only images available for the start-up screen are displayed. You can also



choose the PENTAX logo screen or the Guide Display Start-up screen already stored in the camera.

#### 4 Press the OK button.

The start-up screen is set.



- Once the start-up screen has been set, it will not be deleted even if the original image is deleted or the SD Memory Card/built-in memory is formatted.
- The start-up screen is not displayed when set to [Off].
- The start-up screen is not displayed when the camera starts up in playback mode.

## Correcting Defective Pixels in the CCD Sensor (Pixel Mapping)

Pixel Mapping is a function for mapping out and correcting defective pixels in the CCD sensor. Run the Pixel Mapping function if image dots always seem to be defective in the same place.

#### 1 Use the four-way controller (▲▼) to select [Pixel Mapping] in the [↖ Setting] menu.

#### 2 Press the four-way controller (▶).

The [Pixel Mapping] screen appears.

#### 3 Use the four-way controller (▲▼) to select [Pixel Mapping].

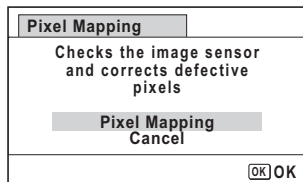

#### 4 Press the OK button.

Defective pixels are mapped and corrected.



When the battery level is low, [Not enough battery power remaining to activate Pixel Mapping] is displayed on the monitor. Charge the battery or replace it with a fully charged battery.

## Starting-up in Playback Mode

You can turn on the camera by pressing and holding the  button.

- 1 Use the four-way controller (▲▼) to select [Playback Mode] in the [ Setting] menu.**
- 2 Use the four-way controller (◀▶) to select  or .**
  - Starts up in Playback Mode
  - Does not start up in Playback Mode
- 3 Press the OK button.**

The setting is saved.

## Resetting to Default Settings (Reset)

You can reset the camera settings to their defaults. Refer to “Default Settings” (p.154) for the reset settings.

- 1 Use the four-way controller (▲▼) to select [Reset] in the [ Setting] menu.**
- 2 Press the four-way controller (▶).**

The [Reset] screen appears.
- 3 Use the four-way controller (▲▼) to select [Reset].**

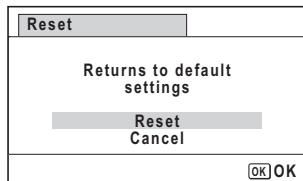

- 4 Press the OK button.**

The settings return to the defaults.



The following settings are not affected by resetting:

- Date Adjustment
- World Time
- Language/言語
- Video Out

## Setting the USB Connection Mode

Set the device to which the camera is connected with the USB cable.



Make sure to set the USB Connection mode before connecting your camera to a computer. You cannot perform the following setting if your camera is connected to a computer with the USB cable.

- 1 Turn your camera on.**
- 2 Use the four-way controller (▲▼) to select [USB Connection] in the [↖ Setting] menu.**
- 3 Press the four-way controller (▶).**  
A pull-down menu appears.
- 4 Use the four-way controller (▲▼) to select [MSC].**
- 5 Press the OK button.**  
The setting is saved.

### MSC and PTP

#### **MSC (Mass Storage Class)**

A general-purpose driver program that handles devices connected to the computer via USB as a memory device. Also indicates a standard for controlling USB devices with this driver.

By simply connecting a device that supports USB Mass Storage Class, you can copy, read, and write files from a computer without installing a dedicated driver.

#### **PTP (Picture Transfer Protocol)**

A protocol that allows transfer of digital images and control of digital cameras via USB, standardized as ISO 15740.

You can transfer image data between devices that support PTP without installing a device driver.

Unless otherwise specified, select MSC when connecting this camera to a computer.

## Connecting the Camera and the Computer

Connect your camera to the computer using the provided USB cable.

- 1 Turn the computer on.**
- 2 Turn your camera off.**
- 3 Connect your camera to the computer using the USB cable.**

Face the ► mark on the USB cable towards the ◀ mark on the camera, and connect the cable to the PC/AV terminal.

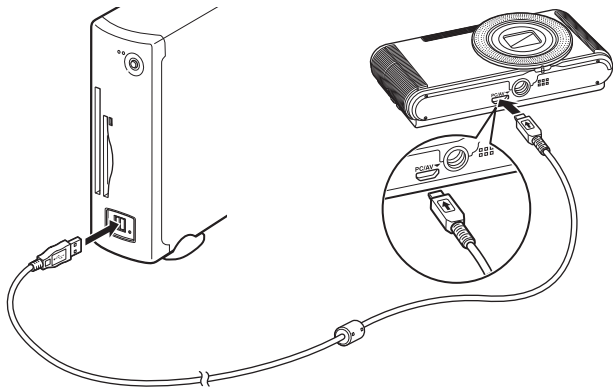

- 4 Turn your camera on.**  
The camera is recognized by the computer.



If the battery runs out of power while images are being transmitted to the computer, the image data may be lost or damaged. Charge the battery fully before connecting your camera to the computer.



- The self-timer lamp blinks while the camera is connected to a computer.
- If there is no SD Memory Card in the camera, the images stored in the built-in memory can be viewed with a computer.
- For information on system requirements, refer to p.140.

## Disconnecting the Camera from the Computer

When the camera is being used by an application such as Medialmpression, it cannot be disconnected until the application is closed.

### Windows

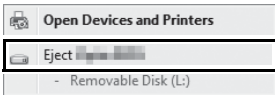
- 1 Click the  [Safely Remove Hardware] icon in the task bar located at the bottom-right corner of the desktop.
- 2 Click [Eject (the device connected)].  
The message appears.  

- 3 Disconnect the USB cable from the Windows PC and your camera.

### Macintosh

- 1 Drag [NO NAME] on the desktop to the trash.  
If the SD Memory Card has a volume label, drag the icon of that name to the trash.
- 2 Disconnect the USB cable from the Macintosh and your camera.



The camera will automatically switch to the playback mode when the USB cable is disconnected from the camera or the computer.

# Using the Provided Software

The following software is included in the provided CD-ROM.

## Image viewing/managing/editing software

“Medialmpression 3.1 for PENTAX” (for Windows)

“Medialmpression 2.1 for PENTAX” (for Macintosh)

Languages: English, French, German, Spanish, Portuguese, Italian, Dutch, Swedish, Russian, Korean, Chinese (traditional and simplified), Japanese

\*If the language running on your operating system is not supported by the software, some screens and texts will be displayed in English



You can edit movies when using the Medialmpression (for Windows)

## System Requirements

The following system requirements must be met for you to fully enjoy the images and movies captured with the camera on a computer.



The following lists the minimum system requirements for playing back and editing movies. Operation is not guaranteed on all computers meeting the system requirements.

### Windows

OS	Windows XP (SP3), Windows Vista or Windows 7 • The OS must be preinstalled and updated to the latest version.
CPU	Pentium 4 1.6 GHz or equivalent AMD Athlon (Intel Core 2 Duo 2.0 GHz or equivalent AMD Athlon X2 or higher processor recommended)
Memory	512 MB or more (1 GB or more recommended)
Hard Disk Space	300 MB or more
Others	CD/DVD drive USB port as standard equipment 1024 × 768 pixels, 16-bit color monitor or greater



Windows 95, Windows 98, Windows 98SE, Windows Me, Windows NT and Windows 2000 are not supported.

## Macintosh

OS	Mac OS X (Ver.10.3.9, 10.4, 10.5, 10.6, 10.7) • The OS must be preinstalled and updated to the latest version.
CPU	PowerPC G4 800 MHz processor or equivalent CPU (Intel Core Duo or higher processor recommended)
Memory	512 MB or more (1 GB or more recommended)
Hard Disk Space	300 MB or more
Others	CD/DVD drive USB port as standard equipment 1024 × 768 pixels, 16-bit color monitor or greater

## Installing the Software

Install the image viewing/managing/editing software “MediaImpression”.



- Make sure the computer meets the system requirements before installing the software.
- When multiple accounts have been set up in the computer, log on with an account that has administrative rights before installing the software.

## Windows

This section outlines installation steps in Windows 7 as an example.

- 1 Turn your Windows PC on.**
- 2 Insert the provided CD-ROM into the CD/DVD drive.**  
If the installation screen appears, go to Step 5.

**3** Click [Computer] in the Start menu.

**4** Double-click the CD/DVD drive icon.

The installation screen appears.

**5** Click [MediaImpression 3.1 for PENTAX].



**6** Choose a language in the “Choose Setup Language” screen and click [OK].

The setup screen appears. Follow the on-screen guidance and install the software.

**7** Select the file format to use and click [Next].

All files in the checked format will open with MediaImpression. Remove the check to open the file using another application.

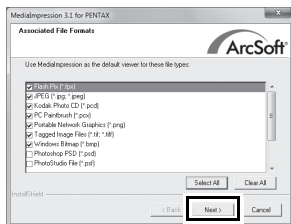

**8** Click [Finish].

Installation is complete.

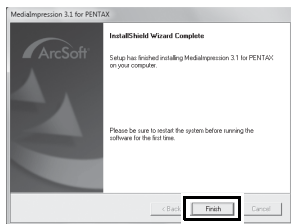

**9** Click [Exit] on the installation screen.

Remove the CD-ROM and reboot the computer.

- 1 Turn your Macintosh on.
- 2 Insert the provided CD-ROM into the CD/DVD drive.
- 3 Double-click the CD-ROM icon.
- 4 Double-click the [Pentax Software Installer] icon.  
The installation screen appears.
- 5 Click [Medialmpression 2.1 for PENTAX].

The setup screen appears. Follow the on-screen guidance and install the software.



- 6 Click [Close].  
Installation is complete.

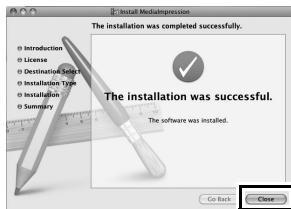

- 7 Click [Exit] on the installation screen.  
The window is closed.

## Product Registration on the Internet

In order to better serve you, we request that you complete the product registration.

If the computer is connected to the Internet, please click [Product Registration] on the installation screen. The world map screen shown on the right for Internet Product Registration is displayed. Click the displayed country or region and then follow the instructions to register your product.

Only customers in countries and regions displayed on the software installation screen can register their products on the Internet Product Registration.



## Using MediaImpression on Windows

### 1 Connect your camera to the computer.

Refer to Steps 2 to 4 on p.138 for details.  
The [AutoPlay] screen appears.

### 2 Click [Import media files to local disk].

MediaImpression starts and the Import screen appears.

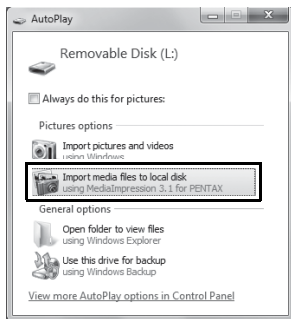

### When the [AutoPlay] screen does not appear

- 1 Double-click the [MedialImpression 3.1 for PENTAX] icon on the desktop.
- 2 Click [PhotoImpression].
- 3 Click [Import].

### 3 Click the folder icon next to [Destination Folder] and specify the destination location.

To transfer all images, proceed to Step 5.

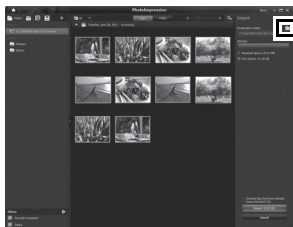

### 4 Select an image to transfer.

To select multiple images, choose the images while pressing the Ctrl key.

### 5 Click [Import].

A message appears when transfer is complete.

An arrow mark appears on the transferred images.

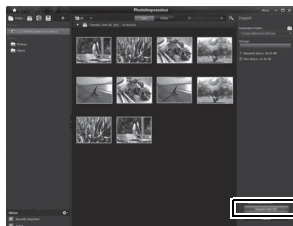

You can find more information on how to use MedialImpression by using the help pages. Select [Help] in [Menu] at the top right of the screen.

## Using MediaImpression on Macintosh

### 1 Connect the camera to your Macintosh.

Refer to Steps 2 to 4 on p.138 for details.

### 2 Double-click the [MediaImpression 2.1 for PENTAX] icon in the [Applications] folder.

MediaImpression 2.1 for PENTAX starts and the start page appears.



MediaImpression 2.1 for PENTAX.app

### 3 Click [Import].

The Import screen appears.



### 4 Select an image to transfer.

To select multiple images, choose the images while pressing the Command key.

To specify the destination location, click the folder icon.

If any of the "Import Options" are checked, marks will appear on the images that were transferred.

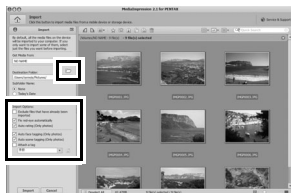

## 5 Click [Import].

The images are transferred to the computer and the Media Browser screen appears.

When a message appears after transfer is complete, click [Done].

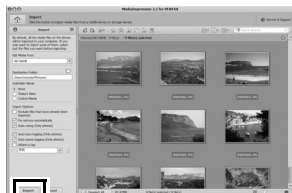

- If the images from the camera are not displayed in the Import screen, select [NO NAME] (or the volume label name) in [Get Media from].
- You can find more information on how to use MediaImpression by using the help pages. Select [ArcSoft MediaImpression Help] in [Help] on the menu bar.

# Functions Available for Each Shooting Mode

✓: Can be set.      ×: Cannot be set.

Function		Shooting Mode				
		AUTO PICT	P	●	📄	📷📷
Zoom button	Zoom operation	✓	✓	✓*1	✓	✓
Flash Mode	📷 (Auto)	✓	✓	✓	×	✓
	📷 (Flash Off)	✓	✓	✓	✓	✓
	📷 (Flash On)	✓	✓	×	✓	✓
	📷 (Flash On + Red-eye)	✓	✓	×	✓	✓
Drive Mode	☐ (Standard)	✓	✓	✓	✓	✓
	⌚ (Self-timer)	✓	✓	✓	✓	✓
	⌚ (2 sec. Self-timer)	✓	✓	✓	✓	✓
	📷 (Continuous Shooting)	✓	✓	×	✓	✓
	📷 (Burst Shooting)	✓	✓	×	✓	✓
Focus Mode	<b>AF</b> (Standard)	✓	✓	✓	✓	✓
	📷 (Macro)	✓	✓	✓	✓	✓
	📷 (Super Macro)	✓	✓	×	✓	✓
	<b>PF</b> (Pan Focus)	✓	✓	✓	✓	✓
	▲ (Infinity)	✓	✓	×	✓	✓
[📷 Rec. Mode] menu	Recorded Pixels	✓	✓	×*5	✓	✓
	White Balance	×*9	✓	×*9	✓	×*9
	Focusing Area	×*10	✓	×*10	✓	✓
	Sensitivity	✓	✓	×*11	✓	✓
	EV Compensation	×*13	✓	×*13	✓	✓
	Face Detection	✓*14	✓	×*15	✓	✓*14
	Sharpness	×	✓	×*17	✓	×
	Saturation	×	✓	×*17	✓	×
	Contrast	×	✓	×*17	✓	×
Date Imprint	✓	✓	×*18	✓	✓	

- \*1 Intelligent Zoom is not available
- \*2 Only optical zoom is available
- \*3 Fixed at 📷 (Flash Off)
- \*4 Fixed at ▲ (Infinity)
- \*5 Fixed at 16M

- \*6 Fixed at 5M for the 4:3 aspect ratio  
Fixed at 4M for the 16:9 aspect ratio
- \*7 In 📷 mode, fixed at 3M for the 4:3 aspect ratio and 2M for the 16:9 aspect ratio  
In 📷 mode, fixed at 5M for the 4:3 aspect ratio and 4M for the 16:9 aspect ratio
- \*8 Set in the [📷 Movie] menu

Shooting menu items not listed in this chart can be set in any shooting mode except for Green Mode. However, these settings may not function properly in certain shooting modes and setting conditions even if they can be selected. For further information, please refer to the pages listed below.

Shooting Mode							Function	Page	
✓	✓*2	✓	✓	✓	✓*1	Zoom operation	Zoom button	p.63	
✓	✓	x	✓	✓	x	(Auto)	Flash Mode	p.70	
✓	✓	x*3	✓	✓	x*3	(Flash Off)			
✓	✓	x	✓	✓	x	(Flash On)			
✓	✓	x	✓	✓	x	(Flash On + Red-eye)			
✓	✓	✓	✓	✓	✓	(Standard)	Drive Mode	p.71	
✓	✓	✓	✓	✓	✓	(Self-timer)			
✓	✓	✓	✓	✓	✓	(2 sec. Self-timer)			
✓	✓	x	x	x	x	(Continuous Shooting)			
✓	✓	x	x	x	x	(Burst Shooting)			
✓	✓	x	✓	✓	✓	<b>AF</b> (Standard)	Focus Mode	p.73	
✓	✓	x	✓	✓	✓	(Macro)			
✓	✓	x	✓	✓	✓	(Super Macro)			
✓	✓	x	✓	✓	✓	<b>PF</b> (Pan Focus)			
✓	✓	x*4	✓	✓	✓	(Infinity)	[Rec. Mode] menu	p.75	
✓	x*6	✓	x*7	✓	✓*8	Recorded Pixels			p.77
x*9	✓	x*9	✓	✓	✓	White Balance			p.74
✓	✓	x*10	✓	✓	✓	Focusing Area			p.78
✓	x*11	x*12	✓	✓	x*11	Sensitivity			p.76
✓	✓	✓	✓	✓	✓	EV Compensation			p.79
✓*16	✓	✓	✓	✓	✓	Face Detection			p.80
x	✓	x	✓	✓	✓	Sharpness			p.81
x	✓	x	✓	✓	✓	Saturation			p.81
x	✓	x	✓	✓	✓	Contrast			p.81
✓	✓	✓	✓	✓	x*18	Date Imprint	p.81		

\*9 Fixed at **AWB**

\*10 Fixed at [ ] (Multiple)

\*11 Fixed at [Auto]

\*12 The sensitivity is fixed at the minimum value

\*13 Fixed at  $\pm 0.0$

\*14 [Off] is not available

\*15 Fixed at [On]

\*16 Available only when Color is selected in [A] (Text) mode

\*17 Fixed at the normal setting

\*18 Fixed at [Off]

# Messages







Messages such as the following may appear on the display during camera operation.

Message	Description
Battery depleted	The battery is exhausted. Charge the battery using the power adapter D-PA116 (p.31).
Memory card full	The SD Memory Card is full and no more images can be saved. Insert a new SD Memory Card or delete unwanted images (p.34, p.98). Change the number of recorded pixels of recorded images and try again (p.105).
Built-in memory full	Displayed if the built-in memory is full when saving a file.
Memory card error	Shooting and playback are impossible due to a problem with the SD Memory Card. You may be able to display or copy the images on the card using a computer.
The built-in memory is not formatted	The data within the built-in memory is damaged. Format the built-in memory.
Card is not formatted	The SD Memory Card you have inserted is unformatted or has been formatted on a computer or other device and is not compatible with this camera. Format the SD Memory Card in the camera (p.123).
Card is locked	The SD Memory Card is write-protected (p.6).
Compression error	This message appears when the camera fails to compress an image. Change the number of recorded pixels of the image and try shooting or saving it again.
No image	There is no image on the SD Memory Card or in the built-in memory.
Movie recording stopped	This message appears when the internal temperature of the camera has exceeded normal operating limits while recording a movie.
The camera will turn off to prevent damage from overheating	The camera turned off because it has overheated. Wait until it cools down and then turn it back on.
Deleting	This message appears while deleting an image.
Camera cannot play this image and sound	You are trying to play back an image in a format not supported by this camera. You may be able to play it back on another brand of camera or on your computer.

Message	Description
Image folder cannot be created	The largest file number (9999) has been assigned to an image in the largest folder number (999) and no more images can be saved. Insert a new SD Memory Card or format the card/built-in memory (p.123).
Protected	The image you are trying to delete is protected (p.100).
Data being recorded	Displayed when you try to switch to  mode while an image is still being recorded, or when an image is being saved or a setting is being changed. It disappears after the image is recorded or the setting is changed.
Data being processed	Displayed when the camera takes more than five seconds to display an image due to image processing, or when the SD Memory Card or the built-in memory is being formatted.
No image to be processed	Displayed when there are no images.
This image cannot be processed	Displayed for files that cannot be processed.
No card in the camera	Displayed when no SD Memory Card is inserted.
Available built-in memory is insufficient to copy the images	Displayed when there is insufficient built-in memory to perform copying.
Cannot process correctly	Displayed when Red-eye Compensation processing fails.
Not enough battery power remaining to activate Pixel Mapping	Appears during pixel mapping if the battery level is insufficient. Charge the battery using the power adapter D-PA116, or replace the battery with a fully charged one. (p.31)

# Troubleshooting

Problem	Cause	Remedy
The camera will not turn on	The battery is not installed	Check if a battery is installed.
	The battery is exhausted	Charge the battery.
No image appears on the display	The camera is connected to a computer	The display is off when the camera is connected to a computer.
	The camera is connected to a TV	The display is off when the camera is connected to a TV.
The display is hard to see	The brightness level of the display is set too dark	Adjust the brightness level in [Brightness Level] in the [Setting] menu (p.132).
	Power Saving function is activated	When the Power Saving function is activated, the display automatically darkens after a certain amount of time. Press any button to return to the normal brightness level. Select [Off] in [Power Saving] in the [Setting] menu to turn the Power Saving function off (p.133).
The shutter will not release	The flash is charging	Pictures cannot be taken while the flash is charging. Wait until charging is finished.
	There is no available space on the SD Memory Card or in the built-in memory	Insert an SD Memory Card with available space or delete unwanted images (p.34, p.98).
	Recording	Wait until recording is finished.
The picture is dark when using the flash	The subject is too far away in a dark environment, such as a night scene	The picture becomes dark if the subject is too far away. Take pictures within the specified flash range.

Problem	Cause	Remedy
The subject is not in focus	The subject is difficult to focus on with autofocus	Lock the focus on an object the same distance away as the subject (by pressing and holding the shutter release button halfway), then aim the camera at your subject and press the shutter release button fully (p.56).
	The subject is not in the focusing area	Locate the desired subject in the focus frame (focusing area) in the center of the display. If it is difficult to do so, first lock the focus on the desired subject (focus lock), and then move the camera to recompose.
The flash does not discharge	The flash mode is set to 	Set to  (Auto) or  (Flash On) (p.70).
	The drive mode is set to  or  The focus mode is set to  The shooting mode is set to  , or while recording a movie	The flash does not discharge in these modes.



Very occasionally, static electricity may cause camera malfunction. In this case, remove the battery and install it again. If the camera then works properly, normal condition is restored and you can continue using the camera.

# Default Settings

The table below lists the factory default settings.

The meaning of the indications for menu items with a default setting is explained below.

## Last Memory Setting

Yes : The current setting (last memory) is saved when the camera is turned off.

No : The setting returns to the default setting when the camera is turned off.

\* : The last memory setting depends on the [Memory] setting (p.87).

— : N/A

## Reset Setting



Yes : The setting returns to the default setting with the Reset function (p.136).

No : The setting is saved even after reset.

— : N/A

## ● [📷 Rec. Mode] Menu Items



Item	Default Setting	Last Memory Setting	Reset Setting	Page
Recorded Pixels	 (4608×2592)	Yes	Yes	p.75
White Balance	<b>AWB</b> (Auto)	*	Yes	p.77
Focusing Area	[ ] (Multiple)	Yes	Yes	p.74
Sensitivity	Auto	*	Yes	p.78
EV Compensation	±0.0	*	Yes	p.76
Face Detection	On	*	Yes	p.79
Digital Zoom	<input checked="" type="checkbox"/> (On)	*	Yes	p.64

Item		Default Setting	Last Memory Setting	Reset Setting	Page
Memory	Flash Mode	<input checked="" type="checkbox"/> (On)	Yes	Yes	p.87
	Drive Mode	<input type="checkbox"/> (Off)	Yes	Yes	
	Focus Mode	<input type="checkbox"/> (Off)	Yes	Yes	
	Zoom Position	<input type="checkbox"/> (Off)	Yes	Yes	
	White Balance	<input type="checkbox"/> (Off)	Yes	Yes	
	Sensitivity	<input type="checkbox"/> (Off)	Yes	Yes	
	EV Compensation	<input type="checkbox"/> (Off)	Yes	Yes	
	Face Detection	<input type="checkbox"/> (Off)	Yes	Yes	
	Digital Zoom	<input checked="" type="checkbox"/> (On)	Yes	Yes	
	DISPLAY	<input type="checkbox"/> (Off)	Yes	Yes	
File No.	<input checked="" type="checkbox"/> (On)	Yes	Yes		
Green Button	Green Mode	Yes	Yes	p.82	
Sharpness	 (Normal)	Yes	Yes	p.80	
Saturation	 (Normal)	Yes	Yes	p.81	
Contrast	 (Normal)	Yes	Yes	p.81	
Date Imprint	Off	Yes	Yes	p.81	



● [Movie] Menu Items

Item	Default Setting	Last Memory Setting	Reset Setting	Page
Recorded Pixels	 (1280×720/30 fps)	Yes	Yes	p.86
Movie SR	<input checked="" type="checkbox"/> (On)	Yes	Yes	p.86











● [  Setting ] Menu Items

Item		Default Setting	Last Memory Setting	Reset Setting	Page
Sound	Operation Volume	3	Yes	Yes	p.124
	Playback Volume	3	Yes	Yes	
	Start-up Sound	Off	Yes	Yes	
	Shutter Sound	1	Yes	Yes	
	Operation Sound	1	Yes	Yes	
	Self-timer Sound	1	Yes	Yes	
Date Adjustment	Date Format (date)	According to the initial setting	Yes	No	p.40 p.125
	Date Format (time)	24h	Yes	No	
	Date	1/1/2012	Yes	No	
	Time	According to the initial setting	Yes	No	
World Time	Select Time	 Hometown	Yes	Yes	p.127
	Destination (City)	According to the initial setting	Yes	No	
	Destination (DST)	<input type="checkbox"/> (Off)	Yes	No	
	Hometown (City)	According to the initial setting	Yes	No	
	Hometown (DST)	<input type="checkbox"/> (Off)	Yes	No	
Language/言語		According to the initial setting	Yes	No	p.37 p.129
Folder Name		Date	Yes	Yes	p.130
USB Connection		MSC	Yes	Yes	p.137
Video Out		According to the initial setting	Yes	No	p.131
Wallpaper		Off	Yes	Yes	p.131
Brightness Level		 (Normal)	Yes	Yes	p.132
Power Saving		5 sec.	Yes	Yes	p.133
Auto Power Off		3 min.	Yes	Yes	p.133
Reset		Cancel	—	—	p.136
Delete All		Cancel	—	—	p.99
Pixel Mapping		Cancel	—	—	p.135
Playback Mode		<input checked="" type="checkbox"/> (On)	Yes	Yes	p.136
Format		Cancel	—	—	p.123

## ● Playback Mode Palette Items

Item		Default Setting	Last Memory Setting	Reset Setting	Page
Slideshow	Interval	3 sec.	Yes	Yes	p.94
	Screen Effect	Wipe	Yes	Yes	
	Sound Effect	<input checked="" type="checkbox"/> (On)	Yes	Yes	
Image Rotation		Normal	—	—	p.96
Small Face Filter		 (approx. 7%)	No	No	p.107
Miniature Filter		 (Blurring of the top and bottom)	No	No	p.108
HDR Filter		—	—	—	p.108
Digital Filter		B&W	No	—	p.110
Frame Composite		Default 1	Yes	Yes	p.113
Red-eye Compensation		—	—	—	p.112
Movie Editing	Save as Still Image	—	—	—	p.116
	Divide Movies	—	—	—	
Resize	Recorded Pixels	Depending on the picture taken	—	—	p.105
Cropping		Depending on the picture taken	—	—	p.106
Image Copy		Built-in memory → SD Memory Card	—	—	p.118
Protect	Single Image	Depending on the recorded image	—	—	p.100
	All Images	Depending on the recorded image	—	—	
DPOF	Single Image	Copies: 0	—	—	p.120
	All Images	Date: <input type="checkbox"/> (Off)	—	—	
Start-up Screen		Off	Yes	Yes	p.134

## ● Key Operation

Item	Function	Default Setting	Last Memory Setting	Reset Setting	Page
 button	Operation Mode	 mode	—	—	—
Zoom button	Zoom Position	Full wide-angle	*	No	p.63
Four-way controller	 Drive Mode	 (Standard)	*	Yes	p.71
	 Shooting Mode	 (Auto Picture)	Yes	Yes	p.57
	 Flash Mode	 (Auto)	*	Yes	p.70
	 Focus Mode	<b>AF</b> (Standard)	*	Yes	p.73
<b>MENU</b> button	Menu Display	Capture mode: [  Rec. Mode] menu Playback mode: [  Setting] menu	—	—	p.47
<b>OK</b> button	Information Display	Normal	*	Yes	p.20

# List of World Time Cities

**City:** indicates cities that can be set as either the Initial Setting (p.37) or the World Time (p.127).  
**Video Output Format:** indicates the video output format of the city set as the initial setting.

Region	City	Video Output Format	Region	City	Video Output Format
North America	Honolulu	NTSC	Africa/ West Asia	Istanbul	PAL
	Anchorage	NTSC		Cairo	PAL
	Vancouver	NTSC		Jerusalem	PAL
	San Francisco	NTSC		Nairobi	PAL
	Los Angeles	NTSC		Jeddah	PAL
	Calgary	NTSC		Tehran	PAL
	Denver	NTSC		Dubai	PAL
	Chicago	NTSC		Karachi	PAL
	Miami	NTSC		Kabul	PAL
	Toronto	NTSC		Male	PAL
	New York	NTSC		Delhi	PAL
Halifax	NTSC	Colombo		PAL	
Central and South America	Mexico City	NTSC		Kathmandu	PAL
	Lima	NTSC		Dacca	PAL
	Santiago	NTSC	East Asia	Yangon	NTSC
	Caracas	NTSC		Bangkok	PAL
	Buenos Aires	PAL		Kuala Lumpur	PAL
	Sao Paulo	PAL		Vientiane	PAL
Rio de Janeiro	NTSC	Singapore		PAL	
Europe	Lisbon	PAL		Phnom Penh	PAL
	Madrid	PAL		Ho Chi Minh	PAL
	London	PAL		Jakarta	PAL
	Paris	PAL		Hong Kong	PAL
	Amsterdam	PAL		Beijing	PAL
	Milan	PAL		Shanghai	PAL
	Rome	PAL		Manila	NTSC
	Copenhagen	PAL		Taipei	NTSC
	Berlin	PAL		Seoul	NTSC
	Prague	PAL	Tokyo	NTSC	
	Stockholm	PAL	Guam	NTSC	
	Budapest	PAL	Oceania	Perth	PAL
	Warsaw	PAL		Adelaide	PAL
	Athens	PAL		Sydney	PAL
	Helsinki	PAL		Noumea	PAL
Moscow	PAL	Wellington		PAL	
Africa/ West Asia	Dakar	PAL		Auckland	PAL
	Algiers	PAL		Pago Pago	NTSC
	Johannesburg	PAL			

# Optional Accessories

A number of dedicated accessories are available for this camera. Products marked with an asterisk (\*) are the same as those supplied with the camera.

- **Power supply**

- Rechargeable lithium-ion battery D-LI108 (\*)**

- Power adapter D-PA116 (\*)**

- Battery charger D-BC108**

- **Cable**

- USB cable I-USB116 (\*)**

- AV cable I-AVC116**

- **Strap**

- O-ST116 (\*)**

- O-ST8**                      Silver chain strap

- O-ST24**                     Genuine leather strap

- O-ST81**                    Waterproof strap

- **Camera case**

- O-CC81**

# Main Specifications

Type	Fully automatic compact digital camera with built-in zoom lens
Number of Effective Pixels	Approx. 16 megapixels
Image Sensor	1/2.3 inch CCD
Number of Recorded Pixels	<p>Still     <b>16M</b> (4608×3456), <b>12M</b> (3456×3456),  <b>12M</b> (4608×2592), <b>7M</b> (3072×2304),  <b>2M</b> (1920×1080), <b>640</b> (640×480)</p> <p>* Fixed at <b>3M</b> for the 4:3 aspect ratio and <b>2M</b> for the 16:9 aspect ratio in Frame Composite mode.  * Fixed at <b>5M</b> for the 4:3 aspect ratio and <b>4M</b> for the 16:9 aspect ratio in Digital SR/Miniature Filter/Burst Shooting mode, or when the sensitivity is set to 3200 or 6400.</p> <p>Movie    <b>1280</b> (1280×720/30 fps), <b>640</b> (640×480/30 fps)  (recorded pixels/frame rate)</p>
Sensitivity (Standard Output Sensitivity)	<p>Auto (ISO 64 - 800)  Manual (ISO 64, 100, 200, 400, 800, 1600, 3200, 6400)  * Fixed at Auto (ISO 64 - 6400) in Digital SR mode.</p>
File Format	<p>Still     JPEG (Exif 2.3), DCF 2.0, DPOF, PRINT Image Matching III</p> <p>Movie    AVI (Motion JPEG), approx. 30fps, PCM system, monaural sound, Movie SR (Movie Shake Reduction)</p>
Storage Media	Built-in memory (approx. 41.7 MB), SD Memory Card, SDHC Memory Card, SDXC Memory Card

## Approximate Image Storage Capacity and Recording Time

### Still Pictures

	Built-in Memory	2 GB SD Memory Card
<b>[16M]</b> 4608×3456	13 pictures	640 pictures
<b>[12M]</b> 3456×3456	18 pictures	842 pictures
<b>[12M]</b> 4608×2592	18 pictures	842 pictures
<b>[7M]</b> 3072×2304	25 pictures	1159 pictures
<b>[2M]</b> 1920×1080	72 pictures	3235 pictures
<b>[640]</b> 640×480	243 pictures	10245 pictures

- The image storage capacity is for reference only when images are recorded on blank built-in memory or SD Memory Card. If movies are recorded, the image storage capacity is decreased. The actual image storage capacity may vary depending on the SD Memory Card and the subject.

### Movie

	Built-in Memory	2 GB SD Memory Card
<b>[1280]</b> 1280×720/30 fps	15 sec.	13 min. 27 sec.
<b>[640]</b> 640×480/30 fps	30 sec.	25 min. 33 sec.

- The above figures are based on our standard shooting conditions and may vary depending on the subject, shooting conditions and type of the SD Memory Card used. If other data such as still images are recorded, recording time becomes shorter.
- Recording can continue until the built-in memory or the SD Memory Card is full, or the size of the recorded movie reaches 2 GB (when using a large capacity memory card). If recording stops at 2 GB, start recording again to continue to record the movie in blocks of 2 GB.

White Balance	Auto, Daylight, Shade, Tungsten Light, Fluorescent Light, Manual	
Lens	Focal Length	5.1 mm - 25.5 mm (approx. 28 mm - 140 mm in 35 mm equivalent focal length)
	Aperture	F3.9 (W) - F6.3 (T)
	Lens Composition	8 elements in 8 groups (5 aspherical elements)
	Zoom Type	Electrically driven
Optical Zoom	5×	
Intelligent Zoom	Approx. 7.5× at <b>[7M]</b> , Approx. 36.0× at <b>[640]</b> (when combined with optical zoom)	
Digital Zoom	Up to approx. 7.2× (combines with 5× optical zoom to give zoom magnification equivalent to approx. 36.0×)	

Shake Reduction	Still	High-sensitivity anti-shake mode (Digital SR)
	Movie	Electronic Movie Shake Reduction (Movie SR)
Display	2.7 inch wide-LCD, approx. 230,000 dots	
Playback Modes	Single-frame, 6-frame, 12-frame, Enlargement (max. 10×, scrollable), Folder Display, Calendar Display, Histogram Display, Deleting Selected Images, Slideshow, Image Rotation, Small Face Filter, Miniature Filter, HDR Filter, Digital Filter, Frame Composite, Movie Playback/Edit (Save as Still Image, Divide Movies), Red-eye Compensation, Resize, Cropping, Image Copy, Protect, DPOF, Start-up Screen	
Focus Modes	Autofocus, Macro, Super Macro, Pan Focus, Infinity	
Focus	Type	TTL contrast detection system by sensor 9-point autofocus (multiple/spot/automatic tracking AF changeable)
	Focus range (From lens face)	Standard : 0.4 m - ∞ (Wide-angle) 1 m - ∞ (Telephoto)
		Macro : 0.1 m - 0.5 m (Wide-angle) 0.3 m - 0.5 m (Mid-zoom)
		Super Macro : 0.05 m - 0.2 m (Fixed at Wide-angle)
	* It is possible to switch to Pan Focus or Infinity. * Face Detection AF is available only while the camera detects the subject's face.	
	Focus Lock	By half-pressing the shutter release button
Exposure Control	Metering System	Multi-segment metering
	Exposure Compensation	±2 EV (can be set in 1/3 EV steps)
Face Detection	Detection of up to 16 people's faces (up to 16 face detection frames on the display), Smile Capture * Face Detection AE is available only while the camera detects the subject's face.	
Shooting Modes	Auto Picture, Program, Blue Sky, Landscape, Flower, Sunset, Night Scene, Night Scene Portrait, Portrait, Natural Skin Tone, Food, Digital SR, Kids, Pet, Sport, Surf & Snow, Fireworks, Frame Composite, Party, Candlelight, Text, Miniature Filter, HDR Filter, Green	
Digital Filters	B&W, Sepia, Toy Camera, Retro (Original image, Amber, Blue), Color (Red, Pink, Purple, Blue, Green, Yellow), Extract Color (Red, Green, Blue), Color Emphasis (Sky Blue, Fresh Green, Delicate Pink, Autumn Leaves), Soft, Brightness	
Movie	Continuous	Approx. 1 second - until built-in memory or SD Memory Card is full (however, maximum size is limited to 2 GB)
	Recording Time	
Shutter Speed	1/2000 sec. - 1/4 sec., max. 4 sec. (Night Scene mode)	

Built-in Flash	Modes	Auto, Flash Off, Flash On, Flash On + Red-eye
	Flash Range	Wide-angle: approx. 0.3 m - 3.6 m (approx. 1.0 ft - 12 ft) (Sensitivity: in Auto condition) Telephoto: approx. 1.0 m - 2.2 m (approx. 3.3 ft - 7.2 ft) (Sensitivity: in Auto condition)
Drive Modes	Single-frame, Self-timer (approx. 10 sec., approx. 2 sec.), Continuous Shooting, Burst Shooting	
Self-timer	Electronic control type, control time: Approx. 10 sec., 2 sec.	
Time Function	World Time	75 cities (28 time zones)
Power Source	Rechargeable lithium-ion battery D-LI108	
Battery Life	Number of Recordable Images approx. 200 pictures	* Recording capacity shows approximate number of shots recorded during CIPA-compliant testing (with display on, flash used for 50% of the shots, and 23 degrees centigrade). Actual performance may vary according to operating conditions.
	Playback Time approx. 130 min.	* According to the result of in-house testing. Actual time may differ depending on usage conditions.
	Movie Recording Time approx. 70 min.	
Interfaces	USB 2.0 (high-speed compatible) /PC/AV terminal	
Video Output	NTSC/PAL (monaural)	
Dimensions	Approx. 101 (W) × 46.5 (H) × 22.5 (D) mm (excluding operating or protruding parts)	
Weight	Approx. 105 g (excluding battery and SD Memory Card) Approx. 122 g (including battery and SD Memory Card)	
Accessories	Rechargeable lithium-ion battery, Power adapter, USB cable, Alternative Skins, Lens Ring (installed on camera), Software (CD-ROM), Strap, Operating Manual, Quick Guide	

# WARRANTY POLICY

All PENTAX cameras purchased through authorized bona fide photographic distribution channels are guaranteed against defects of material or workmanship for a period of twelve months from date of purchase. Service will be rendered, and defective parts will be replaced without cost to you within that period, provided the equipment does not show evidence of impact, sand or liquid damage, mishandling, tampering, battery or chemical corrosion, operation contrary to operating instructions, or modification by an unauthorized repair shop. The manufacturer or its authorized representatives shall not be liable for any repair or alterations except those made with its written consent and shall not be liable for damages from delay or loss of use or from other indirect or consequential damages of any kind, whether caused by defective material or workmanship or otherwise; and it is expressly agreed that the liability of the manufacturer or its representatives under all guarantees or warranties, whether expressed or implied, is strictly limited to the replacement of parts as hereinbefore provided. No refunds will be made on repairs by non-authorized PENTAX service facilities.

## Procedure During 12-month Warranty Period

Any PENTAX which proves defective during the 12-month warranty period should be returned to the dealer from whom you purchased the equipment or to the manufacturer. If there is no representative of the manufacturer in your country, send the equipment to the manufacturer, with postage prepaid. In this case, it will take a considerable length of time before the equipment can be returned to you owing to the complicated customs procedures required. If the equipment is covered by warranty, repairs will be made and parts replaced free of charge, and the equipment will be returned to you upon completion of servicing. If the equipment is not covered by warranty, regular charges of the manufacturer or of its representatives will apply. Shipping charges are to be borne by the owner. If your PENTAX was purchased outside of the country where you wish to have it serviced during the warranty period, regular handling and servicing fees may be charged by the manufacturer's representatives in that country. Notwithstanding this, your PENTAX returned to the manufacturer will be serviced free of charge according to this procedure and warranty policy. In any case, however, shipping charges and customs clearance fees to be borne by the sender. To prove the date of your purchase when required, please keep the receipt or bills covering the purchase of your equipment for at least a year. Before sending your equipment for servicing, please make sure that you are sending it to the manufacturer's authorized representatives or their approved repair shops, unless you are sending it directly to the manufacturer. Always obtain a quotation for the service charge, and only after you accept the quoted service charge, instruct the service station to proceed with the servicing.

- This warranty policy does not affect the customer's statutory rights.
- The local warranty policies available from PENTAX distributors in some countries can supersede this warranty policy. Therefore, we recommend that you review the warranty card supplied with your product at the time of purchase, or contact the PENTAX distributor in your country for more information and to receive a copy of the warranty policy.



The CE Mark is a Directive conformity mark of the European Union.

## **For customers in USA**

### **STATEMENT OF FCC COMPLIANCE**

This device complies with Part 15 of the FCC Rules. Operation is subject to the following two conditions: (1) This device may not cause harmful interference, and (2) this device must accept any interference received, including interference that may cause undesired operation.

Changes or modifications not approved by the party responsible for compliance could void the user's authority to operate the equipment. This equipment has been tested and found to comply with the limits for a Class B digital device, pursuant to part 15 of the FCC Rules. These limits are designed to provide reasonable protection against harmful interference in a residential installation. This equipment generates, uses and can radiate radio frequency energy and, if not installed and used in accordance with the instructions, may cause harmful interference to radio communications. However, there is no guarantee that interference will not occur in a particular installation. If this equipment does cause harmful interference to radio or television reception, which can be determined by turning the equipment off and on, the user is encouraged to try to correct the interference by one or more of the following measures:

- Reorient or relocate the receiving antenna.
  - Increase the separation between the equipment and receiver.
  - Connect the equipment into an outlet on a circuit different from that to which the receiver is connected.
- \* Consult the dealer or an experienced radio/TV technician for help.

## **For customers in Canada**

This Class B digital apparatus complies with Canadian ICES-003.

## **Pour les utilisateurs au Canada**

Cet appareil numérique de la classe B est conforme à la norme NMB-003 du Canada.

## **FOR CALIFORNIA, U.S.A. ONLY**

Perchlorate Material-special handling may apply. The lithium battery used in this camera contains perchlorate material, which may require special handling. See [www.dtsc.ca.gov/hazardouswaste/perchlorate](http://www.dtsc.ca.gov/hazardouswaste/perchlorate)

## Declaration of Conformity

According to 47CFR, Parts 2 and 15 for  
Class B Personal Computers and Peripherals

We: PENTAX RICOH IMAGING AMERICAS  
CORPORATION

Located at: 633 17<sup>th</sup> Street, Suite 2600  
Denver, Colorado 80202 U.S.A.  
Phone: 800-877-0155 Fax: 303-790-1131

Declare under sole responsibility that the product identified herein complies with 47CFR Parts 2 and 15 of the FCC rules as a Class B digital device. Each product marketed is identical to the representative unit tested and found to be compliant with the standards. Records maintained continue to reflect the equipment being produced can be expected to be within the variation accepted, due to quantity production and testing on the statistical basis as required by 47CFR §2.909. Operation is subject to the following two conditions: (1) This device may not cause harmful interference, and (2) This device must accept any interference received, including interference that may cause undesired operation. The above named party is responsible for ensuring that the equipment complies with the standards of 47CFR §15.101 to §15.109.

Product Name: Digital Camera

Model Number: Optio LS465

Contact person: Customer Service Manager

Date and Place: April, 2012, Colorado

## Information for Users on Collection and Disposal of Old Equipment and Used Batteries



### 1. In the European Union

These symbols on the products, packaging and/or accompanying documents mean that used electrical and electronic equipment and batteries should not be mixed with general household waste.



Used electrical/electronic equipment and batteries must be treated separately and in accordance with legislation that requires proper treatment, recovery and recycling of these products.



By disposing of these products correctly you will help ensure that the waste undergoes the necessary treatment, recovery and recycling and thus prevent potential negative effects on the environment and human health which could otherwise arise due to inappropriate waste handling.

If a chemical symbol is added beneath the symbol shown above, in accordance with the Battery Directive, this indicates that a heavy metal (Hg = Mercury, Cd = Cadmium, Pb = Lead) is present in the battery at a concentration above an applicable threshold specified in the Battery Directive.

For more information about collection and recycling of used products, please contact your local authorities, your waste disposal service or the point of sale where you purchased the products.

### 2. In other countries outside the EU

These symbols are only valid in the European Union. If you wish to discard used products, please contact your local authorities or dealer and ask for the correct method of disposal.

For Switzerland: Used electrical/electronic equipment can be returned free of charge to the dealer, even when you don't purchase a new product. Further collection facilities are listed on the home page of [www.swico.ch](http://www.swico.ch) or [www.sens.ch](http://www.sens.ch).



## Symbols

Mode .....	12, 46
Mode .....	12, 46
button .....	42, 44
[ Rec. Mode]	
menu .....	50, 154
[ Movie] Menu .....	51, 155
[ Setting] menu .....	52, 156
Delete .....	89, 98
<b>T</b> Tele .....	63
<b>W</b> Wide .....	63
Magnify .....	97
Six-/Twelve-image	
display .....	91
Self-timer .....	71
Continuous Shooting ....	71
Burst Shooting .....	71
Green Mode .....	61
Auto Picture .....	60
Program .....	61
Blue Sky .....	58
Landscape .....	58
Flower .....	58
Sunset .....	58
Night Scene .....	58
Night Scene Portrait ....	58
Portrait .....	58
Natural Skin Tone .....	58
Food .....	58
Digital SR .....	58
Kids .....	58
Pet .....	65
Sport .....	58
Surf & Snow .....	58
Fireworks .....	58

Frame Composite	
.....	66, 113
Party .....	59
Candlelight .....	59
Text .....	67
Miniature .....	68, 108
<b>HDR</b> HDR .....	68, 108

**A**









Alternative Skins .....	27
Auto <b>AWB</b> .....	77
Auto Picture Mode .....	60
Auto Power Off .....	133
Auto  .....	70
Automatic Tracking	
AF .....	59, 74
AV cable .....	103
AV equipment .....	103

**B**

B&W filter .....	110
Basic mode .....	61
Battery level indicator .....	33
Blue Sky Mode .....	58
Brightness filter .....	110
Brightness Level .....	132
Built-in memory .....	118
Burst Shooting  .....	71

**C**

Calendar display .....	92
Camera shake .....	86
Candlelight Mode .....	59
Capture Mode Palette .....	57
Charging a battery .....	31
Checking the SD Memory	
Card .....	36
City name .....	159

Color Emphasis filter .....	110	Flash On + Red-eye 	70
Color filter .....	110	Flash On 	70
Connecting to a TV .....	103	Flower Mode .....	58
Continuous Shooting 	71	Fluores. Light 	77
Contrast .....	81	Focus Mode .....	73
Copy .....	118	Focusing .....	73
Cropping .....	106	Focusing Area .....	74
<b>D</b>		Folder display .....	92
Date and time		Folder name .....	130
setting .....	40, 125	Food Mode .....	58
Date Imprint .....	81	Format .....	123
Daylight 	77	Four-way controller .....	43, 45
Daylight saving		Frame Composite .....	66, 113
time .....	128	Frame rate .....	86
Default settings .....	154	<b>G</b>	
Delete 	89, 98	Green Button .....	43, 45, 82
Delete all .....	99	Green Mode .....	61
Destination .....	127	Guide indications .....	24
Digital Filter .....	110	<b>H</b>	
Digital SR .....	58	HDR Filter .....	68, 108
Digital Zoom .....	63, 64	Histogram .....	24
Display brightness .....	132	Hometown .....	127
Display language .....	37, 129	<b>I</b>	
Dividing movies .....	117	Image Storage	
DPOF settings .....	120	Capacity .....	162
Drive Mode .....	71	Infinity 	73
<b>E</b>		Info Display .....	21
Editing movies .....	116	Initial settings .....	37
Error messages .....	150	Installing a battery .....	29
Exposure setting .....	76	Installing the Software .....	141
Extract Color filter .....	110	Instant Review .....	57
<b>F</b>		Intelligent Zoom .....	63
Face Detection .....	59, 79	<b>K</b>	
File number .....	87	Kids Mode .....	58
Filters .....	68, 108, 110	<b>L</b>	
Fireworks Mode .....	58	Landscape Mode .....	58
Flash Mode .....	70		
Flash Off 	70		

Language setting ..... 37, 129

## M

Macintosh ..... 141

Macro  ..... 73

Magnify  ..... 97

Manual  ..... 77

Mass Storage Class ..... 137

MediaImpression ..... 140

Memory ..... 87

**MENU** button ..... 43, 45

Miniature Filter ..... 68, 108

Movie ..... 84

Movie button ..... 42

Movie Editing ..... 116

Movie menu ..... 51, 155

Movie SR (Movie Shake

Reduction) Function ..... 86

MSC ..... 137

## N

Natural Skin Tone Mode .... 58

Night Scene Mode ..... 58

Night Scene Portrait

Mode ..... 58

NTSC ..... 131

Number of pixels ..... 75

## O

**OK** button ..... 43, 45

Opening screen ..... 134

Operating the menus ..... 47

Optional accessory ..... 160

## P

PAL ..... 131

Pan Focus **PF** ..... 73

Party Mode ..... 59

Pet Mode ..... 65

Photo processing lab ..... 120

Picture Transfer Protocol

..... 137

Pixel Mapping ..... 135

Playback ..... 89, 90

Playback Mode ..... 136

Playback Mode

Palette ..... 93, 157

Playing back movies ..... 90

Portrait Mode ..... 58

Power Saving ..... 133

Power switch ..... 36, 42, 44

Press fully

(shutter release button) ..... 56

Press halfway

(shutter release button) ..... 56

Product registration ..... 144

Program Mode ..... 61

Protect  ..... 100

PTP ..... 137

## R

Rec. Mode menu ..... 50, 154

Recorded Pixels ..... 75, 86

Recording movies ..... 84

Red-eye Compensation ... 112

Red-eye reduction  ..... 70

Registering menu items .... 82

Reset ..... 136

Resize ..... 105

Retro filter ..... 110

Rotating ..... 96

## S

Saturation ..... 81

Saving as still picture

(movie) ..... 116

Saving pictures by date ... 130

Saving settings ..... 87

Screen effect ..... 95

SD Memory Card ..... 34

Select Time ..... 128

Self-timer ☺	71
Sensitivity	78
Sepia filter	110
Setting menu	52, 156
Shade 🏠	77
Shake Reduction	86
Sharpness	80
Shooting information	21
Shooting mode	57
Shutter release	
button	42, 44, 56
Six-image display 🗪	91
Slideshow	94
Small Face Filter	107
Smile Capture	60, 79
Soft filter	110
Sound settings	124
Sound types	125
Specifications	161
Sport Mode	58
Standard <b>AF</b>	73
Start-up screen	134
Strap	26
Sunset Mode	58
Super Macro 🌸	73
Surf & Snow Mode	58
System requirements	140

<b>T</b>	
Text Mode	67
Time imprint	81
Toy Camera filter	110
Tungsten Light ☀	77
TV	103
Twelve-image display 🗪 ...	91

**U**

USB Connection	137
----------------	-----

**V**

Video output	
format	131, 159
Volume change	90, 124

**W**

Wallpaper	131
White Balance	77
Windows	140
World Time	127

**Z**

Zoom button	42, 44
Zoom <b>T/W</b>	63

# Memo

# Memo

# Memo

**PENTAX RICOH IMAGING CO., LTD.**

2-35-7, Maeno-cho, Itabashi-ku, Tokyo 174-8639, JAPAN  
(<http://www.pentax.jp>)

**PENTAX RICOH IMAGING  
FRANCE S.A.S.  
(European Headquarters)**

112 Quai de Bezons, B.P. 204, 95106 Argenteuil Cedex,  
FRANCE  
(HQ - <http://www.pentax.eu>)  
(France - <http://www.pentax.fr>)

**PENTAX RICOH IMAGING  
DEUTSCHLAND GmbH**

Julius-Vosseler-Strasse 104, 22527 Hamburg,  
GERMANY  
(<http://www.pentax.de>)

**PENTAX RICOH IMAGING  
UK LTD.**

PENTAX House, Heron Drive, Langley, Slough, Berks  
SL3 8PN, U.K.  
(<http://www.pentax.co.uk>)

**PENTAX RICOH IMAGING  
AMERICAS CORPORATION**

633 17th Street, Suite 2600, Denver, Colorado 80202,  
U.S.A.  
(<http://www.pentaximaging.com>)

**PENTAX RICOH IMAGING  
CANADA INC.**

1770 Argentia Road Mississauga, Ontario L5N 3S7,  
CANADA  
(<http://www.pentax.ca>)

**PENTAX RICOH IMAGING  
CHINA CO., LTD.**

23D, Jun Yao International Plaza, 789 Zhaojiabang  
Road, Xu Hui District, Shanghai, 200032, CHINA  
(<http://www.pentax.com.cn>)

<http://www.pentax.jp/english>

- Specifications and external dimensions are subject to change without notice.