

# PENTAX



Digital Camera

## Optio VS 20

### Operating Manual

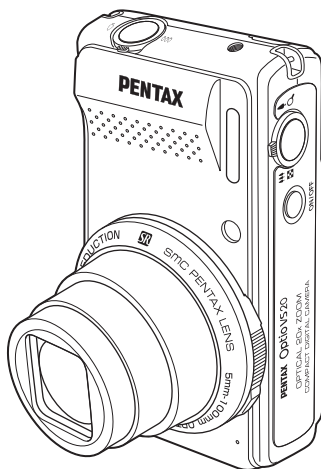

To ensure the best performance from your camera, please read the Operating Manual before using the camera.

Thank you for purchasing this PENTAX Digital Camera.

Please read this manual before using the camera in order to get the most out of all the features and functions. Keep this manual safe, as it can be a valuable tool in helping you to understand all the camera's capabilities.

### **Regarding copyrights**

Images taken with the PENTAX Digital Camera that are for anything other than personal enjoyment cannot be used without permission according to the rights as specified in the Copyright Act. Please take care, as there are cases where limitations are placed on taking pictures even for personal enjoyment during demonstrations, performances or of items on display. Images taken with the purpose of obtaining copyrights also cannot be used outside the scope of use of the copyright as laid out in the Copyright Act, and care should be taken here also.

### **Regarding trademarks**

SDXC Logo is a trademark of SD-3C, LLC.

ArcSoft, and its logo are either the registered trademark or trademark of ArcSoft Inc. in the United States and/or other countries.

Microsoft and Windows are registered trademarks of Microsoft Corporation in the United States and other countries.

Windows Vista is either a registered trademark or trademark of Microsoft Corporation in the United States and/or other countries.

Macintosh and Mac OS are trademarks of Apple Inc., registered in the U.S. and other countries.

This product supports PRINT Image Matching III. PRINT Image Matching enabled digital still cameras, printers and software help photographers to produce images more faithful to their intentions. Some functions are not available on printers that are not PRINT Image Matching III compliant.

Copyright 2001 Seiko Epson Corporation. All Rights Reserved.

PRINT Image Matching is a trademark of Seiko Epson Corporation. The PRINT Image Matching logo is a trademark of Seiko Epson Corporation.

All other brands or product names are trademarks or registered trademarks of their respective companies. In this manual, the ™ and ® marks are not specified.

### **Regarding Product Registration**

In order to serve you better, we request that you complete the product registration, which can be found on the CD-ROM supplied with the camera or the PENTAX website. Thank you for your cooperation.

Refer to chapter 7 for more information.

## To users of this camera

- Do not use or store this device in the vicinity of equipment that generates strong electromagnetic radiation or magnetic fields.  
Strong static charges or the magnetic fields produced by equipment such as radio transmitters could interfere with the monitor, damage the stored data, or affect the product's internal circuitry and cause camera misoperation.
- The liquid crystal panel used in the display is manufactured using extremely high precision technology. Although the level of functioning pixels is 99.99% or better, you should be aware that 0.01% or fewer of the pixels may not illuminate or may illuminate when they should not. However, this has no effect on the recorded image.
- If you point the camera toward an object that is bright, a band of light may appear on the screen display. This phenomenon is referred to as “smear” and is not a malfunction of the camera.
- There is a possibility that the illustrations and the display screen in this manual are different from the actual product.
- In this manual, SD, SDHC, and SDXC Memory Cards are referred to as SD Memory Cards hereafter.
- In this manual, the generic term “computer(s)” refers to either a Windows PC or a Macintosh hereafter.
- In this manual, the term “battery(ies)” refers to any type of batteries used for this camera and accessories.

## USING YOUR CAMERA SAFELY

We have paid close attention to the safety of this product. When using this product, we request your special attention regarding items marked with the following symbols.



### Warning

This symbol indicates that violating this item could cause serious personal injuries.



### Caution

This symbol indicates that violating this item could cause minor or medium personal injuries, or loss of property.

## About the Camera



### Warning

- Do not attempt to take the camera apart or remodel the camera. High voltages are present within the camera, and there is therefore a danger of electric shocks if the camera is taken apart.

- If the inside of the camera should become exposed as a result of, for example, the camera being dropped, please do not under any circumstances touch such exposed portions, as there is a danger of receiving an electric shock.
- Wrapping the strap of the camera around your neck is also dangerous. Please take care that small children do not hang the strap around their necks.
- If the camera emits smoke or a strange smell, or in the event of any other irregularity, stop using the camera immediately, remove the battery and contact your nearest PENTAX Service Center. Continued use of the camera may result in fire or electric shock.

### **Caution**

- Do not place your finger over the flash when discharging the flash. You may burn yourself.
- Do not discharge the flash while it is touching your clothing as there is a risk of discoloring.
- Some portions of the camera heat up during use, so please take care, as there is a risk of low temperature burns if such portions are held for long periods of time.
- Should the screen display be damaged, be careful of glass fragments. Also, be careful not to allow the liquid crystal to get on your skin or in your eyes or in your mouth.
- Depending on your inherent factors or physical condition, the use of the camera may cause itching, rashes or blisters. In case of any abnormality, stop using the camera and get medical attention immediately.

## About the Battery Charger and the AC Adapter

### **Warning**

- Always use the battery charger and AC adapter exclusively developed for this product, with the specified power and voltage. Using a battery charger or AC adapter not exclusive to this product, or using the exclusive battery charger or AC adapter with an unspecified power or voltage can cause a fire, electric shock, or camera breakdown. The specified voltage is 100 - 240V AC.
- Do not disassemble or modify the product. This can cause a fire or electric shock.
- If the generation of smoke or strange odor from the product or other abnormality occurs, immediately discontinue use and consult a PENTAX Service Center. Continuing to use the product can cause a fire or electric shock.

- If water should happen to get inside the product, consult a PENTAX Service Center. Continuing to use the product can cause a fire or electric shock.
- If a thunder storm should occur while using the battery charger or AC adapter, unplug the AC plug (cord) and discontinue use. Continuing to use the product can cause damage to the equipment, fire, or electric shock.
- Wipe off the plug of the AC plug if it becomes covered with dust. Dust on the plug may cause a fire.

### **Caution**

- Do not plug or unplug the AC plug with wet hands. This can cause an electric shock.
- Do not drop the product, or subject it to violent impact. This can cause equipment breakdown.
- Do not use the battery charger to charge a battery other than a rechargeable lithium-ion battery D-LI122. Attempting to charge other types of batteries may cause an explosion, or heating, or may damage the battery charger.
- To reduce the risk of hazards, use only a CSA/UL certified power supply cord set, cord is Type SPT-2 or heavier, minimum NO.18 AWG copper, one end with a molded-on male attachment plug cap (with a specified NEMA configuration), and the other is provided with a molded-on female connector body (with a specified IEC nonindustrial type configuration) or the equivalent.

## About the Battery

### **Warning**

- Be sure to store the battery out of the reach of small children. Placing it in their mouths may cause an electric shock.
- If any leakage from the battery should come in contact with your eyes, it may cause a loss of sight. Flush your eyes with clean water and get medical attention immediately. Do not rub them.

### **Caution**

- Only use the specified battery with this camera. Use of other batteries may cause an explosion or fire.
- Do not disassemble the battery. Disassembling the battery may cause an explosion or leakage.

- Remove the battery from the camera immediately if it becomes hot or begins to smoke. Be careful not to burn yourself during removal.
- Keep wires, hairpins, and other metal objects away from the + and - contacts of the battery.
- Do not short the battery or dispose of the battery in fire. This can cause an explosion or fire.
- If any leakage from the battery should come in contact with skin or clothes, wash the affected areas thoroughly with water.
- Precautions for D-LI122 Battery Usage:  
USE SPECIFIED CHARGER ONLY.
  - DO NOT INCINERATE.
  - DO NOT DISASSEMBLE.
  - DO NOT SHORT CIRCUIT.
  - DO NOT EXPOSE TO HIGH TEMP. (140°F/60°C)RISK OF FIRE AND BURNS. SEE MANUAL.

## Keep the Camera and Accessories Out of the Reach of Small Children

### **Warning**

- Be sure to keep the camera and its accessories out of the reach of small children.
  1. Injuries may result from the product falling or from unexpected movement.
  2. Suffocation may result from wrapping the strap around the neck.
  3. Small accessories such as battery or an SD Memory Card may be swallowed. Seek medical attention immediately if an accessory is accidentally swallowed.

## Care to be Taken During Handling

### Before Using Your Camera

- When traveling, take the Worldwide Service Network listing that is included in the package. This will be useful if you experience problems abroad.
- When the camera has not been used for a long time, confirm that it is still working properly, particularly prior to taking important pictures (such as at a wedding or when traveling). Contents of the recording cannot be guaranteed if recording, playback or transferring your data to a computer, etc. is not possible due to a malfunction of your camera or recording media (SD Memory Card), etc.

## About the Battery and Charger

- Storing the battery fully charged may decrease the battery performance. Avoid storing in high temperatures.
- If the battery is left inserted and the camera is not used for a long time, the battery will over-discharge and shorten the battery's usage span.
- Charging the battery a day before use or on the day of use is recommended.

## Precautions on Carrying and Using Your Camera

- The lens on this camera is not interchangeable. The lens is not removable.
- Do not subject the camera to high temperatures or high humidity. Do not leave the camera in a vehicle, as the temperature can get very high.
- As this camera is not waterproof, do not use the camera where it may come in contact with rain, water or any other liquid.
- Do not subject the camera to strong vibrations, shocks, or pressure. Use a cushion to protect the camera from vibrations of motorcycles, automobiles, or ships. If the camera is subjected to strong vibrations, shocks or pressure, take your camera to your nearest PENTAX Service Center and have it checked.
- The temperature range in which the camera can be used is 0°C to 40°C (32°F to 104°F).
- The monitor may appear black under high temperatures, but will return to normal as temperatures normalize.
- The response speed of the liquid crystal display becomes slow at low temperatures. This is due to the properties of the liquid crystal and is not a fault.
- Sudden temperature changes will cause condensation on the inside and outside of the camera. Place the camera in your bag or a plastic bag, and remove it after temperature of the camera and surroundings are equalized.
- Be careful not to allow dirt, mud, sand, dust, water, toxic gases or salt to enter the camera as this may damage the camera. Wipe away any raindrops or water droplets and allow the camera to dry.
- Please do not press forcefully on the display. This could cause breakage or malfunction.
- Be careful not to sit down with the camera in your back pocket as this may damage the exterior of the camera or the display.
- When using a tripod with the camera, be careful not to overtighten the screw in the tripod socket on the camera.



## Cleaning Your Camera

- Do not clean the product with organic solvents such as thinner, alcohol or benzine.
- Use a lens brush to remove dust accumulated on the lens. Never use a spray blower for cleaning as it may damage the lens.

## Storing Your Camera



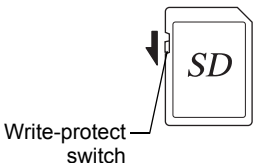

- Do not store the camera with preservatives or chemicals. Storage in high temperatures and high humidity can cause mold to grow on the camera. Remove the camera from its case and store it in a dry and well-ventilated location.
- Avoid using or storing the card where it may be exposed to static electricity or electrical interference.
- Avoid using or storing the card in direct sunlight or where it may be exposed to rapid changes in temperature or to condensation.
- Periodic inspections are recommended every one to two years to maintain high performance.

## Other Precautions

- Please note that deleting data, or formatting the SD Memory Cards or the built-in memory does not completely erase the original data. Deleted files can sometimes be recovered using commercially available software. It is user's responsibility to ensure the privacy of such data.
- The SD Memory Card is equipped with a write-protect switch. Setting the switch to LOCK prevents new data from being recorded on the card, the stored data from being deleted, and the card from being formatted by the camera or computer.   appears on the display when the card is write-protected.
- Care should be taken when removing the SD Memory Card immediately after using the camera, as the card may be hot.
- Keep the battery/card cover closed and do not remove the SD Memory Card or turn the camera off while the data is being played back or saved to the card, or the camera is connected to a computer with the USB cable, as this may cause the data to be lost or the card to be damaged.

- Do not bend the SD Memory Card or subject it to violent impact. Keep it away from water and store away from high temperature.
- Do not remove the SD Memory Card during formatting as this may damage the card and render it unusable.
- The data on the SD Memory Card may be deleted in the following circumstances. We do not accept any liability for data that is deleted
  - (1) when the SD Memory Card is mishandled by the user.
  - (2) when the SD Memory Card is exposed to static electricity or electrical interference.
  - (3) when the SD Memory Card has not been used for a long time.
  - (4) when the SD Memory Card is ejected or the battery is removed while the data on the card is being recorded or accessed.
- If it is not used for a long time, the data on the card may become unreadable. Be sure to regularly make a backup of important data on a computer.
- When using an SD Memory Card with a slow recording speed, recording may stop while you are taking movies even when there is adequate space in the memory, or shooting and playback may take a long time.
- Be sure to format SD Memory Cards that are unused or have been used on another camera. Refer to “Formatting the Memory” (p.176).

# Contents

USING YOUR CAMERA SAFELY .....	1
Care to be Taken During Handling .....	4
Contents .....	8
Composition of the Operating Manual .....	13
<b>Camera Features .....</b>	<b>14</b>
Checking the Contents of the Package .....	17
Names of Parts .....	18
Names of Operating Parts .....	19
Monitor Indications .....	20
<b>Getting Started .....</b>	<b>29</b>
<b>Attaching the Strap .....</b>	<b>30</b>
<b>Powering the Camera .....</b>	<b>31</b>
Charging the Battery .....	31
Installing the Battery .....	32
Using the AC Adapter .....	35
<b>Installing the SD Memory Card .....</b>	<b>37</b>
Number of Images Recordable on an SD Memory Card .....	39
<b>Turning the Camera On and Off .....</b>	<b>40</b>
Starting-up in the Playback Mode .....	41
<b>Initial Settings .....</b>	<b>42</b>
Setting the Display Language .....	42
Setting the Date and Time .....	46
<b>Common Operations .....</b>	<b>49</b>
<b>Understanding the Button Functions .....</b>	<b>50</b>
 Mode .....	50
 Mode .....	52
Switching Between  Mode and  Mode .....	54
<b>Setting the Camera Functions .....</b>	<b>55</b>
Operating the Menus .....	55
Menu List .....	58
<b>Taking Pictures .....</b>	<b>63</b>
<b>Taking Still Pictures .....</b>	<b>64</b>
Taking Pictures .....	64
Setting the Shooting Mode .....	67
Using the Face Detection Function .....	69
Taking Pictures Automatically (Auto Picture Mode) .....	70

Taking Pictures in the Custom Settings (Program Mode) .....	71
Taking Pictures in the Basic Mode (Green Mode).....	72
Using the Zoom .....	74
Taking Pictures of Dark Scenes (Handheld Night Snap/Night Scene Portrait/Night Scene/Sunset/Digital SR/Fireworks Mode) .....	77
Taking Pictures of People (Portrait/Natural Skin Tone Mode).....	78
Taking Pictures of Children (Kids Mode).....	79
Taking Pictures of Your Pet (Pet Mode).....	80
Taking Pictures of Sports and Leisure Activities (Surf & Snow/ Sport Mode) .....	81
Taking Pictures of Text (Text Mode) .....	83
Framing Your Pictures (Frame Composite Mode).....	84
Taking Pictures Using the Filters (Fish-eye/Sketch/Miniature).....	86
Taking Panoramic Pictures (Digital Panorama Mode).....	88
Using the Self-timer .....	90
Taking a Series of Pictures (Continuous Shooting/Burst Shooting/ 16-frame Shooting Mode) .....	92
Taking Pictures Using the Remote Control Unit (Optional) .....	93
Shooting while the Exposure is Automatically Changed (Auto Bracketing) .....	95
<b>Setting the Shooting Functions.....</b>	<b>97</b>
Selecting the Flash Mode .....	97
Selecting the Focus Mode .....	99
Selecting the Recorded Pixels.....	103
Adjusting the White Balance.....	105
Setting the Exposure (EV Compensation).....	107
Correcting the Brightness (D-Range Setting).....	108
Setting the Sensitivity .....	109
Setting the AUTO ISO Range.....	110
Setting the Image Sharpness (Sharpness).....	111
Setting the Color Saturation (Saturation).....	111
Setting the Image Contrast (Contrast).....	112
Setting the Shake Reduction Function .....	112
Registering a Face to be Detected Preferentially .....	113
Switching the Face Detection Function .....	117
Setting the Date Imprint Function .....	118
Setting for Displaying the Electronic Level .....	119
Calling Up a Specific Function.....	120
<b>Recording Movies .....</b>	<b>122</b>
Recording a Movie.....	122
Selecting the Recorded Pixels and Frame Rate for Movies .....	124
Setting the Movie SR (Movie Shake Reduction) Function.....	125
Setting the Screen Effect for Recording a Movie.....	126

<b>Saving the Settings (Memory)</b> .....	<b>128</b>
<b>Playing Back and Deleting Images</b>	<b>131</b>
<hr/>	
<b>Playing Back Images</b> .....	<b>132</b>
Playing Back Still Pictures .....	132
Playing Back a Movie .....	133
Multi-Image Display .....	134
Using the Playback Function .....	136
Slideshow .....	138
Rotating the Image .....	140
Zoom Playback .....	141
<b>Deleting Images</b> .....	<b>142</b>
Deleting a Single Image .....	142
Deleting Selected Images .....	143
Deleting All Images .....	145
Protecting Images from Deletion (Protect) .....	146
<b>Connecting the Camera to AV Equipment</b> .....	<b>149</b>
<b>Editing and Printing Images</b>	<b>151</b>
<hr/>	
<b>Editing Images</b> .....	<b>152</b>
Changing the Image Size (Resize) .....	152
Cropping Images .....	153
Stretching a User-Selected Area of an Image (Stretch Filter) .....	154
Processing Images to Make Faces Look Smaller .....	156
Using the Digital Filters .....	158
Compensating for an Unwanted Red-eye Effect .....	162
Adding a Frame (Frame Composite) .....	163
Editing Movies .....	166
Copying Images .....	168
<b>Setting the Printing Service (DPOF)</b> .....	<b>171</b>
Printing Single Images .....	171
Printing All Images .....	173
<b>Settings</b>	<b>175</b>
<hr/>	
<b>Camera Settings</b> .....	<b>176</b>
Formatting the Memory .....	176
Changing the Sound Settings .....	177
Changing the Date and Time .....	178
Setting the World Time .....	181
Changing the Display Language .....	183
Changing the Naming System of the Folder .....	184
Changing the Video Output Format .....	185

Adjusting the Brightness of the Display .....	186
Using the Power Saving Function .....	187
Setting the Auto Power Off Function .....	188
Changing the Start-up Screen .....	189
Correcting Defective Pixels in the CCD Sensor (Pixel Mapping) .	190
Resetting to Default Settings (Reset) .....	191
<b>Viewing Images on a Computer</b> .....	<b>193</b>
<hr/>	
<b>Setting Up Your Computer</b> .....	<b>194</b>
Provided Software .....	194
System Requirements .....	194
Installing the Software .....	196
Setting the USB Connection Mode .....	199
<b>Connecting to Your Computer</b> .....	<b>201</b>
Connecting the Camera and Your Computer .....	201
Transferring Images .....	202
Disconnecting the Camera from Your Computer.....	205
Starting "Medialmpression" .....	206
Details on How to Use "Medialmpression" .....	207
<b>Appendix</b> .....	<b>209</b>
<hr/>	
<b>Functions Available for Each Shooting Mode</b> .....	<b>210</b>
<b>Messages</b> .....	<b>212</b>
<b>Troubleshooting</b> .....	<b>214</b>
<b>Default Settings</b> .....	<b>216</b>
<b>List of World Time Cities</b> .....	<b>221</b>
<b>Optional Accessories</b> .....	<b>222</b>
<b>Main Specifications</b> .....	<b>223</b>
<b>WARRANTY POLICY</b> .....	<b>227</b>
<b>Index</b> .....	<b>232</b>

In this manual, the method for operating the four-way controller is shown in illustrations, such as in the ones below.

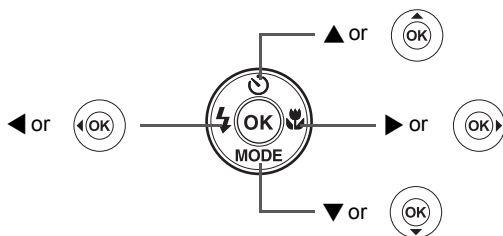

The meanings of the symbols used in this Operating Manual are explained below.

	indicates the reference page number for an explanation of the related operation.
	indicates information that is useful to know.
	indicates precautions to be taken when operating the camera.
mode	This is the mode for capturing still pictures. In this manual, the mode for taking still pictures is referred to as the “Still Picture Capture Mode”.
mode	This is the mode for viewing still pictures and playing back movies.

# Composition of the Operating Manual

This Operating Manual contains the following chapters.

## 1 Getting Started

This chapter explains what you need to do after purchasing the camera before you start taking pictures. Be sure to read it and follow the instructions.

## 2 Common Operations

This chapter explains common operations such as the functions of the buttons and how to use the menus. For more details, refer to the respective chapters below.

## 3 Taking Pictures

This chapter explains the various ways of capturing images and how to set the relevant functions.

## 4 Playing Back and Deleting Images

This chapter explains how to view still pictures and movies on the camera or on a TV and how to delete them from the camera.

## 5 Editing and Printing Images

This chapter explains the various ways of printing still pictures and how to edit images with the camera. For information on transferring images to a computer and installing the provided application software, see "Connecting to Your Computer" in chapter 7. For details on editing and printing images on a computer, see the Help menu of the application software.

## 6 Settings

This chapter explains how to set the camera-related functions.

## 7 Viewing Images on a Computer

This chapter explains how to connect the camera to your computer, install the supplied CD-ROM, etc.

## 8 Appendix

This chapter deals with troubleshooting and lists the optional accessories.

1

2

3

4

5

6

7

8

# Camera Features

In addition to basic picture-taking, the Optio VS20 has a variety of shooting modes to suit different situations. This section describes how to make the most of the key features of your camera. Together with the explanations of camera operations, it will enable you to enjoy your camera to the full.

## Shooting Pictures by Holding the Camera Vertically

The Optio VS20 has a shutter release button and a zoom lever for shooting with the camera held vertically, which enables you to shoot naturally. When you hold the camera vertically, indications on the display are automatically displayed in vertical orientation.

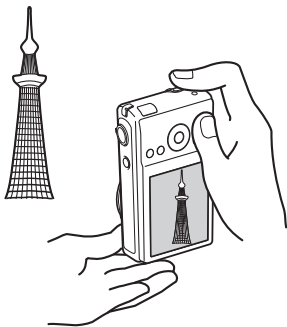

- **A built-in electronic level (p.26) indicates the tilt of the camera.**

## Advanced Movie Recording

The Optio VS20 has a Shake Reduction function to reduce camera shake during movie recording (p.125).

- **Use the camera to shoot fun-filled movies of your children or pets as a visual diary of their development (p.122).**

## Perfect for Portrait Shots!

The Optio VS20 comes with a “Face Detection” function that spots the faces in your shot and automatically adjusts the focus and exposure for the faces. It can detect up to 10 people per shot, so it will help you take perfect group shots too. It will automatically release the shutter when people are smiling, so you can always get the best shot.

- **Face Detection function (p.69)**
- **Modes for taking stunning pictures of people (p.78)**

## Add Various Frames to Your Pictures!

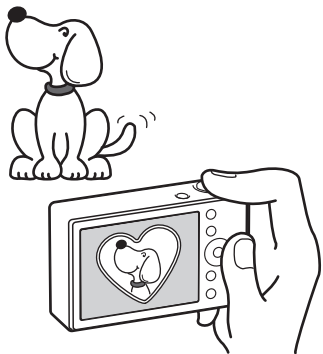

When you take a picture with the Optio VS20, you can choose from a wide range of fun frames to create attractive framed shots (p.84). You can also add frames to pictures you have taken and adjust the position of the subject in the picture or reduce or enlarge the picture size to match the frame shape and size. Now you no longer have to worry about the subject not fitting into the frame (p.163).

- **For decorating your pictures with a frame.**

## Display Images in Calendar Format!

With the Optio VS20, you can display recorded images by date in calendar format (p.135). This lets you quickly find the image you want to play back.

## Easy-to-Navigate Capture and Playback Functions!

The user-friendly design of the Optio VS20 enables easy operation with only a few buttons. Simply by choosing the appropriate icon, you can select the shooting mode (p.67) and choose the optimal settings for the situation, or the playback mode (p.136, p.152) and enjoy the various playback and editing functions. A guide on the display lets you check the functions available in each mode and how to use them.



- **A shooting mode guide is displayed in the Capture Mode Palette and a playback mode guide in the Playback Mode Palette (p.67, p.136).**
- **Use the Green Mode to take pictures easily using standard settings (p.72).**

## A multitude of functions inside the camera for enjoying images without a Computer!

The Optio VS20 has a variety of functions to let you enjoy playing back and editing images without having to connect the camera to your computer and transfer the images first. The camera is all you need to take and edit still pictures and movies (p.152).

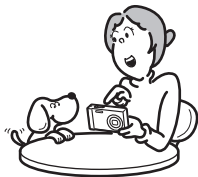

- **Resize (p.152), Cropping (p.153) and Red-eye Compensation (p.162) can be used, while the image is displayed in the playback mode.**
- **You can divide a movie into two or select a frame from a movie to save as a still picture (p.166).**

## Checking the Contents of the Package



Camera  
Optio VS20



Strap  
O-ST122 (\*)

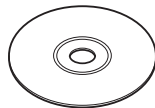

Operating Manuals &  
Software (CD-ROM)  
S-SW122

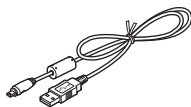

USB cable  
I-USB122 (\*)



Rechargeable lithium-ion  
battery D-LI122 (\*)

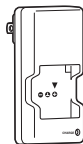

Battery charger  
D-BC122 (\*)



Quick Guide

Items marked with an asterisk (\*) are also available as optional accessories.  
For other optional accessories, refer to "Optional Accessories" (p.222).

## Names of Parts

### Front

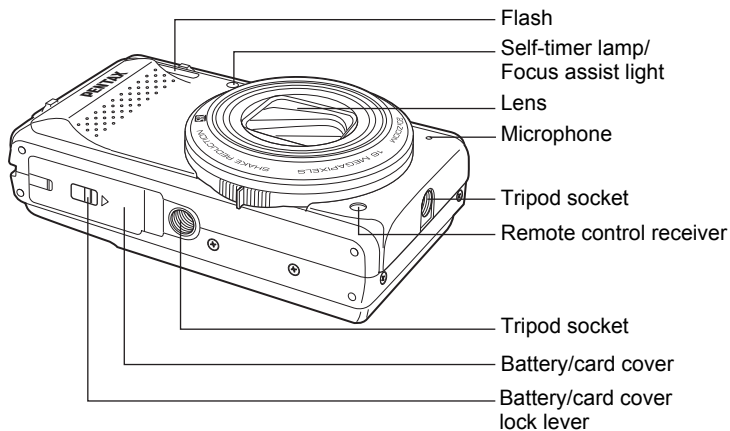

### Back

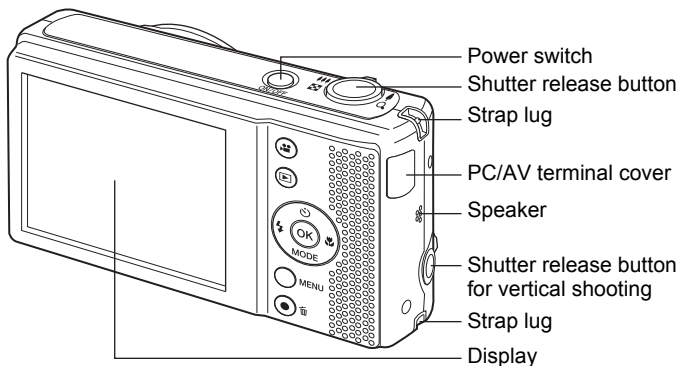

## Names of Operating Parts

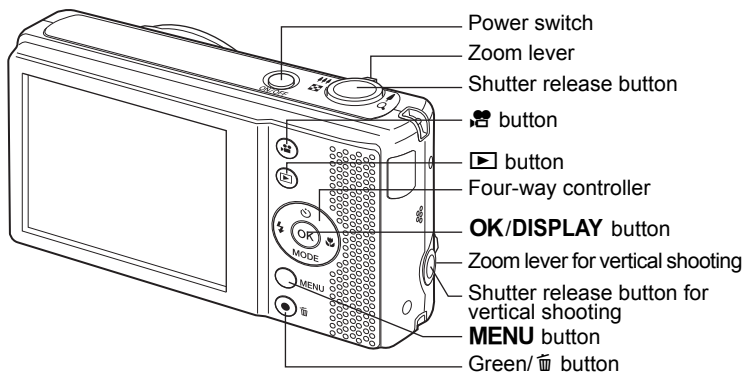

Refer to “Understanding the Button Functions” (p.50) for an explanation of the function of each button.



# Monitor Indications

## Display in Mode

The display shows information such as the camera settings in the capture mode.

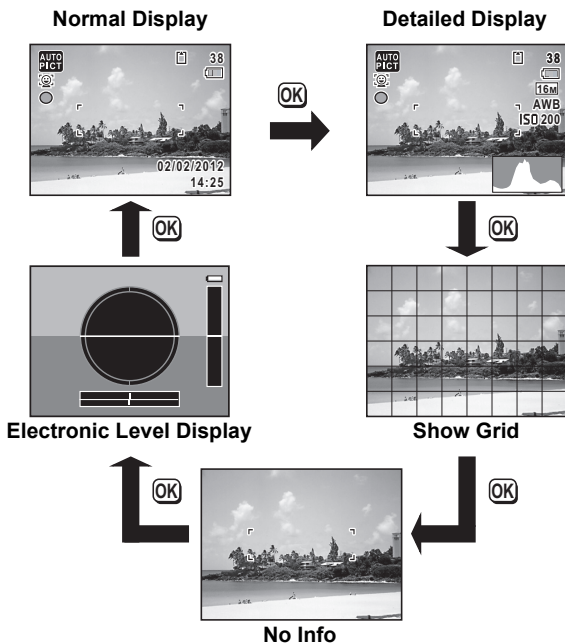
The display changes in the following sequence each time you press the **OK/DISPLAY** button: Normal Display, Detailed Display, Show Grid, No Info, Electronic Level Display, Normal Display.



- When the shooting mode is set to  (Green) mode, the monitor display is as shown on the right. You cannot change the information on the display by pressing the **OK/DISPLAY** button.
- The electronic level display appears only when the electronic level on the [  Rec. Mode] menu is set to  (On) (p.119).



## Normal Display in Still Picture Capture Mode

Horizontal display



Vertical display

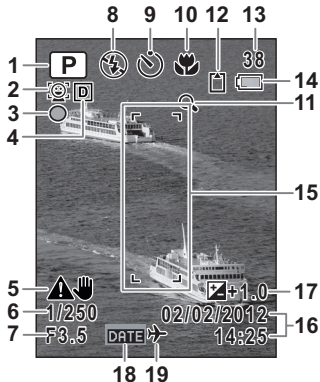

- |                                |  |
|--------------------------------|--|
| 1 Shooting mode (p.67)         | 11 Digital Zoom/Intelligent Zoom icon (p.74) |
| 2 Face Detection icon (p.69)   | 12 Memory status (p.40)                      |
| 3 Tilt icon (p.119)            | 13 Remaining image storage capacity          |
| 4 D-range setting icon (p.108) | 14 Battery level indicator (p.34)            |
| 5 Shake Reduction icon (p.112) | 15 Focus frame (p.64)                        |
| 6 Shutter speed                | 16 Date and time (p.46)                      |
| 7 Aperture                     | 17 EV Compensation (p.107)                   |
| 8 Flash mode (p.97)            | 18 Date Imprint setting (p.118)              |
| 9 Drive mode (p.90)            | 19 World time setting (p.181)                |
| 10 Focus mode (p.99)           |  |

\* 6 and 7 appear only when the shutter release button is pressed halfway.

\* As to 10, when the focus mode is set to **AF** and the Auto-Macro function is activated, the  appears on the display (p.99).

\* Some indications may not appear depending on the shooting mode.

### Switching the Display for Shooting between Vertical and Horizontal Orientation

When you hold the camera vertically for shooting a still picture, the display is automatically switched to vertical orientation.

- When you hold the camera horizontally, you cannot use the shutter release button/zoom lever for vertical shooting.
- While you are recording movies and playing back still pictures/movies, the display is not switched to vertical orientation.

## Detailed Display/No Info Display in Still Picture Capture Mode

A1 to A18 and B1 appear when “Detailed Display” is selected. Only B1 (Focus Frame) appears when “No Info” is selected.

### Horizontal display

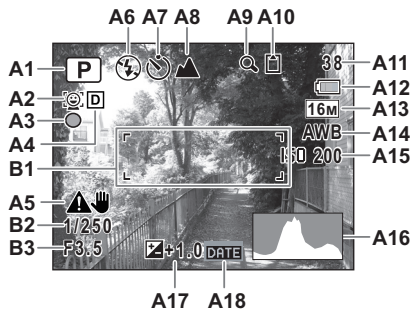

### Vertical display

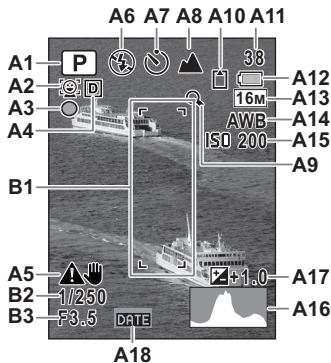

- |   |   |
|---|---|
| <b>A1</b> Shooting mode (p.67)                      | <b>A12</b> Battery level indicator (p.34) |
| <b>A2</b> Face Detection icon (p.69)                | <b>A13</b> Recorded pixels (p.103)        |
| <b>A3</b> Tilt icon (p.119)                         | <b>A14</b> White Balance (p.105)          |
| <b>A4</b> D-range setting icon (p.108)              | <b>A15</b> Sensitivity (p.109)            |
| <b>A5</b> Shake Reduction icon (p.112)              | <b>A16</b> Histogram (p.25)               |
| <b>A6</b> Flash mode (p.97)                         | <b>A17</b> EV Compensation (p.107)        |
| <b>A7</b> Drive mode (p.90)                         | <b>A18</b> Date Imprint setting (p.118)   |
| <b>A8</b> Focus mode (p.99)                         | <b>B1</b> Focus frame (p.64)              |
| <b>A9</b> Digital Zoom/Intelligent Zoom icon (p.74) | <b>B2</b> Shutter speed                   |
| <b>A10</b> Memory status (p.40)                     | <b>B3</b> Aperture                        |
| <b>A11</b> Remaining image storage capacity         |   |

\* B2 and B3 appear only when the shutter release button is pressed halfway.

\* When the shooting mode is **AUTO PICT** (Auto Picture) and if you press the shutter release button halfway, the selected shooting mode appears in A1 even when “No Info” is selected (p.70).

\* Some indications may not appear depending on the shooting mode.

## Display in Mode

The display shows the shooting information of the image in  mode. The display changes in the following sequence each time you press the **OK/DISPLAY** button: Normal Display, Detailed Display, No Info.

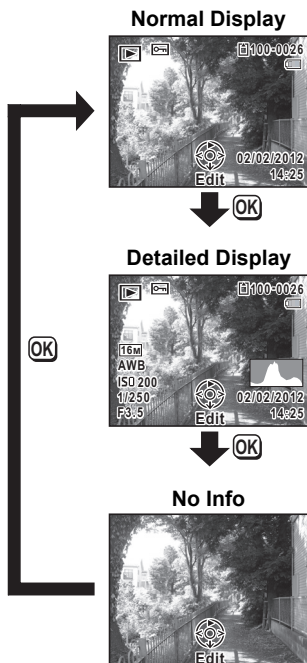

## Normal Display/Detailed Display in Playback Mode

(All of the display items are displayed here for explanatory purposes.)

The display shows information such as the shooting conditions. A1 to A10 appear when “Normal Display” or “Detailed Display” is selected. B1 to B5 appear only when “Detailed Display” is selected.

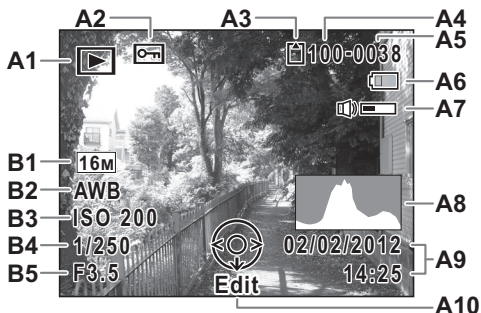





- |   |   |
|---|---|
| <b>A1</b> Playback mode<br>▶: Still Picture Playback Mode (p.136) | <b>A8</b> Histogram (p.25)              |
| <b>A2</b> Protect icon (p.146)                                    | <b>A9</b> Captured date and time (p.46) |
| <b>A3</b> Memory status (p.40)                                    | <b>A10</b> Four-way controller guide    |
| <b>A4</b> Folder number (p.184)                                   | <b>B1</b> Recorded pixels (p.103)       |
| <b>A5</b> File number   | <b>B2</b> White Balance (p.105)         |
| <b>A6</b> Battery level indicator (p.34)                          | <b>B3</b> Sensitivity (p.109)           |
| <b>A7</b> Volume icon   | <b>B4</b> Shutter speed                 |
|   | <b>B5</b> Aperture                      |

- \* In “Normal Display”, A6 and A9 disappear if no operation is performed for two seconds.
- \* A7 appears only when the volume is being adjusted during playback of movies. (p.133)
- \* A10 appears even when “No Info” is selected, but disappears if no operation is performed for two seconds. When no operation is performed for two seconds in “Normal Display” or “Detailed Display”, only “Edit” disappears.

## Guide Indications

A guide indication for each available button/key operation appears as follows on the display during operation.

Four-way controller (▲)	▲
Four-way controller (▼)	▼
Four-way controller (◀)	◀
Four-way controller (▶)	▶
<b>MENU</b> button	

Zoom lever	
<b>OK/DISPLAY</b> button	
Shutter release button	
Green/🗑️ button	

## Using the Histogram

A histogram shows the brightness distribution of an image. The horizontal axis represents brightness (dark at the left and bright at the right) and the vertical axis represents the number of pixels.

The shape of the histogram before and after shooting tells you whether the brightness and contrast are correct or not, and lets you decide if you need to adjust the exposure and take a picture again.

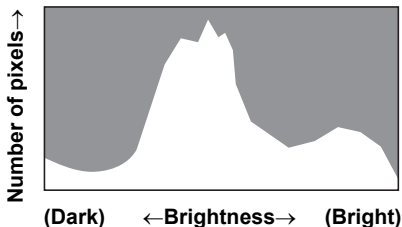

Setting the Exposure (EV Compensation)  p.107

## Understanding Brightness

If the brightness is correct, the graph peaks in the middle. If the image is too dark, the peak is on the left side, and if it is too bright, the peak is on the right side.

**Dark image**

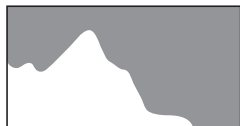

**Correct image**

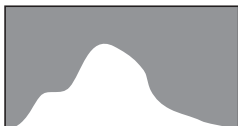

**Bright image**

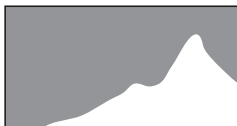

When the image is too dark, the part to the left is cut off (dark portions) and when the image is too bright, the part to the right is cut off (bright portions).

## Understanding Contrast

The graph peaks gradually for images in which contrast is balanced. The graph peaks on both sides but sinks in the middle for images with a large difference in contrast and low amounts of mid-level brightness.

## Electronic level display

This camera is equipped with an electronic level for detecting whether the camera is level. When [Electronic Level] is set to  (On), the electronic level can be displayed by pressing the **OK/DISPLAY** button. A bar graph indicating the horizontal camera angle appears at the bottom of the screen, and a bar graph indicating the vertical camera angle appears on the right side.

### Example:

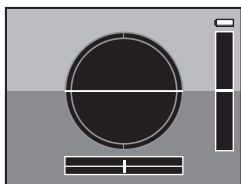

Horizontally and vertically level (green)

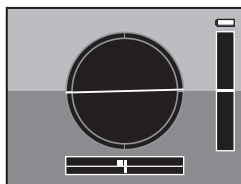

Tilted 1° to the right (yellow)  
Vertically level (green)

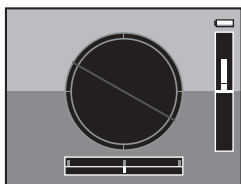

Outside horizontal level display (red)  
Tilted 5° up (red)

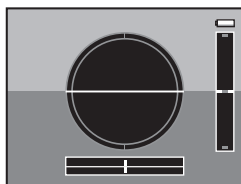

Horizontally level (green)  
Outside vertical level display (red)



If the camera angle cannot be detected, both ends and the center of the bar graphs flash red.

## Memo

# 1 Getting Started

---

<b>Attaching the Strap .....</b>	<b>30</b>
<b>Powering the Camera .....</b>	<b>31</b>
<b>Installing the SD Memory Card .....</b>	<b>37</b>
<b>Turning the Camera On and Off .....</b>	<b>40</b>
<b>Initial Settings .....</b>	<b>42</b>

# Attaching the Strap

Attach the strap (O-ST122) supplied with the camera.

1

Getting Started

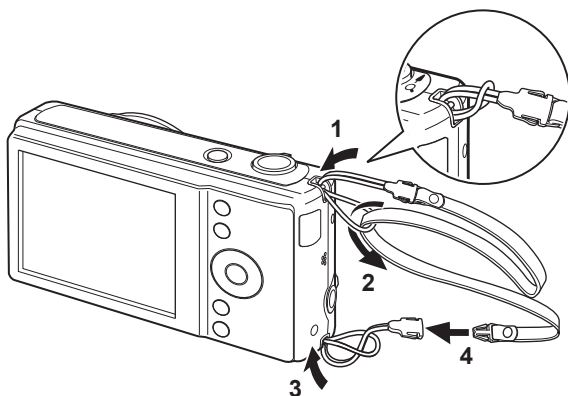

- 1** Pass the thin string of the strap through the strap lug of the camera.
- 2** Pass the other end of the strap through the loop of thin string, and fasten the loop.
- 3** Remove the top at the other end of the strap, and attach it to the other strap lug in the same way.
- 4** Attach the strap to the top attached to the strap lug in Step 3.



The top of the strap can be removed from the strap.

## Charging the Battery

Use the supplied battery charger (D-BC122) to charge the supplied rechargeable lithium-ion battery (D-LI122) before using it in the camera for the first time or after a long period of non-use, or when the [Battery depleted] message appears.

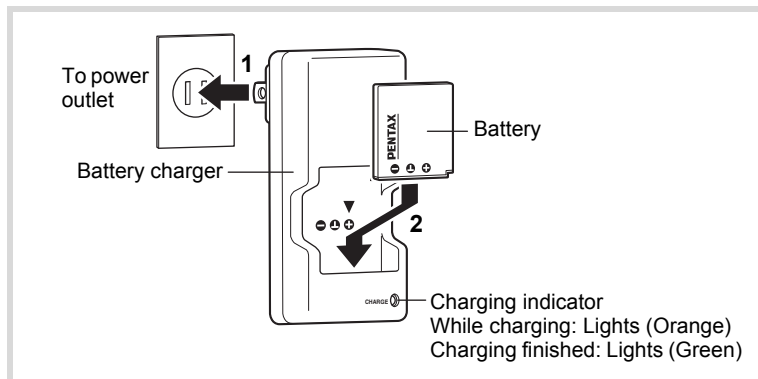

- 1 Plug the AC plug into the power outlet.**
- 2 Place the battery in the battery charger so that the PENTAX logo is facing up.**

The charging indicator lights orange while the battery is charging and lights green when charging is finished.
- 3 Remove the battery from the battery charger when charging is finished.**



- Do not use the supplied battery charger (D-BC122) to charge batteries other than the rechargeable lithium-ion battery D-LI122, as the battery charger may overheat or be damaged.
- The battery has reached the end of its service life when it starts to run down soon after being charged. Replace it with a new battery.
- If the battery is inserted correctly but the charging indicator fails to light, the battery may be faulty. Replace it with a new battery.



The time required to fully charge the battery is about 120 minutes (max.). (The charging time may vary depending on the ambient temperature and charging conditions.) The appropriate ambient temperature for charging the battery is 0°C to 40°C (32°F to 104°F).

## Installing the Battery

Use the rechargeable lithium-ion battery D-LI122 that is provided with the camera. Charge the battery before using it in the camera for the first time.

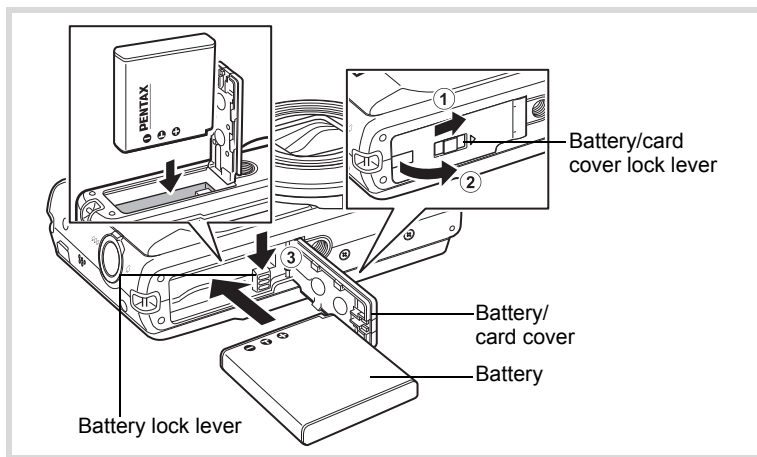

### 1 Open the battery/card cover.

Slide the battery/card cover lock lever in the direction indicated by the arrow ① and flip the cover open ②.

## 2 Press the battery lock lever in the direction of ③ and insert the battery so that the PENTAX logo is facing toward the display.

Match the marks on the battery to the marks inside the battery compartment and push the battery in until it is locked in place.



Make sure that the battery is inserted with the PENTAX logo facing toward the display. If the battery is incorrectly oriented, malfunction may result.

## 3 Close the battery/card cover.

After closing the battery/card cover, slide the cover lock lever in the opposite direction indicated by ①. When you hear a click, the cover is securely closed.

### Removing the Battery

## 1 Open the battery/card cover.

## 2 Press the battery lock lever in the direction of ③.

The battery will be ejected. Take care not to drop the battery when removing it.



- This camera uses a rechargeable lithium-ion battery D-LI122. Use of any other type of battery may damage the camera and cause a malfunction.
- Insert the battery correctly. If the battery is incorrectly oriented, malfunction may result.
- Do not remove the battery while the camera is turned on.
- When storing the battery for more than 6 months, charge the battery for 30 minutes using the battery charger and store the battery separately.  
Be sure to recharge the battery every 6 to 12 months. Storing the battery at or below room temperature is ideal. Avoid storing it at high temperature.
- The date and time may be returned to the default setting if the camera is left without the battery for a long time.
- Be careful as the camera or the battery may become hot when the camera is used continuously for a long period of time.



Use the AC adapter kit K-AC122 (optional) if you intend to use the camera for a long time. (p.35)

## Recordable Image No., Movie Recording Time, and Playback Time (at 23°C with the display on and the battery fully charged)

Recordable Image No.* <sup>1</sup> (flash used for 50% of shots)	Movie Recording Time* <sup>2</sup>	Playback Time* <sup>2</sup>
Approx. 200 pictures	Approx. 100 min.	Approx. 180 min.

\*1 Recording capacity shows approximate number of shots recorded during CIPA-compliant testing (with display on, flash used for 50% of the shots, and 23 degrees centigrade). Actual performance may vary according to operating conditions.

\*2 According to the result of in-house testing.



- In general, battery performance may temporarily deteriorate as the temperature decreases.
- Be sure to take a spare battery with you when traveling abroad or to a cold region, or if you intend to take a lot of pictures.

## Battery Level Indicator

You can check the battery level by the indicator on the display.

Screen Display	Battery Status
(green)	Adequate power remains.
(green)	Battery is running low.
(yellow)	Battery is running very low.
(red)	Battery is exhausted.
[Battery depleted]	The camera will turn off after this message appears.

## Using the AC Adapter

Use of the AC adapter kit K-AC122 (optional) with a household power supply is recommended if you intend to use the camera for a long time or connect it to a computer.

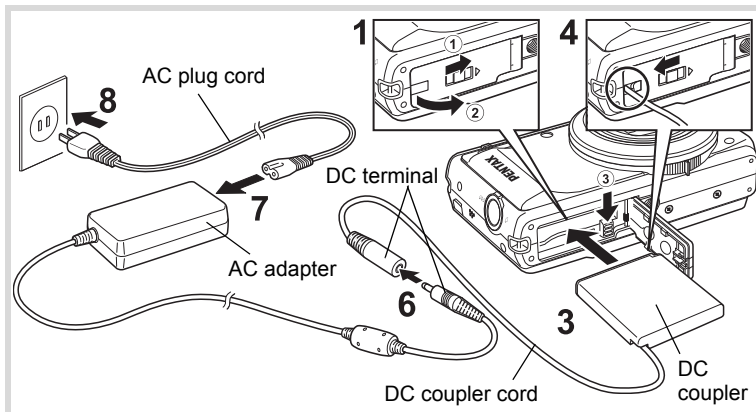

- 1** Make sure that the camera is turned off and open the battery/card cover.
- 2** Remove the battery.  
Refer to p.32 - p.33 on how to open/close the battery/card cover and remove the battery.
- 3** Insert the DC coupler while holding down the battery lock lever.  
Confirm the DC coupler is locked in place.
- 4** Extract the DC coupler cord.  
Pull out the tab at the joint of the camera and the battery/card cover so that the DC coupler cord is extracted from there.
- 5** Close the battery/card cover.

- 6** Connect the DC terminal of the AC adapter to the DC terminal of the DC coupler.
- 7** Connect the AC plug cord to the AC adapter.
- 8** Plug the AC plug cord into the power outlet.



- Make sure that the camera is turned off before connecting or disconnecting the AC adapter.
- Make sure that the AC plug cord and the DC terminal connecting the AC adapter to the camera are inserted securely. Data may be lost if either becomes disconnected while data is being recorded on the SD Memory Card or the built-in memory.
- Use the AC adapter with due care to avoid fire or electric shock. Be sure to read “About the Battery Charger and the AC Adapter” (p.2) before using the AC adapter.
- Be sure to read the operation manual accompanying the AC adapter kit K-AC122 before using the adapter.
- When connecting the AC adapter, you cannot set the camera upright on the table because the cord from the DC coupler comes out of the bottom of the camera. Additionally, do not place the camera with the lens facing down because the lens extends when the camera turns on. Hold the camera in your hand or use a tripod when using the AC adapter.

# Installing the SD Memory Card

This camera uses an SD Memory Card, an SDHC Memory Card, or an SDXC Memory Card. (All cards are referred to as SD Memory Cards hereafter.) Captured images are saved on the SD Memory Card if a card is inserted in the camera. They are saved in the built-in memory if a card is not inserted (p.40).



- Be sure to use this camera to format (initialize) an SD Memory Card that is unused or has been used in other cameras or digital devices. Refer to "Formatting the Memory" (p.176) for instructions on formatting.
- Make sure that the camera is turned off before inserting or removing the SD Memory Card.



The still picture storage capacity varies depending on the capacity of the SD Memory Card and the selected number of recorded pixels (p.39).

## Backing Up Data

The camera may not be able to access data in the built-in memory in the case of a malfunction. Use a computer or other device to back up important data in another location.

Read the precautions on handling the SD Memory Card  p.6

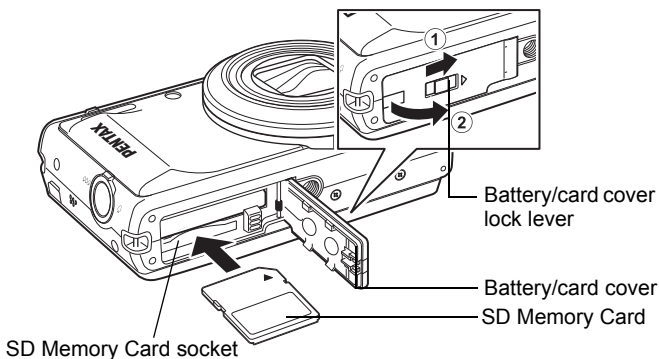

### 1 Open the battery/card cover.

Slide the battery/card cover lock lever in the direction indicated by the arrow ① and flip the cover open ②.

### 2 Insert the SD Memory Card into the SD Memory Card socket so that the label is facing toward the lens of the camera.

Push the card in until it clicks. Data may not be recorded correctly if the card is not inserted all the way.

### 3 Close the battery/card cover.

After closing the battery/card cover, slide the cover lock lever in the opposite direction indicated by ①. When you hear a click, the cover is securely closed.

## To Remove the SD Memory Card

### 1 Open the battery/card cover.

### 2 Push the card into the SD Memory Card socket to eject it.

Pull the card out.

## Number of Images Recordable on an SD Memory Card

The file sizes of the recorded images vary depending on the number of recorded pixels of the images, so the number of images that can be saved on an SD Memory Card also varies.

Choose the appropriate number of recorded pixels for still pictures on the [📷 Rec.Mode] menu.

Selecting the Recorded Pixels 📷p.103

Choose the appropriate number of recorded pixels for movies on the [🎬 Movie] menu.

Selecting the Recorded Pixels and Frame Rate for Movies 🎬p.124

For an approximate guide to the number of images or the length of recorded movies that can be saved on an SD Memory Card, see “Main Specifications” (p.223).

# Turning the Camera On and Off

1

Getting Started

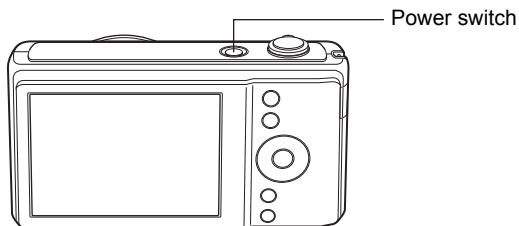

## 1 Press the power switch.

The camera turns on and the display turns on.

When you turn the camera on, the lens cover opens and the lens extends.

If the [Language/言語] screen or [Date Adjustment] screen appears when you turn the camera on, follow the procedure on p.42 to set the display language and/or current date and time.

## 2 Press the power switch again.

The display turns off, the lens closes, and the camera turns off.

Taking Still Pictures p.64

## Checking the Memory Card

The memory card is checked when the camera turns on and the memory status is displayed.

- : The SD Memory Card is inserted.  
Images will be saved on the SD Memory Card.
- : The SD Memory Card is not inserted.  
Images will be saved in the built-in memory.

Memory status



-  : The write-protect switch on the SD Memory Card is in the LOCK position (p.6). Images cannot be recorded.

## Starting-up in the Playback Mode

Use this mode when you want to play back an image straightaway without taking any pictures.

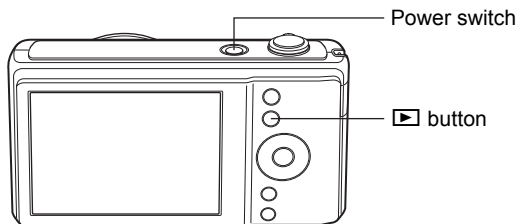

### 1 Press the power switch while holding down the ▶ button.

The display turns on with the lens retracted and the camera turns on in the playback mode.



To switch from the playback mode to the capture mode, press the ▶ button or press the shutter release button halfway.

Playing Back Still Pictures  p.132

# Initial Settings

The [Language/言語] screen appears when the camera is turned on for the first time. Perform the operations in “Setting the Display Language” below to set the language, and in “Setting the Date and Time” (p.46) to set the current date and time.

Language, Date, and Time can be changed later. Refer to the pages below for instructions.

- To change the language, follow the steps in “Changing the Display Language” (p.183).
- To change the date and time, follow the steps in “Changing the Date and Time” (p.178).

## Setting the Display Language

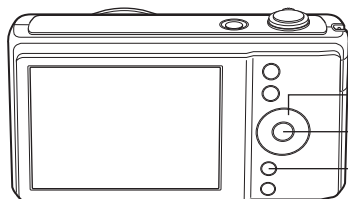

- 1 Use the four-way controller (▲▼◀▶) to choose the desired display language.

Language/言語		
English	日本語	Türkçe
Français	Dansk	Ελληνικά
Deutsch	Svenska	Русский
Español	Suomi	ไทย
Português	Polski	한국어
Italiano	Čeština	中文繁體
Nederlands	Magyar	中文简体
MENU/Cancel		OK/OK

## 2

### Press the **OK** button.

The [Initial Setting] screen appears in the selected language. If the desired settings for [Hometown] and [DST] (Daylight Saving Time) appear, press the four-way controller (▼) twice to select [Settings complete] and press the **OK** button to display the [Date Adjustment] screen. Go to “Setting the Date and Time” (p.46).

Go to Step 3 in “To Set Hometown and DST” (p.45) if the desired settings do not appear.

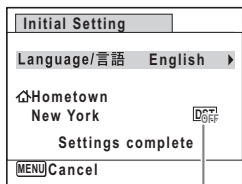

Daylight saving time

If you accidentally select another language and go to the next procedure, perform the following operation to set the language back.

● **When Another Language Has Been Inadvertently Selected**

- 1 Press the four-way controller (▶).**
- 2 Use the four-way controller (▲ ▼ ◀ ▶) to select the language and press the OK button.**

The [Initial Setting] screen appears in the selected language.

● **When the Screen After Step 2 Appears in Another Language**

- 1 Press the OK button.**
- 2 Press the MENU button.**
- 3 Press the four-way controller (▶).**
- 4 Use the four-way controller (▼ ▲) to select [Language/言語].**
- 5 Press the four-way controller (▶).**  
The [Language/言語] screen appears.
- 6 Use the four-way controller (▲ ▼ ◀ ▶) to select the language.**
- 7 Press the OK button.**

The [↖ Setting] menu appears in the selected language.

The language is now switched to your desired language. To reset [Hometown], [Date] and [Time], refer to the pages below for instructions.

- To change [Hometown], follow the steps in “Setting the World Time” (☞p.181).
- To change the [Date] and [Time], follow the steps in “Changing the Date and Time” (☞p.178).

## To Set Hometown and DST

- 3** Press the four-way controller (▼).

The frame moves to [Hometown].

- 4** Press the four-way controller (▶).

The [Hometown] screen appears.

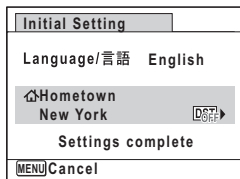

- 5** Use the four-way controller (◀▶) to choose a city.

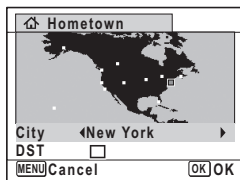

- 6** Press the four-way controller (▼).

The frame moves to [DST] (Daylight Saving Time).

- 7** Use the four-way controller (◀▶) to select  (On) or  (Off).

- 8** Press the OK button.

The [Initial Setting] screen appears.

- 9** Press the four-way controller (▼) to select [Settings complete].

- 10** Press the OK button.

The [Date Adjustment] screen appears. Next, set the date and time.

## Setting the Date and Time

Set the current date and time and the display style.

### 1 Press the four-way controller (▶).

The frame moves to [mm/dd/yy].

### 2 Use the four-way controller (▲▼) to choose the date format.

Choose from [mm/dd/yy], [dd/mm/yy] or [yy/mm/dd].

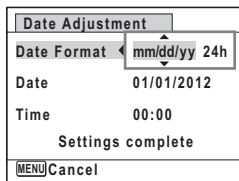

### 3 Press the four-way controller (▶).

The frame moves to [24h].

### 4 Use the four-way controller (▲▼) to select [24h] (24-hour display) or [12h] (12-hour display).

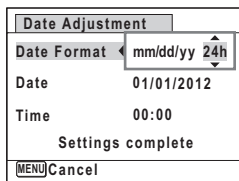

### 5 Press the four-way controller (▶).

The frame returns to [Date Format].

### 6 Press the four-way controller (▼).

The frame moves to [Date].

### 7 Press the four-way controller (▶).

The frame moves to the month.

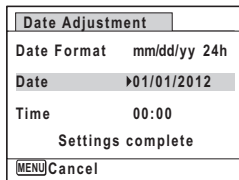

## 8 Use the four-way controller (▲▼) to change the month.

Change the day and year in the same manner.

Next, change the time.

If you selected [12h] in Step 4, the setting switches between am and pm corresponding to the time.

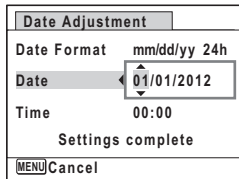

## 9 Press the four-way controller (▼) to select [Settings complete].

## 10 Press the OK button.

The setting is saved and the camera returns to capture status.

[Language/言語], [Date], [Time], [Hometown], and [DST] can be changed. Refer to the pages below for instructions.

- To change the language, follow the steps in “Changing the Display Language” (p.183).
- To change the date and time, follow the steps in “Changing the Date and Time” (p.178).
- To change the city or turn DST on and off, follow the steps in “Setting the World Time” (p.181).



When the [Initial Setting] or [Date Adjustment] screen is displayed, you can cancel the setting operation and switch to the capture mode by pressing the **MENU** button. In this case, the [Initial Setting] screen will appear next time you turn the camera on.



If you press the **OK** button in Step 10, the camera clock is reset to 00 seconds. To set the exact time, press the **OK** button when the time signal (on the TV, radio, etc.) reaches 00 seconds.

The video output format (NTSC/PAL) is set to the format of the city selected in [Hometown] on the [Initial Setting] screen. Refer to “List of World Time Cities” (p.221) for the video output format of each city that is set at the time of the initial setting, and “Changing the Video Output Format” (p.185) for changing the video output format.

## Memo

# **2 Common Operations**



---

<b>Understanding the Button Functions .....</b>	<b>50</b>
<b>Setting the Camera Functions .....</b>	<b>55</b>

# Understanding the Button Functions

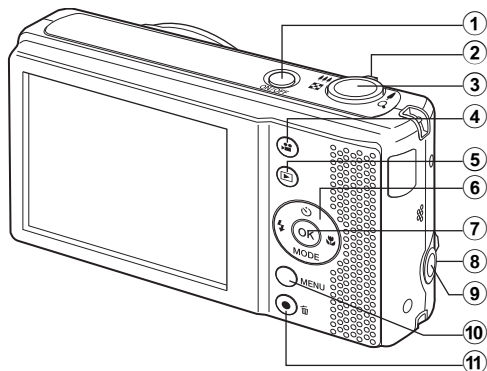
## Mode



- 1 Power switch**  
Turns the camera on and off (p.40).
- 2 Zoom lever**  
Changes the captured area (p.74).
- 3 Shutter release button**  
Focuses the camera on the subject when pressed halfway in Still Picture Capture Mode (except in **▲** and **MF** modes).  
Takes a still picture when pressed down fully (p.65).
- 4  button**  
Starts and stops movie recording (p.122)
- 5  button**  
Switches to the  mode (p.54).

**⑥ Four-way controller**

- (▲) Changes the drive mode (p.90).
- (▼) Displays the Capture Mode Palette (p.67).
- (◀) Changes the flash mode (p.97).
- (▶) Changes the focus mode (p.99).

**⑦ OK/DISPLAY button**

Changes the information on the display (p.20).

**⑧ Zoom lever for vertical shooting**

Used as a zoom lever when you hold a camera vertically.  
The function is the same as with ② zoom lever.

**⑨ Shutter release button for vertical shooting**

Used as a shutter release button when you hold a camera vertically.  
The function is the same as with ③ shutter release button.

**⑩ MENU button**

Displays the [📷 Rec.Mode] menu (p.55).

**⑪ Green button**

Switches to ● (Green) mode (p.72).  
Calls up the assigned function (p.120).

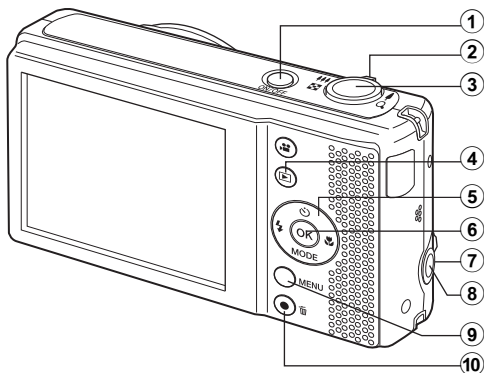

- ① **Power switch**  
Turns the camera on and off (p.40).
- ② **Zoom/📷/🔍 lever**  
Turn to the left (📷) during single-image display to change to four-image display. Changes to nine-image display when turned to the left again. Returns to the previous display when turned to the right (🔍) (p.134). Enlarges the image when turned to the right (🔍) during single-image display. Returns to the previous display when turned to the left (📷) (p.141).  
Turn to the left (📷) during nine-image display to change to folder or calendar display (p.135).  
Turn to the right (🔍) during folder/calendar display to change to nine-image display (p.135).  
Adjusts the volume during playback of movies (p.133).
- ③ **Shutter release button**  
Switches to 📷 mode (p.54).
- ④ **▶ button**  
Switches to 📷 mode (p.54).



## ⑤ Four-way controller

- (▲) Plays back and pauses a movie (p.133).
- (▼) Displays the Playback Mode Palette (p.136).  
Stops a movie during playback (p.133).
- (◀▶) Displays the previous or next image during single-image display (p.132).  
Frame forwards, frame reverses, plays back in reverse, plays back normally, plays back in fast-forward, and plays back in reverse fast-forward when playing back movies (p.133).
- (▲▼◀▶) Moves the display area during zoom display (p.141).  
Selects an image in four-image/nine-image display, a folder in folder display, and a date in calendar display (p.134).  
Moves the image when using the Frame Composite function (p.163).

## ⑥ OK/DISPLAY button

- Changes the information on the display (p.20).
- Returns zoom display or four-image/nine-image display to single-image display (p.134, p.141).
- Changes to nine-image display of the selected folder during folder display (p.135).
- Changes to single-image display of the selected date during calendar display (p.135).

## ⑦ Zoom//Q lever for vertical shooting

- Used as a zoom//Q lever when you hold a camera vertically.
- The function is the same as with ② zoom//Q lever.

## ⑧ Shutter release button for vertical shooting

- Switches to  mode.
- The function is the same as with ③ shutter release button.

## ⑨ MENU button



- Displays the [ Setting] menu during single-image display (p.55).
- Returns to single-image display during Playback Mode Palette display (p.136).
- Returns zoom display or four-image/nine-image display to single-image display (p.134).
- Changes to nine-image display of the selected folder during folder display (p.135).
- Changes to nine-image display of the selected date during calendar display (p.135).

## ⑩ Green/ button

- Switches from single-image display to the Delete screen (p.142).
- Switches from four-image/nine-image display to the Select & Delete screen (p.143).

Switches from folder display to the calendar display screen (p.135).  
Switches from calendar display to the folder display screen (p.135).  
Saves the paused frame as a single image during the playback of a series of successive images taken with 16-frame shooting function. (p.134)

## Switching Between Mode and Mode

In this manual, the capture mode, such as for taking still pictures, is referred to as “ mode” (the capture mode). The playback mode, such as for displaying captured images on the display, is referred to as “ mode” (the playback mode). In  mode, you can perform simple editing operations on the images that are played back.

Follow the procedure below to switch between  mode and  mode.

### To Switch from Mode to Mode

#### 1 Press the button.

The camera switches to  mode.

### To Switch from Mode to Mode

#### 1 Press the button or the shutter release button halfway.

The camera switches to  mode.

### Displaying data stored in the built-in memory

When an SD Memory Card is inserted in the camera, images and movies on the SD Memory Card are displayed. If you want to display images and movies in the built-in memory, turn the camera off and remove the SD Memory Card.



Make sure that the camera is turned off before removing the SD Memory Card.

# Setting the Camera Functions

To change the camera settings, press the **MENU** button to display the menu screens. Functions for playing back and editing images are called up from the Playback Mode Palette (p.136).

## Operating the Menus

There are three menus available with the camera: [📷 Rec. Mode], [🎥 Movie], and [⚙️ Setting].

Press the **MENU** button in 📷 mode to display the [📷 Rec. Mode] menu. Press the **MENU** button in 🎥 mode to display the [⚙️ Setting] menu. Use the four-way controller (◀▶) or zoom lever (🌲/🌲) to switch between the menus.

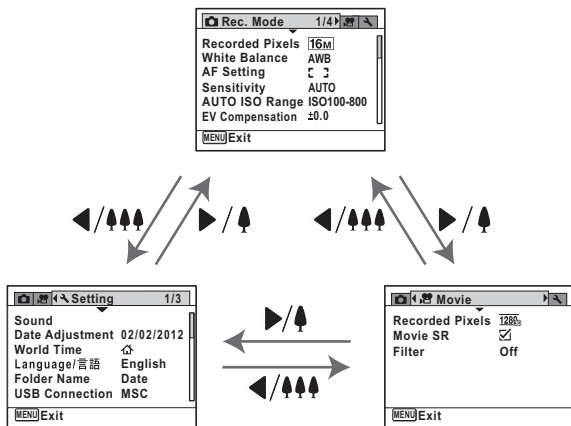

Available button operations appear on the display during menu operation (p.25).

Ex.) To set the [Focusing Area] on the [Rec.Mode] menu

**1 Press the MENU button in camera mode.**

The [Rec.Mode] menu appears.

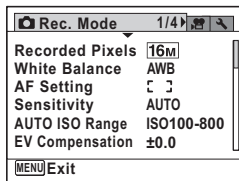

**2 Press the four-way controller (▼).**

The frame moves to [Recorded Pixels].

**3 Press the four-way controller (▼) twice.**

The frame moves to [AF Setting].

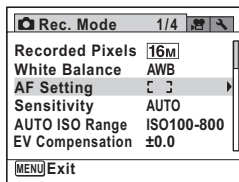

**4 Press the four-way controller (▶).**

The [AF Setting] screen appears.

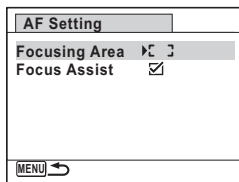

**5 Press the four-way controller (▶).**

A pull-down menu appears with the items that can be selected.

The pull-down menu displays only those items that can be selected with the current camera settings.

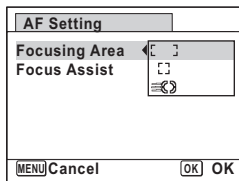

**6 Use the four-way controller (▲▼) to change the setting.**

The focusing area changes each time the four-way controller (▲▼) is pressed.

## 7 Press the **OK** button or the four-way controller (◀).

The setting is saved and then the camera is ready for setting the other functions. To exit the settings, press the **MENU** button.

To use another operation, refer to the following alternate Step 7 options.

### To Save the Setting and Start Taking Pictures

## 7 Press the shutter release button halfway.

The setting is saved and the camera returns to capture status. When the shutter release button is pressed fully, the picture is taken.



When the [ Setting] menu is displayed from mode, you can switch to mode by pressing the button.

### To Save the Setting and Start Playback of Images

## 7 Press the button.

When the [ Rec.Mode] menu is displayed from mode, the setting is saved and the camera returns to playback status.

### To Cancel the Changes and Continue with Menu Operations

## 7 Press the **MENU** button.

The changes are canceled and the screen returns to Step 3.



The **MENU** button function differs depending on the screen. Refer to the guide indications.

Exit : Exits the menu and returns to the original screen.

: Returns to the previous screen with the current setting.

Cancel : Cancels the current selection, exits the menu and returns to the previous screen.

## Menu List

This displays the items that can be set with the menus and provides descriptions of each item. See the list of default settings in the Appendix “Default Settings” (p.216) to check whether the settings are saved when the camera is turned off and whether the settings return to the defaults when the camera is reset.

### [Rec.Mode] Menu

Item	Description	Page	
Recorded Pixels	For choosing the number of recorded pixels of still pictures	p.103	
White Balance	For adjusting the color balance according to the light conditions	p.105	
AF Setting	Focusing Area	For changing the autofocus area	p.101
	Focus Assist	For setting whether to use the focus assist light	p.102
Sensitivity	For setting the sensitivity	p.109	
AUTO ISO Range	For setting the adjustment range when sensitivity is set to AUTO	p.110	
EV Compensation	For adjusting the overall brightness of the picture	p.107	
D-Range Setting	Highlight Correction	Adjusts the bright areas when the image is too bright	p.108
	Shadow Correction	Adjusts the dark areas when the image is too dark	
Shake Reduction	For setting Shake Reduction when taking still pictures.	p.112	
Face Recall	For registering a face to be detected preferentially	p.113	
Face Detection	For choosing whether to use the Face Detection function to spot the faces in your shot and to automatically adjust the focus and exposure for the faces	p.117	
Blink Detection	For choosing whether to use the Blink Detection function when the Face Detection function is activated	p.118	
Digital Zoom	For choosing whether to use the Digital Zoom function	p.76	
Memory	For choosing whether to save the set values of the shooting function or return to the defaults when the camera is turned off	p.128	
Green Button	For assigning a function to the Green button so that you can go straight to it in  mode	p.120	
Sharpness	For choosing sharp or soft outlines	p.111	
Saturation	For setting the color saturation	p.111	

Contrast	For setting the image contrast level	p.112
Date Imprint	For choosing whether to imprint the date and/or time when taking still pictures	p.118
Electronic Level	For choosing whether to display the electronic level for detecting the tilt of the camera.	p.119

### ● [📷 Rec. Mode] Menu 1

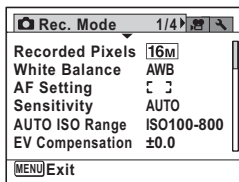

### ● [📷 Rec. Mode] Menu 2

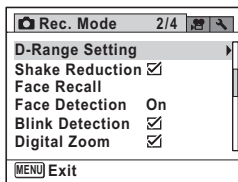

### ● [📷 Rec. Mode] Menu 3

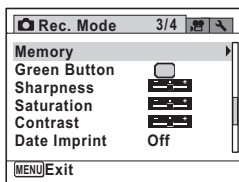

### ● [📷 Rec. Mode] Menu 4

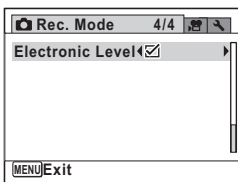

- Use **●** (Green) mode to enjoy easy picture-taking using standard settings, regardless of the settings in the [📷 Rec.Mode] menu (p.72).
- Assigning a frequently used function to the Green button enables you to go straight to the desired function (p.120).

## [🎥 Movie] Menu

Item	Description	Page
Recorded Pixels	For choosing the number of recorded pixels of movies	p.124
Movie SR	For choosing whether to use the Movie Shake Reduction function	p.125
Filter	For setting a screen effect in movie recording	p.126

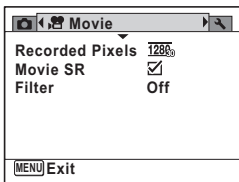

## [ Setting] Menu

Item	Description	Page
Sound	For adjusting the operation volume and playback volume, and setting the start-up sound, shutter sound, key operation sound and self-timer sound	p.177
Date Adjustment	For adjusting the date and time	p.178
World Time	For setting the Hometown and Destination	p.181
Language/言語	For setting the language in which menus and messages appear	p.183
Folder Name	For choosing how names are assigned to folders for storing images	p.184
USB Connection	For setting the method for connecting to a computer (MSC or PTP).	p.199
Video Out	For setting the output format to AV equipment	p.185
Brightness Level	For changing the brightness of the display	p.186
Power Saving	For setting the time until the camera enters power-saving mode	p.187
Auto Power Off	For setting the time until the camera turns off automatically	p.188
Reset	For returning settings other than the date and time, language, world time and video out to their defaults	p.191
Delete all	For deleting all images at once.	p.145
Pixel Mapping	For mapping out and correcting any defective pixels in the CCD sensor	p.190
Format	For formatting the SD Memory Card/built-in memory.	p.176

- [**Setting**] Menu 1



- [**Setting**] Menu 2

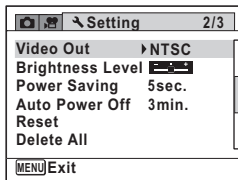

- [**Setting**] Menu 3

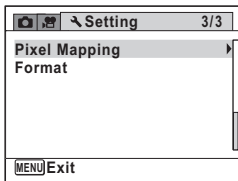

## Memo

# **3 Taking Pictures**

---

<b>Taking Still Pictures .....</b>	<b>64</b>
<b>Setting the Shooting Functions .....</b>	<b>97</b>
<b>Recording Movies .....</b>	<b>122</b>
<b>Saving the Settings (Memory) .....</b>	<b>128</b>

# Taking Still Pictures

## Taking Pictures

The Optio VS20 features a wide range of shooting modes and functions to suit almost any subject or scene. This chapter describes how to take pictures with the most commonly used standard settings (the factory default settings).

3

Taking Pictures

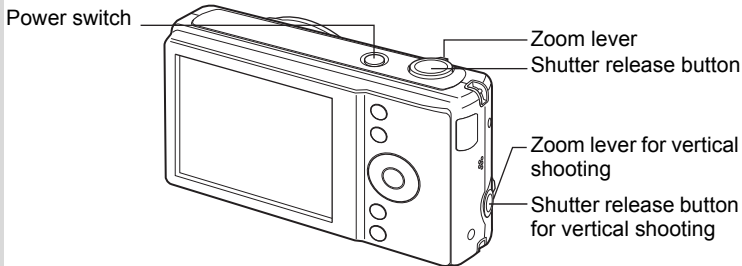

### 1 Press the power switch.

The camera turns on and is ready to take still pictures. In this manual, this is called Still Picture Capture Mode.

### 2 Confirm the subject and shooting information on the display.

The focus frame in the middle of the display indicates the zone of automatic focusing.

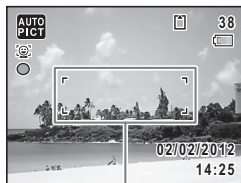

Focus frame

When the camera detects a face, the Face Detection function is activated and the face detection frame appears (p.69).

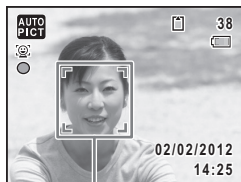

Face detection frame

When you hold the camera vertically, indications on the display are automatically displayed in vertical orientation. Use the shutter release button/zoom lever for vertical shooting. (In this manual, they are generally described as the shutter release button/zoom lever.)



- When you hold the camera horizontally, you cannot use the shutter release button/zoom lever for vertical shooting.
- While you are recording movies and playing back still pictures/movies, the display is not switched to vertical orientation.



You can change the captured area by turning either of the two zoom levers to the left or right (p.74).

▲ (Right)	Enlarges the subject.
▲▲▲ (Left)	Widens the area that is captured by the camera.

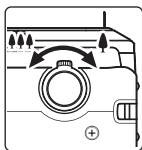
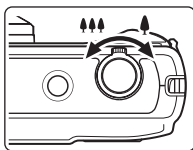

### 3

#### Press the shutter release button halfway.

The camera emits focus assist light in dark shooting situations.

The focus frame (or face detection frame) on the display turns green when the camera focuses on the subject at the correct distance.

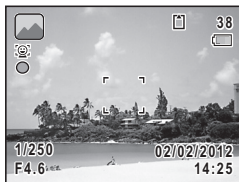

### 4

#### Press the shutter release button fully.

The picture is taken.

The flash discharges automatically depending on the light conditions. The captured image appears on the display (Instant Review) and is saved to the SD Memory Card or the built-in memory.



Press the Green button to switch to  (Green) mode and let the camera set all the shooting functions automatically (p.72).

## Using the Shutter Release Button

The shutter release button works in a two-step action as follows.

### Press halfway

This refers to pressing the shutter release button gently to the first position. This locks the focus setting and the exposure. The green focus

frame lights on the display when the shutter release button is pressed halfway and the subject is in focus. If the subject is out of focus, the frame turns white.

### Press fully

This refers to pressing the shutter release button all the way down to the fully depressed position. This takes a picture.

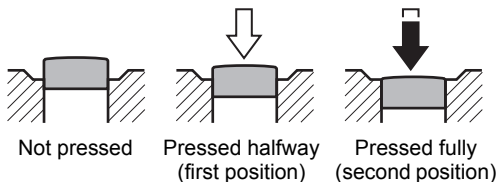

### Poor focusing conditions

The camera may not be able to focus under the following conditions. In these cases, lock the focus on an object the same distance away as the subject (by pressing and holding the shutter release button halfway), then aim the camera at your subject and press the shutter release button fully.

- Objects that lack contrast such as a blue sky or white wall
- Dark places or objects, or conditions that prevent light being reflected back
- Intricate patterns
- Fast moving objects
- When there is an object in the foreground and an object in the background in the captured area
- Strongly reflected light or strong backlighting (bright background)

### Instant Review and Blink Detection

The image appears on the display immediately after it is captured (Instant Review). If the camera detects that the subject's eyes are closed while the Face Detection function (p.69) is activated, the message [Closed eyes have been detected] appears for 3 seconds (Blink Detection).



- When the Face Detection function does not work, Blink Detection also does not function. Even if the subjects' faces are detected, Blink Detection may not function depending on the condition of the detected faces.
- You can also disable the Blink Detection function (p.117).

## Setting the Shooting Mode

The Optio VS20 has a variety of shooting modes that let you take pictures in different situations simply by choosing the appropriate mode for the particular situation from the Capture Mode Palette.

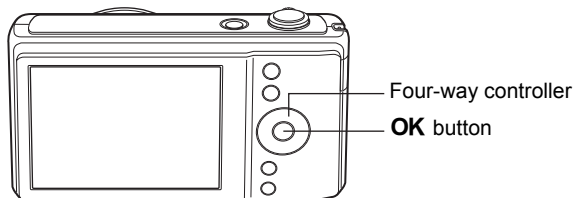

### 1 Press the four-way controller (▼) in mode.

The Capture Mode Palette appears.

### 2 Use the four-way controller (▲▼◀▶) to choose a shooting mode.

When an icon is selected in the Capture Mode Palette, the selected shooting mode guide appears.























### 3 Press the OK button.



The shooting mode is selected and the camera returns to capture status.



Some functions may not be available or may not function fully depending on the selected shooting mode. For details, refer to "Functions Available for Each Shooting Mode" (p.210).

There are 24 available shooting modes.

Shooting Mode		Description	Page
	Auto Picture	Automatically selects the best capture mode.	p.70
	Program	Used for basic shooting. Various functions can also be set with this mode.	p.71
	Natural Skin Tone	For images of people. Enhances skin tone while smoothing blemishes.	p.78
	Handheld Night Snap	Minimizes camera shake for shooting at night.	p.77
	Night Scene Portrait	For images of people at night. Use of a tripod or other support is advised.	p.77
	Night Scene	For night time images. Use of a tripod or other support is suggested.	p.77
	Digital Panorama	Stitches images taken with the camera to create a panoramic photograph.	p.88
	Landscape	For capturing landscape views. Enhances colors of sky and foliage.	—
	Blue Sky	Emphasizes saturation of the sky to produce a bright image.	—
	Sunset	For images of sunsets and warm lighting.	p.77
	Flower	For images of flowers. The outline of the flower is softened.	—
	Digital SR	Higher sensitivity reduces blur.	p.77
	Kids	For capturing moving kids. Reproduces a healthy and bright skin tone.	p.79
	Pet	For capturing moving pets. Select the color according to the pet's coat.	p.80
	Portrait	For capturing portraits. Reproduces a healthy and bright skin tone.	p.78
	Food	For images of food and prepared dishes. Enhances saturation and contrast.	—
	Fireworks	For capturing fireworks. Use of a tripod or other support is suggested.	p.77
	Surf & Snow	For bright images such as sand or snow. Accurately meters for bright scenes.	p.81
	Sport	For a fast moving subject. Tracks the subject until the picture is taken.	p.81
	Fish-eye	Simulates a fish-eye lens's barrel distortion curvature.	p.86
	Sketch	Simulates an artistic pencil drawing.	p.86

Shooting Mode		Description	Page
	Miniature	For capturing an image with the subject looks like miniature objects.	p.86
	Text	Captures text in an easy to read manner. Text contrast can be adjusted.	p.83
	Frame Composite	For capturing images with a frame. Recorded pixels is fixed at <b>[3M]</b> (2048×1536).	p.84

## Using the Face Detection Function

When the camera detects a person's face in the image, the Face Detection function displays a yellow face detection frame around the face on the display screen, sets the focus (Face Detection AF) and compensates the exposure (Face Detection AE).

If the subject in the face detection frame moves, the frame also moves and changes size as it tracks the face.

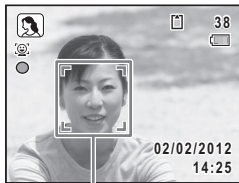

Face detection frame

The Face Detection function can detect up to 10 people's faces. If it detects multiple faces, the camera displays a yellow frame over the main face and white frame(s) over the other face(s). It can display up to a total of 10 frames, including a main frame and white frame(s).

When multiple faces are detected

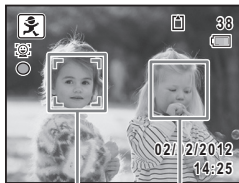

Main frame White frame



- Face Detection AF and AE may not work if the subject is wearing sunglasses, has part of their face covered or is not looking toward the camera.
- If the camera cannot detect the subject's face, the camera focuses using the setting currently selected in [Focusing Area].

- You can register up to three faces to be detected preferentially.
  - ☛ Registering a Face to be Detected Preferentially (p.113)
- The default setting is On. You can switch to Off or Smile for automatic release of the shutter when the subject smiles.
  - ☛ Switching the Face Detection Function (p.117)

## Taking Pictures Automatically (Auto Picture Mode)

In **AUTO PICT** (Auto Picture) mode, the camera automatically selects the most appropriate mode depending on the situations and subjects.

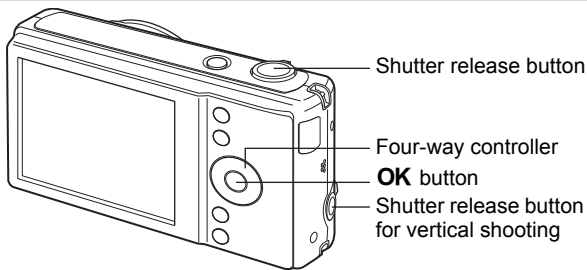

3

### 1 Press the four-way controller (▼) in mode.

The Capture Mode Palette appears.

### 2 Use the four-way controller (▲▼◀▶) to select **AUTO PICT**.

### 3 Press the **OK** button.

**AUTO PICT** (Auto Picture) mode is selected and the camera returns to capture status.





When the camera detects a face, the Face Detection function is activated and the face detection frame appears (p.69).

### 4 Press the shutter release button halfway.

The focus frame on the display turns green and the selected shooting mode is displayed on the top left of the screen when the camera focuses on the subject at the correct distance.



Standard	Night Scene	Night Scene Portrait
Landscape	Flower	Portrait
Sport	Candlelight	Portrait × Blue Sky







 Portrait x Backlight	 Portrait x Sunset	 Group Photo
 Text	 Blue Sky	 Sunset

## 5 Press the shutter release button fully.

The picture is taken.



The following restrictions apply in **AUTO PICT** mode:

- You cannot turn the Face Detection function off.
- The Focusing Area setting is fixed at [ ] (Multiple).
- If  (Night Scene) mode is selected when the flash mode is  (Auto) or  (Auto + Red-eye), the flash mode automatically changes to  (Flash Off).
- If  (Night Scene Portrait) mode is selected when the flash mode is  (Auto), the flash mode automatically changes to  (Flash On + Red-eye) when the camera detects a face and determines that the flash is needed.
- The EV Compensation function cannot be used.

## Taking Pictures in the Custom Settings (Program Mode)

In  (Program) mode, the camera automatically sets the shutter speed and aperture for taking still pictures. However, you can select other functions such as the flash mode and recorded pixels.

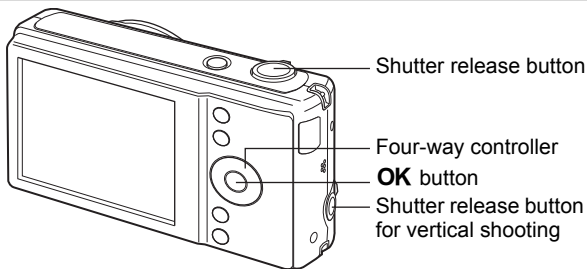

## 1 Press the four-way controller (▼) in mode.

The Capture Mode Palette appears.

**2** Use the four-way controller (▲▼◀▶) to select **[P]**.

**3** Press the OK button.

**[P]** (Program) mode is selected and the camera returns to capture status. When the camera detects a face, the Face Detection function is activated and the face detection frame appears (p.69).



**4** Set the functions you want to change.

Refer to “Setting the Shooting Functions” (p.97) for details on how to set the functions.

**5** Press the shutter release button halfway.

The focus frame on the display turns green when the camera focuses on the subject at the correct distance.

**6** Press the shutter release button fully.

The picture is taken.

## Taking Pictures in the Basic Mode (Green Mode)

In **●** (Green) mode, you can enjoy easy picture-taking using standard settings, regardless of the settings in the **[Rec.Mode]** menu.

**●** mode settings are as shown below.

Flash Mode	(Auto)	Shadow Correction	<input type="checkbox"/> (Off)
Drive Mode	<input type="checkbox"/> (Standard)	Shake Reduction	<input checked="" type="checkbox"/> (On)
Focus Mode	<b>AF</b> (Standard)	Face Recall	Functional
Information Display	Normal	Face Detection	<input checked="" type="checkbox"/> (On)
Recorded Pixels	<b>16M</b> (4608×3456)	Blink Detection	<input checked="" type="checkbox"/> (On)
White Balance	<b>AWB</b> (Auto)	Digital Zoom	<input checked="" type="checkbox"/> (On)
Focusing Area	(Multiple)	Sharpness	(Normal)
Focus Assist	<input checked="" type="checkbox"/> (On)	Saturation	(Normal)
Sensitivity	AUTO	Contrast	(Normal)
AUTO ISO Range	ISO100-800	Date Imprint	Off
EV Compensation	±0.0	Electronic Level	<input checked="" type="checkbox"/> (On)
Highlight Correction	<input type="checkbox"/> (Off)		

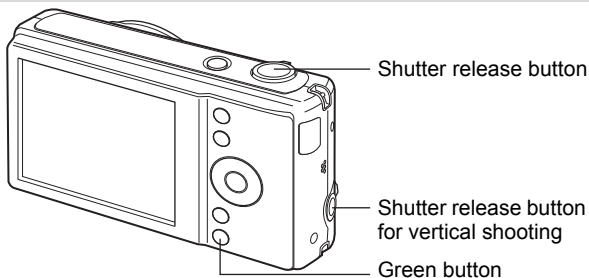

## 1 Press the Green button in mode.

The camera switches to  mode.

Press the Green button again to return to the status before  mode was selected.

When the camera detects a face, the Face Detection function is activated and the face detection frame appears (p.69).





## 2 Press the shutter release button halfway.







The focus frame on the display turns green when the camera focuses on the subject at the correct distance.

## 3 Press the shutter release button fully.

The picture is taken.



¥ The  mode is available only when it is assigned to [Green Button] of the [ Rec. Mode] menu (p.120). By default, the  mode is assigned to the Green button.

- In  mode, you cannot change the information on the display by pressing the **OK/DISPLAY** button.
- Press the **MENU** button in  mode to display the [ Setting] menu. The [ Rec.Mode] menu cannot be displayed.
- When the camera is turned off in  mode, it turns on in  mode next time the power switch is pressed.

## Using the Zoom

You can use the zoom to change the captured area.

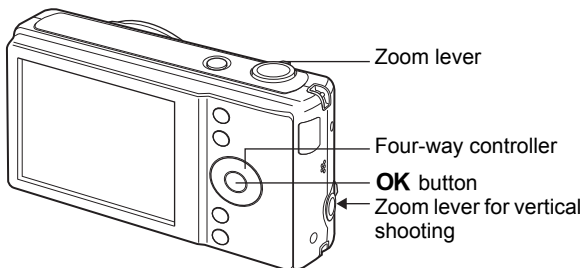

### 1 Turn the zoom lever or the zoom lever for vertical shooting in mode.

(Right) Tele	Enlarges the subject.
(Left) Wide	Widens the area that is captured by the camera.

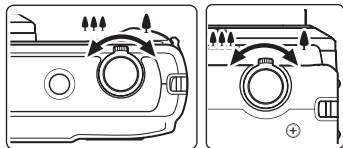

When you continue to turn to the right () , the camera automatically switches from optical zoom to Intelligent Zoom and stops at the point where the zoom switches to Digital Zoom. Once the lever is released and turned again, the camera switches to Digital Zoom.

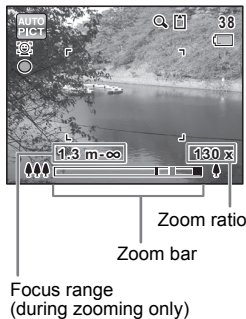

\* The focus range is not displayed when the focus mode is set to , or the shooting mode is set to (Fireworks).

The zoom bar is displayed as follows.

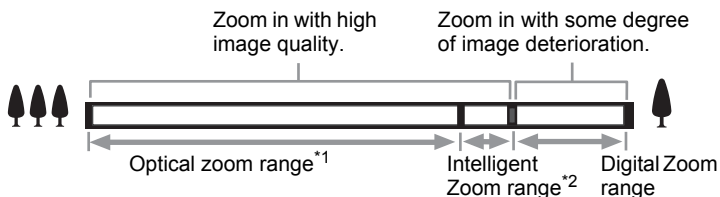

\*1 You can zoom in to a maximum of 20× optically.

\*2 The Intelligent Zoom range differs depending on the recorded pixels. See the following table.

### Recorded pixels and the maximum zoom ratio

Recorded pixels	Intelligent Zoom (Zoom magnification includes 20× optical)	Digital Zoom
16M	Not Available (20× optical zoom only)	Equivalent to approx. 144×
12M 16M / 12M 16M	Not Available (20× optical zoom only)	
7M	Approx. 30×	
3M	Approx. 45×	Equivalent to approx. 144×
2M 16M	Approx. 48×	
2M	Approx. 57.6×	
640	Approx. 144× (Same as Digital Zoom)	



- It is recommended to use a tripod to prevent camera shake when taking pictures at a high magnification rate.
- Pictures taken in the Digital Zoom range appear grainier than pictures taken in the optical zoom range.
- Intelligent Zoom and Digital Zoom cannot be used in the following situations:
  - In (👤) (Digital SR) and 📷 (Handheld Night Snap) modes
  - When the sensitivity is set to 3200 or 6400
- The image enlarged using Intelligent Zoom may appear rough on the display. This does not affect the quality of recorded image.
- In movie recording mode, optical zooming is only available before recording starts, while digital zooming is available during recording.

Selecting the Recorded Pixels p.103

## To Set the Digital Zoom

The Digital Zoom is set to  (On) in the default setting. To take pictures using only the optical zoom and Intelligent Zoom, set the Digital Zoom to  (Off).

### 1 Press the MENU button in mode.

The [ Rec.Mode] menu appears.

### 2 Use the four-way controller ( ) to select [Digital Zoom].

### 3 Use the four-way controller ( ) to select (On) or (Off).

The setting is saved.

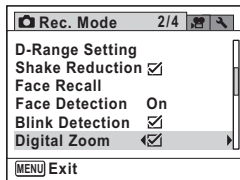







### 4 Press the MENU button.

The camera returns to capture status.





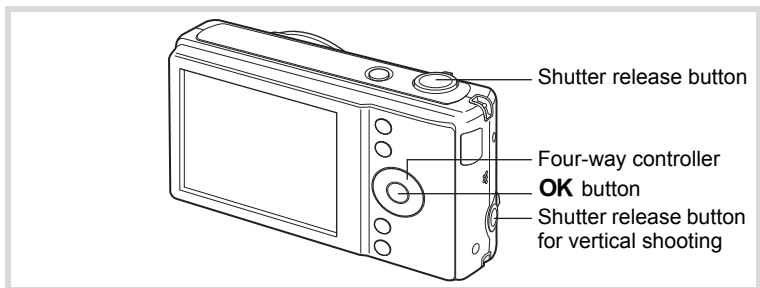

Saving the Digital Zoom Function setting  p.128

## Taking Pictures of Dark Scenes (Handheld Night Snap/Night Scene Portrait/Night Scene/Sunset/Digital SR/Fireworks Mode)

You can choose settings appropriate for taking pictures of dark scenes, such as nightscapes.

	Handheld Night Snap	Minimizes camera shake for shooting at night. The number of recorded pixels is fixed at <b>[5M]</b> (2592×1944).
	Night Scene Portrait	For images of people at night. Use of a tripod or other support is advised. If the Face Detection function is activated when the flash mode is set to $\frac{1}{2}$ A (Auto), the flash mode automatically changes to $\frac{1}{2}$ (Flash On + Red-eye).
	Night Scene	For night time images. Use of a tripod or other support is suggested.
	Sunset	For images of sunsets and warm lighting.
	Digital SR	Higher sensitivity reduces blur. The sensitivity is automatically set to AUTO and the number of recorded pixels is fixed at <b>[5M]</b> (2592×1944).
	Fireworks	For capturing fireworks. Use of a tripod or other support is suggested. The shutter speed is fixed at 4 sec. and the sensitivity is fixed at the minimum value.



- 1 Press the four-way controller (▼) in  mode.**  
The Capture Mode Palette appears.
- 2 Use the four-way controller (▲▼◀▶) to select , , , ,  or .**

### 3 Press the OK button.

The shooting mode is selected and the camera returns to capture status. When the camera detects a face, the Face Detection function is activated and the face detection frame appears (p.69).

### 4 Press the shutter release button halfway.

The focus frame on the display turns green when the camera focuses on the subject at the correct distance.

### 5 Press the shutter release button fully.

The picture is taken.



- The shutter speed tends to be slower when taking pictures of dark scenes.
- In (👤) mode, sensitivity is automatically fixed at AUTO.

## Taking Pictures of People (Portrait/Natural Skin Tone Mode)

(👤) (Portrait) and (👤) (Natural Skin Tone) modes are suitable for taking pictures of people. Face Detection (p.69) operates automatically for each shooting mode, making it easier to emphasize the subject's face when taking pictures.

	Portrait	For capturing portraits. Reproduces a healthy and bright skin tone.
	Natural Skin Tone	For images of people. Enhances skin tone while smoothing blemishes.

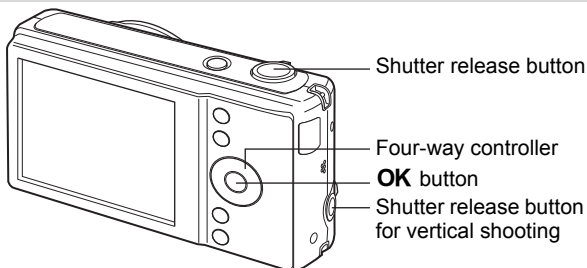

## 1 Press the four-way controller (▼) in mode.

The Capture Mode Palette appears.

## 2 Use the four-way controller (▲▼◀▶) to select or and press the OK button.

The shooting mode is selected and the camera returns to capture status.

When the camera detects a face, the Face Detection function is activated and the face detection frame appears (p.69).



## 3 Press the shutter release button halfway.

The focus frame on the display turns green when the camera focuses on the subject at the correct distance.

## 4 Press the shutter release button fully.

The picture is taken.

## Taking Pictures of Children (Kids Mode)

 (Kids) mode is suitable for taking pictures of moving children. It also reproduces a healthy and bright skin tone. Face Detection (p.69) operates automatically for this mode, making it easier to emphasize the subject's face when taking pictures.

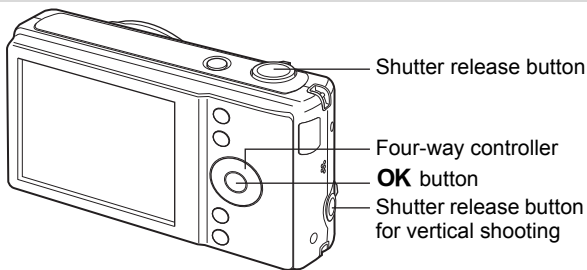

## 1 Press the four-way controller (▼) in mode.

The Capture Mode Palette appears.

**2** Use the four-way controller (▲▼◀▶) to select .

**3** Press the OK button.

 mode is selected and the camera returns to capture status.

When the camera detects a face, the Face Detection function is activated and the face detection frame appears (p.69).



**4** Press the shutter release button halfway.

The focus frame on the display turns green when the camera focuses on the subject at the correct distance.

**5** Press the shutter release button fully.

The picture is taken.

## Taking Pictures of Your Pet (Pet Mode)

Use  (Pet) mode to keep your moving pet in focus and capture the color of your pet's coat when you take a picture. Choose the appropriate icon depending on what color your pet is (closer to black or white or in between).

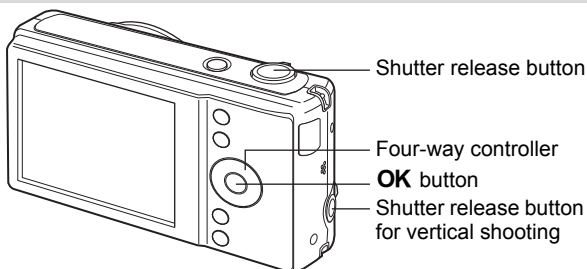

**1** Press the four-way controller (▼) in  mode.

The Capture Mode Palette appears.

**2** Use the four-way controller (▲▼◀▶) to select .

**3 Press the OK button.**  
mode selection screen appears.

**4 Use the four-way controller (▲▼) to select [Cat], [Dog], [Cat], [Dog], [Cat] or [Dog].**

There are two types of icons: a cat and dog icon. Choosing either the cat or dog icon does not affect the resulting picture. Choose whichever you prefer.



**5 Press the OK button.**  
mode is selected and the camera returns to capture status.



**6 Press the shutter release button halfway.**  
The focus frame on the display turns green when the camera focuses on the subject at the correct distance.  
The focus frame follows the subject while the shutter release button is pressed halfway.

**7 Press the shutter release button fully.**  
The picture is taken.

## Taking Pictures of Sports and Leisure Activities (Surf & Snow/Sport Mode)

	Surf & Snow	For bright images such as sand or snow. Accurately meters for bright scenes.
	Sport	For a fast moving subject. Tracks the subject until the picture is taken.

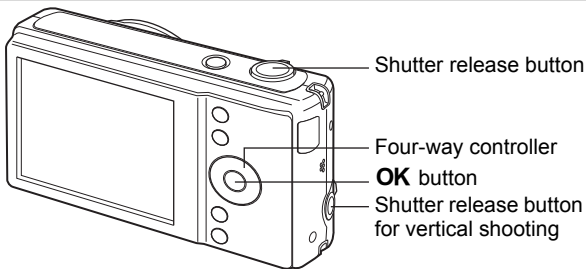

3

**1 Press the four-way controller (▼) in  mode.**

The Capture Mode Palette appears.

**2 Use the four-way controller (▲▼◀▶) to select  or .**

**3 Press the OK button.**

The shooting mode is selected and the camera returns to capture status.

When the camera detects a face, the Face Detection function is activated and the face detection frame appears (p.69).



**4 Press the shutter release button halfway.**

The focus frame on the display turns green when the camera focuses on the subject at the correct distance.

When  mode is selected, the focus frame follows the subject while the shutter release button is pressed halfway.

**5 Press the shutter release button fully.**

The picture is taken.

## Taking Pictures of Text (Text Mode)

**A** (Text) mode allows you to take clear pictures of written text. This is convenient for capturing a digital copy of an important document or enhancing legibility of small print.

<b>A</b> Color	Maintains original colored text.
<b>A</b> Neg. Color	Reverses the color of the text.
<b>A</b> B & W	Turns the color of the text into black and white.
<b>A</b> Neg. B & W	Turns the color of the text into reversed black and white.

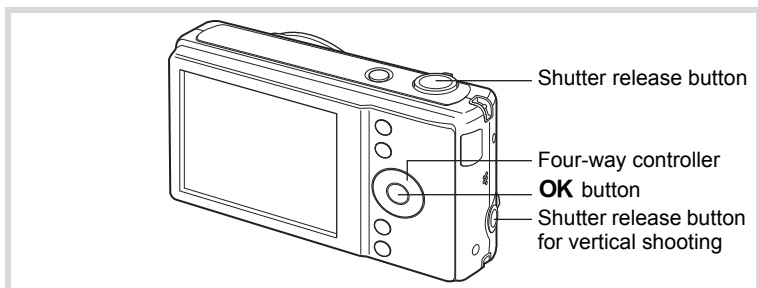

- 1 Press the four-way controller (▼) in **A** mode.**  
The Capture Mode Palette appears.
- 2 Use the four-way controller (▲▼◀▶) to select **A**.**
- 3 Press the OK button.**  
**A** mode selection screen appears.
- 4 Use the four-way controller (▲▼) to select **A**, **A**, **A** or **A**.**

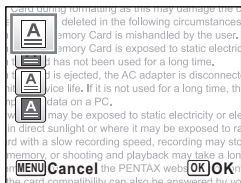

**5 Press the OK button.**

The selected icon appears and the camera returns to capture status.

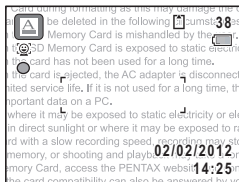
**6 Press the shutter release button halfway.**



The focus frame on the display turns green when the camera focuses on the subject at the correct distance.

**7 Press the shutter release button fully.**

The picture is taken.

**Framing Your Pictures (Frame Composite Mode)**

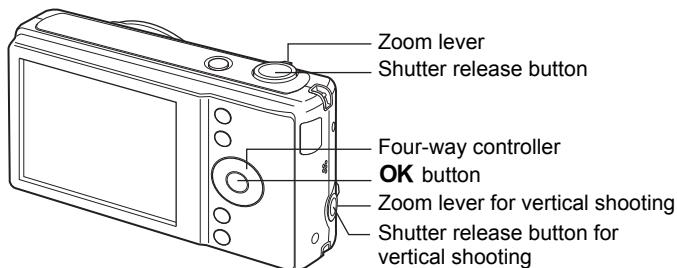
In  (Frame Composite) mode, you can take pictures using the frames stored in the camera.

**1 Press the four-way controller (▼) in  mode.**

The Capture Mode Palette appears.

**2 Use the four-way controller (▲▼◀▶) to select  and press the OK button.**

A 9-frame display of the frame selection screen appears.

**3 Use the four-way controller (▲▼◀▶) to choose the frame you want to use.**

**4 Turn the zoom lever to the right (Q).**

The selected frame appears in single-image display.

You can choose another frame using either of the following operations.

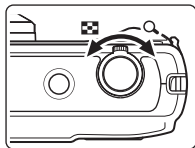

Four-way controller (◀▶)	Press to choose a different frame.
Zoom lever to the left (Q)	Returns to the 9-frame display of the frame selection screen, and then lets you choose a different frame in the same way as Step 3.

**5 Press the OK button.**

The frame appears on the display.

When the camera detects a face, the Face Detection function is activated and the face detection frame appears (p.69).



**6 Press the shutter release button halfway.**

The focus frame on the display turns green when the camera focuses on the subject at the correct distance.

**7 Press the shutter release button fully.**

The picture is taken.



- In mode, recorded pixels is fixed at **3M** (2048×1536).
- When the camera leaves the factory, it includes 3 default frames built-in.



### Optional Frames

The CD-ROM (S-SW122) contains optional frames. Copy these frames to the camera to use them (p.165). These optional frames are deleted if the files on the built-in memory are deleted with a computer or if the built-in memory is formatted.





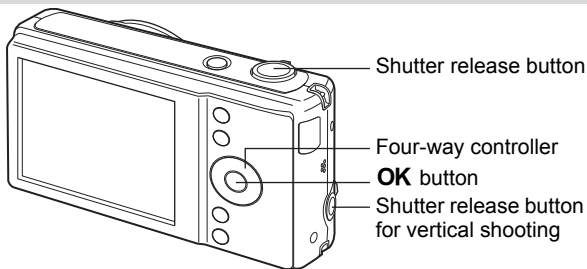

Adding a Frame to a captured image p.163

## Taking Pictures Using the Filters (Fish-eye/Sketch/Miniature)

You can take impressive pictures using the filters.



	Fish-eye	For simulating a fish-eye lens's barrel distortion curvature
	Sketch	For simulating an artistic pencil drawing
	Miniature	For capturing an image with the subject looks like a miniature object.





- 1 Press the four-way controller (▼) in  mode.**  
The Capture Mode Palette appears.
- 2 Use the four-way controller (▲▼◀▶) to select , , or .**
- 3 Press the OK button.**  
When  mode is selected, the bar to adjust the effect is displayed.  
When  mode is selected, go to Step 6.  
When  mode is selected, the screen for selecting the area to be blurred is displayed.

## 4 Use the four-way controller (◀▶) to select an option.

In  (Fish-eye) mode

	Fish-eye effect weak
	Fish-eye effect standard
	Fish-eye effect strong

In  (Miniature) mode

	Focuses on the bottom of the image and blurs the top.
	Focuses on the center of the image and blurs the top and bottom.
	Focuses on the top of the image and blurs the bottom.

## 5 Press the OK button.

The camera is in the selected mode and returns to capture status.

## 6 Press the shutter release button halfway.

The focus frame on the display turns green when the camera focuses on the subject at the correct distance.

## 7 Press the shutter release button fully.



The picture is taken.

Processing the captured images by using the digital filter  p.158

## Taking Panoramic Pictures (Digital Panorama Mode)

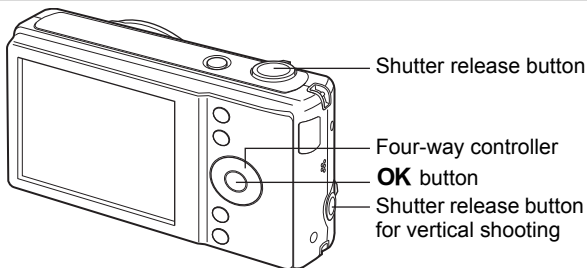
In  (Digital Panorama) mode, you can stitch two or three captured frames to create a panoramic photograph with the camera.



- 1 Press the four-way controller (▼) in  mode.**  
The Capture Mode Palette appears.
- 2 Use the four-way controller (▲▼◀▶) to select .**
- 3 Press the OK button.**  
The camera enters the  mode and the message [Set shift direction] is displayed.
- 4 Use the four-way controller (◀▶) to choose the direction in which the images will be joined.**  
The screen for taking the first frame is displayed.



When the camera detects a face, the Face Detection function is activated and the face detection frame appears (p.69).



## 5 Press the shutter release button halfway.

The focus frame on the display turns green when the camera focuses on the subject at the correct distance.

## 6 Press the shutter release button fully.

The screen for taking the second frame is displayed after you take the first frame.

### If you select right (▶) in Step 4:

The right edge of the first frame appears in semi-transparent form on the left edge of the display.

### If you select left (◀) in Step 4:

The left edge of the first frame appears in semi-transparent form on the right edge of the display.

## 7 Move the camera so that the alignment icons for the semi-transparent image and the actual view overlap.

The shutter is automatically released when the icons overlap.

If the actual view is not aligned with the semi-transparent image, an arrow indicating the direction the camera must be moved (either up or down) appears.

If the shutter is not released automatically, press the shutter release button to take the picture.

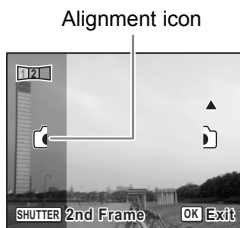

## 8 Take the third frame.

Repeat Step 7 to take the third frame.

The panorama stitching starts and a stitched image appears.



- Some distortion may result from moving objects, repeating patterns, or if nothing exists when overlapping the first and second frames or the second and third frames on the preview guide.
- When the Face Detection is activated (p.69), it works only when taking the first frame. The Smile Capture function cannot be set.

## To Cancel after Taking the First or Second Frame

- 1** After shooting the first frame in Step 6 or second frame in Step 7, press the **OK** button or the four-way controller (▼).

A confirmation dialog appears.

- 2** Use the four-way controller (▲▼) to select an option and press the **OK** button.

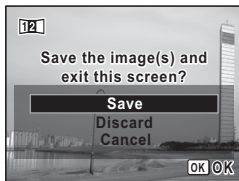

- Save:** Saves the captured image(s) and you can retake the first frame. When this option is selected after shooting the second frame, the first and the second frames are stitched and a stitched image appears.
- Discard:** Discards the captured image(s) and you can retake the first frame.
- Cancel:** Returns to the previous shooting screen.

## Using the Self-timer

In Self-timer mode, the picture is taken ten seconds or two seconds after the shutter release button is pressed.

Stabilize the camera with a tripod when taking a picture with the self-timer.

	Use this mode when you want to be included in a group picture. The picture is taken approximately ten seconds after the shutter release button is pressed.
	Use this mode to avoid camera shake. The picture is taken approximately two seconds after the shutter release button is pressed.

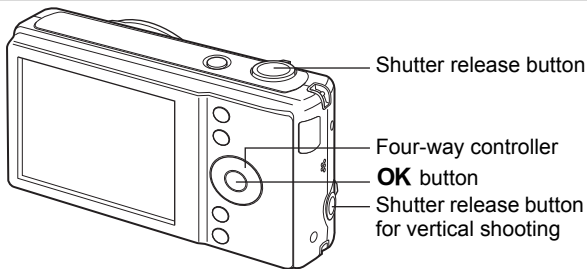

**1** Press the four-way controller (▲) in mode.

**2** Use the four-way controller (◀▶▼) to select or and press the OK button.

The camera is ready to take the picture using the self-timer.



**3** Press the shutter release button halfway.

The focus frame on the display turns green when the camera focuses on the subject at the correct distance.

**4** Press the shutter release button fully.

When set to , the self-timer lamp lights. The self-timer lamp blinks during the last 3 seconds before shooting or when set to .

The picture is taken ten seconds or two seconds later.









- Focusing may be compromised if you move the camera while the self-timer lamp is blinking when taking still pictures.
- The self-timer lamp does not light up or blink in (Pet) mode.





- In movie recording mode, recording will start after ten seconds (or two seconds).
- Press the shutter release button halfway while the self-timer is engaged to stop the countdown and press fully to restart the countdown.
- cannot be selected while (Green) mode is in default setting. Select in another shooting mode and then switch the shooting mode to .



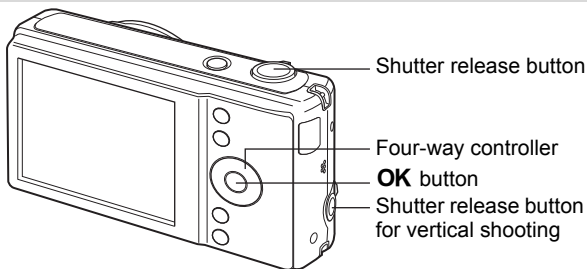

## Taking a Series of Pictures (Continuous Shooting/ Burst Shooting/16-frame Shooting Mode)

In these modes, pictures are taken continuously as long as the shutter release button is pressed.

	Continuous Shooting	Each time a picture is taken, the image is saved in the memory before the next image is taken. The higher the image quality, the longer the interval between shots.
	Burst Shooting (L)	The number of recorded pixels is fixed at [5M] (2592×1944) and pictures are taken consecutively. The interval between shots becomes shorter in the following sequence:  and  .
	Burst Shooting (H)	
	16-frame Shooting	16 pictures are taken continuously at 1/7.5 second intervals.



**1** Press the four-way controller (▲) in  mode.

**2** Use the four-way controller (◀▶▼) to select , ,  or  and press the OK button.

The camera is ready to take a series of pictures.



**3** Press the shutter release button halfway.

The focus frame on the display turns green when the camera focuses on the subject at the correct distance.

## Press the shutter release button fully.

In or , mode, pictures are taken continuously as long as you keep the shutter release button pressed.

In mode, 16 pictures are taken continuously with one press of the shutter release button.



- The flash does not discharge in , , or mode.
- , , and cannot be selected in (Green), (Auto Picture), (Natural Skin Tone), (Night Scene), (Frame Composite) or (Digital Panorama) and movie recording modes. cannot be selected in (Digital SR) mode.



- The focus and exposure are locked with the first shot.
- When the Face Detection is activated (p.69), it works only when taking the first shot.
- In mode, pictures are taken with the following settings.
  - Sensitivity is fixed at AUTO.
  - EV Compensation and Auto Focus are adjusted when taking the first picture and are fixed for subsequent pictures.
  - The flash is not available (Ⓢ appears).
  - The last shot taken is displayed in Instant Review.
- In mode, the recorded pixels is fixed at (640×480) per one frame and will be saved as a single image in 4 × 4 rows of the 16 images with the recorded pixels of (2560×1920).
- When you play back the images taken with mode, they will be displayed as follows.
  - When played back on this camera, 16 images are continuously played back like a movie. You can save one of a series of images taken with mode as a single image. The available operations during playback are the same as when playing back the movies. (p.133)
  - When played back on a computer, the 16 images are arranged in 4 × 4 rows and displayed as a single image.

## Taking Pictures Using the Remote Control Unit (Optional)

You can use the remote control (optional) to take pictures while you are away from the camera.

	Remote Control	The shutter will be released after about three seconds when the shutter release button on the remote control unit is pressed.
--	----------------	---



0-sec Remote Control

The shutter will be released immediately when the shutter release button on the remote control unit is pressed.

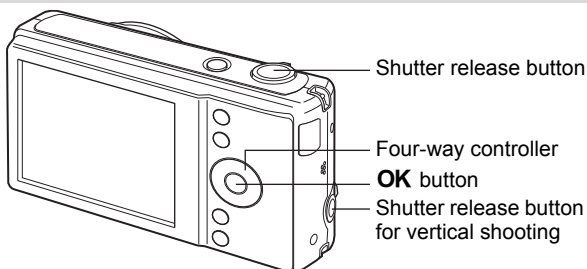

**1 Press the four-way controller (▲) in mode.**

The [Drive Mode] screen appears.

**2 Use the four-way controller (◀▶) to select and press the four-way controller (▼).**

**3 Use the four-way controller (◀▶) to select or and press the OK button.**

The self-timer lamp begins to blink slowly and the camera is ready to take a picture with the remote control.



**4 Point the remote control at the remote control receiver and press the shutter release button on the remote control.**

The focus frame turns green when the subject is in focus and the camera takes a picture at the following timing.





When (Remote Control) is selected:

The self-timer lamp blinks quickly and the camera takes a picture after about three seconds.

When (0-sec Remote Control) is selected:

The camera takes a picture immediately.





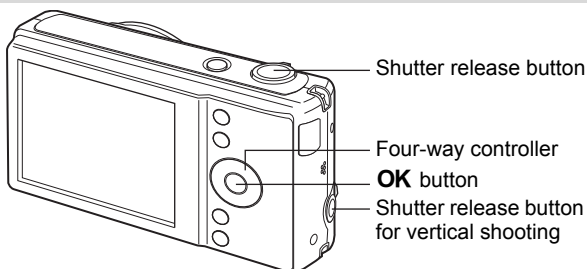

- The operating range is approx. 4 m (13 ft) from the front of the camera when using the remote control unit.
- When using the REMOTE CONTROL WATERPROOF O-RC1, you can record a movie by pressing the **Fn** button on the remote control or the  button on the camera.
- The camera takes a picture even if the focus is not achieved.
- If the shutter release button on the camera is pressed halfway during the countdown, the countdown stops. If the shutter release button on the remote control is pressed again, the camera starts the countdown again.
-  /  cannot be selected in  (Green) mode.
- The self-timer lamp does not flash in  (Pet) mode.

## Shooting while the Exposure is Automatically Changed (Auto Bracketing)

You can take three continuous pictures with different exposures when the shutter release button is pressed and select the best one. In Auto Bracketing, you can select the exposure change from  $\pm 0.3$  EV,  $\pm 0.7$  EV, and  $\pm 1.0$  EV. When you select  $\pm 1.0$  EV, the first image is exposed with no compensation, the second image is  $-1.0$  EV (underexposed) and the third image is  $+1.0$  EV (overexposed).



- 1 Press the four-way controller () in  mode.**  
The [Drive Mode] screen appears.
- 2 Use the four-way controller ( ) to select  (Auto Bracketing).**

**3** Press the four-way controller (▼).

**4** Use the four-way controller (◀▶) to select the amount of exposure change.

Select from.[ ±0.3 EV], [±0.7 EV], and [±1.0EV]



**5** Press the OK button.

The setting is saved and the camera returns to capture status in Auto Bracketting mode.

**6** Press the shutter release button halfway.

The focus frame on the display turns green when the camera focuses on the subject at the correct distance.

**7** Press the shutter release button fully.

Three pictures with different exposure are taken



- In **AUTO PICT** (Auto Picture), (Green), (Fireworks), (Digital Panorama), or (Frame Composition), you cannot select Auto Bracketting.
- In Auto Bracketting mode, Blink Detection is fixed at Off.

# Setting the Shooting Functions

## Selecting the Flash Mode

	Auto	The flash discharges automatically depending on the light conditions. If the Face Detection function is activated, the flash mode is automatically set to .
	Flash Off	The flash does not discharge, regardless of the brightness. Use this mode to take pictures where flash photography is prohibited.
	Flash On	The flash discharges regardless of the brightness.
	Auto + Red-eye	This mode reduces the phenomenon of red eyes caused by the light from the flash being reflected in the subject's eyes. The flash discharges automatically. A pre-flash discharges before the main flash.
	Flash On + Red-eye	This mode reduces the phenomenon of red eyes caused by the light from the flash being reflected in the subject's eyes. The flash discharges regardless of the light conditions. A pre-flash discharges before the main flash.



- The flash does not discharge () in movie recording mode, or when the drive mode is set to (Continuous Shooting), (Burst Shooting L), (Burst Shooting H) or (16-frame shooting), or the focus mode is set to (Infinity).
- In (Green) mode, you can only select or .
- In (Night Scene) mode, you cannot select and .
- In (Night Scene Portrait) mode, or when the Face Detection function is activated and the flash is set to , the flash mode will automatically change to when a face is detected.



Using the flash when capturing images at a close distance may cause uneven exposure of the image due to the light distribution.

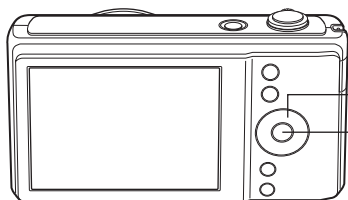

Four-way controller

OK button

3

## 1 Press the four-way controller (◀) in mode.

The flash mode changes each time the button is pressed. You can also change the setting using the four-way controller (▲▼).

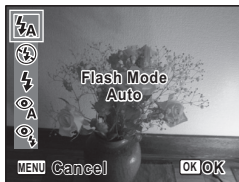

## 2 Press the OK button.

The setting is saved and the camera returns to capture status.





### About the red-eye phenomenon

Taking pictures using the flash may cause the subject's eyes to appear red in the resulting picture. This phenomenon occurs when the light from the flash is reflected in the subject's eyes. It can be reduced by illuminating the area around the subject or moving closer to the subject and zooming out to a wider angle. Setting the flash mode to (Auto + Red-eye) or (Flash On + Red-eye) is also an effective way of reducing red eyes.

If the subject's eyes appear red despite such precautions, they can be corrected by the red-eye compensation function (p.162).

Saving the Flash Mode setting p.128

## Selecting the Focus Mode

<b>AF</b>	Standard	Use this mode when the distance to the subject is 40 cm (16 in.) or more. The camera is focused on the subject in the autofocus area when the shutter release button is pressed halfway.
	Macro	This mode is used when the distance to the subject is approx. 10 cm to 50 cm (4 in. to 20 in.). The camera is focused on the subject in the autofocus area when the shutter release button is pressed halfway.
	1cm Macro	This mode is used when the distance to the subject is approx. 1 cm to 20 cm (0.4 in. to 8 in.). The camera is focused on the subject in the autofocus area when the shutter release button is pressed halfway.
	Infinity	This mode is used for taking distant objects. The flash is set to  (Flash Off).
<b>MF</b>	Manual Focus	This mode lets you adjust the focus manually.

### 1 Press the four-way controller (▶) in mode.



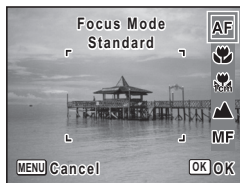

The focus mode changes each time the button is pressed. You can also change the setting using the four-way controller (▲▼).



### 2 Press the OK button.

The setting is saved and the camera returns to capture status.



- In  (Green) mode, you can only select **AF** or .
- When **AF** (Standard) is selected and the subject is closer than 20 cm, the camera automatically focuses from 10 cm (Auto-Macro function). In this case,  appears on the display.
- When shooting with  selected, if the subject is further than 50 cm away, the camera automatically focuses to  $\infty$  (Infinity).
- When shooting with  selected, even if the subject is not in focus, the camera is able to shoot the image. In this case, a blurred image will be shot.

Saving the Focus Mode setting  p.128

## To Set the Focus Manually (Manual Focus)

### 1 Press the four-way controller (▶) in mode.

The [Focus Mode] screen appears.

### 2 Press the four-way controller (▶) to select **MF**.

### 3 Press the **OK** button.

The central portion of the image is magnified to full screen on the display.

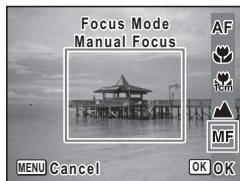

### 4 Use the four-way controller (▲▼) to adjust the focus.

The **MF** indicator appears on the display to indicate the approximate distance to the subject. Adjust the focus using the indicator as a guide.

- ▲ for distant focus
- ▼ for closer focus

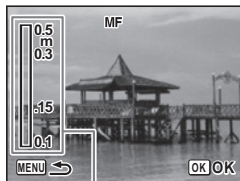

**MF** indicator

### 5 Press the **OK** button.

The focus is fixed and the camera returns to capture status. After the focus is fixed, you can press the four-way controller (▶) again to display the **MF** indicator and readjust the focus.





The shooting mode and drive mode cannot be changed while the **MF** indicator is displayed.











To switch from **MF** to another focus mode, press the four-way controller (▶) while the **MF** indicator is displayed.

## To Set the Focusing Area

You can change the autofocus area (Focusing Area).



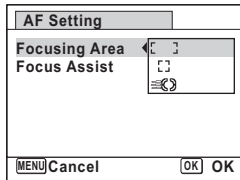

	Multiple	Normal autofocus area
	Spot	The autofocus area becomes smaller.
	Automatic Tracking AF	Keeps moving subjects in focus.

- 1 Press the MENU button in  mode.**  
The [ Rec.Mode] menu appears.
- 2 Use the four-way controller ( ) to select [AF Setting].**
- 3 Press the four-way controller ().**  
The [AF Setting] screen appears.
- 4 Press the four-way controller ().**  
A pull-down menu appears.
- 5 Use the four-way controller ( ) to change the focusing area setting.**





- 6 Press the OK button.**  
The setting is saved.
- 7 Press the MENU button twice.**  
The camera returns to capture status.



- In movie recording and  (Frame Composite) modes, the Focusing Area cannot be set to .
- In  (Green) and  (Auto Picture) modes, the Focusing Area is fixed at .

## To set the AF Assist Light (Focus Assist)

The camera automatically emits the focus assist light in dark shooting situations. You can set the light to on or off.

- 1 **Press the MENU button in  mode.**  
The [ Rec. Mode] menu appears.
- 2 **Use the four-way controller (▲ ▼) to select [AF Setting].**
- 3 **Press the four-way controller (▶).**  
The [AF Setting] screen appears.
- 4 **Use the four-way controller (▲ ▼) to select [Focus Assist].**

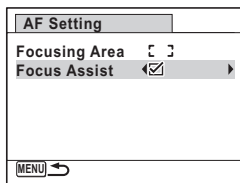



- 5 **Use the four-way controller (◀ ▶) to select  (On) or  (Off).**  
The setting is saved.
- 6 **Press the MENU button twice.**  
The camera returns to capture status.



Looking at the light directly will not create a safety hazard. However, do not look into the focus assist light from a very short distance since you may feel dazzled.



- The camera does not emit the focus assist light under the following conditions.
  - In movie recording mode
  -  (Fireworks) or  (Pet) mode
  - When the focus mode is set to ▲ (Infinity) or MF (Manual Focus)

## Selecting the Recorded Pixels

You can choose from six recorded pixels settings for still pictures.

The larger your recorded pixels, the clearer the details will appear when you print your picture. As the quality of the printed picture also depends on the image quality, exposure control, resolution of the printer and other factors, you do not need to select more than the required number of recorded pixels. **[7M]** (3072×2304) is adequate for making postcard-size prints. The more pixels there are, the larger the picture and the bigger the file size.

Refer to the following table for the appropriate settings according to use.





Recorded Pixels	Expected Usage
<b>[16M]</b> 4608×3456	For printing high quality photos or A4-size pictures or larger, or editing images on a computer.
<b>[12M]</b> 3456×3456	
<b>[12M 16:9]</b> 4608×2592	For making postcard-size prints.
<b>[7M]</b> 3072×2304	
<b>[2M 16:9]</b> 1920×1080	For a natural feeling of expansiveness with the same aspect ratio as HDTV.
<b>[640]</b> 640×480	For posting on a website or attaching to e-mail.

The default setting is **[16M]**.

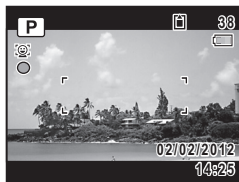
### Shooting/Playback screen when **[12M 16:9]** or **[2M 16:9]** is selected

If you select **[12M 16:9]** or **[2M 16:9]** as the Recorded Pixels setting, the aspect ratio of the image is 16:9 and the monitor display is as shown on the right.



- 1 Press the MENU button in  mode.**  
The [ Rec.Mode] menu appears.
- 2 Use the four-way controller ( ) to select [Recorded Pixels].**
- 3 Press the four-way controller () .**  
A pull-down menu appears.

- 4 Use the four-way controller (▲▼) to select the number of recorded pixels.**

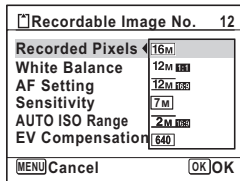

- 5 Press the OK button.**

The setting is saved.

- 6 Press the MENU button.**





The camera returns to capture status.



- The number of recorded pixels for images captured in (Green) mode is fixed at **16M**.
- The number of recorded pixels for images captured in (Frame Composite) is fixed at **3M** (2048×1536).
- If you exit (Digital Panorama) mode after taking the first frame, the number of recorded pixels for the captured image is fixed at **2M** (1600×1200).
- When recorded in (Burst Shooting L), (Burst Shooting H) or (Digital SR) mode, the number of recorded pixels is fixed at **5M** (2592×1944).
- The number of recorded pixels for images captured with (16-frame shooting) is fixed at **640** for one frame and **5M** (2560×1920) for one image.
- If you change the [Recorded Pixels] setting frequently, you can save time by assigning it to the Green button (p.120).

## Adjusting the White Balance

You can take pictures in natural colors by adjusting the white balance according to the light conditions at the time of shooting.

<b>AWB</b>	Auto	The camera adjusts the white balance automatically.
	Daylight	Use this mode when taking pictures outside in sunlight.
	Shade	Use this mode when taking pictures outside in the shade.
	Tungsten Light	Use this mode when taking pictures under electric or other tungsten light.
	Fluores. Light	Use this mode when taking pictures under fluorescent light.
	Manual	Use this mode when adjusting the white balance manually.



- Set another white balance if you are not satisfied with the color balance of pictures taken with the White Balance set to **AWB**.
- Depending on the selected shooting mode, the white balance setting may not be changed. Refer to “Functions Available for Each Shooting Mode” (p.210) for details.

### 1 Press the **MENU** button in mode.



The [ Rec. Mode] menu appears.

### 2 Use the four-way controller ( ) to select [**White Balance**].

### 3 Press the four-way controller ().

The [White Balance] screen appears.

### 4 Use the four-way controller ( ) to change the setting.

You can check the result of selected white balance setting on the preview image each time you press the four-way controller ( ).

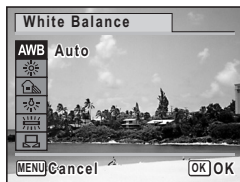

### 5 Press the **OK** button.

The setting is saved.

## 6 Press the MENU button.

The camera returns to capture status.

Refer to the section “To Set the White Balance Manually” for instructions on adjusting the white balance manually.

Saving the White Balance setting  p.128

### To Set the White Balance Manually

Have a blank sheet of white paper or similar material ready.

**1** In the [White Balance] screen, use the four-way controller (▲▼) to select  (Manual).

**2** Point the camera at the blank sheet of paper or other material so that it fills the frame displayed in the center of the screen.

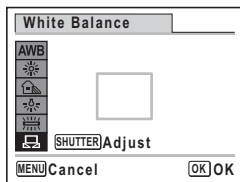

**3** Press the shutter release button fully.

The white balance is automatically adjusted.

**4** Press the OK button.

The setting is saved and the [ Rec. Mode] menu reappears.

**5** Press the MENU button.

The camera returns to capture status.

## Setting the Exposure (EV Compensation)

You can adjust the overall brightness of the picture.

Use this function to take pictures that are intentionally overexposed or underexposed.

### 1 Press the **MENU** button in mode.

The [ Rec.Mode] menu appears.

### 2 Use the four-way controller ( ) to select [EV Compensation].

### 3 Use the four-way controller ( ) to select the EV value.

To brighten, select a positive (+) value. To darken, select a negative (-) value.

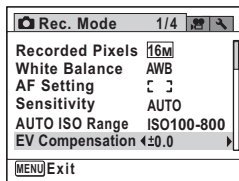

You can choose the EV setting in the range of -2.0 EV to +2.0 EV in 1/3 EV steps.



### 4 Press the **MENU** button.

The camera returns to capture status.



- When the histogram is displayed in still picture capture mode/playback mode, you can check the exposure (p.25).
- The EV Compensation function cannot be used in  (Green) or  (Auto Picture) mode.
- If you change the [EV Compensation] setting frequently, you can save time by assigning it to the Green button (p.120).

Saving the EV Compensation value setting  p.128

## Correcting the Brightness (D-Range Setting)

Expands the dynamic range and prevents bright and dark areas from occurring. [Highlight Correction] adjusts the bright areas when the image is too bright and [Shadow Correction] adjusts the dark areas when the image is too dark.

### 1 Press the **MENU** button in mode.

The [ Rec. Mode] menu appears.

### 2 Use the four-way controller ( ) to select [**D-Range Setting**].

### 3 Press the four-way controller ().

The [D-Range Setting] screen appears.

### 4 Use the four-way controller ( ) to select [**Highlight Correction**] or [**Shadow Correction**].

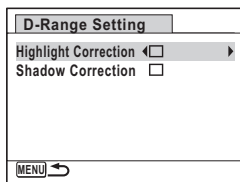



### 5 Use the four-way controller ( ) to select (On) or (Off).

### 6 Press the **MENU** button twice.

The camera returns to capture status.

The D-Range Setting icon appears on the display.

	When [Highlight Correction] is set to <input checked="" type="checkbox"/>
	When [Shadow Correction] is set to <input checked="" type="checkbox"/>
	When [Highlight Correction] and [Shadow Correction] are both set to <input checked="" type="checkbox"/>



When [Highlight Correction] is set to , the minimum sensitivity is ISO 200.







## Setting the Sensitivity

You can select the sensitivity to suit the brightness of the surroundings.

AUTO	The sensitivity is automatically adjusted by the camera. (Default value: sensitivity 100 - 800)
100	 <p>The lower the sensitivity, the less noise that affects the image. The shutter speed will be slower in low light conditions.</p> <p>Higher sensitivity settings use faster shutter speeds in low light conditions to reduce camera shake, but the image may be affected by noise.</p>
200	
400	
800	
1600	
3200	
6400	

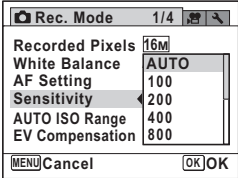

When [Highlight Correction] is set to , the minimum sensitivity is ISO 200 (p.108).

- 1 Press the MENU button in  mode.**  
The [ Rec.Mode] menu appears.
  - 2 Use the four-way controller ( ) to select [Sensitivity].**
  - 3 Press the four-way controller ().**  
A pull-down menu appears.
  - 4 Use the four-way controller ( ) to change the sensitivity.**
- 
- 5 Press the OK button.**  
The setting is saved.
  - 6 Press the MENU button.**  
The camera returns to capture status.



- In movie recording mode or the shooting mode is set to **●** (Green) mode, only AUTO (sensitivity 100 - 800) is available.
- When set to **(●)** (Digital SR) mode, only AUTO (sensitivity 100 - 6400) is available.
- If you change the [Sensitivity] setting frequently, you can save time by assigning it to the Green button (p.120).

Saving the sensitivity setting p.128

## 3 Setting the AUTO ISO Range

Set the sensitivity range when the sensitivity is set to AUTO.  
You can select from 100-200, 100-400, 100-800, and 100-1600.

### 1 Press the MENU button in mode.

The [ Rec. Mode] menu appears.

### 2 Use the four-way controller (**▲ ▼**) to select [AUTO ISO Range].

### 3 Press the four-way controller (**▶**).

A pull-down menu appears.

### 4 Use the four-way controller (**▲ ▼**) to select the sensitivity adjustment range.

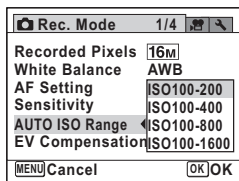

### 5 Press the OK button.

The setting is saved.

### 6 Press the MENU button.

The camera returns to capture status.



When [Highlight Correction] in [D-Range Setting] is set to  (On), select from 200-400, 200-800, and 200-1600.

## Setting the Image Sharpness (Sharpness)

You can give the image sharp or soft outlines.

- 1 Press the **MENU** button in **📷** mode.

The [📷 Rec. Mode] menu appears.

- 2 Use the four-way controller (▲▼) to select [Sharpness].

- 3 Use the four-way controller (◀▶) to change the sharpness level.

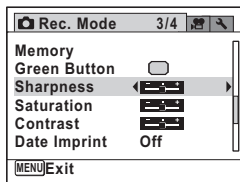
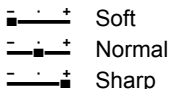

- 4 Press the **MENU** button.

The camera returns to capture status.

## Setting the Color Saturation (Saturation)

You can set the color saturation.

- 1 Press the **MENU** button in **📷** mode.

The [📷 Rec. Mode] menu appears.

- 2 Use the four-way controller (▲▼) to select [Saturation].

- 3 Use the four-way controller (◀▶) to change the saturation level.

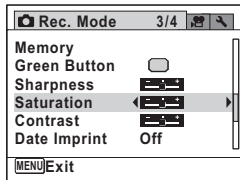
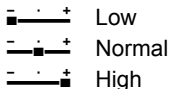









- 4 Press the **MENU** button.

The camera returns to capture status.

## Setting the Image Contrast (Contrast)

You can set the image contrast level.

- 1 Press the MENU button in  mode.**  
The [ Rec. Mode] menu appears.
- 2 Use the four-way controller ( ) to select [Contrast].**
- 3 Use the four-way controller ( ) to change the contrast level.**

 Low  
 Normal  
 High
- 4 Press the MENU button.**  
The camera returns to capture status.

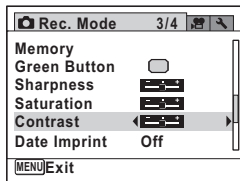





## Setting the Shake Reduction Function

You can set this function to correct camera shake which can occur during shooting. The default setting is  (On).



Use the Movie SR function (p.125) to correct camera shake in movie recording mode.

- 1 Press the MENU button in  mode.**  
The [ Rec. Mode] menu appears.
- 2 Use the four-way controller ( ) to select [Shake Reduction].**

### 3 Use the four-way controller (◀▶) to select or .

- Corrects camera shake.
- Does not correct camera shake.

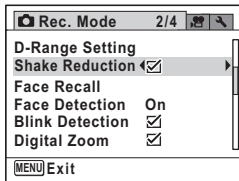

### 4 Press the MENU button.

The camera returns to capture status.

One of the following icons appears on the display.

	When the shutter release button is pressed halfway with [Shake Reduction] set to <input checked="" type="checkbox"/> (On).
	When [Shake Reduction] is set to <input type="checkbox"/> (Off). (If the camera shake is likely to occur,  is indicated when the shutter button is pressed halfway.)



The Shake Reduction function does not work in the following situation:  
- During movie recording

## Registering a Face to be Detected Preferentially

You can register up to three faces to be detected preferentially in Face Detection function (p.69). If the name is registered together with the face, the name is displayed on the display when the face is detected. If multiple faces have been registered and have priorities set, the face with the highest priority is focused on when more than one registered face is detected.

### To Register the First Face

#### 1 Press the MENU button in mode.

The [ Rec. Mode] menu appears.

#### 2 Use the four-way controller (▲▼) to select [Face Recall].

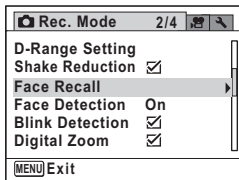

### 3 Press the four-way controller (▶).

The screen for registering a face appears. Point the camera at the face to be registered.

When a face is detected around the yellow frame, the face is taken automatically, and the screen to enter the name appears.



### 4 Enter the person's name for the face that has been registered.

Use the four-way controller (◀▶▲▼) to select a character, then press the **OK** button.

Repeat this step to enter up to 8 characters. To cancel the entered character, press the **●** (Green) button.

Screen to enter the name

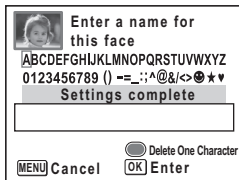

To finish entering the name, use the four-way controller (◀▶▲▼) to select [Settings complete] then press the **OK** button. The face list screen appears.

Face list screen

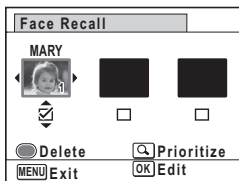

To register the second and third faces, go to Step 1 in “To Register the Second and Third Faces”.

### 5 Press the MENU button.

The camera returns to the [📷 Rec. Mode] menu.

## To Register the Second and Third Faces

When you select [Face Recall] on the [📷 Rec. Mode] menu, the face list screen appears if a face or faces have been registered. You can register a second and third faces.

When you register multiple faces, you can set the priority.

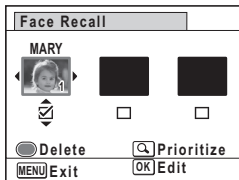

**1** Use the four-way controller (◀▶) to select a blank column.

**2** Press the ● (Green) button.

The screen for registering a face appears. Point the camera at the face to be registered.

When a face is detected around the yellow frame, the face is taken automatically, and the screen to enter the name appears.

**3** Enter the person's name for the face that has been registered.

Enter the name following Step 4 in "To Register the First Face" (p.114) then press the OK button. The face list screen appears.

**4** Set the priority.

Use the four-way controller (◀▶) to select a face to set the priority and turn the zoom lever to select the priority from [1], [2], and [3].

([3] appears only for registering a third face.)

The registered faces appear with the highest priority on the left.

The priority can be set later using the same procedure.

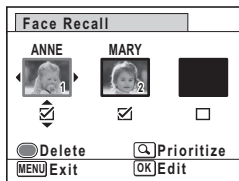
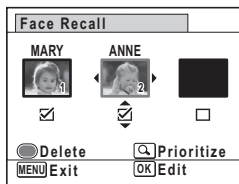

**5** Press the MENU button.

The camera returns to the [📷 Rec. Mode] menu.

## To Change a Registered Name

**1** Select [Face Recall] on the [📷 Rec. Mode] menu to display the face list screen.

**2** Use the four-way controller (◀▶) to select a face to be changed then press the OK button.

The screen to enter the name appears.

**3 Change the name.**

Press the **■** (Green) button to delete a character to be changed then enter a new character.

Select [Settings complete] then press the **OK** button.

**4 Press the MENU button.****To Release a Registration Temporarily**

You can release the registered face temporarily.

**1 Select [Face Recall] on the [📷 Rec. Mode] menu to display the face list screen.****2 Use the four-way controller (◀▶) to select a face to be released temporarily.****3 Use the four-way controller (▲▼) to select  (Off).****4 Press the MENU button.**

When you select  (On) in Step 3, registration for the face will be retrieved.

**To Release a Registration****1 Select [Face Recall] on the [📷 Rec. Mode] menu to display the face list screen.****2 Use the four-way controller (◀▶) to select a face to be released.****3 Press the **■** (Green) button.**

A confirmation dialog appears.

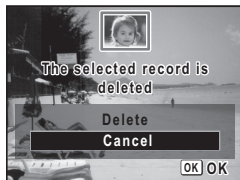

**4** Press the four-way controller (▲) to select [Delete].

**5** Press the MENU button.

The registration is released, and the face disappears from the face list screen.

## Switching the Face Detection Function

The camera comes with a Face Detection function that spots the faces in your shot and automatically adjusts the focus and exposure for the faces. It will automatically release the shutter when people are smiling (Smile Capture function/Smile), or if anyone blinked, it will tell you that so you can take the shot again until it is perfect (Blink Detection). The default setting is [On] for [Face Detection] and  (On) for [Blink Detection].

**1** Press the MENU button in  mode.

The [📷 Rec. Mode] menu appears.

**2** Use the four-way controller (▲▼) to select [Face Detection].

**3** Press the four-way controller (▶).  
A pull-down menu appears.

**4** Use the four-way controller (▲▼) to select an option.

On	The camera detects a person's face.
Smile	The camera automatically release the shutter when your subject smiles.
Off	The camera does not detect a person's face.

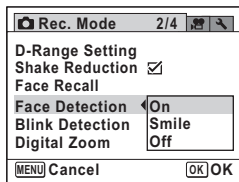

**5** Press the OK button.

The setting is saved.

**6** To set the Blink Detection function, press the four-way controller (▼) to select [Blink Detection].

## 7 Use the four-way controller (◀▶) to select or .

- Blink Detection function works.
- Blink Detection function does not work.

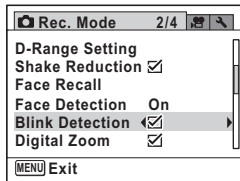

## 8 Press the MENU button.

The camera returns to capture status.

The Face Detection icon appears on the display.

	When [Face Detection] is set to [On]
	When [Face Detection] is set to [Smile]

## Setting the Date Imprint Function

You can choose whether to imprint the date and/or time when taking still pictures.

### 1 Press the MENU button in mode.

The [ Rec.Mode] appears.

### 2 Use the four-way controller (▲▼) to select [Date Imprint].

### 3 Press the four-way controller (▶).

A pull-down menu appears.

### 4 Use the four-way controller (▲▼) to select the Date Imprint details.

Choose from [Date], [Date & Time], [Time], or [Off].

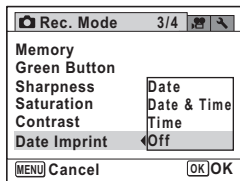

### 5 Press the OK button.

The setting is saved.

## 6 Press the MENU button.

The camera returns to capture status.



- The date and/or time imprinted with the Date Imprint function cannot be deleted.
- Note that if the printer or the image editing software is set to print the date and the images to be printed already have the date and/or time imprinted, the imprinted dates and/or times may overlap.



- **DATE** appears on the display in mode when [Date Imprint] is set.
- The date and/or time are imprinted on the picture with the display style set in the [Date Adjustment] screen (p.46).

## Setting for Displaying the Electronic Level

The camera has the Electronic Level to detect the tilt of the camera. When the [Electronic Level] on the [ Rec. Mode] menu is set to  (On), the display can be switched to the Electronic Level display by pressing the **OK/DISPLAY** button in the capture mode. On the Normal Display or Detailed Display in the capture mode, the Tilt icon to indicate the tilt of the camera appears.

### 1 Press the MENU button in mode.

The [ Rec. Mode] menu appears.

### 2 Use the four-way controller (▲▼) to select [Electronic Level].

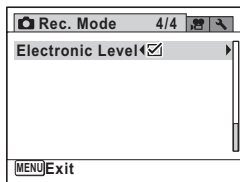

### 3 Use the four-way controller (◀▶) to select (On) or (Off).

- (On) The electronic level display and the tilt icon will be displayed (default).
- (Off) The electronic level display and the tilt icon will not be displayed.

## 4 Press the MENU button.

The camera returns to capture status.

### Tilt icon in the capture mode

- (green): The camera is level.
- △/D (yellow): The camera is tilted.
- /● (red): The camera is extremely tilted.

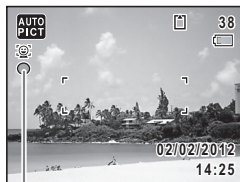

Tilt icon

For examples of the Electronic Level display  Electronic level display (p.26)





## Calling Up a Specific Function

You can assign a function to the Green button and recall it quickly by simply pressing the Green button. This is useful for going straight to the setting screens of frequently used functions.

The following functions can be assigned to the Green button:

-  (Green) Mode
- Recorded Pixels
- EV Compensation
- Sensitivity



- The Green button setting can be returned to its default setting by selecting [Reset] on the [ Setting] menu.
- The functions other than  (Green) mode can be set in the usual manner on the [ Rec. Mode] menu.
- You cannot save different settings for the same function on the Green button and on the [ Rec. Mode] menu.

## To Assign a Function to the Green Button

### 1 Press the MENU button in mode.

The [ Rec. Mode] menu appears.

### 2 Use the four-way controller ( ) to select [Green Button].

### 3 Press the four-way controller (▶).

A pull-down menu appears.

### 4 Use the four-way controller (▲▼) to choose a function and press the OK button.

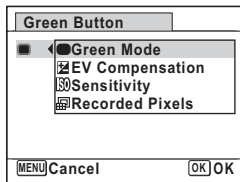

### 5 Press the MENU button.

The selected function is assigned to the Green button.

## To Use the Green Button

### 1 Press the Green button in mode.

The function assigned to the Green button is called up.

### 2 Use the four-way controller (◀▶) to change the settings and press the OK button.

The camera returns to capture status.



Taking Pictures in the Basic Mode (Green Mode)  p.72



If a function other than  (Green) mode has been assigned to the Green button, the camera returns to the original screen if no operation is performed for 1 minute after the Green button is pressed.

# Recording Movies

## Recording a Movie

This mode enables you to record movies. Sound is recorded at the same time.

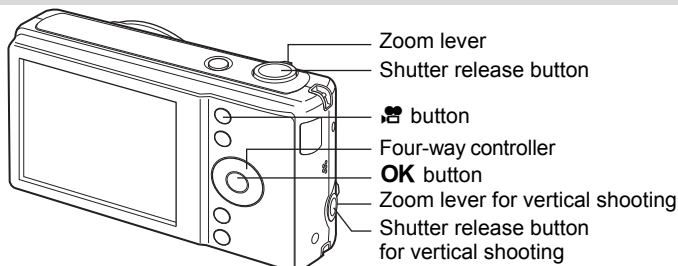

3

Taking Pictures

### 1 Point the camera at your subject in mode.

When the camera detects a person's face, the Face Detection function is activated and the face detection frame appears (p.69). (The frame disappears when recording starts.)

### 2 Press the button.

The camera automatically focuses on the subject and compensates the exposure. Recording starts.

You can continue recording until the built-in memory or the SD Memory Card is full, or the size of the recorded movie reaches 2 GB.

The following information appears on the display.

- 1 Movie icon
- 2 Recording (blinks)
- 3 Remaining recordable time
- 4 Focus frame (does not appear during recording)
- 5 Movie Shake Reduction icon

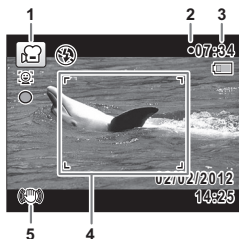

You can change the captured area by turning the zoom lever left or right.

▲ (Right)	Enlarges the subject.
▲▲▲ (Left)	Widens the area that is captured by the camera.

### 3

#### Press the button.



Recording stops.

Playing Back a Movie  p.133



- The flash does not discharge while recording a movie.
- The autofocus system does not operate while recording a movie.
- You can use the optical zoom only before recording, while the Digital Zoom is available both before and during recording.
- Recording does not start while a menu screen is being displayed or in the playback mode even if the  button is pressed.
- Even if Face Detection is set to [Smile], movie recording does not start with the Smile Capture function.
- You can use the optional remote control (p.93) to record movies while you are away from the camera.







#### To Keep the Button Pressed

If you keep the  button pressed for more than one second, recording will continue as long as you keep the button pressed. Shooting stops when you take your finger off the  button.









## Selecting the Recorded Pixels and Frame Rate for Movies

You can choose from the following recorded pixels and frame rate settings for movies.

The more pixels there are, the clearer the details and the bigger the file size. The more frames per second, the better the quality of the movie, but the file size becomes larger.

Setting	Recorded Pixels	Frame Rate	Use
	1280×720	30 fps	Records images in HDTV format (16:9). Movement is recorded smoothly. (default setting)
	1280×720	15 fps	Records images in HDTV format (16:9). Increases the maximum recording time by making the file size smaller.
	640×480	30 fps	Suitable for viewing on a TV or computer screen. Movement is recorded smoothly.
	640×480	15 fps	Suitable for viewing on a TV or computer screen. Increases the maximum recording time by making the file size smaller.
	320×240	30 fps	Suitable for posting on a website or attaching to an e-mail. Movement is recorded smoothly.
	320×240	15 fps	Suitable for posting on a website or attaching to an e-mail. Increases the maximum recording time by making the file size smaller.

\* The frame rate (fps) indicates the number of frames per second.

- 1 Press the MENU button in  mode.**  
The [ Rec. Mode] menu appears.
- 2 Press the four-way controller () or turn the zoom lever to the right (.**  
The [ Movie] menu appears.
- 3 Use the four-way controller ( ) to select [Recorded Pixels].**
- 4 Press the four-way controller (.**  
A pull-down menu appears.

- 5** Use the four-way controller (▲▼) to select the number of recorded pixels and frame rate.

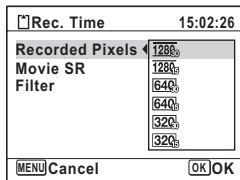

- 6** Press the OK button.

The setting is saved.

- 7** Press the MENU button.

The camera returns to capture status.

## Setting the Movie SR (Movie Shake Reduction) Function

You can correct camera shake while you are recording a movie with the Movie SR (Movie Shake Reduction) function.

- 1** Press the MENU button in mode.

The [ Rec. Mode] menu appears.

- 2** Press the four-way controller (▶) or turn the zoom lever to the right (Q).

The [ Movie] menu appears.

- 3** Use the four-way controller (▲▼) to select [Movie SR].

- 4** Use the four-way controller (◀▶) to select  or .

- Corrects camera shake.
- Does not correct camera shake.

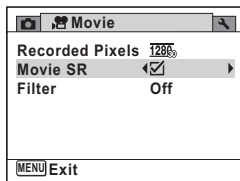

- 5** Press the MENU button.

The camera returns to capture status.

## Setting the Screen Effect for Recording a Movie

You can record a movie with various color tones or special effects.

Off	No effect (default)
B&W	For recording black and white movies
Sepia	For recording movies with sepia tone
Fish-eye	For simulating a fish-eye lens's barrel distortion curvature
Miniature	For blurring part of the image to create a fake miniature scene
Sketch	For simulating an artistic pencil drawing

3

Taking Pictures

### 1 Press the MENU button in mode.

The [ Rec. Mode] menu appears.

### 2 Press the four-way controller (▶), or turn the zoom lever to the right (Q).

The [ Movie] menu appears.

### 3 Use the four-way controller (▲▼) to select [Filter].

### 4 Press the four-way controller (▶).

The pull-down menu appears.

### 5 Use the four-way controller (▲▼) to select the filter.

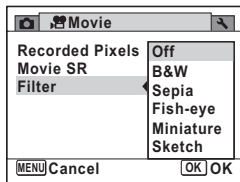

### 6 Press the OK button.



The setting is saved.

### 7 Adjust the effect when [Fish-eye] or [Miniature] is selected.

When [B&W], [Sepia] or [Sketch] is selected, skip this step.



**When [Fish-eye] is selected:**

Press the four-way controller (▶) then use the four-way controller (▲▼) to set the degree of effect.

	Fish-eye effect weak
	Fish-eye effect standard
	Fish-eye effect strong

**When [Miniature] is selected:**

Press the four-way controller (▶) then use the four-way controller (▲▼) to set the area to be blurred.

	Focuses on the bottom of the image and blurs the top.
	Focuses on the center of the image and blurs the top and bottom.
	Focuses on the top of the image and blurs the bottom.

**8****Press the MENU button.**

The camera returns to capture status.



- When [Fish-eye], [Miniature], or [Sketch] is selected, Movie SR is fixed at Off. The number of recorded pixels for movies is fixed at 640p.
- The settings for [Fish-eye] and [Miniature] on the movie menu are independent of the settings for still pictures.

# Saving the Settings (Memory)

The Memory function is for saving the current camera settings when the camera is turned off.

For some camera settings, the Memory function is always set to  (On) (the settings are saved when the camera is turned off), while for others you can choose  or  (Off) (to choose whether the settings are saved or not when the camera is turned off). The items which can be set to  or  in the Memory function are shown in the table below. (Items not listed here are always saved in the selected settings when the camera is turned off.)

If you select , the settings will be saved in the status they were in immediately before the camera was turned off. If you select , the settings will be reset to the defaults when the camera is turned off. The table below also shows whether the Memory default setting for each item is  or .

Item	Description	Default Setting	Page
Flash Mode	The flash mode set with the four-way controller (◀)	<input checked="" type="checkbox"/>	p.97
Drive Mode	The drive mode set with the four-way controller (▲)	<input type="checkbox"/>	p.90 p.92 p.93 p.95
Focus Mode	The focus mode set with the four-way controller (▶)	<input type="checkbox"/>	p.99
Zoom Position	The zoom position set with the zoom lever	<input type="checkbox"/>	p.74
MF Position	The manual focus position set with the four-way controller (▲▼)	<input type="checkbox"/>	p.100
White Balance	The [White Balance] setting on the [📷 Rec.Mode] menu	<input type="checkbox"/>	p.105
Sensitivity	The [Sensitivity] setting on the [📷 Rec.Mode] menu	<input type="checkbox"/>	p.109
EV Compensation	The [EV Compensation] setting on the [📷 Rec.Mode] menu	<input type="checkbox"/>	p.107
Face Detection	The [Face Detection] setting on the [📷 Rec. Mode] menu	<input type="checkbox"/>	p.117
Digital Zoom	The [Digital Zoom] setting on the [📷 Rec.Mode] menu	<input checked="" type="checkbox"/>	p.76
DISPLAY	The information display mode set with the <b>OK/DISPLAY</b> button	<input type="checkbox"/>	p.20
File No.	If a new SD Memory Card is inserted when On has been selected, file numbers are assigned sequentially.	<input checked="" type="checkbox"/>	—

---

**1** Press the **MENU** button in **📷** mode.

The [📷 Rec.Mode] menu appears.

---

**2** Use the four-way controller (▲▼) to select [Memory].

---

**3** Press the four-way controller (▶).

The [Memory] screen appears.

---

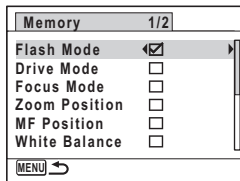
**4** Use the four-way controller (▲▼) to choose an item.

---

**5** Use the four-way controller (◀▶) to select  (On) or  (Off).

---

**6** Press the **MENU** button twice.

The camera returns to capture status.

## Memo

# 4 Playing Back and Deleting Images

---

Playing Back Images .....	132
Deleting Images .....	142
Connecting the Camera to AV Equipment .....	149

# Playing Back Images

## Playing Back Still Pictures

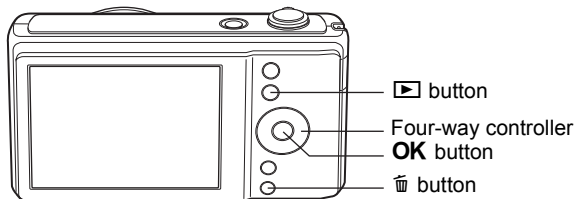

4

Playing Back and Deleting Images

### 1 Press the ▶ button after taking a picture.

The camera enters the ▶ mode and the captured image appears on the display (single-image display).

File number



### To Play Back the Previous or Next Image

### 2 Press the four-way controller (◀▶).

The previous or next image appears.

### To Delete the Displayed Image

Press the 🗑 button while the image is displayed to display the Delete screen. Press the four-way controller (▲) to select [Delete] and press the OK button.





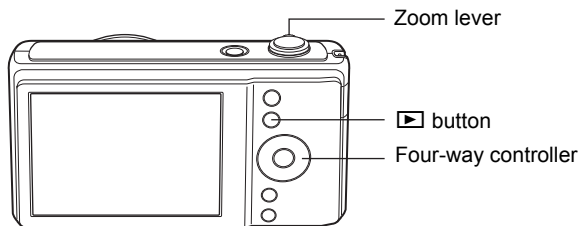

For information on other deletion procedures see p. 142

## Playing Back a Movie

You can play back the movies you have taken. Sound is played back at the same time. You can also play back images taken with  (16-frame shooting) mode in the same way as you play back movies.









**1** In  mode, use the four-way controller ( ) to choose the movie you want to play back.



**2** Press the four-way controller (). Playback starts.



### Available operations during playback

Zoom lever to the right (  )	Increases the volume.
Zoom lever to the left (  )	Reduces the volume.
Four-way controller (  )	Pauses playback.
Four-way controller (  ) held down	Fast-forwards playback while the button is held down.
Four-way controller (  )	Plays back in reverse.
Four-way controller (  ) held down	Fast-reverses playback while the button is held down.

### Available operations while playback is paused

Four-way controller (  )	Resumes playback.
Four-way controller (  )	Forwards the frame.
Four-way controller (  )	Reverses the frame.

Green button

Saves the paused frame of a series of images taken with **16** (16-frame shooting) mode as a single image in **640** (640×480) pixels.

### 3 Press the four-way controller (▼). Playback stops.

## Multi-Image Display

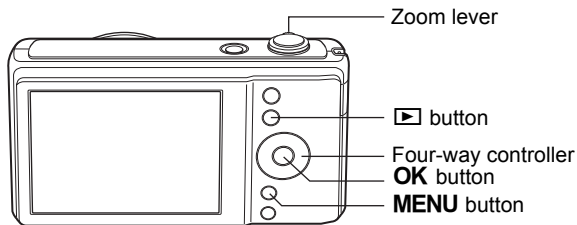

4

## Four-Image Display/Nine-Image Display

You can display four or nine thumbnails of captured images at a time.

### 1 In ▶ mode, turn the zoom lever to the left (☒).

The four-image display appears showing a page consisting of four thumbnail images. Turn the zoom lever to the left (☒) again to switch to nine-image display.

A page consisting of four or nine thumbnail images appears. The displayed images change four or nine images at a time page by page.

Use the four-way controller (▲▼◀▶) to move the frame. If there are too many images to display on one page, pressing the four-way controller (▲◀) while the image ① is selected will display the previous page. Similarly, if you choose image ② and press the four-way controller (▼▶), the next page appears.

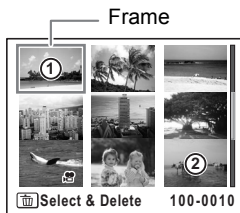
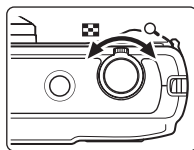



Nine-image display

The icons that appear on the images indicate the following:

(No icon)	Still picture
	Movie (the first frame appears)

Press the **OK** or **MENU** button to switch to single-image display of the selected image.

Press the  or shutter release button to switch to  mode.

## Folder Display/Calendar Display



In nine-image display, turn the zoom lever to the left () to switch to folder display or calendar display. Press the Green button to switch between folder display and calendar display.

### 1 In mode, turn the zoom lever to the left () three times.

The screen changes to folder display or calendar display.

#### Folder display

The list of folders with recorded images appears.

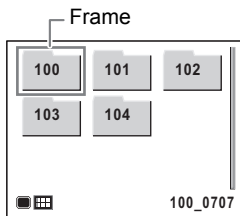

Four-way controller (  )	Moves the frame.
Zoom lever to the right (  )/ <b>OK</b> button	Displays the images in the selected folder in nine-image display.
<b>MENU</b> button	Returns to nine-image display.



#### Calendar display

Images are displayed by date in calendar format.

A thumbnail of the first image recorded on each date is displayed on the calendar.

Four-way controller (  )	Moves the frame.
Zoom lever to the right (  )	Displays the images for that date in nine-image display.

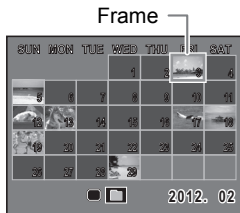

<b>OK</b> button	Displays the first image recorded on that date in single-image display.
<b>MENU</b> button	Returns to nine-image display.

## Using the Playback Function

Press the four-way controller (▼) in mode to display the Playback Mode Palette.

You can display the playback function you want to use simply by using the four-way controller (▲▼◀▶) to choose an icon and pressing the **OK** button.

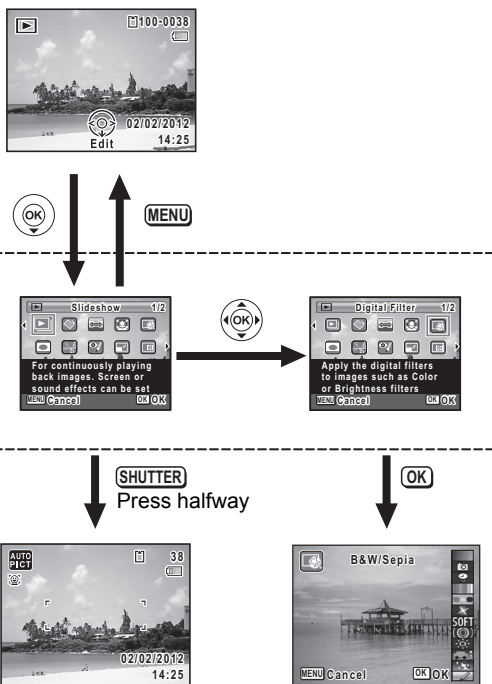

Closes the Playback Mode Palette and goes to mode.

Goes to the screen for selected playback function.











When an icon is selected in the Playback Mode Palette, a guide for the selected function appears.

## Playback Mode Palette

Playback Mode		Description	Page
	Slideshow	For continuously playing back images. Screen or sound effects can be set.	p.138
	Image Rotation	Rotates captured images. Useful when viewing vertical images on a TV.	p.140
	Stretch Filter	Stretches or elongates a user-selected area of image (4:3 to 16:9).	p.154
	Small Face Filter	Reduces the size of faces in the image, for well-proportioned portraits.	p.156
	Digital Filter	Apply the digital filters to images such as Color or Brightness filters.	p.158
	Frame Composite	For composing an image with a frame. Select Overwrite or Save as to save.	p.163
	Save as Still Image	For saving one frame from a movie as a still picture.	p.167
	Divide Movies	For dividing a movie into two.	
	Red-eye Compensation	For compensating red-eye. May not work due to the condition of the image.	p.162
	Resize	Changes Recorded Pixels to make the file size smaller.	p.152
	Cropping	For cropping images to the size you like. Saved as a new image.	p.153
	Image Copy	To copy images between the built-in memory and an SD Memory Card.	p.168
	Protect	Protects images from delete function. Format function still erases all.	p.146
	DPOF	For the print settings. Useful when printing at a printing service.	p.171
	Start-up Screen	For setting a captured image as the Start-up Screen.	p.189

## Slideshow

You can play back recorded images one after another.







- 1** Enter the  mode and use the four-way controller ( ) to choose an image to start the slideshow with.
- 2** Press the four-way controller ().  
The Playback Mode Palette appears.
- 3** Use the four-way controller (   ) to select  (Slideshow).



- 4** Press the **OK** button twice.  
The slideshow starts.  
Pressing the **OK** button during the slideshow pauses the slideshow. To resume the slideshow, press the **OK** button again.
- 5** Press any button other than the **OK** button.  
The slideshow stops.

### To Set the Slideshow Conditions

You can set the playback interval and also a screen effect and sound effect for when one image changes to the next.

- 1** Press the four-way controller () in  mode.  
The Playback Mode Palette appears.
- 2** Use the four-way controller (   ) to select  (Slideshow).
- 3** Press the **OK** button.  
The screen for setting the slideshow conditions appears.

- 4** Use the four-way controller (▲▼) to select [Interval].

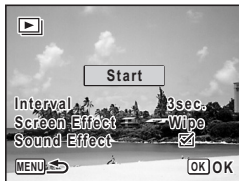

- 5** Press the four-way controller (▶).

A pull-down menu appears.

- 6** Use the four-way controller (▲▼) to change the interval and press the OK button.

Choose from [3sec.], [5sec.], [10sec.], [20sec.], or [30sec.].

- 7** Use the four-way controller (▲▼) to select [Screen Effect].

After selecting [Screen Effect], press the four-way controller (▶). A pull-down menu appears with the following items. Use the four-way controller (▲▼) to select an item and press the OK button.

Wipe	The next image slides over the previous one from left to right.
Checker	The next image appears in small square mosaic blocks.
Fade	The current image gradually fades out and the next image fades in.
Off	No effect

- 8** Use the four-way controller (▲▼) to select [Sound Effect].

- 9** Use the four-way controller (◀▶) to select  (On) or  (Off).

Except when the [Screen Effect] is set to [Off], you can choose  (On) or  (Off) for the sound that is played when one image changes to the next.

- 10** Use the four-way controller (▲▼) to select [Start] and press the OK button.

The slideshow starts using the selected interval and effect.



- The slideshow will continue until you press any button other than the **OK** button.
- Movies will normally be played through to the end before the next picture is played back, regardless of the interval setting. However, pressing the four-way controller (▶) while playing back a movie skips to the next image.
- Panorama images will be scrolled for display from left to right in 4 seconds before the next picture is played back, regardless of the settings of [Interval] or [Screen Effect].

Connecting the Camera to AV Equipment p.149

4

## Rotating the Image

### 1 Press the button after taking a picture.

The image appears on the display.

### 2 Press the four-way controller (▼).

The Playback Mode Palette appears.

### 3 Use the four-way controller (▲▼◀▶) to select (Image Rotation) and press the **OK** button.

The rotation selection screen (0°, Right 90°, Left 90°, or 180°) appears.

### 4 Use the four-way controller (▲▼◀▶) to choose the rotation direction and press the **OK** button.

The rotated image is saved.

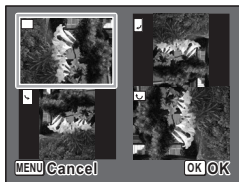

- Movies cannot be rotated.
- Protected images can be rotated, but they cannot be saved in a rotated state.

## Zoom Playback

You can magnify an image up to ten times.

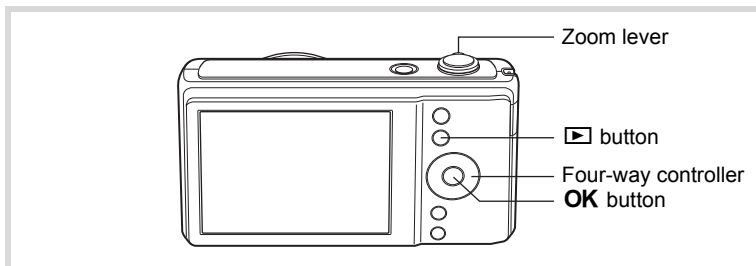

**1** Enter the mode and use the four-way controller ( ) to choose the image you want to magnify.

**2** Turn the zoom lever to the right () .

The image is magnified ( $\times 1.1$  to  $\times 10$ ). Continuing to turn the zoom lever to the right () changes the magnification continuously.

You can use the guide mark “+” appears at the bottom left of the screen to check which portion of the image is magnified.

**Available operations while an image is magnified**

Four-way controller (   )	Moves the position to be magnified.
Zoom lever to the right ()	Makes the image bigger (max. $\times 10$ ).
Zoom lever to the left ()	Makes the image smaller (min. $\times 1.1$ ).

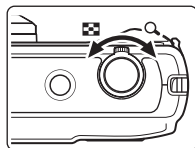

Guide

**3** Press the OK button.

The image returns to single-image display.



Images taken with (16-frame shooting) mode and movies cannot be magnified.

# Deleting Images

Delete images with mistakes or that are unnecessary.

## Deleting a Single Image

You can delete a single image.



Protected images cannot be deleted (p.146).

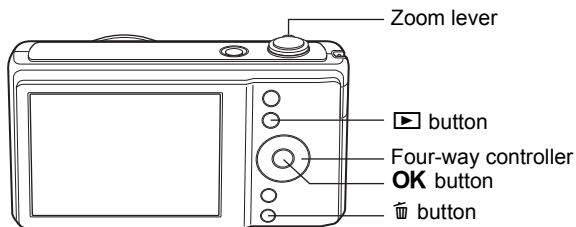

4

**1** Enter the ▶ mode and use the four-way controller (◀▶) to choose the image you want to delete.

**2** Press the 🗑 button.  
A confirmation screen appears.

**3** Use the four-way controller (▲▼) to select [Delete].



**4** Press the OK button.  
The image is deleted.

## Deleting Selected Images

You can delete several images selected from the four-image or nine-image display at once.



Protected images cannot be deleted.

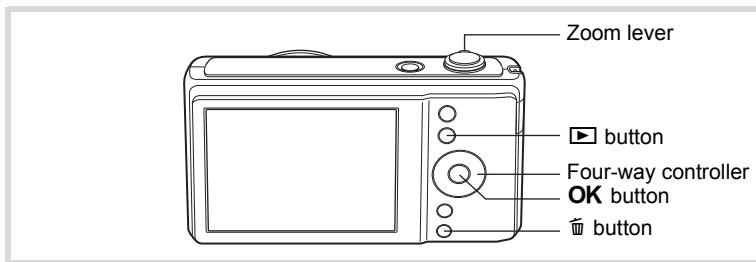

- 1 In ▶ mode, turn the zoom lever to the left (📷) once or twice.**

Four-image display or nine-image display appears.

- 2 Press the 🗑 button.**  
☐ appears on the images.



### 3 Use the four-way controller (▲▼◀▶) to choose the images you want to delete and press the OK button.

☑ appears on the selected image.

If you select an image and turn the zoom lever to the right (Q), the selected image appears in single-image display as long as the lever is turned, enabling you to check whether you really want to delete it or not. (The display returns to four-/nine-image display when you release the lever.) However, protected images cannot be displayed in single-image display.



### 4 Press the button.

A confirmation dialog appears.

### 5 Use the four-way controller (▲▼) to select [Select & Delete].



### 6 Press the OK button.

The selected images are deleted.

## Deleting All Images

You can delete all the images at once.



Protected images cannot be deleted (p.146).

### 1 Press the MENU button in mode.

The [ Setting] menu appears.

When you press the MENU button in mode, press the four-way controller () once.

### 2 Use the four-way controller ( ) to select [Delete all].

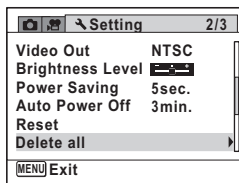

### 3 Press the four-way controller () .

The [Delete all] screen appears.

### 4 Use the four-way controller ( ) to select [Delete all].

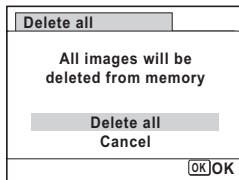

### 5 Press the OK button.

All the images are deleted.

## Protecting Images from Deletion (Protect)

You can protect stored images from being accidentally deleted.

- 1 Press the four-way controller (▼) in [▶] mode.**

The Playback Mode Palette appears.

- 2 Use the four-way controller (▲▼◀▶) to select [Protect].**



- 3 Press the OK button.**

The screen for selecting [Single Image] or [All Images] appears.

- 4 Use the four-way controller (▲▼) to select [Single Image].**



- 5 Press the OK button.**

The message [Protects this image] appears. To protect another image, use the four-way controller (◀▶) to select another image.

- 6 Use the four-way controller (▲▼) to select [Protect].**



## 7 Press the OK button.

The selected image is protected.



- To cancel the protection of the image, select [Unprotect] in Step 6.
- appears below the file number on protected images during playback.
- The maximum number of images you can protect in succession with [Single Image] is 99.

## To Protect All Images

### 1 Press the four-way controller (▼) in mode.

The Playback Mode Palette appears.

### 2 Use the four-way controller (▲▼◀▶) to select (Protect).

### 3 Press the OK button.

The screen for selecting [Single Image] or [All Images] appears.

### 4 Use the four-way controller (▲▼) to select [All Images].



### 5 Press the OK button.

### 6 Use the four-way controller (▲▼) to select [Protect].

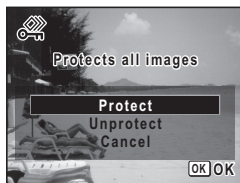

7

## Press the OK button.

All the images are protected.



Protected images will be deleted when the SD Memory Card/built-in memory is formatted (p.176).



To cancel the protection of all your images, select [Unprotect] in Step 6.

4

# Connecting the Camera to AV Equipment

By using the optional AV cable (I-AVC7), you can capture and play back images on equipment with a video IN jack, such as a TV. Make sure the camera and TV are turned off before connecting the camera to the TV.

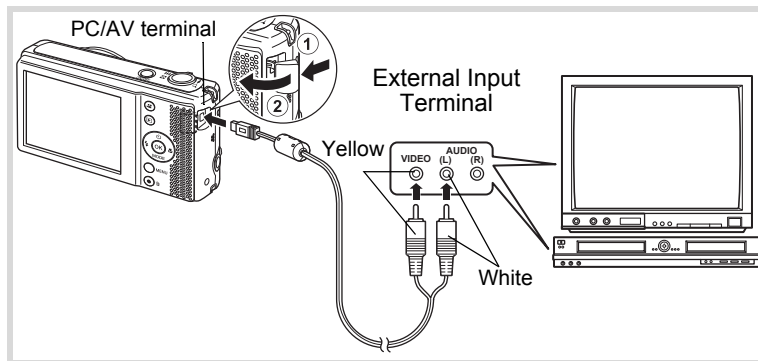

- 1 Connect the AV cable to the PC/AV terminal.**  
Connect the terminal of the AV cable with ⇐ pointing toward the ◀ on the PC/AV terminal of the camera.
- 2 Connect the other ends of the AV cable (yellow: video, white: audio) to the video input terminal and audio input terminal of the AV device.**  
When using stereo sound equipment, insert the sound terminal into the L (white) terminal.
- 3 Turn the AV device on.**  
When the device that the camera is connected to and the device that plays back images are different, turn both devices on.  
When viewing images on AV equipment with multiple video input terminals (such as a TV), refer to the operation manual of the device and select the video input terminal to which the camera is connected.



- It is recommended to use the optional AC adapter kit K-AC122 if you intend to use the camera for a long time (p.35).
- Depending on the country or region, images and movie files may fail to be played back if the video output format is set differently from the one in use there. If this happens, change the video output format setting (p.185).
- The camera display turns off while the camera is connected to AV equipment.
- Volume cannot be adjusted with the zoom lever while the camera is connected to AV equipment.
- When the camera is connected to an AV equipment, you can forward/reverse the images with the remote control (optional).

# 5 Editing and Printing Images

---

<b>Editing Images .....</b>	<b>152</b>
<b>Setting the Printing Service (DPOF) .....</b>	<b>171</b>

## **About printing**

The following options are available for printing images taken with this camera.

- 1 Use a printing service.**
- 2 Use your printer with an SD Memory Card slot to print directly from the SD Memory Card.**
- 3 Use your computer's software to print images.**

## Changing the Image Size (Resize)

By changing the size of a selected image, you can make the file size smaller than the original. You can use this function to continue taking pictures when the SD Memory Card or the built-in memory is full, by making the images smaller and overwriting the original images to make more space available.



- Images taken with **2M 1699**, images taken with **16** (16-frame shooting) mode, panoramic images and movies cannot be resized.
- You cannot select a larger resolution than that of the original image.

**1** Enter the mode and use the four-way controller (**◀▶**) to choose the image you want to resize.

**2** Press the four-way controller (**▼**).  
The Playback Mode Palette appears.

**3** Use the four-way controller (**▲▼◀▶**) to select (**Resize**).



**4** Press the **OK** button.  
The screen for choosing the size appears.

- 5** Use the four-way controller (◀▶) to select [Recorded Pixels].



- 6** Press the OK button.

A confirmation dialog for overwriting the image appears.

If the selected image is protected, the processed image is saved as a new image and the following confirmation dialog does not appear.

- 7** Use the four-way controller (▲▼) to select [Overwrite] or [Save as].

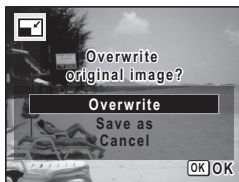

- 8** Press the OK button.

The resized image is saved.

## Cropping Images

You can delete the unwanted part of a picture and save the cropped image as a separate image.



Images taken with **2M 16:9**, panoramic images, images taken with  (16-frame shooting) mode and movies cannot be cropped.

- 1** Enter the  mode and use the four-way controller (◀▶) to choose the image you want to crop.

- 2** Press the four-way controller (▼).

The Playback Mode Palette appears.

- 3 Use the four-way controller (▲▼◀▶) to select  (Cropping).**



- 4 Press the OK button.**

The cropping screen appears.

The largest size of the cropped image is shown with a green frame on the screen. The cropped image cannot be larger than this cropping frame size.

- 5 Choose the cropping conditions.**

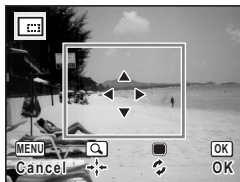

The following operations move the green frame and set the area for cropping on the screen.

Zoom lever	Changes the size of the cropping frame.
Four-way controller (▲▼◀▶)	Moves the cropping frame up, down, left and right.
Green button	Rotates the cropping frame.

- 6 Press the OK button.**

The cropped image is saved with a new file name.

The number of recorded pixels is selected automatically according to the size of the cropped image.

## Stretching a User-Selected Area of an Image (Stretch Filter)

For stretching a user-selected area of a 4:3 image and storing it as a 16:9 image.

**1** In  mode, use the four-way controller (◀▶) to choose the image you want to edit.

**2** Press the four-way controller (▼).

The Playback Mode Palette appears.

**3** Use the four-way controller (▲▼◀▶) to select  (Stretch Filter).



**4** Press the OK button.

The message [Specify the position and area of effect for stretch] appears and the adjustment screen is displayed.

**5** Use the four-way controller (◀▶) to move the area of effect for stretching.

Four-way controller (◀)	Moves the area of effect for stretching left.
Four-way controller (▶)	Moves the area of effect for stretching right.

**6** Turn the zoom lever left or right to adjust the width of the area of effect for stretching.

Zoom lever to the left (ⓧ)	Makes the area of effect narrower.
Zoom lever to the right (Ⓚ)	Makes the area of effect wider.

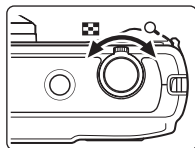

## 7 Press the OK button.

A confirmation dialog for overwriting the image appears.

## 8 Use the four-way controller (▲▼) to select [Overwrite] or [Save as].

## 9 Press the OK button.

The stretched image is saved.

The number of recorded pixels of a new image becomes  $\frac{12M}{16M}$  for an image taken with  $\frac{16M}{16M}$ , or  $\frac{2M}{16M}$  for an image taken with less than  $\frac{16M}{16M}$ .



## Processing Images to Make Faces Look Smaller

Images are processed to reduce the size of people's faces detected with the Face Detection function (p.69) when taking pictures so that they look smaller.

## 1 In mode, use the four-way controller (◀▶) to choose the image you want to edit.

## 2 Press the four-way controller (▼).

The Playback Mode Palette appears.

## 3 Use the four-way controller (▲▼◀▶) to select (Small Face Filter).



## 4 Press the OK button.

Face detection frames for faces that can be corrected are displayed. Proceed to Step 6 when there is only one detection frame.

## 5 Use the four-way controller (▲▼◀▶) to select a face to be processed.

A green frame indicates the face that is to be processed.

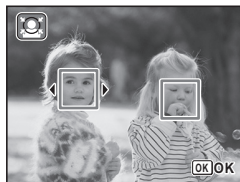

## 6 Press the OK button.

## 7 Use the four-way controller (◀▶) to change the reduction ratio.

- ▣ — +    Approx. 5%
- ▣ — +    Approx. 7%
- ▣ — +    Approx. 10%



## 8 Press the OK button.

A confirmation dialog for overwriting the image appears. If the selected image is protected, the processed image is saved as a new image and the following confirmation dialog does not appear.

## 9 Use the four-way controller (▲▼) to select [Overwrite] or [Save as].



## 10 Press the OK button.

The camera returns to  mode and the processed image is displayed.



You may not be able to process images in the following situations:

- When the size of face taken in relation to an image is too large or too small
- When faces are located in the edges of an image









In such cases, the face detection frame in Step 4 will not appear.

## Using the Digital Filters

This mode lets you change the color tones and perform special processing on a selected image.

B&W/Sepia	Processes the image using the B&W or sepia filter.
Toy Camera	Processes the image that looks as though it was shot with a toy camera.
Retro	Processes the image into one that has the look of an old photo.
Color	Processes the image using the selected color filter. You can choose from six filters: red, pink, purple, blue, green, and yellow.
Extract Color	Extracts only a specific color and processes the rest of the image into black and white. You can choose from three filters: red, green, and blue.
Starburst	Processes the image of night scenes or lights reflected on water with a special sparkling look achieved by adding effects to the image's highlights. You can choose from three filters: Cross, Heart and Star.
Soft	Processes the image into a soft image that appears soft overall.
Fish-eye	Creates an image that looks as though it was shot with a fish-eye lens.
Brightness	Adjusts the brightness of the image.
Miniature	Blurs part of the image to create a fake miniature scene.
Natural Skin Tone	Enhances skin tones while smoothing blemishes.
Sketch	Processes the image to simulate an artist's pencil drawing.

5

- 1** Enter the  mode and use the four-way controller ( ) to choose the image you want to edit.
- 2** Press the four-way controller ().  
The Playback Mode Palette appears.
- 3** Use the four-way controller (   ) to select  (Digital Filter).



## 4 Press the OK button.

The digital filter selection screen appears.

- 1 B&W/Sepia
- 2 Toy Camera
- 3 Retro
- 4 Color
- 5 Extract Color
- 6 Starburst
- 7 Soft
- 8 Fish-eye
- 9 Brightness
- 10 Miniature
- 11 Natural Skin Tone
- 12 Sketch

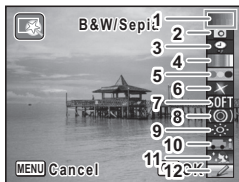

### For Soft / Natural Skin Tone / Sketch

## 5 Use the four-way controller (▲▼) to choose a digital filter.

The preview image of the result of the filter effect appears.

## 6 Press the OK button.

A confirmation dialog for overwriting the image appears.

If the selected image is protected, the processed image is saved as a new image and the following confirmation dialog does not appear.

## 7 Use the four-way controller (▲▼) to select [Overwrite] or [Save as].

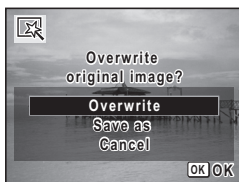

## 8 Press the OK button.

Images processed with the filter are saved with the same number of recorded pixels as the original image.

**5** Use the four-way controller (▲▼) to choose a digital filter.

**6** Use the four-way controller (◀▶) to choose the effect.



B&W/Sepia	B&W ↔ Sepia
Retro	Blue ↔ Original image ↔ Amber
Color	Red ↔ Pink ↔ Purple ↔ Blue ↔ Green ↔ Yellow
Extract Color	Red ↔ Green ↔ Blue
Starburst	Cross ↔ Heart ↔ Star
Miniature	Blurs upper ↔ Blurs upper and lower ↔ Blurs lower

**7** Press the **OK** button.

A confirmation dialog for overwriting the image appears.

If the selected image is protected, the processed image is saved as a new image and the following confirmation dialog does not appear.

**8** Use the four-way controller (▲▼) to select [Overwrite] or [Save as].

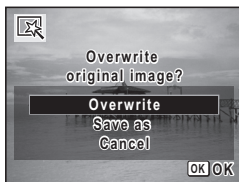

**9** Press the **OK** button.

Images processed with the filter are saved with the same number of recorded pixels as the original image.

- 5** Use the four-way controller (▲▼) to choose a digital filter.
- 6** Use the four-way controller (◀▶) to adjust the effect.

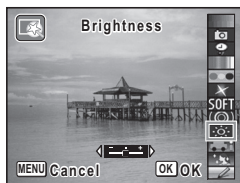

	Four-way controller (◀)	Default Setting	Four-way controller (▶)
Toy Camera	Weak	Standard	Strong
Fish-eye	Weak	Medium	Strong
Brightness	Dark	Standard	Bright

- 7** Press the **OK** button.

A confirmation dialog for overwriting the image appears.

If the selected image is protected, the processed image is saved as a new image and the following confirmation dialog does not appear.

- 8** Use the four-way controller (▲▼) to select **[Overwrite]** or **[Save as]**.

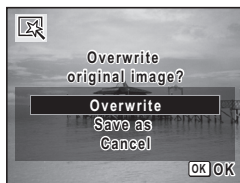

- 9** Press the **OK** button.

Images processed with the filter are saved with the same number of recorded pixels as the original image.



Panoramic images, movies or images taken with another camera cannot be edited using Digital Filter function. An error message appears if you choose this function from the Playback Mode Palette and press the **OK** button.





## Compensating for an Unwanted Red-eye Effect

You can correct images where the flash has caused the subject to appear with red eyes.

**1** Enter the  mode and use the four-way controller ( ) to choose the image you want to correct.

**2** Press the four-way controller ().

The Playback Mode Palette appears.

**3** Use the four-way controller (   ) to select  (Red-eye Compensation).

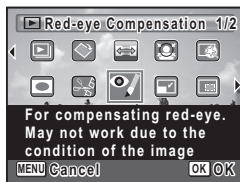

**4** Press the OK button.

A confirmation dialog for overwriting the image appears.

If the selected image is protected, the processed image is saved as a new image and the following confirmation dialog does not appear.

**5** Use the four-way controller ( ) to select [Overwrite] or [Save as].

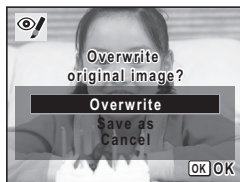

**6** Press the OK button.

The processed image is saved with the same number of recorded pixels as the original.



- The red-eye compensation function can only be used with still pictures taken with this camera.
- The red-eye compensation function cannot be used on panoramic images, images taken with (16-frame shooting) mode or on images where red eyes cannot be detected on the camera. An error message appears in Step 4.

## Adding a Frame (Frame Composite)

This function lets you add a decorative frame to still pictures. There are 3 frames already stored in the camera.

**1** Enter the mode and use the four-way controller (◀▶) to choose the image to which you want to add a frame.

**2** Press the four-way controller (▼).  
The Playback Mode Palette appears.

**3** Use the four-way controller (▲▼◀▶) to select (Frame Composite).

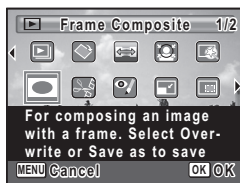

**4** Press the **OK** button.  
A 9-frame display of the frame selection screen appears.

**5** Use the four-way controller (▲▼◀▶) to choose a frame.

**6** Turn the zoom lever to the right (Q).  
The selected frame appears in single-image display.



You can choose another frame using either of the following operations.

Four-way controller (◀▶) Press to choose a different frame.

Zoom lever to the left (⊞) Returns to the 9-frame display of the frame selection screen, and then perform Step 5 to choose a different frame.

## 7 Press the OK button.

The image position and size adjustment screen appears.

Use the four-way controller (▲▼◀▶) to adjust the position of the image, and use the zoom lever to make the image larger or smaller.

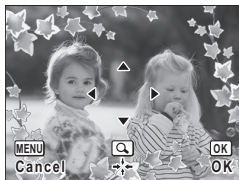

## 8 Press the OK button.

A confirmation dialog for overwriting the image appears.

If the selected image is protected, the processed image is saved as a new image and the following confirmation dialog does not appear.

## 9 Use the four-way controller (▲▼) to select [Overwrite] or [Save as].



## 10 Press the OK button.

The processed image is saved with the recorded pixels of **3M**.



The Frame Composite function cannot be used on images taken with **12M 16:9**, **12M 16:9** or **2M 16:9**, panoramic images, images taken with **16:9** (16-frame shooting) mode, movies or images of size smaller than **3M**. An error message appears in Step 4.

## Optional Frames

In addition to the built-in frames, the CD-ROM (S-SW122) contains a total of 90 optional frames. These frames can be stored either in the built-in memory or on SD Memory Cards. To save the optional frames into the built-in memory, do so after removing the SD Memory Card.

### To Copy Frames

- 1 Remove the SD Memory Card from the camera.**  
If you leave the SD Memory Card in the camera, the frames will be copied onto the card, not into the camera's built-in memory.
- 2 Connect the camera to the computer using the provided USB cable.**  
See "Connecting with Computers" in chapter 7 for instructions on connecting the camera to a computer.
- 3 When the device detection window opens, click [Cancel].**
- 4 Insert the CD-ROM (S-SW122) into the CD-ROM drive.**
- 5 When the top screen opens, click [EXIT].**
- 6 If there is not already a "FRAME" folder in the root directory of the camera (removable disk), create the folder.**
- 7 Copy the desired files from the FRAME folder in the root directory of the CD-ROM to the FRAME folder on the camera (removable disk).**  
For information on working with files on your computer, refer to the instruction manual supplied with the computer.
- 8 Disconnect the USB cable from the computer and camera.**  
See "Connecting with Computers" in chapter 7 for instructions on disconnecting the cable.

- Frames can be stored both in the built-in memory and on SD Memory Cards, but using large numbers of frames may slow down processing speed.

## To Use a New Frame

Frames downloaded from the PENTAX website or other source can be used for adding a frame to pictures.



- Extract the downloaded frame and copy it to the FRAME folder in the built-in memory or the SD Memory Card.
- The FRAME folder is created when the SD Memory Card is formatted with this camera.
- For more information on downloading, refer to the PENTAX website.

## Editing Movies

You can select a frame from the recorded movie to save as a still picture or divide a movie into two.

5

**1** In mode, use the four-way controller (◀▶) to choose the movie you want to edit.

**2** Press the four-way controller (▼).  
The Playback Mode Palette appears.

**3** Use the four-way controller (▲▼◀▶) to select (Movie Editing).



**4** Press the OK button.  
The movie edit selection screen appears.  
Subsequent steps vary depending on your selection.



## To Save a Frame from a Movie as a Still Picture

**5** Select [Save as Still Image] on the movie edit selection screen.

**6** Press the **OK** button.

The screen appears for selecting a frame to be saved as a still picture.

**7** Use the four-way controller (**▲▼◀▶**) to choose the frame you want to save.

- ▲ Plays or pauses the movie
- ▼ Stops the movie and returns to the first frame
- ◀ Reverses the movie frame by frame
- ▶ Advances the movie frame by frame



**8** Press the **OK** button.

The selected frame is saved as a still picture.

## To Divide a Movie

**5** Select [Divide Movies] on the movie edit selection screen.

**6** Press the **OK** button.

The screen for choosing the dividing position appears.

**7** Use the four-way controller (**▲▼◀▶**) to determine the dividing position.

- ▲ Plays or pauses the movie
- ▼ Stops the movie and returns to the first frame
- ◀ Reverses the movie frame by frame
- ▶ Advances the movie frame by frame



- 8** Press the **OK** button.  
A confirmation dialog appears.

- 9** Use the four-way controller (**▲▼**) to select **[Divide]**.

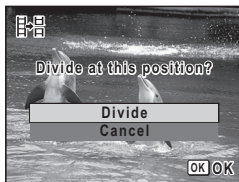

- 10** Press the **OK** button.  
The movie is divided at the specified position, the two portions are saved as new files, and the original one is deleted.



The protected movies cannot be divided.

5

## Copying Images

You can copy images from the built-in memory to the SD Memory Card and vice versa. This function can only be selected when an SD Memory Card has been inserted in the camera.



Make sure that the camera is turned off before inserting or removing the SD Memory Card.

- 1** Press the four-way controller (**▼**) in **[▶]** mode.  
The Playback Mode Palette appears.

- 2** Use the four-way controller (**▲▼◀▶**) to select **[Image Copy]** (Image Copy).

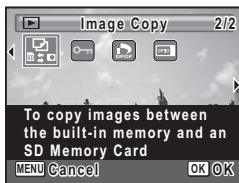

### 3 Press the OK button.

The copying method selection screen appears.

#### To Copy Files from the Built-in Memory to the SD Memory Card

All the images in the built-in memory are copied to the SD Memory Card at once. Before copying the images, make sure that there is enough space on the SD Memory Card.

### 4 Use the four-way controller (▲▼) to select [●→SD].

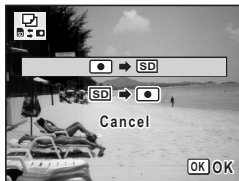

### 5 Press the OK button.

All the images are copied.

#### To Copy Files from the SD Memory Card to the Built-in Memory

Selected images from the SD Memory Card are copied to the built-in memory one by one at a time.

### 4 Use the four-way controller (▲▼) to select [SD→●].

### 5 Press the OK button.

### 6 Use the four-way controller (◀▶) to select the image you want to copy.



### 7 Press the OK button.

The selected image is copied.



When a file is copied from the SD Memory Card to the built-in memory, it is assigned a new file name.

# Setting the Printing Service (DPOF)

DPOF (Digital Print Order Format) is the format for storing print order data on still pictures captured with a digital camera. Once the print order data has been stored, the pictures can be printed according to the DPOF settings using a DPOF-compatible printer or photo processing lab. You cannot store print order data for movies.



If the picture already has the date and/or time imprinted on it (p.118), do not set [Date] to  (On) in DPOF setting. If you select , the imprinted date and/or time may overlap.

## Printing Single Images

Set the following items for each image.

Copies	Choose the number of copies up to 99.
Date	Specify whether you want the date inserted on the print or not.

**1** In mode, press the four-way controller (▼).  
The Playback Mode Palette appears.

**2** Use the four-way controller (▲▼◀▶) to select (DPOF).

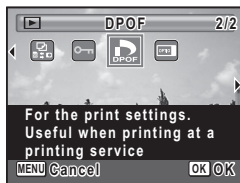

**3** Press the OK button.  
The screen for selecting [Single Image] or [All Images] appears.

- 4** Use the four-way controller (▲▼) to select [Single Image].



- 5** Press the **OK** button.

The message [Applies DPOF settings to this image] appears.

To apply DPOF settings for another image, use the four-way controller (◀▶) to select another image.

If DPOF settings have already been applied for an image, the previous number of copies and date setting ( or ) will be displayed.

- 6** Use the four-way controller (▲▼) to choose the number of copies.



- 7** Use the **Green** button to choose whether to insert the date or not.

(On) The date will be imprinted.

(Off) The date will not be imprinted.

To continue setting DPOF print order data, use the four-way controller (◀▶) to choose another image and repeat Steps 6 and 7.

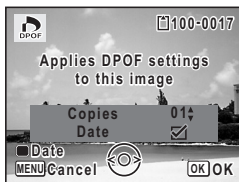

- 8** Press the **OK** button.

The settings are saved and the screen returns to the DPOF menu.





Depending on the printer or printing equipment at the photo processing lab, the date may not be imprinted on the pictures even if  (On) is selected in the DPOF setting.



To cancel DPOF settings, set the number of copies to [00] in Step 6 and press the **OK** button.

## Printing All Images

When you choose the number of copies and whether or not to insert the date, the settings are applied to all the images stored in the camera.

- 1 Display the screen for DPOF settings in  mode.**  
Refer to Steps 1 to 3 on p.171.
- 2 Use the four-way controller ( ) to select [All Images].**
- 3 Press the OK button.**  
The message [Applies DPOF settings to all images] appears.
- 4 Choose the number of copies and whether to insert the date or not.**  
Refer to Steps 6 and 7 in “Printing Single Images” on p.172 for details on how to make the settings.
- 5 Press the OK button.**  
The settings for all the images are saved and the camera returns to the DPOF setting screen.



The number of copies specified in the [All Images] setting applies to all the images. Before printing, check that the number is correct.



Settings for single images are canceled when settings are made with [All Images].



# 6 Settings

---

Camera Settings .....	176
-----------------------	-----

## Formatting the Memory

Formatting deletes all the data on the SD Memory Card/built-in memory. Be sure to use this camera to format (initialize) an SD Memory Card that is unused or has been used on other cameras or digital devices.

**Caution**



- Do not remove the SD Memory Card during formatting as this may damage the card and render it unusable.
- Formatting deletes all the data on the card, including protected images and images recorded with a computer or camera other than this camera.
- SD Memory Cards formatted on a computer or device other than this camera cannot be used. Be sure to format the card with this camera.
- When the SD Memory Card is inserted to the camera, the SD Memory Card will be formatted. To format the built-in memory, be sure to operate after taking out the SD Memory Card.
- The optional frames copied from the CD-ROM (S-SW122) are deleted when the SD Memory Card or the built-in memory is formatted (3 default frames are not deleted.).

6

Settings

### 1 Press the MENU button in mode.

The [ Setting] menu appears.

When you press the **MENU** button in  mode, press the four-way controller () twice.

### 2 Use the four-way controller ( ) to select [Format].

### 3 Press the four-way controller () .

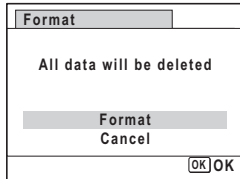

The [Format] screen appears.

### 4 Use the four-way controller ( ) to select [Format].



## 5 Press the OK button.

Format starts.



When formatting is completed, the camera returns to  mode or  mode.

## Changing the Sound Settings

You can adjust the volume of operation sounds and change the type of sound.

### 1 Press the MENU button in mode.

The [ Setting] menu appears.

When you press the **MENU** button in  mode, press the four-way controller () twice.

### 2 Use the four-way controller ( ) to select [Sound].

### 3 Press the four-way controller () .

The [Sound] screen appears.

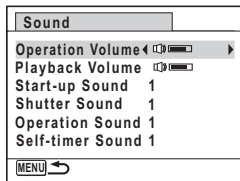

## To Change the Operation Volume/Playback Volume

### 4 Use the four-way controller ( ) to select [Operation Volume].

### 5 Use the four-way controller ( ) to adjust the volume.

Set the volume to 0 to mute the start-up sound, shutter sound, operation sound, and self-timer sound.



### 6 Change [Playback Volume] in the same way as in Steps 4 and 5.

## To Change the Sound Type

- 4** Use the four-way controller (▲▼) to select [Start-up Sound].
- 5** Press the four-way controller (▶).  
A pull-down menu appears.
- 6** Use the four-way controller (▲▼) to select the sound type.  
Choose from [1], [2], [3] or [Off].
- 7** Press the OK button.
- 8** Set [Shutter Sound], [Operation Sound] and [Self-timer Sound] in the same way as in Steps 4 to 7.
- 9** Press the MENU button.  
The screen returns to the [↖ Setting] menu.

## 6 Changing the Date and Time

You can change the initial date and time settings. You can also set the style in which the date appears on the camera.

- 1** Press the MENU button in  mode.  
The [↖ Setting] menu appears.  
When you press the MENU button in  mode, press the four-way controller (▶) twice.
- 2** Use the four-way controller (▲▼) to select [Date Adjustment].
- 3** Press the four-way controller (▶).  
The [Date Adjustment] screen appears.

**4 Press the four-way controller (▶).**

The frame moves to [mm/dd/yy].  
Depending on the initial setting or previous setting, [dd/mm/yy] or [yy/mm/dd] may be displayed.

Date Adjustment	
Date Format	▶mm/dd/yy 24h
Date	01/01/2012
Time	00:00
Settings complete	
[MENU]Cancel	

**5 Use the four-way controller (▲▼) to choose the date format.**

Choose from [mm/dd/yy], [dd/mm/yy] or [yy/mm/dd].

Date Adjustment	
Date Format	◀mm/dd/yy 24h
Date	01/01/2012
Time	00:00
Settings complete	
[MENU]Cancel	

**6 Press the four-way controller (▶).**

The frame moves to [24h].

**7 Use the four-way controller (▲▼) to select [24h] (24-hour display) or [12h] (12-hour display).**

Date Adjustment	
Date Format	◀mm/dd/yy 24h
Date	01/01/2012
Time	00:00
Settings complete	
[MENU]Cancel	

**8 Press the four-way controller (▶).**

The frame returns to [Date Format].

**9 Press the four-way controller (▼).**

The frame moves to [Date].

**10 Press the four-way controller (▶).**

The frame moves to one of the following items depending on the date format set in Step 5.

For [mm/dd/yy] month (Example: [01])

For [dd/mm/yy] day (Example: [01])

For [yy/mm/dd] year (Example: [2012])

The following operations and screen use [mm/dd/yy] as an example. The operations are the same even if another date format has been selected.

Date Adjustment	
Date Format	mm/dd/yy 24h
Date	▶01/01/2012
Time	00:00
Settings complete	
[MENU] Cancel	

**11 Use the four-way controller (▲▼) to change the month.**

Date Adjustment	
Date Format	mm/dd/yy 24h
Date	◀ 01/01/2012
Time	00:00
Settings complete	
[MENU] Cancel	

**12 Press the four-way controller (▶).**

The frame moves to the day field. Use the four-way controller (▲▼) to change the day. After changing the day, change the year in the same manner.

**13 Change the time in the same way as in Steps 8 to 11.**

If you selected [12h] in Step 7, the setting switches between am and pm corresponding to the time.

**14 Press the four-way controller (▼) to select [Settings complete].****15 Press the OK button.**

The date and time settings are saved.



When you press the **OK** button in Step 15, the camera clock is reset to 00 seconds. To set the exact time, press the **OK** button when the time signal (on the TV, radio, etc.) reaches 00 seconds.

## Setting the World Time

The date and time selected in “Setting the Date and Time” (p.46) and “Changing the Date and Time” (p.178) serve as the 🏠 (Hometown) date and time. If you set the Destination city using the world time function, you can display the Destination date and time when taking pictures in a different time zone.

### To Set the Destination

#### 1 Press the MENU button in mode.

The [Setting] menu appears.

When you press the MENU button in  mode, press the four-way controller (▶) twice.

#### 2 Use the four-way controller (▲▼) to select [World Time].

#### 3 Press the four-way controller (▶).

The [World Time] screen appears.

#### 4 Use the four-way controller (▲▼) to select → (Destination).

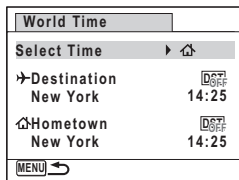

#### 5 Press the four-way controller (▶).

The [Destination] screen appears. The city that is currently selected blinks on the map.

#### 6 Use the four-way controller (◀▶) to change the Destination city.

The current time, location and time difference of the selected city appear.

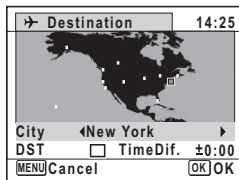

- 7** Use the four-way controller (▲▼) to select [DST].
- 8** Use the four-way controller (◀▶) to select  (On) or  (Off).  
Select  (On) if the Destination city uses daylight saving time.
- 9** Press the **OK** button.  
The [World Time] setting is saved.
- 10** Press the **MENU** button twice.  
The camera returns to capture status with the current setting.



Select (Hometown) in Step 4 of p.181 to set the city and DST setting for the Hometown city.

### To Display the Time of the Destination on the Display (Select Time)

- 1** Press the **MENU** button in mode.  
The [ Setting] menu appears.  
When you press the **MENU** button in mode, press the four-way controller (▶) twice.
- 2** Use the four-way controller (▲▼) to select [World Time].
- 3** Press the four-way controller (▶).  
The [World Time] screen appears.
- 4** Use the four-way controller (▲▼) to select [Select Time].
- 5** Press the four-way controller (▶).  
A pull-down menu appears.

World Time	
Select Time	▶
▶ Destination	<input type="checkbox"/> DST
London	20:25
Hometown	<input type="checkbox"/> DST
New York	14:25
MENU	

## 6 Use the four-way controller (▲▼) to select → (Destination) or ↻ (Hometown).

- Displays the time of the Destination city
- ↻ Displays the time of the Hometown city

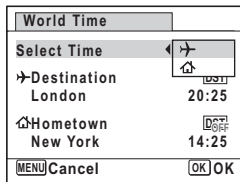

## 7 Press the OK button.

The setting is saved.

## 8 Press the MENU button twice.

The camera returns to mode or mode.

When → (Destination) is selected in Step 6, the → icon appears on the display to indicate that the destination date and time are displayed in mode.



## Changing the Display Language

You can change the language in which the menus, error messages, etc. are displayed.

The camera supports the following languages: English, French, German, Spanish, Portuguese, Italian, Dutch, Japanese, Danish, Swedish, Finnish, Polish, Czech, Hungarian, Turkish, Greek, Russian, Thai, Korean and Chinese (traditional and simplified).

## 1 Press the MENU button in mode.

The [ Setting] menu appears.

When you press the **MENU** button in mode, press the four-way controller (▶) twice.

## 2 Use the four-way controller (▲▼) to select [Language/言語].

### 3 Press the four-way controller (▶).

The [Language/言語] screen appears.

### 4 Use the four-way controller (▲▼◀▶) to select the desired language.

Language/言語		
English	日本語	Türkçe
Français	Dansk	Ελληνικά
Deutsch	Svenska	Русский
Español	Suomi	<b>ไทย</b>
Português	Polski	한국어
Italiano	Čeština	中文繁體
Nederlands	Magyar	中文简体
MENU/Cancel		OK/OK

### 5 Press the OK button.

The menus and messages are displayed in the selected language.

## Changing the Naming System of the Folder

You can change the naming system of the folder for storing images. When the naming system is set to [Date], pictures are saved in separate folders by the date they were taken.

6

Settings

PENTX	xxxPENTX (where xxx is the 3-digit folder number)
Date	xxx_mmdd (3-digit folder number_month day) * xxx_ddmm (3-digit folder number_day month) when the date format is set to [dd/mm/yy]

Taken with the folder name setting [PENTX].  
(e.g. September 25)

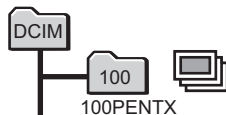

Taken with the folder name setting [Date].  
(e.g. September 25)

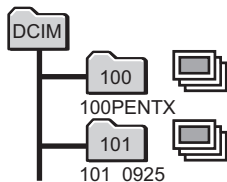

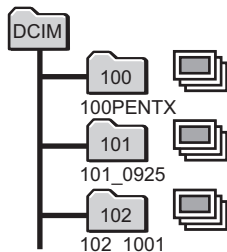

Next time, taken with the folder name setting [Date] again.  
(e.g. October 1)



- Up to 900 folders can be created.
- Up to 9999 images can be saved in a folder.

## 1 Press the MENU button in mode.

The [ Setting] menu appears.

When you press the MENU button in  mode, press the four-way controller () twice.

## 2 Use the four-way controller ( ) to select [Folder Name].

## 3 Press the four-way controller () .

A pull-down menu appears.

## 4 Use the four-way controller ( ) to select [PENTX] or [Date].

## 5 Press the OK button.



The setting is saved.

## Changing the Video Output Format

When you connect the camera to AV equipment, choose the appropriate video output format (NTSC or PAL) for taking and playing back images.

## 1 Press the MENU button in mode.

The [ Setting] menu appears.

When you press the MENU button in  mode, press the four-way controller () twice.

## 2 Use the four-way controller ( ) to select [Video Out].

## 3 Press the four-way controller () .

A pull-down menu appears.

## 4 Use the four-way controller ( ) to select video output format.

Choose a video output format to match the input format of the AV equipment.

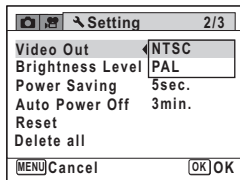

## 5 Press the OK button.

The setting is saved.



Depending on the country or region, images may fail to be played back if the video output format is set differently from the one in use there. If this happens, change the video output format setting.

Connecting the Camera to AV Equipment p.149  
Video output format of each city p.221

## Adjusting the Brightness of the Display

You can adjust the brightness of the display.

### 1 Press the MENU button in mode.

The [ Setting] menu appears.

When you press the **MENU** button in mode, press the four-way controller () twice.

### 2 Use the four-way controller ( ) to select [Brightness Level].

### 3 Use the four-way controller ( ) to adjust the brightness.

Dark  
 Normal  
 Bright

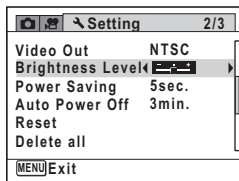

### 4 Press the MENU button.



The camera returns to mode or mode.  
The display appears with the set brightness.

## Using the Power Saving Function

You can save battery power by setting the display to dim automatically when no operation is performed for a fixed time. After the power saving function has been activated, the display returns to the ordinary brightness by pressing any of the buttons.

### 1 Press the **MENU** button in mode.

The [ Setting] menu appears.

When you press the **MENU** button in  mode, press the four-way controller () twice.

### 2 Use the four-way controller ( ) to select [Power Saving].

### 3 Press the four-way controller () .

A pull-down menu appears.

### 4 Use the four-way controller ( ) to select the time until the camera enters power saving mode.

Choose from [2min.], [1min.], [30sec.], [15sec.], [5sec.] or [Off].

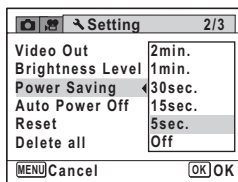

### 5 Press the **OK** button.

The setting is saved.





- Power Saving does not function in the following situations:
  - in the playback mode
  - while recording a movie
  - while the camera is connected to a computer
  - while a menu is being displayed
- When no operation is performed right after the camera is turned on, Power Saving is activated only after 15 seconds elapse even if [5sec.] is set.

## Setting the Auto Power Off Function

You can set the camera to turn off automatically when no operation is performed for a fixed time.

### 1 Press the **MENU** button in mode.

The [ Setting] menu appears.

When you press the **MENU** button in  mode, press the four-way controller () twice.

### 2 Use the four-way controller ( ) to select [**Auto Power Off**].

### 3 Press the four-way controller ().

A pull-down menu appears.

### 4 Use the four-way controller ( ) to select the time until the camera turns off automatically.

Choose from [5min.], [3min.] or [Off].

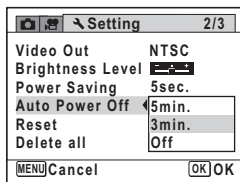

### 5 Press the **OK** button.

The setting is saved.



Auto Power Off does not function in the following situations:

- while recording a movie
- during a slideshow or movie playback
- while the camera is connected to a computer

## Changing the Start-up Screen

You can choose the start-up screen displayed when the camera is turned on.

You can choose any of the following images as the start-up screen:

- The Guide Display Start-up Screen showing a guide to the shooting modes and buttons
- One of the 3 pre-installed screens
- One of your own images (compatible images only)

### 1 In mode, press the four-way controller (▼).

The Playback Mode Palette appears.

### 2 Use the four-way controller (▲▼◀▶) to select (Start-up Screen).



### 3 Press the OK button.

The image selection screen appears.

### 4 Use the four-way controller (◀▶) to choose the image for the start-up screen.

Only images available for the start-up screen are displayed. You can also choose one of the 3 pre-installed screens or the Guide Display Start-up Screen already stored in the camera.

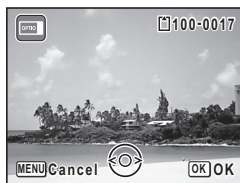

### 5 Press the OK button.

The start-up screen is set.



- Once the start-up screen has been set, it will not be deleted even if the original image is deleted or the SD Memory Card/built-in memory is formatted.
  - Select [Off] to hide the start-up screen.
  - The start-up screen is not displayed when the camera starts up in the playback mode.
- ¥ Movies or images taken at (16-frame shooting) or (Digital Panorama) mode cannot be used for the start-up screen.

## Correcting Defective Pixels in the CCD Sensor (Pixel Mapping)

Pixel Mapping is a function for mapping out and correcting defective pixels in the CCD sensor. Run the Pixel Mapping function if image dots always seem to be defective in the same place.

### 1 Press the MENU button in mode, and press the four-way controller (▶) twice.

The [ Setting] menu appears.

When you press the MENU button in mode, [Pixel Mapping] cannot be selected.

### 2 Use the four-way controller (▲▼) to select [Pixel Mapping].

### 3 Press the four-way controller (▶).

The [Pixel Mapping] screen appears.

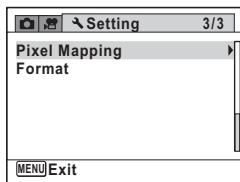

- 4** Use the four-way controller (▲▼) to select [Pixel Mapping].

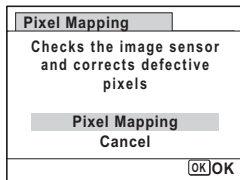

- 5** Press the OK button.

Defective pixels are mapped and corrected.





When the battery level is low, [Not enough battery power remaining to activate Pixel Mapping] is displayed on the monitor. Use the AC adapter kit K-AC122 (optional) or load a fully charged battery.

## Resetting to Default Settings (Reset)

You can reset the camera settings to their defaults. Refer to “Default Settings” (p.216) for the reset settings.

- 1** Press the MENU button in  mode.

The [ Setting] menu appears.

When you press the MENU button in  mode, press the four-way controller (▶) twice.

- 2** Use the four-way controller (▲▼) to select [Reset].

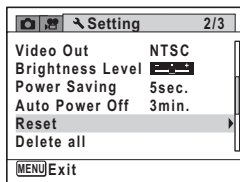

- 3** Press the four-way controller (▶).

The [Reset] screen appears.

#### 4 Use the four-way controller (▲▼) to select [Reset].

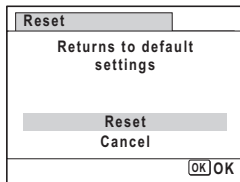

#### 5 Press the OK button.

The settings return to the defaults.



The following settings are not affected by resetting:

- Date Adjustment
- World Time
- Language/言語
- Video Out

# **7 Viewing Images on a Computer**

---

<b>Setting Up Your Computer .....</b>	<b>194</b>
<b>Connecting to Your Computer .....</b>	<b>201</b>

# Setting Up Your Computer

By installing the software supplied with the camera on your computer and connecting the camera to your computer with the USB cable, you can transfer images and movies captured with your camera to the computer and then display and manage them. This section explains how to install the provided software and the other necessary preparations for enjoying the captured pictures and movies on your computer.

## Provided Software

The following software is included in the CD-ROM (S-SW122).

### Image viewing/managing/editing software

#### Windows

- “**MedialImpression 3.1 for PENTAX**”

#### Macintosh

- “**MedialImpression 2.1 for PENTAX**”

Applicable languages: English, French, German, Spanish, Portuguese, Italian, Dutch, Swedish, Russian, Korean, Chinese (traditional and simplified), Japanese

 Caution

It is recommended to use the optional AC adapter kit K-AC122 when the camera is connected to the computer (p.35). If the battery runs out of power while images are being transmitted to the computer, the image data may be lost or damaged.

## System Requirements

The following system requirements must be met for you to fully enjoy the images and movies captured with the camera on your computer.

## Windows

OS	Windows XP (SP3), Windows Vista or Windows 7 • The OS must be preinstalled and updated to the latest version.
CPU	Pentium IV 1.6 GHz or equivalent AMD Athlon (Intel Core 2 Duo 2.0 GHz or equivalent AMD Athlon X2 processor recommended)
Memory	512 MB minimum (1 GB or more recommended)
Hard Disk Space	300 MB minimum
Others	CD-ROM drive USB port as standard equipment 1024 × 768 pixels, 16-bit color monitor or greater

- \* Operation is not guaranteed on all computers meeting the system requirements.
- \* The system requirements describe the minimum environment for playing and editing movies.



Windows 95, Windows 98, Windows 98SE, Windows Me, Windows NT and Windows 2000 are not supported.

## Macintosh

OS	Mac OS X (Ver.10.3.9, 10.4, 10.5, 10.6, 10.7) • The OS must be preinstalled and updated to the latest version.
CPU	PowerPC G4 800 MHz processor or equivalent CPU (Power PC G5 or Intel Core Duo processor recommended)
Memory	512 MB minimum (1 GB or more recommended)
Hard Disk Space	300 MB minimum
Others	CD-ROM drive USB port as standard equipment 1024 × 768 pixels, 16-bit color monitor or greater

- \* Operation is not guaranteed on all computers meeting the system requirements.
- \* The system requirements describe the minimum environment for playing and editing movies.

## Installing the Software

Install the image viewing/managing/editing software “MediaImpression”.



- Make sure your computer meets the system requirements before installing the software.
- When multiple accounts have been set up in your computer, log on with an account that has administrative rights before installing the software.

### Windows

- 1 Turn your Windows PC on.**
- 2 Insert the CD-ROM (S-SW122) into the CD-ROM/DVD drive.**

If the top screen (illustration below) appears, go to Step 5.

- 3 Click [Computer] in the Start menu.**
- 4 Double-click the CD-ROM/DVD drive (S-SW122) icon.**

The top screen appears.

- 5 Click [Software Install], choose a language in the “Choose Setup Language” screen and click [OK].**

The setup screen appears. Follow the on-screen guidance and install the software.

Top screen

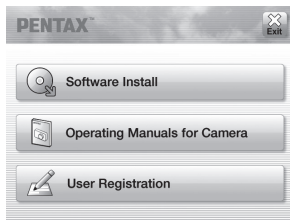

## 6 Select the file format to use and click [Next].

All files in the checked format will open with MediaImpression 3.1 for PENTAX. Remove the check to open the file using another application.

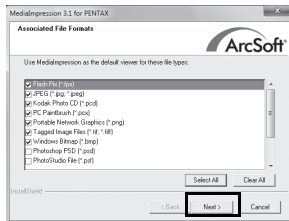

## 7 Click [Finish].

Installation is complete.  
Reboot your computer.

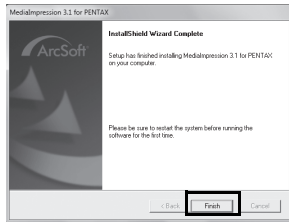

## Macintosh

### 1 Turn your Macintosh on.

### 2 Insert the CD-ROM (S-SW122) into the CD-ROM/DVD drive.

### 3 Double-click the CD-ROM (S-SW122) icon.

### 4 Double-click the [PENTAX Software Installer] icon.

The installation screen appears.

### 5 Click [MediaImpression 2.1 for PENTAX].

The setup screen appears. Follow the on-screen guidance and install the software.



- 6** Click **[Close]**.  
Installation is complete.

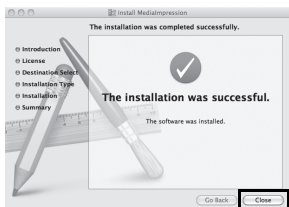

- 7** Click **[Exit]** on the installation screen.  
The window is closed.

## Product Registration on the Internet

In order to better serve you, we request that you complete the product registration.

If your computer is connected to the Internet, please click **[User Registration]** on the top screen (Windows)/**[Product Registration]** on the installation screen (Macintosh).

The world map screen shown on the right for Internet Product Registration is displayed. Click the displayed country or region and then follow the instructions to register your product.

Only customers in countries and regions displayed on the software installation screen can register their products on the Internet Product Registration.

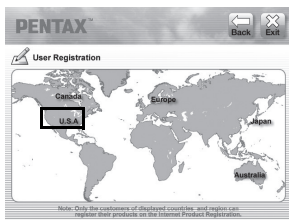

7

## Setting the USB Connection Mode

Set the device to which the camera is connected with the USB cable.





Make sure to set the USB Connection mode before connecting your camera to the computer. You cannot perform the following setting if the camera is connected to your computer with the USB cable.

**1 Turn your camera on.**

**2 Press the MENU button in  mode.**



The [ Setting] menu appears.

When you press the **MENU** button in  mode, press the four-way controller () twice.

**3 Use the four-way controller ( ) to select [USB Connection].**

**4 Press the four-way controller ().**

A pull-down menu appears.

**5 Use the four-way controller ( ) to select [MSC].**

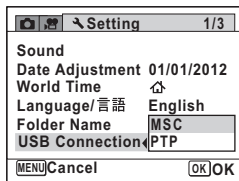

**6 Press the OK button.**

The setting is saved.

## MSC (Mass Storage Class) and PTP (Picture Transfer Protocol)

### MSC (Mass Storage Class)

A general-purpose driver program that handles devices connected to the computer via USB as a memory device. Also indicates a standard for controlling USB devices with this driver.

By simply connecting a device that supports USB Mass Storage Class, you can copy, read, and write files from a computer without installing a dedicated driver.

### PTP (Picture Transfer Protocol)

A protocol that allows transfer of digital images and control of digital cameras via USB, standardized as ISO 15740.

You can transfer image data between devices that support PTP without installing a device driver.

Unless otherwise specified, select MSC when connecting this camera to your computer.

# Connecting to Your Computer

## Connecting the Camera and Your Computer

Connect your camera to the computer using the provided USB cable.

- 1 Turn your computer on.**
- 2 Turn your camera off.**
- 3 Connect your camera to the computer using the USB cable.**

Connect the terminal of the USB cable with ⇐ pointing toward the display of the camera.

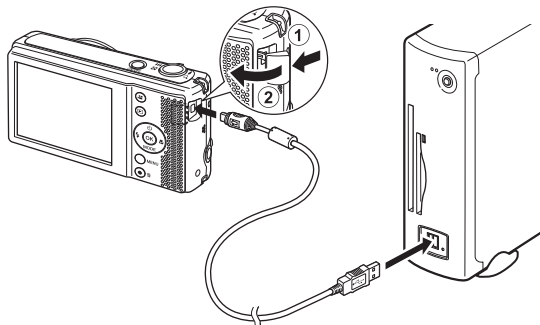

- 4 Turn your camera on.**

For Windows, the “AutoPlay” screen appears on the computer. If the “AutoPlay” screen does not appear, follow the steps in “When the [AutoPlay] screen does not appear” (p.202).

For Macintosh, the camera is recognized as [NO NAME] on the desktop.





- The self-timer lamp blinks while the camera is connected to a computer.
- For Macintosh, the volume label name appears instead of [NO NAME] if the SD Memory Card has a volume label. A new unformatted SD Memory Card may show the manufacturer's name or model number.

## When the [AutoPlay] screen does not appear

### 1 Double-click the [MediaImpression] icon on the desktop.

MediaImpression starts and the Start page appears.



### 2 Click [PhotoImpression].

### 3 Click the connected camera on top left of the screen.

The import screen appears. For subsequent steps, go to Step 6 on p.203.

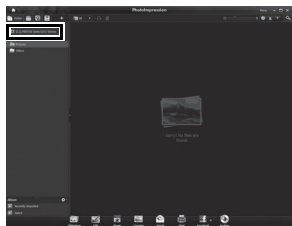

## Transferring Images

Import the images captured with the camera into your computer.



- If there is no SD Memory Card in the camera, the images stored in the built-in memory will be transferred to your computer.
- If you are using a Macintosh, go to p.204.

## 5 Click [Import media files to local disk].

MediaImpression 3.1 for PENTAX starts and the import screen appears.



## 6 Select an image to import.

To select multiple images, choose the images while pressing the Ctrl key. To specify the destination location, click the folder icon.

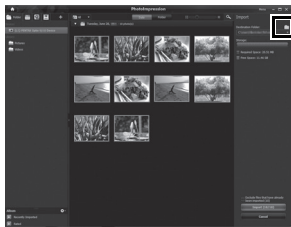

## 7 Click [Import].

A message appears indicating that import is complete. An arrow mark appears on the imported image.

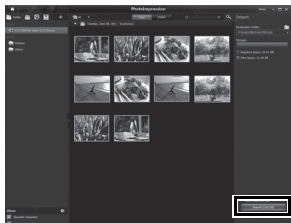

**5** Double-click the [MediaImpression 2.1 for PENTAX] icon in the [Applications] folder.



MediaImpression 2.1 for PENTAX starts and the Start page appears.

**6** Click [Import].

The import screen appears. For subsequent steps, refer to Step 6 and 7 on p.203.

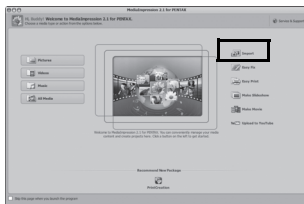

If the images from the camera are not displayed in the import screen, select [NO NAME] (or the volume label name) in [Get Media from].

# Disconnecting the Camera from Your Computer

## Windows

- 1 Click the  [Safely Remove Hardware] icon in the task bar.



- 2 Click [Eject (the device connected)].  
A message appears indicating that the hardware can be safely removed.

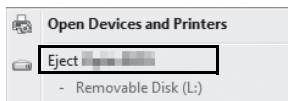

- 3 Disconnect the USB cable from your Windows PC and the camera.

## Macintosh

- 1 Drag [NO NAME] on the desktop to the trash.  
If the SD Memory Card has a volume label, drag the icon of that name to the trash.
- 2 Disconnect the USB cable from your Macintosh and the camera.



- If the camera (removable disk) is being used by an application such as "MediaImpression", the camera cannot be disconnected until the application is closed.
- The camera will automatically switch to the playback mode when the USB cable is disconnected from your computer or the camera.

## Starting “MediaImpression”

“MediaImpression” lets you view, edit, manage, search for, share, and print images.

- 1 Double-click the [MediaImpression] icon on the desktop (for Windows) or in the [Applications] folder (for Macintosh).**

MediaImpression starts and the Start page appears.

- 2 Click [PhotoImpression].**  
The Media Browser screen appears.



\* The screen shown is for a Windows PC. Items shown will differ depending on the operating system and settings.

- 3 Select and click the folder containing the images you wish to view.**

The images are displayed.

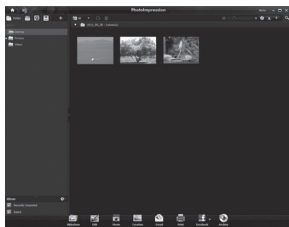

- 4 Select and double-click an image you wish to view.**

You can enlarge/reduce the display size of the image or edit the image. You can also play back movies and sound.





## Memo

# 8 Appendix

---

<b>Functions Available for Each Shooting Mode .....</b>	<b>210</b>
<b>Messages .....</b>	<b>212</b>
<b>Troubleshooting .....</b>	<b>214</b>
<b>Default Settings .....</b>	<b>216</b>
<b>List of World Time Cities .....</b>	<b>221</b>
<b>Optional Accessories .....</b>	<b>222</b>
<b>Main Specifications .....</b>	<b>223</b>
<b>WARRANTY POLICY .....</b>	<b>227</b>
<b>Index .....</b>	<b>232</b>

# Functions Available for Each Shooting Mode

✓: Can be set.      ×: Cannot be set.

Function		Shooting Mode						
Zoom lever	Zoom operation	✓	✓*1	✓*2	✓*3	✓*1	✓*1	
Flash Mode	(Auto)	✓	✓	✓	×	×	✓	
	(Flash Off)	✓	✓	✓	✓	✓	✓	
	(Flash On)	✓	✓	×	×	✓	✓	
	(Auto + Red-eye)	✓	✓	×	×	×	✓	
	(Flash On + Red-eye)	✓	✓	×	×	✓	✓	
Drive Mode	(Standard)	✓	✓	✓	✓	✓	✓	
	(Self-timer)	✓	✓	✓	✓	✓	✓	
	(Remote Control)	✓	✓	×	✓	✓	✓	
	(Continuous Shooting)		✓	×	×	×	×	
	(Burst Shooting L/H)	×	✓	×	×	×	×	
	(16-frame Shooting)	×	✓	×	×	×	×	
	(Auto Bracketing)	×	✓	×	×	✓	×	
Focus Mode	<b>AF</b> (Standard)	✓	✓	✓	✓	✓	✓	
	(Macro)	✓	✓	✓	✓	✓	✓	
	(1cm Macro)	✓	✓	×	✓	✓	✓	
	(Infinity)	✓	✓	×	✓	✓	✓	
	<b>MF</b> (Manual Focus)	✓	✓	×	✓	✓	✓	
[Rec. Mode] menu	Recorded Pixels	✓	✓	×	×	✓	✓	
	White Balance	×	✓	×	✓	✓	×	
	AF Setting	Focusing Area	×	✓	×	✓	✓	✓
		Focus Assist	✓	✓	×	✓	✓	✓
	Sensitivity	✓	✓	×	×	✓	✓	
	AUTO ISO Range	✓	✓	×	×	✓	✓	
	EV Compensation	×	✓	×	✓	✓	✓	
	D-Range Setting	✓	✓	×	✓	✓	✓	
	Shake Reduction	✓	✓	×	✓	✓	✓	
	Face Recall	✓	✓	✓	✓	✓	✓	
	Face Detection	✓*15	✓	×	✓	✓	✓*15	
	Blink Detection	✓	✓	×	×	✓	✓	
	Digital Zoom	✓	✓	×	×	✓	✓	
	Sharpness							
	Saturation	×	✓	×	✓	✓	×	
	Contrast							
Date Imprint	✓	✓	×	✓	✓	✓		
Electronic Level	✓	✓	×	✓	✓	✓		

\*1 Optical zoom is always possible, Digital Zoom and Intelligent Zoom cannot be used if the Sensitivity selection is ISO 3200/6400.

\*2 Intelligent Zoom is not available

\*3 Only optical zoom is available

\*4 Fixed at

\*5 Fixed at

\*6 Fixed at

\*7 Fixed at

\*8 Fixed at

\*9 Fixed at

\*10 Set in the Movie menu

\*11 Fixed at **AWB**

\*12 (Automatic Tracking AF) is not available

\*13 Fixed at (Multiple)

\*14 Fixed at On

Shooting menu items not listed in this chart can be set in any shooting mode except for Green Mode. However, these settings may not function properly in certain shooting modes and setting conditions even if they can be selected. For further information, please refer to the pages listed below.

Shooting Mode								Function	Page		
								Zoom operation	Zoom lever	p.74	
✓*1	✓*3	✓	✓*1	✓*1	✓*1	✓*2		Zoom operation	Zoom lever	p.74	
✓	✓	x	✓	✓	✓	x		(Auto)	Flash Mode	p.97	
✓	✓	✓*4	✓	✓	✓	✓*4		(Flash Off)			
✓	✓	x	✓	✓	✓	x		(Flash On)			
✓	✓	x	✓	✓	✓	x		(Auto + Red-eye)			
✓	✓	x	✓	✓	✓	x		(Flash On + Red-eye)			
✓	✓	✓	✓	✓	✓	✓		(Standard)	Drive Mode	—	
✓	✓	✓	✓	✓	✓	✓		(Self-timer)		p.90	
✓	✓	✓	✓	✓	✓	✓		(Remote Control)		p.93	
✓	✓	x	x	x	x	x		(Continuous Shooting)		p.92	
✓	✓	x	x	x	x	x		(Burst Shooting L/H)			
✓	x	x	x	x	x	x		(16-frame Shooting)	p.95		
✓	✓	x	x	✓	x	x		(Auto Bracketing)			
✓	✓	x	✓	✓	✓	✓		<b>AF</b> (Standard)	Focus Mode	p.99	
✓	✓	x	✓	✓	✓	✓		(Macro)			
✓	✓	x	✓	✓	✓	✓		(1cm Macro)			
✓	✓	✓*5	✓	✓	✓	✓		(Infinity)			
✓	✓	x	✓	✓	✓	✓		<b>MF</b> (Manual Focus)			
✓	x*7	✓*8	✓	✓	x*9	✓*10		Recorded Pixels	[Rec. Mode] menu	p.103	
x*11	✓	x*11	✓	✓	✓	✓		White Balance		p.105	
x*13	✓	x*13	✓*12	✓*12	✓	✓*12		Focusing Area		AF Setting	p.101
✓	✓	x*16	✓	✓	✓	✓		Focus Assist			p.102
✓	x*17	x*18	✓	✓	✓	x*17		Sensitivity		p.109	
✓	x*19	✓	✓	✓	✓	x*20		AUTO ISO Range		p.110	
✓	✓	✓	✓	✓	✓	✓		EV Compensation		p.107	
✓	✓	✓	✓	✓	✓	✓		D-Range Setting		p.108	
✓	✓	✓	✓	✓	✓	✓*22		Shake Reduction		p.112	
✓	✓	✓	✓	✓	✓	✓		Face Recall		p.113	
✓*23	✓	✓	✓	x	✓*24	✓		Face Detection		p.117	
✓	✓	✓	✓	x	✓	✓		Blink Detection		p.118	
✓	x	✓	✓	✓	✓	✓		Digital Zoom		p.76	
x	✓	x	✓	✓	✓	✓		Sharpness		p.111	
x	✓	x	✓	✓	✓	✓		Saturation		p.111	
x	✓	x	✓	✓	✓	✓		Contrast		p.112	
✓	✓	✓	✓	✓	✓	x*16		Date Imprint		p.118	
✓	✓	✓	✓	✓	✓	✓		Electronic Level		p.119	

\*15 Off is not available

\*16 Fixed at Off

\*17 Fixed at AUTO

\*18 The sensitivity is fixed at its minimum setting

\*19 Fixed at 100-6400

\*20 Fixed at 100-800

\*21 Fixed at  $\pm 0.0$

\*22 Set with [Movie SR] of the Movie menu

\*23 Off is not available for Night Scene Portrait, Kids and Portrait modes

\*24 Smile is not available

\*25 Fixed at the normal setting

# Messages









Messages such as the following may appear on the display during camera operation.

Message	Description
Battery depleted	The battery exhausted. Replace with charged battery. (p.31)
Memory card full	The SD Memory Card is full and no more images can be saved. Insert a new SD Memory Card or delete unwanted images (p.37, p.142). Change the recorded pixels of recorded images and try again (p.152).
Memory card error	Shooting and playback are impossible due to a problem with the SD Memory Card. You may be able to display or copy the images on the card using a computer.
Card is not formatted	The SD Memory Card you have inserted is unformatted or has been formatted on a computer or other device and is not compatible with this camera. Format the SD Memory Card in the camera (p.176).
The built-in memory is not formatted	The data within the built-in memory are damaged. Format the built-in memory.
Card is locked	The SD Memory Card is write-protected (p.6).
Compression error	This message appears when the camera fails to compress an image. Change the recorded pixels of the image and try shooting or saving it again.
No image	There are no images on the SD Memory Card.
Movie recording stopped	This message appears when the internal temperature of the camera has exceeded normal operating limits while recording a movie.
Deleting	This message appears when deleting an image.
Camera cannot play this image and sound	You are trying to play back a picture or a movie in a format not supported by this camera. You may be able to play it back on another brand of camera or on your computer.
Image folder cannot be created	The largest file number (9999) has been assigned to an image in the largest folder number (999) and no more images can be saved. Insert a new SD Memory Card or format the card/built-in memory (p.176).
Protected	The image you are trying to delete is protected.

Message	Description
Data being recorded	This message appears when you try to switch to  mode while an image is still being recorded, or when the protect setting or DPOF setting is being changed. It disappears after the image is recorded or the setting is changed.
Data being processed	This message appears when the camera takes more than five seconds to display an image due to image processing, or when the SD Memory Card or the built-in memory is being formatted.
Built-in memory full	Displayed if the built-in memory is full when saving a file.
No image to be processed	Displayed when there are no images.
This image cannot be processed	Displayed for files that cannot be processed.
No card in the camera	Displayed when no SD Memory Card is inserted.
Available memory on card is insufficient to copy the images	Displayed when there is insufficient memory on an SD Memory Card to perform copying.
Available built-in memory is insufficient to copy the images	Displayed when there is insufficient built-in memory to perform copying.
Cannot process correctly	Displayed when Natural Skin Tone or Red-eye Compensation processing fails.

# Troubleshooting

Problem	Cause	Remedy
The camera will not turn on	The battery is not installed	Check if a battery is installed. If not, install a battery.
	The battery is installed incorrectly	Check orientation of the battery. Reinsert the battery with the label facing the display (p.32).
	The battery is exhausted	Charged the battery.
No image appears on the display	The camera is connected to a computer	The display is off when the camera is connected to a computer.
	The camera is connected to a TV	The display is off when the camera is connected to a TV.
The display is hard to see	The brightness level of the display is set too dark	Adjust the brightness level in [Brightness Level] in the [Setting] menu (p.186).
	Power Saving function is activated	When the Power Saving function is activated, the display automatically darkens after a certain amount of time. Press a button to return to the normal brightness level. Select [Off] in [Power Saving] in the [Setting] menu to turn the Power Saving function off (p.187).
The shutter will not release	The flash is charging	Pictures cannot be taken while the flash is charging. Wait until charging is finished.
	There is no available space on the SD Memory Card or in the built-in memory	Insert an SD Memory Card with available space or delete unwanted images (p.37, 142).
	Recording	Wait until recording is finished.
The picture is dark when using the flash	The subject is too far away in a dark environment, such as a night scene	The picture becomes dark if the subject is too far away. Take pictures within the specified flash range.

Problem	Cause	Remedy
The subject is not in focus	The subject is difficult to focus on with autofocus	Lock the focus on an object the same distance away as the subject (by pressing and holding the shutter release button halfway), then aim the camera at your subject and press the shutter release button fully (p.66). Or set the focus manually (p.100).
	The subject is not in the focusing area	Locate the desired subject in the focus frame (focusing area) in the center of the display. If it is difficult to do so, first lock the focus on the desired subject (focus lock), and then move the camera to recompose.
The flash does not discharge	The flash mode is set to  (Flash Off)	Set to  (Auto) or  (Flash On) (p.97).
	The drive mode is set to  ,  ,  or  The focus mode is set to  In movie recording mode	The flash does not discharge in these modes.



Very occasionally, static electricity may cause camera malfunction. In this case, remove the battery and install it again. If the camera is then working properly, normal operation is restored and you can continue using the camera.

# Default Settings

The table below lists the factory default settings.

The meaning of the indications for menu items with a default setting is explained below.

## Last Memory Setting

Yes : The current setting (last memory) is saved when the camera is turned off.

No : The setting returns to the default setting when the camera is turned off.

\* : The setting depends on the [Memory] setting (p.128).

— : N/A

## Reset Setting



Yes : The setting returns to the default setting with the Reset function (p.191).

No : The setting is saved even after reset.

— : N/A

## ● [📷 Rec.Mode] Menu Items



Item		Default Setting	Last Memory Setting	Reset Setting	Page
Recorded Pixels		(4608×3456)	Yes	Yes	p.103
White Balance		<b>AWB</b> (Auto)	*	Yes	p.105
AF Setting	Focusing Area	(Multiple)	Yes	Yes	p.101
	Focus Assist	<input checked="" type="checkbox"/> (On)	Yes	Yes	p.102
Sensitivity		AUTO	*	Yes	p.109
AUTO ISO Range		ISO100-800	*	Yes	p.110
EV Compensation		±0.0	*	Yes	p.107
D-Range Setting	Highlight Correction	<input type="checkbox"/> (Off)	Yes	Yes	p.108
	Shadow Correction	<input type="checkbox"/> (Off)	Yes	Yes	
Shake Reduction		<input checked="" type="checkbox"/> (On)	Yes	Yes	p.112
Face Recall		—	—	—	—
Face Detection		<input checked="" type="checkbox"/> (On)	*	Yes	p.117
Blink Detection		<input checked="" type="checkbox"/> (On)	Yes	Yes	p.118
Digital Zoom		<input checked="" type="checkbox"/> (On)	*	Yes	p.76

Item		Default Setting	Last Memory Setting	Reset Setting	Page
Memory	Flash Mode	<input checked="" type="checkbox"/> (On)	Yes	Yes	p.128
	Drive Mode	<input type="checkbox"/> (Off)	Yes	Yes	
	Focus Mode	<input type="checkbox"/> (Off)	Yes	Yes	
	Zoom Position	<input type="checkbox"/> (Off)	Yes	Yes	
	MF Position	<input type="checkbox"/> (Off)	Yes	Yes	
	White Balance	<input type="checkbox"/> (Off)	Yes	Yes	
	Sensitivity	<input type="checkbox"/> (Off)	Yes	Yes	
	EV Compensation	<input type="checkbox"/> (Off)	Yes	Yes	
	Face Detection	<input type="checkbox"/> (Off)	Yes	Yes	
	Digital Zoom	<input checked="" type="checkbox"/> (On)	Yes	Yes	
	DISPLAY	<input type="checkbox"/> (Off)	Yes	Yes	
File No.	<input checked="" type="checkbox"/> (On)	Yes	Yes		
Green Button		Green Mode	Yes	Yes	p.120
Sharpness		 (Normal)	Yes	Yes	p.111
Saturation		 (Normal)	Yes	Yes	p.111
Contrast		 (Normal)	Yes	Yes	p.112
Date Imprint		Off	Yes	Yes	p.118
Electronic Level		<input checked="" type="checkbox"/> (On)	Yes	Yes	p.119

### ● [Movie] Menu Items

Item	Default Setting	Last Memory Setting	Reset Setting	Page
Recorded Pixels	 (1280×720/30 fps)	Yes	Yes	p.124
Movie SR	<input checked="" type="checkbox"/> (On)	Yes	Yes	p.125
Filter	Off	Yes	Yes	p.126











● [  Setting ] Menu Items

Item		Default Setting	LastMemory Setting	Reset Setting	Page
Sound	Operation Volume	3	Yes	Yes	p.177
	Playback Volume	3	Yes	Yes	
	Start-up Sound	1	Yes	Yes	
	Shutter Sound	1	Yes	Yes	
	Operation Sound	1	Yes	Yes	
	Self-timer Sound	1	Yes	Yes	
Date Adjustment	Date Format (date)	According to initial setting	Yes	No	p.46 p.178
	Date Format (time)	24h	Yes	No	
	Date	01/01/2012	Yes	No	
	Time	According to initial setting	Yes	No	
World Time	Select Time	 Hometown	Yes	Yes	p.181
	Destination (City)	According to initial setting	Yes	No	
	Destination (DST)	<input type="checkbox"/> (Off)	Yes	No	
	Hometown (City)	According to initial setting	Yes	No	
	Hometown (DST)	<input type="checkbox"/> (Off)	Yes	No	
Language/言語		According to initial setting	Yes	No	p.42 p.183
Folder Name		Date	Yes	Yes	p.184
USB Connection		MSC	Yes	Yes	p.199
Video Out		According to initial setting	Yes	No	p.185
Brightness Level			Yes	Yes	p.186
Power Saving		5 sec.	Yes	Yes	p.187
Auto Power Off		3 min.	Yes	Yes	p.188
Reset		Cancel	—	—	p.191
Delete all		Cancel	—	—	p.145
Pixel Mapping		Cancel	—	—	p.190
Format		Cancel	—	—	p.176

## ● Playback Mode Palette Items

Item		Default Setting	Last Memory Setting	Reset Setting	Page
Slideshow	Interval	3 sec.	Yes	Yes	p.138
	Screen Effect	Wipe	Yes	Yes	
	Sound Effect	<input checked="" type="checkbox"/> (On)	Yes	Yes	
Image Rotation		Depending on the tilt of the camera	—	—	p.140
Stretch Filter		—	—	—	p.154
Small Face Filter		Approx. 7%	—	—	p.156
Digital Filter		B&W/Sepia	No	—	p.158
Frame Composite		Default 1	Yes	Yes	p.163
Movie Editing	Save as Still Image	—	—	—	p.167
	Divide Movies	—	—	—	p.167
Red-eye Compensation		—	—	—	p.162
Resize	Recorded Pixels	Depending on the picture taken	—	—	p.152
Cropping		Depending on the picture taken	—	—	p.153
Image Copy		Built-in memory → SD Memory Card	—	—	p.168
Protect	Single Image	Depending on the recorded image	—	—	p.146
	All Images	Depending on the recorded image	—	—	
DPOF	Single Image	Copies: 0	—	—	p.171
	All Images	Date: <input type="checkbox"/> (Off)	—	—	
Start-up Screen		Start-up Screen 1	Yes	Yes	p.189

## ● Key Operation

Item	Function	Default Setting	LastMemory Setting	Reset Setting	Page
 button	Operation Mode	 mode	—	—	—
Zoom lever	Zoom Position	Full wide-angle	*	No	p.74
Four-way controller	 Drive Mode	 (Standard)	*	Yes	p.90
	 Shooting Mode	 (Auto Picture)	Yes	Yes	p.67
	 Flash Mode	 (Auto)	*	Yes	p.97
	 Focus Mode	<b>AF</b> (Standard)	*	Yes	p.99
<b>MENU</b> button	Menu Display	Capture mode:  Rec.Mode] menu Playback mode:  Setting] menu	—	—	p.55
<b>OK/DISPLAY</b> button	Information Display	Normal	*	Yes	p.20

# List of World Time Cities

**City:** indicates cities that can be set as either the Initial Setting (p.42) or the World Time (p.181).  
**Video Output Format:** indicates the video output format of the city set as the initial setting.

Region	City	Video Output Format	Region	City	Video Output Format
North America	Honolulu	NTSC	Africa/ West Asia	Istanbul	PAL
	Anchorage	NTSC		Cairo	PAL
	Vancouver	NTSC		Jerusalem	PAL
	San Francisco	NTSC		Nairobi	PAL
	Los Angeles	NTSC		Jeddah	PAL
	Calgary	NTSC		Tehran	PAL
	Denver	NTSC		Dubai	PAL
	Chicago	NTSC		Karachi	PAL
	Miami	NTSC		Kabul	PAL
	Toronto	NTSC		Male	PAL
	New York	NTSC		Delhi	PAL
Halifax	NTSC	Colombo		PAL	
Central and South America	Mexico City	NTSC		Kathmandu	PAL
	Lima	NTSC		Dacca	PAL
	Santiago	NTSC	East Asia	Yangon	NTSC
	Caracas	NTSC		Bangkok	PAL
	Buenos Aires	PAL		Kuala Lumpur	PAL
	Sao Paulo	PAL		Vientiane	PAL
Rio de Janeiro	NTSC	Singapore		PAL	
Europe	Lisbon	PAL		Phnom Penh	PAL
	Madrid	PAL		Ho Chi Minh	PAL
	London	PAL		Jakarta	PAL
	Paris	PAL		Hong Kong	PAL
	Amsterdam	PAL		Beijing	PAL
	Milan	PAL		Shanghai	PAL
	Rome	PAL		Manila	NTSC
	Copenhagen	PAL		Taipei	NTSC
	Berlin	PAL		Seoul	NTSC
	Prague	PAL	Tokyo	NTSC	
	Stockholm	PAL	Guam	NTSC	
	Budapest	PAL	Oceania	Perth	PAL
	Warsaw	PAL		Adelaide	PAL
	Athens	PAL		Sydney	PAL
	Helsinki	PAL		Noumea	PAL
Moscow	PAL	Wellington		PAL	
Africa/ West Asia	Dakar	PAL		Auckland	PAL
	Algiers	PAL		Pago Pago	NTSC
	Johannesburg	PAL			

# Optional Accessories

A number of dedicated accessories are available for this camera. Products marked with an asterisk (\*) are the same as those supplied with the camera.

- **Power supply**

- Rechargeable lithium-ion battery D-LI122 (\*)**

- Battery Charger D-BC122 (\*)**

- AC adapter kit K-AC122**

- (AC adapter D-AC115, DC coupler D-DC122, AC plug cord)

- The AC adapter, DC coupler and AC plug cord are only sold as a kit.

- **Cable**

- USB cable I-USB122 (\*)**

- USB cable I-USB7**

- AV cable I-AVC7**

- **Strap**

- O-ST122 (\*)**

- O-ST8** Silver chain strap

- O-ST24** Genuine leather strap

- O-ST81** Waterproof strap

- **Camera case**

- O-CC81**

- **Remote Control**

- REMOTE CONTROL WATERPROOF O-RC1**

- REMOTE CONTROL E**

- REMOTE CONTROL F**

# Main Specifications

Type	Fully automatic compact digital still camera with built-in zoom lens
Number of Effective Pixels	Approx. 16 megapixels
Image Sensor	1/2.33 inch CCD
Number of Recorded Pixels	Still <b>16M</b> (4608×3456), <b>12M</b> (3456×3456), <b>12M</b> (4608×2592), <b>7M</b> (3072×2304), <b>2M</b> (1920×1080), <b>640</b> (640×480) <ul style="list-style-type: none"><li>* Fixed at <b>5M</b> in Digital SR mode.</li><li>* Fixed at <b>3M</b> in Frame Composite mode.</li><li>* Fixed at <b>2M</b> for one frame in Digital Panorama mode.</li><li>* Fixed at <b>5M</b> when the sensitivity is set to 3200 or 6400.</li><li>* Fixed at <b>5M</b> in Burst Shooting (L/H) mode.</li><li>* Fixed at <b>640</b> (640×480) per one frame, and <b>5M</b> (2560×1920) per one picture in 16-frame shooting mode.</li></ul> Movie <b>1280<sub>s</sub></b> (1280×720/30 fps), <b>1280<sub>s</sub></b> (1280×720/15 fps) <b>640<sub>s</sub></b> (640×480/30 fps), <b>640<sub>s</sub></b> (640×480/15 fps) <b>320<sub>s</sub></b> (320×240/30 fps), <b>320<sub>s</sub></b> (320×240/15 fps) (recorded pixels/frame rate)
Sensitivity (Standard Output Sensitivity)	Auto (ISO100-1600) Manual (ISO100, 200, 400, 800, 1600, 3200, 6400) * Fixed at AUTO (ISO100 - 6400) in Digital SR mode.
File Format	Still JPEG (Exif 2.3), DCF 2.0, DPOF, PRINT Image Matching III Movie AVI (Motion JPEG), approx. 30fps/15fps, PCM system, monaural sound, Movie SR (Movie Shake Reduction)
Storage Media	Built-in memory (approx. 16 MB), SD Memory Card, SDHC Memory Card, SDXC Memory Card

## Approximate Image Storage Capacity and Recording Time

### Still Pictures

		Built-in Memory	2 GB SD Memory Card
<b>16M</b>	4608×3456	5 pictures	655 pictures
<b>12M</b>	3456×3456	6 pictures	854 pictures
<b>12M</b>	4608×2592	6 pictures	854 pictures
<b>7M</b>	3072×2304	10 pictures	1228 pictures
<b>2M</b>	1920×1080	27 pictures	3278 pictures
<b>640</b>	640×480	120 pictures	14050 pictures

- The image storage capacity is for reference only when images are recorded on blank built-in memory or SD Memory Card. If movies are recorded, the image storage capacity is decreased. The actual image storage capacity may vary depending on the SD Memory Card and the subject.

### Movie

	Built-in Memory	2 GB SD Memory Card
<b>1280i</b> (1280×720/30 fps)	4 sec.	9 min. 55 sec.
<b>1280i</b> (1280×720/15 fps)	8 sec.	19 min. 50 sec.
<b>640i</b> (640×480/30 fps)	12 sec.	27 min. 17 sec.
<b>640i</b> (640×480/15 fps)	24 sec.	54 min. 35 sec.
<b>320i</b> (320×240/30 fps)	19 sec.	43 min. 40 sec.
<b>320i</b> (320×240/15 fps)	39 sec.	1 hr. 27 min. 20 sec.

- The above figures are based on our standard shooting conditions and may vary depending on the subject, shooting conditions and type of the SD Memory Card used. If other data such as still images are recorded, recording time becomes shorter.
- Recording can continue until the built-in memory or the SD Memory Card is full, or the size of the recorded movie reaches 2 GB (when using an SDHC Memory Card/SDXC Memory Card). If recording stops at 2 GB, start recording again to continue to record the rest of the movie in blocks of 2 GB.

White Balance	Auto, Daylight, Shade, Tungsten Light, Fluorescent Light, Manual	
Lens	Focal Length	5 mm - 100 mm (approx. 28 mm - 560 mm in 35 mm equivalent focal length)
	Aperture	F3.1 (W) - F4.8 (T)
	Lens Composition	11 elements in 8 groups (1 aspherical elements)
	Zoom Type	Electrically driven
Optical Zoom	20×	

Intelligent Zoom	Approx. 30× at <b>[7M]</b> (3072×2304), Approx. 144× at <b>[640]</b> (640×480) (when combined with optical zoom)	
Digital Zoom	Up to approx. 7.2× (combines with 20x optical zoom to give zoom magnification equivalent to approx. 144×)	
Motion Blur Reduction	Still	CCD-Shift-Type (SR: Shake Reduction), High-sensitivity anti-shake mode (Digital SR)
	Movie	Electronic Movie Shake Reduction (Movie SR)
Display	3 inch LCD, approx. 460,000 dots	
Playback Modes	Single-frame, 4-frame, 9-frame, Enlargement (max. 10×, scrollable), Folder Display, Calendar Display, Histogram Display, Deleting Selected Images, Slideshow, Image Rotation, Small Face Filter, Digital Filter, Frame Composite, Movie Playback/Edit (Save as still image, Divide movies), Red-eye Compensation, Resize, Cropping, Stretch Filter, Image Copy, Protect, DPOF, Start-up Screen	
Focus Modes	Autofocus, Macro, 1cm Macro, Infinity, Manual Focus	
Focus	Type	TTL contrast detection system by sensor 9-point autofocus (multiple/spot/automatic tracking AF changeable)
	Focus range (From lens face)	Standard : 0.4 m - ∞ (Wide-angle) 1.6 m - ∞ (Telephoto)
		Macro : 0.1 m - 0.5 m (Wide-angle) 1cm Macro : 0.01 m - 0.2 m (Mid-zoom)
	* It is possible to switch to Infinity and Manual Focus. * Face Detection AF is available only while the camera detects the subject's face.	
Focus Lock	By half-pressing the shutter release button	
Exposure Control	Metering System	Multi-segment metering
	Exposure Compensation	±2 EV (can be set in 1/3 EV steps)
Face Detection	Detection of up to 10 people's faces (up to 10 face detection frames on the display), Smile Capture, Blink Detection, Face Recall * Face Detection AE is available only while the camera detects the subject's face.	
Shooting Modes	Auto Picture, Program, Portrait, Handheld Night Snap, Night Scene Portrait, Night Scene, Landscape, Blue Sky, Sunset, Flower, Sport, Pet, Digital SR, Natural Skin Tone, Kids, Fireworks, Frame Composite, Food, Text, Surf & Snow, Digital Panorama, Green, Fish-eye, Sketch, Miniature	
Digital Filters	B&W/Sepia, Toy Camera, Retro (Blue, Amber), Color (Red, Pink, Purple, Blue, Green, Yellow), Extract Color (Red, Green, Blue), Starburst, Soft, Fish-eye, Brightness, Miniature, Natural Skin Tone, Sketch	
Movie	Continuous Recording Time	Approx. 1 second - until built-in memory or SD Memory Card is full (however, maximum size is limited to 2 GB)
Shutter Speed	1/2500 sec. - 1/4 sec., max. 4 sec. (Night Scene mode)	

Built-in Flash	Modes	Auto, Flash Off, Flash On, Auto + Red-eye, Flash On + Red-eye
	Flash Range	Wide-angle: approx. 0.2 m - 5.1 m (approx. 0.66 ft - 17 ft) (Sensitivity: in AUTO condition) Telephoto: approx. 1.6 m - 3.3 m (approx. 5.2 ft - 11 ft) (Sensitivity: in AUTO condition)
Drive Modes	Single-frame, Self-timer (approx. 10 sec., approx. 2 sec.), Remote Control (3-sec Remote Control, 0-sec Remote Control), Continuous, Burst Shooting (L/H), 16-frame Shooting, Auto Bracketing	
Self-timer	Electronic control type, control time: Approx. 10 sec., 2 sec.	
Time Function	World Time	75 cities (28 time zones)
Power Source	Rechargeable lithium-ion battery D-LI122, AC adapter kit (optional)	
Battery Life	Number of Recordable Images approx. 200 pictures	* Recording capacity shows approximate number of shots recorded during CIPA-compliant testing (with display on, flash used for 50% of the shots, and 23 degrees centigrade). Actual performance may vary according to operating conditions.
	Playback Time approx. 180 min.	* According to the result of in-house testing. Actual time may differ depending on usage conditions.
	Movie Recording Time approx. 100 min.	
Interfaces	USB 2.0 (high-speed compatible) /PC/AV terminal	
Video Output	NTSC/PAL (monaural)	
Dimensions	Approx. 112.0 (W) × 61.5 (H) × 38.5 (D) mm (excluding operating or protruding parts)	
Weight	Approx. 213 g (excluding battery and SD Memory Card) Approx. 234 g (including battery and SD Memory Card)	
Accessories	Rechargeable lithium-ion battery, battery charger, USB cable, Operating Manuals & Software (CD-ROM), strap, Quick Guide	

# WARRANTY POLICY

All PENTAX cameras purchased through authorized bona fide photographic distribution channels are guaranteed against defects of material or workmanship for a period of twelve months from date of purchase. Service will be rendered, and defective parts will be replaced without cost to you within that period, provided the equipment does not show evidence of impact, sand or liquid damage, mishandling, tampering, battery or chemical corrosion, operation contrary to operating instructions, or modification by an unauthorized repair shop. The manufacturer or its authorized representatives shall not be liable for any repair or alterations except those made with its written consent and shall not be liable for damages from delay or loss of use or from other indirect or consequential damages of any kind, whether caused by defective material or workmanship or otherwise; and it is expressly agreed that the liability of the manufacturer or its representatives under all guarantees or warranties, whether expressed or implied, is strictly limited to the replacement of parts as hereinbefore provided. No refunds will be made on repairs by non-authorized PENTAX service facilities.

## Procedure During 12-month Warranty Period

Any PENTAX which proves defective during the 12-month warranty period should be returned to the dealer from whom you purchased the equipment or to the manufacturer. If there is no representative of the manufacturer in your country, send the equipment to the manufacturer, with postage prepaid. In this case, it will take a considerable length of time before the equipment can be returned to you owing to the complicated customs procedures required. If the equipment is covered by warranty, repairs will be made and parts replaced free of charge, and the equipment will be returned to you upon completion of servicing. If the equipment is not covered by warranty, regular charges of the manufacturer or of its representatives will apply. Shipping charges are to be borne by the owner. If your PENTAX was purchased outside of the country where you wish to have it serviced during the warranty period, regular handling and servicing fees may be charged by the manufacturer's representatives in that country. Notwithstanding this, your PENTAX returned to the manufacturer will be serviced free of charge according to this procedure and warranty policy. In any case, however, shipping charges and customs clearance fees to be borne by the sender. To prove the date of your purchase when required, please keep the receipt or bills covering the purchase of your equipment for at least a year. Before sending your equipment for servicing, please make sure that you are sending it to the manufacturer's authorized representatives or their approved repair shops, unless you are sending it directly to the manufacturer. Always obtain a quotation for the service charge, and only after you accept the quoted service charge, instruct the service station to proceed with the servicing.

- This warranty policy does not affect the customer's statutory rights.
- The local warranty policies available from PENTAX distributors in some countries can supersede this warranty policy. Therefore, we recommend that you review the warranty card supplied with your product at the time of purchase, or contact the PENTAX distributor in your country for more information and to receive a copy of the warranty policy.



The CE Mark is a Directive conformity mark of the European Union.

## **For customers in USA**

### **STATEMENT OF FCC COMPLIANCE**

This device complies with Part 15 of the FCC Rules. Operation is subject to the following two conditions: (1) This device may not cause harmful interference, and (2) this device must accept any interference received, including interference that may cause undesired operation.

Changes or modifications not approved by the party responsible for compliance could void the user's authority to operate the equipment. This equipment has been tested and found to comply with the limits for a Class B digital device, pursuant to part 15 of the FCC Rules. These limits are designed to provide reasonable protection against harmful interference in a residential installation. This equipment generates, uses and can radiate radio frequency energy and, if not installed and used in accordance with the instructions, may cause harmful interference to radio communications. However, there is no guarantee that interference will not occur in a particular installation. If this equipment does cause harmful interference to radio or television reception, which can be determined by turning the equipment off and on, the user is encouraged to try to correct the interference by one or more of the following measures:

- Reorient or relocate the receiving antenna.
  - Increase the separation between the equipment and receiver.
  - Connect the equipment into an outlet on a circuit different from that to which the receiver is connected.
- \* Consult the dealer or an experienced radio/TV technician for help.

## **For customers in Canada**

This Class B digital apparatus complies with Canadian ICES-003.

## **Pour les utilisateurs au Canada**

Cet appareil numérique de la classe B est conforme à la norme NMB-003 du Canada.

## **FOR CALIFORNIA, U.S.A. ONLY**

Perchlorate Material-special handling may apply. The lithium battery used in this camera contains perchlorate material, which may require special handling. See [www.dtsc.ca.gov/hazardouswaste/perchlorate](http://www.dtsc.ca.gov/hazardouswaste/perchlorate)

# Declaration of Conformity

According to 47CFR, Parts 2 and 15 for  
Class B Personal Computers and Peripherals

We: PENTAX RICOH IMAGING AMERICAS CORPORATION

Located at: 633 17<sup>th</sup> Street, Suite 2600,  
Denver, Colorado 80202, U.S.A.  
Phone: 800-877-0155 Fax: 303-790-1131

Declare under sole responsibility that the product identified herein complies with 47CFR Parts 2 and 15 of the FCC rules as a Class B digital device. Each product marketed is identical to the representative unit tested and found to be compliant with the standards. Records maintained continue to reflect the equipment being produced can be expected to be within the variation accepted, due to quantity production and testing on the statistical basis as required by 47CFR §2.909. Operation is subject to the following two conditions: (1) This device may not cause harmful interference, and (2) This device must accept any interference received, including interference that may cause undesired operation. The above named party is responsible for ensuring that the equipment complies with the standards of 47CFR §15.101 to §15.109.

Product Name: Digital Camera  
Model Number: Optio VS20  
Contact person: Customer Service Manager  
Date and Place: January, 2012, Colorado

## Information for Users on Collection and Disposal of Old Equipment and Used Batteries



### 1. In the European Union

These symbols on the products, packaging and/or accompanying documents mean that used electrical and electronic equipment and batteries should not be mixed with general household waste.



Used electrical/electronic equipment and batteries must be treated separately and in accordance with legislation that requires proper treatment, recovery and recycling of these products.



By disposing of these products correctly you will help ensure that the waste undergoes the necessary treatment, recovery and recycling and thus prevent potential negative effects on the environment and human health which could otherwise arise due to inappropriate waste handling.

If a chemical symbol is added beneath the symbol shown above, in accordance with the Battery Directive, this indicates that a heavy metal (Hg = Mercury, Cd = Cadmium, Pb = Lead) is present in the battery at a concentration above an applicable threshold specified in the Battery Directive.



































For more information about collection and recycling of used products, please contact your local authorities, your waste disposal service or the point of sale where you purchased the products.









### 2. In other countries outside the EU

These symbols are only valid in the European Union. If you wish to discard used products, please contact your local authorities or dealer and ask for the correct method of disposal.

For Switzerland: Used electrical/electronic equipment can be returned free of charge to the dealer, even when you don't purchase a new product. Further collection facilities are listed on the home page of [www.swico.ch](http://www.swico.ch) or [www.sens.ch](http://www.sens.ch).

## Symbols



 mode .....	12, 54
 mode .....	12, 54
 button .....	50, 52
[  Rec.Mode]	
menu .....	58, 216
[  Movie] menu .....	59, 217
[  Setting] menu .....	60, 218
 Green Mode .....	72
 Delete .....	132, 142
 Tele .....	74
 Wide .....	74
 Magnify .....	141
 Four-/Nine-image	
display .....	134
 Self-timer .....	90
 Continuous Shooting ....	92
 16-frame Shooting .....	92
 Burst Shooting .....	92
 Remote Control .....	93
 0-sec Remote Control ...	94
 Auto Bracketing .....	95
 Auto Picture .....	70
 Program .....	71
 Handheld Night Snap ...	77
 Night Scene .....	77
 Night Scene Portrait ....	77
 Landscape .....	68
 Blue Sky .....	68
 Flower .....	68
 Portrait .....	78
 Natural Skin Tone .....	78
 Surf & Snow .....	81
 Sport .....	81
 Digital SR .....	77
 Kids .....	79
 Sunset .....	77

 Pet .....	80
 Food .....	68
 Fireworks .....	77
 Frame Composite .....	84
 Text .....	83
 Digital Panorama .....	88
 Fish-eye .....	86
 Sketch .....	86
 Miniature .....	86

## Numerics









16-frame shooting 	92
1cm Macro 	99

## A

AC adapter .....	35
Auto + Red-eye 	97
Auto <b>AWB</b> .....	105
Auto Bracketing .....	95
AUTO ISO Range .....	110
Auto Picture Mode .....	70
Auto Power Off .....	188
Auto 	97
Auto-Macro function .....	99
Automatic Tracking AF ....	101
AV cable .....	149

## B

B&W/Sepia filter .....	158
Basic mode .....	72
Battery level indicator .....	34
Blink Detection .....	66
Blue Sky Mode .....	68
Brightness filter .....	158
Brightness Level .....	186
Built-in memory .....	168
Burst Shooting 	92

<b>C</b>	
Calendar display .....	135
Camera shake ...	75, 112, 125
Capture Mode Palette .....	67
Changing volume .....	177
Charging a battery .....	31
Checking the memory	
card .....	40
City name .....	221
Color filter .....	158
Connecting to a TV .....	149
Connecting to AV	
Equipment .....	149
Continuous Shooting  .....	92
Contrast .....	112
Copy .....	168
Cropping .....	153
<b>D</b>	
Date and time setting	46, 178
Date Imprint .....	118
Daylight  .....	105
Daylight saving time .....	45
Default settings .....	216
Delete  .....	132, 142
Destination .....	181
Digital Filter .....	158
Digital Panorama Mode .....	88
Digital SR Mode .....	77
Digital Zoom .....	74, 76
Display brightness .....	186
Display language .....	183
Dividing movies .....	167
DPOF settings .....	171
D-Range Setting .....	108
Drive Mode .....	90
<b>E</b>	
Editing movies .....	166
Electronic level display .....	26
Error messages .....	212
EV Compensation .....	107
Extract Color filter .....	158
<b>F</b>	
Face Detection .....	69, 117
Face Recall .....	113
File number .....	128
Filter .....	126
Filters .....	86, 158
Fireworks Mode .....	77
Fish-eye filter .....	158
Fish-eye Mode .....	86
Flash Mode .....	97
Flash Off  .....	97
Flash On + Red-eye  .....	97
Flash On  .....	97
Flower Mode .....	68
Fluores. Light  .....	105
Focus Assist .....	102
Focus Mode .....	99
Focusing .....	99
Focusing Area .....	101
Folder display .....	135
Folder Name .....	184
Food Mode .....	68
Format .....	176
Four-image display  .....	134
Four-way controller .....	51, 53
Frame Composite .....	163
Frame Composite Mode .....	84
Frame rate .....	124
<b>G</b>	
Green Button .....	51, 53, 120
Green Mode .....	72
Guide indications .....	25
<b>H</b>	
Handheld Night Snap Mode	
.....	77

Highlight Correction ..... 108  
Histogram ..... 25  
Hometown ..... 45, 181

## I

Image Storage Capacity .. 224  
Infinity ▲ ..... 99  
Info Display ..... 22  
Initial Settings ..... 42  
Installing a battery ..... 32  
Installing the Software .... 196  
Instant Review ..... 66  
Intelligent Zoom ..... 74

## K

Kids Mode ..... 79

## L

Landscape Mode ..... 68  
Language setting ..... 42, 183

## M

Macintosh ..... 195  
Macro 🍃 ..... 99  
Magnify Q ..... 141  
Manual Focus **MF** ..... 99  
Manual 📐 ..... 105  
Mass Storage Class ..... 200  
MediaImpression ..... 194  
Memory ..... 128  
**MENU** button ..... 51, 53  
Miniature filter ..... 158  
Miniature mode ..... 86  
Movie ..... 122  
Movie menu ..... 59, 217  
Movie SR (Movie Shake  
Reduction) Function ..... 125  
MSC ..... 200

## N

Natural Skin Tone filter .... 158

Natural Skin Tone Mode .... 78  
Night Scene Mode ..... 77  
Night Scene Portrait  
Mode ..... 77  
Nine-image display 🗪 ..... 134  
NTSC ..... 185  
Number of pixels ..... 103

## O





**OK/DISPLAY** button ... 51, 53  
Operating the menus ..... 55  
Optional accessory ..... 222

## P

PAL ..... 185  
Pet Mode ..... 80  
Photo processing lab ..... 171  
Picture Transfer Protocol  
..... 200  
Pixel Mapping ..... 190  
Playback ..... 132, 133  
Playback Mode  
Palette ..... 136, 219  
Playing back movies ..... 133  
Portrait Mode ..... 78  
Power Saving ..... 187  
Power switch ..... 40, 50, 52  
Press fully  
(shutter release button) ..... 66  
Press halfway  
(shutter release button) ..... 65  
Product Registration ..... 198  
Program Mode ..... 71  
Protect 🔒 ..... 146  
Provided Software ..... 194  
PTP ..... 200

## R

Rec. Mode Menu ..... 58, 216  
Rec. Mode Palette ..... 67  
Recorded Pixels ..... 103, 124

Recording movies .....	122	Starburst filter .....	158
Red-eye Compensation ...	162	Starting-up in the Playback Mode .....	41
Red-eye reduction  .....	97	Start-up screen .....	189
Registering menu items ...	120	Strap .....	30
Remote Control Unit .....	93	Stretch Filter .....	154
Reset .....	191	Sunset Mode .....	77
Resize .....	152	Surf & Snow Mode .....	81
Retro filter .....	158	System Requirements ....	194
Rotating .....	140		
<b>S</b>		<b>T</b>	
Saturation .....	111	Text Mode .....	83
Saving as still picture (movie) .....	167	Time imprint .....	118
Saving pictures by date ...	184	Toy Camera filter .....	158
Saving settings .....	128	Tungsten Light  .....	105
SD Memory Card .....	37	TV .....	149
Select Time .....	182	<b>U</b>	
Self-timer  .....	90	USB Connection .....	199
Sensitivity .....	109	User Registration .....	198
Setting Menu .....	60, 218	<b>V</b>	
Shade  .....	105	Video output format .....	185
Shadow Correction .....	108	Volume change .....	133
Shake Reduction ....	112, 125	<b>W</b>	
Sharpness .....	111	White Balance .....	105
Shooting information .....	21	Windows .....	195
Shooting Mode .....	67	World Time .....	181
Shutter release button .....	50, 52, 65	<b>Z</b>	
Sketch filter .....	158	Zoom .....	74
Sketch mode .....	86	Zoom lever .....	50
Slideshow .....	138		
Small Face Filter .....	156		
Smile .....	117		
Soft filter .....	158		
Sound settings .....	177		
Sound type .....	178		
Specifications .....	223		
Sport Mode .....	81		
Standard <b>AF</b> .....	99		

## Memo

# Memo

**PENTAX RICOH IMAGING COMPANY, LTD.**

2-35-7, Maeno-cho, Itabashi-ku, Tokyo 174-8639, JAPAN  
(<http://www.pentax.jp>)

**PENTAX RICOH IMAGING  
FRANCE S.A.S.**

**(European Headquarters)**

112 Quai de Bezons, B.P. 204, 95106 Argenteuil Cedex,  
FRANCE  
(HQ -<http://www.pentax.eu>)  
(France - <http://www.pentax.fr>)

**PENTAX RICOH IMAGING  
DEUTSCHLAND GmbH**

Julius-Vosseler-Strasse 104, 22527 Hamburg,  
GERMANY  
(<http://www.pentax.de>)

**PENTAX RICOH IMAGING  
UK LTD.**

PENTAX House, Heron Drive, Langley, Slough, Berks  
SL3 8PN, U.K.  
(<http://www.pentax.co.uk>)

**PENTAX RICOH IMAGING  
AMERICAS CORPORATION**

633 17th Street, Suite 2600, Denver, Colorado 80202,  
U.S.A.  
(<http://www.pentaximaging.com>)

**PENTAX RICOH IMAGING  
CANADA INC.**

1770 Argentia Road Mississauga, Ontario L5N 3S7,  
CANADA (<http://www.pentax.ca>)

<http://www.pentax.jp/english>

• Specifications and external dimensions are subject to change without notice.