

Always there to help you

Register your product and get support at
www.philips.com/welcome



CED1600



User manual	1
使用手冊	31
用户手册	59

PHILIPS

Contents

1 Safety	2
2 Your car entertainment system	3
Introduction	3
Playable media	3
What's in the box	3
Overview of the main unit	4
Overview of the remote control	5
3 Install the car entertainment system	6
Connect wires	7
Mount into the dashboard	10
4 Get started	11
Prepare the remote control	11
Turn on	11
Use the home menu	12
Set the date and time	12
Adjust the screen brightness	13
Switch display designs	13
5 Play from hard media	14
Load a disc	14
Connect a USB storage device	14
Control play	15
Browse recorded files	16
6 Listen to radio	17
Switch to radio mode	17
Set up	17
Tune to a radio station	17
Store radio stations in memory	18
Tune to a preset radio station	18
Use RDS related features	18
7 Adjust sound	20
Adjust the volume level	20
Mute sound	20
Enable the MAX Sound feature	20
Enable the DBB sound effect	20
Enable the FullSound effect	20
Select a preset sound equalizer	20
Others	21
8 Adjust settings	22
Access system setup menus	22
Adjust general settings	22
View system information	23
9 Others	23
Play external audio/video input	23
Use buttons on the steering wheel	24
Set the rear view camera	24
Reset the system	24
Replace the fuse	24
Upgrade the firmware	25
10 Product information	26
11 Troubleshooting	27
General	27
12 Notice	28
Compliance	28
Care of the environment	28
Trademark notice	28
Copyright	29

1 Safety

Read and understand all instructions before you use the device. If damage is caused by failure to follow instructions, the warranty does not apply.

- Use of controls or adjustments or performance of procedures other than herein may result in hazardous radiation exposure or other unsafe operation.
- The device is designed for negative ground (earth) 12V DC operation only.
- To reduce the risk of traffic accidents, do not watch video when driving.
- To ensure safe driving, adjust the volume to a safe and comfortable level.
- Improper fuses can cause damage or fire. When you need to change the fuse, consult a professional.
- Use only the supplied mounting hardware for a safe and secure installation.
- To avoid short circuits, do not expose the device, remote control or remote control batteries to rain or water.
- The device shall not be exposed to dripping or splashing.
- Do not place any sources of danger on the device (e.g. liquid filled objects, lighted candles).
- Never insert objects into the ventilation slots or other openings on the device.
- Never place any objects other than discs into the disc tray/slot.
- To avoid exposure to laser radiation, do not disassemble the device.
- Risk of damage to the screen! Never push, rub, or strike the screen with any object.
- Never use solvents such as benzene, thinner, cleaners available commercially, or anti-static sprays intended for discs.
- Clean the device with soft, damp cloth. Never use substances such as alcohol, chemicals or household cleaners on the device.
- Risk of swallowing coin battery!
- The product/remote control may contain a coin/button type battery, which can be swallowed. Keep the battery out of reach of children at all times! If swallowed, the battery can cause serious injury or death. Severe internal burns can occur within two hours of ingestion.
- If you suspect that a battery has been swallowed or placed inside any part of the body, seek immediate medical attention.
- When you change the batteries, always keep all new and used batteries out of reach of children. Ensure that the battery compartment is completely secure after you replace the battery.
- If the battery compartment cannot be completely secured, discontinue use of the product. Keep out of reach of children and contact the manufacturer.

2 Your car entertainment system

Congratulations on your purchase, and welcome to Philips! To fully benefit from the support that Philips offers, register your product at www.philips.com/welcome.

Introduction

With the car entertainment system, you can

- listen to music,
- watch videos,
- view pictures, and
- listen to FM (RDS included) and AM/MW radio.

Playable media

- Disc
 - DVD, Video CD, SVCD, Audio CD, JPEG Picture CD, MP3-CD, WMA-CD
 - DVD-R, DVD-RW, DVD+R, DVD+RW, CD-R, CD-RW
- USB storage device
 - Compatibility: USB 2.0, USB 1.1
 - Class support: MSC (Mass Storage Class)
 - Maximum capacity: 32 GB
- Files
 - File system: FAT16, FAT32
 - Maximum number of folders: 99
 - Maximum number of tracks/files: 999
 - Maximum level of directory: 8
 - Video formats: MPEG1, MPEG2
 - Picture format: .jpeg
 - .mp3 files
 - Sampling frequencies: 32 kHz, 44.1 kHz, 48 kHz
 - Bitrates: 8-320 kbps and variable bitrates

- .wma files
 - Versions: V4, V7, V8, V9 (L1 and L2)
 - Sampling frequencies: 44.1 kHz, 48 kHz
 - Bitrates: 64-192 kbps and variable bitrates
- ID3 tag V2.0 or later
- **Unsupported files:**
 - AAC, WAV, and PCM files
 - DRM protected WMA files (.wav, .m4a, .m4p, .mp4, and .aac)
 - WMA files in lossless format

What's in the box

Check and identify the contents of the package:

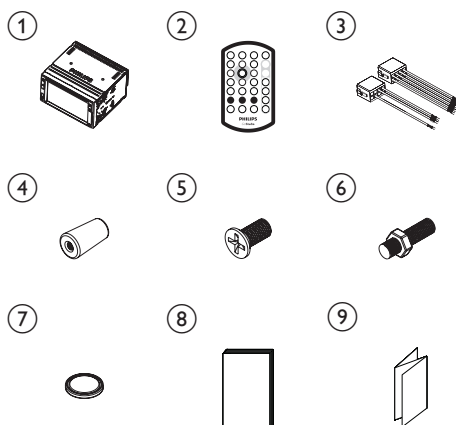

1	Main unit	2	Remote control
3	ISO male connector X 2	4	Rubber cushion X 2
5	Screw X 4 (M5x8mm)	6	Hexagon head screw
7	Remote control battery	8	User manual
9	Quick start guide		

Overview of the main unit

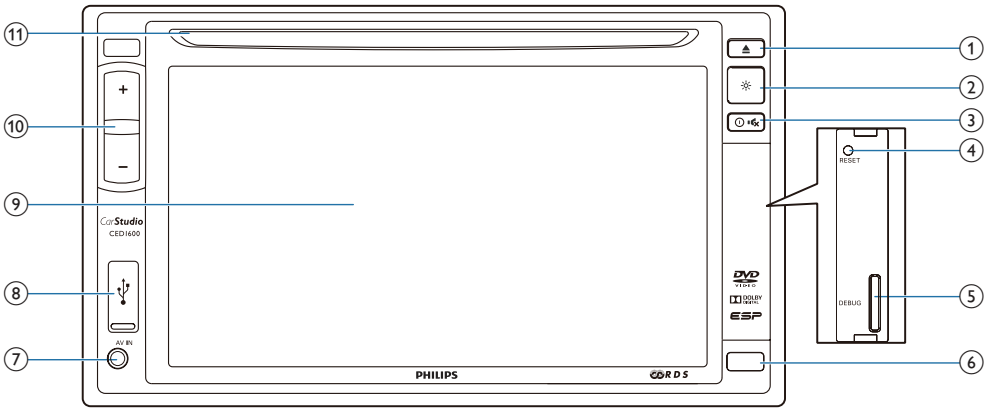

- ① ▲
 - Press to eject the disc.
- ② ☀
 - Press to adjust the brightness of LCD screen.
- ③ ⏻ 🔊
 - Press to turn on the unit.
 - Press and hold to turn off the unit.
 - Press to mute the speakers or release them from mute status.
- ④ RESET
 - Press to reset the system.
- ⑤ SD card slot
 - Insert a micro SD card that contains an upgrade packet for firmware upgrading.
- ⑥ iR sensor
 - The sensor that receives infra-red signals from the remote control.
- ⑦ AV-IN
 - Connect to the audio and video output sockets of an external player by a composite AV cable.
- ⑧ 🔌
 - Connect to a USB storage device.
- ⑨ LCD screen
- ⑩ +/-
 - Press to increase or decrease the volume.
- ⑪ Disc slot

Overview of the remote control

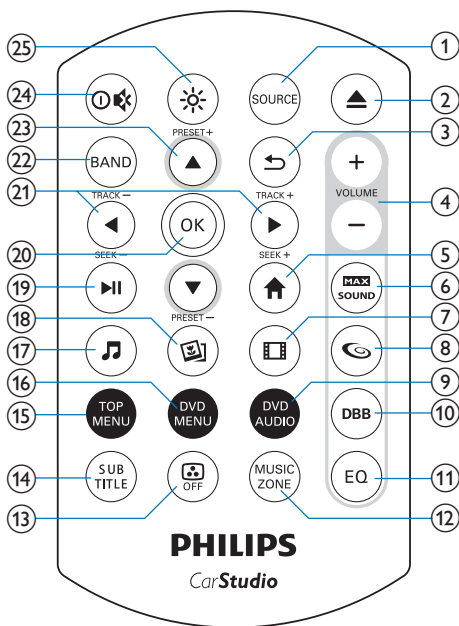

① SOURCE

- Press repeatedly to select a source.

② ▲

- Press to eject the disc.

③ ↶

- Return to the previous menu or mode.

④ VOLUME + / -

- Press to increase or decrease the volume.

⑤ 🏠

- Access the home menu.

⑥ MAX SOUND

- Enable or disable the **MAX Sound** feature.

⑦ 📺

- Switch to video playback mode.

⑧ 🌀

- Enable or disable the FullSound effect.

⑨ DVD AUDIO

- Select an audio language or audio channel.

⑩ DBB

- Enable or disable the DBB (Dynamic Bass Boost) sound effect.

⑪ EQ

- Select a preset sound equalizer.

⑫ MUSIC ZONE

- Select a music listening zone.

⑬ 📺 OFF

- Turn on or off the screen.

⑭ SUB TITLE

- Select an available subtitle.

⑮ TOP MENU

- Access the top menu.

⑯ DVD MENU

- Access the DVD menu.

⑰ 🎵

- Switch to music playback mode.

⑱ 🖼️

- Switch to picture slideshow mode.

⑲ ▶ ||

- Start, pause, or resume the play.

⑳ OK



- Confirm an option.

㉑ ◀ / ▶ / TRACK - / TRACK +

- Skip to the previous or next track, chapter; or file.
- For DVD, press and hold to select a speed for fast backward or forward search.

㉒ BAND

- Select a tuner band.

- ②③ ▲ / ▼ /PRESET +/PRESET -
 - Tune to the previous or next preset radio station.
 - Skip to the previous or next folder.
- ②④  
 - Press to power on the system.
 - Press and hold to power off the system.
 - Press to mute the speakers or release them from mute status.
- ②⑤ 
 - Press to adjust the brightness of the LCD screen.

3 Install the car entertainment system

Always follow the instructions in this chapter in sequence.

These instructions are for a typical installation. However, if your car has different requirements, make the adjustment accordingly. If you have any question regarding installation kits, consult your local retailer:

Note

- This system is designed for negative ground (earth) 12V DC operation only.
- Always install this system in the car dashboard. Other locations can be dangerous as the rear of the system heats up during use.
- To avoid short-circuit: before you connect, make sure that the ignition is off.
- Make sure that you connect the yellow and red power supply leads after all other leads are connected.
- Make sure that all loose leads are insulated with electrical tape.
- Make sure that the leads do not get caught under screws or in parts that will move (e.g. seat rail).
- Make sure that all ground (earth) leads are run to a common ground (earth) point.
- Use only the supplied mounting hardware for a safe and secure installation.
- Improper fuses can cause damage or fire. When you need to change the fuse, consult a professional.
- When you connect other devices to this system, make sure that the rating of the car circuit is higher than the total fuse value of all the connected devices.
- Never connect speaker wires to the metal body or chassis of the car.
- Never connect speaker wires with stripes to one another.

Connect wires

Note

- Make sure that all loose leads are insulated with electrical tape.
- Consult a professional to connect wires as instructed below.
- Before connection, check the car's wiring carefully.

1 Connect the ISO male connectors.

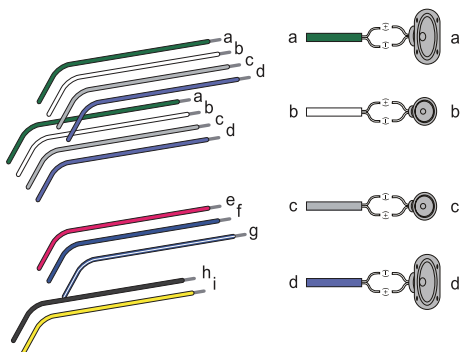

ISO male connectors	Connect to
a	Green strip, black-edged green strip
b	White strip, black-edged white strip
c	Gray strip, black-edged gray strip
d	Purple strip, black-edged purple strip
e	Red strip
f	Blue strip
g	White-edged blue strip
h	Black strip
i	Yellow strip

	Rear left speaker
	Front left speaker
	Front right speaker
	Rear right speaker
	Ignition key +12V DC when ON/ACC
	Motor/electric antenna relay control lead
	Amplifier relay control lead
	Ground
	The +12V car battery which is energized at all times

2 Connect other wires if necessary.

! Caution

- To avoid an accident, the driver must not watch video while driving. By design, this system disallows watching video during drive. Park your car in a safe place and engage the parking brake before watching video.

Note

- When the parking brake of your vehicle is not engaged, the video blocking system is activated. It blocks the display of front video source only.
- If the system is not properly connected with the parking brake control module of your vehicle, video signals will be blocked by the system, with the below message displayed on the TFT.

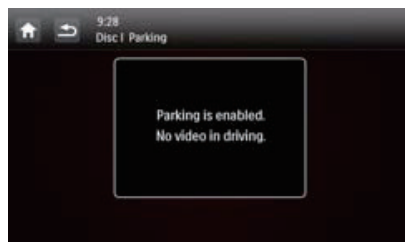

Connectors and sockets on rear panel	External sockets or connectors
1	For ISO male connectors
2	REAR OUT R (Red socket)
3	AV-IN R (Red socket)
4	AV-IN L (White socket)
5	REAR OUT L (White socket)
6	VIDEO IN (Yellow socket)

	Connectors and sockets on rear panel	External sockets or connectors
7	VIDEO OUT 1 (Yellow socket)	Video input socket of an external display device
8	VIDEO OUT 2 (Yellow socket)	Video input socket of an external display device
9	RADIO ANTENNA (Black connector)	Radio antenna
10	CAMERA IN (Purple socket)	Video output socket of an external camera
11	SUB-W OUT (Blue socket)	Sub-woofer
12	REVERSE CAMERA (Purple wire)	Reverse camera (B+)
13	PARKING BRAKE (Pink wire)	Parking brake (-)
14	OE SWC IR REMOTE IN (Brown wire)	OE SWC remote in
15	OE SWC IR REMOTE IN (Black wire)	Ground
16	OE SWC AD LEARN (White wire)	OE SWC AD Learn line 1
17	OE SWC AD LEARN (White wire)	OE SWC AD Learn line 2
18	OE SWC AD LEARN (Black wire)	Ground



Tip

- The pin arrangement for the ISO connectors depends on the type of your vehicle. To avoid damage to the system, connect properly.

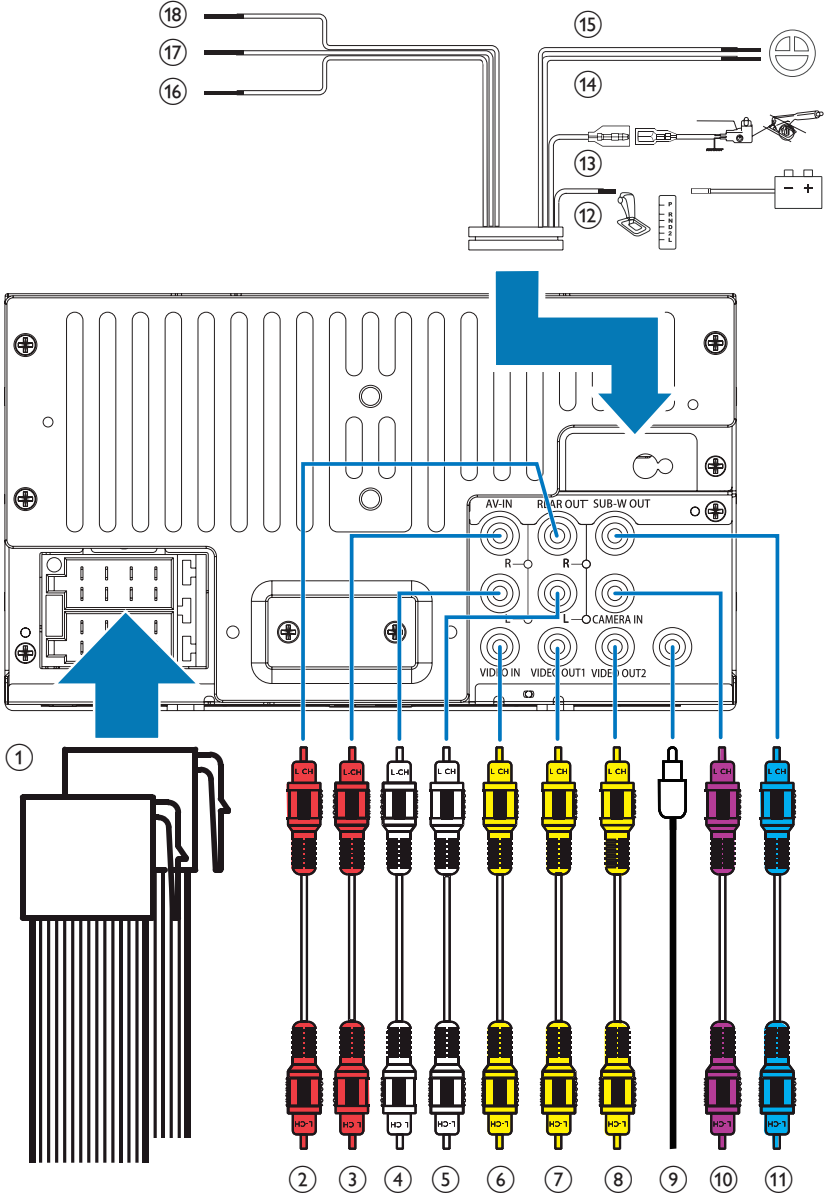

Mount into the dashboard



Note

- Make sure that wires are correctly connected before you mount the main unit into a car.
- If preset radio stations are lost when the ignition key is turned OFF and then back ON, reconnect the red leads crosswise to the yellow ones.

- 1 If the car does not have an on-board drive or navigation computer, disconnect the negative terminal of the car battery.
 - If you disconnect the car battery in a car that has an on-board drive or navigation computer, the computer may lose its memory.
 - If the car battery is not disconnected, to avoid short-circuit, make sure that bare wires do not touch each other.
- 2 Make sure that the car dashboard opening is within these measurements:

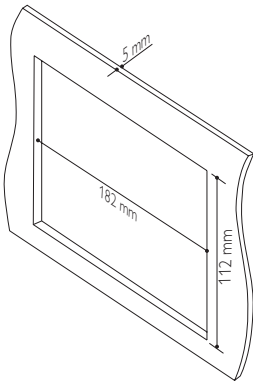

- Since the unit cannot be used if the dashboard opening's slant angle is above 20 degrees, make sure that the horizontal slant of the car dashboard opening is between 0 and 20 degrees.

- 3 Slide the unit into the dashboard until a click sound is heard.

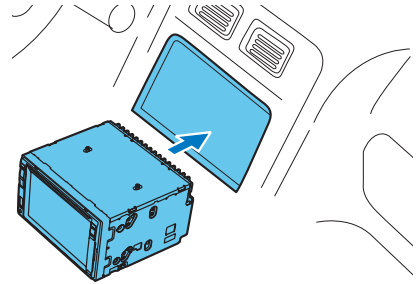

- 4 Reconnect the negative terminal of the car battery.

4 Get started

! Caution

- Risk of car accidents! Never watch video or operate this system while driving.

Prepare the remote control

For the first time use

Pull the protective sheet out.
↳ The remote control is ready for use.

Replace the battery

! Caution

- Risk of explosion! Keep batteries away from heat, sunshine or fire. Never discard batteries in fire.

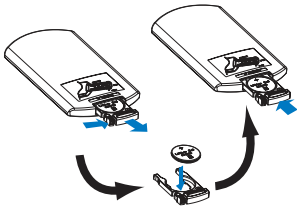

☰ Note

- Remove the battery if it is exhausted or if the remote control is not to be used for a long time.
- Batteries contain chemical substances, they should be disposed of properly.
- Perchlorate Material - special handling may apply. See www.dtsc.ca.gov/hazardouswaste/perchlorate.



- 1 Pull out the battery tray.
- 2 Insert one CR2025 battery with correct polarity (+/-) as indicated.
- 3 Insert the battery tray.

Turn on

- Press .
- ↳ PHILIPS logo and a progress bar are displayed while boot-up.
 - To turn off the system, press and hold  for 3 seconds.

For the first time use

After successful boot-up, the following interface is displayed.



- 1 Tap to select a language for on-screen display.
↳ The following interface is displayed.



- 2 Tap to select a radio region that matches your location.
↳ The following interface is displayed.



- 3 Tap **[Finish]** to complete the initial setup.
↳ The device switches to radio mode automatically.

Use the home menu

Note

- If  is displayed when you touch an icon, it indicates that the selected media or feature is unavailable at the current time.

Access the home menu







Tap  to access the home menu.

- ↳ The clock, date, and the bar of popular icons are displayed.



- To access the full menu with all feature icons displayed, tap .
- To return to the home menu, tap .





-  **[Radio]**: Switch the source to FM/AM radio.
-  **[Disc]**: Switch the source to disc.
-  **[USB]**: Switch the source to USB storage device.
-  **[AV-In 1]/[AV-In 2]**: Switch the source to the audio and video input that is transferred from an external video player.
-  **[SWC]**: Access the interface to assign functions to buttons on the steering wheel.
-  **[Settings]**: Access the system menu.

Customize the home menu



- 1 Tap and hold an icon until it is movable.
- 2 Drag it to the target place, and then release your finger.
 - When you move an icon from the bar for popular icons to the lower area, release your finger when the icon's name is displayed.
 - When you move an icon from the lower area to the bar for popular icons, release your finger when the icon's name disappears.
- 3 Tap  to return to the home menu.
 - ↳ The bar for popular icons is refreshed.

Set the date and time

- 1 Tap  >  to access the full menu with all feature icons displayed.
- 2 Tap  **[Settings]**.
 - ↳ The **[General]** menu is displayed.

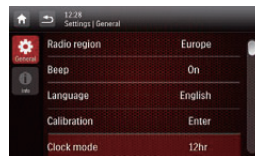

- 3 Tap **[Clock mode]** to select a time format.
 - **[24hr]**: 24-hour time format
 - **[12hr]**: 12-hour time format

- 4 Tap **[Date]** to display the interface for setting the date.

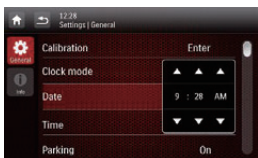

- 5 Tap **▲▼** to set the year, month, and date.

- 6 Tap **[Time]** to display the interface for setting the time.

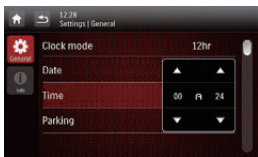

- 7 Tap **▲▼** to set the hour and minute.

- 8 Tap **↶** to return to the home menu.

- 2 Tap a setting to display the options.
 - **[Wallpaper]**: Select a wallpaper.
 - **[Skin]**: Select a background color for on-screen icons.
- 3 Tap an option to select it.
- 4 Tap **↶** to return to the previous mode.

Adjust the screen brightness

Press **☼** on the front panel to select a brightness level of the screen.

- **[LEVEL 1]**, **[LEVEL 2]**, or **[LEVEL 3]**

Switch display designs

Select a preset display design.

- 1 In any mode, tap **☰**, and then **[Display Design]**.
 - ↳ The **[Display Design]** interface is displayed.



5 Play from hard media

You can use this system to listen to audio, watch videos, and view photos that are stored on a disc or USB storage device.

Note

- Before use, check for compatible media.

Load a disc

Caution

- Never insert any object other than a disc of 12-cm diameter into the disc slot.

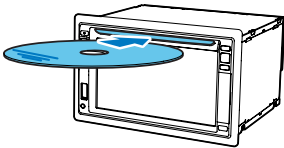

- 1 Insert the disc into the disc slot with the label side facing up.
 - ↳ Play starts automatically.
 - If play does not start automatically, tap the screen to display the ► icon, and then tap ► to start play.
- 2 To eject the disc, press ▲.
 - ↳ When the disc is ejected, the system switches to the previous source or radio mode.

Region code

This system can play DVD discs marked with the following region code.

DVD region code	Countries and regions
-----------------	-----------------------



Asia Pacific, Taiwan, Korea

Connect a USB storage device

Note

- Make sure that the USB storage device contains compatible files.
- NTFS (New Technology File System) file system is not supported.

- 1 Push the USB socket cover upwards to open it.
- 2 Connect the USB storage device to the USB socket.
 - ↳ Play starts automatically.

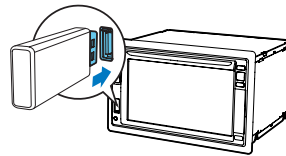

- To remove the USB storage device, switch the system to another source first.

Control play

Videos

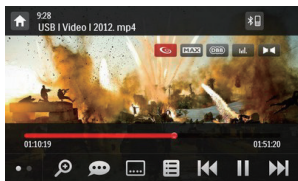

- : Return to the home menu.
- : Zoom in or out of the image.
- : Select an available audio channel or audio language.
- : Select an available subtitle.
- - For DVD, return to the disc menu or root menu.
 - For recorded files, return to the list of files or folders (see 'Browse recorded files' on page 16).
- **PBC**: For VCD/SVCD only, enable or disable the PBC (Playback Control) feature.
- / : Skip to the previous or next title, chapter; track, or file.
 - To search forward fast or rewind the track, tap on the progress bar.
- / : Start, pause, or resume play.
- : Display control icons on the second page.

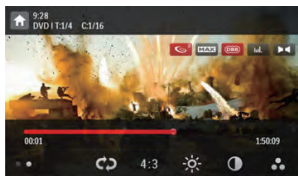





- : Select a repeat mode.
 - DVD: **[Repeat chapter]** (repeat the current chapter), **[Repeat title]** (repeat the current title), **[Repeat all]** (repeat all chapters and titles), or **[Repeat off]** (cancel repeat play).

- VCD/SVCD: **[Repeat one]** (repeat the current track) or **[Repeat all]** (repeat all tracks).
- Recorded files: **[Repeat one]** (repeat the current video file), **[Repeat folder]** (repeat all video files in the current folder), or **[Repeat all]** (repeat all video files).
- **[16:9]/[4:3]**: Select an aspect ratio.
- : Tap to display the brightness bar; and then tap on the bar to adjust the screen brightness.
- : Tap to display the contrast bar; and then tap on the bar to adjust the image contrast.
- : Tap to display the saturation bar; and then tap on the bar to adjust the image saturation.
- : Display control icons on the first page.

Audios









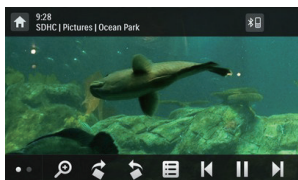



- : Return to the home menu.
- - Press once to access the track list.
 - Press twice to access the folder list.
 - Press repeatedly to return to the playback interface.
- : For recorded files only, skip to the next audio folder.
- : Return to the list of tracks or folders (see 'Browse recorded files' on page 16).
- / : Skip to the previous or next track.
 - To search forward fast or rewind the track, tap on the progress bar.
- / : Start, pause, or resume play.
- / / : Select a repeat mode.
 - : Repeat the current track.





- : For recorded files, repeat all tracks in the current folder.
-  (highlighted): Repeat all tracks.
- : Select random play ( highlighted) or sequential play ( in gray).

Pictures



- : Return to the home menu.
- : Zoom in or out of the picture.
-  / : Rotate the picture clockwise or anti-clockwise by 90 degrees.
-  / : Return to the list of files or folders (see 'Browse recorded files' on page 16).
-  / : Select the previous or next picture.
-  / : Pause or resume the slideshow.
- : Display control icons on the second page.



- **[16:9]/[4:3]**: Select an aspect ratio.
- : Tap to display the brightness bar; and then tap on the bar to adjust the screen brightness.
- : Tap to display the contrast bar; and then tap on the bar to adjust the image contrast.
- : Tap to display the saturation bar; and tap on the bar to adjust the image saturation.
- : Display control icons on the first page.



Browse recorded files

During playing recorded files, you can access the file list and select files from the list.

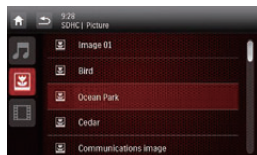
1 Tap  to access the list of files or folders.



2 Tap an icon to select a file category.

- : Display the list of audio tracks or folders.
- : Display the list of picture files or folders.
- : Display the list of video files or folders.

3 Tap the name of a file to start play.

6 Listen to radio

Switch to radio mode

After the boot-up at the first time, the system switches to radio mode automatically.

To switch the source back to radio afterwards, tap  **[Radio]** on the home menu.

↳ The interface for radio is displayed.



Set up

Before you search for radio stations, make prior setup.

Tap  to display the setup menus.

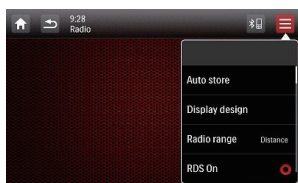

Select a radio range

1 Tap **[Radio Range]**.

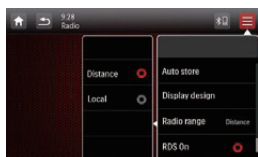

2 Tap **[Distance]** or **[Local]** to select a tuner sensitivity.

- **[Distance]**: Stations with strong and weak signals can be tuned to.
- **[Local]**: Only stations with strong signals can be tuned to.

Enable the RDS feature

Note

- RDS feature is enabled by default.
- Only after the RDS feature is enabled, the option of **[PTY list]** is displayed.

Tap **[RDS Off]** to enable the RDS feature.

↳ The option of **[PTY list]** is displayed.

- To disable the RDS feature, tap **[RDS On]**.

Tune to a radio station



1 Tap **FM** or **AM** to select a band.

- FM bands: **FM1, FM2, FM3**
- AM bands: **AM1, AM2**

2 Tap **<** or **>** repeatedly until the frequency of target radio station is displayed.

- To tune to a radio station automatically, tap and hold **<** or **>** until the frequency digits start change.

Tip

- You can also press **BAND** on the remote control repeatedly to select a band.

Store radio stations in memory

You can store up to 6 stations in each band.

Store radio stations manually

- 1 Select a band.
- 2 Tune to the target radio station.
- 3 Tap and hold one of the channels (1 to 6) over two seconds.
 - ↳ The radio station is saved under the selected channel.

Store radio stations automatically

You can search for a radio station with intro search, which broadcasts a 10-second preview of each detected radio station.

- 1 Select a band.
- 2 Tap .
- 3 Tap **[Auto Store]**.
 - ↳ Auto search starts. The six strongest stations of the selected band are saved in preset channels automatically.

Tune to a preset radio station

- 1 Select a band.
- 2 Tap one of the preset channels (1 to 6) to select a preset radio station.



Use RDS related features

Note

- Only after RDS feature is enabled, you can use RDS related features.

Search for RDS programs of a specific type



- 1 Tap  > **[PTY list]** to display the list of program types.
- 2 Tap the name of a program type to start search.
 - ↳ Once an RDS station that transmits programs of the selected type is found, the RDS station is broadcast automatically.
 - To save the RDS station, tap and hold one of the preset channels.
 - To search for another RDS station, repeat steps 1 and 2.

RDS program types

Item	Program type	Description
1	NEWS	News services
2	AFFAIRS	Politics and current affairs
3	INFO	Special information programs
4	SPORT	Sports
5	EDUCATE	Education and advanced training
6	DRAMA	Radio plays and literature

7	CULTURE	Culture, religion and society
8	SCIENCE	Science
9	VARIED	Entertainment programs
10	POP M	Pop music
11	ROCK M	Rock music
12	MOR M	Light music
13	LIGHT M	Light classical music
14	CLASSICS	Classical music
15	OTHER M	Special music programs
16	WEATHER	Weather
17	FINANCE	Finance
18	CHILDREN	Children's programs
19	SOCIAL	Social Affairs
20	RELIGION	Religion
21	PHONE IN	Phone In
22	TRAVEL	Travel
23	LEISURE	Leisure
24	JAZZ	Jazz Music
25	COUNTRY	Country Music
26	NATION M	National Music
27	OLDIES	Oldies Music
28	FOLK M	Folk Music
29	DOCUMENT	Documentary
30	TEST	Alarm Test
31	ALARM	Alarm

Use alternate frequencies

If the signal of an RDS station is poor, enable the AF (Alternate Frequency) function. The system searches for a strong station that broadcasts the same program.

Tap **AF** to enable or disable the AF function.

- **AF** (highlighted): The function is enabled.
- **AF** (in gray): The function is disabled.

Receive traffic announcement

If you want to receive traffic announcement, enable the TA (Traffic Announcement) function. Tap **TA** to enable or disable the TA function.

- **TA** (highlighted): The function is enabled. When a traffic announcement is on air, the system automatically switches to radio mode and begins to broadcast the traffic announcement. When the traffic announcement is over, the system returns to the previous mode.
- **TA** (in gray): The function is disabled.

7 Adjust sound

When you listen to radio, enjoy music, or watch video, follow the instructions below to adjust sound.

Adjust the volume level

Press +/- repeatedly on the front panel.

- +: Increase the volume level.
- -: Decrease the volume level.

Mute sound

Press  on the front panel.

- To release the speakers from mute status, press  again.

Enable the MAX Sound feature



Tap **MAX** on the playback interface.

- **MAX** (highlighted): The **MAX Sound** feature is enabled.
- **MAX** (in gray): The **MAX Sound** feature is disabled.

Enable the DBB sound effect

When DBB (Dynamic Bass Boost) is enabled, low tones are enhanced electronically.

Tap  on the playback interface.

-  (highlighted): DBB sound effect is enabled.
-  (in gray): DBB sound effect is disabled.

Enable the FullSound effect

Note



- This feature is unavailable when you listen to radio.

Philips FullSound restores the audio details that are lost due to compression. It enriches the music signals so that what you hear is the full sound with every nuance of emotion and every detail of musical genius.

Philips FullSound can:

- bring out CD sound quality from an MP3 track,
- achieve richer bass with greater depth and impact,
- restore the sense of spaciousness that lacks in a compressed audio, and
- enhance sound precision and details.

Tap  on the playback interface.



-  (highlighted): The FullSound effect is enabled.
-  (in gray): The FullSound effect is disabled.

Select a preset sound equalizer

- 1 Tap  on the playback interface.
 - ↳ The current equalizer settings are displayed.





- 2 Tap < or > to select a preset sound equalizer:
 - [Custom], [Techno], [Rock], [Classic], [Jazz], [Optimal], [Flat], or [Pop]
 - ↳ The selected sound equalizer is highlighted.

- 3 Tap on the circle or bar to adjust the settings.
- **[Bass]**: bass range (-14 to +14)
 - **[Middle]**: middle range (-14 to +14)
 - **[Treble]**: treble range (-14 to +14)
 - **[LPF]**: low pass filter range (60 Hz, 80 Hz, 100 Hz, or 160 Hz)
 - **[MPF]**: middle pass filter range (0.5 kHz, 1.0 kHz, 1.5 kHz, or 2.5 kHz)
 - **[HPF]**: high pass filter range (10.0 kHz, 12.5 kHz, 15.0 kHz, or 17.5 kHz)
 -  : Tap and hold to restore the settings.
- 4 Tap  to exit.

Others

Tap  on the playback interface.
 ↳ The setup interface is displayed.



-  : Tap to display the **[Music zone]** interface for selecting a listening zone.
-  : Tap to display the **[Fader/ Balance]** interface for adjusting the fader and balance.
-  : Tap to display the **[SubWoofers]** interface for setting the sub-woofer.

Adjust the fader and balance

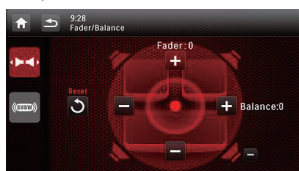

Tap + or - to adjust fader or balance value.

- **[Fader]**: fader range (+16 to -16).
- **[Balance]**: balance range (-16 to +16).

Set the sub-woofer

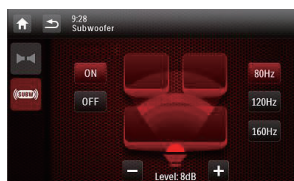

- **[On]/[Off]**: Tap to turn on or off the sub-woofer.
- + / - : Tap to set the volume of sub-woofer (0 dB to 14 dB).
- **[80 Hz]/[120 Hz]/[160 Hz]**: Tap to select a low pass filter range for the sub-woofer.

Select a listening zone

Philips' innovative Zone technology enables the driver or passengers to enjoy music with the best speakers balance and experience more vivid spacial effect as the artist is intended to create. You can switch the music listening zone from the driver to passengers for the best speaker sound settings in car.

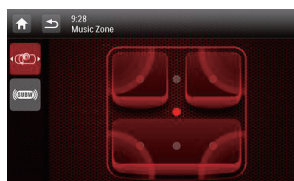

Tap a gray point to switch the listening zone.

↳ The highlighted area indicates the current listening zone.

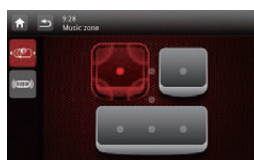

8 Adjust settings

Access system setup menus

1 Tap **↑** > **▲** to display all feature icons.

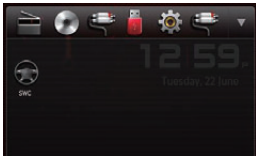

2 Tap **⚙** [Settings].
 ↳ The [General] menu is displayed.



- 3 Tap an icon on the left.
- **⚙** : Access the [General] menu to adjust general settings.
 - **i** : Access the [Info] menu to view system information.
- 4 Swipe your finger up or down to view more settings.
- 5 Tap an option to view details or change the setting.
- To exit the menu, tap **↩**.

Adjust general settings



Settings	Options	Description
[Radio Region]		Select a radio region that matches your location.
[Beep]	[On]	Turn the beep sound on. Each time you press a button or tap an icon, the unit beeps.
	[Off]	Turn off the beep sound.
[Language]		Select an OSD (on-screen display) language.
[Calibration]		Follow the on-screen instructions to calibrate the touch screen.
[Clock mode]	[12Hr]/ [24Hr]	Select a time format.
[Date]		Set the date.
[Time]		Set the time.
[Parking]	[On]/ [Off]	Enable or disable the video blocking system.
[Demo] (Auto start after power off)	[On]/ [Off]	Enable it to demonstrate features after the system is power off.

View system information



Settings

Options

[ARM version]

View firmware versions.

[Servo version]

[MCU version]

[DVD regions]

View the DVD region code that the system supports.

[Restore factory defaults]

Tap to display the dialog box for restoring the system.

- Tap **[Yes]** to restore the system to factory default status.
- Tap **[No]** to return to the previous menu.

9 Others

Play external audio/video input

You can connect an external audio/video player to this system.

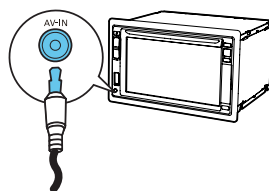

- 1 Connect a composite AV cable to
 - the **AV-IN** socket on the front panel, and
 - the audio and video output sockets of the external player.
- 2 Tap **⬆ > ⬆** to access the full menu with all feature icons displayed.
- 3 Tap **⌂ [AV-IN1]** to display the playback interface.
- 4 Operate on the external player to start play (see the user manual of the external device).



Tip

- If you connect this system to an external player through the **VIDEO IN**, **AV-IN L**, and **AV-IN R** sockets on the rear panel, tap **⌂ [AV-IN2]** to switch the source instead of **⌂ [AV-IN1]**.

Use buttons on the steering wheel

You can assign a function to a button on the steering wheel, and then control the system with that button.

- 1 Tap > to access the full menu with all feature icons displayed.
- 2 Tap .
↳ The [Steering Wheel Remote Control Learning] interface is displayed.



- 3 Tap an icon, for example, , of which you want to assign the function to a button on the steering wheel.



- To cancel the assignment, tap [Cancel].
- 4 Press and hold the button on the steering wheel for one second.
↳ The following interface is displayed.



- 5 Repeat steps 3 and 4 to assign more functions to buttons on the steering wheel.
 - To clear the assignment, tap [Clear All].

Set the rear view camera

If a rear view camera is connected, you can view on the screen what the camera takes.

- 1 Tap > to access the full menu with all feature icons displayed.
- 2 Tap .
↳ Picture from rear camera is displayed.



Reset the system

If the system hangs up, reset it.

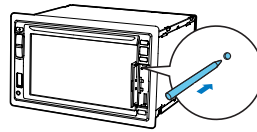

- 1 Flip up the protective cover.
- 2 Press **RESET** with the tip of a ball-point pen or toothpick.

Replace the fuse

If there is no power, check the fuse and replace it if it is damaged.

- 1 Detach the main unit from dashboard.
- 2 Check the electric connection.
- 3 Remove the damaged fuse from the rear panel.

- 4 Insert a new fuse with the same specifications (15 A).

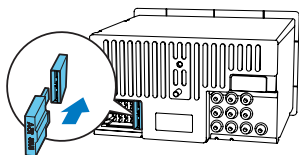

Tip

- If the fuse gets damaged immediately after it is replaced, an internal malfunction may occur. In this case, consult your Philips retailer.

Upgrade the firmware

Note

- Power supply must not be interrupted during the upgrade.
- When the firmware upgrade succeeds, all settings are restored to the factory default status.

Register your product

- 1 Go to www.philips.com/welcome.
- 2 Click the link of "**Register my product**" (the exact wording of this link name may vary in different languages).
- 3 Log in with your account on the prompt Web page.
 - If you have no account for Club Philips, create one first on this Web page.
- 4 Search your product with "**CED1600/98**" as the keyword.
- 5 Click the link of search result to access the Web page for registering your product.

- 6 Fill in necessary information about this product to complete the registration.
 - ↳ With the registration, you can get information about software update and product support at this Web page or via your mailbox that is registered as the account for Club Philips.

Perform the upgrade

- 1 Check the current firmware version of this system (see "View system information" on page 23).
- 2 Go to www.philips.com/support.
- 3 Login with your account for Club Philips.
 - ↳ Support information about your registered product is displayed.
- 4 Click the link of "**Firmware Upgrade Readme File**" (the exact wording of this link name may vary in different languages).
- 5 Read and understand the instructions on firmware upgrade.
- 6 Follow the instructions to download the upgrade packet and complete the upgrade.
 - If the upgrade fails, reboot this system, and then perform the upgrade again.

10 Product information



Note

- Product information is subject to change without prior notice.

General

Power supply	12V DC (11 V - 16 V), negative ground
Fuse	15 A
Suitable speaker impedance	4 - 8 Ω
Maximum power output	50 W \times 4 channels
Continuous power output	20 W \times 4 channels (4 Ω 10% T.H.D.)
Pre-Amp output voltage	4.0 V (CD play mode; 1 kHz, 0 dB, 10 k Ω load)
Sub-woofer output voltage	4.0 V (CD play mode, 61 Hz, 0 dB, 10 k Ω load)
Aux-in level	\geq 800 mV
Dimensions (W \times H \times D)	178 \times 101.5 \times 160 mm
Weight (main unit)	3.1 kg

Disc player

System	DVD / CD audio / MP3 system
Disc diameter	12 cm
Frequency response	20 Hz - 20 kHz
Signal/noise ratio	> 75 dB
Total harmonic distortion	Less than 0.3%
Channel separation	> 55 dB
Video signal format	NTSC/PAL
Video output	1 +/- 0.2V p-p

Radio

Frequency range - FM	87.5 - 108.0 MHz (50 kHz per step)
Frequency range - AM(MW)	522 - 1620 kHz (9 kHz per step)
Usable sensitivity - FM	2 μ V
Usable sensitivity - AM (MW)	25 μ V

LCD

Screen size	6.2 inches
Display resolution	800 \times 480 dots
Contrast ratio	500
Brightness	450 cd/m ²

11 Troubleshooting



Warning

- Never remove the casing of this product.

To keep the warranty valid, never try to repair the product yourself.

If you encounter problems when using this product, check the following points before requesting service. If the problem remains unsolved, go to the Philips Web page (www.philips.com/support). When you contact Philips, make sure that the product is nearby and the model number and serial number are available.

General

No power

- Car engine has not been started. Start the car engine.
- Connections are incorrect.
- The fuse has been damaged. Replace the fuse.

No sound

- Volume is too low. adjust the volume.
- Speaker connections are incorrect.

No response to the remote control

- Make sure that the path between the remote control and the unit is clear from obstacles.
- Move the remote control close to the unit, and point it at the iR sensor.
- The function is not applicable to the current media.
- Replace the remote control battery.

The disc does not play.

- The disc is upside down. Make sure that the printed side is upwards.
- The disc is dirty. Clean the disc with a clean, soft, lint-free cloth. Wipe the disc outwards from the center.

- The disc is defective. Try another disc.
- The disc is incompatible. Try another disc.
- The recordable disc is not finalized.
- The region code of DVD disc is not supported. Use a disc with proper region code.

No image

- Parking wire connection is incorrect. Check the wiring.

Image flashes or is distorted.

- Video connection is improper. Check the connections.

Noise in broadcasts

- Signals are too weak. Select another station with stronger signals.
- Check the connection of the car antenna.

Preset stations are lost.

- Battery cable is not correctly connected. Connect the battery cable to the terminal that is always live.

The fuse is broken.

- The fuse type is incorrect. Replace it with a 15 A fuse.
- Speaker wire or power wire is grounded. Check the connections.

12 Notice

Any changes or modifications made to this device that are not expressly approved by Philips Consumer Lifestyle may void the user's authority to operate the equipment.

Compliance

This apparatus includes this label:



Care of the environment



Your product is designed and manufactured with high quality materials and components, which can be recycled and reused. Never dispose of your product with other household waste. Please inform yourself about the local rules on the separate collection of electrical and electronic products and batteries. The correct disposal of these products helps prevent potentially negative consequences on the environment and human health. Your product contains batteries, which cannot be disposed of with normal household waste. Please inform yourself about the local rules on separate collection of batteries. The correct disposal of batteries helps prevent potentially negative consequences on the environment and human health.

Please visit www.recycle.philips.com for additional information on a recycling center in your area.

Environmental information

All unnecessary packaging has been omitted. We have tried to make the packaging easy to separate into three materials: cardboard (box), polystyrene foam (buffer) and polyethylene (bags, protective foam sheet.) Your system consists of materials which can be recycled and reused if disassembled by a specialized company. Please observe the local regulations regarding the disposal of packaging materials, exhausted batteries and old equipment.

Trademark notice



Windows Media and the Windows logo are trademarks, or registered trademarks of Microsoft Corporation in the United States and/or other countries.



Manufactured under license from Dolby Laboratories. Dolby and the double-D symbol are trademarks of Dolby Laboratories.



'DVD Video' is a trademark of DVD Format/Logo Licensing Corporation. Other trademarks and trade names are those of their respective owners.

Copyright



**Be responsible
Respect copyrights**

This item incorporates copy protection technology that is protected by U.S. patents and other intellectual property rights of Rovi Corporation. Reverse engineering and disassembly are prohibited.

2013 © Koninklijke Philips Electronics N.V. Specifications are subject to change without notice. Trademarks are the property of Koninklijke Philips Electronics N.V or their respective owners. Philips reserves the right to change products at any time without being obliged to adjust earlier supplies accordingly.



Specifications are subject to change without notice
© 2013 Koninklijke Philips Electronics N.V.
All rights reserved.

CED1600_98_UM_V1.1

