

Register your product and get support at
www.philips.com/welcome

CED229/98



User manual

1

使用手冊

23

PHILIPS

Contents

1 Important	2
--------------------	---

2 Your car audio system	3
Introduction	3

3 Play	4
Load and eject discs	4
Insert and remove USB device	4
Insert and remove SD/SDHC card	5
Skip/search	5
Intro play	6
Repeat play	6
Random play	6
Select Language	7
Dynamic Bass Boost	7
MAX sound	7
Zoom	8

4 Radio	9
Select tuner sensitivity	9
Manual tune to a radio station	9
Auto tune to a radio station	10
Store stations manually	10
Store stations automatically	10
Select the preset station	10
Select stereo or mono broadcasting	10

5 Play with RDS	12
Activate AF/TA/REG/CT functions	12
Search for an RDS station by PTY information	12

6 System settings	14
Adjust general settings	14
Adjust AV-In setting	14
Select DVD video settings	14
Select language settings	15
Adjust radio settings	15

7 Other settings	16
Select equalizer settings	16
Control zone settings	16
Other sound settings	17
Select Video Output format	17
Turn on or off the screen backlight	18
Reset	18
Replace fuse	18

8 Product information	19
General	19
Disc player	19
Tuner	19
LCD	19
Compatible USB devices	19
Supported formats	19
Unsupported formats	20

9 Troubleshooting	21
--------------------------	----

10 Notice	22
------------------	----

1 Important

- Read and understand all instructions before you use the apparatus. If damage is caused by failure to follow instructions, the warranty does not apply.
 - Use of controls or adjustments or performance of procedures other than herein may result in hazardous radiation exposure or other unsafe operation.
 - This unit is designed for negative ground (earth) 12V DC operation only.
 - To reduce the risk of traffic accident, do not watch video during driving.
 - To ensure safe driving, adjust the volume to a safe and comfortable level.
 - Improper fuses can cause damage or fire. When you need to change the fuse, consult a professional.
 - Use only the supplied mounting hardware for a safe and secure installation.
 - To avoid short circuit, do not expose the apparatus, remote control or remote control batteries to rain or water.
 - Never insert objects into the ventilation slots or other openings on the apparatus.
 - Never place any objects other than discs into the disc tray/slot.
 - Visible and invisible laser radiation when open. Avoid exposure to beam.
 - Risk of damage to the screen! Never touch, push, rub or strike the screen with any object.
 - Never use solvents such as benzene, thinner, cleaners available commercially, or anti-static sprays intended for discs.
- Clean the apparatus with soft, damp cloth. Never use substances such as alcohol, chemicals or household cleaners on the apparatus.

2 Your car audio system

Congratulations on your purchase, and welcome to Philips!

To fully benefit from the support that Philips offers, register your product at www.Philips.com/welcome.

Read this user manual carefully before you install and use the unit. Save it for future reference.

Introduction

With the in-car audio system, you can enjoy your drive while you listen to:

- FM or AM (MW) radio
- Audio from a USB drive, a SD/SDHC card, external devices.
- Music CDs
- DVD and VCD video

3 Play

Make sure that the disc or device contains playable music or video.

Note

- For CDs recorded in multiple sessions, only the first session is played.
- Does not support MP3 Pro audio format.
- It may not support and display special characters track name (ID3) or album name properly.
- It cannot play some WMA is protected by Digital Rights Management (DRM).
- The system does not display or play the folders or files that exceed the supporting limit.

Warning

- To reduce the risk of traffic accident, do not watch video during driving.

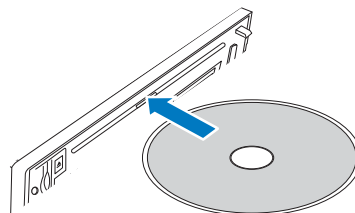

3 To remove the disc, press the **▲** button.
↳ When the disc is ejected, the unit switches to TUNER mode automatically.

4 Close the front panel.
↳ After a few seconds, the screen illuminates.

- For video discs, press **◀◀** or **▶▶** to select an item, then press **OK/MUTE** to start playing.
- For discs that contain MP3s, WMAs, or JPEGs, press **◀◀** or **▶▶** to select a folder, track or picture. Press **OK/MUTE** to start playing.

Tip

- If the disc is blocked in the disc compartment, press and hold the **▲** button until the disc comes out.

Load and eject discs

1 Press **▲** to open the front panel.

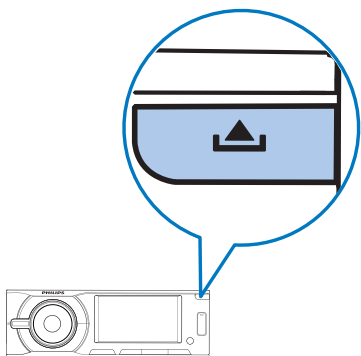

2 Insert the disc into the disc slot with label side facing up.
↳ Play resumes from the point where it was last stopped.

Insert and remove USB device

1 Slide down the USB socket cover.

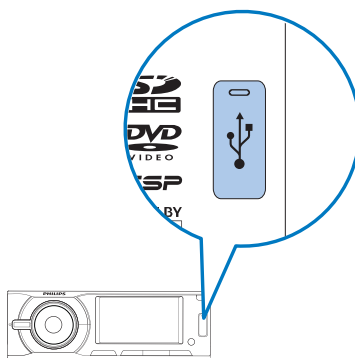

- 2 Insert the USB device into the USB socket.
↳ The unit starts playing from the USB device automatically.
- 3 To remove the USB device, press **OK MUTE** to turn off the unit.
- 4 Remove the USB device.

- 3 To remove the SD or SDHC card, press **OK MUTE** to turn off the unit.
- 4 Press the card until you hear a click sound.
↳ The card is now disengaged.

Insert and remove SD/SDHC card

- 1 Press **▲** to open the front panel.

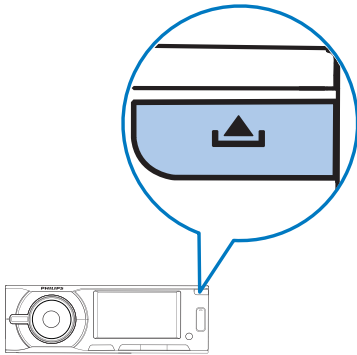

- 2 Insert SD or SDHC card into the card slot.
↳ The unit starts playing from the SD/SDHC card automatically.

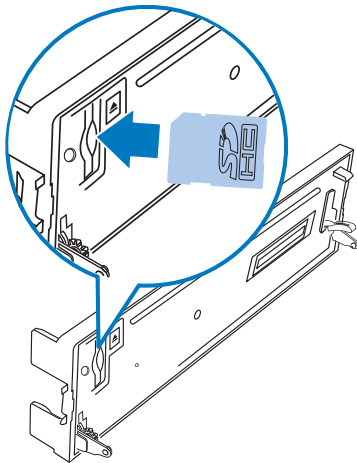

Skip/search

During video and audio disc play

- To skip to a specified chapter or track, press the numeric buttons.

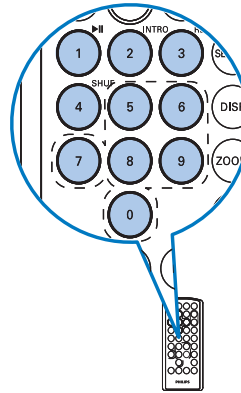

- To skip to the previous or next chapter or track, press **◀◀** or **▶▶**.

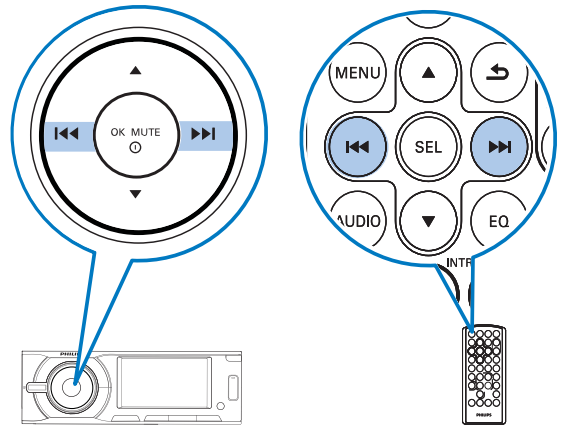

- To search backward or forward quickly, press **◀◀** or **▶▶** for 3 seconds.
- Press **1 ▶▶** to resume normal play.

During MP3/WMA play

- To select a specific song folder, press **→** twice to display the folder list. Press **▲** or **▼** to select, and then press **OK/MUTE** to confirm.

To select a specific track, press **▲** or **▼** within the folder. Press **OK/MUTE** to confirm.

- To skip to a specified chapter or track, press the numeric buttons.

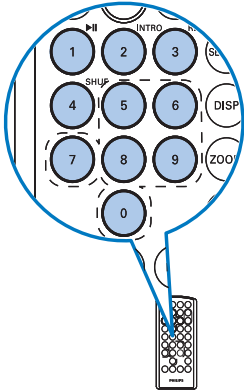

Intro play

This feature plays the first 10 seconds of each audio track.

Press the **INTRO 2** button to enable and disable this function.

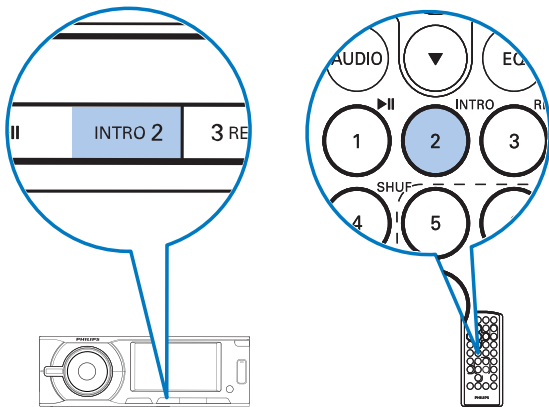

Repeat play

There are 3 standard modes of repeat play for video, audio, and MP3/WMA.

Press the **3 REP** button repeatedly to select.

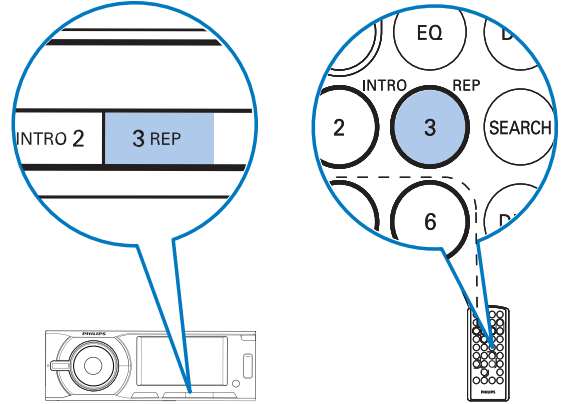

- [REP ONE]**: play the current chapter or track repeatedly.
- [REP DIR]**: play the current folder repeatedly.
- [REP ALL]**: play all chapters in the title or all tracks repeatedly.
- [REP CANCEL]**: cancel repeat play.

Random play

There are 3 standard modes of random play for audio and MP3/WMA.

Press the **SHUF 4** button repeatedly to select.

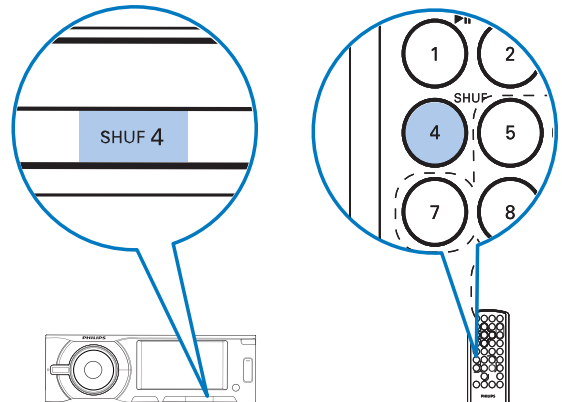

- **[SHUFFLE ALL]**: start random play for all tracks.
- **[SHUFFLE DIR]**: start random play in current folder.
- **[SHUFFLE OFF]**: cancel random play.

Select Language

Subtitle

You can select the subtitle language if the DVD discs contain two or more subtitle languages.

During play, press **SUBTITLE** on the remote control repeatedly until the language is selected.

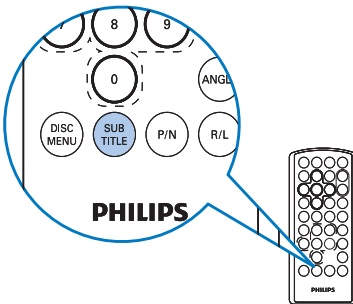

Audio

You can select the audio language if the video discs contain two or more audio channels.

During play, press **R/L** on the remote control repeatedly until the language is selected.

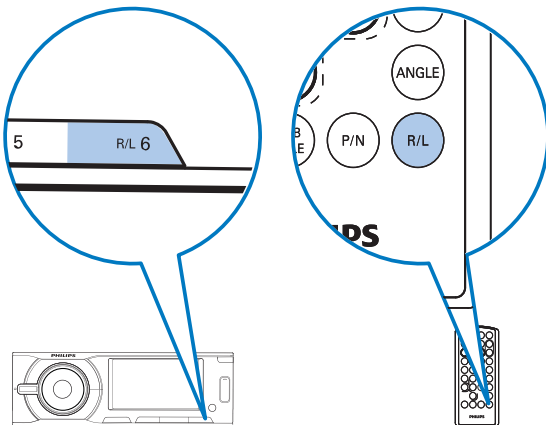

Dynamic Bass Boost

- 1 Press **MAX SOUND / DBB** on the car audio system for 3 seconds or press **DBB** on the remote control.
 - ↳ **[DBB ON]**: The Dynamic Bass Boost (DBB) function is on.
 - ↳ **[DBB OFF]**: The DBB function is off.
- 2 Press **DBB** again to change the DBB setting.

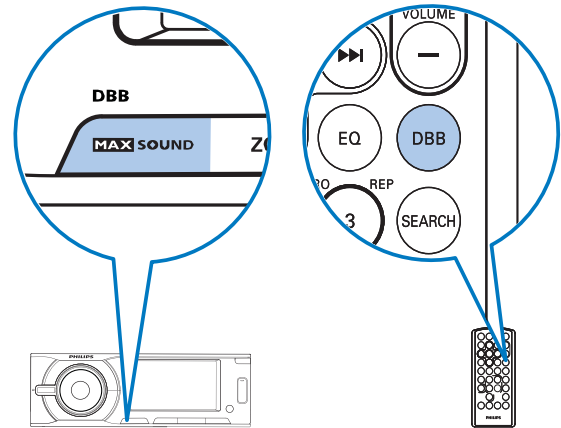

MAX sound

- 1 Press **MAX SOUND / DBB** to produce an instant boost in bass and maximize volume.
- 2 Press **MAX SOUND / DBB** again to turn off.

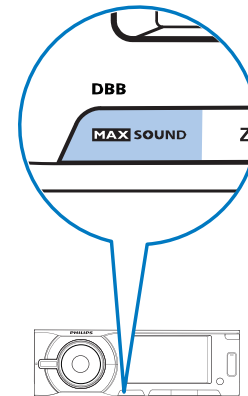

Zoom

To zoom in and out of video images and pictures:

- 1 Press **ZOOM** on the remote control repeatedly.
↳ **[ZOOM]** is displayed.

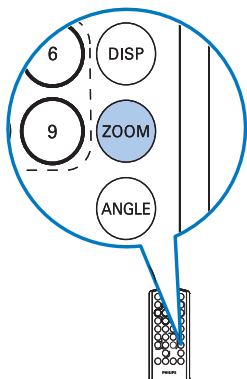

- 2 Press the navigation buttons to pan across the display.

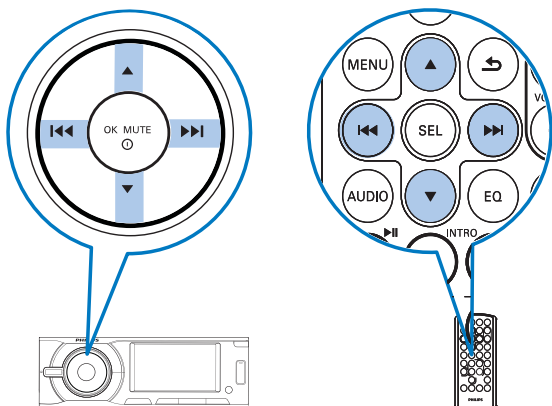

4 Radio

Select tuner sensitivity

Before you start to search for radio station, you can select tuner sensitivity.

- 1 Press **MENU**.
↳ The main menu is displayed.



- 2 Press the navigation buttons to select **[SETTINGS]**, then press **SEL** on remote control or **OK/MUTE** on the car audio to confirm.
- 3 Press **▲** or **▼** button to select **Ⓜ**.

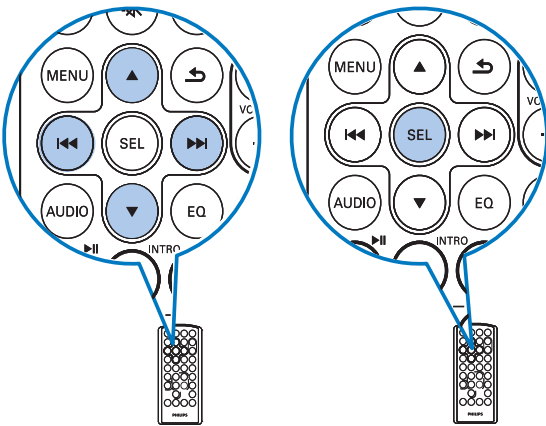

- 4 Press **▶▶** to select **[LOC_DX]**,
- 5 Press **▶▶** again to reach the **[LOC_DX]** option list.
 - **[LOC]**: only broadcast local stations with strong signals.

- **[DX]**: broadcast any stations with strong and weak signals.

- 6 Press **▲** or **▼** button to select **[LOC]** or **[DX]**, then press **SEL** on remote control or **OK/MUTE** on the car audio to confirm.

Manual tune to a radio station

- 1 Press **SOURCE** until you select radio.

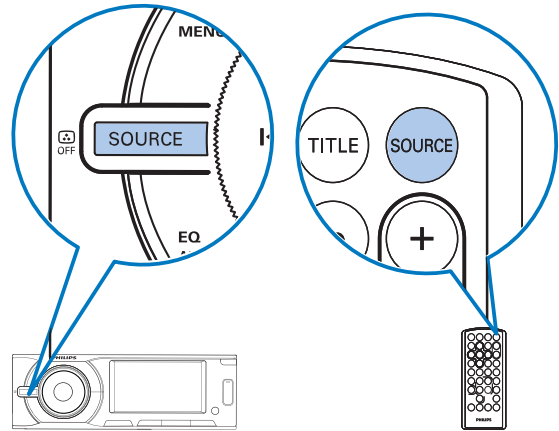

- 2 Press and hold **▲** or **▼** to select band.
↳ **[FM-1]**, **[FM-2]**, **[FM-3]**, **[FM]**, **[MW-1]**, or **[MW-2]** is display.

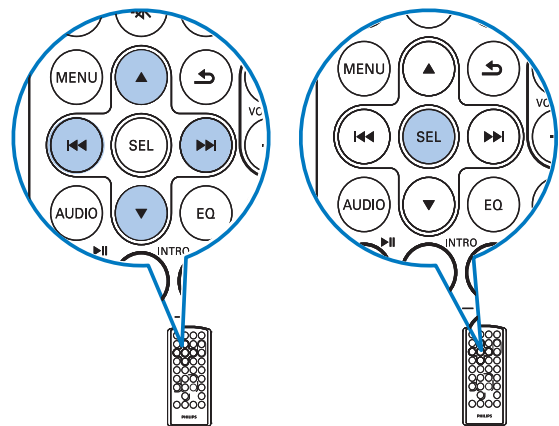

- Press **◀◀** or **▶▶** to tune to a radio station manually.



Auto tune to a radio station

In [RADIO] mode, press and hold **◀◀** or **▶▶** for 3 seconds.

Store stations manually

You can store up to 6 stations in each band.

- Tune to the station which you want to store.
- Press and hold the numeric buttons (1 to 6) for 3 seconds.

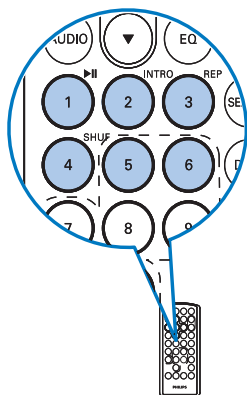

Store stations automatically

You can store up to 6 stations in each band.

- Press **SEARCH** on the remote control or press and hold **AS** on the unit.
 - ↳ The six strongest stations of the selected band are saved in preset channels 1-6 automatically.

Select the preset station

- Press and hold **▲** or **▼** to select band.
 - ↳ [FM-1], [FM-2], [FM-3], [FM], [MW-1], or [MW-2] is display.
- Press the numeric button (1 to 6) to select the preset station.



Select stereo or mono broadcasting

- Press **MENU**.
 - ↳ The main menu is displayed.

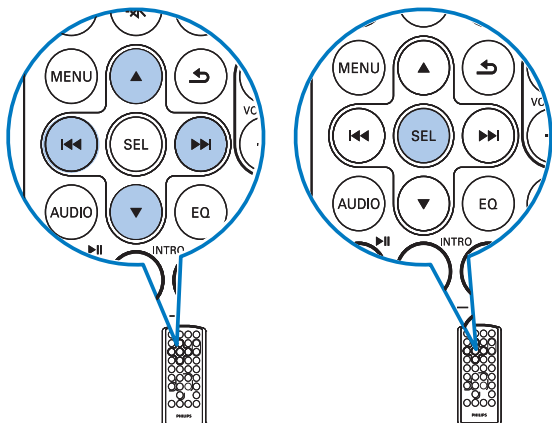

- Press the navigation buttons to select [SETTINGS].
- Press **SEL** on the remote control or **OK/MUTE** on the unit to confirm.



- 4 Press ▲ or ▼ buttons to select the radio setting .
- 5 Press ►► to select [STEREO_MONO].
- 6 Press ►► again to reach the [STEREO_MONO] option list.
- 7 Press ▲ or ▼ to select [STEREO] or [MONO].
- 8 Press SEL on the remote control or ^{OK MUTE}  on the unit to confirm.

5 Play with RDS

The RDS (Radio Data System) function operates only in areas with FM stations broadcasting RDS signals. If you tune to an RDS station, an RDS icon and the station name are displayed.

Activate AF/TA/REG/CT functions

- 1 Press and hold **MENU**.
↳ The setting menu is displayed.
- 2 Press the navigation buttons to select **[Radio] > [LOC_DX] > [DX]**, then press OK/MUTE to select an option.
 - TA (traffic announcement): allows you to receive traffic announcements automatically no matter what source you are listening to.
 - AF (alternate frequency): automatically searches for an alternative frequency for maintaining the same station when the tuner cannot get a good reception.
 - REG (regional radio): sets AF tuning region.
 - CT (clock time): synchronizes the clock of the unit with that on the RDS station.
- 3 Turn OK/MUTE to select **[ON]**, then press OK/MUTE to confirm.

Search for an RDS station by PTY information

The PTY (program type) function lets you find similar programming by genre, and the radio starts searching for stations broadcasting in the selected category.

- 1 Press AS in radio mode.
↳ The PTY menu is displayed.
- 2 Turn OK/MUTE to select a program type, then press OK/MUTE to start searching.
↳ The first radio station will be broadcasted automatically.
↳ **NO PTY** is flashed if no station is searched.
- 3 Repeat Step 1 and 2 to search for next available station.
- 4 Select a channel.

RDS program types

Item	Program type	Description
1	NEWS	News services
2	AFFAIRS	Politics and current affairs
3	INFO	Special information programs
4	SPORT	Sports
5	EDUCATE	Education and advanced training
6	DRAMA	Radio plays and literature

7	CULTURE	Culture, religion and society
8	SCIENCE	Science
9	VARIED	Entertainment programs
10	POP M	Pop music
11	ROCK M	Rock music
12	MOR M	Light music
13	LIGHT M	Light classical music
14	CLASSICS	Classical music
15	OTHER M	Special music programs
16	WEATHER	Weather
17	FINANCE	Finance
18	CHILDREN	Children's programs
19	SOCIAL	Social Affairs
20	RELIGION	Religion
21	PHONE IN	Phone In
22	TRAVEL	Travel
23	LEISURE	Leisure
24	JAZZ	Jazz Music
25	COUNTRY	Country Music
26	NATION M	National Music
27	OLDIES	Oldies Music
28	FOLK M	Folk Music
29	DOCUMENT	Documentary
30	TEST	Alarm Test
31	ALARM	Alarm

6 System settings

Within system settings, there are:

- General settings,
- DVD settings,
- Language settings, and
- Radio settings.

Adjust general settings

1 Press MENU.

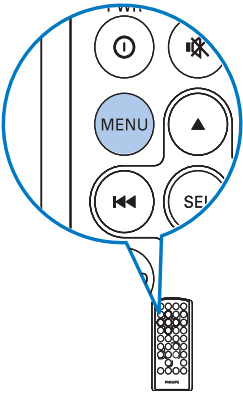

2 Press the navigation buttons to select [SETTINGS], then press ^{OK}MUTE to confirm.

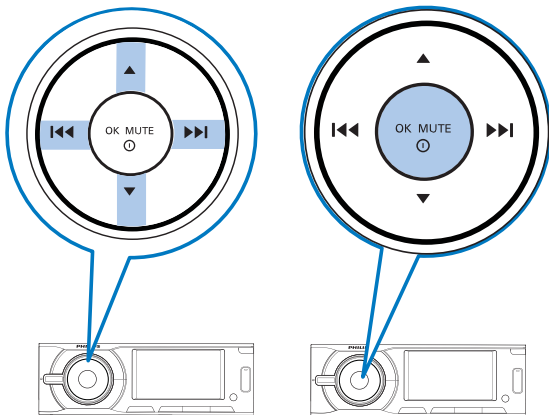

↳ The settings menu is displayed

- 3 Press ▲ or ▼ buttons to select the general setting ⚙.
- 4 Press ►►, and then ▲ or ▼ to select the sub-menu.

Adjust AV-In setting

Note

- AV-In source input is switched off by default to prevent blank screen when AV-In source is not connected. Activate it before using AV-In.

- 1 Press MENU.
- 2 Press the navigation buttons to select [SETTINGS], then press ^{OK}MUTE to confirm.
- 3 Press ▲ or ▼ buttons to select the general setting ⚙.
- 4 Press ►►, and then ▲ or ▼ to select [AV-In].
- 5 Press ▲ or ▼ to select [ON] or [OFF] to activate or deactivate AV-In function.



Select DVD video settings





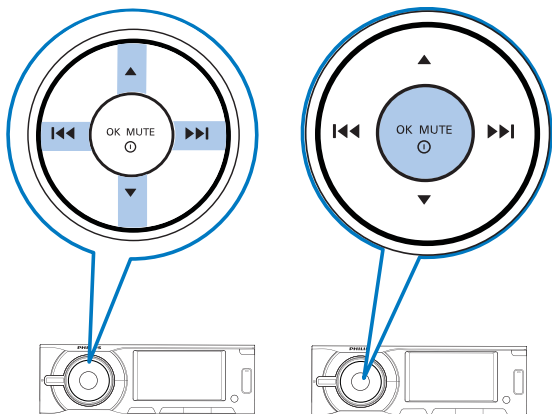

You can adjust the settings for the video output and the screen display.

- 1 Press MENU.

- 2 Press the navigation buttons to select [SETTINGS], then press  to confirm.



↳ The general settings menu is displayed

- 3 Press  or  buttons to select the DVD setting .
- 4 Press , and then  or  button to select the sub-menus.

Select language settings

- 1 Press MENU.
- 2 Press the navigation buttons to select [SETTINGS], then press  to confirm.

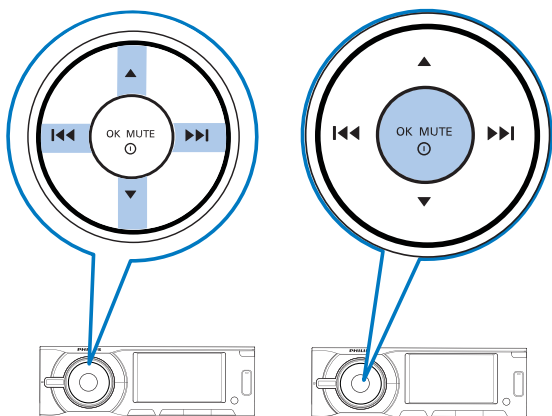

↳ The settings menu is displayed

- 3 Press  or  buttons to select the language setting .



- 4 Press , and then  or  button to adjust.

Adjust radio settings

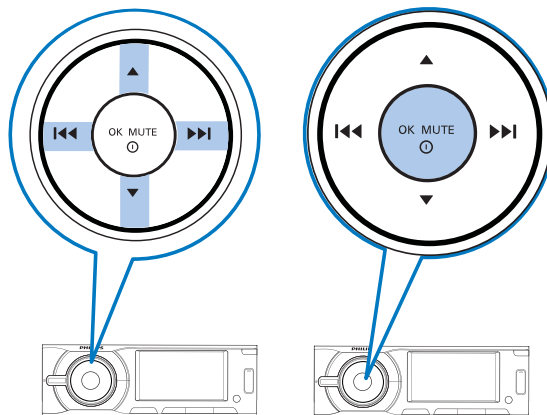
- 1 Press MENU.
- 2 Press the navigation buttons to select [SETTINGS], then press  to confirm.



↳ The settings menu is displayed

- 3 Press  or  buttons to select the radio setting .
- 4 Press , and then  or  button to select [LOC_DX] or [STEREO_MONO].
- 5 Press , and then  or  button to select your preferred settings.

7 Other settings

Select equalizer settings

You can select preset equalizer settings, and they are:

- [USER]
- [TECHNO]
- [ROCK]
- [CLASSIC]
- [JAZZ]
- [OPTIMAL]
- [FLAT]
- [POP]

Note

- Only when you select [USER], then you can adjust the sound value of [BASS] and [TREBLE] .

1 Press EQ/AUDIO.

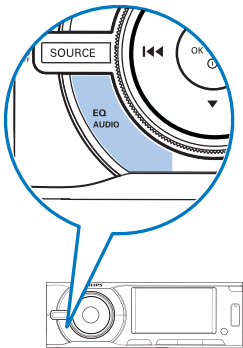

↳ The current equalizer setting is displayed.

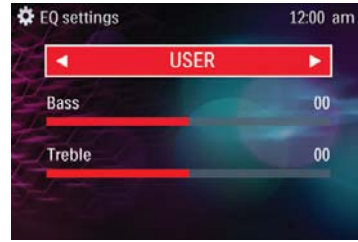

2 Press ◀◀ or ▶▶ to select one of the preset equalizer settings.

3 You can also select [USER], and then press  to confirm.

4 Then, press ▲ or ▼ to select of [BASS] and [TREBLE].

5 Press ◀◀ or ▶▶ to adjust the values.

6 Press  to exit.

Control zone settings

1 Press ZONE.

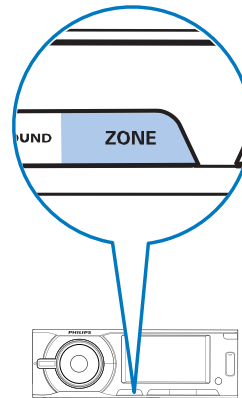

↳ The current zone setting is displayed.

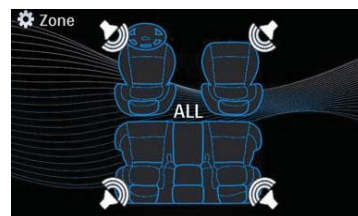

2 Then, you can select one of the following methods to preset zone settings.

- Press **◀◀** or **▶▶**;
- Turn the control knob; or
- Press **ZONE** continuously.

Here are the options of zone setting:

- **[ALL]** - all speakers are in same volume level.
- **[LEFT]** - front left speaker is louder than the rest of the speakers.
- **[RIGHT]** - front right speaker is louder than the rest of the speakers.
- **[FRONT]** - the front speakers are louder than the rear speakers.

Other sound settings

You can adjust the front and rear speaker balance, and the left and right speaker balance.

1 Press and hold **EQ/AUDIO** for 3 seconds.

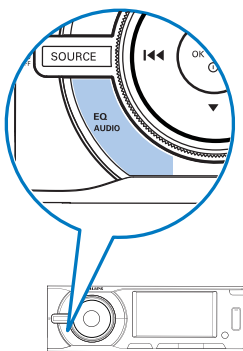

↳ The following options are displayed.

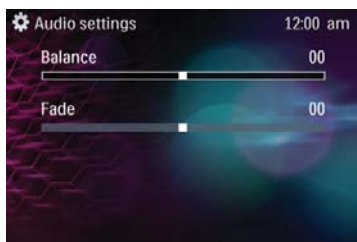

2 Press **▲** or **▼** to select the audio settings to be adjusted.

- **[BALANCE]**: 7L to 7R (L= left speaker ; R= right speaker)
- **[FADE]**: 7R to 7F (R= rear speaker ; F= front speaker)

3 Press **◀◀** or **▶▶** to change the value, and then press **OK MUTE** to confirm.

- You can also turn the control knob to select a value.

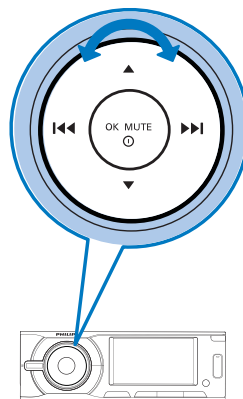

4 Press **↵** to exit.

Select Video Output format

The default video output format is based on the format that is broadcast in your country. If the picture is distorted, change the video output.

Simply press the **P/N** button repeatedly to select the correct video output format.

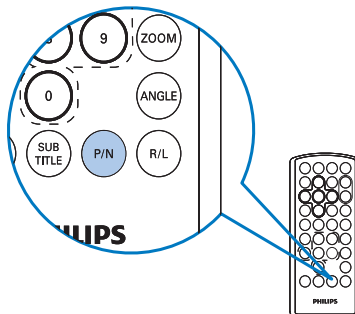

Turn on or off the screen backlight

To turn on or off the screen backlight of the system, press and hold **SOURCE**.

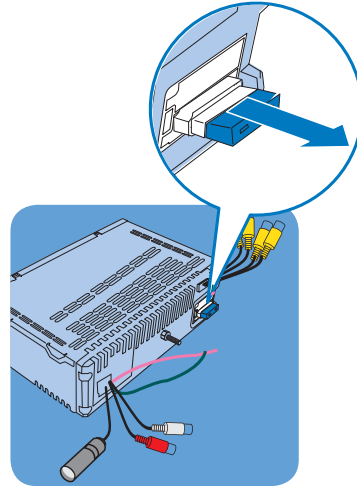

Reset

To reset the car audio system to its default setting:

- 1 Detach the front panel.
- 2 Press **RESET** by using a ball-point pen or similar tool.
↳ All settings are erased except clock.

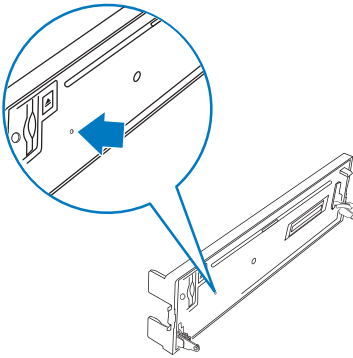

Replace fuse

If the system does not power on, the fuse may be damaged and need replacement.

- 1 Detach the front panel and take out the system.
- 2 Check the electric connection.
- 3 Buy a new fuse that matches the voltage of the damaged fuse (15A).
- 4 Replace the fuse.

8 Product information

Note

- Product information is subject to change without prior notice.

General

Power supply	12V DC (11V - 16V), negative ground
Fuse	15A
Suitable speaker impedance	4-8 Ω
Continuous power output	18W x 4 channels
Line output voltage	2.0V
Aux-in level	500mV
Dimensions (W x H x D)	188 x 58 x 194 mm
Weight	1.7kg

Disc player

System	DVD / CD audio / MP3 system
Frequency response	20Hz - 20k Hz
Signal / noise ratio	> 75dB
Total harmonic distortion	Less than 1%
Channel separation	> 55dB
Video signal format	NTSC / PAL / AUTO
Video output	1.0V

Tuner

Frequency range - FM	87.5 - 107.9 MHz (50kHz)
Frequency range - AM (MW)	522 - 1620 kHz (9kHz)
Usable sensitivity - FM	8 uV
Usable sensitivity - AM (MW)	30 uV

LCD

Screen size	3 inches (16:9)
Display resolution	960 x 240 dots
Contrast ratio	300
Brightness	250 cd/m ²

Compatible USB devices

- USB flash memory (USB 2.0 Full speed or USB1.1 Full speed)
- USB flash player (USB2.0 Full speed or USB1.1 Full speed)
- Memory cards (SD / SDHC)

Supported formats

Supported file/ folder formats	<ul style="list-style-type: none">• USB or memory file format: FAT16, FAT32• Directory nesting up to a maximum of 8 levels• Number of albums / folders: maximum 99• Number of tracks / titles: maximum 999
--------------------------------	---

Supported audio formats	<ul style="list-style-type: none"> • MP3 bit rate (data rate): 32 - 320 Kbps and variable bit rate • WMA v9 or earlier • ID3 tag v1.0, 1.1, 2.2, v2.3, and v2.4
-------------------------	--

Supported video formats	<ul style="list-style-type: none"> • DVD region: Region 3 (for model CED229/98) • MPEG1 (*.avi, *.mpg, *.dat) • MPEG4 (simple profile) (*.avi) • XVID (*.avi)
-------------------------	---

 Note

- For smooth playback, the image size should not be higher than 640X480, frame rate should not be higher than 20 fps and data rate should not be higher than 500kbps in the encoded video.

Unsupported formats

Unsupported file/folder formats	<ul style="list-style-type: none"> • ISO9660, Joliet • Unsupported file formats are skipped. For example, Word documents (.doc) or MP3 files with extension .dlf are ignored and not played.
---------------------------------	--

Unsupported audio formats	<ul style="list-style-type: none"> • AAC, WAV, and PCM audio files. • DRM protected WMA files (.wav, .m4a, .m4p, .mp4, .aac) • WMA files in Lossless format
---------------------------	--

Unsupported video formats	<ul style="list-style-type: none"> • DIVX4 (*.avi) • DIVX5 (*.avi) • M-JPEG (*.avi, *.mov) • MPEG4 (*.mov, *.wmv, *.mp4, *.3g2, *.asf, *.3gp) • H.263 (*.avi, *.mov, *.flv, *.3gp) • H.264 (*.mp4, *.mov) • WMV3 (*.wmv, *.avi) • WMV2 (*.wmv) • RealVideo4 (*.rmvb, *.rm) • RealVideo3 (*.rm) • RealVideo2 (*.ram) • MSVideo (*.avi)
---------------------------	---

 Note

- Not all unsupported formats are listed above. There is no guarantee that your files are playable even though they are not on this list.

9 Troubleshooting

Caution

- Never remove the casing of this apparatus.

To keep the warranty valid, never try to repair the system yourself.

If you encounter problems when using this system, check the following points before requesting service. If the problem remains unsolved, go to the Philips web site (www.philips.com/support). When you contact Philips, make sure that your system is nearby and the model number and serial number are available.

No power

- Car engine has not been started. Start the car engine.
- Connections is incorrect.
- Fuse has been damaged. Replace fuse.

No sound

- Volume is too low. Adjust volume.
- Speaker connections is incorrect.

No response to the remote control

- Ensure that the path between the remote control and the unit is clear from obstacles.
- From a close distance, point the remote control directly at the unit.
- Replace the remote control battery.
- The function does not work. Refer to the instructions.

Disc does not play

- Disc is upside down. Ensure the printed side is upwards.
- Disc is dirty. Clean the disc with a clean, soft, lint-free cloth. Wipe the disc outwards from the center.
- Disc is defective. Try another disc.
- Incompatible disc is used. Try another disc.
- Disc rating exceeds the restrict setting. Change the rating settings to lower one.

- Disc region code is not compatible with the unit. Use disc with proper region code.

Disc is blocked in the disc compartment

- Press and hold ▲ until the disc comes out.

No image

- Parking brake wire connection is incorrect. Check the parking wiring.

Image flashes or distorted

- Video DVD settings do not match with the DVD. Adjust video DVD settings.
- Video connection is improper. Check the connections.

Noise in broadcasts.

- Signals are too weak. Select other stations with stronger signals.
- Check the connection of the car antenna.
- Change broadcast from stereo to mono.

Preset stations lost.

- Battery cable is not connected correctly. Connect the battery cable to the terminal that is always live.

Fuse is broken

- The Fuse type is incorrect. Replace it with a 15A fuse.
- Speaker wire or power wire is grounded. Check the connections.

Display show ERR-12

- USB/SD/SDHC data error. Check the USB device or SD/SDHC card.

10 Notice



Specifications are subject to change without notice. Trademarks are the property of Koninklijke Philips Electronics N.V. or their respective owners. Philips reserves the right to change products at any time without being obliged to adjust earlier supplies accordingly.

The making of unauthorized copies of copy-protected material, including computer programs, files, broadcasts and sound recordings, may be an infringement of copyrights and constitute a criminal offence. This equipment should not be used for such purposes.



Manufactured under license from Dolby Laboratories.

"Dolby" and the double-D symbol are trademarks of Dolby Laboratories.

Other trademarks and trade names are those of their respective owners.

Environmental information

All unnecessary packaging has been omitted. We have tried to make the packaging easy to separate into three materials: cardboard (box), polystyrene foam (buffer) and polyethylene (bags, protective foam sheet.)

Your system consists of materials which can be recycled and reused if disassembled by a specialized company. Please observe the local regulations regarding the disposal of packaging materials, exhausted batteries and old equipment.

Any changes or modifications made to this device that are not expressly approved by Philips Consumer Lifestyle may void the user's authority to operate the equipment.

2010 © Koninklijke Philips Electronics N.V. All rights reserved.

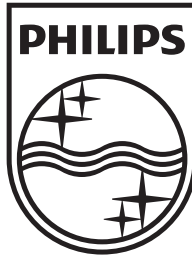

Specifications are subject to change without notice
© 2011 Koninklijke Philips Electronics N.V.
All rights reserved.

CED229_UM_98_V1.2

