

隨時隨地給您提供協助

在以下位置註冊產品及獲取支援：
www.philips.com/welcome

CED230



User manual

3

使用手冊

27

PHILIPS

Contents

1 Important	4
Notice	4
2 Your car audio system	6
Introduction	6
What's in the box	6
Overview of the main unit	7
Overview of the remote control	8
Install the car audio	9
Install remote control battery	12
3 Get started	13
Turn on and turn off	13
Adjust volume	13
Mute	13
Set clock	13
4 Play	14
Load and eject discs	14
Insert and remove USB device	15
Select Language	15
Select audio language	15
Skip/search	15
Intro play	16
Repeat play	16
Random play	16
Zoom	16
5 Radio	17
Manual tune to a radio station	17
Auto tune to a radio station	17
Store stations manually	17
Store stations automatically	17
Select the preset station	17
Play with RDS	17
6 Adjust sound	19
Dynamic Bass Boost	19
MAX sound	19
Select equalizer settings	19
Select listening zone	20
Other sound settings	20
7 System settings	21
Adjust general settings	21
Select video settings	21
Select language settings	22
Adjust tuner settings	22
8 Other settings	23
Turn on or off the screen backlight	23
Select Video Output format	23
Listen to other devices	23
Set rear view camera	23
Reset	23
Replace fuse	24
9 Product information	24
General	24
Disc player	24
Tuner	25
LCD	25
Compatible USB devices	25
Supported formats	25
Unsupported formats	25
10 Troubleshooting	26

1 Important

- Read and understand all instructions before you use the apparatus. If damage is caused by failure to follow instructions, the warranty does not apply.
- Use of controls or adjustments or performance of procedures other than herein may result in hazardous radiation exposure or other unsafe operation.
- This unit is designed for negative ground (earth) 12V DC operation only.
- To reduce the risk of traffic accident, do not watch video during driving.
- To ensure safe driving, adjust the volume to a safe and comfortable level.
- Improper fuses can cause damage or fire. When you need to change the fuse, consult a professional.
- Use only the supplied mounting hardware for a safe and secure installation.
- To avoid short circuit, do not expose the apparatus, remote control or remote control batteries to rain or water.
- Never insert objects into the ventilation slots or other openings on the apparatus.
- Never place any objects other than discs into the disc tray/slot.
- Visible and invisible laser radiation when open. Avoid exposure to beam.
- Risk of damage to the screen! Never touch, push, rub or strike the screen with any object.
- Never use solvents such as benzene, thinner, cleaners available commercially, or anti-static sprays intended for discs.
- Clean the apparatus with soft, damp cloth. Never use substances such as alcohol, chemicals or household cleaners on the apparatus.

- The product/remote control may contain a coin/button type battery, which can be swallowed. Keep the battery out of reach of children at all times! If swallowed, the battery can cause serious injury or death. Severe internal burns can occur within two hours of ingestion.
- If you suspect that a battery has been swallowed or placed inside any part of the body, seek immediate medical attention.
- When you change the batteries, always keep all new and used batteries out of reach of children. Ensure that the battery compartment is completely secure after you replace the battery.
- If the battery compartment cannot be completely secured, discontinue use of the product. Keep out of reach of children and contact the manufacturer.

Notice



Be responsible
Respect copyrights

The making of unauthorized copies of copy-protected material, including computer programs, files, broadcasts and sound recordings, may be an infringement of copyrights and constitute a criminal offence. This equipment should not be used for such purposes.

DIVX™

ABOUT DIVX VIDEO: DivX® is a digital video format created by DivX, LLC, a subsidiary of Rovi Corporation. This is an official DivX Certified® device that plays DivX video. Visit divx.com for more information and software tools to convert your files into DivX videos.

ABOUT DIVX VIDEO-ON-DEMAND: This DivX Certified® device must be registered in order to play purchased DivX Video-on-Demand (VOD) movies. To obtain your registration code, locate the DivX VOD section in your device setup menu. Go to vod.divx.com for more information on how to complete your registration.

DivX®, DivX Certified® and associated logos are trademarks of Rovi Corporation or its subsidiaries and are used under license.



Manufactured under license from Dolby Laboratories.

"Dolby" and the double-D symbol are trademarks of Dolby Laboratories.

Other trademarks and trade names are those of their respective owners.

This apparatus includes this label:



Environmental information

All unnecessary packaging has been omitted. We have tried to make the packaging easy to separate into three materials: cardboard (box), polystyrene foam (buffer) and polyethylene (bags, protective foam sheet.)

Your system consists of materials which can be recycled and reused if disassembled by a specialized company. Please observe the local regulations regarding the disposal of packaging materials, exhausted batteries and old equipment.

Disposal of your old product and batteries

Your product is designed and manufactured with high quality materials and components, which can be recycled and reused.

Never dispose of your product with other household waste. Please inform yourself about the local rules on the separate collection of electrical and electronic products and batteries. The correct disposal of these products helps prevent potentially negative consequences on the environment and human health.

Your product contains batteries, which cannot be disposed of with normal household waste. Please inform yourself about the local rules on separate collection of batteries. The correct disposal of batteries helps prevent potentially negative consequences on the environment and human health.

Please visit www.recycle.philips.com for additional information on a recycling center in your area.

Any changes or modifications made to this device that are not expressly approved by Philips Consumer Lifestyle may void the user's authority to operate the equipment.

2013 © Koninklijke Philips Electronics N.V. Specifications are subject to change without notice. Trademarks are the property of Koninklijke Philips Electronics N.V or their respective owners. Philips reserves the right to change products at any time without being obliged to adjust earlier supplies accordingly.

2 Your car audio system

Congratulations on your purchase, and welcome to Philips!

To fully benefit from the support that Philips offers, register your product at www.Philips.com/welcome.

Read this user manual carefully before you install and use the unit. Save it for future reference.

Always follow the instructions in this chapter in sequence.

If you contact Philips, you will be asked for the model and serial number of your apparatus. The model number and serial number are on the bottom of your apparatus. Write the numbers here:

Model No. _____

Serial No. _____

Introduction

With the in-car audio system, you can enjoy your drive while you listen to:

- FM or AM (MW) radio
- Audio from USB drive or external devices.
- Music CDs
- DVD and VCD video

What's in the box

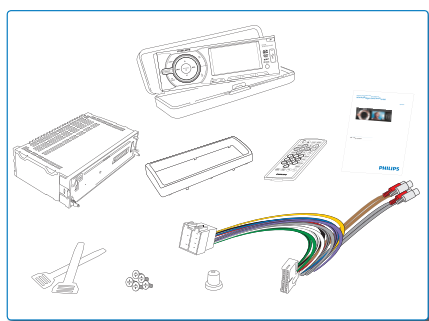



Caution

- Use the controls only as stated in this user manual.

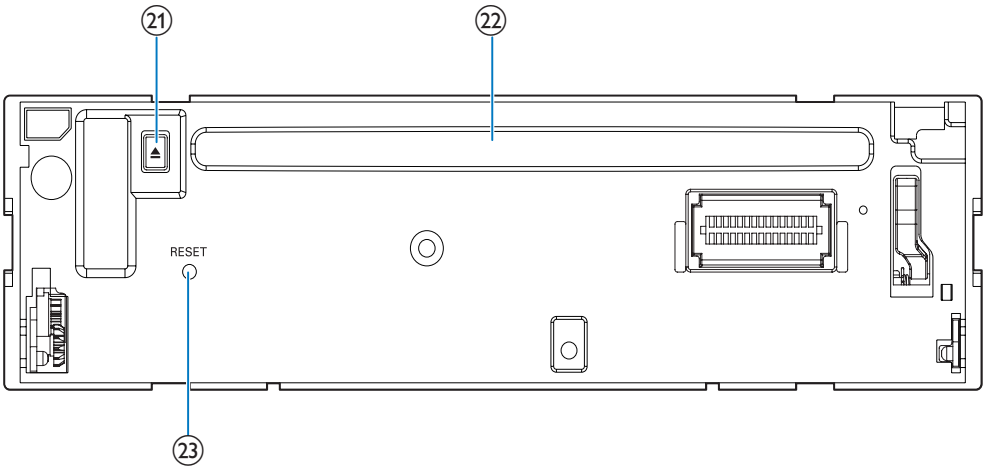
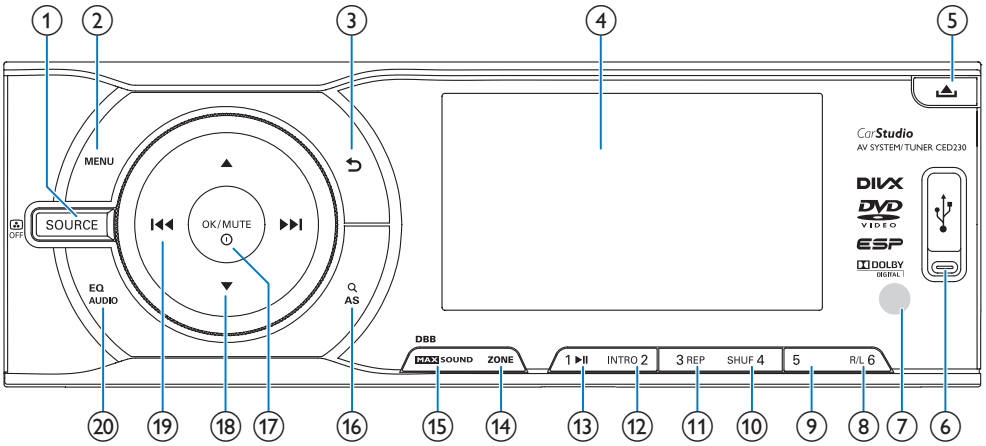
Overview of the main unit



- ① **SOURCE**
 - Select source.
- ② **MENU**
 - Access the system menu.
- ③ **↶**
 - Return to previous menu.
- ④ **Screen**
- ⑤ **🔒**
 - Unlock the front panel.
- ⑥ **USB socket**
- ⑦ **Remote control sensor**
- ⑧ **R/L, 6**
 - Select preset station no. 6.
 - Select audio channel.

- ⑨ **5, ■**
 - Select preset station no. 5
 - Stop playback.
- ⑩ **SHUF, 4**
 - Turn random play on or off.
 - Select preset station no. 4
- ⑪ **3, REP**
 - Select repeat play mode.
 - Select preset station no. 3
- ⑫ **INTRO, 2**
 - Turn scan play on or off.
 - Select preset station no. 2
- ⑬ **1, ►||**
 - Start play.
 - Pause or resume play.
 - Select preset station no. 1
- ⑭ **ZONE**
 - Select listening zone.
- ⑮ **DBB,  SOUND,**
 - Turn on or off Dynamic Bass Boost (DBB) sound and maximum volume.
- ⑯ **Q, AS**
 - Zoom in/out.
 - Store radio station automatically.
- ⑰ **OK/MUTE **
 - Turn the unit on or off.
 - Turn mute on or off.
 - Adjust volume.
 - Confirm selection.
- ⑱ **▲ / ▼**
 - Select tuner band.
 - Select folder.
- ⑲ **◀◀ / ▶▶**
 - Tune for radio station.
 - Skip/search for track.
- ⑳ **EQ/AUDIO**
 - Select equalizer (EQ) setting.
 - Access audio setting menu.
- ㉑ **Disc slot**

- ㉒ **▲**
 - Eject disc.
- ㉓ **RESET**
 - Restore default settings.

Overview of the remote control

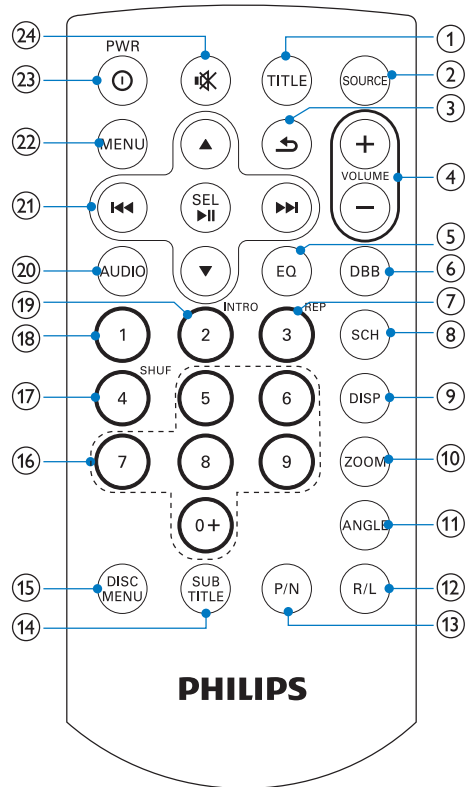

- ① **TITLE**
 - Access or exit DVD title menu.
- ② **SOURCE**
 - Select connected device.
- ③ **↶**
 - Return to previous menu.
 - Disable screen saver.

- ④ **VOLUME +/-**
 - Adjust volume.
- ⑤ **EQ**
 - Select equalizer (EQ) setting.
- ⑥ **DBB**
 - Turn on or off Dynamic Bass Boost (DBB) sound.
- ⑦ **3, REP**
 - Select repeat play mode.
 - Select preset station no. 3
- ⑧ **SCH**
 - Store radio station automatically.
- ⑨ **DISP**
 - Display play information.
- ⑩ **ZOOM**
 - Enlarge or reduce picture or active image size.
- ⑪ **ANGLE**
 - Select a difference angle/version of the current DVD scene.
- ⑫ **R/L**
 - Select audio channel.
- ⑬ **P/N**
 - Select video output format.
- ⑭ **SUBTITLE**
 - Select DVD or DivX subtitle language.
- ⑮ **DISC MENU**
 - Return to DVD main menu.
- ⑯ **5/6/7/8/9/0+**
 - Select track or preset radio station.
- ⑰ **SHUF, 4**
 - Turn random play on or off.
 - Select preset station no. 4.
- ⑱ **1**
 - Select preset station no. 1
- ⑲ **INTRO, 2**
 - Turn intro play on or off.
 - Select preset station no. 2
- ⑳ **AUDIO**
 - Access audio setting menu.
- ㉑ **Navigation buttons**
 - ◀◀ / ▶▶
 - Tune for radio station.
 - Skip/search for track.
 - ▲ / ▼
 - Select tuner band.
 - Select folder.
 - SEL/ ▶▶**
 - Confirm selection.
 - Start play.
 - Pause or resume play.
- ㉒ **MENU**
 - Access system menu.
- ㉓ **⓪ PWR**
 - Turn the unit on or off.
- ㉔ **🔇**
 - Mute or unmute audio.

Install the car audio

These instructions are for a typical installation. However, if your car has different requirements, make the corresponding adjustment. If you have any questions regarding installation kits, consult your Philips car audio dealer.



Caution

- This unit is designed for negative ground (earth) 12V DC operation only.
- Always install this unit in the car dashboard. Other locations can be dangerous as the rear of the unit heats up during use.
- To avoid short-circuit: before you connect, ensure that the ignition is off.
- Ensure that you connect the yellow and red power supply leads after all other leads are connected.
- Ensure that all loose leads are insulated with electrical tape.
- Ensure that the leads do not get caught under screws or in parts that will move (e.g. seat rail).
- Ensure that all ground (earth) leads are run to a common ground (earth) point.
- Use only the supplied mounting hardware for a safe and secure installation.
- Improper fuses can cause damage or fire. When you need to change the fuse, consult a professional.

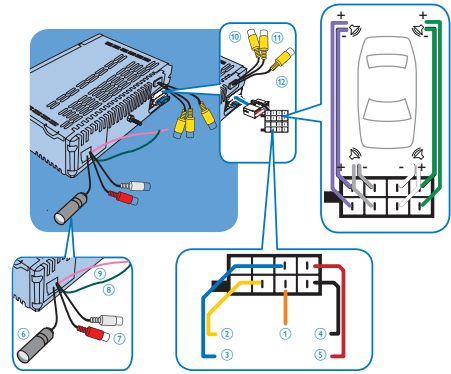

OR

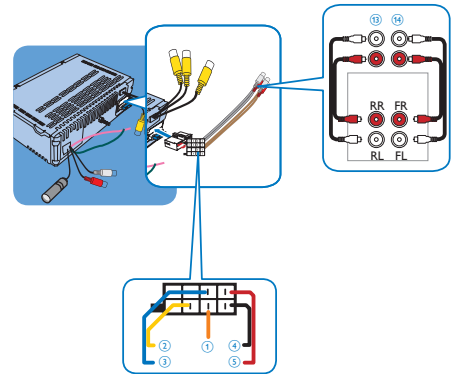

Note on the power supply lead (yellow)

- When you connect other devices to this apparatus, ensure that the rating of the car circuit is higher than the total fuse value of all the connected devices.

Notes on speaker connection

- Never connect speaker wires to the metal body or chassis of the car.
- Never connect speaker wires with stripes to one another.

Connect



Caution

- Make sure that all bare wires are insulated with electrical tape.



Note

- As different cars have different requirements, you might need to connect the device differently from the user manual's instructions. In that case, consult a professional mechanic to connect.

- 1 Illumination switch
- 2 To the +12V car battery which is energized at all time
- 3 Motor/electric antenna relay control lead/
Amplifier relay control lead
- 4 Ground
- 5 Ignition Key +12V DC when ON/ACC
- 6 Antenna
- 7 Aux-In
- 8 Parking Switch Cable
- 9 Reverse Driving Cable
- 10 Video-In

- 11 Camera-In
- 12 Video-Out
- 13 Rear line-Out
- 14 Front line-Out

Connect parking brake cable and reverse driving cable to a rear view backup camera

Note

- Check your local driving regulations on whether it is legally required to install the rear view backup camera. These connections require a professional mechanic to install.

This car audio video system allows you to connect to the rear view backup camera. You can view the things that happens behind your car in the display, especially you are driving a big vehicle. This helps protecting your bumper and anything it might contact.

Mount into dashboard

Note

- For proper operation of the DVD player, the chassis must be mounted within 20 degree horizontal. Ensure that the unit is mounted within this limitation.

Caution

- Keep the connection of the car battery if there is an on-board drive or navigation computer: Otherwise, the computer may lost its memory.
- To avoid short circuit, ensure the bare wires do not touch each other and disconnect the negative terminal of the car battery.

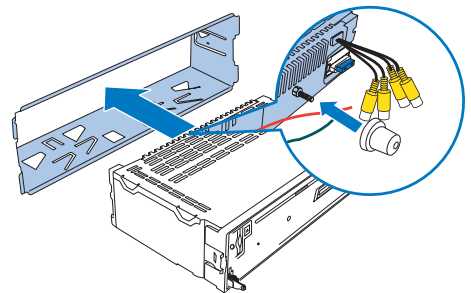
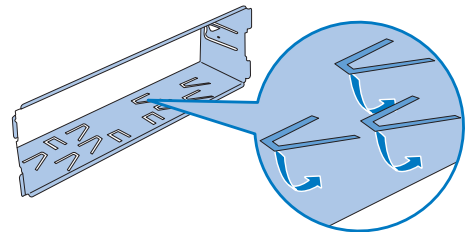
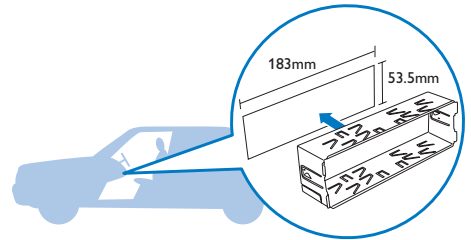
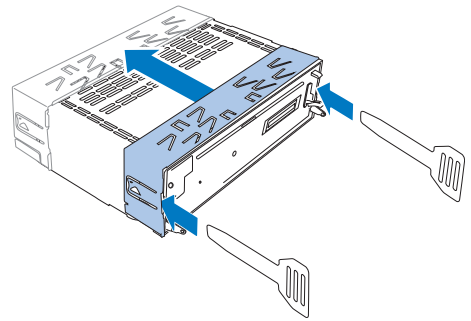

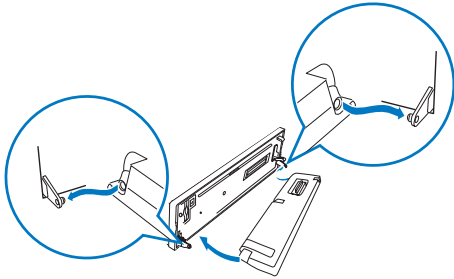
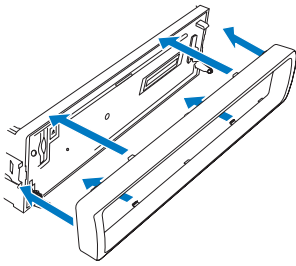

25 Reconnect the negative terminal of the car battery.

To replace the remote control battery

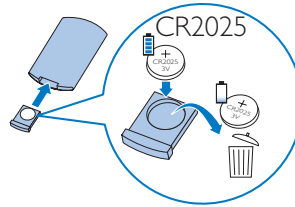
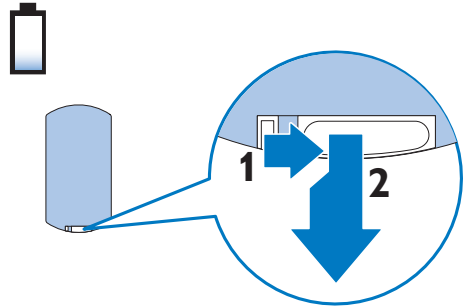

Install remote control battery



Caution

- Risk of explosion! Keep batteries away from heat, sunshine or fire. Never discard batteries in fire.
- Risk of decreased battery life! Never mix different brands or types of batteries.
- Risk of product damage! When the remote control is not used for long periods, remove the batteries.
- Perchlorate Material - special handling may apply; See www.dtsc.ca.gov/hazardouswaste/perchlorate.

For first time use

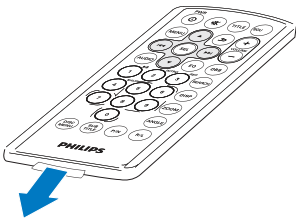

3 Get started

Turn on and turn off

Turn On

Press the power button ().

Turn Off

Press and hold the same power button for 3 seconds.

Adjust volume

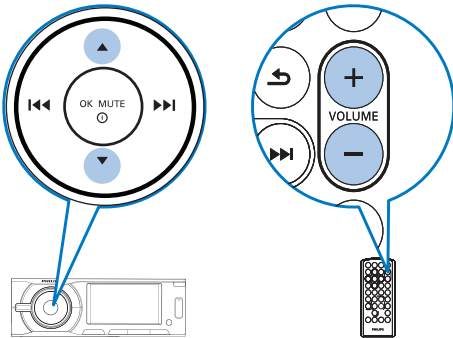

Mute

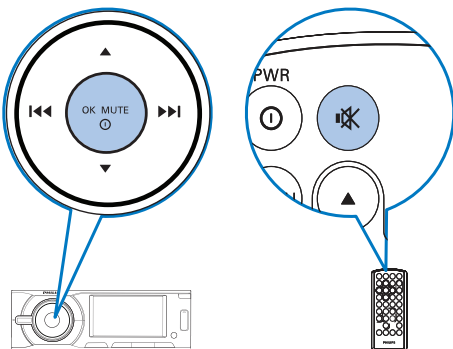

Set clock

- 1 Press **MENU**.
- 2 Press the navigation buttons to select **[SETTINGS]**, then press **SEL** on the remote control.
- 3 Select **[System]**, then press **▶▶**.
- 4 Select **[Time mode]**, then press **▶▶**.
↳ The time mode options are displayed:
 - **[12 hour mode]**
 - **[24 hour mode]**
- 5 Select a mode, then press **SEL**.
- 6 Press **◀◀** to return to previous menu and select **[Time adjust]**, then press **▶▶**.
- 7 Press **▲** or **▼** to enter clock, then press **SEL**.

4 Play

Make sure that the disc or device contains playable music or video.

Note

- For CDs recorded in multiple sessions, only the first session is played.
- Does not support MP3 Pro audio format.
- It may not support and display special characters track name (ID3) or album name properly.
- It cannot play some WMA is protected by Digital Rights Management (DRM).
- The system does not display or play the folders or files that exceed the supporting limit.

Warning

- To reduce the risk of traffic accident, do not watch video during driving.

Load and eject discs

Warning

- To reduce the risk of traffic accident, do no watch video during driving.

You can play video, audio or images stored on the following discs:

- DVD video, DVD-R, DVD-RW
- VCD
- Audio CD, CD with JPEG files, CD-R, CD-RW

Note

- Ensure that the disc contains playable content.

You can play DVD discs with the following region codes:

DVD region code	Countries
-----------------	-----------



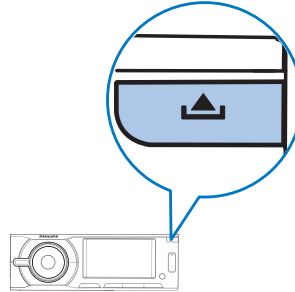

Asia Pacific, Taiwan, Korea

1 Press  to open the front panel.



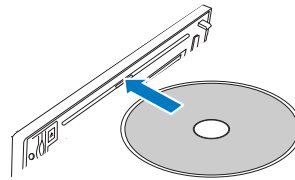





2 Insert the disc into the disc slot with label side facing up.
↳ Play resumes from the point where it was last stopped.



3 To remove the disc, press the  button.
↳ When the disc is ejected, the unit switches to TUNER mode automatically.

4 Close the front panel.
↳ After a few seconds, the screen illuminates.

- For video discs, press  or  to select an item, then press  to start playing.
- For discs that contain MP3s, WMAs, or JPEGs, press  or  to select a folder, track or picture. Press  to start playing.

Tip

- If the disc is blocked in the disc compartment, press and hold the **▲** button until the disc comes out.

Insert and remove USB device

- 1 Slide down the USB socket cover.

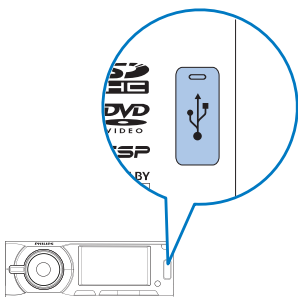

- 2 Insert the USB device into the USB socket.
↳ The unit starts playing from the USB device automatically.
- 3 To remove the USB device, press **OK/MUTE** to turn off the unit.
- 4 Remove the USB device.

Select Language

You can select the subtitle language if the DVD or DivX discs contain two or more subtitle languages.

During play, press **SUBTITLE** on the remote control repeatedly until the language is selected.

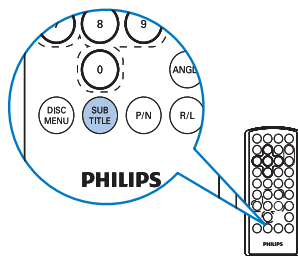

Select audio language

You can select the audio language if the video discs contain two or more audio channels.

During play, press **R/L** on the remote control repeatedly until the language is selected.

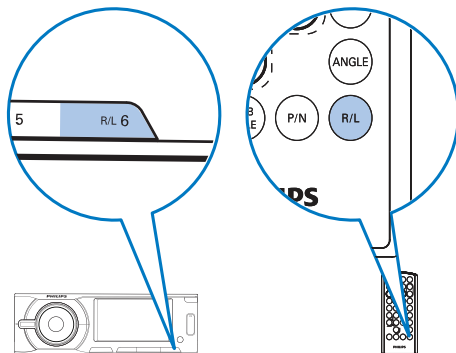

Skip/search

During video and audio disc play

- To skip to a specified chapter or track, press the numeric buttons.
- To skip to the previous or next chapter or track, press **◀◀** or **▶▶**.



- To search backward or forward quickly, press **⏮** or **⏭** for 3 seconds.
- Press **[O]** to resume normal play.

During MP3/WMA play

- To select a track, press **▲** or **▼** to select a folder. Press **⏮** or **⏭** to skip to previous or next track.

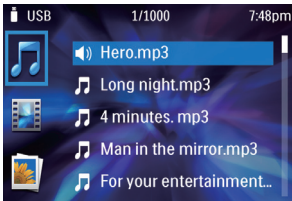

- To skip to a specified chapter or track, press the numeric buttons.

Intro play

This feature plays the first 10 seconds of each audio track.

Press the **INTRO 2** button to select **[INTRO ON]** or **[INTRO OFF]**.

Repeat play

There are 3 standard modes of repeat play for video, audio, and MP3/WMA.

Press the **3 REP** button repeatedly to select.

- **[RPT 1]**: play the current chapter or track repeatedly.
- **[RPT DIR]**: play the current folder repeatedly.

- **[RPT ALL]**: play all chapters in the title or all tracks repeatedly.
- **[RPT OFF]**: cancel repeat play.

Random play

There are 3 standard modes of random play for audio and MP3/WMA.

Press the **SHUF 4** button repeatedly to select.

- **[SHUFFLE ALL]**: start random play for all tracks.
- **[SHUFFLE DIR]**: start random play in current folder.
- **[SHUFFLE OFF]**: cancel random play.

Zoom

To zoom in and out of video images and pictures:

- 1 Press **ZOOM** on the remote control repeatedly.
↳ **[ZOOM]** is displayed.

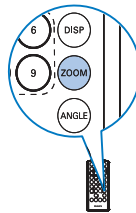

- 2 Press the navigation buttons to pan across the display.

5 Radio

Manual tune to a radio station

- 1 Press **MENU**.
- 2 Press the navigation buttons to select **[RADIO]**, then press **ON MUTE**.
- 3 Press and hold **▲** or **▼** to select band.
↳ **[FM]** or **[AM]** is display.
- 4 Press **◀◀** or **▶▶** to tune to a radio station manually.



Auto tune to a radio station

In **[RADIO]** mode, press and hold **◀◀** or **▶▶** for 3 seconds.

Store stations manually

You can store up to 6 stations in each band.

- 1 Tune to the station which you want to store.
- 2 Press and hold the numeric buttons (1 to 6) for 3 seconds.

Store stations automatically

You can store up to 6 stations in each band.

- 1 Press **SEARCH**.

↳ The six strongest stations of the selected band are saved in preset channels 1-6 automatically.

Select the preset station

- 1 Press **▲** or **▼** to select band.
↳ **[FM]** or **[AM]** is display.
- 2 Press the numeric button (1 to 6) to select the preset station.

Play with RDS

The RDS (Radio Data System) function operates only in areas with FM stations broadcasting RDS signals. If you tune to an RDS station, an RDS icon and the station name are displayed.

Search for an RDS station by PTY information

The PTY (program type) function lets you find similar programming by genre, and the radio starts searching for stations broadcasting in the selected category.

- 1 Press and hold **SEARCH**.
↳ The PTY menu is displayed.
- 2 Turn **⊖** to select a program type, then press **⊖** to start searching.
- 3 Select a channel.

RDS program types

Item	Program type	Description
1	NEWS	News services
2	AFFAIRS	Politics and current affairs
3	INFO	Special information programs
4	SPORT	Sports

5	EDUCATE	Education and advanced training
6	DRAMA	Radio plays and literature
7	CULTURE	Culture, religion and society
8	SCIENCE	Science
9	VARIED	Entertainment programs
10	POP M	Pop music
11	ROCK M	Rock music
12	MOR M	Light music
13	LIGHT M	Light classical music
14	CLASSICS	Classical music
15	OTHER M	Special music programs
16	WEATHER	Weather
17	FINANCE	Finance
18	CHILDREN	Children's programs
19	SOCIAL	Social Affairs
20	RELIGION	Religion
21	PHONE IN	Phone In
22	TRAVEL	Travel
23	LEISURE	Leisure
24	JAZZ	Jazz Music
25	COUNTRY	Country Music
26	NATION M	National Music
27	OLDIES	Oldies Music
28	FOLK M	Folk Music
29	DOCUMENT	Documentary
30	TES	Alarm Test
31	ALARM	Alarm

- AF (alternate frequency): automatically searches for a different station when the tuner cannot get a good reception.
- REG (regional radio): sets AF tuning region.
- CT (clock time): synchronizes the clock of the unit with that on the RDS station.

3 Turn \odot to select **[ON]**, then press \odot to confirm.

Activate AF/TA/REG/CT functions

- 1 Press and hold **MENU**.
↳ The setting menu is displayed.
- 2 Press the navigation buttons to select **[Radio] > [LOC_DX] > [DX]**, then press \odot to select an option.
 - TA (traffic announcement): allows you to receive traffic announcements automatically no matter what source you are listening to.

6 Adjust sound

Dynamic Bass Boost

- 1 Press **MAX SOUND** / **DBB** on the car audio system for 3 seconds or press **DBB** on the remote control.
 - ↳ **[DBB ON]**: The Dynamic Bass Boost (DBB) function is on.
 - ↳ **[DBB OFF]**: The DBB function is off.
- 2 Press **DBB** again to change the DBB setting.

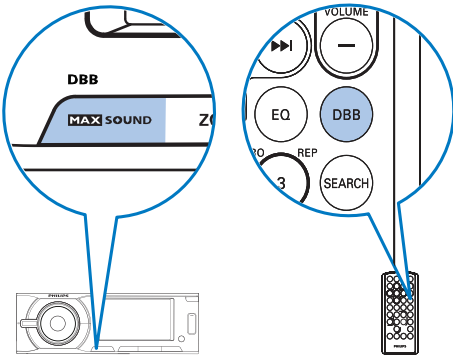

MAX sound

- 1 Press **MAX SOUND** / **DBB** to produce an instant boost in bass and maximize volume.
- 2 Press **MAX SOUND** / **DBB** again to turn off.

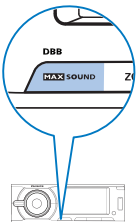

Select equalizer settings

You can select preset equalizer settings, and they are:

- **[USER]**
- **[TECHNO]**
- **[ROCK]**
- **[CLASSIC]**
- **[JAZZ]**
- **[OPTIMAL]**
- **[FLAT]**
- **[POP]**

Note

- Only when you select **[USER]**, then you can adjust the sound value of **[BASS]**, **[MID]**, and **[TREBLE]**.

- 1 Press **EQ/AUDIO**.
 - ↳ The current equalizer setting is displayed.

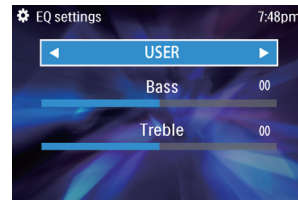

- 2 Press **◀** or **▶** to select one of the preset equalizer settings.
- 3 You can also select **[USER]**, and then press **OK/MUTE** to confirm.
- 4 Then, press **▲** or **▼** to select of **[BASS]**, and **[TREBLE]**.
- 5 Press **◀** or **▶** to adjust the values.
- 6 Press **↵** to exit.

Select listening zone

- 1 Press **ZONE**.
↳ The current zone setting is displayed.



- 2 Press **◀◀** or **▶▶** to select one of the preset zone settings:
 - **[ALL]** - all speakers are in same volume level.
 - **[LEFT]** - front left speaker is louder than the rest of the speakers.
 - **[RIGHT]** - front right speaker is louder than the rest of the speakers.
 - **[FRONT]** - the front speakers are louder than the rear speakers.
- 3 Press **OK/MUTE** to confirm.
- 4 Press **↶** to exit.

- 2 Press **▲** or **▼** to select the audio settings to be adjusted.
 - **[BALANCE]**: 7L to 7R (L= left speaker ; R= right speaker)
 - **[FADE]**: 7R to 7F (R= rear speaker ; F= front speaker)
- 3 Press **◀◀** or **▶▶** to change the value, and then press **OK/MUTE** to confirm.
 - You can also turn the control knob to select a value.
- 4 Press **↶** to exit.

Other sound settings

You can adjust the front and rear speaker balance, and the left and right speaker balance.

- 1 Press **EQ/AUDIO** for 3 seconds.
↳ The following options are displayed.

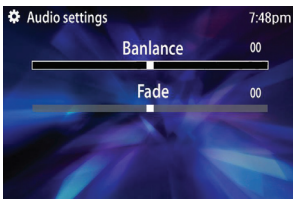

7 System settings

Within system settings, there are:

- General settings,
- DVD settings,
- Language settings, and
- Radio settings.

Adjust general settings

- 1 Press **MENU**.
↳ The main menu is displayed.



- 2 Press the navigation buttons to select **[SETTINGS]**, then press **OK/MUTE** to confirm.
↳ The settings menu is displayed

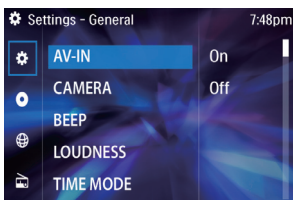

- 3 Press **▲** or **▼** buttons to select the general setting **⚙**.
- 4 Press **▶▶**, then **▲** or **▼** to select the sub-menus, and then press **OK/MUTE** to confirm.

[AV-IN]	[ON]/[OFF]
---------	------------

[CAMERA]	[ON]/[OFF]
----------	------------

[Beep]	[ON]/[OFF]	Turn on or off the beep sound. When it turned on, each time you press a button, the device beeps
--------	------------	--

[LOUDNESS]	[ON]/[OFF]
[TIME MODE]	[12 hour mode]/[24 hour mode]

[TIME ADJUST]	Set clock.
---------------	------------

[PARKING]	[ON]/[OFF]	Disable or enable DVD watching during driving.
-----------	------------	--

[INVERTED CAMERA]	[ON]/[OFF]
-------------------	------------

Select video settings

- 1 Press **MENU**.
- 2 Press the navigation buttons to select **[SETTINGS]**, then press **OK/MUTE** to confirm.
- 3 Press **▲** or **▼** to select the DVD setting **●**.
- 4 Press **▶▶**, and then **▲** or **▼** to highlight an option, then press **OK/MUTE** to confirm.

[TV SYSTEM]	[NTSC]	Used in the United States, Canada, Japan, Mexico, the Philippines, South Korea, Taiwan, and some other countries.
-------------	--------	---

	[PAL]	Used in the United States, Canada, Japan, Mexico, the Philippines, South Korea, Taiwan, and some other countries.
--	-------	---

	[Auto]	The correct format is set automatically. Select this option if you are not sure which format should be selected.
[TV TYPE]	[4:3 PS]	While playing a full-height picture, the sides of the picture may be trimmed.
	[4:3 LB]	While playing a wide-screen picture, black bars may appear on the top and the bottom of the screen.
	[16:9]	For widescreen display.
[Password]	[Last]	Set password to restrict the play of discs. The default password is 0000.
[RATING]	[1 kid safe]	Acceptable for children.
	[2 G]	Acceptable for general viewers.
	[3 PG]	Parental guidance suggested.
	[4 PG 13]	Unsuitable for children under age 13
	[5 PGR]	Recommend parents to restrict children under 17 to view.
	[6 R]	Restricted. Recommend parent to guide children under 17 to view.
	[7 NC 17]	Unsuitable for children under age 17.
	[8 Adult]	Acceptable for adults only.
[DEFAULT]		Restore to default settings.
[BRIGHTNESS]		Adjust the intensity and details of dark areas.

[CONTRAST]		Adjust the intensity of bright areas.
[HUE]		Compensate for color variations.
[SATURATION]		Adjust color saturation.

Select language settings

- 1 Press MENU.
- 2 Press the navigation buttons to select [SETTINGS], the press to confirm.
- 3 Press to select the language setting .
- 4 Press , and then to select a language:
 - [OSD LANGUAGE]
 - [Audio Lang]
 - [Subtitle lang]
 - [Menu lang]
 - [DivX [R] VOD]
- 5 Press to confirm

Adjust turner settings

- 1 Press MENU.
- 2 Press the navigation buttons to select [SETTINGS], then press .
- 3 Press to select [RADIO], then press .
- 4 Press the navigation buttons to select an option, then press to confirm.

[LOC/DX]	[LOC]	Only broadcast local stations with strong signals.
	[DX]	Broadcast any stations with strong and weak signals.
[STEREO/MONO]	[STEREO]	For stereo broadcasting.
	[MONO]	For mono broadcasting.

8 Other settings

Turn on or off the screen backlight

To turn on or off the screen backlight of the system, press and hold **SOURCE**.

Select Video Output format

The default video output format is based on the format that is broadcast in your country. If the picture is distorted, change the video output.

Simply press the **P/N** button repeatedly to select the correct video output format.

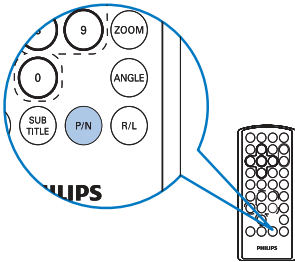

Listen to other devices

You can connect an external audio/video device to the car audio system.

- 1 Connect the the device to the car audio system.
- 2 Press **MENU**.
↳ The main menu is displayed.T
- 3 Press the navigation buttons to select  **[AV-IN]**.
- 4 Operate the connected the device (see the device's instructions manual).

Set rear view camera

If you connected a rear view camera, you can see from the screen of the car audio system what the camera takes when the back lamp lights up.

- 1 Press **MENU**.
↳ The main menu is displayed.T
- 2 Press the navigation buttons to select  **[CAMERA]**.
↳ Picture from rear camera is displayed.



Tip

- To adjust camera setting, see "Adjust general settings"section.

Reset

To reset the car audio system to its default setting:

- 1 Detach the front panel.
- 2 Press **RESET** by using a ball-point pen or similar tool.
↳ All settings are erased except clock.

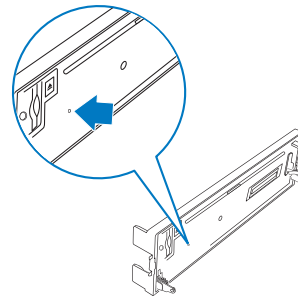

Replace fuse

If the system does not power on, the fuse may be damaged and need replacement.

- 1 Detach the front panel and take out the system.
- 2 Check the electric connection.
- 3 Buy a new fuse that matches the voltage of the damaged fuse (15A).
- 4 Replace the fuse.

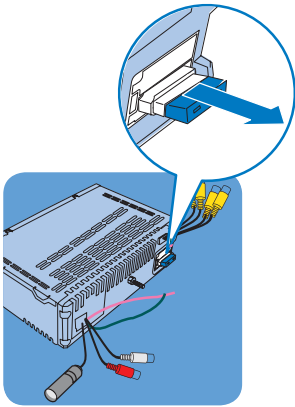

9 Product information

Note

- Product information is subject to change without prior notice.

General

Power supply	12V DC (11V - 16V), negative ground
Fuse	15A
Suitable speaker impedance	4-8 Ω
Continuous power output	18W \times 4 channels
Line output voltage	2.0V
Aux-in level	500mV
Dimensions (W \times H \times D)	188 \times 58 \times 194 mm
Weight	1.5kg
Operating temperature range	-20°C to 70 °C

Disc player

System	DVD / CD audio / MP3 system
Frequency response	20Hz - 20k Hz
Signal / noise ratio	> 75dB
Total harmonic distortion	Less than 1%
Channel separation	> 55dB
Video signal format	NTSC / PAL / AUTO
Video output	1 +/- 2.0V

Tuner

Frequency range - FM	87.5 - 107.9 MHz (50kHz per step)
Frequency range - AM (MW)	522 - 1620 kHz (9kHz per step)
Usable sensitivity - FM	8 μ V
Usable sensitivity - AM (MW)	30 μ V

LCD

Screen size	3 inches (16:9)
Display resolution	320 x 240 pixel
Contrast ratio	>400:1
Brightness	350 cd/m ²

Compatible USB devices

- USB flash memory (USB 2.0 or USB1.1)
- USB flash player (USB2.0 or USB1.1)

Supported formats

- USB or memory file format: FAT16, FAT32
- MP3 bit rate (data rate): 32 - 320 Kbps and variable bit rate
- WMA v9 or earlier
- Directory nesting up to a maximum of 8 levels
- Number of albums / folders: maximum 99
- Number of tracks / titles: maximum 999
- ID3 tag v2.0 or later
- File name in Unicode UTF8 (maximum length: 128 bytes)

Unsupported formats

- Empty albums: an empty album is an album that does not contain MP3 / WMA files, and is not be shown in the display.
- Unsupported file formats are skipped. For example, Word documents (.doc) or MP3 files with extension .dlf are ignored and not played.
- AAC, WAV, and PCM audio files.
- DRM protected WMA files (.wav, .m4a, .m4p, .mp4, .aac)
- WMA files in Lossless format
- ISO9660, Joliet
- Maximum title number: 512 (depending on file name length)
- Maximum album number: 255
- Supported sampling frequencies: 32 kHz, 44.1 kHz, and 48 kHz
- Supported bit-rates: 32 ~ 256 (Kbps), variable bit rates

10 Troubleshooting



Caution

- Never remove the casing of this apparatus.

To keep the warranty valid, never try to repair the system yourself.

If you encounter problems when using this system, check the following points before requesting service. If the problem remains unsolved, go to the Philips web site (www.philips.com/support). When you contact Philips, make sure that your system is nearby and the model number and serial number are available.

No power

- Car engine has not been started. Start the car engine.
- Connections is incorrect.
- Fuse has been damaged. Replace fuse.

No sound

- Volume is too low. Adjust volume.
- Speaker connections is incorrect.

No response to the remote control

- Ensure that the path between the remote control and the unit is clear from obstacles.
- From a close distance, point the remote control directly at the unit.
- Replace the remote control battery.
- The function does not work. Refer to the instructions.

Disc does not play

- Disc is upside down. Ensure the printed side is upwards.
- Disc is dirty. Clean the disc with a clean, soft, lint-free cloth. Wipe the disc outwards from the center.
- Disc is defective. Try another disc.
- Incompatible disc is used. Try another disc.
- Disc rating exceeds the restrict setting. Change the rating settings to lower one.

- Disc region code is not compatible with the unit. Use disc with proper region code.

Disc is blocked in the disc compartment

- Press and hold ▲ until the disc comes out.

No image

- Parking brake wire connection is incorrect. Check the parking wiring.

Image flashes or distorted

- Video DVD settings do not match with the DVD. Adjust video DVD settings.
- Video connection is improper. Check the connections.

Noise in broadcasts.

- Signals are too weak. Select other stations with stronger signals.
- Check the connection of the car antenna.
- Change broadcast from stereo to mono.

Preset stations lost.

- Battery cable is not connected correctly. Connect the battery cable to the terminal that is always live.

Fuse is broken

- The Fuse type is incorrect. Replace it with a 15A fuse.
- Speaker wire or power wire is grounded. Check the connections.

Display show ERR-12

- USB data error. Check the USB device.



Specifications are subject to change without notice
© 2013 Koninklijke Philips Electronics N.V.
All rights reserved.

CED230_98_UM_V1.0

