



Prestigio

10 YEARS IN THE ART OF HI-TECH



MultiPad 4 Ultimate 8.0 3G

PMP7480D3G_QUAD

Tablet PC

User Manual

Version 1.0

www.prestigio.com

About this user manual

This user manual is specially designed to detail the device's functions and features.

- Please read this manual before using the device to ensure safe and proper use.
- Descriptions are based on the device's default settings.
- Images and screenshots may differ in appearance from the actual product.
- Prestigio continuously strives to improve its products. Due to software upgrading, some contents in this user manual may be different from your product. Prestigio reserves the rights to revise this user manual or withdraw it at any time without prior notice. Please take your product as standard.
- The Android Applications which are provided by your device have been developed by Android's users or other companies, not by Prestigio and are provided at no charge. Unless indicated, otherwise, Prestigio makes no promises nor representations and takes no responsibilities about their performance, quality, content or intellectual property rights.

Conventions used in this manual

In this user manual, we use the following symbols to indicate useful and important information:



Caution: provides safety precaution and important information.



Note: gives additional information.



Tips: usage tips.



The order of options or menus you must select to perform a step.

Contents

1. Unboxing	1
Open your package	1
Your tablet at a glance	1
Buttons.....	1
2. Getting started.....	2
Install the SIM card	2
Insert a memory card	3
Power on your tablet	3
Home screens.....	4
List menu.....	5
3. Basics	6
Finger tips.....	6
Motion gesture	7
Charge the battery	7
Connect to your PC	8
Lock and unlock the screen.....	9
Voice control.....	10
Recently used apps	10
Notifications panel	10
Enter text	12
Use widgets.....	13
System upgrade	13
Status icons	14
4. Web & network.....	15
Connect to Internet.....	15
VPN.....	17
Web browse	18
5. Apps.....	20
Play store.....	20
Manage your apps.....	20
6. Mail	21
Set up an email account.....	21
Send a mail.....	21
View your mails.....	21
Reply to a mail.....	22
Delete mails	22
Gmail	22

7. Camera	24
Your camera at a glance	24
Take a photo	25
Take a photo of yourself	25
Take a panoramic photo	25
Take a group shot.....	25
Take continuous shots	25
HDR	26
Record a video	26
Camera scenes	26
Camera and video settings.....	26
8. Multimedia	28
Gallery	28
Video player	30
Music player.....	31
FM radio.....	33
Voice recorder.....	34
9. Phone	35
Make a call	35
Answer a call	35
Reject a call	35
End a call	35
Contacts	35
Use speed dial	37
Call a phone number in a text message	37
Call a phone number in an email	37
Set up a conference call	37
Make an emergency call	38
10. Messages	39
Send a message.....	39
Check your message.....	39
Reply to a message	39
Forward a message	39
Delete messages	40
Create a conversation shortcut.....	40
WAP push messages	40
11. Bluetooth.....	41
Turn on or off Bluetooth	41
Pair with a Bluetooth device	41

Unpair with a Bluetooth device	41
Receive data via Bluetooth	41
Send data via Bluetooth	41
12. eReader Prestigio	42
Your eReader at a glance	42
Download an eBook	42
Read an eBook	42
eReader settings	43
13. Travel & maps	44
Find a location	44
Get directions	44
Navigation	45
Use Google maps	45
14. My files and storage	46
My files	46
Storage	46
15. Utilities	47
Clock	47
Calendar	48
Calculator	48
ToDo list	49
Google search	49
16. Set up your tablet	51
Wireless & Networks	51
Device	52
Personal	52
Accounts	52
System	53
17. Specifications	54
18. Troubleshooting	55

1. Unboxing

1

Open your package

- Prestigio MultiPad
- Travel charger
- Carrying case
- USB cable
- OTG cable
- Quick start guide
- Legal and safety notices
- Warranty card

Your tablet at a glance

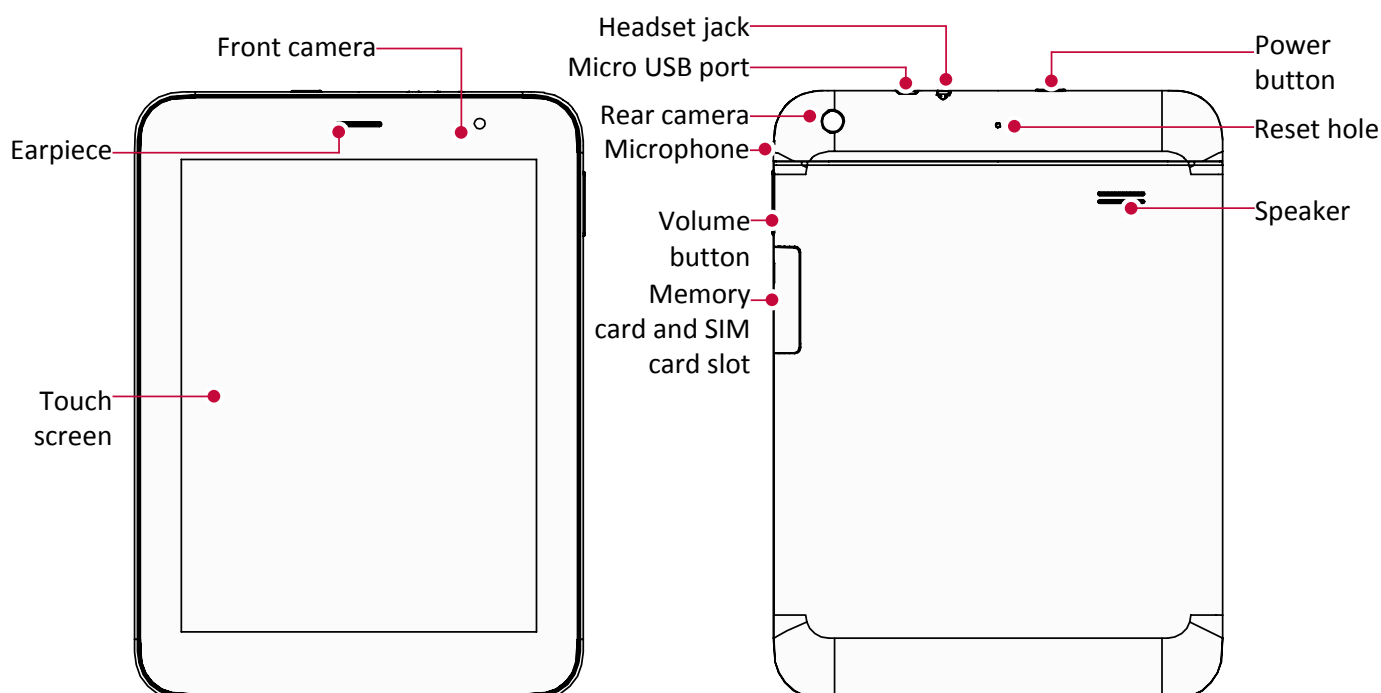

Buttons

Button	Definition	Function
	Power	<ul style="list-style-type: none">• Press and hold to power on or off your tablet.• Press to lock or unlock the screen display.
	Volume	<ul style="list-style-type: none">• Press to adjust the volume.
	Back	<ul style="list-style-type: none">• Tap to return to the previous screen.• Tap to hide the onscreen keyboard when it is opened.
	Home	<ul style="list-style-type: none">• Tap to return to home screen.
	Recent app	<ul style="list-style-type: none">• Tap to open the list of recent apps.
	List menu	<ul style="list-style-type: none">• Tap to open the list menu.• Tap and hold to add or delete a page of Home screen.

2. Getting started

2

Congratulations on your purchase and welcome to Prestigio. To get the most from your product and enjoy all Prestigio has to offer, please access:

<http://www.prestigio.com/catalogue/MultiPads>

More details about your product, please access:

<http://www.prestigio.com/support>



Please read the "Legal and safety notices" on your package before use.



- Do not cover the antenna area with your hands or other objects. This may cause connectivity problems.
- Do not allow water to contact the touch screen. The touch screen may malfunction in humid conditions or when exposed to water.

Install the SIM card

Follow the steps below to insert your SIM card.

1. Securely hold your MultiPad. With your finger, open the cover of the Memory card and SIM card slot.

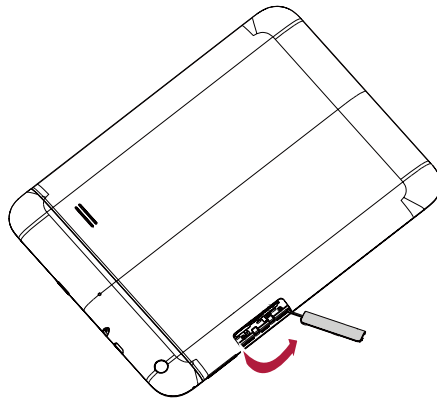

Be careful not to damage your fingernails when you open the cover.

2. With the SIM card's gold contacts facing down and its cut-off corner facing outwards, insert the SIM card all the way into the SIM card slot. Push the SIM card in until it clicks into place.

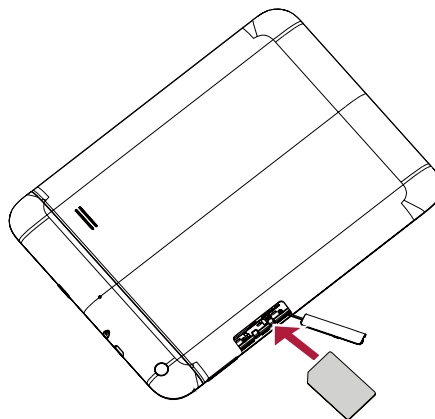

Remove the SIM card: Push the SIM card in to eject it from its slot, and remove it.

Insert a memory card

You can expand the memory of your tablet and store more additional multimedia files by adding a micro-SD card. Depending on the memory card manufacturer and type, some memory cards may not be compatible with your device.

1. Insert a memory card with the gold-coloured contacts facing downwards.
2. Push the memory card into the slot until it locks in place.

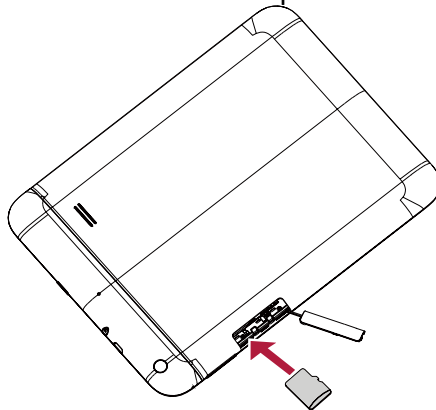

3. Close the cover of the memory card and SIM card slot.

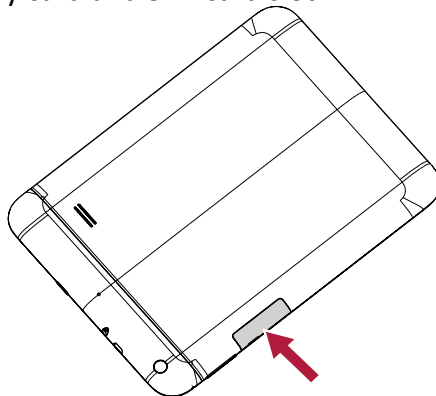

Some memory cards may not be fully compatible with the device. Using an incompatible card may damage the device or the memory card, or corrupt the data stored in it.



- Frequent writing and erasing of data shortens the lifespan of memory cards.
- When inserting a memory card into the device, the memory card's file directory appears in the **File manager > SD card**.



Remove the memory card: push the memory card until it disengages from the device, and then pull it out.

Power on your tablet

Press and hold the Power button for a few seconds to power on your tablet.

1. When turning on the device for the first time, follow the on-screen instructions to set up your device.
2. After setting up your tablet, there is an Installer Prestigio wizard appears on the screen. It offers you some third-party apps, tap the apps you want to install on your tablet. Follow the on-screen instructions to install the apps.
3. It might take a certain time for your tablet to install the apps.



To turn off your tablet, press and hold the Power button, and then tap **Power off** on the pop up screen.



If you do not install the apps provided by the Installer Prestigio wizard for the first time, you can tap **Installer Prestigio** on the home screen to install the apps next time.

Home screens

Your Home screen is the starting point to access all of the tablet's features. The Home screen can have multiple panels. To view other panels, swipe left or right. Tap  to return to the center home screen. You can add your favorite applications, shortcuts, folders and widgets, so they're always just a tap away. Your tablet's home screen consists of the following areas:





Set wallpaper

Pick your favorite photo as your Home wallpaper. Choose from the available wallpapers, or use any photo you've taken with the camera.

1. Tap and hold the blank area on the Home screen.
2. Select one of the following: **Gallery**, **Live wallpapers** or **Wallpapers**.
3. Select an image and tap **Set wallpaper**. Or, select an image, resize it by dragging the frame, and then tap **OK**.

Add or delete a page

You can add a new blank page for your Home screen. You can also delete the current page on the Home screen.

- Tap and hold  on the Home screen.
 - Tap  to add a new page of the Home screen.
 - Tap  to delete the selected page.



Add an app icon to home screen

1. On the Home screen, tap  to open the list menu.
2. Tap and hold an application icon.
3. Drag it into a panel preview.

Remove an item on the Home screen

1. Tap and hold an item to remove.
2. The **Remove** option appears at the top of the Home screen.
3. Drag the item to the **Remove** option.
4. When the **Remove** option turns red, release the item.

List menu

All your apps' icons can be found on the list menu. You also can find all the widgets of the apps on the list menu. On home screen, tap  to open list menu. The list menu can have multiple panels. To view other panels, swipe left or right. Tap  or  to return to the home screen. Your tablet's list menu consists of the following areas:



3. Basics

3

Finger tips

Only use your fingers to use the touch screen.

Tap

To open an application, to select a menu item, to press an on-screen button, or to enter a character using the on-screen keyboard, tap it with a finger.

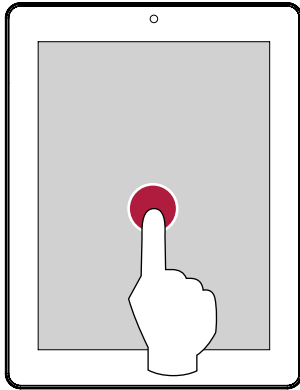

Tap and hold

Tap and hold an item for more than 2 seconds to access available options.

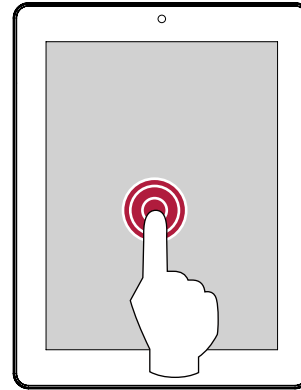

Swipe

Quickly swipe your finger vertically or horizontally across the screen to go to other Home pages, scroll through documents, and more.

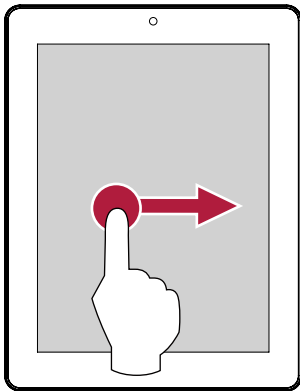

Slide

Slide your finger vertically across the screen to open drop-down menu.

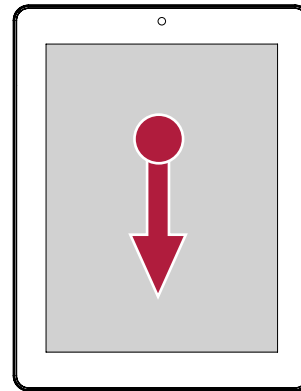

Zoom in

Spread two fingers apart on a webpage, map, or image to zoom in a part.

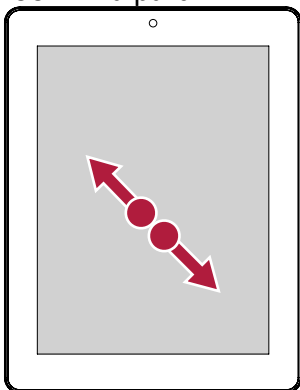

Zoom out

Pinch two fingers together on a webpage, map, or image to zoom out a part.

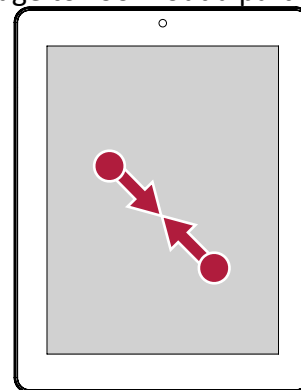

Scroll

Drag up or down to scroll. On some screens, such as webpages, you can also scroll side to side.

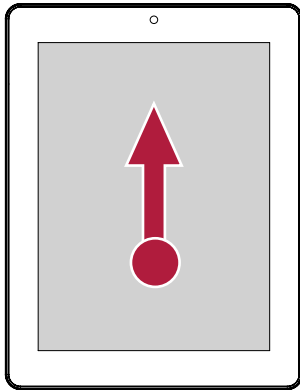

Flick

Flick left or right on the Home screen or the Applications screen to see another panel. Flick up or down to scroll through a webpage or a list, such as contacts.

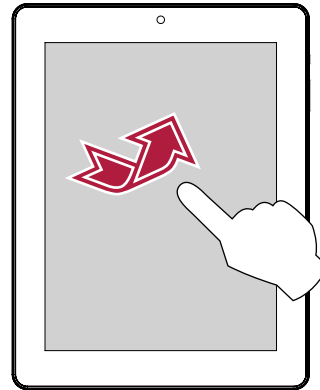

Motion gesture

Rotate your tablet for a better view

For many screens, you can automatically change the screen orientation from portrait to landscape by turning your tablet sideways. When entering text, you can turn your tablet sideways to bring up a bigger keyboard.

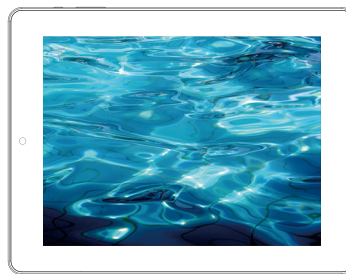
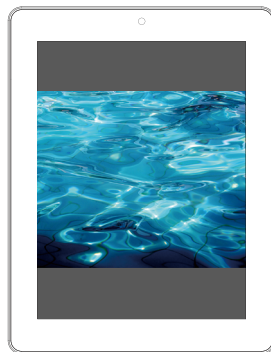

To prevent the display from rotating automatically, open the notifications panel and deselect **Auto rotation**.



- Some applications do not allow screen rotation.
- Some applications display a different screen depending on the orientation.

Charge the battery

A new battery is partially charged. The battery icon in the upper-right corner shows the battery level of charging status.

1. Plug the small end of the charger into the micro USB port of the device, and plug the large end of the charger into an electric socket.

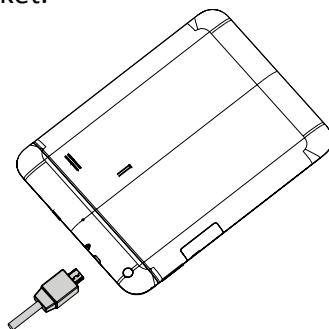

2. After fully charging, disconnect the device from the charger. First unplug the charger from the device, and then unplug it from the electric socket.



Always use authentic accessories as they enable your tablet to perform at its peak. Nonauthentic accessories (eg. chargers) may damage your tablet.



- You can use the tablet while it is charging.
- The only way to turn off the charger is to unplug it, so it is advisable to use an easily accessible power socket.

Optimize your battery performance

Here are some steps to help you optimize your battery performance.

- Always ensure that your tablet profile is appropriately set to meet your actual usage. Profile setting significantly impacts the tablet's battery performance. In general, Outdoor Mode is the most power-draining setting while Silent Mode consumes the least amount of power.
- If you're not using applications like Bluetooth, WIFI, GPS and Apps, turn them off. And be sure to lock your tablet to prevent accidental pressing of the keys with the auto-lock feature.
- Adjust the intensity and duration of your display screen's backlight to low or medium level and for the shortest duration. In general, the lower the backlight level and the shorter the duration, the more power you will save.
- Avoid using or placing your tablet near magnetic objects (eg. a radio or television) or on metal surfaces, which will impact the network connection and ultimately drain power from your battery.

Connect to your PC

Your tablet's micro USB port allows you exchange media and other files with a connected computer.

- Connect your tablet to the PC using the supplied USB cable.

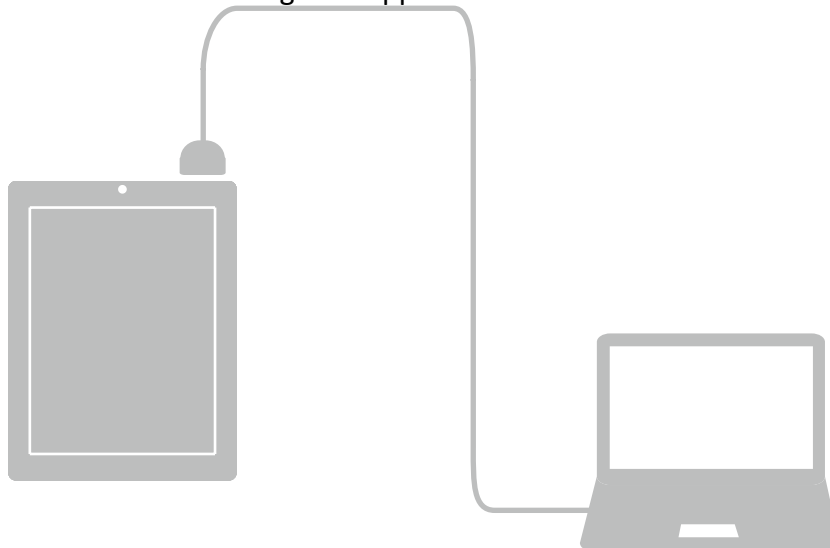

Load files from your PC

1. Connect your tablet to the PC by using the USB cable.
2. Slide to open notification panel, tap **Connected as USB Storage**.
3. Tap to select **USB storage** in USB computer connection screen.
4. Slide to open notification panel again, tap **USB connected**.
5. Tap to turn on USB storage.
6. Transfer files between your tablet and the PC.

Connect with Windows Media Player

1. Connect your tablet to the PC by using the USB cable.
2. Slide to open notification panel, open **USB computer connection** screen.
3. Tap to select **MTP(Media device)**.
4. Open Windows Media Player on your PC.
5. You can sync multimedia files now.

Lock and unlock the screen

When not in use, lock your tablet to prevent unwanted operation and save the battery.

- Lock: press the power button.



When your tablet is locked, nothing happens if you touch the screen.

Your tablet can still:

- Receive calls, text messages, and other updates.
- Listen to music.
- Adjust the volume.

You can use the headset to answer a call or listen to music.

- Unlock: press the power button, and then slide the lock icon to unlock your screen.

Auto lock

You can set an time span for the screen to be locked automatically.

1. On home screen, tap  to open list menu.
2. Tap **Settings > Display > Sleep**.
3. Select your desired time span.

Set screen lock pattern

Protect your personal information and prevent others from using your tablet without your permission by setting a screen lock pattern, face unlock, PIN, or password. You'll be asked to unlock the screen every time your tablet is powered on or when it's idle for a certain period of time.

1. On home screen, tap  to open list menu.
2. Tap **Settings > Security > Screen lock**.

Setting a face unlock

1. On home screen, tap  to open list menu.
2. Tap **Settings > Security > Screen lock > Face Unlock**.
3. Fit your face in the frame to be captured.

Setting a pattern

1. On home screen, tap  to open list menu.
2. Tap **Settings > Security > Screen lock > Pattern**.
3. Draw a pattern by connecting four dots or more, and then draw the pattern again to verify it.

Setting a PIN

1. On home screen, tap  to open list menu.
2. Tap **Settings > Security > Screen lock > PIN**.
3. Enter at least four numbers, and then enter the password again to verify it.

Setting a password

1. On home screen, tap  to open list menu.
2. Tap **Settings > Security > Screen lock > Password**.
3. Enter at least four characters including numbers and symbols, and then enter the password again to verify it.

Unlock your tablet

Turn on the screen by pressing the Power button, and enter the unlock code.

If you've forgotten your screen lock pattern, you have up to five attempts to try and unlock your tablet. If this fails, take the device to dealer to reset it.

Voice control

Voice Control lets you make phone calls and control music playback using voice commands.

Use Voice Control: press the volume button to adjust the volume. Press the top of the button to volume up, and press the bottom of the button to volume down.

Recently used apps

You can easily access apps you've just recently opened.

1. Tap  to open the list of recently-used apps.
 2. Slide your finger to see recently-opened apps.
 - To switch back to an app, just tap it.
 - To remove an app from the list, swipe it.
-

Notifications panel

To help make sure you don't miss important events, many apps can provide alerts. An alert can appear briefly as a banner at the top of the screen, which goes away if you don't respond to it, or as a notice in the center of the screen that remains until you acknowledge it.

When you get a new notification, you can open the Notifications panel to see what event notification or new information you have received. You can also quickly access settings from the Notifications panel.

- To open the Notifications panel, slide down from the top of the screen.
- To close the Notifications panel, drag up the bar that is on the bottom of the screen.
- To dismiss the notification, tap .

Using Quick Settings

The Quick Settings tab lets you easily turn on Airplane mode, Wi-Fi, and more, and also provides a quick shortcut to change the mode and set the brightness, auto rotation if slide the tab.

- Tap the upper-left or upper-right corner on the screen to switch between Notifications panel and Quick Setting list.

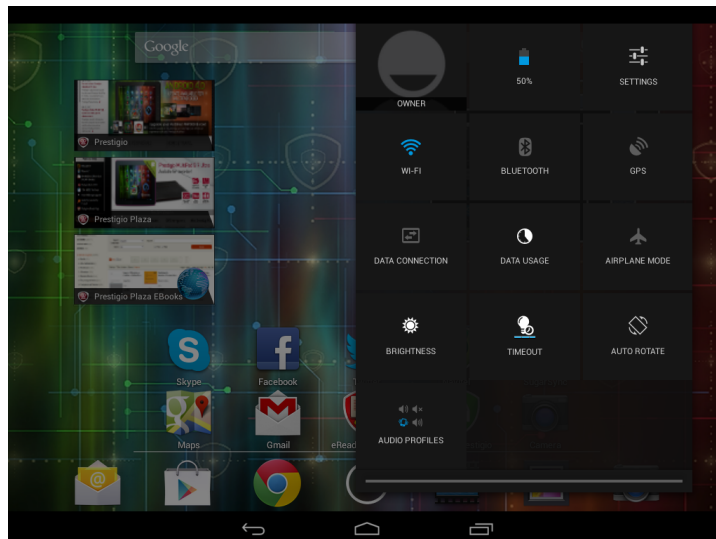

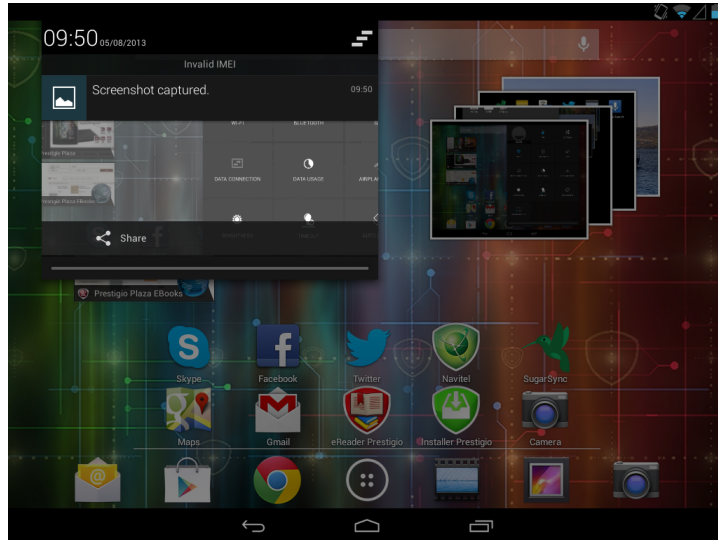

You can view your tablet's current status and use the following options:

- Battery: check the battery status.
- Wi-Fi: activate or deactivate the Wi-Fi feature.
- Bluetooth: activate or deactivate the Bluetooth feature.
- GPS: activate or deactivate the GPS feature.
- Data connection: activate or deactivate the data connection.
- Data usage: check the data usage of the data connection.
- Airplane mode: turn on or off your tablet's wireless radios.
- Brightness: adjust the brightness of the screen.
- Timeout: adjust the screen timeout.
- Auto rotation: allow or prevent the interface from rotating when you rotate the device.
- Audio profiles: switch to General, Silent, Meeting or Outdoor profiles quickly.

Enter text

Use the onscreen keyboard to enter text, such as contact information, mail, and web addresses. Depending on the app and the language you're using, the keyboard may correct misspellings, predict what you're typing, and even learn as you use it.

Change the input method

You can download an input app or use the input method pre-installed on your tablet. To change the input method, follow the steps:

1. On home screen, tap  to open list menu.
2. Tap **Settings > Language & input > Default**.
3. Choose the desired input method.



Use the Prestigio keyboard

Tap a text field to bring up the keyboard, then tap keys on the keyboard. You can enter the text in QWERTY keyboard.



Enter the text

As you type, each letter appears above your thumb or finger. The letter isn't entered until you choose your desired word.

- Type uppercase: tap the Shift key  before tapping a letter. Or touch and hold the Shift key, then tap a letter.
- Type lowercase: tap the Shift key again and then tap a letter.
- Enter numbers, symbols or punctuation: tap .

Enter text by voice

You also can enter the text by activating the voice input feature and then speak into the microphone. Your phone displays what you speak.

Voice typing: open the Prestigio keyboard, tap and hold .

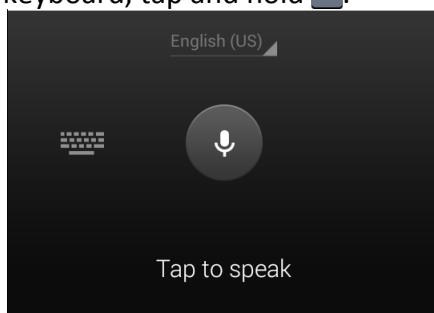

- If the device does not recognise your words correctly, tap the underlined text and select an alternative word or phrase from the dropdown list.
- To change the language or add languages for the voice recognition, tap  and select **Add more languages**.

Copy and paste text

1. After you have selected the text you want to copy, tap . The selected text is then copied to the clipboard.
2. In a text entry field, press at the point where you want to paste the text.
3. Tap **Paste**.

Move a text

1. After you have selected the text you want to cut, tap . The selected text is then cut to the clipboard.
2. In a text entry field, press at the point where you want to paste the text.
3. Tap **Paste**.

Use widgets

Widgets put at-a-glance important information and media content up front on your Home screen. Some widgets are already added to your Home screen for your convenience. You can add more from the available selections of widgets.

Add a widget to the Home screen

1. On home screen, tap  to open the list menu.
2. Tap **WIDGETS** to open widgets list.
3. Scroll left or right on the widgets panel.
4. Tap and hold the desired widgets to add it to the home screen.



- Some widgets connect to web services. Using a web-based widget may result in additional charges.
- The widgets available may vary depending on the region or service provider.

System upgrade

Your tablet can check and notify you if there's a new upgrade available. You can also manually check if there's an available update.

You can set this option in **Settings > About tablet > System updates**.



Do not press any buttons while the device is upgrading.

Status icons

The icons in the status bar at the top of the screen give information about your tablet:



Icons	What it means	Icons	What it means
	Silent mode activated.		3G network connected.
	Vibration mode activated.		Wi-Fi connected.
	Flight mode activated.		Roaming (outside of normal service area).
	Battery power level.		Bluetooth is activated.
	Call in progress.		Connected to PC.
	Missed call.		Wired microphone headset connected.
	New SMS or MMS.		Wired headset connected.
	GPRS network connected.		No SIM card detected.
	EDGE network connected.		Alarm is set.
	HSPA network connected.		

4. Web & network

4

You can connect your tablet to Internet and browse a webpage on the website.

Connect to Internet

Your tablet connects to the Internet whenever necessary, using a Wi-Fi connection (if available) or your mobile operator's data connection.

Data connection

You can use your mobile operator's data connection. Some apps and services may transfer data over your mobile operator's cellular network, which may result in additional fees. Contact your mobile operator for details.

Turn on or off data connection

1. On the home screen or list menu, tap **Settings**.
 - Or, tap  on Quick Setting list.
2. Tap **More...** > **Mobile networks** > **Data connection**.
3. Tap to turn on or off data connection.



You can tap to turn on or off data connection on Quick Setting list. On home screen, tap upper-right corner to switch to Quick Setting list, and then tap **Data connection**.





If you don't have the data connection turned on and you're also not connected to a Wi-Fi network, you won't receive automatic updates to your email, social network accounts, and other synced information.

Add a new access point

Access Point Names (APNs) connect your tablet to data networks for services such as mobile web browsing.



Before you add another data connection, have the access point name and settings from your mobile operator ready (including username and password if required).

1. On the home screen or list menu, tap **Settings**.
 - Or, tap  on Quick Setting list.
2. Tap **More...** > **Mobile networks** > **Access Point Names**.
3. On the APNs screen, tap  > **New APN**.
4. Enter the APN settings.
5. Tap  > **Save**.
6. Select the new APN on the APNs screen.

Turn on or off data roaming

Connect to your mobile operator's partner networks and access data services when you're out of your mobile operator's coverage area.



Using data services while roaming may be costly. Check with your mobile operator for data roaming rates before you use data roaming.

1. On the home screen or list menu, tap **Settings**.
- Or, tap  on Quick Setting list.
2. Tap **More... > Mobile networks > Data roaming**.
3. Tap to turn on or off data roaming.

Keep track of your data usage

If you're on a limited data allowance, it's important to keep track of the activities and apps that usually send and receive data, such as browsing the web, syncing online accounts, and sending email or sharing status updates.

 To help you save on data usage, connect to a Wi-Fi network whenever possible and set your online accounts and emails to sync less frequently.

 Data usage measured by your tablet may vary with your actual data usage.

1. On the home screen or list menu, tap **Settings**.
- Or, tap  on Quick Setting list.
2. Tap **Data usage**.
3. On the Mobile tab, turn on data connection, select **Set mobile data limit** to automatically disable your data connection when you reach the set limit.
4. Tap **Data usage cycle**, you can set a particular time interval to see how much data you've used.
5. Drag the red line marker to set your monthly data limit.

- You can check your data usage on Quick Setting list. On home screen, tap upper-right corner to switch to quick setting list, and then tap **Data usage**.
- If you're connecting your tablet to another portable Wi-Fi hotspot, tap  **> Mobile hotspots** to restrict background data from downloading that may incur extra data fees.

Check the data usage of apps

1. On the home screen or list menu, tap **Settings**.
- Or, tap  on Quick Setting list.
2. Tap **Data usage**.
3. On the Mobile tab, drag the vertical line markers to see how much data you've used during a particular time interval.
4. Scroll down the screen to see a list of apps and their data usage info.
5. Tap an app to see more details.

Wi-Fi

Connect the device to a Wi-Fi network to use the Internet or share media files with other devices. To use Wi-Fi, you need access to a wireless point or hotspot.

 The availability and strength of the Wi-Fi signal will vary depending on objects, such as buildings or simply a wall between rooms, the Wi-Fi signal has to pass through.

Turn on or off Wi-Fi

Do the following method:

- On home screen, tap upper-right corner to switch to quick setting list, and then tap **WI-FI**.
- On the home screen or list menu, tap **Settings**, and then tap **Wi-Fi** to turn it on or off.

Connect to a wireless network

1. On the home screen or list menu, tap **Settings**, and then tap **Wi-Fi** to turn it on.
2. Detected Wi-Fi networks will be listed in the Wi-Fi networks section.
3. Tap the desired Wi-Fi network you want to connect.
 - If you selected a secured network, you'll be asked to enter the network key or password.



The next time your tablet connects to a previously accessed secured wireless network, you won't be asked to enter the key or other security information again.

Forget the wireless network

Any network that has ever been used, including the current network, can be forgotten so your tablet will not automatically connect to it.

1. On the home screen or list menu, tap **Settings**, and then tap **Wi-Fi**.
2. Tap the wireless network you've been connected.
3. Tap **Forget**.

Use your tablet as a wireless router

Share your data connection with other devices by turning your tablet into a wireless router.



- Make sure the data connection is turned on.
- You must have an approved data plan associated with your account from your mobile service provider to use this service.

1. On the home screen or list menu, tap **Settings**.
2. Tap **More...> Tethering & portable hotspot**.
3. In **Hotspot & tethering settings**, choose the default router name.
4. Choose the type of security and set the password (key) for your wireless router.
 - If you selected None in Security, you don't need to enter a password. The password is the key other people need to enter on their device so they can connect and use your tablet as a wireless router.
5. Tap to turn on Wi-Fi hotspot.

Share your mobile data connection by USB tethering

You can use the data connection of your tablet for your computer to connect to the Internet.



- Make sure your SIM card is inserted on your tablet.
- You may need to have USB tethering added to your data plan, and it may incur additional cost. Contact your mobile service provider for details.

1. Connect your tablet to the computer by using the provided USB cable.
2. On the home screen or list menu, tap **Settings**.
3. Make sure that data connection is turned on.
4. Tap **More...> Tethering & portable hotspot**.
5. Tap to turn on **USB tethering**.

VPN

You can connect and access resources inside a secured local network, such as your corporate network. Depending on the type of VPN you're using at work, you may be asked to enter your login credentials and install security certificates before you can connect to your company's local network. You can get this information from your network administrator. You must first establish a Wi-Fi or data connection before you can start a VPN connection.

Add a VPN connection

You must first set a lock screen PIN or password before you can use credential storage and set up the VPN.

1. On the home screen or list menu, tap **Settings**.
2. Tap **More... > VPN**.
3. Tap  to add VPN profile.
4. Enter the VPN settings and set them up according to the security details your network administrator gave you.
5. Tap **Save**.

Connect to a VPN

1. On the home screen or list menu, tap **Settings**.
2. Tap **More... > VPN**.
3. Tap the VPN that you want to connect to.
4. Enter your log in credentials, and then tap **Connect**. When you're connected, the VPN connected icon appears in the notification area of the status bar. You can then open the web browser to access resources such as your corporate network intranet.











Disconnect from a VPN

1. On the home screen or list menu, tap **Settings**.
2. Tap **More... > VPN**.
3. Tap the VPN connection to disconnect from it.

Web browse

You can use your tablet to browse the websites. Before browsing a website, please confirm that you have turn on data connection or Wi-Fi.

Browse a webpage

1. On the home screen or list menu, tap **Browser**.
2. Enter your search keywords or a webpage address.
3. While browse a webpage, you can:
 - Tap  to go to the previous webpage.
 - Tap  to go to the next webpage.
 - Tap  to reload the current web page; While the device is loading web pages, this icon changes to .
 - Tap  to bookmark the current web page.
 - Tap  to search for information.
 - Tap  to open a list of saved bookmarks and recent Internet history.
 - Tap  to close the current tab.
 - Tap  to open a new tab.
 - Tap  to browse wepages from Bookmarks, History and Saved pages.

Add bookmarks

1. On the home screen or list menu, tap **Browser**.
2. Enter your search keywords or a webpage address.
3. Browse a webpage.
4. Tap .

Open a bookmark

1. While viewing a webpage, tap .
2. Tap **Bookmarks**.
3. On the Bookmarks tab, navigate to the bookmark you want to open, and then tap it.

Edit a bookmark

1. While viewing a webpage, tap .
2. Tap **Bookmarks**.
3. On the Bookmarks tab, tap and hold the webpage you want to edit.
4. Tap **Edit bookmark** on the pop up screen.
5. Enter your changes, and then tap **OK**.

View Browsing history

1. While viewing a webpage, tap .
2. Tap **History**.
3. On the History tab, tap a time period to see a list of webpages you've visited.

Download files

You can download files and apps directly from your favorite websites.



Files and apps downloaded from the Web can be from unknown sources. To protect your tablet and personal data, we strongly recommend that you download and open only the files you trust.

1. On the home screen or list menu, tap **Browser**.
2. Go to the website where you can download the file you want.
3. Follow the website's download instructions for apps.



Before you can install the downloaded app, you need to set your tablet to allow installation of third-party apps in **System settings > Security > Unknown sources**.

View your downloads

1. On the list menu, tap **Downloads**.
2. Tap the file to open it.

Browser settings

Customize the web browser to suit your browsing style. Set display, privacy, and security options when using the web browser.

- From the browser screen, tap  > **Settings**.

Set homepage

1. On the home screen or list menu, tap **Browser**.
2. On the browser screen, tap  > **Settings**.
3. Tap **General > Set homepage**.
4. Select the homepage you want to use.

5. Apps

5

Play store



Use the Google Play store to purchase and download applications and games that are able to run on the your tablet. Choose from a wide variety of free and paid apps ranging from productivity apps, entertainment, to games.

- On the home screen or list menu, tap .



- A Google Wallet™ payment service is required to purchase a paid app. You will be asked to confirm method of payment when you purchase an app.
- The name of the Play Store app may differ depending on your region.
- The ability to purchase apps varies by region.



Search and install an app

1. On the home screen or list menu, tap .
2. Browse applications by category, or tap  to search with a keyword.
3. Select an application to view information.
4. To download it, tap **Install**.
 - If there is a charge for the application, tap the price, and follow on-screen instructions to complete the purchase process.



- When a new version is available for any installed application, an update icon appears at the top of the screen to alert you to the update. Open the notifications panel and tap the icon to update the application.
- To install applications that you downloaded from other sources, you need to set your tablet to allow installation of third-party apps in **System settings > Security > Unknown sources**.

Uninstall an app in Play store

1. On the home screen or list menu, tap .
2. Tap .
3. Select an app you want to uninstall.
4. Tap **Uninstall**.

Manage your apps

Check the running apps

1. On the home screen or list menu, tap **Settings > Apps**.
2. Go to Running tab, you can check all the apps is running now.

Stop an app

1. On the home screen or list menu, tap **Settings > Apps**.
2. Tap the app you want to stop.
3. Tap **Stop**.

Uninstall an app

1. On the home screen or list menu, tap **Settings > Apps**.
2. Tap the app you want to uninstall.
3. Tap **Uninstall**.



- For different apps, the options may be vary.
- You can not uninstall the essential apps and system app, such as Contacts, Settings and etc.

6. Mail

6

Use this application to send or view email messages. Learn to send or view email messages via your personal or company email account.

Set up an email account

1. On the home screen or list menu, tap **Email**, do one of the following:
 - If this is your first time to add an email account in Mail, just move to the next step.
 - If you've already added an email account in Mail, then tap  > **Settings** > **ADD ACCOUNT**.
2. Enter the email address and password for your email account.
3. Tap **Next** for a private email account, or tap **Manual setup** for a company email account.
4. Follow on-screen instructions to complete the setup.





When you are finished setting up the email account, the email messages are downloaded to your device.



Consult your mail service provider for the mail server configuration.

Send a mail

1. On the home screen or list menu, tap **Email**.
2. Switch to the email account that you want to use.
3. Tap .
4. Fill in one or more recipients.
 - If you want to loop in more recipients in a carbon copy (Cc) or blind carbon copy (Bcc) of the email message, tap **+CC/BCC**.
5. Enter the subject, and then compose your mail.
 - Add an attachment: tap  and then choose what you want.
6. Tap  to send the mail.

View your mails

1. On the home screen or list menu, tap **Email**.
2. Switch to the email account that you want to use.
3. The mail inbox displayed on the screen.
4. Tap  to check whether there is a new mail.
5. Tap the desired mail to read it.



Unread email messages display in bold in your inbox and color bars appear next to them.

Search for a mail

1. On the home screen or list menu, tap **Email**.
2. Switch to the email account that you want to use.
3. Tap  to display the search bar.
4. Choose a search option in the drop-down list.
5. Enter the first few letters of the mail sender or subject in the search bar.
6. Select the mail from the list.

Reply to a mail

1. On the home screen or list menu, tap **Email**.
2. Switch to the email account that you want to use.
3. In the email account inbox, tap the email message.
4. Tap ↶, and then compose your mail.
5. Tap ➤ to send the mail.

Delete mails

1. On the home screen or list menu, tap **Email**.
2. Switch to the email account that you want to use.
3. Tap the desired mail, and then tap 🗑️.

Gmail

Use this application to quickly and directly access the Google Mail service.

View your Gmail Inbox

All your received email messages are delivered to your Inbox.

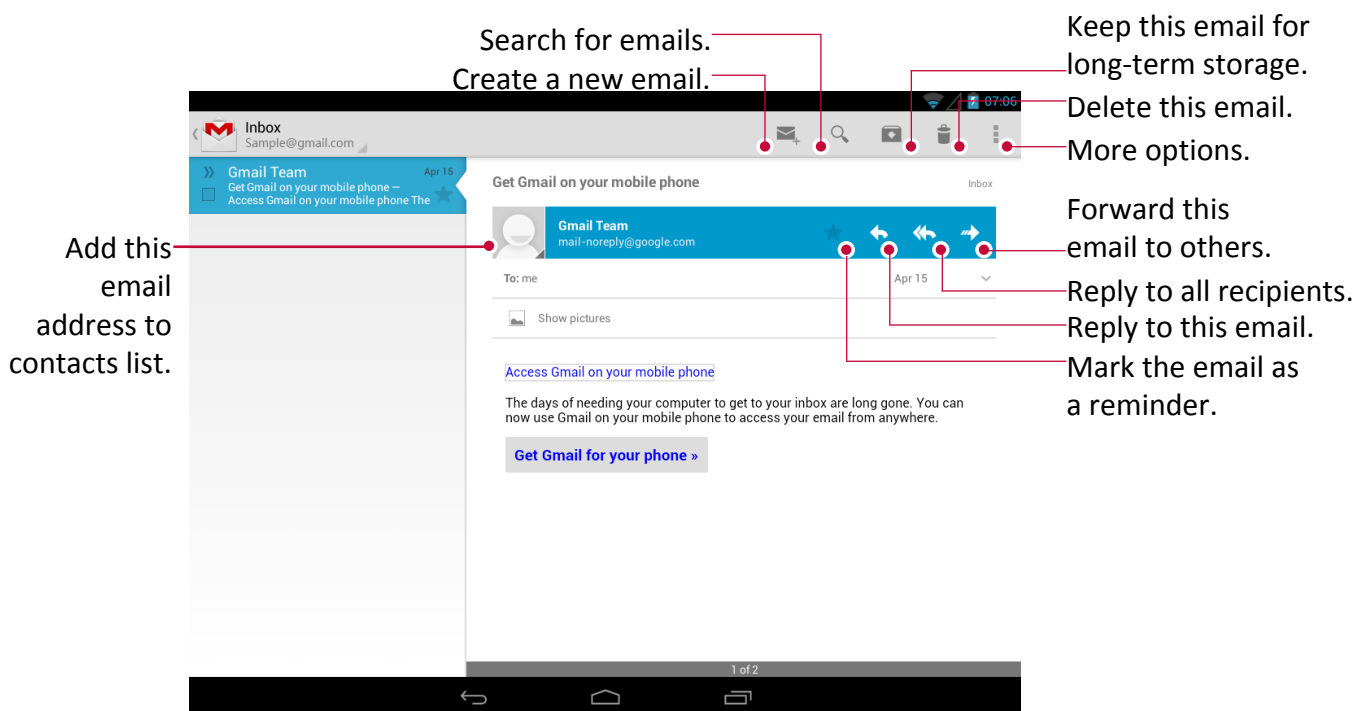

1. On the home screen or list menu, tap **Gmail**.
2. The mail inbox displayed on the screen.
3. Tap ↻ to check whether there is a new mail.
4. Tap the desired mail to read it.
5. Swipe left or right to view the previous or next mail.





Search for a mail

1. On the home screen or list menu, tap **Gmail**.
2. Tap 🔍 to display the search bar.
3. Enter the first few letters of the mail sender or subject in the search bar.
4. Select the mail from the list.

Send a mail by Gmail

1. On the home screen or list menu, tap **Gmail**.
2. Tap .
3. Fill in one or more recipients.
 - If you want to loop in more recipients in a carbon copy (Cc) or blind carbon copy (Bcc) of the email message, tap **+CC/BCC**.
4. Enter the subject, and then compose your mail.
 - Add a picture or video: tap .
5. Tap  to send the mail.

Reply to a mail by Gmail

1. On the home screen or list menu, tap **Gmail**.
2. In the email account inbox, tap the email message.
3. Tap , and then compose your mail.
4. Tap  to send the mail.

Delete mail by Gmail

1. On the home screen or list menu, tap **Gmail**.
2. Tap the desired mail, and then tap .

7. Camera

7

With your tablet, you can take both photos and videos as desired. In addition to the rear camera on the back, there's a camera on the front for video calls and self-portraits. The LED flash on the back gives you extra light when you need it.





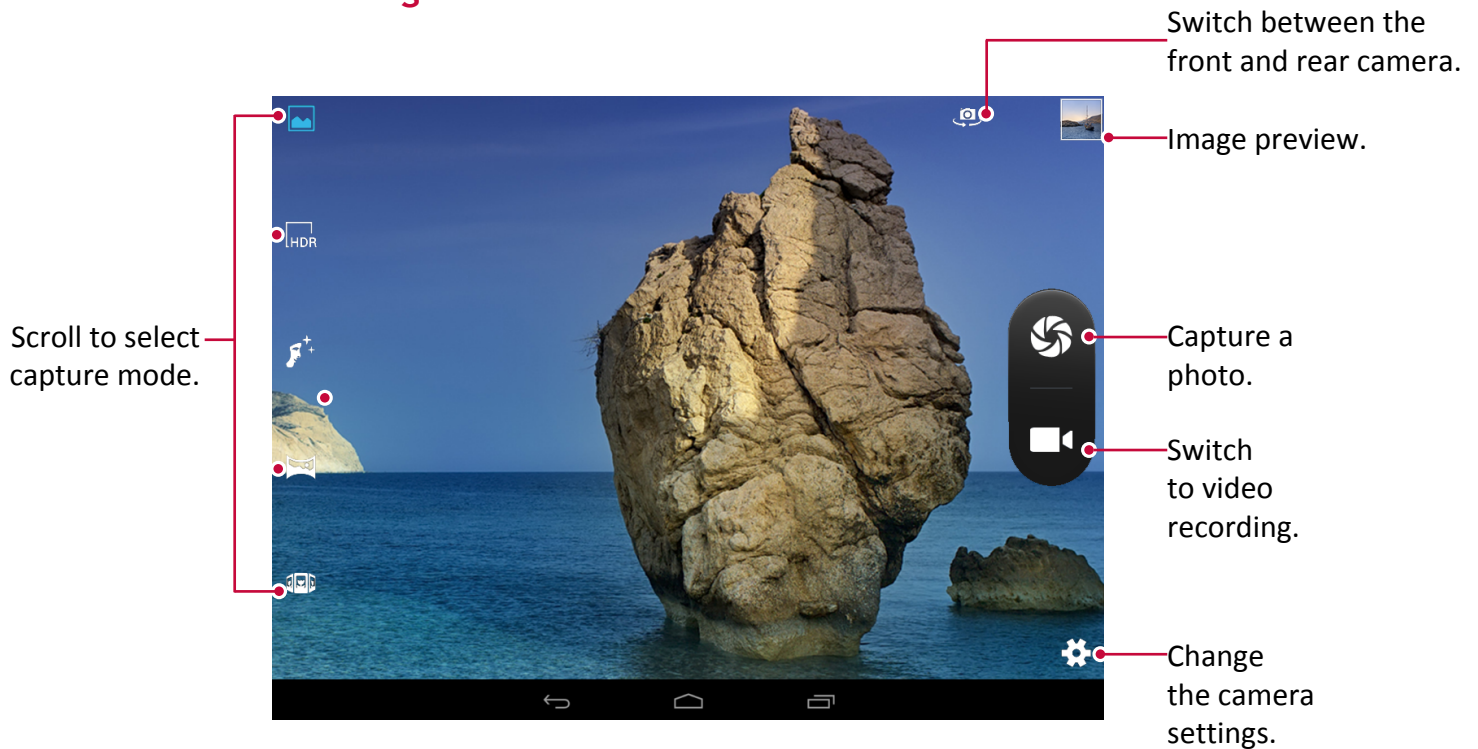



- To use the camera, on the home screen or list menu, tap **Camera**.

Your camera at a glance



Select capture mode



While using your camera, you can scroll the capture mode list to select your desired capture mode. You can choose the following capture modes:

-  Take a single photo.
-  Use HDR (High Dynamic Range) to capture your subjects clearly when shooting portraits against a bright background.
-  Set your tablet to recognise people's faces and help you take photos of them.
-  Take a panoramic photo. You can take a photo composed of many photos strung together.
-  Capture multi-angle photos.
-  Switch to auto scene detection mode.
-  Auto capture when smile is detected.
-  Switch to best shot mode.
-  Take three photos with different exposures and then combine them to improve the contrast ratio.



Take a photo

1. Tap **Camera** to turn on the camera.
2. Spread or pinch the screen to zoom in or out.
3. Change the camera setting if necessary.
4. Just point the camera at what you want to capture. The camera adjusts the focus automatically as you move it.
5. Tap  to capture the photo.

Take a photo of yourself



1. Tap **Camera** to turn on the camera.
2. On the screen, tap .
3. Tap  to capture the photo.

Set self timer

1. Tap **Camera** to turn on the camera.
2. Tap  to customize your camera.
3. On the pop up window, tap  > **Self timer**, select your time span.
4. When you're ready to take a photo, tap . The photo will be captured after the set time span.

Take a panoramic photo

You can capture anything wide or tall in a single photo by using your tablet.

1. Tap **Camera** to turn on the camera.
2. Scroll the capture mode, and then tap .
3. When you're ready to take the first shot, tap . Directional arrows appear, prompting you to pan left or right in landscape view (or pan up or down in portrait view).
4. Pan your tablet as smoothly as you can, and then pause when you see a complete frame on the Viewfinder screen. The camera automatically captures the shot.
5. Repeat the previous step to take the remaining shots.
6. The camera stitches the shots into a single photo.



Zoom and flash are disabled when you're in this mode.

Take a group shot



Using your tablet, you can get perfect group portraits with the most smiles and the fewest blinks.

1. Tap **Camera** to turn on the camera.
2. Scroll the capture mode, and then tap .
3. When you're ready to take the photo, tap .
4. The camera takes several shots and merges them into the best possible group photo.

Take continuous shots



With your tablet, you can take continuous shots by just holding the capture icon once.

Make sure that you're in normal capture by tapping .

1. Tap **Camera** to turn on the camera.
2. Tap  to customize your camera.
3. On the pop up window, tap  > **Continuous shot**, select your desired shots.
4. When you're ready to take the photo, tap and hold .
5. To save more photos from the batch, just delete the photos you don't want to keep.

HDR





When shooting portraits against a bright background, use the HDR (High Dynamic Range) scene to capture your subjects clearly. HDR brings out the details of both the highlights and shadows, even in high contrast lighting.

1. Tap **Camera** to turn on the camera.
2. Scroll the capture mode, and then tap .
3. When you're ready to take the photo, tap .





Do not move your tablet during HDR capturing.

Record a video

1. Tap **Camera** to turn on the camera.
2. When you're ready to start recording, tap .
3. While recording, use the following actions:
 - Freely zoom in or out.
 - Change focus to a different subject or area by just tapping it on the Viewfinder screen.
 - Tap the flash icon to turn the flash on or off.
 - Tap  to pause video recording.
 - To capture an image from the video while recording, tap .
4. To stop recording, tap .





Camera scenes

A scene is a collection of settings to suit the lighting and environment. Use Normal and let the camera automatically determine optimal settings, or choose from a wide selection of scenes before you start taking photos. Predefined settings make point-and-shoot photos easier to take.

1. Tap **Camera** to turn on the camera.
2. Tap  to customize your camera.
3. On the pop up window, tap  > **Scene mode**.

Camera and video settings

Before taking photos/recording videos, customise your camera settings.

1. Tap **Camera** to turn on the camera.
2. Tap  to customize your camera.
3. On the pop up window, tap // to switch among general settings, camera and video settings. The available options vary depending on the mode used.
 - **GPS location info:** Attach a GPS location tag to the photo.
 - **Exposure:** This determines how much light the camera's sensor receives. For lowlight situations, use a higher exposure.
 - **Color Effect:** Select among various photo effects that are available.
 - **Scene mode:** Change the scene mode.
 - **White balance:** Select an appropriate white balance, so images have a true-to-life colour range. The settings are designed for specific lighting situations. These settings are similar to the heat range for white-balance exposure in professional cameras.
 - **Image properties:** Sharpen or blur the borders between objects; select appropriate Hue; make colors more or less pronounced; adjust the brightness and contrast.
 - **Anti-flicker:** Select a band to avoid the impacts on photos caused by flickers from lighting sources.
 - **Restore defaults:** Restore to default settings.
 - **Face detection:** Set ideal exposure and clarity of faces.

- **Self timer:** Select a time span for auto photographing.
- **Continuous shot:** set continuous shots.
- **Picture size:** Select the size of picture.
- **Preview size:** Set the preview screen ratio when you are taking a photo.
- **ISO:** Select an ISO value. This controls camera light sensitivity. It is measured in filmcamera equivalents. Low values are for stationary or brightly-lit objects. Higher values are for fast-moving or poorly-lit objects.
- **Face beauty:** Take a photo with lightened faces for gentler images.
- **Microphone:** Enable or disable microphone while recording a video.
- **Audio mode:** Select a audio mode.
- **Time lapse interval:** Set the time lapse interval.
- **Video quality:** Set the quality level for videos.



- To improve GPS signals, avoid shooting in locations where the signal may be obstructed, such as between buildings or in low-lying areas, or in poor weather conditions.
- Your location may appear on your photos when you upload them to the Internet. To avoid this, deactivate the GPS location info.

8. Multimedia

8

Your tablet provides you several entertainment ways. You can view the photos taken by the camera. You can also enjoy music and video playing.

Gallery

Use Gallery to view all your photos and videos that are on your tablet.

- To open your gallery, on the home screen or list menu, tap **Gallery**.



- Some file formats are not supported depending on the software installed on the device.
- Some files may not play properly depending on how they are encoded.

View your photos

View photos in the album

1. On the home screen or list menu, tap **Gallery**.
2. Tap  to open drop-down list, and then tap **Albums**.
3. Browse to an album or a group of photos.
4. Tap a photo to view it in full screen.

View photos by locations

1. On the home screen or list menu, tap **Gallery**.
2. Tap  to open drop-down list, and then tap **Locations**.
3. Pinch the screen or pan across the map until (location indicator) appears. The location indicator shows how many photos are taken in that area. Only photos with geo-tag info appear on the map.
4. Tap the location indicator. The photos taken in the same area are displayed.

View photos by time

View photos and videos based on when they were taken.

1. On the home screen or list menu, tap **Gallery**.
2. Tap  to open drop-down list, and then tap **Times**. Photos and videos stored on your tablet are displayed according to the time they were taken.
3. Tap the sorted photos by a time. All the photos taken around that time are displayed.

Zoom in and out

Use one of the following methods to zoom in an image:

- Double-tap anywhere to zoom in.
- Spread two fingers apart on any place to zoom in. Pinch to zoom out, or double-tap to return.

Start a photo slideshow

1. On the home screen or list menu, tap **Gallery**.
2. Browse to an album or a group of photos.
3. Tap  > **Slideshow**.

Watch a video

1. On the home screen or list menu, tap **Gallery**.
2. In the Gallery app's Album, go to the video that you want to watch.
3. Tap the on-screen controls to control the video playback.



4. Press the volume button to adjust the volume.
5. Tap  to select more options.

Edit your photos

When viewing a photo, tap  and use the following functions:

- **Delete:** Delete the photo.
- **Slideshow:** Start a slideshow with the images in the current folder.
- **Edit:** Launch Paper Artist to edit the photo.
- **Rotate left:** Rotate anticlockwise.
- **Rotate right:** Rotate clockwise.
- **Crop:** Resize the orange frame to crop and save the photo in it.
- **Set picture as:** Set the photo as a wallpaper or a contact image.
- **Details:** Check information of the photo.

Crop a photo



1. On the home screen or list menu, tap **Gallery**.
2. Browse to the photo that you want to edit.
3. Tap  > **Edit**, and then tap  > **Crop**. You'll see a crop box around the photo.
 - Drag the crop box over the part of the photo you want to crop.
 - Press and hold the edge of the crop box, and drag your finger inward or outward to resize the crop box.
4. Tap **Save**.

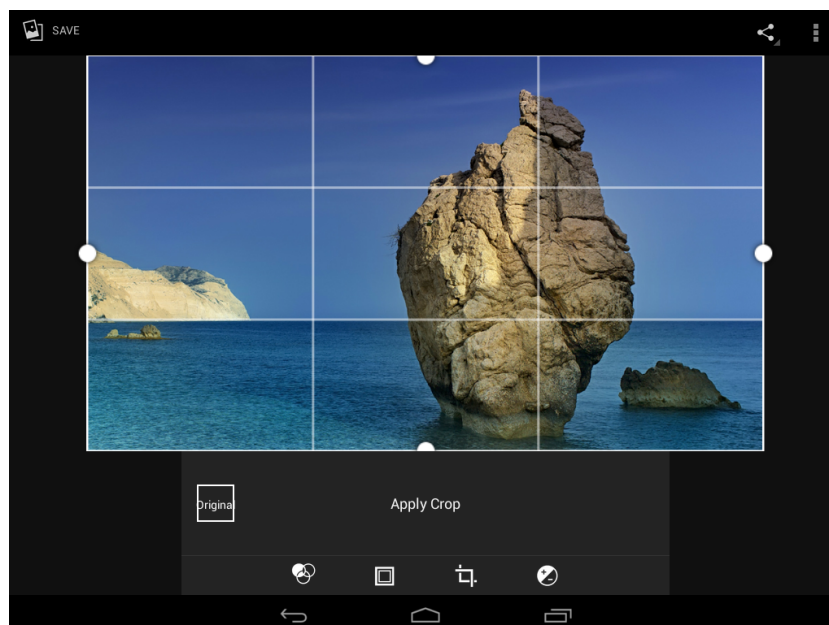

The cropped photo is saved as a copy. The original photo remains unedited.



Add photo effects

1. On the home screen or list menu, tap **Gallery**.
2. Browse to the photo that you want to edit.
3. Tap  > **Edit**, and then tap .
4. Tap an effect to apply to the photo.
5. Tap **Save**.





The enhanced photo is saved as a copy. The original photo remains unedited.

Share your photos

You can share your photos with another device via email, MMS or Bluetooth.



Share photos by Email

1. On the home screen or list menu, tap **Gallery**.
2. Browse to the photo that you want to share.
3. Tap  to open the drop-down list, and then tap **Email**.
4. Choose an Email account.
5. Compose your message.
6. Tap  to send the mail.



If you have multiple email accounts, the default email account will be used.

Share a photo by MMS

1. On the home screen or list menu, tap **Gallery**.
2. Browse to the photo that you want to share.
3. Tap  to open drop-down list, and then tap **Messaging**.
4. Enter a phone number or add a contact from your phonebook.
5. Compose your message.
6. Tap  to send the message.

Share photos via Bluetooth

1. On the home screen or list menu, tap **Gallery**.
2. Browse to the photo that you want to share.
3. Tap  to open drop-down list, and then tap **Bluetooth**.



You'll be asked to turn on Bluetooth and connect to the receiving Bluetooth device, so the files can be sent.

Delete photos

1. On the home screen or list menu, tap **Gallery**.
2. Browse to the photo that you want to delete.
3. Tap , and then tap **delete**.

Set as wallpaper or contact photo

1. On the home screen or list menu, tap **Gallery**.
2. Browse to the photo that you want to set as wallpaper.
3. Tap , and then tap **Set picture as**.
4. Select Wallpaper or Contact photo.
5. You'll see a crop box around the photo.
 - Drag the crop box over the part of the photo you want to crop.
 - Press and hold the edge of the crop box. When directional arrows appear, drag your finger inward or outward to resize the crop box.
6. Tap **OK** to set the photo as your wallpaper or contact photo.

Video player

You can use the video player on your tablet to watch the videos.



Watch a video by using video player

1. On the home screen or list menu, tap **Video Player**.
2. Tap the video that you want to watch.
3. Tap the on-screen controls to control the video playback.
4. Press the volume button to adjust the volume.
5. Tap  to select more options.

Share your videos

You can share your photos with another device via email, MMS or Bluetooth.



Share videos by Email

1. On the home screen or list menu, tap **Video Player**.
2. Tap the video that you want to share.
3. Tap  to open drop-down list, and then tap **Email**.
4. Choose an Email account.
5. Compose your message.
6. Tap  to send the mail.



If you have multiple email accounts, the default email account will be used.

Share a video by MMS

1. On the home screen or list menu, tap **Video Player**.
2. Tap the video that you want to share.
3. Tap  to open drop-down list, and then tap **Messaging**.
4. Enter a phone number or add a contact from your phonebook.
5. Compose your message.
6. Tap  to send the message.

Share videos via Bluetooth

1. On the home screen or list menu, tap **Video Player**.
2. Tap the video that you want to share.
3. Tap  to open drop-down list, and then tap **Bluetooth**.



You'll be asked to turn on Bluetooth and connect to the receiving Bluetooth device, so the files can be sent.

Music player

You can listen to your favourite music with the music player. The Music app is a central hub for your favorite music whether it is on your tablet or streamed through a music service.

- To use the music player, on the home screen or list menu, tap **Music**.



- Some file formats are not supported depending on the device's software version.
- Some files may not play properly depending on the encoding used.

Browse music

1. From the Home screen, tap **Music**.
2. You can:
 - Tap **Artists/Albums/Playlists**, you can browse songs sorted by artists, albums, or playlists.

- Tap **Songs**, browse all songs.
- Tap **Now playing**, check the song is playing now.

Listen to music

1. On the home screen or list menu, tap **Music**.
2. Tap a song from the category.
3. Use the following keys to control playback:

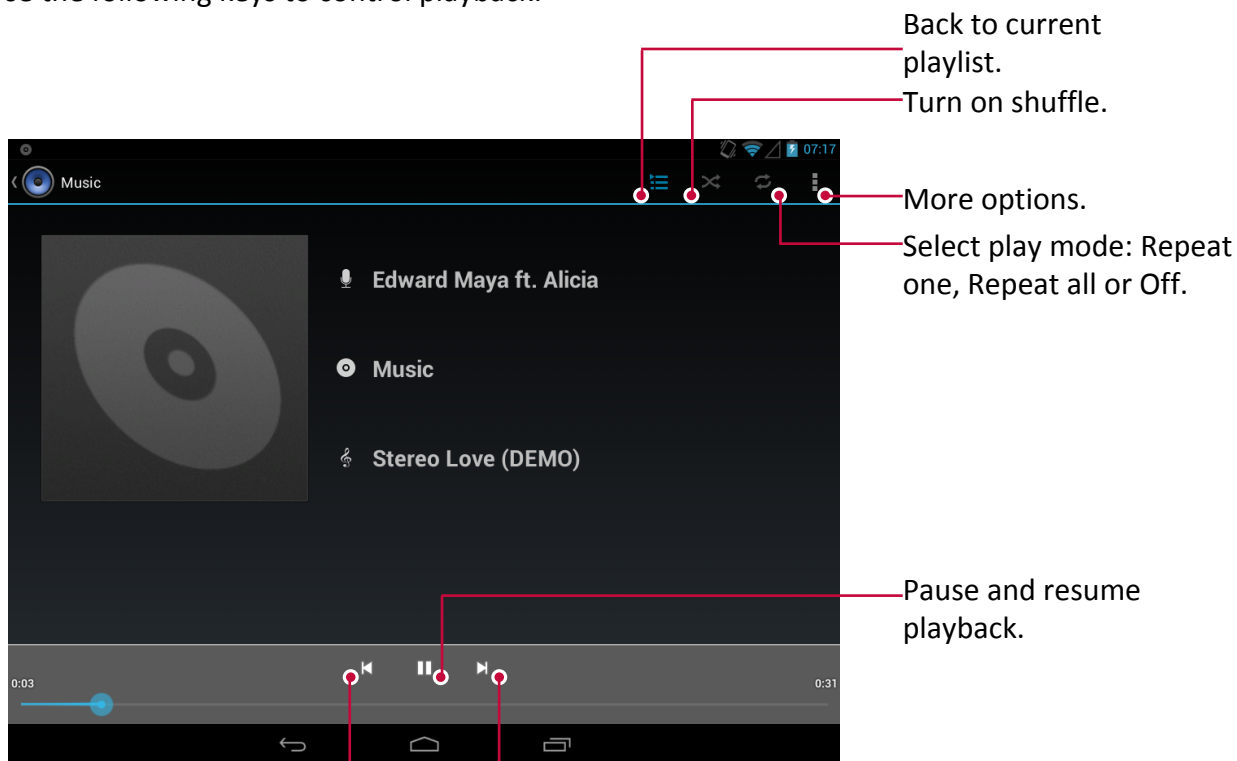

Skip to the previous song.
Tap and hold to move backwards quickly.

Skip to the next song.
Tap and hold to move forwards quickly.

Set a song as ringtone

1. On the home screen or list menu, tap **Music**.
2. Tap a song from the category.
3. Tap  to select **Use as ringtone**.

Your playlist

Create a playlist

You can make your own playlist.

1. On the home screen or list menu, tap **Music**.
2. Tap a song from the category.
3. Tap  to select **Add to playlist**.
4. On the pop up screen, tap **New** to create a new playlist.
5. Enter a title and tap **Save**.

Rename the playlist

1. On the home screen or list menu, tap **Music**.
2. Tap **Playlists** to view all your playlists.
3. Tap and hold the playlist you want to rename.
4. Select **Rename** on the pop up screen.

Delete a playlist

1. On the home screen or list menu, tap **Music**.
2. Tap **Playlists** to view all your playlists.
3. Tap and hold the playlist you want to delete.
4. Select **Delete** on the pop up screen.

Delete a song

1. On the home screen or list menu, tap **Music**.
2. Tap a song from the category.
3. Tap  to select **Delete**.

FM radio

You can listen to radio programs by using your tablet.

- To use the FM radio, on the home screen or list menu, tap **FM Radio**.



You must connect a headset before using the FM radio on your tablet.

Listen to a radio station

1. On the home screen or list menu, tap **FM Radio**.
2. Tap  > **Search**. It starts scanning automatically and save the available channels.
3. Use the following keys to control playback:

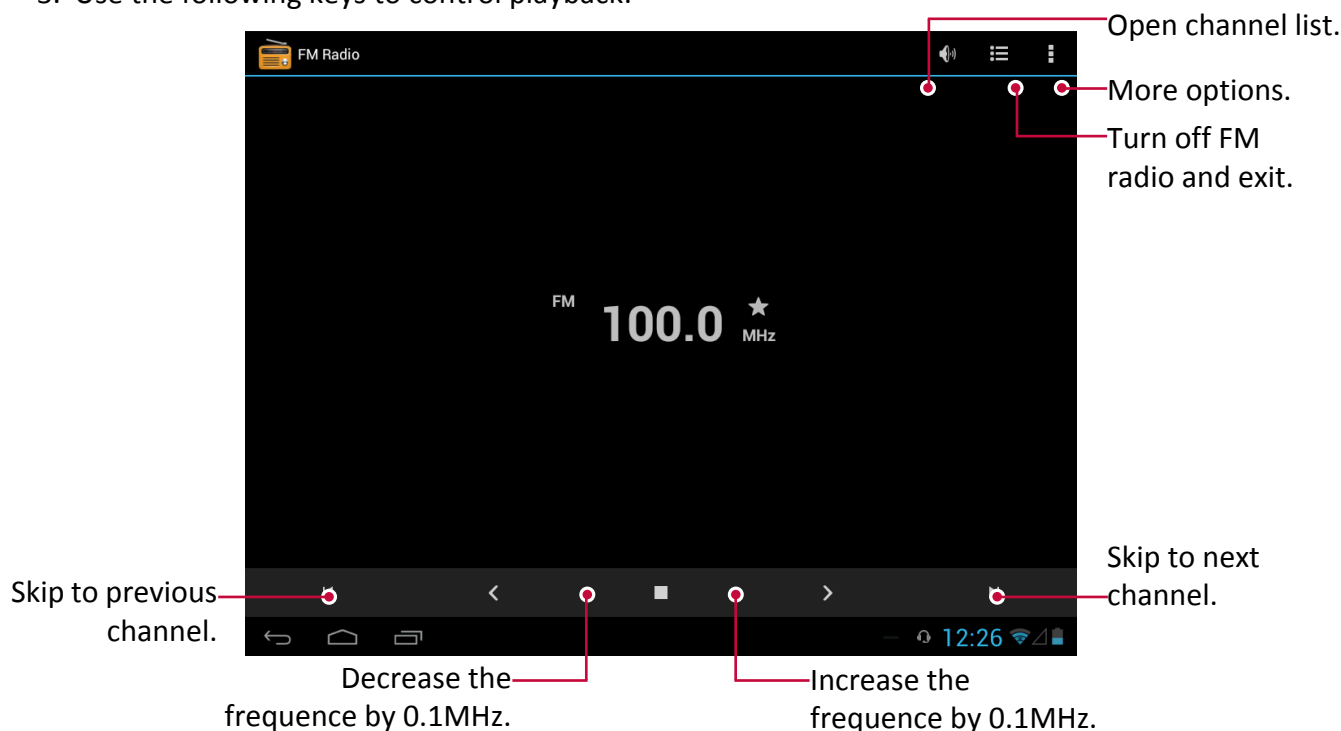



Turn off FM

- You can use other apps while listening to the radio.
- To turn off FM Radio completely, tap .

Record radio programs





You can record a radio program when listen to it.

1. On the home screen or list menu, tap **FM Radio**.
2. Tune to your desired radio station.
3. Tap  > **Record FM**.
4. Tap  to stop recording.
5. Enter a name for the voice and tap **Save**.

Voice recorder

Use Voice Recorder to capture information during lectures, interviews, or even to create your own audio log.

Record a voice memo

1. On the home screen or list menu, tap **Sound Recorder**.
2. Hold the microphone near the sound source.
3. Tap  to start recording a voice clip.
4. Tap  to pause voice recording. (Tap  to resume voice recording.)
5. Tap  to stop recording.
6. Tap **Save**.





Voice Recorder can run in the background while you do other things on your tablet, except when you open other apps that also use audio functions.

Play a voice memo

1. On the home screen or list menu, tap **Sound Recorder**.
2. Tap  to open recording file list.
3. Select your voice memo and tap it.

Delete a voice memo

1. On the home screen or list menu, tap **Sound Recorder**.
2. Tap  to open recording file list.
3. Tap and hold the voice memo you want to delete.
4. Tap  to delete the file.

9. Phone

9

Learn to use calling functions, such as making and answering calls, using options available during a call or customising and using call-related features.

Make a call

1. Tap **Phone** to open the dial pad, enter your number directly. Or enter the first few digits of a phone number, then choose a contact.
2. Tap .

You also can use the following methods to make a call:

- Make a call from the history of incoming and outgoing calls and messages.
- Make a call from the contacts list.
- Make a call from the list of favourite contacts.



The phone dialer's smart dial features makes it quick and easy for you to make a call. Simply enter the phone number or first few letters of the person's name you want to call. Smart dial automatically searches and filters your stored contacts and the phone numbers from the call history.

Answer a call

When you receive a phone call from a contact, the incoming call screen appears. To pick up the phone, do the following:





- Slide  to .



- If there is a headset connected to your tablet, you can pick up a call by pressing the center button of your headset.
- If the call waiting service is active, another call can be made. When the second call is answered, the first call is put on hold.

Reject a call

When a call comes in, do the following to reject the call:

- Slide  to , reject the call immediately.
- Slide  to , you can send a message to the caller or create a task for returning the call.
- Press the Power button or Volume button to mute the ringing sound without rejecting the call.

End a call

Tap  to end a call. Or press the center button of your headset.

Contacts

Contacts are stored in one of the two available phonebooks: SIM phonebook (located on your SIM card, by which the number of entries you can store depends on the card capacity) or the Smart Phonebook (located on your tablet). When adding new contacts, the contacts will only be added to the phonebook you have selected.

View contacts

Do the following methods to view the contact list:

- On the home screen, tap **People**.
- Or on the list menu, tap **People**.

Search for a contact

1. Go to **People** to view the contact list.
2. Scroll up or down the contact list.
3. Tap  and enter the first few letters of the name in the search bar.
4. Select the contact from the option list.

Call a contact

1. Go to **People** to view the contact list.
2. Scroll the list to select your desired contact.
 - Tap the number area to call the contact.
 - Tap  to make a video call with the contact.

Add a new contact

Method one:

1. On the home screen, tap **Phone** to display dial pad.
2. Enter a number, tap  > **Add to contacts**.
3. Tap **Create new contact**, select your desired storage.
4. Add details as desired.
5. Tap **Done** to finish saving.

Method two:

1. Go to **People** to view the contact list.
2. Tap  to add a new contact.



For contacts on the smart phonebook, you can add detailed information, like home number, office number, contact pictures and etc.

My favourites

Add a contact to favourites

You can add your contacts stored on the smart phonebook to your favourites.

1. Search for the desired contact.
2. Tap  to add the contact to your favourites.



View your favourites

1. Go to **People** to view the contact list.
2. Tap  to open drop-down list, and then tap **Favourites**.

Contact groups

You can group your contacts as different groups. For different groups, you can use different identification, and send messages to a group.

Add contacts to a group

1. Go to **People** to view the contact list.
2. Tap  to open drop-down list, and then tap **Groups**.
3. Tap  to add contacts to a group.
4. Enter your group's name, and tap  to add contacts.

Import/Export contacts

1. Go to **People** to view the contact list.
2. Tap  > **Import/export**.
3. Select the contacts storage.
4. Follow the on-screen steps to finish.

Delete contacts

1. Go to **People** to view the contact list.
2. Tap  > **Delete contact**.
3. Choose the desired contacts.
4. Tap **OK** to delete the contacts.

Use speed dial

Use Speed dial to call a phone number with a single tap. For example, if you assign a contact's number to the number 2 key, you can just press and hold 2 to dial the number.



The number 1 key is generally reserved for your voicemail. Press and hold this key to call voicemail and retrieve your voicemail messages.

To assign a contact to a speed-dial key

1. On the home screen, tap **Phone** to display dial pad.
2. Tap  > **Speed dial**.
3. Choose a numeric key.
4. Tap the desired contact from your phonebook.

Call a phone number in a text message

1. Tap the phone number within the message.
2. Tap  to call the number.



To call the message sender, tap  on the top of your screen.

Call a phone number in an email





1. Tap the phone number in the email body.
2. Tap  to call the number.

Set up a conference call

If network applicable, you can make the first call (or accept a call), and then simply dial each subsequent call to add it to the conference.



Make sure your SIM card is enabled with conference calling service. Contact your mobile operator for details.

1. During a call, tap  to enter a phone number or select a contact from your phonebook.
2. Tap  to dial the number.
3. The second number is dialled, and the first call is put on hold at this time.
 - You can tap  to toggle between 2 calls.
 - Tap  to add the contact to a conference call.

Make an emergency call

In some regions, you can make emergency calls even if you don't have a SIM card installed or your SIM card has been blocked.



If you are out of base station coverage, you won't be able to make an emergency call.

1. On the Home screen, tap **Phone** to open the dial pad.
2. Dial the emergency number for your local, and then tap .







In Europe, the standard emergency number is 112; in the UK, it is 999.

10. Messages

10

Messages let you exchange text messages with other SMS and MMS devices via your cellular connection. Your sent and received messages are neatly grouped into conversations, by contact name or phone number.

Send a message

1. On the home screen or list menu, tap **Messaging**.
2. Tap  to start composing a new message.
3. Use the following methods to add recipients:
 - Enter a phone number.
 - Tap , select contacts, and then tap **OK**.
4. Enter the text message in the text box.
5. Tap  to add picture/video/audio/slideshow if you want to send an MMS message.
6. Tap  to send the message.



After finish entering your text, you can just tap  to save the message as a draft.



- There is a limit on the number of characters for a single text message (displayed above the send button). If you exceed the limit, your text message will be delivered as one but will be billed as more than one message.
- Your text message automatically becomes a multimedia message if you enter an email address as the recipient, add a message subject, attach an item, or compose a very long message.

Check your message

Depending on your notification settings, your tablet plays a sound, vibrates, or displays the message briefly in the status bar when you receive a new message. A new message icon is also displayed in the status bar. Incoming messages are grouped into message threads by contact.

Check your text message

- Open the Notifications panel, and then tap the new message notification.
- Go to the Messages app and open the message.

Listen to a voice message



When you received a voice message, check the message and tap  to start voice playback.

Reply to a message

1. On the Messages screen, tap a contact (or phone number) to display the exchange of messages with that contact.
2. In the text box, enter your message.
3. Tap  to send the message.

Forward a message

1. On the Messages screen, tap a contact (or phone number) to view the exchange of message with that contact.
2. Tap and hold a message.
3. In the pop up window (**Message options**), select **Forward**.
4. Use the following methods to add recipients:

- Enter a phone number.
 - Tap , select contacts, and then tap **OK**.
5. Enter more text if you wanted.
 6. Tap  to send the message.

Delete messages

Delete a message

1. On the home screen or list menu, tap **Messaging**.
2. The messages screen displayed.
3. Tap a contact (or phone number) to view the exchange of message with that contact.
4. Tap and hold a message.
5. In the pop up window (**Message options**), select **Delete**.

Delete a conversation

1. On the home screen or list menu, tap **Messaging**.
2. The messages screen displayed.
3. Tap and hold a contact or phone number.
4. Tap  on the bottom of the screen.

Create a conversation shortcut

You can create a shortcut for the conversation, do the following:

1. On the home screen or list menu, tap **Messaging**.
2. The messages screen displayed.
3. Tap and hold a contact or phone number.
4. Tap  on the bottom of the screen.
5. Then you can find the shortcut on your home screen.

WAP push messages

WAP push messages contain a web link. Often, the link will be to download a file that you have requested from a service provider.

When you receive a WAP push message, a notification icon is displayed in the status bar.

Opening and reading a new WAP push message

1. Open the Notifications panel, and then tap the push message notification.
2. Tap **Visit website**.

Viewing all your WAP push messages

1. On the home screen or list menu, tap **Messaging**.
2. Tap  > **Wappush messages**.

11. Bluetooth

11

Your tablet can connect to a compatible Bluetooth device for exchanging data. Bluetooth creates a direct wireless connection between two devices over short distances.



Do not use the Bluetooth feature for illegal purposes (for example, pirating copies of files or illegally tapping communications for commercial purposes).

Turn on or off Bluetooth

1. On the home screen or list menu, tap **Settings**.
2. Tap to turn on or off **Bluetooth**.



You can tap to turn on or off Bluetooth on quick setting list. On home screen, tap upper-right corner to switch to quick setting list, and then tap **Bluetooth**.

Pair with a Bluetooth device

1. On the home screen or list menu, tap **Settings**.
2. Tap to turn on or off **Bluetooth**.
3. A list of available Bluetooth devices appears.
4. Select the device you wish to connect.
5. Tap **Pair**. The pairing is made if your pairing request is accepted by the other part.

Unpair with a Bluetooth device

1. On the home screen or list menu, tap **Settings**.
2. Tap **Bluetooth**.
3. Select the device you want to unpair and then tap
4. Tap **Unpair**.

Receive data via Bluetooth

1. On the home screen or list menu, tap **Settings**.
2. Tap to turn on or off **Bluetooth**.
3. Tap your tablet model to make it visible to all nearby Bluetooth devices.
4. Accept the request and pair with the other Bluetooth device.
5. Slide to open notifications panel, tap **Accept**.



- If you do not use the Bluetooth feature for some time, you should deactivate it in order to conserve battery power.
- The files received via Bluetooth are stored in the Bluetooth folder.

Send data via Bluetooth

1. On the home screen or list menu, tap **Settings**.
2. Tap to turn on or off **Bluetooth**.
3. Pair with a Bluetooth device.
4. Tap **File Manager** on the home screen or list menu.
5. Tap the file you want to share.
6. Tap
 and select Bluetooth.7. Select a device to start sending the file.

12. eReader Prestigio

12

With the eReader Prestigio, you can easily and quickly download and read eBooks on your tablet.

- On the home screen or list menu, tap **eReader Prestigio**.

Your eReader at a glance

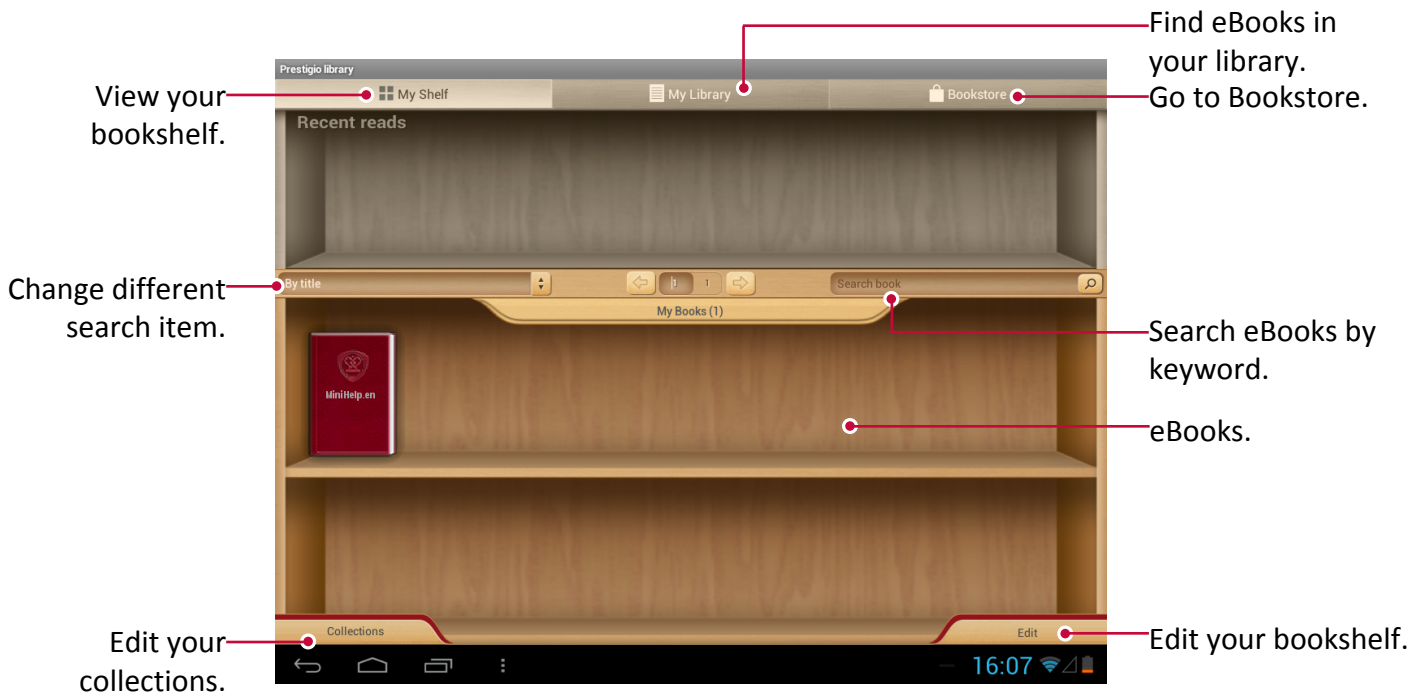

Download an eBook

You can download eBooks by using eReader Prestigio. Some eBooks are free to download, and some eBooks need a payment.





You will be asked to confirm method of payment when you purchase a paid eBook.

1. On the home screen or list menu, tap **eReader Prestigio**.
2. Tap **Bookstore** tab.
3. Select your language, and then find your desired eBook.
4. Tap  to download the eBook.

Read an eBook



1. On the home screen or list menu, tap **eReader Prestigio**.
2. Tap **My shelf** or **My library** tab.
3. Find your desired eBook.
4. Tap the eBook to read it.

Add a bookmark

1. While reading a eBook, tap .
2. Tap , and then tap **New bookmark**.
3. The certain page is added to bookmark.



Open the bookmark

You can continue reading your eBook from the certain page which you have added to bookmark.

1. While reading a eBook, tap .
2. Tap .
3. In **This book** or **All books** tab, tap your desired bookmark.



Search for a content

You can search for a certain content in the eBook, for example, a word, a sentence or a paragraph, etc.

1. While reading a eBook, tap .
2. Tap .
3. Enter a word, a sentence or a paragraph, etc.
4. Tap **Go** in the virtual keyboard to search for the content page by page.

Zoom in and out

While reading an eBook, you can zoom in or out the screen to fit your reading.

1. While reading a eBook, tap .
2. Tap .
3. Tap **Zoom in** or **Zoom out**.

eReader settings

You can set up your eRead Prestigio while reading an eBook.

1. On the home screen or list menu, tap **eReader Prestigio**.
2. Tap **My shelf** or **My library** tab.
3. Find your desired eBook.
4. Tap the eBook to read it.
5. While reading a eBook, tap .
6. Tap **Settings**.
7. Select your desired options.

13. Travel & maps

Use this application to pinpoint the location of your tablet, search for places, or get directions.

13

Find a location

About Locations

Use this application to search for nearby restaurants, banks, bus stops, and more.

- On the home screen or list menu, tap **Local**.



- If you are in an area where there are a lot of surrounding buildings, locations may have a hard time pinpointing your location.
- This application may not be available depending on the region or service provider.

Turn on or off location service

In order to find your location on your tablet, you need to enable location sources.



1. On the home screen or list menu, tap **Settings**.
2. Tap **Location access**.
3. Select or clear the location sources you want to turn on or off.

Find your location

1. On the home screen or list menu, tap **Local**.
2. Your tablet will pinpoint your location.
3. Select a category that you're interested in to see the places that are nearby.



Add a new category

You can add a new category to search for more places nearby quickly.

1. On the home screen or list menu, tap .
2. Tap  > **Add a search**.
3. On the category list, enter a keyword to search into the text field.

Search for a place



You can search for a name of an establishment, street, or city. Suggested matches will be shown while you type.

1. On the home screen or list menu, tap **Local**.
2. Tap .
3. Enter the place you want to search for.
4. Select the desired place in the result list.
 - Tap  to get directions to the place.

Get directions

Get detailed directions to where you want to go.

Get directions from your location

1. On the home screen or list menu, tap **Local**.
2. Tap .
3. Enter the place you want to search for.
4. Select the desired place in the result list.
5. Tap  to get directions to the place.

6. Choose how you want to get to your destination.
7. The map opens showing the route to your destination.

Get directions by setting a start and end location

1. On the home screen or list menu, tap **Local**.
 - Or, tap **Maps** on the home screen or list menu.
2. Tap  to get directions.
3. Choose your start point and end point.
4. The map opens showing the route to your destination.

Navigation

Use this application to search for a route to a destination while driving.



To use navigation, the GPS satellites option in **Settings > Location access** needs to be selected.



This application may not be available depending on the region or service provider.



Navigation maps, your current location, and other navigational data may differ from actual location information. You should always pay attention to road conditions, traffic, and any other factors that may affect your driving. Follow all safety warnings and regulations while driving.

Do the following to start navigation:

- In Locations, tap , and then search for the place you want to go to.
- On the home screen or list menu, tap **Navigation**.

Use Google maps

About Google Maps

Google Maps lets you track your current location and receive detailed directions to your destination. It also provides a search tool where you can locate places of interest or an address on a map, or view locations at street level.



- On the home screen or list menu, tap **Maps**.







- To find your location with Google Maps, you need to enable location sources.
- The Google Maps app does not cover every country or city.

Use Google maps

You can do the following:

- Tap  to search for a place.
- Tap  to get directions.
- Tap  to find your location on the map.

Get help

If you need help or have questions about Maps or Latitude, tap   > **Help** (or   > **Where's Latitude?**).

Maps settings

You can set up the Google maps, tap   > **Settings** while viewing the maps.

14. My files and storage

14

My files

Use this application to access all kinds of files stored on your tablet, including photos, videos, songs, and sound clips.

- On the home screen or list menu, tap **File Manager**.

View my files

1. On the home screen or list menu, tap **File Manager**.
2. Tap to choose a source storage.
3. Select a folder to open it.

Search for a file

1. On the home screen or list menu, tap **File Manager**.
2. Tap to choose a source storage.
3. Tap , and enter key word.
4. Select the desired file or folder in the drop up list.





Add a new folder

1. While viewing a folder or file, tap .
2. Enter a name for the new folder.
3. Tap **OK** to add the folder to the file list.

Manage your files

You can share, copy, move or delete a file in a folder.

While viewing a folder, tap and hold the file. You can do the following selections:

- Tap  to share the file with others.
- Tap  to copy the file.
- Tap  to delete the file.
- Tap  to cut the file to clipboard.
- Tap  to get more options.

Storage

If you connect a Micro SD card to your tablet, there are two source storages: your tablet and the Micro SD card.

Check your storage usage

1. On the home screen or list menu, tap **Settings**.
2. Tap **Storage**.
3. You can check the total space of your tablet's memory and SD card.

Set your preferred install location

1. On the home screen or list menu, tap **Settings**.
2. Tap **Storage**.
3. In **Default write disk** tab, tap to choose your preferred install location.

Erase SD card

1. On the home screen or list menu, tap **Settings**.
2. Tap **Storage**.
3. Select **Erase SD card**.



Formatting a memory card permanently deletes all data from it.



The actual available capacity of the internal memory is less than the specified capacity, because the operating system and default applications occupy part of the memory.

15. Utilities

15

Clock

Use the clock app to set alarms, check the time in any location in the world, measure the duration of an event, or set a timer.

- On the home screen or list menu, tap **Clock**.

World clock



You can add a city to the world clock screen.

1. On the home screen or list menu, tap **Clock**.
2. Tap .
3. Scroll through the list and tap the city that you want to add.

Alarm

You can set up one or more alarms.

Set an alarm



1. On the clock screen, tap .
2. Tap  to add a new alarm.
3. Use the virtual digit keyboard to set the alarm time.
4. Tap **OK**.
5. If you want the alarm for multiple days, tap **Repeat**.

Turn off an alarm



1. On the clock screen, tap .
2. Select the alarm you want to turn off.
3. Drag the check button to Off.

Stop an alarm

When the alarm rings,

- Slide to : The alarm stops.
- Slide to : The alarm will sound again after a specified length of time.



Delete an alarm

1. On the clock screen, tap .
2. Tap and hold the alarm you want to delete.
3. Tap .

Timer

1. On the clock screen, tap .
2. Set the duration, and then tap **Start**.

Stopwatch

- On the clock screen, tap .
- Tap **Start** to time an event.
- Tap  to record lap times.
- Tap  to clear lap time records.

Calendar

You can create your event and make a plan on your calendar.

- On the home screen or list menu, tap **Calendar**.

View the calendar

On the home screen or list menu, tap **Calendar** to check the calendar. Tap  to change your calendar to Day, Week, Month or Agenda view.



Create an event

1. Go to **Calendar**, select a date.
2. Tap  to create a new event.
3. Edit reminder settings.
4. Tap **Done** to save the event.

Manage your events

Edit an event



You can only edit events you have created.

1. While viewing the calendar, tap  to change your calendar to Agenda view.
2. Tap the event you want to edit, and then tap .
3. Make your changes to the event.
4. Tap **Done**.



If you're editing an event that repeats, you'll be asked whether you want to edit just that occurrence or all occurrences of that event.

Delete an event

1. While viewing the calendar, tap  to change your calendar to Agenda view.
2. Tap the event you want to delete, and then tap .





If the event repeats, you'll be asked whether you want to delete just that occurrence or all occurrences from Calendar.

Clear all events

- Go to **Calendar**, and then tap  > **Clear events**.

Share an event

You can share a calendar event as a vCalendar using Bluetooth or by sending it as a file attachment with your email or message.

1. While viewing the calendar, tap  to change your calendar to Agenda view.
2. Tap the event you want to share, and then tap .
3. Choose how you want to send the event.

Calculator

Use this app for simple or complex calculations.

On the home screen or list menu, tap **Calculator**.

- To clear history, tap  > **Clear history**.

ToDo list

Use the ToDo app, you can organize and track to do and task lists.

- On the home screen or list menu, tap **ToDo**.

Create your to-do list

1. On the home screen or list menu, tap **ToDo**.
2. Tap .
3. Edit the title and details, and then set the expire date.
4. Tap **Done** to save the task.



Manage your to-do list

Edit a task

You can only edit tasks you have created.

1. On the home screen or list menu, tap **ToDo**.
2. Tap the event you want to edit.
3. Make your changes to the task.
4. Tap **Done**.

Mark the task as done or undone

- Select the task on the **TODO** category, tap  to mark the task as done.
- Select the task on the **DONE** category, tap  to mark the task as undone.

Delete a task

1. On the home screen or list menu, tap **ToDo**.
2. Tap the task you want to delete, and then tap .

Google search

Use this application to search not only the Internet, but also apps and their contents on your tablet as well.

- On the home screen or list menu, tap **Google**.



Some apps, such as Contacts or Emails, have their own search function, which you can use to search only within those apps.

Search on the web or your tablet

1. Tap the search field, and then enter a keyword.
2. Select one of the suggested keywords that appear.



If no results are returned from the apps, the web browser appears, displaying the search results.

Search with your voice

Use Google Voice Search to find information on the Web just by speaking to your tablet.

1. On the home screen or list menu, tap **Voice Search**.
 - If the Google search bar is available on the Home screen, you can also tap .
2. Speak a keyword or phrase when **Speak now** appears on the screen.
3. Select one of the suggested keywords that appear.
4. If what you're searching for is in the list, tap the item to open it in its compatible app. Otherwise, tap **Retry** to search again.



This application may not be available depending on the region or service provider.

Set search options

1. On the home screen or list menu, tap **Google**.
2. Tap  > **Settings** to set the following options:
 - **Voice**: Set the Google Voice Search language, speech output, and more.
 - **Tablet search**: Select the apps on your tablet which you want included when doing a search.
 - **Privacy & accounts**: Manage your location history, enable recent web searches to show, or clear your search history.

Google Now

Launch Google search to view Google Now cards that show the current weather, public transit info, your next appointment, and more when you are most likely to need it.

Join Google Now when opening Google search for the first time.

To change Google Now settings, tap  > **Settings** > **Google Now**.

16. Set up your tablet

16

Use this app to control and customize tablet settings .

- On the home screen or list menu, tap **Settings**.

Wireless & Networks

SIM management

- Check your SIM card information.
- Set the SIM card for data connection.

Wi-Fi

Activate the Wi-Fi feature to connect to a Wi-Fi network and access the Internet or other network devices.

Bluetooth

Activate the Bluetooth feature to exchange information over short distances.

Data usage

Keep track of your data usage amount, and customise the settings for the limitation.

More...

Set up the following items.

- **Airplane mode**

Activate Flight mode to disable all wireless functions on your device. You can use only nonnetwork features.

Airplane mode disables the wireless features in order to reduce potential interference with aircraft operation and other electrical equipment.

- **VPN**

Set up and manage virtual private networks (VPNs).

- **Tethering & portable hotspot**



- Set to use your device as a wireless modem by making a USB connection with a computer.
- Set to use your device as a wireless access point for other devices.
- Activate the Bluetooth tethering feature to share your mobile network with computers via Bluetooth.

- **Mobile networks**

- Data connection: Use to allow packet switching data networks for network services.
- Data roaming: Use the device to connect to another network when you are roaming or your home network is not available.
- Preferred networks: Selected a preferred network.
- Network mode: Select a network type.
- Access Point Names: Set up access point names (APNs).
- Network operators: Search for available networks and select a network for roaming.

Device

Audio profiles

- Tap  to edit the profiles. Or, tap  to add your customized profiles.
 - Select the profiles of the tablet.
 - Set the volume, type for ringtone and notification.

Display

Change the settings to control the display and backlight on your device.

Storage

View memory information for your device and memory card. You can also format the memory card.



Formatting a memory card permanently deletes all data from it.



The actual available capacity of the internal memory is less than the specified capacity because the operating system and default applications occupy part of the memory.

Battery

View the amount of battery power consumed by your device.

Apps

Manage running applications, move applications to or from the storage card, and install or uninstall programs.

Personal

Location access

Select the sources to use when determining your location.

- Access to my location: Set to use Wi-Fi and/or mobile networks for finding the current location.
- GPS satellites: Set to use the GPS satellite for finding the current location.
- Wi-Fi & mobile network location: Let apps use Google's location service to estimate your location faster.

Security

Set a screen lock or manage the credential storage.

Language & input

Set the operating system language and region. You can also set on-screen keyboard options.

Backup & reset

Change the settings for managing settings and data.

- Back up my data: Set to back up settings and application data to the Google server.
- Backup account: Set up or edit your Google backup account.
- Automatic restore: Set to restore settings and application data when the applications are reinstalled on the device.
- Factory data reset: Reset settings to the factory default values and delete all data.

Accounts

Add and manage your Email, Google, Facebook and Twitter accounts.

System

Date & time

Access and alter the following settings to control how the device displays the time and date.

- Automatic date & time: Automatically update the time and date when moving across time zones.
- Automatic time zone: Set to receive time zone information from the network when you move across time zones.
- Set date: Set the current date manually.
- Set time: Set the current time manually.
- Select time zone: Set the home time zone.
- Use 24-hour format: Display time in 24-hour format.
- Choose date format: Select a date format.

Schedule power on & off

Set the time to power on/off automatically.

Accessibility

Use these settings when you've downloaded and installed an accessibility tool, such as a screen reader that provides voice feedback. You can turn accessibility functions or services on or off.

Developer options

Change the settings for application development.

About tablet

Access device information and update device software. View different information about the tablet, such as the battery, legal information, model number, software version, baseband version and build number.

17. Specifications

17

Item	Specification
Processor	Cortex A7 Quad core
Memory	16GB eMMC+1GB DDR3, Micro SD slot supports up to 32GB
OS	Android 4.2.1
Frequency	1.2GHz
GPU	IMG SGX 55Mtri/s, 1600Mpix/s
Display	8" Ratio 4:3 IPS, Capacitive multi-touch panel (support up to 5 points)
Resolution	1024 x 768 Pixels
Band	WCDMA + GSM (WCDMA: 900/2100; GSM: 850/900/1800/1900)
Interfaces	Micro USB 2.0, Micro SD (micro SDHC compatible)
Communications	WiFi (802.11 b/g/n), 3G(WCDMA)
Bluetooth	Support Bluetooth 4.0
Camera	Front 2M FF, Rear 5.0M AF
G-sensor	Support
GPS	Support
Dimension	204*154*9.6mm
Weight	445g(with battery)

18. Troubleshooting

18

The tablet does not switch on

Remove/reinstall the battery. Then charge the tablet until the battery icon stops scrolling. Unplug the charger and try to switch the tablet on.

The display shows BLOCKED when you switch on the tablet

Somebody tried to use your tablet but didn't know the PIN code nor the unblocking code (PUK). Contact your service provider.

The display shows IMSI failure

This problem is related to your subscription. Contact your operator.

The network symbol is not displayed

The network connection is lost. Either you are in a radio shadow (in a tunnel or between tall buildings) or you are outside the network coverage area. Try from another place, try to reconnect to the network (especially when abroad), or contact your network operator for assistance/information.

The touch screen responds slowly or improperly

If your device has a touch screen and the touch screen is not responding properly, try the following:

- Remove any protective covers from the touch screen. Protective covers may prevent the device from recognising your inputs and are not recommended for touch screen devices.
- Ensure that your hands are clean and dry when tapping the touch screen.
- Restart your device to clear any temporary software bugs.
- Ensure that your device software is upgraded to the latest version.
- If the touch screen is scratched or damaged, take it to your local dealer.

Your battery seems to over heat

You might be using a charger that was not intended for use with your tablet. Make sure you always use the authentic accessory shipped with your tablet.

Your tablet doesn't display the phone numbers of incoming calls

This feature is network and subscription dependent. If the network doesn't send the caller's number, the phone will display Call 1 or Withheld instead. Contact your operator for detailed information on this subject.

You can't send text messages

Some networks don't allow message exchanges with other networks. First check that you have entered the number of your SMS centre, or contact your operator for detailed information on this subject.

You can't receive and/or store JPEG pictures

A picture may not be accepted by your tablet if it is too large, if its name is too long, or if it doesn't have the correct file format.

You feel that you have missed some calls

Check your call divert options.

When charging, the battery icon shows no bar and the outline is flashing

Only charge the battery in an environment where the temperature does not go below 0°C (32°F) or above 50°C (113°F). In other cases please contact your tablet supplier.

The display shows SIM failure

Check that the SIM card has been inserted correctly. If the problem persists, your SIM card may be damaged. Contact your operator.

Your tablet doesn't work well in your car

A car contains many metallic parts that absorb electromagnetic waves which can affect the tablet's performance. A car kit is available to provide you with an external antenna and enables you to make and receive phone calls without handling the handset.

Check with the local authorities whether or not you are allowed to use the tablet while driving.

Your tablet is not charging

If the battery is completely flat, it might take several minutes of precharge (up to 5 minutes in some cases) before the charging icon is displayed on the screen.

The picture captured with the tablet camera is not clear

Make sure that the camera lens on both sides is clean.

When you turn on your device or while you are using the device, it prompts you to enter one of the following codes:

- Password: When the device lock feature is enabled, you must enter the password you set for the device.
- PIN: When using the device for the first time or when the PIN requirement is enabled, you must enter the PIN supplied with the SIM or USIM card. You can disable this feature by using the Lock SIM card menu.
- PUK: Your SIM or USIM card is blocked, usually as a result of entering your PIN incorrectly several times. You must enter the PUK supplied by your service provider.
- PIN2: When you access a menu requiring the PIN2, you must enter the PIN2 supplied with the SIM or USIM card. For details, contact your service provider.

Your device freezes or has fatal errors

If your device freezes or hangs, you may need to close programs or reset the device to regain functionality. If your device is frozen and unresponsive, press and hold the Power button for 8-10 seconds. The device reboots automatically.

If this does not solve the problem, perform a factory data reset. On the list menu, tap Settings > Back up & reset > Factory data reset > Reset device > Erase everything.

Others cannot hear you speaking on a call

- Ensure that you are not covering the built-in microphone.
- Ensure that the microphone is close to your mouth.
- If using a headset, ensure that it is properly connected.

Error messages appear when launching the FM radio

The FM radio application on your tablet uses the headset cable as an antenna. Without a headset connected, the FM radio cannot receive radio stations. To use the FM radio, first ensure that the headset is properly connected. Next, scan for and save the available radio stations.

Another Bluetooth device is not located

- Ensure that the Bluetooth wireless feature is activated on your device.
- Ensure that the Bluetooth wireless feature is activated on the device you wish to connect to, if necessary.
- Ensure that your device and the other Bluetooth device are within the maximum Bluetooth range (10 m).

A connection is not established when you connect the device to a computer

- Ensure that the USB cable you are using is compatible with your device.
- Ensure that you have the proper drivers installed and updated on your computer.
- If you are a Windows XP user, ensure that you have Windows XP Service Pack 3 or higher installed on your computer.
- Ensure that you have Windows Media Player 10 or higher installed on your computer.