

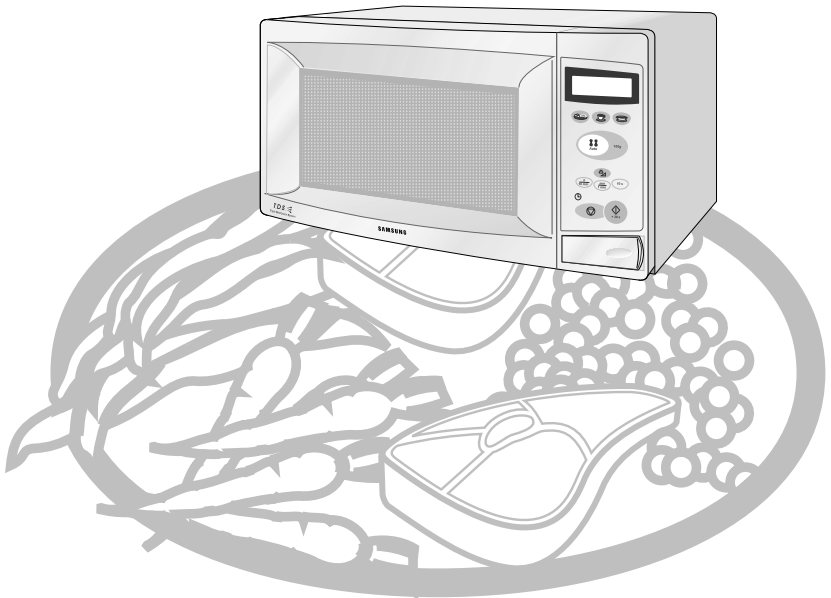

# MICROWAVE OVEN M1638 / M1618

## Owner's Instructions and Cooking Guide



## Quick Look-up Guide (M1638)

### If you want to cook some food

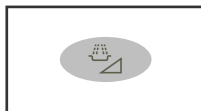

- 1 Place the food in the oven.  
Select the power level by pressing the  button once or more times.

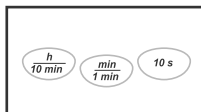

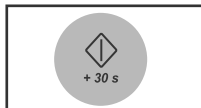

- 2 Select the cooking time by pressing the **10min**, **1min** or **10s** buttons as required.

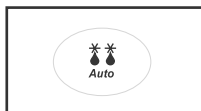

- 3 Press the  button.  
**Result:** Cooking starts.  
The oven beeps four times when cooking is over.

### If you want to defrost some food



- 1 Place the frozen food in the oven.  
Press the **Auto** () button.  
**Result:** The following indication is displayed: 

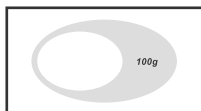

- 2 Select the weight by pressing the **100g** buttons as required.

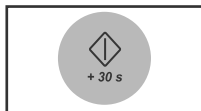

- 3 Press the  button.

### If you want to add an extra minute

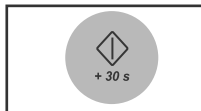

- 1 Leave the food in the oven.  
Press **+30s** once or more times for each extra 30 seconds that you wish to add.

## Quick Look-up Guide (M1618)



### *If you want to cook some food*



- 1 Place the food in the oven.  
Select the power level by rotating the **COOKING POWER CONTROL** knob.



- 2 Select the cooking time by rotating the **TIMER** knob.

### *If you want to defrost some food*

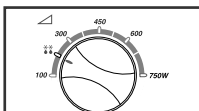

- 1 Turn the **COOKING POWER CONTROL** knob to (  ).



- 2 Turn the **TIMER** knob to select the appropriate time.

### *If you want to adjust the cooking time*



- 1 Leave the food in the oven.  
Turn the **TIMER** knob to desired time.

# Contents

Quick Look-up Guide .....	2
Oven .....	5
Control Panel .....	6
Accessories .....	8
Using this Instruction Booklet .....	9
Safety Precautions .....	10
Installing Your Microwave Oven.....	12
Setting the Time(M1638) .....	12
How a Microwave Oven Works .....	13
Checking that Your Oven is Operating Correctly .....	14
What to Do if You are in Doubt or Have a Problem.....	15
Cooking/Reheating .....	16
Power Levels .....	17
Stopping the Cooking.....	18
Adjusting the Cooking Time .....	18
Using the Instant Reheat Feature .....	19
Instant Reheat Settings .....	20
Using the Auto Defrost Feature (M1638).....	21
Manual Defrosting Food (M1618) .....	21
Auto Defrost Settings (M1638) .....	22
Multistage Cooking (M1638) .....	23
Cookware Guide .....	24
Cooking Guide .....	25
Cleaning Your Microwave Oven.....	32
Storing and Repairing Your Microwave Oven .....	33
Technical Specifications .....	34

# Oven

Model : M1638

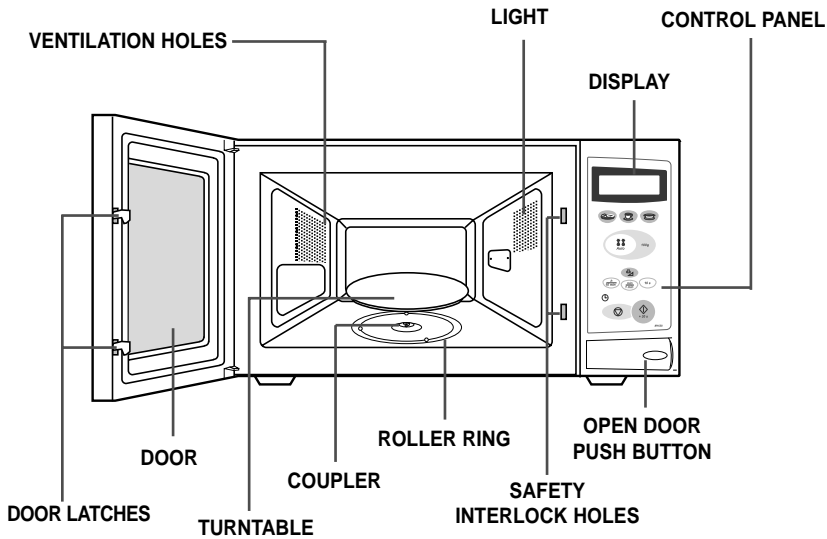

Model : M1618

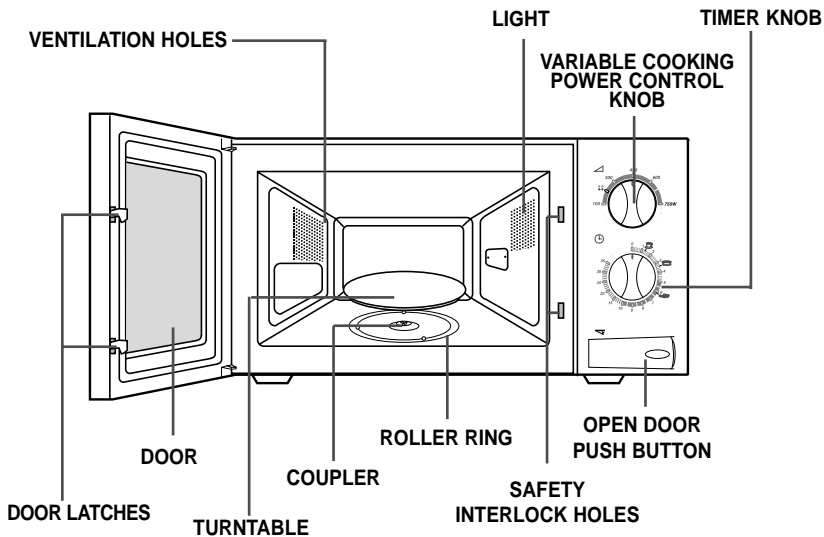

# Control Panel (M1638)

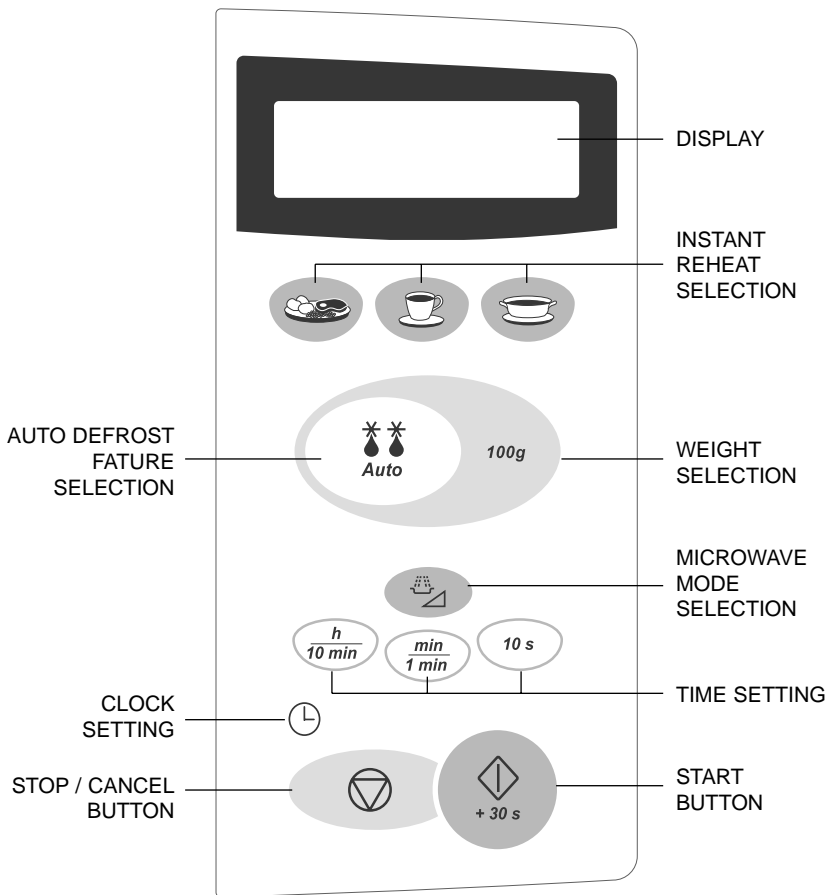

# Control Panel (M1618)

GB

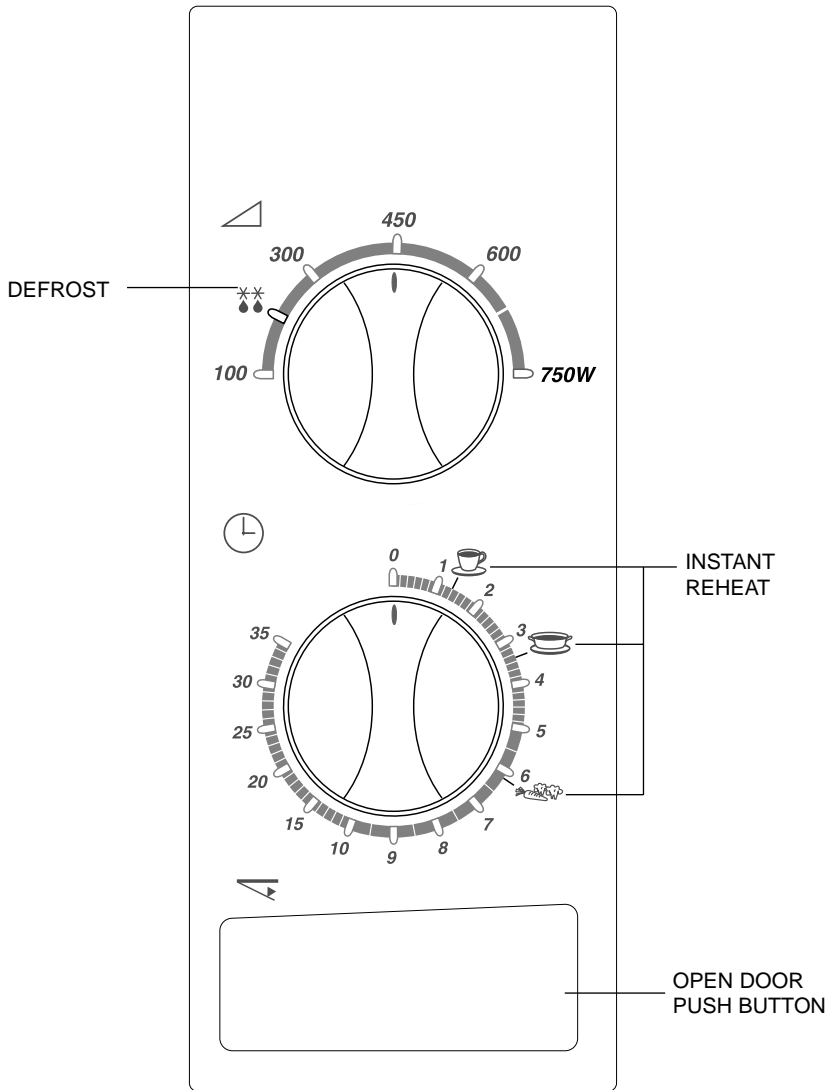

## Accessories

*Depending on the model that you have purchased, you are supplied with several accessories that can be used in a variety of ways.*



**1** **Coupler**, already placed over the motor shaft in the base of the oven.

Purpose: The coupler rotates the turntable.

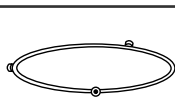

**2** **Roller ring**, to be placed in the centre of the oven.

Purpose: The roller ring supports the turntable.

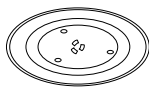

**3** **Turntable**, to be placed on the roller ring with the centre fitting onto the coupler.

Purpose: The turntable serves as the main cooking surface. It can be easily removed for cleaning.



**DO NOT** operate the microwave oven without the roller ring and turntable.

# Using this Instruction Booklet

***You have just purchased a SAMSUNG microwave oven. Your Owner's Instructions contain much valuable information on cooking with your microwave oven:***

- ◆ ***Safety precautions***
- ◆ ***Suitable accessories and cookware***
- ◆ ***Useful cooking tips***

***Inside the cover you will find a quick look-up guide explaining three basic cooking operations:***

- ◆ ***Cooking food***
- ◆ ***Defrosting food***
- ◆ ***Adding extra cooking time***

***At the front of the booklet you will find illustrations of the oven, and more importantly the control panel, so that you can find the buttons more easily.***

***The step-by-step procedures use two different symbols.***



**Important**



**Note**

## ***PRECAUTIONS TO AVOID POSSIBLE EXPOSURE TO EXCESSIVE MICROWAVE ENERGY***

Failure to observe the following safety precautions may result in harmful exposure to microwave energy.

- (a) Under no circumstances should any attempt be made to operate the oven with the door open or to tamper with the safety interlocks (door latches) or to insert anything into the safety interlock holes.
- (b) Do not place any object between the oven door and front face or allow food or cleaner residues to accumulate on sealing surfaces. Ensure that the door and door sealing surfaces are kept clean by wiping after use first with a damp cloth and then with a soft dry cloth.
- (c) Do not operate the oven if it is damaged until it has been repaired by a qualified microwave service technician trained by the manufacturer.

It is particularly important that the oven door closes properly and that there is no damage to the:

- (1) Door, door seals and sealing surfaces
  - (2) Door hinges (broken or loose)
  - (3) Power cable
- (d) The oven should not be adjusted or repaired by anyone other than a properly qualified microwave service technician trained by the manufacturer.

# Safety Precautions

*Before cooking food or liquids in your microwave oven, please check that the following safety precautions are taken.*

1. **DO NOT** use any metallic cookware in the microwave oven:

- ◆ Metallic containers
- ◆ Dinnerware with gold or silver trimmings
- ◆ Skewers, forks, etc.

**Reason:** Electric arcing or sparking may occur and may damage the oven.

2. **DO NOT** heat:

- ◆ Airtight or vacuum-sealed bottles, jars, containers  
Ex) Baby food jars
- ◆ Airtight food.  
Ex) Eggs, nuts in shells, tomatoes

**Reason:** The increase in pressure may cause them to explode.

**Tip:** Remove lids and pierce skins, bags, etc.

3. **DO NOT** operate the microwave oven when it is empty.

**Reason:** The oven walls may be damaged.

**Tip:** Leave a glass of water inside the oven at all times.

The water will absorb the microwaves if you accidentally set the oven going when it is empty.

4. **DO NOT** cover the rear ventilation slots with cloths or paper.

**Reason:** The cloths or paper may catch fire as hot air is evacuated from the oven.

5. **ALWAYS** use oven gloves when removing a dish from the oven.

**Reason:** Some dishes absorb microwaves and heat is always transferred from the food to the dish. The dishes are therefore hot.

6. **DO NOT** touch heating elements or interior oven walls.

**Reason:** These walls may be hot enough to burn even after cooking has finished, although they do not appear to be so. Do not allow inflammable materials to come into contact with any interior area of the oven. Let the oven cool down first.

7. To reduce the risk of fire in the oven cavity:

- ◆ Do not store flammable materials in the oven
- ◆ Remove wire twist ties from paper or plastic bags
- ◆ Do not use your microwave oven to dry newspapers
- ◆ If smoke is observed, keep the oven door closed and switch off or disconnect the oven from the power supply

## Safety Precautions (continued)



8. Take particular care when heating liquids and baby foods.
  - ◆ ALWAYS allow a standing time of at least 20 seconds after the oven has been switched off so that the temperature can equalize.
  - ◆ Stir during heating, if necessary, and ALWAYS stir after heating.
  - ◆ Take care when handling the container after heating. You may burn yourself, if the container is too hot.
  - ◆ A risk of delayed eruptive boiling exists.
  - ◆ To prevent delayed boiling and possible scalding, you should put a plastic spoon or glass stick into the beverages and stir before, during and after heating.

**Reason:** During the heating of liquids the boiling point can be delayed; this means that eruptive boiling can start after the container is removed from the oven. You may scald yourself.
  - ◆ In the event of scalding, follow these FIRST AID instructions:
    - Immerse the scalded area in cold water for at least 10 minutes.
    - Cover with a clean, dry dressing.
    - Do not apply any creams, oils or lotions.
  - ◆ NEVER fill the container to the top and choose a container that is wider at the top than at the bottom to prevent the liquid from boiling over. Bottles with narrow necks may also explode if overheated.
  - ◆ ALWAYS check the temperature of baby food or milk before giving it to the baby.
  - ◆ NEVER heat a baby's bottle with the teat on, as the bottle may explode if overheated.
9. Be careful not to damage the power cable.
  - ◆ Do not immerse the power cable or plug in water and keep the power cable away from heated surfaces.
  - ◆ Do not operate this appliance if it has a damaged power cable or plug.
10. Stand at arm's length from the oven when opening the door.

**Reason:** The hot air or steam released may cause scalding.
11. Keep the inside of the oven clean.

**Reason:** Food particles or spattered oils stuck to oven walls or floor can cause paint damage and reduce the efficiency of the oven.
12. "Clicking" sound might be noticed while operating, especially at defrosting mode.

**Reason:** When the electrical power output is changing, you may hear that sound. This is normal.
13. When the microwave oven is operating without any load, the power will be cut off automatically for safety. You can operate normally after letting it stand for over 30 minutes.

### IMPORTANT SAFETY INSTRUCTIONS

During cooking, you should look into the oven from time to time when food is being heated or cooked in disposable containers of plastic, paper or other combustible materials.

### IMPORTANT

Young children should NEVER be allowed to use or play with the microwave oven. Nor should they be left unattended near the microwave oven when it is in use. Items of interest to children should not be stored or hidden just above the oven.

# Installing Your Microwave Oven

Place the oven on a flat, level surface strong enough to safely bear the weight of the oven.

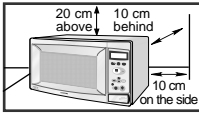

1 When you install your oven, Make sure there is adequate ventilation for your oven by leaving at least 10 cm (4 inches) of space behind, on the sides of the oven and 20 cm (8 inches) of above.

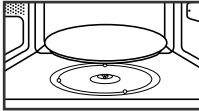

2 Remove all packing materials inside the oven. Install the roller ring and turntable. Check that the turntable rotates freely.

**Never** block the air vents as the oven may overheat and automatically switch itself off. It will remain inoperable until it has cooled sufficiently.

For your personal safety, plug the cable into a 3-pin, 230 Volt, 50Hz, AC earthed socket. If the power cable of this appliance is damaged, it must be replaced by a special cable (I-SHENG SP022, KDK KKP4819D, EUROELECTRIC 3410, SAMIL SP-106B, MOONSUNG EP-48E). Contact your local dealer to have it replaced. The power cable of ISRAEL is PENCON(ZD16A), S/AFRICA APEX LEADS SA16 and NIGERIA, GHANA, KENYA and U.A.E is PENCON(UD13A1).

**Do not** install the microwave oven in hot or damp surroundings like next to a traditional oven or radiator. The power supply specifications of the oven must be respected and any extension cable used must be of the same standard as the power cable supplied with the oven. Wipe the interior and the door seal with a damp cloth before using your microwave oven for the first time.

# Setting the Time (M1638)

Your microwave oven has an inbuilt clock. The time can be displayed in either the 24-hour or 12-hour notation. You must set the clock:

- ◆ When you first install your microwave oven
- ◆ After a power failure

➤ Do not forget to reset the clock when you switch to and from summer and winter time.

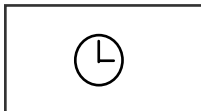

1 To display the time in the... Then press the **L** button...

24-hour notation	Once
12-hour notation	Twice

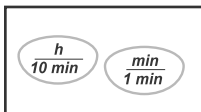

2 Set the hour with the **h** button and the minutes with the **min** buttons.

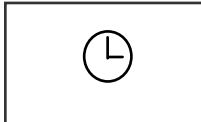

3 When the right time is displayed, press the **L** button again to start the clock.

Result: The time is displayed whenever you are not using the microwave oven.

## How a Microwave Oven Works

**Microwaves are high-frequency electromagnetic waves; the energy released enables food to be cooked or reheated without changing either the form or the colour.**

**You can use your microwave oven to:**

- ◆ Defrost
- ◆ Instant Reheat
- ◆ Cook

### ***Cooking Principle***

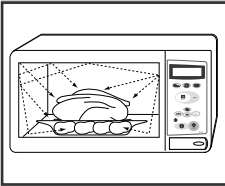

- 1 The microwaves generated by the magnetron are distributed uniformly as the food rotates on the turntable. The food is thus cooked evenly.
- 2 The microwaves are absorbed by the food up to a depth of about 1 inch (2.5 cm). Cooking then continues as the heat is dissipated within the food.
- 3 Cooking times vary according to the recipient used and the properties of the food:
  - ◆ Quantity and density
  - ◆ Water content
  - ◆ Initial temperature (refrigerated or not)



As the centre of the food is cooked by heat dissipation, cooking continues even when you have taken the food out of the oven. Standing times specified in recipes and in this booklet must therefore be respected to ensure:

- ◆ Even cooking of the food right to the centre
- ◆ The same temperature throughout the food

## Checking that Your Oven is Operating Correctly

The following simple procedure enables you to check that your oven is working correctly at all times.

First, place a bowl of water on the turntable.

### Model : M1638

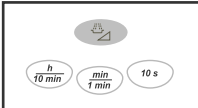

1 Press the  button and set the time to 4-5 minutes by pressing the **1min** button the appropriate number of times.



2 Press  button.

Result: The oven heats the water for 4 to 5 minutes.  
The water should then be boiling.

### Model : M1618

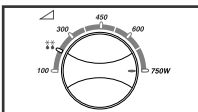

1 Set the power level to maximum by turning **COOKING POWER CONTROL** knob.

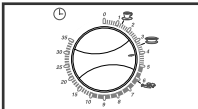

2 Set the time 4 to 5 minutes by turning the **TIMER** knob.



The oven must be plugged into an appropriate wall socket. The turntable must be in position in the oven. If a power level other than the maximum is used, the water takes longer to boil.

## What to Do if You are in Doubt or Have a Problem

*If you have any of the problems listed below try the solutions given.*

- This is normal.
    - Condensation inside the oven
    - Air flow around the door and outer casing
    - Light reflection around the door and outer casing
    - Steam escaping from around the door or vents
  - The oven does not start when you press the ◊ button.(M1638)
    - Is the door completely closed?
  - The oven does not start when you turn the TIMER knob.(M1618)
    - Is the door completely closed?
  - The food is not cooked at all
    - Have you set the timer correctly and/or pressed the ◊ button?(M1638)
    - Have you set the timer correctly? (M1618)
    - Is the door closed?
    - Have you overloaded the electric circuit and caused a fuse to blow or a breaker to be triggered?
  - The food is either overcooked or undercooked
    - Was the appropriate cooking length set for the type of food?
    - Was an appropriate power level chosen?
  - Sparking and cracking occur inside the oven (arcing)
    - Have you used a dish with metal trimmings?
    - Have you left a fork or other metal utensil inside the oven?
    - Is aluminium foil too close to the inside walls?
  - The oven causes interference with radios or televisions
    - Slight interference may be observed on televisions or radios when the oven is operating. This is normal. To solve this problem, install the oven away from televisions, radios and aerials.
    - If interference is detected by the oven's microprocessor, the display may be reset. To solve this problem, disconnect the power plug and reconnect it. Reset the time.(M1638)
- If the above guidelines do not enable you to solve the problem, contact your local dealer or SAMSUNG after-sales service.



## Cooking / Reheating

The following procedure explains how to cook or reheat food.  
**ALWAYS check your cooking settings before leaving the oven unattended.**

First, place the food in the centre of the turntable. Close the door

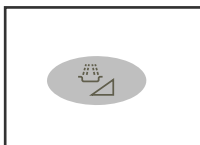
### Model : M1638



- 1 Press the  button.  
**Result:** The 750W (maximum cooking power) indications are displayed: Select the appropriate power level by pressing the  button again until the corresponding wattage is displayed. Refer to the power level table on the next page.

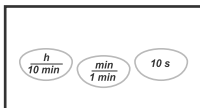

- 2 Set the cooking time by pressing the **10min**, **1min** and **10s** buttons.

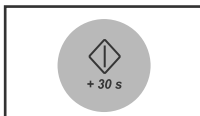

- 3 Press the  button.  
**Result:** The oven light comes on and the turntable starts rotating. Cooking starts and when it has finished the oven beeps four times.



**Never** switch the microwave oven on when it is empty.



If you wish to heat a dish for a short period of time at maximum power(750W), simply press the **+30s** button once for each 30 seconds of cooking time. The oven starts immediately.

### Model : M1618

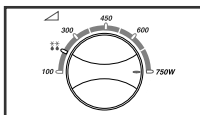

- 1 Set the power level to maximum by turning **COOKING POWER CONTROL** knob.  
**(MAXIMUM POWER : 750 W)**

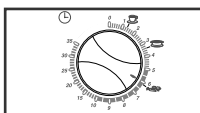

- 2 Set the time by turning **TIMER** knob.  
**Result:** The oven light comes on and the turntable starts rotating.



**Never** switch the microwave oven on when it is empty



You can change the power level during cooking by turning the **COOKING POWER CONTROL** knob.

## Power Levels

*You can choose among the power levels below.*



Power Level	Output	
	M1638	M1618
HIGH	750 W	750 W
MEDIUM HIGH	600 W	600 W
MEDIUM	450 W	450 W
MEDIUM LOW	300 W	300 W
DEFROST(❄️)	180 W	180 W
LOW / KEEP WARM	100 W	100 W

- 
- ◆ If you select higher power level, the cooking time must be decreased.
  - ◆ If you select lower power level, the cooking time must be increased.

## Stopping the Cooking

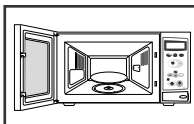

*You can stop cooking at any time to check the food.*

Model : M1638

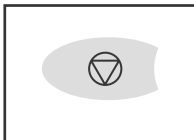

- 1 To stop temporarily;  
Open the door.  
**Result:** Cooking stops. To resume cooking, close the door and press  again.



- 2 To stop Completely;  
Press the  button.  
**Result:** The cooking stops.  
If you wish to cancel the cooking settings, press the **Cancel**() button again.



You can also cancel any setting before starting by simply pressing **Cancel** () button.

Model : M1618

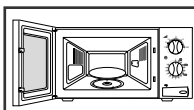

- 1 To stop temporarily;  
Open the door.  
**Result:** Cooking stops. To resume cooking, close the door.

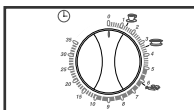

- 2 To stop completely;  
Turn the **TIMER** knob to "0".

## Adjusting the Cooking Time

Model : M1638

*You can increase the cooking time by pressing the **+30s** button once for each 30 seconds to be added.*

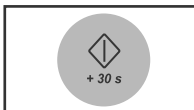

Press the **+30s** button once for each 30 seconds to be added.

Model : M1618



Adjust the remaining cooking time by rotating the **TIMER** knob

# Using the Instant Reheat Feature

Model : M1638

With the Instant Reheat feature, the cooking time is set automatically and you do not have to press the  button. You can adjust the number of servings by pressing the appropriate Instant Reheat button the required number of times.

First, place the food in the centre of the turntable and close the door.

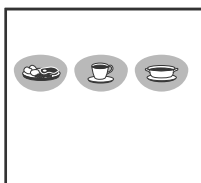

Press the **Instant Reheat** button which you want the required number of times

**Result:** Cooking starts after about two seconds. When it has finished:

- 1) The oven beeps four times.
- 2) The end reminder signal will beep 3 times (once every minute).
- 3) The current time is displayed again.

**Example:** Press the  button three times to reheat three cups of coffee. Refer to the table below.

➤ Use only recipients that are microwave-safe.

Model : M1618

First, place the food in the centre of the turntable and close the door.

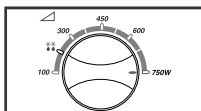

1 Turn the **COOKING POWER CONTROL** knob to Max Power.

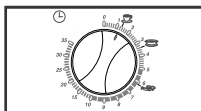



2 Turn the **TIMER** knob to select Instant Reheat.  
(drinks or soup/sauce, fresh vegetables).

➤ Use only recipients that are microwave-safe.



## Instant Reheat Settings (M1638)

The following table presents the various Instant Reheat Programmes, quantities, standing times and appropriate recommendations.

Button	Serving Type	Serving Size	Standing Time	Recommendations
	<b>Ready Meal</b> Chilled	300-350 g	2 mins	Put the meal on a ceramic plate and cover it with microwave cling film. This programme is suitable for the meals consisting of 3 components e.g. meat with sauce, vegetables and side dishes like potatoes, rice or pasta.
	<b>Drinks</b> Coffee, milk, tea, water	150 ml(1cup) 300 ml(2cups) 450 ml(3cups)	1-2 mins	Pour the liquid into ceramic cups and reheat uncovered. Place 1 cup in the centre, 2 cups opposite of each other and 3 or 4 cups in a circle. Leave them to stand in the microwave oven. Stir the drinks before and after standing time and be careful while taking the cups out (see safety instructions for liquids).
	<b>Soup/Sauce</b> Chilled	200 - 250 ml 400 - 450 ml	2 mins	Pour the soup/sauce into a deep ceramic soup plate or bowl and cover during heating and standing time. Stir before and after standing time.

## Instant Reheat Setting (M1618)

Here are a few tips and recommendations to be followed when reheating food with the Instant Reheat Feature.

Symbol	Serving Type	Serving Size	Cooking Time	Standing Time
	Drinks	150 ml	1 min 20 sec	1-2 mins
	Soup/Sauce	200-250 ml	3 min 25 sec	2-3 mins
	Fresh vegetables	300 - 350 g	6 min 10 sec	3 mins

## Using the Auto Defrost Feature (M1638)

*The Auto Defrost feature enables you to defrost meat, poultry, fish.  
The defrost time and power level are set automatically.  
You simply select the programme and the weight.*

GB

➤ Use only dishes that are microwave-safe.

**First, place the frozen food in the centre of the turntable and close the door.**



1 Press the **Auto**() button.

Result: The following indication is displayed: 

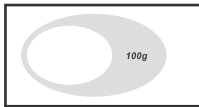

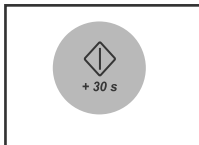

2 Select the food weight by pressing the **100g** button.  
It is possible to set up to a maximum of 1500 g.



3 Press  button.

Result:  Defrosting begins.

 The oven beeps halfway through defrosting to remind you to turn the food over.

 Press  again to finish defrosting

➤ You can also defrost food manually. To do so, select the microwave cooking/reheating function with a power level of 180W. Refer to the section entitled "Cooking/Reheating" on page 16 for further details.

## Manual Defrosting Food (M1618)

*The Defrost feature enables you to defrost meat, poultry, fish.*

**First, place the frozen food in the centre of the turntable and close the door.**

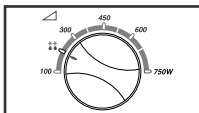

1 Turn the **COOKING POWER CONTROL** knob to 180 W() .

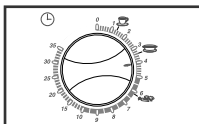

2 Turn the **TIMER** knob to select the appropriate time.

Result: Defrosting begins.

➤ Use only recipients that are microwave-safe.

## Auto Defrost Settings (M1638)

*Remove all kinds of package material before defrosting.*

*Place the frozen foods on a turntable.*

*Turn the food over when the oven beeps.*

*Keep the standing time of corresponding food after Auto Defrosting being finished.*

<i>Food</i>	<i>Portion</i>	<i>Standing Time</i>	<i>Recommendation</i>
Meat	200-1500g	20-60min.	Shield the edges with aluminium foil.
Poultry	200-1500g	20-60min.	Turn the food over when the oven beeps.
Fish	200-1500g	20-50min.	



Select the defrosting function with a power level of 180W if you want to defrost food manually.

For further details on Manual defrosting and defrosting time, refer to the page 30.

# Multistage Cooking (M1638)

Your microwave oven can be programmed to cook food in up to three stages.

**Example :** You wish to defrost food and cook it without having to reset the oven after each stage. You can thus defrost and cook a 500g fish in three stages:

◆ **Defrosting**

◆ **Cook I**

◆ **Cook II**

- \* You can set between two and three stages in multistage cooking.
- \* If you set three stage, the first stages must be defrosting and the second stage must be a standing time.
- \* Don't press  button until you've set the final stage.

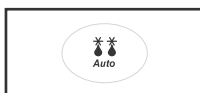

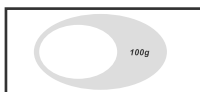

1 Press the **Auto**() button.

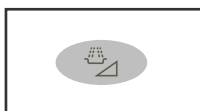

2 Set the weight by pressing the **100 g** buttons the appropriate number of times (500g in the example).



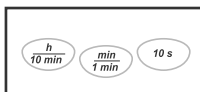

3 Press the  button.  
The microwave mode(I) ;if necessary, set the power level by pressing the  button again one or more times. (600W in the example)



4 Set the cooking time by pressing the **10min**, **1min** and **10s** buttons the appropriate number of times (4 minutes in the example).



5 Press the  button.  
The microwave mode(II) ;if necessary, set the power level by pressing the  button again one or more times. (450W in the example)

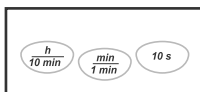

6 Set the cooking time by pressing the **10min**, **1min** and **10s** buttons the appropriate number of times (5 minutes in the example).

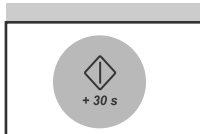

7 Press  button.  
**Result:** The three modes [defrosting and cooking(I,II)] are selected one after the other. According to the defrosting mode that you have chosen, the oven may beep half way through defrosting to remind you to turn the food over.  
◆ When cooking is over, the oven beeps four times.

## Cookware Guide

*To cook food in the microwave oven, the microwaves must be able to penetrate the food, without being reflected or absorbed by the dish used.*

*Care must therefore be taken when choosing the cookware. If the cookware is marked microwave-safe, you do not need to worry.*

*The following table lists various types of cookware and indicates whether and how they should be used in a microwave oven.*

Cookware	Microwave-Safe	Comments
<b>Aluminium foil</b>	✓ X	Can be used in small quantities to protect areas against overcooking. Arcing can occur if the foil is too close to the oven wall or if too much foil is used.
<b>Browning plate</b>	✓	Do not preheat for more than eight minutes.
<b>China and earthenware</b>	✓	Porcelain, pottery, glazed earthenware and bone china are usually suitable, unless decorated with a metal trim.
<b>Disposable polyester cardboard dishes</b>	✓	Some frozen foods are packaged in these dishes.
<b>Fast-food packaging</b>		
• Polystyrene cups and containers	✓	Can be used to warm food. Overheating may cause the polystyrene to melt.
• Paper bags or newspaper	X	May catch fire.
• Recycled paper or metal trims	X	May cause arcing.
<b>Glassware</b>		
• Oven-to-table ware	✓	Can be used, unless decorated with a metal trim.
• Fine glassware	✓	Can be used to warm foods or liquids. Delicate glass may break or crack if heated suddenly.
• Glass jars	✓	Must remove the lid. Suitable for warming only.
<b>Metal</b>		
• Dishes	X	May cause arcing or fire.
• Freezer bag twist ties	X	
<b>Paper</b>		
• Plates, cups, napkins and Kitchen paper	✓	For short cooking times and warming. Also to absorb excess moisture.
• Recycled paper	X	May cause arcing.
<b>Plastic</b>		
• Containers	✓	Particularly if heat-resistant thermoplastic. Some other plastics may warp or discolour at high temperatures. Do not use Melamine plastic.
• Cling film	✓	Can be used to retain moisture. Should not touch the food. Take care when removing the film as hot steam will escape.
• Freezer bags	✓ X	Only if boilable or oven-proof. Should not be airtight. Prick with a fork, if necessary.
<b>Wax or grease-proof paper</b>	✓	Can be used to retain moisture and prevent spattering.

# Cooking Guide

## MICROWAVES

Microwave energy actually penetrates food, attracted and absorbed by its water, fat and sugar content.

The microwaves cause the molecules in the food to move rapidly. The rapid movement of these molecules creates friction and the resulting heat cooks the food.

## COOKING

### Cookware for microwave cooking:

Cookware must allow microwave energy to pass through it for maximum efficiency. Microwaves are reflected by metal, such as stainless steel, aluminium and copper, but they can penetrate through ceramic, glass, porcelain and plastic as well as paper and wood. So food must never be cooked in metal containers.

### Foods suitable for microwave cooking:

Many kinds of food are suitable for microwave cooking, including fresh or frozen vegetables, fruit, pasta, rice, grains, beans, fish, and meat. Sauces, custard, soups, steamed puddings, preserves, and chutneys can also be cooked in a microwave oven. Generally speaking, microwave cooking is ideal for any food that would normally be prepared on a hob. Melting butter or chocolate, for example (see the chapter with special hints).

### Covering during cooking

To cover the food during cooking is very important, as the evaporated water rises as steam and contributes to cooking process. Food can be covered in different ways: e.g. with a ceramic plate, plastic cover or microwave suitable cling film.

### Standing times

After cooking is over the standing time is important to allow the temperature to even out within the food.

## Cooking Guide for frozen vegetables

Use a suitable glass pyrex bowl with lid. Cook covered for the minimum time - see table. Continue cooking to get the result you prefer.

Stir twice during cooking and once after cooking. Add salt, herbs or butter after cooking. Cover during standing time.

Food	Portion	Power	Time (min.)	Standing Time (min.)	Instructions
Spinach	150 g	600 W	5-5 1/2	2-3	Add 15 ml (1 tablespoon) cold water.
Broccoli	300 g	600 W	9 1/2-10 1/2	2-3	Add 15 ml (1 tbsp.) cold water.
Peas	300 g	600 W	8 1/2-9	2-3	Add 15 ml (1 tbsp.) cold water.
Green Beans	300 g	600 W	10-11	2-3	Add 15 ml (1 tbsp.) cold water.
Mixed Vegetables (carrots/peas/corn)	300 g	600 W	8 1/2 - 9 1/2	2-3	Add 15 ml (1 tbsp.) cold water.
Mixed Vegetables (Chinese style)	300 g	600 W	8-9	2-3	Add 15 ml (1 tbsp.) cold water.

# Cooking Guide

## Cooking Guide for fresh vegetables

Use a suitable glass pyrex bowl with lid. Add 30-45 ml cold water (2-3 tbsp.) for every 250 g unless another water quantity is recommended - see table. Cook covered for the minimum time - see table. Continue cooking to get the result you prefer. Stir once during and once after cooking. Add salt, herbs or butter after cooking. Cover during a standing time of 3 minutes.

Hint: Cut the fresh vegetables into even sized pieces. The smaller they are cut, the quicker they will cook.

**All fresh vegetables should be cooked using full microwave power (750 W).**

Food	Portion	Time (min.)	Standing Time (min.)	Instructions
Broccoli	250 g 500 g	4 1/2-5 8-8 1/2	3	Prepare even sized florets. Arrange the stems to the centre.
Brussels Sprouts	250 g	6-7	3	Add 60-75 ml (5-6 tbsp.) water.
Carrots	250 g	4 1/2-5	3	Cut carrots into even sized slices.
Cauliflower	250 g 500 g	5-5 1/2 8 1/2-9	3	Prepare even sized florets. Cut big florets into halves. Arrange stems to the centre.
Courgettes	250 g	3 1/2-4	3	Cut courgettes into slices. Add 30 ml (2 tbsp.) water or a knob of butter. Cook until just tender.
Egg Plants	250 g	4 1/2-5	3	Cut egg plants into small slices and sprinkle with 1 tablespoon lemon juice.
Leeks	250 g	5-5 1/2	3	Cut leeks into thick slices.
Mushrooms	125 g 250 g	1 1/2-2 3 1/2-4	3	Prepare small whole or sliced mushrooms. Do not add any water. Sprinkle with lemon juice. Spice with salt and pepper. Drain before serving.
Onions	250 g	5 1/2-6	3	Cut onions into slices or halves. Add only 15 ml (1 tbsp.) water.
Pepper	250 g	4 1/2-5	3	Cut pepper into small slices.
Potatoes	250 g 500 g	4 1/2-5 1/2 8-9	3	Weigh the peeled potatoes and cut them into similar sized halves or quarters.
Turnip Cabbage	250 g	5-5 1/2	3	Cut turnip cabbage into small cubes.

# Cooking Guide

## Cooking Guide for rice and pasta

**Rice :** Use a large glass pyrex bowl with lid - rice doubles in volume during cooking. Cook covered.  
After the cooking time is over, stir before standing time and salt or add herbs and butter.  
Remark: the rice may not have absorbed all water after the cooking time is finished.

**Pasta :** Use a large glass pyrex bowl. Add boiling water, a pinch of salt and stir well. Cook uncovered.  
Stir occasionally during and after cooking. Cover during standing time and drain thoroughly afterwards.

Food	Portion	Power	Time (min.)	Standing Time (min.)	Instructions
White Rice (parboiled)	250 g	750 W	17-18	5	Add 500 ml cold water.
Brown Rice (parboiled)	250 g	750 W	22-23	5	Add 500 ml cold water.
Brown Rice	250 g	750 W	22-23	10	Add 600 ml cold water.
Mixed Rice (rice + wild rice)	250 g	750 W	18-19	5	Add 500 ml cold water.
Mixed Corn (rice + grain)	250 g	750 W	19-20	5	Add 400 ml cold water.
Pasta	250 g	750 W	11-12	5	Add 1000 ml hot water.

# Cooking Guide

## REHEATING

Your microwave oven will reheat food in a fraction of the time that conventional ovens and hobs normally take.

Use the power levels and reheating times in the following chart as a guide. The times in the chart consider liquids with a room temperature of about +18 to +20°C or a chilled food with a temperature of about +5 to +7°C.

### Arranging and covering

Avoid reheating large items such as joint of meat - they tend to overcook and dry out before the centre is piping hot. Reheating small pieces will be more successful.

### Power levels and stirring

Some foods can be reheated using 750 W power while others should be reheated using 600 W, 450 W or even 300 W.

Check the tables for guidance. In general, it is better to reheat food using a lower power level, if the food is delicate, in large quantities, or if it is likely to heat up very quickly (mince pies, for example).

Stir well or turn food over during reheating for best results. When possible, stir again before serving.

Take particular care when heating liquids and baby foods. To prevent eruptive boiling of liquids and possible scalding, stir before, during and after heating. Keep them in the microwave oven during standing time. We recommend putting a plastic spoon or glass stick into the liquids. Avoid overheating (and therefore spoiling) the food.

It is preferable to underestimate cooking time and add extra heating time, if necessary.

### Heating and standing times

When reheating food for the first time, it is helpful to make a note of the time taken - for future reference.

Always make sure that the reheated food is piping hot throughout.

Allow food to stand for a short time after reheating - to let the temperature even out.

The recommended standing time after reheating is 2-4 minutes, unless another time is recommended in the chart..

Take particular care when heating liquids and baby food. See also the chapter with the safety precautions.

## REHEATING LIQUIDS

Always allow a standing time of at least 20 seconds after the oven has been switched off to allow the temperature to even out. Stir during heating, if necessary, and ALWAYS stir after heating. To prevent eruptive boiling and possible scalding, you should put a spoon or glass stick into the beverages and stir before, during and after heating.

## REHEATING BABY FOOD

**BABY FOOD:** Empty into a deep ceramic plate. Cover with plastic lid. Stir well after reheating! Let stand for 2-3 minutes before serving. Stir again and check the temperature. Recommended serving temperature: between 30-40°C.

**BABY MILK:** Pour milk into a sterilised glass bottle. Reheat uncovered. Never heat a baby's bottle with teat on, as the bottle may explode if overheated. Shake well before standing time and again before serving! Always carefully check the temperature of baby milk or food before giving it to the baby. Recommended serving temperature: ca. 37°C.

### REMARK:

Baby food particularly needs to be checked carefully before serving to prevent burns. Use the power levels and times in the next table as a guide lines for reheating.

# Cooking Guide

## Reheating Liquids and Food

Use the power levels and times in this table as a guide lines for reheating.

Food	Portion	Power	Time (min.)	Standing Time (min.)	Instructions
Drinks (coffee, tea and water)	150 ml (1 cup) 300 ml (2 cups) 450 ml (3 cups)	750 W	1½ 2½ 3½	1 - 2	Pour into cups and reheat uncovered: 1 cup in the centre, 2 cups opposite of each other, 3 cups in a circle. Keep in microwave oven during standing time and stir well.
Soup (chilled)	250 g 450 g	750 W	3 - 3 ½ 4 ½ - 5	2 - 3	Pour into a deep ceramic plate. Cover with plastic lid. Stir well after reheating. Stir again before serving.
Stew (chilled)	350 g	600 W	6 - 7	2 - 3	Put stew in a deep ceramic plate. Cover with plastic lid. Stir occasionally during reheating and again before standing and serving.
Pasta with sauce (chilled)	350 g	600 W	4 ½ - 5 ½	3	Put pasta (e.g. spaghetti or egg noodles) on a flat ceramic plate. Cover with microwave cling film. Stir before serving.
Filled pasta with sauce (chilled)	350 g	600 W	5 ½ - 6 ½	3	Put filled pasta (e.g. ravioli, tortellini) in a deep ceramic plate. Cover with plastic lid. Stir occasionally during reheating and again before standing and serving.
Plated Meal (chilled)	350 g 450 g	600 W	6 - 7 7 - 8	3	Plate a ready-to heat meal of 2-3 chilled on a ceramic dish. Cover with microwave cling-film.

## Reheating Baby Food and Milk

Use the power levels and times in this table as guide lines for reheating.

Food	Portion	Power	Time (min.)	Standing Time (min.)	Instructions
Baby food (vegetables + meat)	190 g	600 W	30 sec.	2 - 3	Empty into ceramic deep plate. Cook covered. Stir after cooking time. Stand for 2-3 minutes. Before serving, stir well and check the tem perature carefully.
Baby porridge (grain + milk + fruit)	190 g	600 W	20 sec.	2 - 3	Empty into ceramic deep plate. Cook covered. Stir after cooking time. Stand for 2-3 minutes. Before serving, stir well and check the tem perature carefully.
Baby milk	100 ml 200 ml	300 W	30-40 sec. 1 min to 1 min 10sec	2 - 3	Stir or shake well and pour into a sterilised glass bottle. Place into the centre of turn-table. Cook uncovered. Shake well and stand for at least 2 minutes. Before serving, shake well and check the tempera ture carefully.

# Cooking Guide

## DEFROSTING

Microwaves are an excellent way of defrosting frozen food. Microwaves gently defrost frozen food in a short period of time. This can be of great advantage, if unexpected guests suddenly show up.

Frozen poultry must be thoroughly thawed before cooking. Remove any metal ties and take it out of any wrapping to allow thawed liquid to drain away.

Put the frozen food on a dish without cover. Turn over halfway, drain off any liquid and remove any giblets as soon as possible.

Check the food occasionally to make sure that it does not feel warm.

If smaller and thinner parts of the frozen food start to warm up, they can be shield by wrapping very small strips of aluminium foil around them during defrosting.

Should poultry start to warm up on the outer surface, stop thawing and allow it to stand for 20 minutes before continuing.

Leave the fish, meat and poultry to stand in order to complete defrosting. The standing time for complete defrosting will vary depending on the quantity defrosted. Please refer to the table below.

Hint: Flat food defrosts better than thick and smaller quantities need less time than bigger ones. Remember this hint while freezing and defrosting food.

For defrosting of frozen food with a temperature of about -18 to -20 °C, use the following table as a guide.

**All frozen food should be defrosted using defrosting power level (180 W).**

Food	Portion	Time (min.)	Standing Time (min.)	Instructions
Meat				
Minced beef	500 g	14 - 16	5 - 20	Place the meat on a flat ceramic plate. Shield thinner edges with aluminium foil. Turn over after half of defrosting time!
Pork steaks	250 g	7 - 7½		
Poultry				
Chicken pieces	500 g (2 pc)	15 - 16	15 - 40	First, put chicken pieces first skin-side down, whole chicken first breast-side-down on a flat ceramic plate. Shield the thinner parts like wings and ends with aluminium foil. Turn over after half of defrosting time!
Whole chicken	900 g	32 - 34		
Fish				
Fish fillets	250 g (2 pc)	7 - 8	5 - 20	Put frozen fish in the middle of a flat ceramic plate. Arrange the thinner parts under the thicker parts. Shield narrow ends with aluminium foil. Turn over after half of defrosting time!
	400 g (4 pc)	12 - 13		
Fruits				
Berries	250 g	7 - 8	5 - 10	Distribute fruits on a flat, round glass dish (with a large diameter).
Bread				
Bread rolls (each ca. 50 g)	2 pc	1½ - 2	5 - 10	Arrange rolls in a circle or bread horizontally on kitchen paper in the middle of turntable. Turn over after half of defrosting time!
	4 pc	3 - 4		
Toast/ Sandwich	250 g	4 - 5		
German bread (wheat + rye flour)	500 g	8 - 10		

## **SPECIAL HINTS**

### **MELTING BUTTER**

Put 50 g butter into a small deep glass dish. Cover with plastic lid. Heat for 30-40 seconds using 750 W, until butter is melted.

### **MELTING CHOCOLATE**

Put 100 g chocolate into a small deep glass dish. Heat for 3-5 minutes, until chocolate is melted. Stir once or twice during melting.

### **MELTING CRYSTALLIZED HONEY**

Put 20 g crystallized honey into a small deep glass dish. Heat for 20-30 seconds using 300 W, until honey is melted.

### **MELTING GELATINE**

Lay dry gelatine sheets (10 g) for 5 minutes into cold water. Put drained gelatine into a small glass pyrex bowl. Heat for 1 minute using 300 W. Stir after melting.

### **COOKING GLAZE/ICING (FOR CAKE AND GATEAUX)**

Mix instant glaze (approximately 14 g) with 40 g sugar and 250 ml cold water. Cook uncovered in a glass pyrex bowl for 3 1/2 to 4 1/2 minutes using 750 W, until glaze/icing is transparent. Stir twice during cooking.

### **COOKING JAM**

Put 600 g fruits (for example mixed berries) in a suitable sized glass pyrex bowl with lid. Add 300 g preserving sugar and stir well. Cook covered for 10-12 minutes using 750 W. Stir several times during cooking. Empty directly into small jam glasses with twist-off lids. Stand on lid for 5 minutes.

### **COOKING PUDDING**

Mix pudding powder with sugar and milk (500 ml) by following the manufacturers instructions and stir well. Use a suitable sized glass pyrex bowl with lid. Cook covered for 6 1/2 to 7 1/2 minutes using 750 W. Stir several times well during cooking.

### **BROWNING ALMOND SLICES**

Spread 30 g sliced almonds evenly on a medium sized ceramic plate. Stir several times during browning for 3 1/2 to 4 1/2 minutes using 600 W. Let it stand for 2-3 minutes in the oven. Use oven gloves while taking out!

## Cleaning Your Microwave Oven

*The following parts of your microwave oven should be cleaned regularly to prevent grease and food particles from building up:*

- *Inside and outside surfaces*
- *Door and door seals*
- *Turntable and Roller rings*



ALWAYS ensure that the door seals are clean and the door closes properly.

1. Clean the outside surfaces with a soft cloth and warm, soapy water. Rinse and dry.
2. Remove any splashes or stains on the inside surfaces or on the roller ring with a soapy cloth. Rinse and dry.
3. To loosen hardened food particles and remove smells, place a cup of diluted lemon juice on the turntable and heat for ten minutes at maximum power.
4. Wash the dishwasher-safe plate whenever necessary.



**DO NOT** spill water in the vents. NEVER use any abrasive products or chemical solvents. Take particular care when cleaning the door seals to ensure that no particles:

- Accumulate
- Prevent the door from closing correctly

## Storing and Repairing Your Microwave Oven

*A few simple precautions should be taken when storing or having your microwave oven serviced.*

*The oven must not be used if the door or door seals are damaged:*

- *Broken hinge*
- *Deteriorated seals*
- *Distorted or bent oven casing*

*Only a qualified microwave service technician should perform repair*



**NEVER** remove the outer casing from the oven. If the oven is faulty and needs servicing or you are in doubt about its condition:

- Unplug it from the wall socket
- Contact the nearest after-sales service centre



If you wish to store your oven away temporarily, choose a dry, dust-free place.

**Reason:** Dust and damp may adversely affect the working parts in the oven.



This microwave oven is not intended for commercial use.

## Technical Specifications

*SAMSUNG strives to improve its products at all times. Both the design specifications and these user instructions are thus subject to change without notice.*

<b>Model</b>	<b>M1638 / M1618</b>
<b>Power source</b>	230V ~ 50 Hz
<b>Power consumption</b> Microwave	1150 W
<b>Output power</b>	100 W / 750 W (IEC-705)
<b>Operating frequency</b>	2450 MHz
<b>Magnetron</b>	OM75S(31)
<b>Cooling method</b>	Cooling fan motor
<b>Dimensions (W x H x D)</b> Outside	489 x 275 x 351 mm
Oven cavity	306 x 181 x 322 mm
<b>Volume</b>	17 liter
<b>Weight</b> Net	13.5 kg approx

