

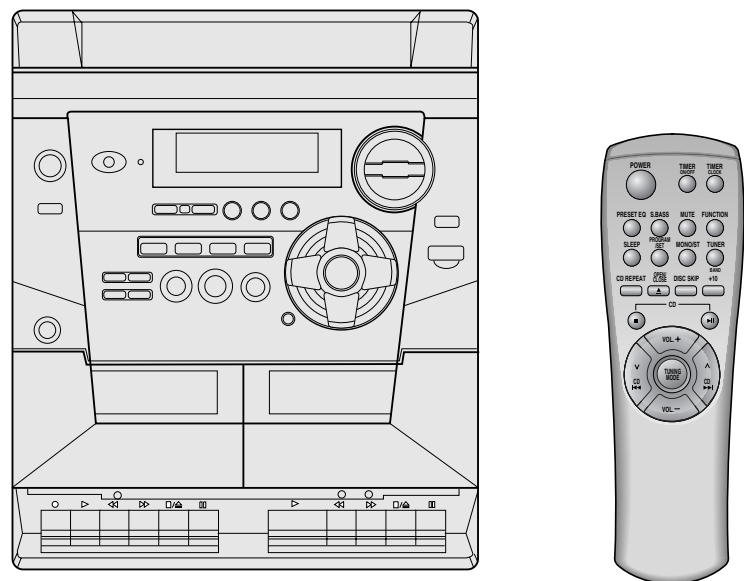

THREE-CD CHANGER MINI-COMPACT SYSTEM MAX-900

Instruction Manual



**CLASS 1 LASER PRODUCT
KLASSE 1 LASER PRODUKT
LUOKAN 1 LASER LAITE
KLASS 1 LASER APPARAT
PRODUCTO LASER CLASE 1**

CAUTION
RISK OF ELECTRIC SHOCK.
DO NOT OPEN

CAUTION:
TO REDUCE THE RISK OF ELECTRIC SHOCK, DO NOT REMOVE REAR COVER. NO USER SERVICEABLE PARTS INSIDE. REFER SERVICING TO QUALIFIED SERVICE PERSONNEL.

CLASS 1 LASER PRODUCT

This Compact Disc player is classified as a CLASS 1 LASER product.

Wiring the Main Power Supply Plug(UK Only)

IMPORTANT NOTICE

The main lead on this equipment is supplied with a moulded plug incorporating a fuse. The value of the fuse is indicated on the pin face of the plug and if it requires replacing, a fuse approved to BS1362 of the same rating must be used.

Never use the plug with the fuse cover removed. If the cover is detachable and a replacement is required, it must be of the same colour as the fuse fitted in the plug. Replacement covers are available from your dealer.

If the fitted plug is not suitable for the power points in your house or the cable is not long enough to reach a power point, you should obtain a suitable safety approved extension lead or consult your dealer for assistance.

However, if there is no alternative to cutting off the plug, remove the fuse and then safely dispose of the plug. Do not connect the plug to a main socket as there is a risk of shock hazard from the bared flexible cord.

Never attempt to insert bare wires directly into a main socket. A plug and fuse must be used at all times.

IMPORTANT

The wires in the main lead are coloured in accordance with the following code:-

BLUE = NEUTRAL BROWN = LIVE

As these colours may not correspond to the coloured markings identifying the terminals in your plug, proceed as follows:-

The wire coloured BLUE must be connected to the terminal marked with the letter N or coloured BLUE or BLACK. The wire coloured BROWN must be connected to the terminal marked with the letter L or coloured BROWN or RED.

WARNING: DO NOT CONNECT EITHER WIRE TO THE EARTH TERMINAL WHICH IS MARKED WITH THE LETTER E OR BY THE EARTH SYMBOL , OR COLOURED GREEN OR GREEN AND YELLOW.

Use of controls, adjustments or performance of procedures other than those specified herein may result in hazardous radiation exposure.

CAUTION-INVISIBLE LASER RADIATION WHEN OPEN AND INTER LOCKS DEFEATED, AVOID EXPOSURE TO BEAM.



This symbol indicates that dangerous voltage which can cause electric shock is present inside this unit.



This symbol alerts you to important operating and maintenance instructions accompanying the unit.

WARNING: To reduce the risk of fire or electric shock, do not expose this appliance to rain or moisture.

CAUTION: TO PREVENT ELECTRIC SHOCK, MATCH WIDE BLADE OF PLUG TO WIDE SLOT, FULLY INSERT.

Thank you for buying this SAMSUNG mini-compact system.

Please take time to read these instructions. They will allow you to operate your system with ease and take full advantage of its features.

◆ SAFETY WARNINGS	2
◆ INSTALLING YOUR MINI-COMPACT SYSTEM	
■ Where to Install Your Mini-Compact System	4
■ Inserting Remote Control Batteries	4
■ Connecting the Loudspeakers	4
■ Connecting Your System to the Power Supply	4
■ Connecting an AM (MW) Aerial	5
■ Connecting an FM Aerial	5
■ Connecting the SW Aerial (option)	5
■ Menu System	6
■ Viewing the Various Functions on Your System	6
■ Setting the Clock	6
◆ CD-PLAYER	
■ Loading and Changing Compact Discs	7
■ Listening to a Compact Disc	7
■ Selecting a Disc in the CD changer	8
■ Selecting a Track	8
■ Selecting a Track with a Two-Digit Number	8
■ Searching for a specific Music Passage on a CD	8
■ Repeating One or All Tracks on the Compact Discs	9
■ Programming the Order of Playback	9
■ Checking or Changing Programmed Tracks	10
◆ TUNER	
■ Searching for and Storing the Radio Stations	10
■ Selecting a Stored Station	11
■ Improving Radio Reception	11
◆ TAPE DECK	
■ Listening to a Cassette	12
■ Listening to Two Cassettes in Sequence	12
■ Rewinding and Fast-Forwarding a Cassette	12
■ Recording a Radio Programme	13
■ Recording a Compact Disc	13
■ Copying a Cassette (Dubbing)	13
◆ OTHER FUNCTIONS	
■ Timer Function	14
■ Cancelling the Timer	14
■ Setting the System to Switch Off Automatically (option)	14
■ Mute Function	15
■ Super Bass System	15
■ Selecting an Equalize Preset	15
■ Power Sound Function	15
■ About RDS broadcasting (option)	16
■ CD DIGITAL OUT Jack (option)	17
■ Connecting to an External Source	18
■ Connecting Headphones	18
◆ RECOMMENDATIONS FOR USE	
■ Safety Precautions	18
■ Cleaning Your Mini-Compact System	19
■ Precautions When Using Compact Discs	19
■ Precautions When Using Audio Cassettes	19
■ Before Contacting the After-Sales Service	19
■ Front Panel View	20
■ Remote Control	21
■ Rear Panel View	22
■ Technical Specifications	22

Symbols



Where to Install Your Mini-Compact System

To take full advantage of your new mini-compact system, follow these installation instructions before connecting the unit.

- ◆ Install the system on a flat, stable surface.
- ◆ Never place this unit on carpeting.
- ◆ Never place this unit in an outdoor area.
- ◆ Maintain an open space of approximately 4 inches (10 cm) on the sides and rear of the system, for ventilation purposes.
- ◆ Make sure that you have enough room to open the compact disc compartment easily.
- ◆ Place the loudspeakers at a reasonable distance on either side of the system to ensure good stereo sound.
- ◆ Direct the loudspeakers towards the listening area.
- ◆ For optimum performance, make sure that both speakers are placed at an equal distance above the floor.

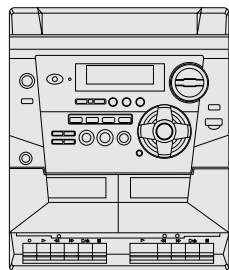

Inserting Remote Control Batteries

Insert or replace remote control batteries when you:

- ◆ Purchase the mini-compact system
 - ◆ Find that the remote control is no longer operating correctly
- ☛ When replacing the batteries, use a new set of batteries and never mix alkaline and manganese batteries.

- 1 Place your thumb on the position marked  on the battery compartment cover (rear of the remote control) and push the cover in the direction of the arrow.
- 2 Insert two AAA, LR03 or equivalent batteries, taking care to respect the polarities:
 - ◆ + on the battery against + on the remote control
 - ◆ - on the battery against - on the remote control
- 3 Replace the cover by sliding it back until it clicks into position.

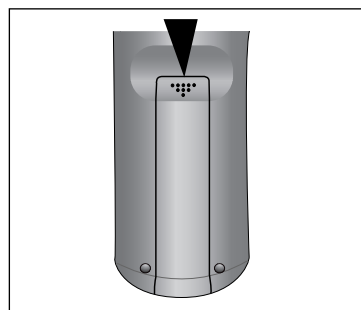

Connecting the Loudspeakers

The loudspeaker connector terminals are located on the rear of the system.

There are four terminals on the system:

- ◆ Two for the left speaker (marked L)
- ◆ Two for the right speaker (marked R)

To achieve the correct sound quality, connect the:

- ◆ Red wire to the + terminals
- ◆ Black wire to the - terminals

- 1 To connect a wire to a terminal, push the tab as far as it will go:
 - ◆ To the right on the system
- 2 Insert the wire, up to the plastic sheathing, in the hole.
- 3 Push the tab back:
 - ◆ To the left on the system, until it clicks into place

Result: The wire is pinched and held firmly in place.
- 4 Repeat the operation for each wire.

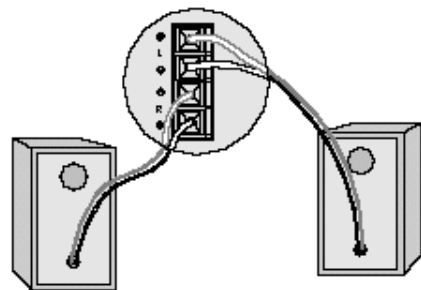

Connecting Your System to the Power Supply

The main lead must be plugged into an appropriate socket.

- ☛ Before plugging your system into a main socket, you must check the voltage setting (OPTIONAL). If the voltage of the socket does not correspond to the setting on the rear of the unit, you may seriously damage your system.

- 1 Check the position of the voltage selector on the rear of the system (OPTIONAL).
- 2 Plug the main lead (marked AC CORD on the rear of the system) into an appropriate socket.
- 3 Press the POWER button to switch your mini-component system on.

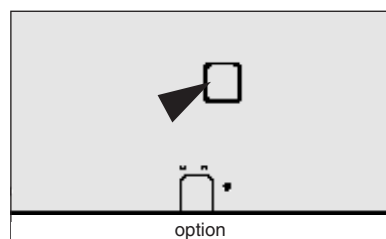

Connecting the AM (MW) Aerial

The AM aerial (for long and medium waves) can be:

- ◆ Placed on a stable surface
- ◆ Fixed to the wall

The AM aerial connector terminals are located on the rear of the system and are marked AM.

- ☛ To avoid noise interference, check that the loudspeaker wires do not run close to the aerial wires. Always keep them at least 2 inches (5 cm) away.

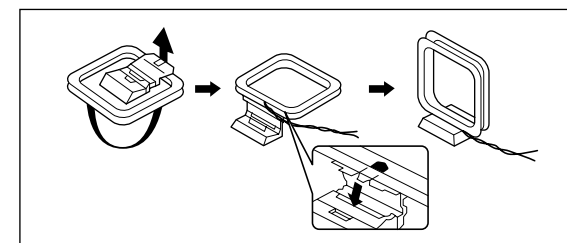
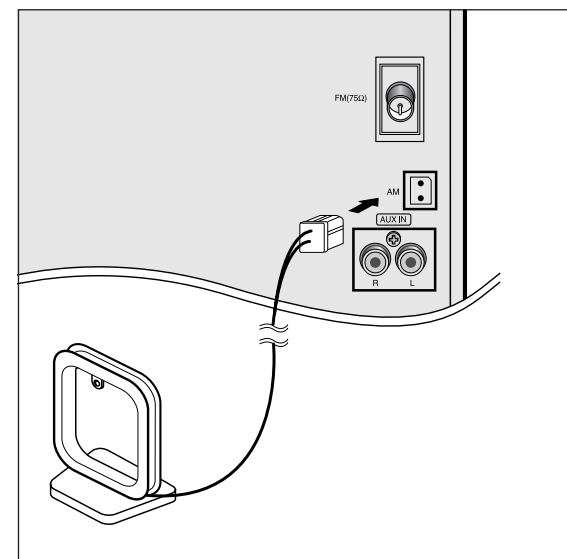

Connecting the FM Aerial

There are two types of aerial, (depending on option chosen).

1 How to connect a COAXIAL TYPE aerial.

- ◆ Connect a 75Ω antenna to the FM antenna terminal.
- ◆ Plug the connector on the FM aerial supplied into the coaxial socket (75Ω) marked FM on the rear of the system.
- ◆ Follow the instructions given on Page 10 to tune into a radio station, and determine the best position for the aerial.
- ◆ If reception is poor, you may need to install an outdoor aerial. To do so, connect an outdoor FM aerial to the FM socket on the rear of the system using a 75Ω coaxial cable (not supplied).

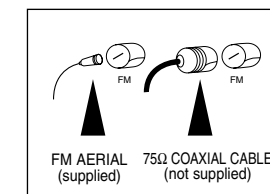
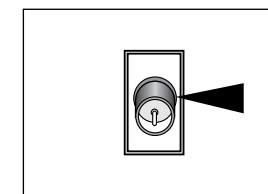

2 How to connect a SCREW TYPE aerial.

- ◆ The FM aerial connector terminals are located on the rear of the system and marked FM (75Ω).
- ◆ Spread the T-form FM aerial out and attach the ends to a wall, in the position providing the best reception.

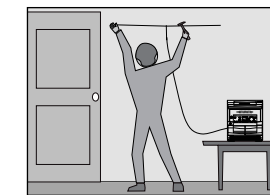
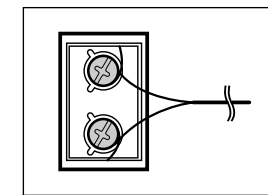

Connecting the SW Aerial (option)

How to connect a WIRE TYPE aerial.

- 1
 - ◆ Spread the SW aerial out and attach the ends to a wall, in the position providing the best reception.
 - ◆ If reception is poor (e.g. distance from transmitter too great, walls blocking the radio waves, etc.), install an outdoor aerial.

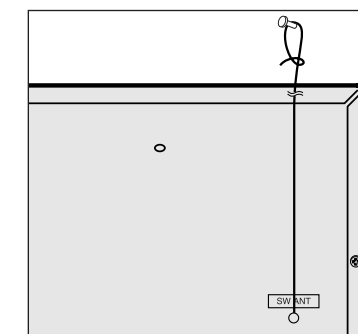

Menu System

To select the basic functions on your mini-component system (radio, compact disc, cassette or auxiliary source), press the corresponding buttons on the front panel or FUNCTION on the remote control.

Depending on the feature that you select, the multi-function buttons illuminate.

- Switch the system on by pressing Power.
Result: The function selected just before the system was last switched off is reactivated.
- Press FUNCTION the appropriate number of times to select one of the 4 functions available:
 - TUNER (radio)
 - CD (compact disc)
 - AUX (auxiliary source)**Result:** The various sub-options available are indicated by the symbols displayed on the multi-function buttons; these symbols change according to the function that you select.

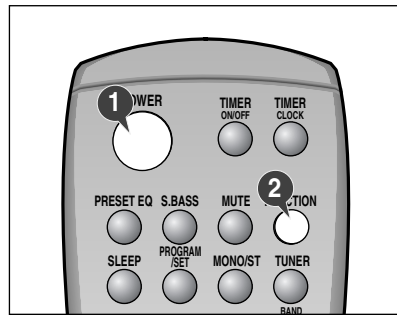

Viewing the Various Functions on Your System

You can view the various functions available on your system.

- Press the DEMO button.
Result: The various functions available are listed in turn on the display.
- All these functions are described in detail in this booklet. For instructions on how to use them, refer to the appropriate sections.
- To cancel this function, press DEMO again.

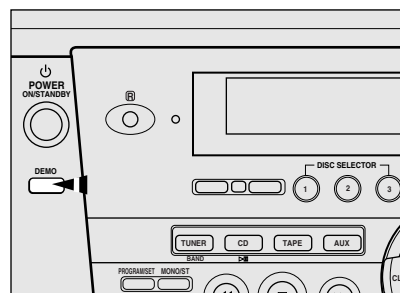

Setting the Clock

Your system is equipped with a clock which allows you to turn your system on and off automatically. You should set the clock:

- When you purchase the mini-compact system
 - After a power failure
 - After unplugging the unit
- Remember to reset the time when the clock changes from winter to summer time and vice versa.
- For each step, you have a few seconds to set the required options. If you exceed this time, you must start again.

- Switch the system on by pressing POWER.
- Press TIMER/CLOCK twice.
Result: CLOCK is displayed.
- Press PROGRAM/SET.
Result: The hour flashes.
- | To... | Press... |
|--------------------|--------------------|
| Increase the hours | PRESET/MANUAL UP |
| Decrease the hours | PRESET/MANUAL DOWN |
- When the correct hour is displayed, press PROGRAM/SET.
Result: The minutes flash.
- | To... | Press... |
|----------------------|--------------------|
| Increase the minutes | PRESET/MANUAL UP |
| Decrease the minutes | PRESET/MANUAL DOWN |
- When the correct time is displayed, press PROGRAM/SET.
Result: The clock starts and is displayed, even when the system is in standby mode.

➤ You can display the time, even when you are using another function, by pressing TIMER/CLOCK once.

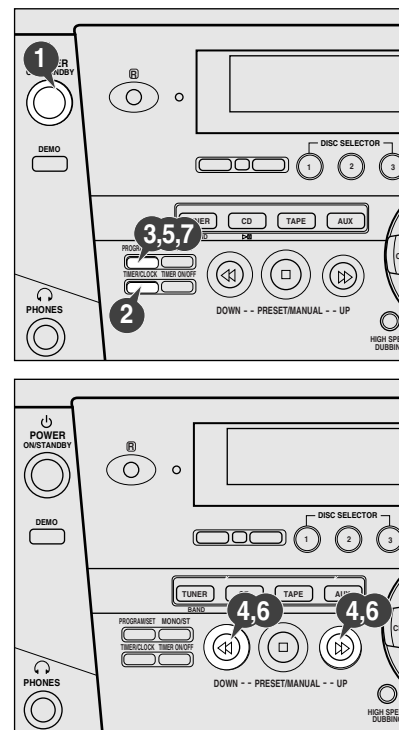

Loading and Changing Compact Discs

The CD disc changer can contain up to three 12 cm or 8 cm compact discs without using an adapter.

- Never force the compact disc carousel when opening and closing the compartment.
Never press down or place objects on the carousel.
- Always treat your compact discs with care; refer, if necessary, to the section entitled "Precautions When Using Compact Discs" on page 19.

- Switch the system on by pressing POWER.
- Press the OPEN/CLOSE button on the front panel (or \blacktriangle on the remote control).
Result: The compartment opens.
- Place one or two discs in the front slots of the carousel, with the label on the discs facing upwards.
 - Check that the compact disc has been correctly inserted in the holder before closing the compartment.
- If you wish to load a third compact disc, press the DISC CHANGE button on the front panel (or DISC SKIP on the remote control).
Result: The carousel rotates by 120°.
- Close the compartment by pressing the OPEN/CLOSE button again.
 - If you wish to start playing a disc directly, you can also proceed as follows.

To play...	Press...
Disc 1	CD (\blacktriangleright) or DISC SELECTOR 1
Disc 2	DISC SELECTOR 2
Disc 3	DISC SELECTOR 3

Result: The compartment closes automatically and the disc selected starts playing.

- To change or unload the compact disc changer, repeat Steps 2 to 5.

- Keep the compartment closed whenever you are not using it, to prevent dust from entering.
- You can load or unload compact discs when the radio, tape or auxiliary source function is selected.

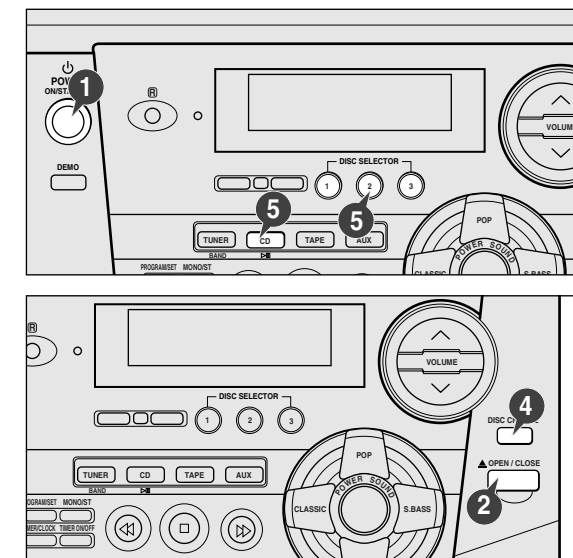

Listening to a Compact Disc

When you have loaded at least one compact disc into the player, you can start listening to it.

- Always treat your compact discs with care; refer, if necessary, to the section entitled "Precautions When Using Compact Discs" on page 19.

- Switch the system on by pressing POWER.
- Select the CD function by pressing CD on the front panel or FUNCTION one or more times on the remote control.
- Load one or more discs.
- Press CD (\blacktriangleright) on the front panel or \blacktriangleright on the remote control.
 - If you have loaded more than one compact disc, they will be played in turn.
- Adjust the volume as required by:
 - Pressing the VOLUME \blacktriangle or \blacktriangledown on the front panel or
 - Pressing the VOL. + or - buttons on the remote control
- To pause temporarily during playback, press CD (\blacktriangleright).
 - Press CD (\blacktriangleright) again to continue disc playback.
- Press \blacksquare when you have finished.

- When playing a disc, you can load new discs without stopping the current one. To do so, open the compartment by pressing DISC CHANGE and load new discs in the other two vacant slots (not the one containing the disc that you are playing). You cannot rotate the carousel during playback.
- When no discs are loaded, the "NO DISC" indication is displayed.
- The CD player stops automatically after playing the three discs, if the CD REPEAT function has not been selected.



Selecting a Disc in the CD changer

The CD function is automatically selected when DISC SKIP is pushed.

To select a specific disc, press the corresponding DISC SELECTOR (1, 2, 3) button on the front panel or DISC SKIP on the remote control, until the required disc indicator flashes.

Result: All the discs will be played in turn, starting with the one selected.

➤ If you wish to play the current disc only, press REPEAT on the remote control one or more times, until DISC is displayed.

- If you use the DISC SELECTOR (1, 2, 3) function when listening to the radio or to a tape, the system switches automatically to the CD mode.
- If the disc selected is not loaded, the next disc is played automatically.

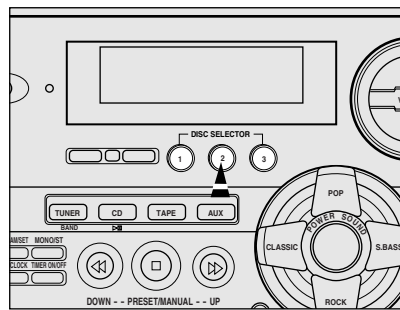

Selecting a Track with a Two-Digit Number

To select a track with a two-digit number faster, use the +10 key button.

- For example, to select the track no.25.
- Press +10 two times.
Result: The tens (10, 20 and so on) are displayed.
- Press \leftarrow CD five times.

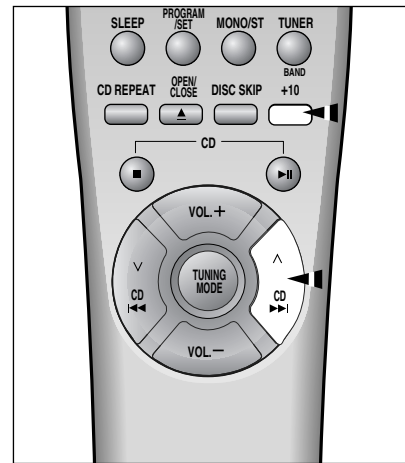

Repeating One or All Tracks on the Compact Discs

You can repeat indefinitely:

- ◆ A specific track on a compact disc.
- ◆ All tracks on the compact disc selected.
- ◆ All discs loaded in the carousel

- To repeat... Press CD REPEAT on the REMOTE CONTROL one or more times until...
The current track indefinitely REPEAT 1 is displayed
The selected disc REPEAT DISC is displayed
All discs loaded REPEAT DISC ALL is displayed

2 When you wish to stop the Repeat function, press REPEAT until DISC ALL or DISC is displayed, or press ■.

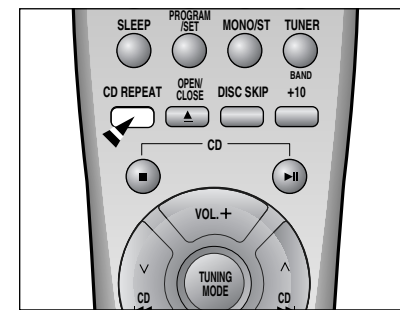

Selecting a Track

You can select the track you wish to listen to, either when the compact disc player is stopped or when a disc is playing.

To start playback at the beginning of the...	Press...
Next track	▶▶
Current track	⏮
Previous track	⏮ twice
Track of your choice	⏮ or ▶▶ the appropriate number of times.

➤ You can also use ⏮ and ▶▶ buttons on the remote control.

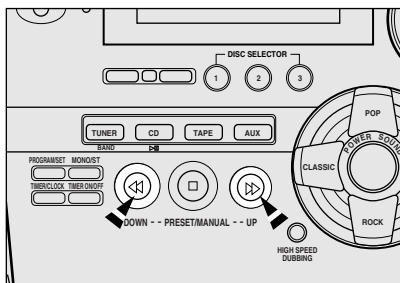

Searching for a Specific Music Passage on a CD

When listening to a compact disc, you can quickly search for a specific music passage on a track.

➤ It is recommended that you turn the volume down before using this function.

To search through the tracks...	Press and hold down...
Forwards	▶▶ for at least one second
Backwards	⏮ for at least one second

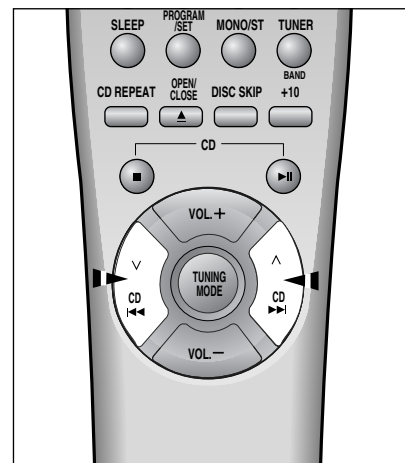

Programming the Order of Playback

You can decide:

- ◆ The order in which you listen to the tracks on the discs loaded
- ◆ Which tracks you do not wish to listen to
- You can programme up to 24 tracks.
- ◆ You must stop the compact disc player before selecting the tracks.
- ◆ This feature can be combined with the Repeat function.

- If the CD function is selected, stop the player by pressing ■.
- Load the selected CDs.
- Press PROGRAM/SET.
Result: The following indications are displayed:
PR DI. --
(01 = Programme n°, DI = Disc n°, -- = Track n° on the disc)
- If necessary, select the disc containing the required track by pressing the corresponding DISC SELECTOR(1, 2, 3) button.
- Select the required track by pressing:
◆ ⏮ to move back through the tracks
◆ ▶▶ to move forward through the tracks
- Press PROGRAM/SET to confirm your selection.
Result: The selection is stored and **PR DI. --** is displayed.
- To select other tracks, repeat Steps 4 to 6.

8 Press ▶▶ to listen to the track selection in the order programmed.

To...	Press...
Listen to the current track again	⏮ once
Listen to the previous track	⏮ twice
Listen to the next track	▶▶ once
Skip forwards or backwards one or more tracks	▶▶ or ⏮ the appropriate number of times

10 To cancel the selection, press ■.
◆ Once if the compact disc player is stopped
Result: PROGRAM is no longer displayed.

- If you open the compartment, the selection is cancelled.
- ◆ If you select the number of a disc which is not loaded or a track which does not exist on the CD, the selection skips to the next programmed track.

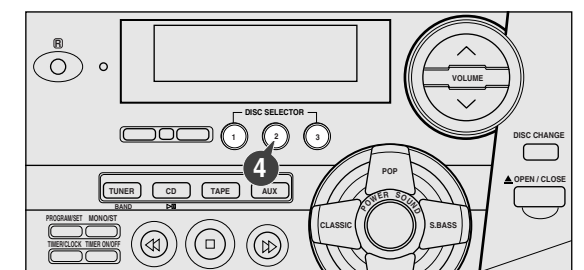
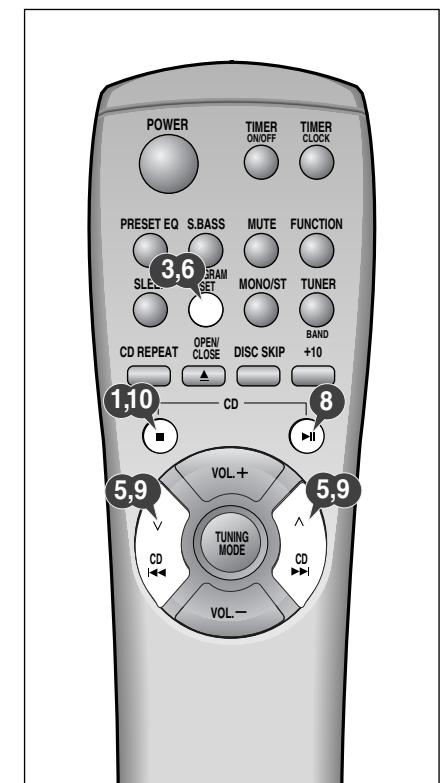

Checking or Changing Programmed Tracks

You can check or change your selection of tracks at any time.

- 1 Press **■** once if you have started listening to the selection.
- 2 Press PROGRAM/SET.
➤ If you have already programmed 24 tracks, CH is displayed instead of PR when you press PROGRAM/SET.
- 3 Press PROGRAM/SET again.
Result: The first track selected is displayed, together with the letter CH (Change).
- 4 Press PROGRAM/SET one or more times until the track to be changed is displayed.
- 5 If necessary, press the corresponding DISC SELECTOR (1, 2, 3) button to change discs.
- 6 Press TUNING DOWN and UP to select a different track.
- 7 Press PROGRAM/SET to confirm your change.
- 8 Press CD (▶) to start listening to the selection.
Result: The first track selected is played.

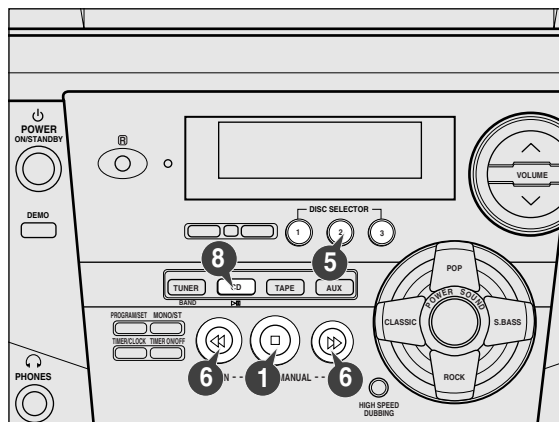
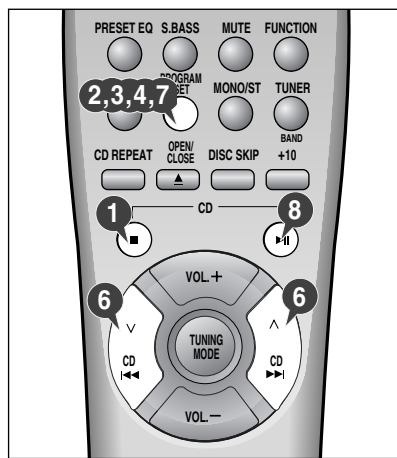

Searching for and Storing the Radio Stations

You can store up to:

- ◆ 15 FM stations (option)
- ◆ 15 AM stations (option)
- ◆ 15 FM stations (option)
- ◆ 8 MW stations (option)
- ◆ 7 LW stations (option)
- ◆ 15 FM stations (option)
- ◆ 5 MW stations (option)
- ◆ 5 SW1 stations (option)
- ◆ 5 SW2 stations (option)

- 1 Switch the system on by pressing POWER.
- 2 Select the TUNER function by pressing TUNER on the front panel or FUNCTION on the remote control one or more times.
- 3 Select the required frequency band by pressing TUNER again on the front panel or BAND on the remote control.
Result: The appropriate indication is displayed:
 - ◆ FM Frequency Modulation
 - ◆ AM(MW) Medium Wave
 - ◆ LW(OPTION) Long Wave
 - ◆ SW1, SW2(OPTION) Short Wave
- 4 To search for a station... Press PRESET/MANUAL on the front panel or TUNING MODE on the remote control.
 - Manually One or more times until MANUAL is displayed.
 - Automatically One or more times until AUTO is displayed.
- 5 Select the station to be stored by:
 - ◆ Pressing PRESET MANUAL DOWN or UP on the front panel or
 - ◆ Pressing TUNING DOWN or UP on the remote control
 - ◆ To scroll through the frequencies faster when searching manually, hold down the PRESET MANUAL DOWN or UP buttons.
 - ◆ The automatic search procedure may stop on a frequency that does not correspond to a radio station. If this happens, use the manual search mode.
- 6 Adjust the volume by:
 - ◆ Pressing the VOLUME ▲ or ▼ on the front panel or
 - ◆ Pressing the VOL. + or - buttons on the remote control
- 7 Select the stereo or mono mode by pressing MONO/ST.

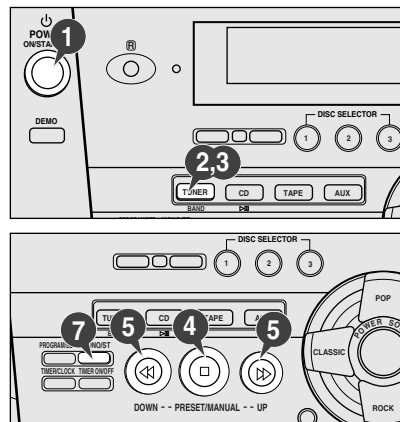

Searching for and Storing the Radio Stations (continued)

- 8 If you do not want to store the radio station found, revert to Step 4 and search for another station. Otherwise:
 - a Press PROGRAM/SET.
Result: The programme number and PROGRAM are displayed for a few seconds.
 - b Press PRESET MANUAL DOWN and UP to assign a programme number between 1 and 15.
 - c Press PROGRAM/SET to store the radio station.
Result: PROGRAM is no longer displayed and the station is stored.
- 9 To store any other radio frequencies required, repeat Steps 3 to 8.
 - The PROGRAM function can be used to assign a new station to an existing programme number.

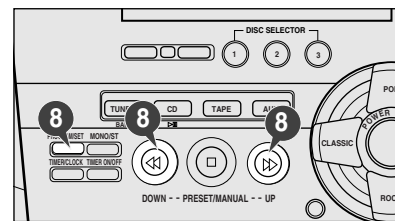

Selecting a Stored Station

You can listen to a stored radio station as follows:

- 1 Switch the system on by pressing POWER.
- 2 Select the TUNER function by pressing TUNER on the front panel or FUNCTION on the remote control one or more times.
- 3 Select the required frequency band by pressing TUNER BAND on the remote control or TUNER again on the front panel.
- 4 Press the TUNING MODE button until "PRESET" is displayed.
- 5 Select the radio station as follows.

To listen to ...	Press ...
Stored station	TUNING DOWN and UP to select the required programme.
Another station	TUNING DOWN and UP until the required frequency is displayed.

 - Press TUNING MODE again to exit the stored station selection function.

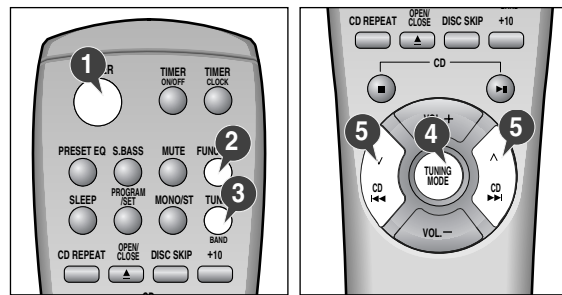

Improving Radio Reception

You can improve the quality of radio reception by:

- ◆ Rotating the FM or AM(MW) aerial
 - ◆ Testing the positions of the FM and AM(MW) aerials before fixing them permanently
- If reception from a specific FM radio station is poor, press MONO/ST to switch from stereo mode to mono. The quality of the sound will be improved.

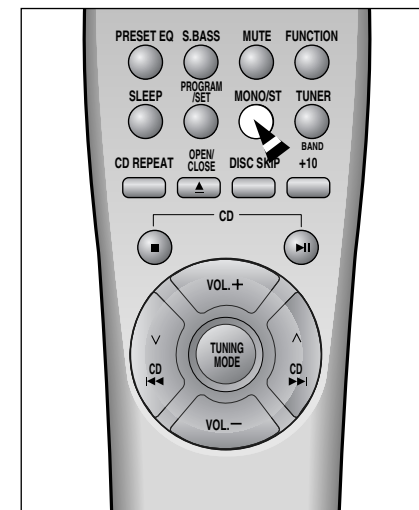

Listening to a Cassette

- When you press one of the tape deck's buttons, except for STOP/EJECT button it remain in the down position. It returns to its original position automatically when the function is completed or you cancel the command.
- Always treat your cassettes with care; refer, if necessary, to the section entitled "Precautions When Using Audio Cassettes" on page 19.

- Switch the system on by pressing the POWER button.
 - Press the TAPE button.
 - To open either Deck 1 or 2, press the corresponding STOP/EJECT (■/▲) button.
 - Insert the pre-recorded cassette with the open edge of the tape facing downwards.
 - Close the deck by pushing on it until it clicks into place.
 - Press the PLAY (▶) button corresponding to the selected deck to start listening to the cassette.
 - Adjust the volume by pressing the appropriate VOLUME buttons.
 - To stop playback temporarily, press PAUSE (⏸). Press PAUSE (⏸) again to continue listening to the cassette.
 - To... Press STOP/EJECT (■/▲)...
- | | |
|---------------------------|-------|
| Stop playing the cassette | Once |
| Open the cassette door | Twice |

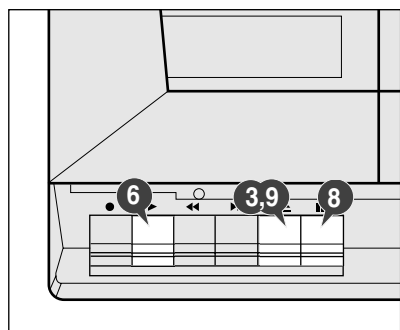
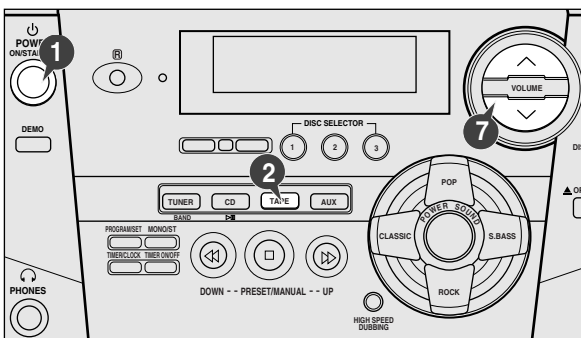

Listening to Two Cassettes in Sequence

You can only listen to one cassette at a time but you can switch automatically from one deck to the other to listen to two cassettes, one after the other.

- Repeat Steps 1 to 5 above, inserting a cassette in each deck.
- Press the PLAY (▶) button corresponding to Deck 2.
- Press the PLAY (▶) and PAUSE (⏸) at the same time for Deck 1.
Result: The cassette in Deck 2 is played until the end of the tape is reached; the cassette in Deck 1 then starts playing automatically.

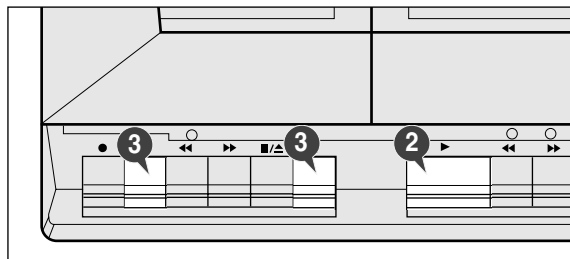

Rewinding and Fast-Forwarding a Cassette

You can rewind or fast-forward a cassette.

Example: You wish to listen to a track again or fast-forward the cassette to the end when you have finished playing all the tracks on one side of the cassette.

- Before fast-forwarding or rewinding the cassette, you must stop the playback.
- You can use this function while listening to a compact disc or radio programme.

- If necessary, press STOP/EJECT (■/▲) for the appropriate deck to stop the playback.
 - To... Press...
- | | |
|---------------------------|------------|
| Fast-forward the cassette | F/FWD (▶▶) |
| Rewind the cassette | REW (◀◀) |

- The rewind or fast-forward functions stop automatically when the beginning or end of the cassette is reached. The REW (◀◀) or F/FWD (▶▶) button then returns to its original position.

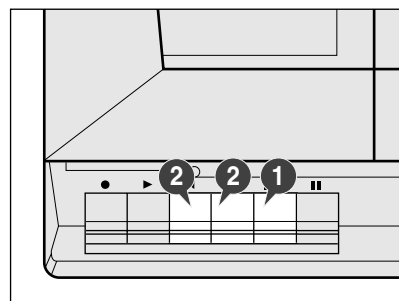

Recording a Radio Programme

You can record a radio programme of your choice.

- You can only record on cassettes in Deck 1.
- You can only record on normal bias cassettes.
- You do not need to adjust the volume, as it has no effect on recording.

- Switch your system on by pressing POWER.
- Insert a blank cassette in Deck 1.
- Press the TUNER button to select the radio function.
- Select the radio station that you wish to record.
- Press the RECORD (●) button corresponding to Deck 1.
Result: Recording starts.
- Press STOP/EJECT (■/▲) when you are ready to stop recording.

- You can press PAUSE (⏸) during recording, if you wish to skip unwanted passages. Press PAUSE (⏸) again when you want to start recording again.

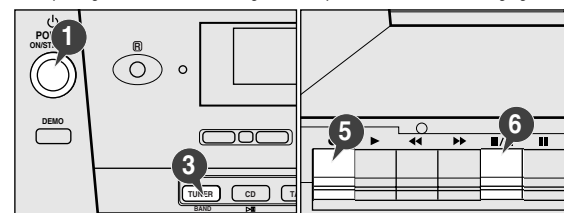

Recording a Compact Disc

You can record a compact disc on a cassette placed in Deck 1.

- You can only record on normal bias cassettes.
- You do not need to adjust the volume, as it has no effect on recording.

You can start recording with any track on the compact disc.

- Switch your system on by pressing POWER.
- Insert a blank cassette in Deck 1.
- Press the CD button.
- Select the required disc.
- Press the CD button and select the required track on the compact disc.
- Press the RECORD (●) button corresponding to Deck 1.
Result: Recording starts.
- Press the PAUSE (⏸) button corresponding to Deck 1 to stop recording temporarily.
Result: Recording stops but the compact disc continues playing.
- When you are ready to stop recording, press STOP/EJECT (■/▲) for the cassette deck and STOP (■) for the compact disc player.

- If you cannot press the RECORD (●) button, check that the cassette has been inserted correctly and the safety tabs are intact.

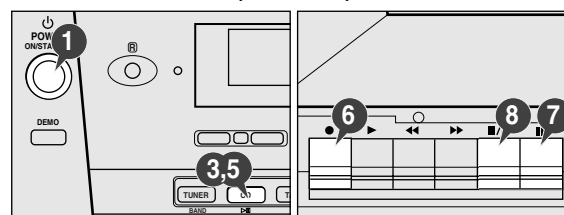

Copying a Cassette (Dubbing)

You can copy a cassette from Deck 2 to Deck 1. Two options are available:

- Normal speed dubbing
- High-speed dubbing

- Take care not to insert the tape to be copied in Deck 1, as it will be erased when you start recording.
- You do not need to adjust the volume, as it has no effect on the recording.

- Switch your system on by pressing POWER.
- Insert a blank cassette in Deck 1.
- Insert the tape to be copied in Deck 2.
- Press the TAPE button to select the cassette function.
- Press RECORD (●) for Deck 1.
- Press PLAY (▶) for Deck 2.
- To copy a cassette at high speed, press HI-DUBBING.
Result: The cassette is copied and the H DUBB indicator flashes.
- When you have finished recording, press the STOP/EJECT (■/▲) buttons for both Deck 1 and Deck 2.

- It is an infringement of copyright laws to copy records and pre-recorded cassettes CD or radio programmes or to re-record them in any form without the permission of the owners of the corresponding copyright.

- The sound quality of cassettes copied using high-speed dubbing is lower than with normal dubbing.
- It is recommended that you turn the volume down during high-speed dubbing, due to the high-pitched sound.

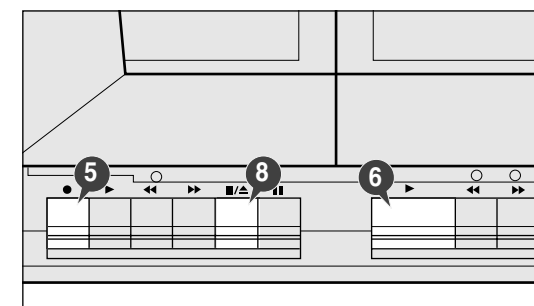
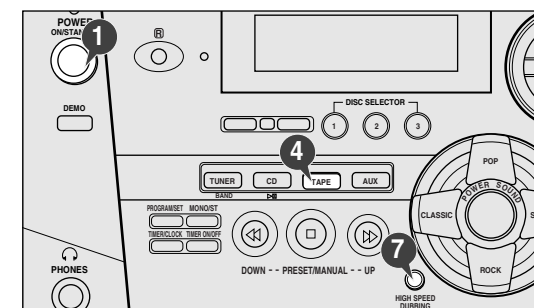

Timer Function

The timer enables you to switch the system on or off at specific times.
Example: You wish to wake up to music every morning.

- If you no longer want the system to be switched on or off automatically, you must cancel the timer.
- ◆ Before setting the timer, check that the current time is correct.
- ◆ For each step, you have a few seconds to set the required options. If you exceed this time, you must start again.

- 1** Switch the system on by pressing POWER.
- 2** Press TIMER/CLOCK until **TIMER** is displayed.
- 3** Press PROGRAM/SET.
Result: ON TIME is displayed (instead of the equalizer symbols) for a few seconds, followed by any switch-on time already set; you can set the timer switch-on time.
- 4** Set the timer switch-on time.
 - a** Set the hour by pressing TUNING DOWN and UP.
 - b** Press PROGRAM/SET.
Result: The minutes flash.
 - c** Set the minutes by pressing TUNING DOWN and UP.
 - d** Press PROGRAM/SET.
Result: OFF TIME is displayed (instead of the equalizer symbols) for a few seconds, followed by any switch-off time already set; you can now set the timer switch-off time.
- 5** Set the timer switch-off time.
 - a** Set the hour by pressing TUNING DOWN and UP.
 - b** Press PROGRAM/SET.
Result: The minutes flash.
 - c** Set the minutes by pressing TUNING DOWN and UP.
 - d** Press PROGRAM/SET.
Result: VOL XX is displayed, where XX corresponds to the volume already set.
- 6** Press TUNING DOWN and UP to adjust the volume level and press PROGRAM/SET.
Result: The source to be selected is displayed.
- 7** Press TUNING DOWN and UP to select the source to be played when the system switches on.

If you select...	You must also...
TUNER (radio)	<ol style="list-style-type: none"> a Select the FM or AM frequency band by pressing TUNING DOWN and UP. b Press PROGRAM/SET. c Select a preset station by pressing TUNING DOWN and UP.
CD (compact disc)	<ol style="list-style-type: none"> a Load one or more compact discs.
- 8** Press POWER to set the system to standby mode.
Result: TIMER is displayed to the bottom left of the time, indicating that the timer has been set. The system will switch on and off automatically at the required times.

- If the timer switch on and off times are identical, the word ERROR is displayed.

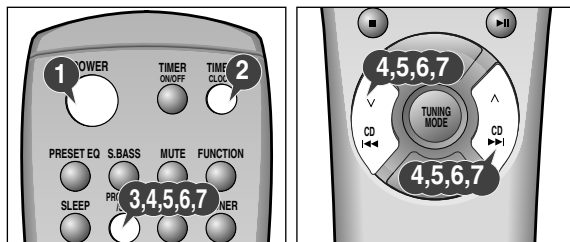

Cancelling the Timer

After having set the timer, it will start automatically as shown by the **TIMER** indication on the display. If you no longer wish to use the timer, you must cancel it.

- You can stop the timer at any time (system on or in standby mode).

To...	Press TIMER-ON/OFF ...
Cancel the timer	Once. Result: TIMER is no longer displayed.
Restart the timer	Twice. Result: TIMER is displayed again.

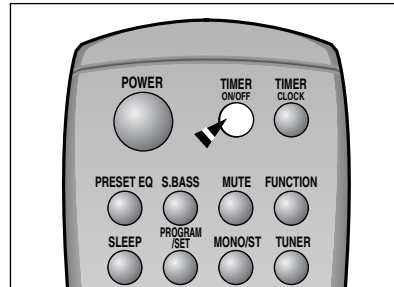

Setting the System to Switch off Automatically (option)

While listening to a compact disc or a cassette, you can set the system to switch off automatically.

Example: You wish to go to sleep to music.

- 1** Press AI OFF/SLEEP.
Result: playback starts and the following indications are displayed:

SLEEP
90 MIN

(AI OFF) → 90 MIN → 60 MIN → 45 MIN

← 15 MIN ← 30 MIN ←
- 2** Press AI OFF/SLEEP one or more times to indicate how long the system should continue playing before it switches off.

At any time, you can:

 - ◆ Check the remaining time by pressing AI OFF/SLEEP
 - ◆ Change the remaining time by repeating Steps 1 and 2
- 3** Press AI OFF/SLEEP one or more times until AI OFF is displayed.
Result: The system will automatically switch off at the end of disc or cassette.
- 4** To cancel SLEEP or AI OFF function, press AI OFF/SLEEP one or more times until OFF is displayed.

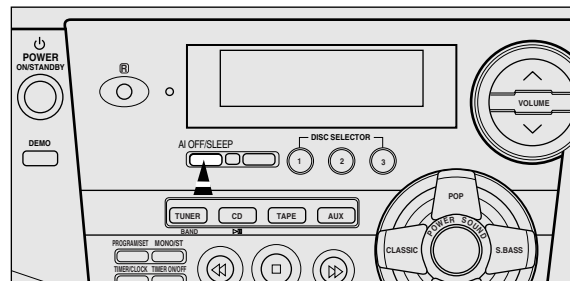

Mute Function

You can turn the sound off temporarily on your system.
Example: You wish to answer a telephone call.

- 1** Press MUTE on the remote control.
Result: The equalizer symbols are no longer displayed, the speaker symbols flash and the sound is switched off.
- 2** To switch the sound back on, press MUTE again or the VOLUME buttons.

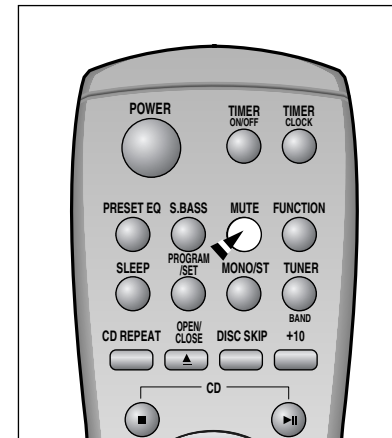

Super Bass Sound

Your mini-compact system has a bass amplification function called **SBS (Super Bass Sound)**. This function makes the sound more powerful and real.

- 1** Press the S. BASS button.
Result: S. BASS is displayed for a few seconds.
- 2** To cancel this function, press S. BASS again.

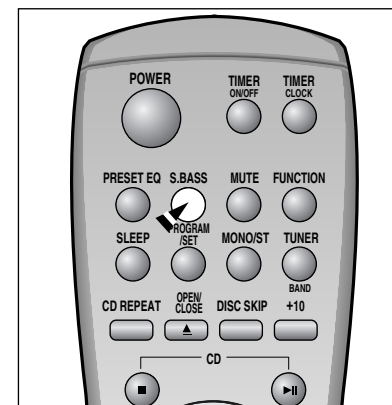

Selecting an Equalizer Preset

Your mini-compact system is equipped with a preset equalizer that allows you to choose the most appropriate balance between treble and bass frequencies, according to the type of music you are listening to.

Press PRESET EQ on the remote control until the required option is selected.

To obtain a...	Select...
Normal balance (linear)	PASS
Balance suitable for pop music	POP
Balance suitable for rock music	ROCK
Balance suitable for classic music	CLASSIC

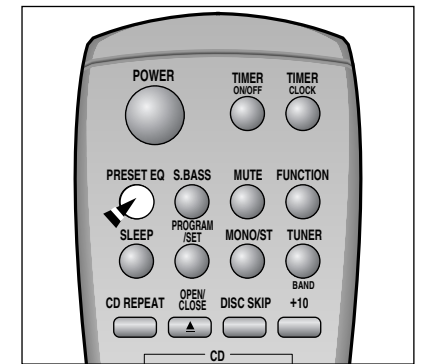

Power Sound Function

This machine is equipped with the function of **POWER SOUND**, which amplifies bass and improves high key or bass twice as much for you to appreciate powerful real surround-sound.

- 1** Press POWER SOUND button on the front panel.
Result:
 - ◆ The POWER SOUND button on the front panel lights up green.
 - ◆ P--SOUND is displayed for a few seconds.
 - ◆ A more powerful resonant sound is diffused.
- 2** To cancel this function, press POWER SOUND again.

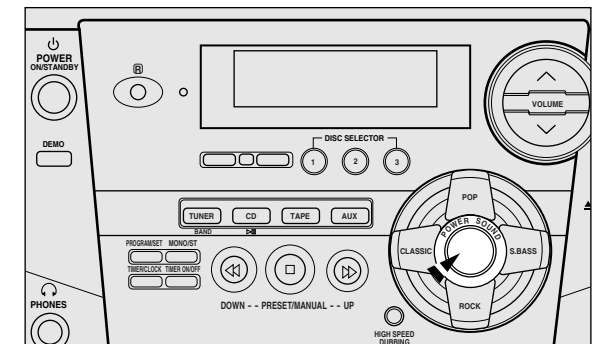

About RDS broadcasting (option)

This unit has the RDS (Radio Data System) function, which enables for the various information such as broadcasting station, radio text, time and 17 types of programs (News, Rock, Classic, etc.) to be received from the FM RDS station together with normal radio signal.

- 1 Press the Power ON button.
- 2 Receive the FM radio.
 - ◆ See the radio receiving method on the page 10.
 - ◆ FM and frequency are shown on the display
 - ◆ If the received station transmit the RDS information, 'RDS' appears automatically on the display.
- 3 Press the RDS DISPLAY button to select the desired RDS mode.
 - ◆ Whenever the button is pressed, RDS mode changes as follows.

▶ PS NAME → RT → CT → Current FM frequency

◆ The RDS function is available only on FM broadcasts.

Description on RDS function

1. **PTY** (Program Type) : Displays the type of programme currently being broadcast
2. **PS NAME** (Program Service Name) : Indicates the name of broadcasting station and is decoded (if any) composed of 8 characters.
3. **RT** (Radio Text) : The text broadcast by a station and composed of maximum 64 characters.
4. **CT** (Clock Time) : Decodes the real time clock from the FM frequency.
 - Some stations may not transmit PTY, RT or CT information therefore this may not be displayed in all cases.
5. **TP** (Traffic Program) : Indicates that the turned station is capable of transmitting traffic broadcasts.
6. **TA** (Traffic Announcement) : When this symbol flashes it shows that the traffic announcement is in progress.
7. **EON** (Enhanced Other Networks Information) : Offers the RDS information on other networks.

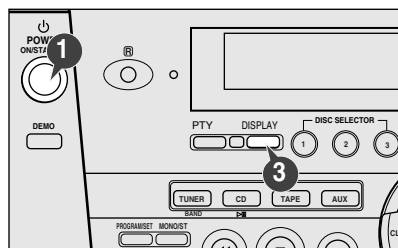

About RDS DISPLAY function (option)

About "PS NAME" MODE

➤ Displays the name of broadcasting station.

Press the RDS DISPLAY button to select the PS NAME.

- ◆ "PS NAME" appears on the display.
- ◆ If the PS information is being received, the PS name (BBC, AFO, NDR, etc.) is shown on the display.
- ◆ If the PS information isn't received, the original FM frequency is shown.

Even though no RDS DISPLAY button is pressed, the reception of PS information makes the PS name displayed.

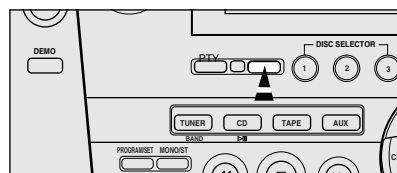

About 'RT' MODE

➤ Displays the character transmitted from the broadcasting station.

Press the RDS DISPLAY button to select the RT MODE.

- ◆ "RT" appears on the display.
- ◆ If the RT information is being received, the received information is shown on the display.
- ◆ If the RT information isn't received, the "NO RT" is shown. On the display.

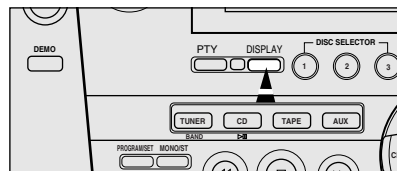

About CT(Clock Time)

➤ Sets the time of the RDS clock.

To select the CT time, set the RDS DISPLAY button to CT MODE.

- ◆ "CT" lights on the top display for several seconds.

◆ The CT information will take up to 2 minutes to be decoded therefore the clock isn't displayed immediately.

- ◆ If there is no available CT information, "NO CT" is displayed.

➤ The CT RDS clock does not update the system clock.

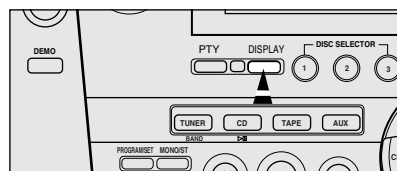

PTY (Program Type) indication and PTY-SEARCH function (option)

- ◆ The PTY information is composed of an identification symbol, which helps the FM radio to recognize the program type of each FM station.
- ◆ The 17 PTY modes are shown in the display by pressing the PTY button.

Display	Program Type
NEWS	• News including an announced opinion and report
AFFARIS	• Several matters including a current incident, documentary, discussion and analysis.
INFO	• Information including weights and measures, returns and forecast, matters interesting the customer, medical information, etc.
SPORT	• Sports
EDUCATE	• Education
DRAMA	• Drama-Radio serial, etc.
CULTURE	• Culture-National or local culture including the religious problem, social science, language, theater, etc.
SCIENCE	• Natural science and technology
VARIED	• Others-Speech, amusing program (quiz, game), interview, comedy and satirical play, etc.
POP M	• Pop music
ROCK M	• Rock music
M.O.R.M	• M.O.R.- Comfortable music, occasionally vocal
LIGHT M	• Light classical music- Classical music and instrumental and chorus music
CLASSIC	• Heavy classical music-Orchestra music, symphony, chamber music and opera
OTHER M	• Other music - Jazz, R&B, country music
ALARM	• Alarm
TRAFFIC	• Traffic information

About PTY-SEARCH

- 1 Tuned to an FM station broadcasting a PTY MODE.
 - ◆ See the FM receiving method on the page 10.
 - ◆ If the received station is transmitting the RDS information, "RDS" lights up.
 - 2 Press the PTY button.
 - ◆ The PTY MODE(NEWS, AFFARIS, etc) appears on the display.
 - ◆ Press the PRESET/MANUAL DOWN or UP button to select the desired PTY MODE.
- If the station is transmitting no PTY information, 'NO PTY' shows on the display.
- ◆ When the PTY MODE is selected(The PTY MODE is shown in the display), press the PTY KEY once again to convert into PTY-SEARCH MODE and auto-search the station sequentially.
- ◆ If a station is found broadcasting required PTY MODE then the search stops and the stop is selected.

◆ If the PTY MODE isn't found it is returned to the at beginning the PTY SEARCH and auto-search and PTY SEARCH are suspended.

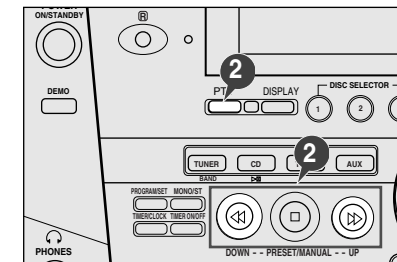

CD DIGITAL OUT Jack (option)

This unit can output CD digital sound signals through this jack. Use an optical cable to connect digital audio equipment. (DAT deck, MD recorder, etc.). Remove the dust cap (1) from the CD DIGITAL OUT jack. Then, connect an optical cable plug to the CD DIGITAL OUT jack.

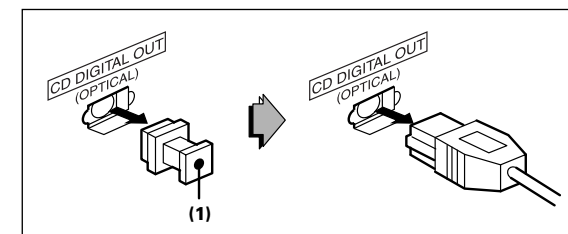

When the CD DIGITAL OUT jack is not being used Attach the supplied dust cap.

Connecting to an External Source

The auxiliary input can be used to take advantage of the sound quality of your mini-compact system when listening to other sources.

- Examples:**
- ◆ A television
 - ◆ A video disc player
 - ◆ A DAT or DCC cassette player
 - ◆ A Hi-Fi stereo video cassette recorder

➤ To connect the external source, the source must have an audio output. In addition, you need an RCA connection cable.

- 1 Set the system to standby mode and disconnect it and the external source from the main.
- 2 Connect the audio cable to the rear of the mini-compact system.

Connect the...	To the connector marked...
Red jack	R (right)
White jack	L (left)

➤ For optimum sound quality, do not invert the right and left channels.
- 3 Plug the system back into the main socket and press POWER to switch it on.
- 4 Select the AUX source by pressing AUX on the front panel or FUNCTION on the remote control one or more times.

Result: AUX is displayed.
- 5 Switch the external source on.
- 6 Adjust the volume and balance as required:
 - ◆ Volume
 - ◆ Equalizer

Example: You can watch a film and take advantage of stereo sound provided that the original sound track is in stereo, (as if you were in a cinema).

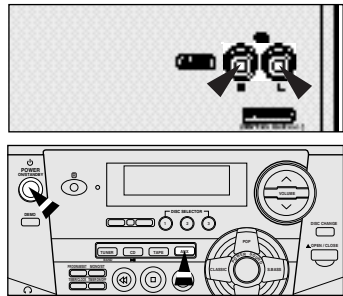

Connecting Headphones

You can connect a set of headphones to your mini-compact system so that you can listen to music or radio programmes without disturbing other people in the room. The earphones must have a 6.3 mm jack or an appropriate adapter.

Connect the headphones to the PHONES jack on the front panel. **Result:** The loudspeakers are no longer used to output the sound.

➤ Prolonged use of headphones at a high volume may damage your hearing.

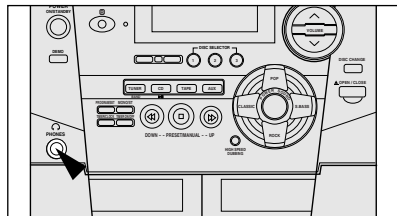

Safety Precautions

The following diagrams illustrate the precautions to be taken when using or moving your mini-compact system.

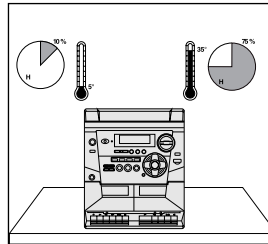

Ambient operating conditions:
 Ambient temperature 5°C-35°C
 Humidity 10-75%

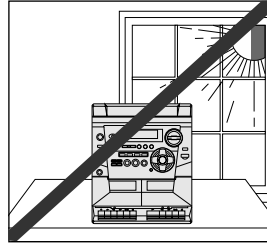

Do not expose the unit to direct sun radiation or other heat sources. This could lead to overheating and malfunction of the unit.

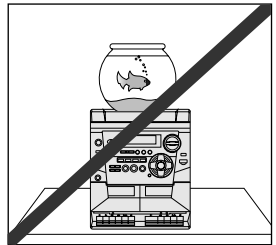

Do not place potted plants or vases on top of the unit. Moisture entering the unit could lead to dangerous electric shock and can cause equipment damage. In such events immediately disconnect the main plug from the socket.

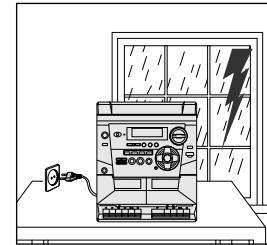

During thunderstorms, disconnect the main plug from the socket. Main voltage peaks due to lightning could damage the unit.

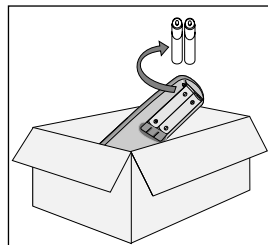

Remove the batteries from the remote control, if not used for any extended periods. Leaking batteries can cause serious damage to the remote control.

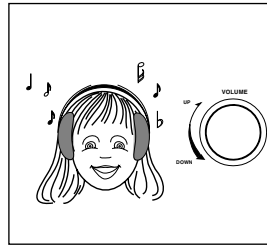

When using headphones, take care not to listen at excessive volumes. Extended use of headphones at high volumes will lead to hearing damage.

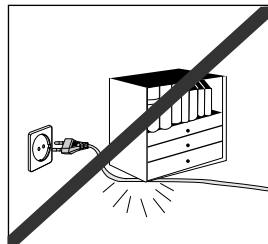

Do not place heavy items on the main lead. Main cable damage can lead to damage of the equipment (fire hazard) and can cause electric shock.

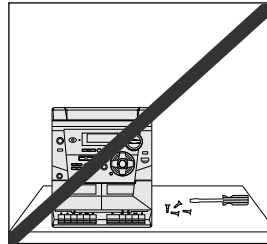

Do not remove any equipment panels. The inside of the unit contains live components, which cause electric shock.

Cleaning Your Mini-Compact System

To obtain the best possible results from your mini-compact system, you must clean the following elements regularly:

- ◆ The outer casing
 - ◆ The compact disc player
 - ◆ The cassette players (heads, rollers and drive capstans)
- Always unplug the system from the wall outlet:
- ◆ Before cleaning it
 - ◆ If you are not going to be using it for a long time

Outer Casing

Clean the outer casing regularly using a soft cloth and a light detergent. Do not use abrasive powders, liquids or aerosol cleaners. Never let any liquids get into the system.

Compact Disc Player

1 Before playing a compact disc, clean it with a special CD cleaning agent. Do not use the same cleaning agents as for vinyl LP records. Carefully wipe the disc from the centre outwards.

2 Regularly clean the player with a special cleaning disc (available from your local dealer).

Tape Decks

- 1 Press STOP/EJECT (■▲) to open the cassette deck.
 - 2 Use a cotton bud and a special cassette cleaning agent to clean the:
 - ◆ Head (1)
 - ◆ Rollers (2)
 - ◆ Drive capstans (3)
- If you will not be using the remote control for a long time, remove the batteries to prevent corrosion.
- ◆ Although your system is very hard-wearing, it should not be used in an excessively dusty environment or subjected to shocks or extreme heat (close to heating appliances or in direct sunlight, etc.).
- ◆ If the unit emits an unpleasant odour when in use, unplug it from the main supply and contact the after-sales service.

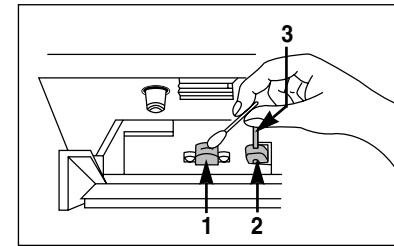

Precautions When Using Compact Discs

- ◆ Handle your compact discs with care. Always hold them by the edges to avoid leaving fingerprints on the shiny surface.
- ◆ When you have finished playing a compact disc, always put it back in its case.
- ◆ Do not fix paper or adhesive tape to the discs and do not write on the label.
- ◆ Clean them with a special-purpose cloth.
- ◆ Store your compact discs in a clean place, out of direct sunlight, where they will not be exposed to high temperatures.
- ◆ Always use compact discs marked

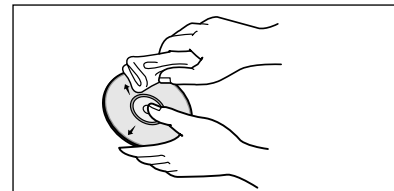

Precautions When Using Audio Cassettes

- ◆ Check that the tape in the cassette is sufficiently taut.
- ◆ To prevent erasing a cassette that you wish to keep, remove the safety tab on the upper edge of the cassette. To record a cassette, where the tab has been broken, simply cover the opening with adhesive tape.
- ◆ When you have finished playing a cassette, always put it back in its case.
- ◆ Store your cassettes in a clean place, out of direct sunlight, where they will not be exposed to high temperatures.
- ◆ Avoid using 120-minute cassettes as they place unnecessary strain on the tape mechanism.

Before Contacting the After-Sales Service

It always takes a little time to become familiar with a new appliance. If you have any of the problems listed below, try the solutions given. They may save you the time and inconvenience of an unnecessary service call.

Problem	Checks/Explanation
The system does not work	<ul style="list-style-type: none"> • The main lead is not correctly plugged into a wall socket or the wall socket is not switched on. • The remote control batteries need replacing or the polarity has not been respected. • The POWER button has not been pressed.
There is no sound	<ul style="list-style-type: none"> • The volume has been completely turned down. • The correct function (TUNER, CD, AUX) has not been selected. • You have connected a set of earphones. • The loudspeaker wires have been disconnected. • The MUTE button has been pressed.
The Timer does not work	<ul style="list-style-type: none"> • The timer has been stopped by pressing TIMER ON/OFF.
The compact disc player does not start playing	<ul style="list-style-type: none"> • The CD function has not been selected. • The disc has been inserted face down or is either dirty or scratched. • The laser sensor is dirty or dusty. • The system has not been installed on a flat, horizontal surface. • Condensation has formed in the player; leave the system in a warm, airy room for at least one hour.
The tape does not start playing	<ul style="list-style-type: none"> • The TAPE function has not been selected. • The cassette has not been inserted correctly. • The cassette player has not been closed. • The tape is either slack or broken.
The volume falls off	<ul style="list-style-type: none"> • The audio heads are dirty.
The cassette is not erased correctly	<ul style="list-style-type: none"> • The rollers or drive capstans are dirty.
There is excessive wow and flutter	<ul style="list-style-type: none"> • The tape is worn.
Reception is poor or no radio stations are received at all	<ul style="list-style-type: none"> • The TUNER function has not been selected. • The radio frequency has not been correctly selected. • The aerial has been disconnected or is not facing the right way. Turn it until you find the best orientation. • You are in a building that blocks radio waves; you must use an outside aerial.

If the above guidelines do not allow you to solve the problem, take a note of:

- ◆ The model and serial numbers, normally printed on the rear of the system
- ◆ Your warranty details
- ◆ A clear description of the problem

Then contact your local dealer or SAMSUNG after-sales service.

Front Panel View

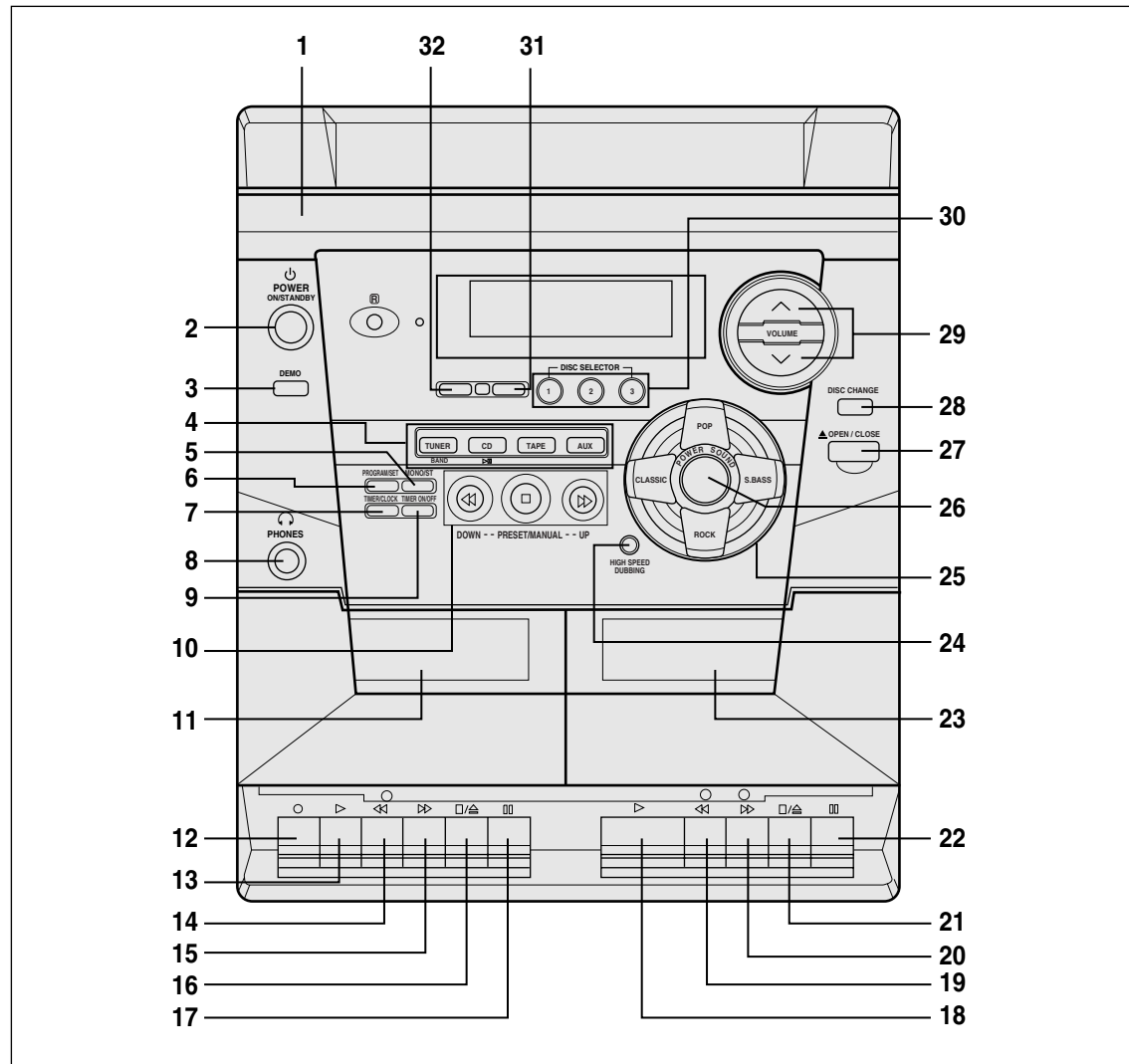

- | | |
|-------------------------------|----------------------------------|
| 1. COMPACT DISC COMPARTMENT | 17. PAUSE |
| 2. POWER/STANDBY BUTTON | 18. PLAY |
| 3. DEMO | 19. REWIND |
| 4. FUNCTION SELECTION buttons | 20. FAST-FORWARD |
| 5. MONO/ST | 21. STOP/EJECT |
| 6. PROGRAM/SET | 22. PAUSE |
| 7. TIMER/CLOCK | 23. CASSETTE DECK 2 |
| 8. HEADPHONE JACK CONNECTOR | 24. HIGH SPEED DUBBING |
| 9. TIMER ON/OFF | 25. EQUALIZER SELECTION buttons |
| 10. PRESET/MANUAL(DOWN/UP) | 26. POWER SOUND |
| 11. CASSETTE DECK 1 | 27. CD COMPARTMENT OPEN/CLOSE |
| 12. RECORD | 28. DISC CHANGE |
| 13. PLAY | 29. VOLUME |
| 14. REWIND | 30. DISC SELECTION buttons |
| 15. FAST-FORWARD | 31. DISPLAY/AI OFF/SLEEP(OPTION) |
| 16. STOP/EJECT | 32. PTY/CD REPEAT(OPTION) |

Remote Control

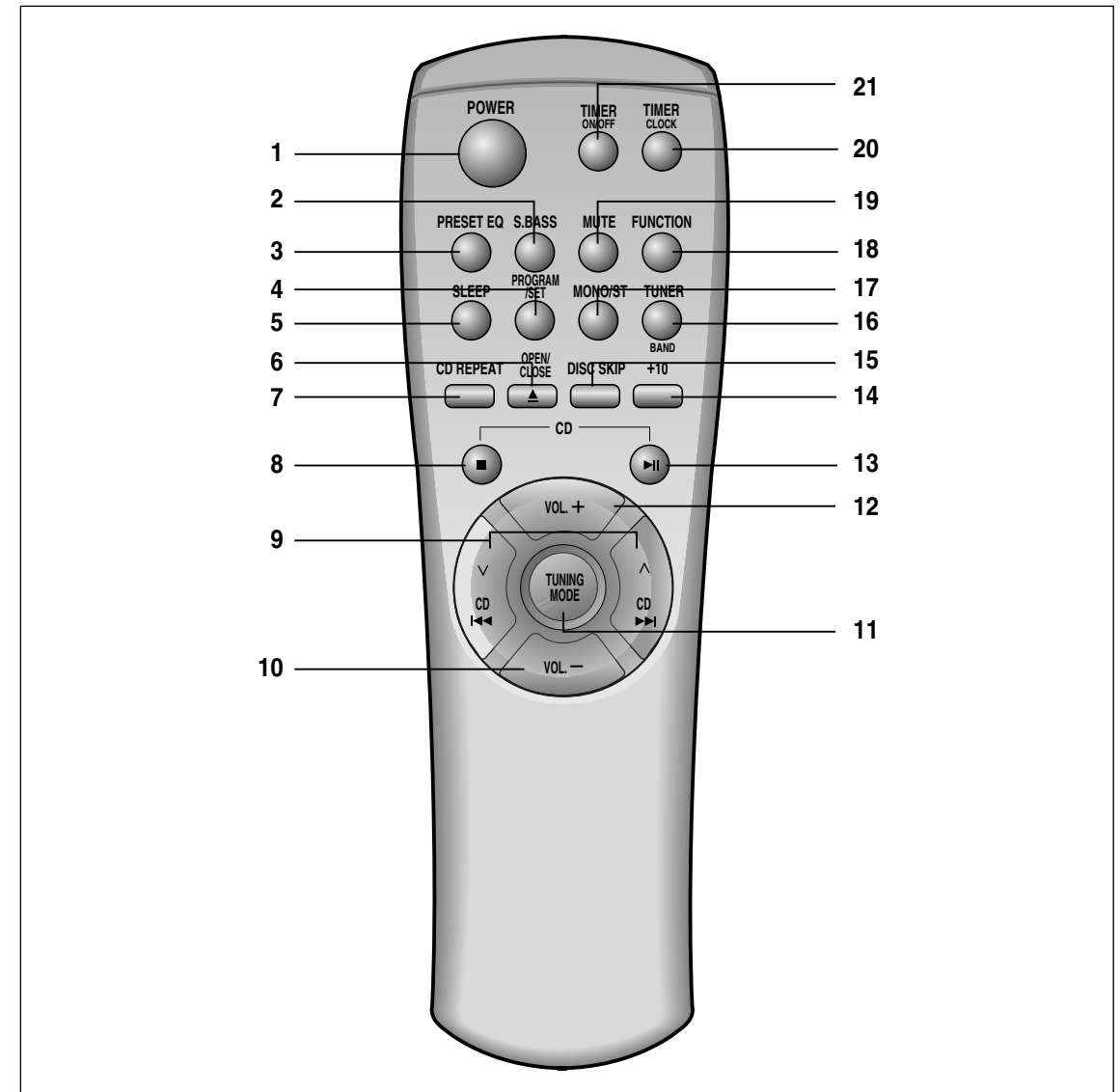

- | | |
|-------------------------------------|-------------------------------|
| 1. POWER/STANDBY | 11. TUNING MODE |
| 2. S. BASS | 12. VOLUME INCREASE |
| 3. EQUALIZER MODE SELECTION | 13. PLAYBACK/PAUSE |
| 4. PROGRAM/SET | 14. TWO-DIGIT TRACK SELECTION |
| 5. SLEEP | 15. DISC NUMBER SKIP |
| 6. OPEN/CLOSE | 16. FREQUENCY BAND SELECTION |
| 7. CD TRACK REPEAT | 17. MONO/STEREO SELECTION |
| 8. STOP | 18. FUNCTION SELECTION |
| 9. CD TRACK OR RADIO STATION SEARCH | 19. MUTE |
| 10. VOLUME DECREASE | 20. TIMER CLOCK |
| | 21. TIMER SWITCH ON AND OFF |

Rear Panel View

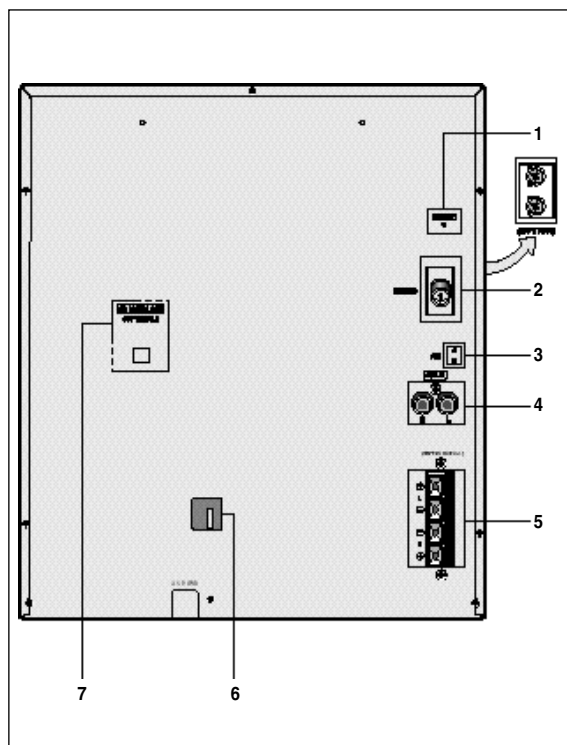

1. SW AERIAL CONNECTOR TERMINAL (OPTION)
2. FM AERIAL CONNECTOR TERMINALS
3. AM AERIAL CONNECTOR TERMINAL
4. AUX-INPUT
5. LOUDSPEAKER CONNECTOR TERMINALS
6. VOLTAGE SELECTOR (OPTION)
7. CD DIGITAL OUT JACK (OPTION)

Technical Specifications

SAMSUNG strives to improve its products at all times. Both the design specifications and these user instructions are thus subject to change without notice.

RADIO

Long and medium wave

LW (OPTION)

Usable sensitivity 1000 μ V

SW (OPTION)

Usable sensitivity 80 μ V

MW (AM)

Signal/noise ratio 40 dB

Usable sensitivity 500 μ V

Total harmonic distortion 2 %

FM

Signal/noise ratio 60 dB

Usable sensitivity 3 μ V

Total harmonic distortion 0.5 %

COMPACT DISC PLAYER

Capacity 3 discs

Frequency range 20 Hz - 20 KHz (\pm 1 dB)

Signal/noise ratio 90 dB (at 1 KHz) with filter

Distortion 0.05 % (at 1 KHz)

Channel separation 80 dB

Disc sizes Diameter: 120 or 80 mm. Thickness: 1.2 mm

TAPE DECK

Frequency range 125 Hz ~ 8 KHz

Signal/noise ratio 40 dB

Channel separation 33 dB

Erasing effect 60 dB

AMPLIFIER

Output power (6 Ω) 2 x 15 Watts RMS (total harmonic distortion: 10 %)

Channel separation 50 dB

Signal/noise ratio 75 dB

GENERAL

Dimensions 270 (W) x 317 (H) x 340 (D) mm

THIS APPLIANCE IS MANUFACTURED BY:

SAMSUNG
ELECTRONICS