

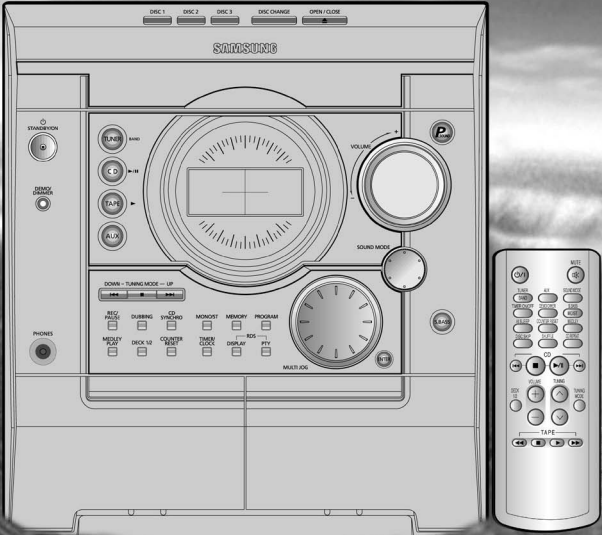

THREE-CD CHANGER MINI-COMPACT SYSTEM CD-R/RW PLAYBACK MAX-J530

Instruction Manual



Safety Warnings

CLASS 1 LASER PRODUCT
KLASSE 1 LASER PRODUKT
LUOKAN 1 LASER LAITE
KLASS 1 LASER APPARAT
PRODUCTO LASER CLASE 1

Use of controls, adjustments or performance of procedures other than those specified herein may result in hazardous radiation exposure.

CAUTION-INVISIBLE LASER RADIATION WHEN OPEN AND INTERLOCKS DEFEATED, AVOID EXPOSURE TO BEAM.



CAUTION
RISK OF ELECTRIC SHOCK.
DO NOT OPEN



This symbol indicates that dangerous voltage which can cause electric shock is present inside this unit.



This symbol alerts you to important operating and maintenance instructions accompanying the unit.

CAUTION:
TO REDUCE THE RISK OF ELECTRIC SHOCK, DO NOT REMOVE REAR COVER. NO USER SERVICEABLE PARTS INSIDE. REFER SERVICING TO QUALIFIED SERVICE PERSONNEL.

WARNING: To reduce the risk of fire or electric shock, do not expose this appliance to rain or moisture.

CLASS 1 LASER PRODUCT

This Compact Disc player is classified as a CLASS 1 LASER product.

CAUTION: TO PREVENT ELECTRIC SHOCK, MATCH WIDE BLADE OF PLUG TO WIDE SLOT, FULLY INSERT.

Wiring the Main Power Supply Plug(UK Only)

IMPORTANT NOTICE

The main lead on this equipment is supplied with a moulded plug incorporating a fuse. The value of the fuse is indicated on the pin face of the plug and if it requires replacing, a fuse approved to BS1362 of the same rating must be used.

Never use the plug with the fuse cover removed. If the cover is detachable and a replacement is required, it must be of the same colour as the fuse fitted in the plug. Replacement covers are available from your dealer.

If the fitted plug is not suitable for the power points in your house or the cable is not long enough to reach a power point, you should obtain a suitable safety approved extension lead or consult your dealer for assistance.

However, if there is no alternative to cutting off the plug, remove the fuse and then safely dispose of the plug. Do not connect the plug to a main socket as there is a risk of shock hazard from the bared flexible cord.

Never attempt to insert bare wires directly into a main socket. A plug and fuse must be used at all times.

IMPORTANT

The wires in the main lead are coloured in accordance with the following code:-

BLUE = NEUTRAL BROWN = LIVE

As these colours may not correspond to the coloured markings identifying the terminals in your plug, proceed as follows:-

The wire coloured BLUE must be connected to the terminal marked with the letter N or coloured BLUE or BLACK.

The wire coloured BROWN must be connected to the terminal marked with the letter L or coloured BROWN or RED.

WARNING: DO NOT CONNECT EITHER WIRE TO THE EARTH TERMINAL WHICH IS MARKED WITH THE LETTER E OR BY THE EARTH SYMBOL \equiv , OR COLOURED GREEN OR GREEN AND YELLOW.

◆ SAFETY WARNINGS	2
◆ INSTALLING YOUR MINI-COMPACT SYSTEM	
■ Front Panel View	4
■ Display Window	5
■ Remote Control	5
■ Rear Panel View	6
■ Where to Install Your Mini-Compact System	7
■ Connecting your System to the Power Supply	7
■ Inserting Remote Control Batteries	7
■ Connecting the Loudspeakers	7
■ Connecting to an External Source	8
■ Connecting the AM (MW/LW) Aerial	8
■ Connecting the FM Aerial	8
■ Demo/Dimmer function	9
■ Setting the Clock	9
◆ CD-PLAYER	
■ Loading and Changing Compact Discs	10
■ Listening to a Compact Disc	10
■ Selecting a CD in the Disc changer	11
■ Selecting a Track	11
■ Searching for a Specific Music Passage on a CD	11
■ Shuffle Play Function	11
■ Medley Play	12
■ Repeating One or All Tracks on the Compact Discs	12
■ Programming the Order of CD Playback	13
■ Checking or Changing Programmed CD Tracks	13
◆ TUNER	
■ Searching for and Storing the Radio Stations	14
■ Selecting a Stored Station	15
■ Improving Radio Reception	15
■ About RDS broadcasting	16
■ About RDS DISPLAY function	16
■ PTY (Program Type) indication and PTY-SEARCH function	17
◆ TAPE DECK	
■ Listening to a Cassette	18
■ CD Synchro Record Feature	18
■ Recording a Compact Disc	18
■ Recording a Radio Program	19
■ Copying a Cassette (Dubbing)	19
■ Tape Counter	19
◆ OTHER FUNCTIONS	
■ Timer Function	20
■ Cancelling the Timer	20
■ Mute Function	21
■ Selecting Sound Mode	21
■ Power Sound Function	21
■ Setting the System to Switch off Automatically	22
■ S.BASS Function	22
■ Connecting Headphones	22
◆ RECOMMENDATIONS FOR USE	
■ Safety Precautions	23
■ Cleaning Your Mini-Compact System	23
■ Precautions When Using Compact Discs	24
■ Precautions When Using Audio Cassettes	24
■ Before Contacting the After-Sales Service	24
■ Technical Specifications	25



Press



Push

Symbols



Important



Note

Front Panel View

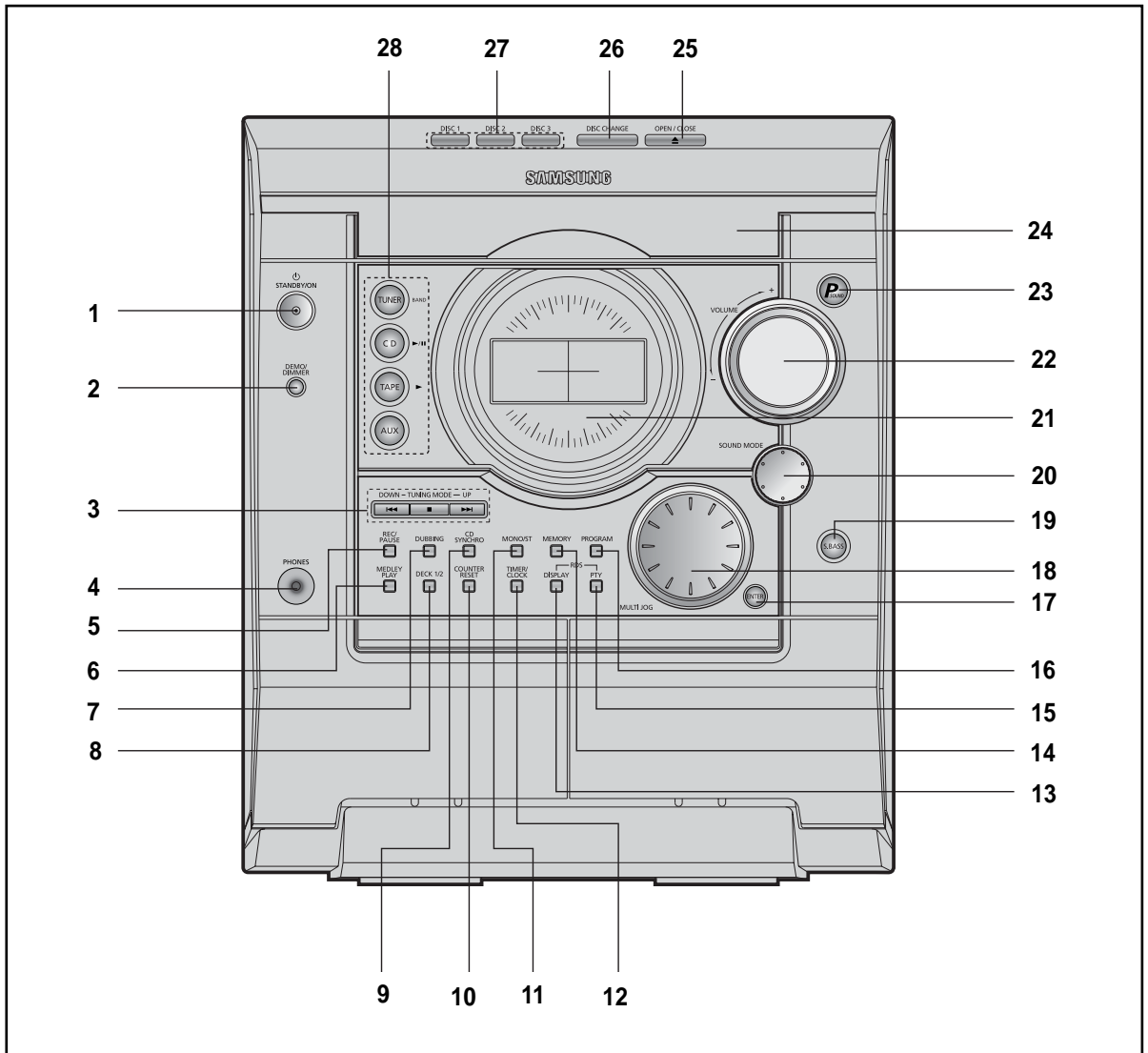

- | | |
|--|--------------------------------|
| 1. STANDBY/ON | 17. ENTER |
| 2. DEMO/DIMMER | 18. MULTI JOG |
| 3. TUNING MODE / Stop buttons
and Search Function buttons | 19. S.BASS |
| 4. PHONES | 20. SOUND MODE |
| 5. REC/PAUSE | 21. Window Display |
| 6. MEDLEY PLAY | 22. VOLUME |
| 7. DUBBING | 23. P.SOUND |
| 8. DECK 1/2 | 24. Compact Disc Compartment |
| 9. CD SYNCHRO | 25. CD Open/Close |
| 10. COUNTER RESET | 26. DISC CHANGE |
| 11. MONO/ST | 27. Disc Selection buttons |
| 12. TIMER/CLOCK | 28. Function Selection buttons |
| 13. RDS DISPLAY | |
| 14. MEMORY | |
| 15. RDS PTY | |
| 16. PROGRAM | |

Window Display

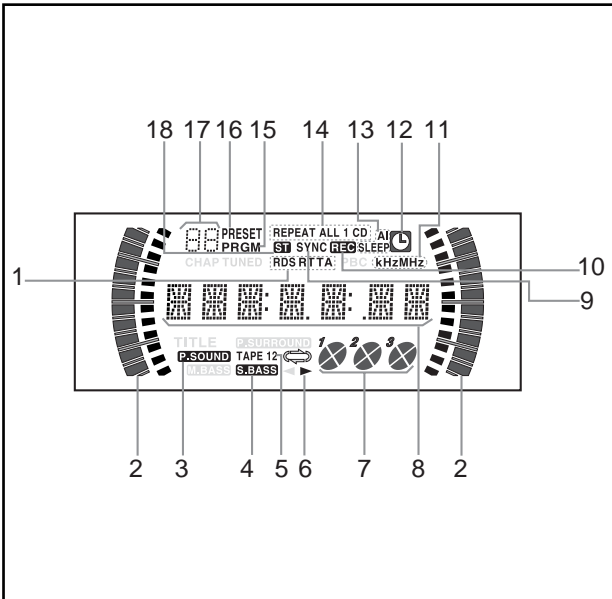

1. RDS
2. Volume
3. POWER SOUND
4. SUPER BASS
5. TAPE 1/2
6. TAPE RUNNING INDICATOR
7. PLAYING DISC NUMBER
8. MAIN DISPLAY(FUNCTION,FREQUENCY,TIME,ETC.)
9. CD SYNCHRO RECORDING
10. RECORDING
11. TUNER FREQUENCY UNIT
12. CLOCK
13. AI SLEEP OR SLEEP
14. CD PLAYING DISC MODE OR CD REPEAT MODE
15. CD PROGRAM OR TUNER MEMORY TO PROGRAM
16. TUNER PRESET
17. CD PROGRAM AND TUNER PRESET NUMBER
18. FM MODE (STEREO)

Remote Control

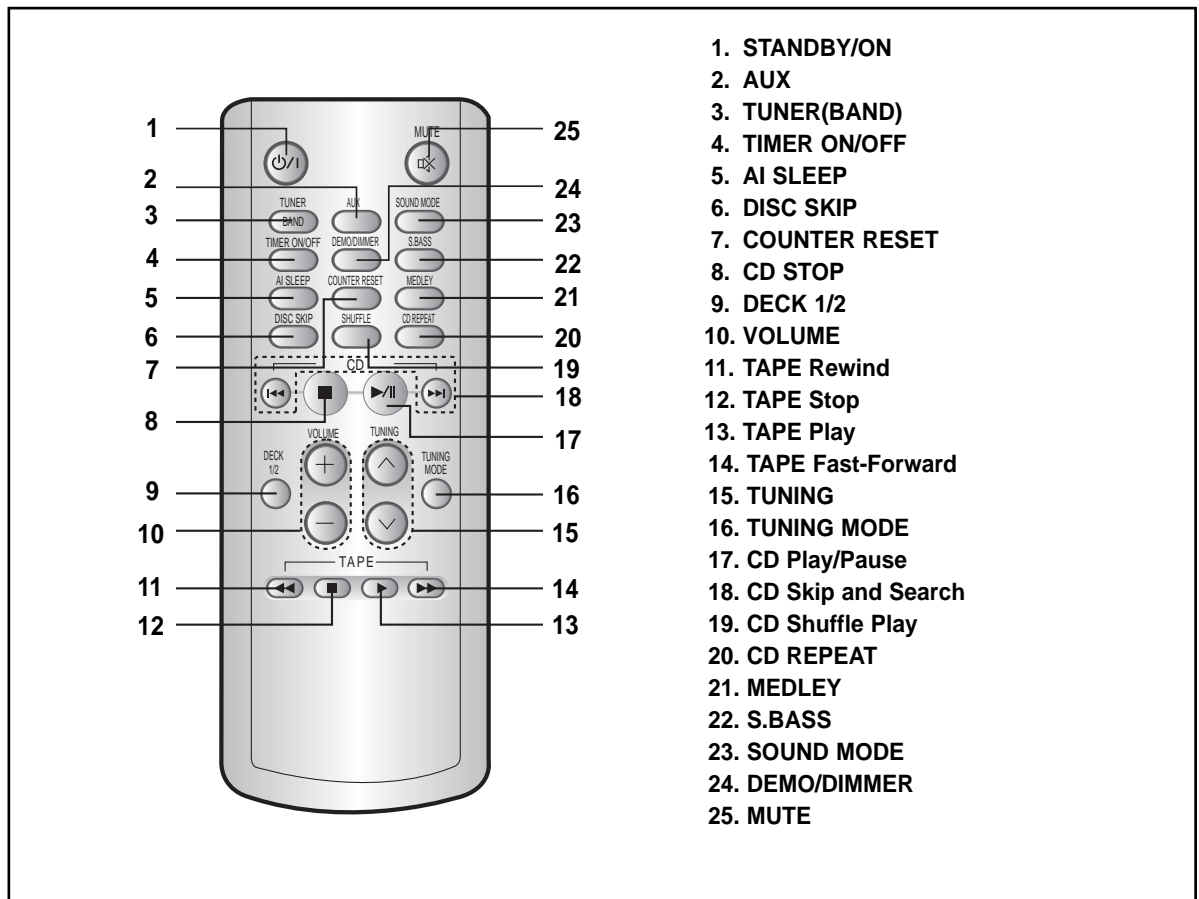

1. STANDBY/ON
2. AUX
3. TUNER(BAND)
4. TIMER ON/OFF
5. AI SLEEP
6. DISC SKIP
7. VOLUME
8. TAPE Rewind
9. TAPE Stop
10. VOLUME
11. TAPE Rewind
12. TAPE Stop
13. TAPE Play
14. TAPE Fast-Forward
15. TUNING
16. TUNING MODE
17. CD Play/Pause
18. CD Skip and Search
19. CD Shuffle Play
20. CD REPEAT
21. MEDLEY
22. S.BASS
23. SOUND MODE
24. DEMO/DIMMER
25. MUTE

Rear Panel View

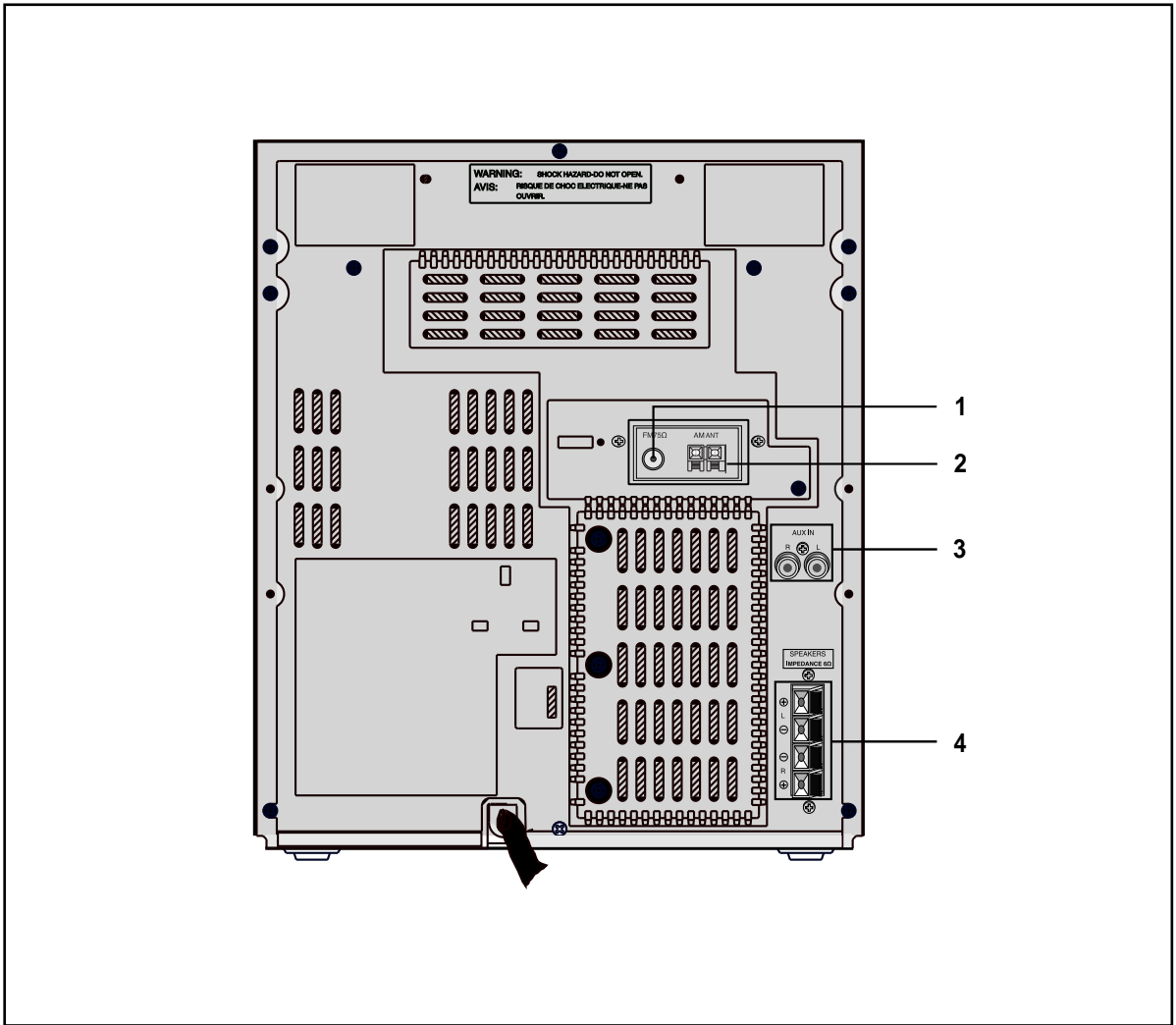

- 1. FM Aerial Connector Terminal
- 2. AM Aerial Connector Terminals
- 3. AUX-Input
- 4. Loudspeaker Connector Terminals

Where to Install Your Mini-Compact System

To take full advantage of your new mini-compact system, follow these installation instructions before connecting the unit.

- ◆ Install the system on a flat, stable surface.
- ◆ Never place this unit on carpeting.
- ◆ Never place this unit in an outdoor area.
- ◆ Maintain an open space of approximately 6 inches (15 cm) on the sides and rear of the system, for ventilation purposes.
- ◆ Make sure that you have enough room to open the compact disc compartment easily.
- ◆ Place the loudspeakers at a reasonable distance on either side of the system to ensure good stereo sound.
- ◆ Direct the loudspeakers towards the listening area.
- ◆ For optimum performance, make sure that both speakers are placed at an equal distance above the floor.

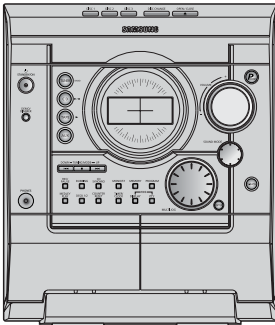

Connecting your System to the Power Supply

The main lead must be plugged into an appropriate socket.

- ☛ Before plugging your system into a main socket, you must check the voltage.

- 1 Plug the main lead into an appropriate socket.
- 2 Press the **STANDBY/ON** button to switch your mini-compact system on.

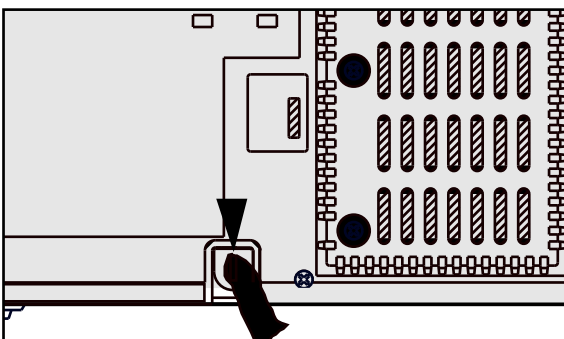

Inserting Remote Control Batteries

GB

Insert or replace remote control batteries when you:

- ◆ Purchase the mini-compact system
- ◆ Find that the remote control is no longer operating correctly

- ☛ When replacing the batteries, use a new set of batteries and never mix alkaline and manganese batteries.

- 1 Place your thumb on the position marked ^{PRESS} ▼ on the battery compartment cover (rear of the remote control) and push the cover in the direction of the arrow.
- 2 Insert two AAA, LR03 or equivalent batteries, taking care to respect the polarities:
 - ◆ + on the battery against + in the battery compartment
 - ◆ - on the battery against - in the battery compartment
- 3 Replace the cover by sliding it back until it clicks into position.

- If you will not be using the remote control for a long time, remove the batteries to prevent corrosion.

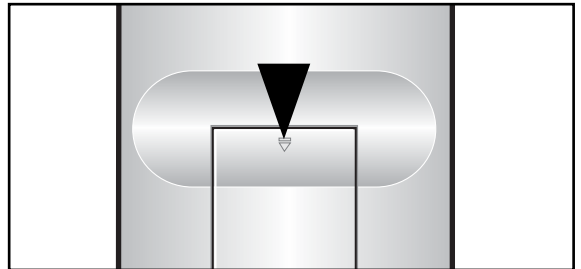

Connecting the Loudspeakers

The loudspeaker connector terminals are located on the rear of the system.

There are four terminals on the system:

- ◆ Two for the left speaker (marked L)
- ◆ Two for the right speaker (marked R)

To achieve the correct sound quality, connect the:

- ◆ Red wire to the + terminals
- ◆ Black wire to the - terminals

- 1 Press and hold the terminal tab.
- 2 Insert the speaker cord.
- 3 Release the finger.

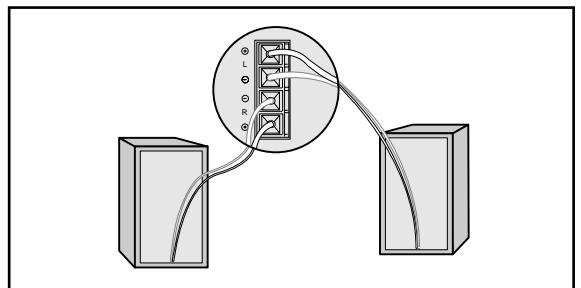

Connecting to an External Source



The auxiliary input can be used to take advantage of the sound quality of your mini-compact system when listening to other sources.

Examples:

- ◆ A television
- ◆ A video disc player
- ◆ A Hi-Fi stereo video cassette recorder

➤ To connect to the external source, the source must have an audio output. In addition, you need an RCA connection cable.

1 Set the system to standby mode and disconnect it and the external source from the main socket.

2 Connect the audio cable to the rear of the mini-compact system.

Connect the...	To the connector marked...
Red jack	R (right)
White jack	L (left)

➤ For optimum sound quality, do not invert the right and left channels.

3 Plug the system back into the main socket and press **STANDBY/ON** to switch it on.

4 Select the AUX source by pressing **AUX**.
Result: AUX is displayed.

5 Switch the external source on.

6 Adjust the volume and balance as required:
◆ Volume ◆ Equalizer

Example: You can watch a film and take advantage of stereo sound provided that the original sound track is in stereo (as if you were in a cinema).

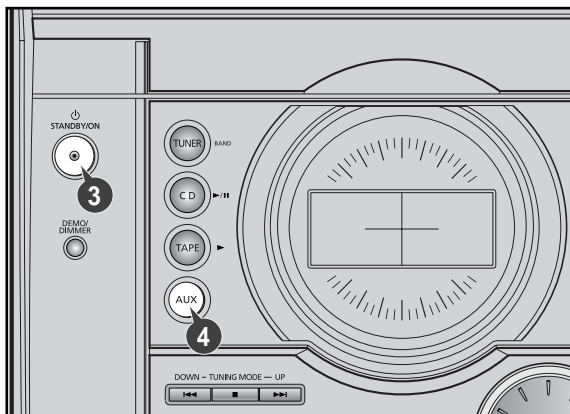
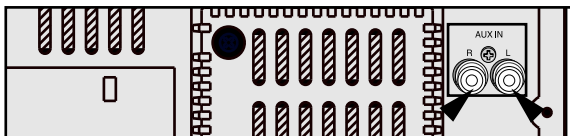

Connecting the AM (MW)/LW Aerial

The AM aerial (for long and medium waves) can be:

- ◆ Placed on a stable surface
 - ◆ Fixed to the wall (you must first remove the base)
- The **AM** aerial connector terminals are located on the rear of the system and are marked **AM**.

➤ To avoid noise interference, check that the loudspeaker wires do not run close to the aerial wires. Always keep them at least 2 inches (5 cm) away.

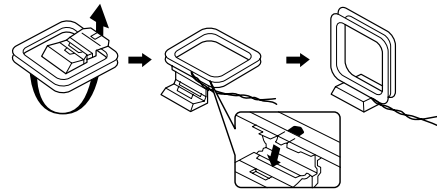
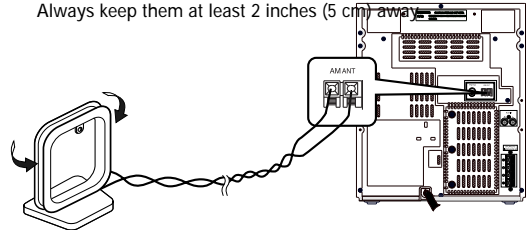

Connecting the FM Aerial

How to connect a COAXIAL TYPE aerial.

- ◆ Connect a 75Ω antenna to the **FM** antenna terminal.
- ◆ Plug the connector on the **FM** aerial supplied into the coaxial socket (75Ω) marked **FM** on the rear of the system.
- ◆ Follow the instructions given on Page 14 to tune into a radio station, and determine the best position for the aerial.
- ◆ If reception is poor, you may need to install an outdoor aerial. To do so, connect an outdoor **FM** aerial to the **FM** socket on the rear of the system using a 75Ω coaxial cable (not supplied).

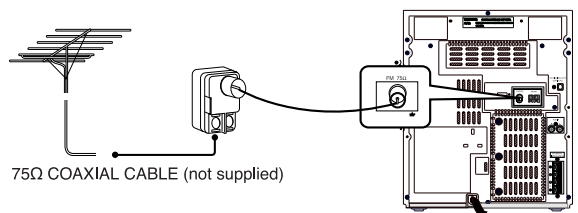
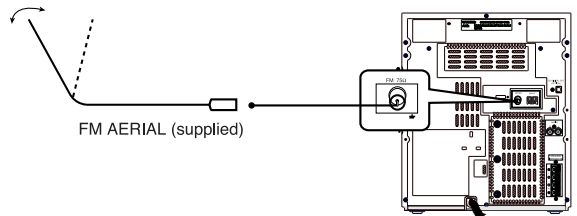

DEMO/DIMMER function

All functions available on the system can be viewed on the display and the display's brightness can be switched between "on" and "off".

- 1 Press the **DEMO/DIMMER** button.
Result: All functions available on the system appear on the front panel display.
- Each of these are explained in detail in this guide. Please refer to the relevant section.
- 2 Press the **DEMO/DIMMER** button again.
Result: The Dimmer function is selected and the display darkens.
 - 3 Press the **DEMO/DIMMER** button once again to brighten the front panel display.
- A display brightness control can only be performed while the system power is on.

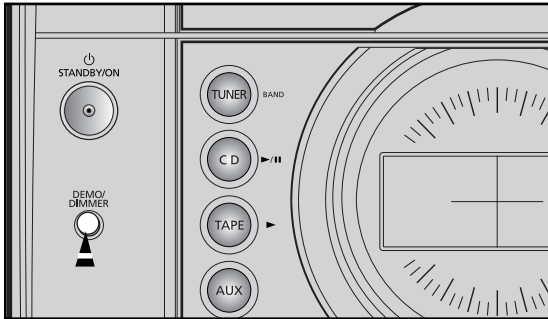

Setting the Clock

Your system is equipped with a clock which allows you to turn your system on and off automatically. You should set the clock:

- ◆ When you first purchase the mini-compact system
 - ◆ After a power failure
 - ◆ After unplugging the unit
- ◆ For each step, you have a few seconds to set the required options. If you exceed this time, you must start again.

- 1 Switch the system on by pressing **STANDBY/ON**.
- 2 Press **TIMER/CLOCK** twice.
Result: **CLOCK** is displayed.
- 3 Press **ENTER**.
Result: The hour flashes.
- 4 **To...** Turn the **MULTI JOG** knob to the...
Increase the hours Right
Decrease the hours Left
- 5 When the correct hour is displayed, press **ENTER**.
Result: The minutes flash.
- 6 **To...** Turn the **MULTI JOG** knob to the...
Increase the minutes Right
Decrease the minutes Left
- 7 When the correct time is displayed, press **ENTER**.
Result: The clock starts and is displayed, even when the system is in standby mode.

- ◆ You can display the time, even when you are using another function, by pressing **TIMER/CLOCK** once.
- ◆ You can also use ◀ / ▶ buttons on the panel front or **TUNING** ∨ / ∨ on the remote control to instead of **MULTI JOG** knob in step 4, 6.

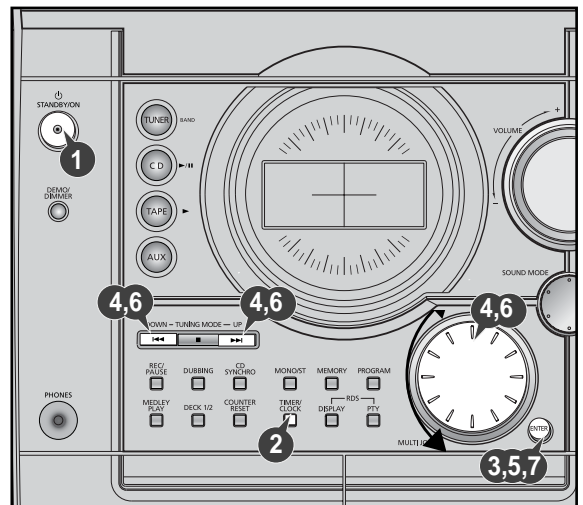

Loading and Changing Compact Discs

GB

The CD disc changer can contain up to three 12 cm or 8 cm compact discs without using an adapter.

- ⚠ Never force the compact disc carousel when opening and closing the compartment.
Never press down or place objects on the carousel.
- Always treat your compact discs with care; refer, if necessary, to the section entitled **"Precautions When Using Compact Discs"** on page 24 .

- 1 Switch the system on by pressing **STANDBY/ON**.
- 2 Press the **OPEN/CLOSE** (▲) button on the front panel.
Result: The compartment opens.
- 3 Place one or two discs in the front slots of the carousel, with the label on the discs facing upwards.
⚠ Check that the compact disc has been correctly inserted in the holder before closing the compartment.
- 4 If you wish to load a third compact disc, press the **DISC CHANGE** button on the front panel (or **DISC SKIP** on the remote control).
Result: The carousel rotates by 120°.
- 5 Close the compartment by pressing the **OPEN/CLOSE** (▲) button again.
➤ If you wish to start playing a disc directly, you can also proceed as follows.

To play...	Press...
Disc 1	CD (▶/) or Disc 1
Disc 2	Disc 2
Disc 3	Disc 3

Result: The compartment closes automatically and the disc selected starts playing.

- 6 To change or unload the compact disc changer, repeat Steps 2 to 5.

- ⚠ Keep the compartment closed whenever you are not using it, to prevent dust from entering.
- You can load or unload compact discs when the radio, tape or auxiliary source function is selected.

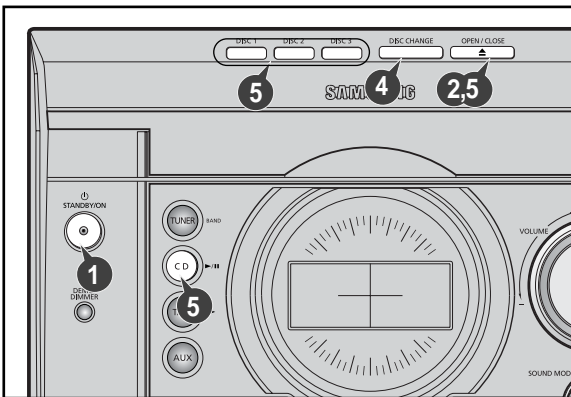

Listening to a Compact Disc

This unit has been designed to playback the CDs: Audio CD, CD Text, CD-R and CD-RW.
When you have loaded at least one compact disc into the player, you can start listening to it.
Continued use of irregular shape CDs (heart-shape, octagonal, etc.) can damage the unit.

- 1 Switch the system on by pressing **Standby/on**.
- 2 Select the CD function by pressing **CD** (▶/||) .
- 3 Load one or more discs.
- 4 Press **CD** (▶/||) on the front panel or ▶/|| on the remote control.
➤ If you have loaded more than one compact disc, they will be played in turn.
- 5 Adjust the volume as required by:
 - ◆ Turning the **VOLUME** knob on the front panel
 - or
 - ◆ Pressing the **VOLUME +** or **-** buttons on the remote control
- 6 To pause temporarily during playback, press **CD** (▶/||) .
➤ Press **CD** (▶/||) again to continue disc playback.
- 7 Press ■ when you want to stop playback.

- ◆ When playing a disc, you can load new discs without stopping the current one. To do so, open the compartment by pressing Disc Change and load new discs in the other two vacant slots (not the one containing the disc that you are playing). You cannot rotate the carousel during playback.
- ◆ When no discs are loaded, the **"NO DISC"** indication is displayed.
- ◆ The CD player stops automatically after playing the three discs, if the CD REPEAT function has not been selected.

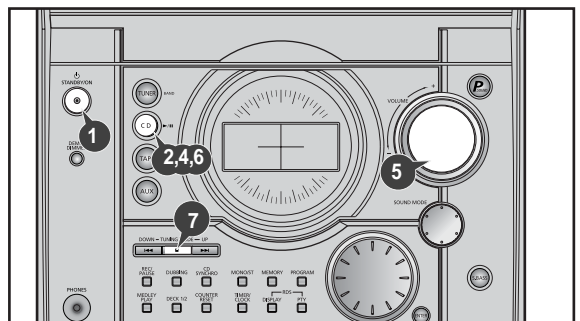

● **When playing a CD-R or CD-RW**
User-edited CD-Rs (Recordable) and CD-RWs (Rewritable) can be played back only if they are already "finalized".

- ◆ You can play back your original CD-Rs or CD-RWs recorded in music CD format. (However, they may be played back depending on their characteristics or recording conditions.)
- ◆ Before playing back CD-Rs or CD-RWs, read their instructions or caution carefully.
- ◆ Some CD-Rs or CD-RWs may not be played back on this unit because of their disc characteristics, damage or stain on them, or if the player's lens is dirty.
- ◆ CD-RWs may require a longer readout time. (This is caused by the fact that reflectance of CD-RWs is lower than for regular CDs.)

Selecting a CD in the Disc changer

The CD function is automatically selected when Disc Skip is pushed.

To select a specific disc, press the corresponding DISC (1, 2, 3) button on the front panel or DISC SKIP on the remote control, until the required disc indicator flashes.

Result: All the discs will be played in turn, starting with the one selected.

- If you wish to play the current disc only, press CD REPEAT on the front panel one or more times, until 1 CD is displayed.
- ♦ If you use the DISC (1, 2, 3) function when listening to the radio or to a tape, the system switches automatically to the CD mode.
- ♦ If the disc selected is not loaded, the next disc is played automatically.
- ♦ When the CD door is opened, if you hold the OPEN/CLOSE button over 5 seconds until "LOCK" is on the display, the CD door will be locked. In the case, you should hold the OPEN/CLOSE button once again until "UNLOCK" is on the display, the CD door will be unlocked.

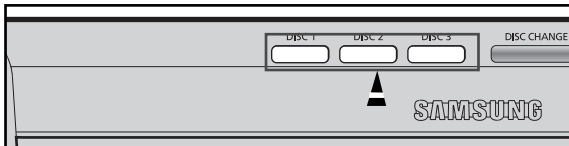

Selecting a Track

You can select the track you wish to listen to, either when the compact disc player is stopped or when a disc is playing.

To start playback at the beginning of the...	Turn the MULTI JOG knob...
Next track	One notch to the right
Current track	One notch to the left
Previous track	Two notches to the left
Track of your choice	The appropriate number of notches to the right or to the left

- ♦ You can also use the ◀◀ and ▶▶ buttons on the front panel, or the ◀◀ and ▶▶ buttons on the remote control to select a track.

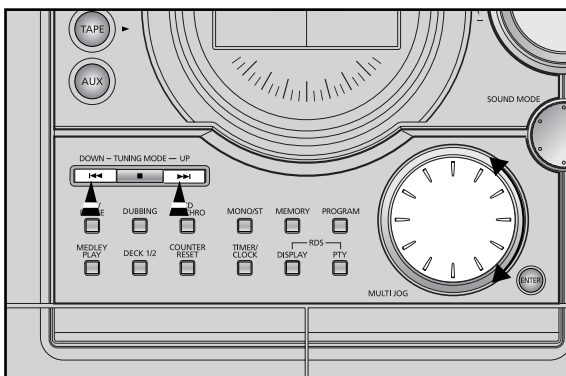

Searching for a Specific Music Passage on a CD

When listening to a compact disc, you can quickly search for a specific music passage on a track.

- It is recommended that you turn the volume down before using this function.

To search through the tracks...	Press and hold down...
Forwards	▶▶ for at least one second
Backwards	◀◀ for at least one second

You can also press and hold down ◀◀ / ▶▶ on the front panel to auto search through the tracks.

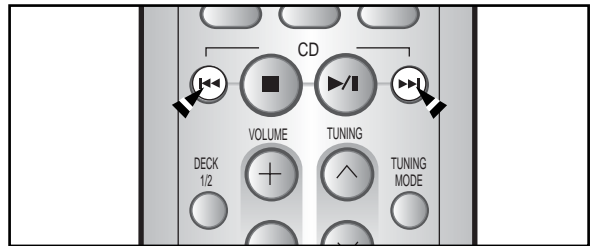

Shuffle Play Function

You can listen to the tracks on a compact disc in a different order each time, as the various tracks will be selected automatically in a random sequence.

- 1 Press the **SHUFFLE** button.
Result: The SHUFFLE (CD) indication appears and all the tracks are played in a random order. Both the track number and the playing time are displayed.
- 2 When playing tracks in a random order, you can:
 - ♦ Move on to the next track (selected at random) by pressing ◀◀/▶▶ or turning **MULTI JOG** one notch to the left or right.
 - ♦ Search quickly for a specific point in the current track by holding ◀◀/▶▶ more than one second.
- 3 To finish the random playback, press ■ or press the **SHUFFLE** button again.

- Repeat and CD Synchro function are not available in Shuffle playing mode.

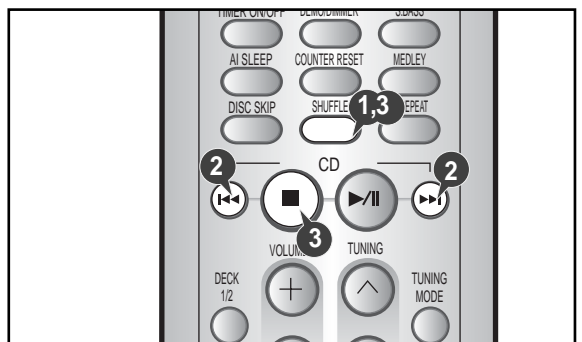

Medley Play



You can select "MEDLEY ON" and "MEDLEY OFF" during playback of a CD.

- 1 Press the **MEDLEY PLAY** button once.
Result: "MEDLEY " is displayed.
◆ The interval time between the tracks can be shorten.
- 2 Press the **MEDLEY PLAY** button again.
◆ Cancel this function,return to normal playback.

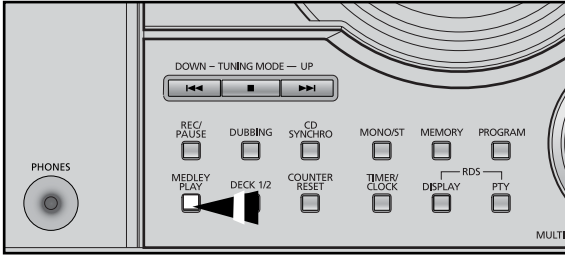

Repeating One or All Tracks on the Compact Discs

You can repeat indefinitely:

- ◆ A specific track on a compact disc.
- ◆ All tracks on the compact disc selected.
- ◆ All discs loaded in the carrousel

- 1 **To repeat...** **Press CD REPEAT on the Remote control once or more times until...**

The current track indefinitely **REPEAT 1** is displayed
 The selected disc **REPEAT 1 CD** is displayed
 All discs loaded **REPEAT ALL CD** is displayed

- 2 When you wish to stop the Repeat function, press **CD REPEAT** until **ALL CD** or **1 CD** is displayed, or press ■ .

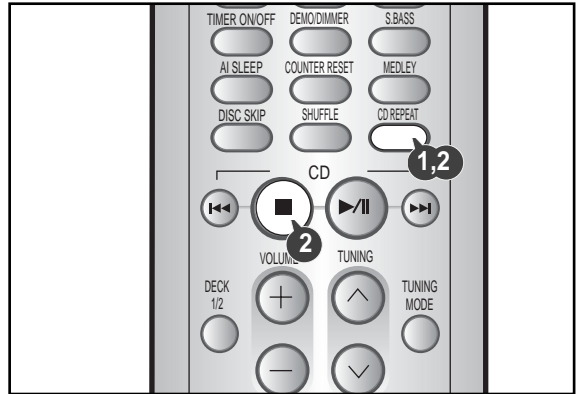

Programming the Order of CD Playback

You can decide:

- ◆ The order in which you listen to the tracks on the discs loaded
- ◆ Which tracks you do not wish to listen to
- ◆ You can program up to 24 tracks.
 - ◆ You must stop the compact disc player before selecting the tracks.
 - ◆ This feature can be combined with the Repeat function.

1 If the CD function is selected, stop the player by pressing ■ .

2 Load the selected CDs.

3 Press **PROGRAM**.
Result: The following indications are displayed:

01 PR1 ---

(01 = Program no., PR1 = Disc no., --- = Track no. on the disc)

4 If necessary, select the disc containing the required track by pressing the corresponding **DISC (1, 2, 3)** button.

5 Select the required track by turning the **MULTI JOG** knob:

- ◆ To the left to move back through the tracks
- ◆ To the right to move forward through the tracks

6 Press **PROGRAM** to confirm your selection.
Result: The selection is stored and 02 PR1 --- is displayed.

7 To select other tracks, repeat Steps 4 to 6.

8 Press **CD (▶/||)** to listen to the track selection in the order programmed.

9 To... Turn the **MULTI JOG** knob...

- | | | |
|-----------------------------------|-------|---|
| Listen to the current track again | | One notch to the left |
| Listen to the previous track | | Two notches to the left |
| Listen to the next track | | One notch to the right |
| Skip forwards or backwards one | | The appropriate number of notches to the right or to the left |
| or more tracks | | |

10 To cancel the selection, press ■ .

- ◆ Once if the compact disc player is stopped
Result: **PRGM** is no longer displayed.
- ◆ If you open the compartment, the selection is cancelled.
- ◆ If you select the number of a disc which is not loaded or a track which does not exist on the CD, the selection skips to the next programmed track.
- ◆ You can also use the ◀▶ buttons to select the required tracks in step 5, 9.

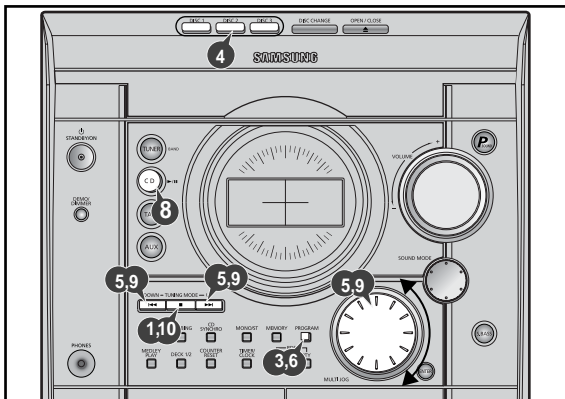

Checking or Changing Programmed CD Tracks

You can check or change your selection of tracks at any time.

1 Press ■ once if you have started listening to the selection.

2 Press **PROGRAM**.
Result: The following indications are displayed:

01 CH1 ---

(CH = Check, 01=Program No, CH1 = Disc No, -- = Track No on the disc)

➤ If you have already programmed 24 tracks, **CH** is displayed instead of **PR** when you press **PROGRAM**.

3 Press **PROGRAM** again.
Result: The first track selected is displayed, together with the letter **CH** (Change).

4 Press **PROGRAM** once or more times until the track to be changed is displayed.

5 If necessary, press the corresponding **Disc (1, 2, 3)** button to change discs.

6 Press ◀▶ and ▶▶ or turn **MULTI JOG** to select a different track.

7 Press **PROGRAM** to confirm your change.

8 Press **CD (▶/||)** to start listening to the selection.
Result: The first track selected is played.

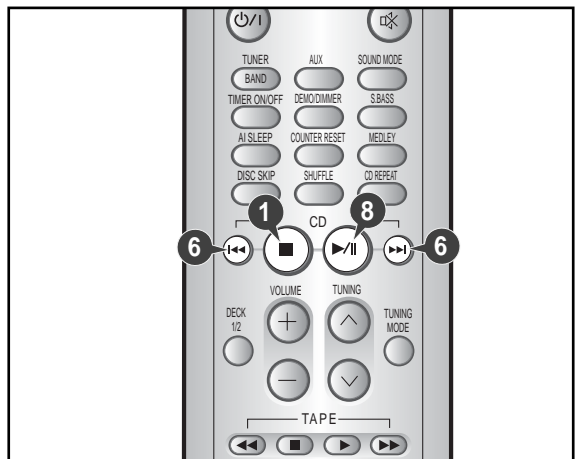
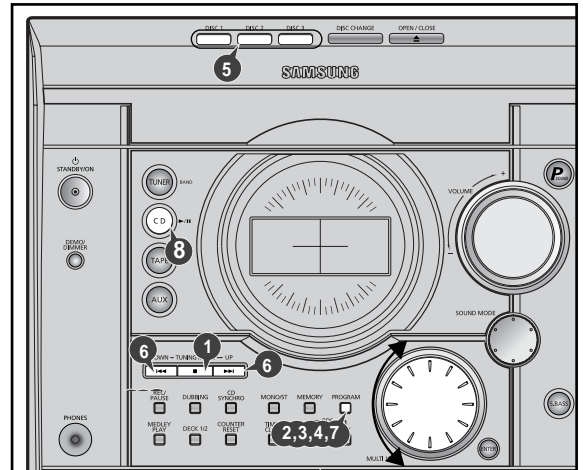

Searching for and Storing the Radio Stations



You can store up to:

- ◆ 15 FM stations or ◆ 15 FM stations
- ◆ 8 MW stations ◆ 15 AM(MW) stations
- ◆ 7 LW stations

- 1 Switch the system on by pressing **STANDBY/ON**.
 - 2 Select the **TUNER** function by pressing **TUNER**.
 - 3 Select the required frequency band by pressing **TUNER (BAND)** again on the front panel or **TUNER (BAND)** on the remote control.
Result: The appropriate indication is displayed:
 - ◆ **FM** Frequency Modulation
 - ◆ **AM (MW)** Medium Wave
 - ◆ **LW (Option)** Long Wave
 - 4 To search for a station... Press **TUNING MODE**
- ManuallyOnce or more times until **MANUAL** is displayed.
- AutomaticallyOnce or more times until **AUTO** is displayed.
- 5 Select the station to be stored by:
 - ◆ Turning the **MULTI JOG** knob to the right or to the left to increase or decrease the frequency respectively
 or
 - ◆ Pressing **TUNING** \vee or \wedge on the remote control
 - ◆ To scroll through the frequencies faster when searching manually, hold down the **TUNING Down** or **Up** buttons.
 - ◆ The automatic search procedure may stop on a frequency that does not correspond to a radio station. If this happens, use the manual search mode.
 - 6 Adjust the volume by:
 - ◆ Turning the **VOLUME** knob on the front panel
 or
 - ◆ Pressing the **VOLUME +** or **-** buttons on the remote control
 - 7 Select the FM stereo or mono mode by pressing **MONO/ST**.
 - 8 If you do not want to store the radio station found, revert to Step 4 and search for another station.
 Otherwise:
 - a Press **MEMORY**.
Result: The **PRGM** is displayed for a few seconds.
 - b Press **TUNING Down** and **Up** to assign a program number .
 - c Press **MEMORY** to store the radio station.
Result: **PRGM** is no longer flashed and the station is stored.
 - 9 To store any other radio frequencies required, repeat Steps 3 to 8.
- ◆ The **PROGRAM** function can be used to assign a new station to an existing program number.

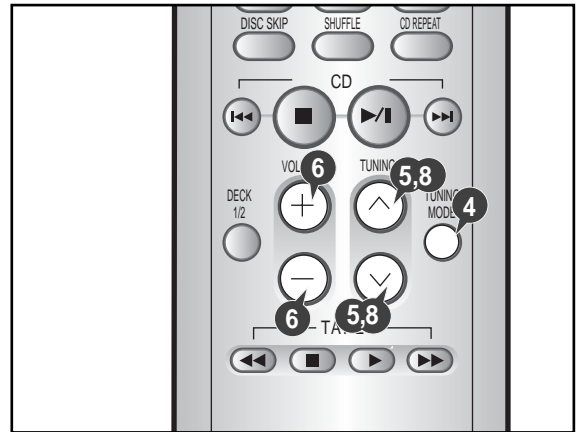
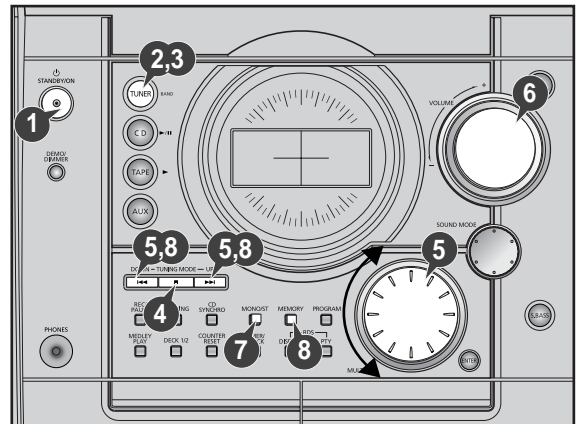

In Tuner mode

- ◆ In manual tuning mode, you can use **MULTI JOG** or \lll / \ggg button on the panel front to manual search a radio station.
- ◆ During Tuner auto searching, press \blacksquare button to stop auto searching.
- ◆ In Preset tuning mode, you can use **MULTI JOG** or \lll / \ggg button on the panel front to search a stored radio station.

Selecting a Stored Station

You can listen to a stored radio station as follows:

- 1 Switch the system on by pressing **STANDBY/ON**.
- 2 Select the **TUNER** function by pressing **TUNER** on remote control.
- 3 Select the required frequency band by pressing **TUNER** (Band) on the remote control or **TUNER** (Band) again on the front panel.
- 4 Press the **TUNING MODE** button on the front panel of the unit, or the **TUNING MODE** button on the remote control until "PRESET" is displayed.
- 5 Turning **MULTI JOG** on the front panel left or right until the desired station is found or press **◀/▶** to select the desired station.
or
Select the desired station by pressing the **TUNING** \vee or \wedge button on the remote control.
Result: The desired station is now received.

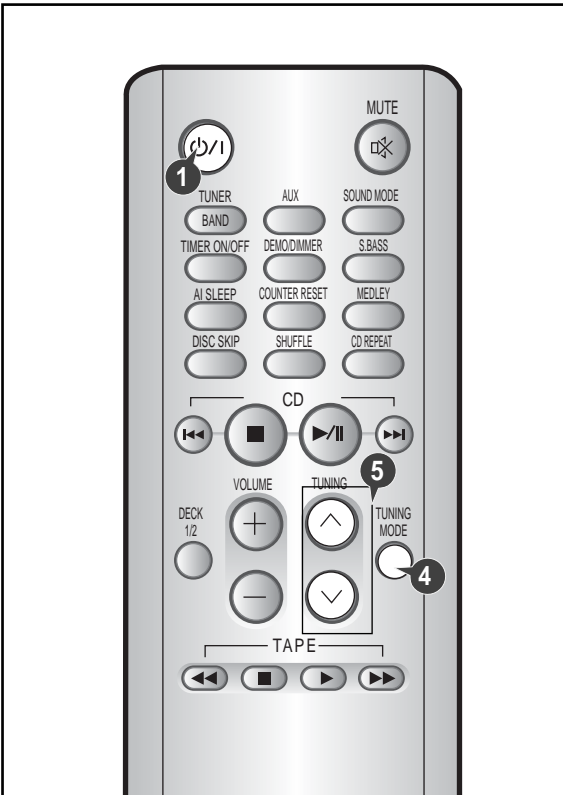
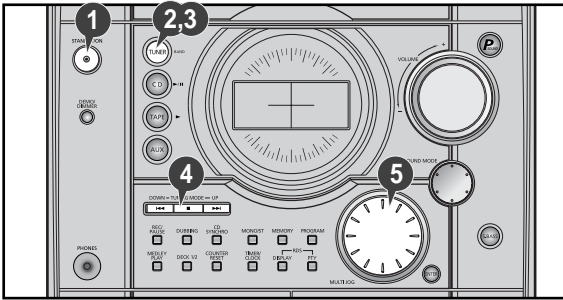

Improving Radio Reception

You can improve the quality of radio reception by:

- ◆ Rotating the FM or AM(MW) aerial
 - ◆ Testing the positions of the FM and AM(MW) aerials before fixing them permanently
- If reception from a specific FM radio station is poor, press **MONO/ST.** to switch from stereo mode to mono. The quality of the sound will be improved.

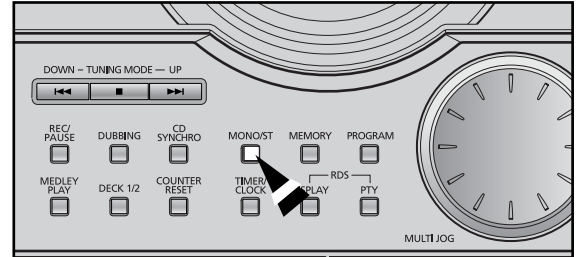

About RDS broadcasting

This unit has the RDS (Radio Data System) function, which enables for the various information such as broadcasting station, radio text, time and 30 types of programs (News, Rock, Classic, etc.) to be received from the FM RDS station together with normal radio signal.

- 1 Press the **STANDBY/ON** button.
- 2 Receive the **FM** radio.
 - ◆ See the radio receiving method on the **page 14**.
 - ◆ **FM** and frequency are shown on the display
 - ◆ If the received station transfers the RDS information, 'RDS' appears automatically on the display.
- 3 Press the **RDS DISPLAY** button to select the desired RDS mode.
 - ◆ Whenever the button is pressed, RDS mode changes as follows.

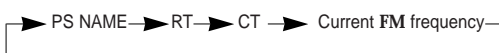

◆ The RDS function is available only in **FM** broadcasting.

➤ Description on RDS function

1. **PTY** (Program Type) : Displays the type of programme currently being broadcast
2. **PS NAME** (Program Service Name) : Indicates the name of broadcasting station and is composed of 8 characters.
3. **RT** (Radio Text) : Decodes the text broadcast by a station (if any) and is composed of maximum 64 characters.
4. **CT** (Clock Time) : Decodes the real time clock from the **FM** frequency.
 - Some stations may not transmit **PTY**, **RT** or **CT** information therefore this may not be displayed in all cases.
5. **TA** (Traffic Announcement) : When this symbol flashes it shows that the traffic announcement is in progress.

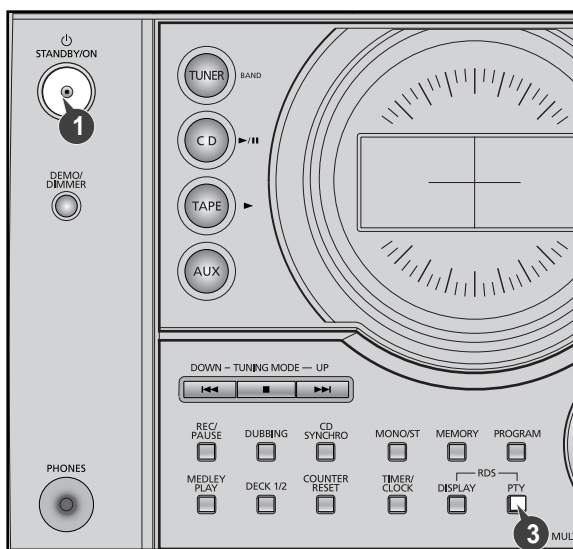

About RDS DISPLAY function

About "PS NAME" MODE

➤ Displays the name of broadcasting station.

Press the **RDS DISPLAY** button to select the PS NAME.

- ◆ "**PS NAME**" appears on the display.
- ◆ If the PS information is being received, the PS name (BBC, AFO, NDR, etc.) is shown on the display.
- ◆ If the PS information isn't received, the original **FM** frequency is shown.

◆ Even though no **RDS DISPLAY** button is pressed, the reception of PS information ensures the PS name is displayed.

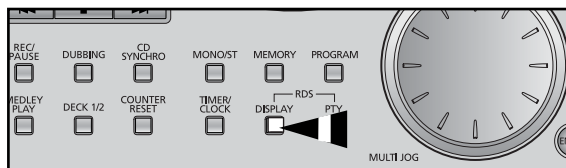

About 'RT' MODE

➤ Displays the character transmitted from the broadcasting station.

Press the **RDS DISPLAY** button to select the RT MODE.

- ◆ "**RT**" appears on the display.
- ◆ If the RT information is being received, the received information is shown on the display.
- ◆ If the RT information isn't received, the "**NO RT**" is shown on the display.

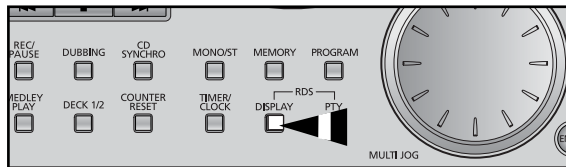

About CT(Clock Time)

➤ Sets the time of RDS clock.

To select the CT time, set the RDS Display button to CT MODE.

◆ The CT information will take up to 2 minutes to be decoded therefore the clock isn't displayed immediately.

- ◆ If there is no received CT information, "**NO CT**" is displayed.

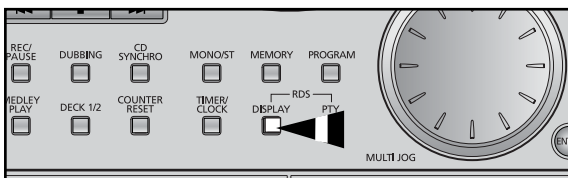

PTY (Program Type) indication and PTY-SEARCH function

- ◆ The PTY information is composed of an identification symbol, which helps the **FM** radio to recognize the program type of each **FM** station.
- ◆ The 30 PTY modes are shown on the display by pressing the PTY button.

Display	Program Type
NEWS	• News including an announced opinion and report
AFFAIRS	• Several matters including a current incident, documentary, discussion and analysis.
INFO	• Information including weights and measures, returns and forecast, matters interesting the customer, medical information, etc.
SPORT	• Sports
EDUCATE	• Education
DRAMA	• Drama-Radio serial, etc.
CULTURE	• Culture-National or local culture including the religious problem, social science, language, theater, etc.
SCIENCE	• Natural science and technology
VARIED	• Others-Speech, amusing program (quiz, game), interview, comedy and satirical play, etc.
POP M	• Pop Music
ROCK M	• Rock Music
M.O.R.M	• M.O.R- Comfortable music, occasionally vocal or piece
LIGHT M	• Light classical music- Classical music and instrumental and chorus music
CLASSICS	• Heavy classical music-Orchestra music, symphony, chamber music and opera
OTHER M	• Other music - Jazz, R&B country music
WEATHER	• Weather
FINANCE	• Finance
CHILDREN	• Children's programmes
SOCIAL	• Social affairs
RELIGION	• Religion
PHONE IN	• Phone in
TRAVEL	• Travel
LEISURE	• Leisure
JAZZ	• Jazz Music
COUNTRY	• Country Music
NATION M	• National Music
OLDIES	• Oldies Music
FOLK M	• Folk Music
DOCUMENT	• Documentary
TEST	• Alarm Test

About PTY-SEARCH

- 1 Tuned to an **FM** station broadcasting a PTY MODE.
 - ◆ See the **FM** receiving method on the **page 14**.
 - ◆ If the received station is transmitting the RDS information, "RDS" lights up.
 - 2 Press the **PTY** button.
 - ◆ The PTY MODE(NEWS, AFFAIRS, etc) appears on the display.
 - ◆ Press the **TUNING Down** or **Up** button to select the desired PTY MODE.
- ◆ If the station is transmitting no **PTY** information, '**NO PTY**' shows on the display.
- ◆ When the PTY MODE is selected(The PTY MODE is shown in the display), press the **PTY** button once again to convert into PTY-SEARCH MODE and auto-search the station sequentially.
- ◆ If a station is found broadcasting required PTY MODE then the search station and the stop is selected.
- 👉 ◆ If the PTY MODE isn't found, it is returned to the original station frequency at beginning the PTY SEARCH and auto-search and PTY SEARCH are suspended.

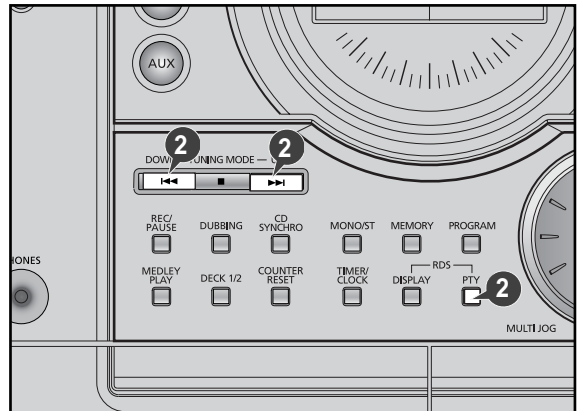

Listening to a Cassette



- ♦ Always treat your cassettes with care; refer, if necessary, to the section entitled "Precautions When Using Audio Cassettes" on page 24.

- 1 Switch the system on by pressing the **STANDBY/ON** button.
- 2 Select the **TAPE** function by pressing **TAPE** on the front panel.
- 3 Open either cassette deck 1 or 2 by pushing and releasing the deck cover where **PUSHE JECT** (▲) is written.
- 4 Insert the pre-recorded cassette with the open edge of the tape facing downward.
- 5 Close the deck by pushing on it until it clicks into place.
Result: Depending on the deck selected, the **1** or **2** indication is displayed in front of the counter number.
- 6 If you have inserted two cassettes, press **DECK 1/2** on the front panel or directly the **DECK 1/2** button on the remote control to select the cassette to be played.
Result: Depending on the deck selected, the **TAPE 1** or **TAPE 2** indication is displayed.
- 7 **To listen to... Press ...**
Side A,B **TAPE** (▶)

Result: The cassette starts playing.

When the cassette is stopped, select one of the following functions as required or on the remote control.

8 Main Unit

To...	Press...
Rewind the cassette	◀◀
Fast-forward the cassette	▶▶

Remote Control

To...	Press ...
Rewind the cassette	◀◀
Fast-forward the cassette	▶▶

- 9 **To...** **Press ...**
Stop the playback

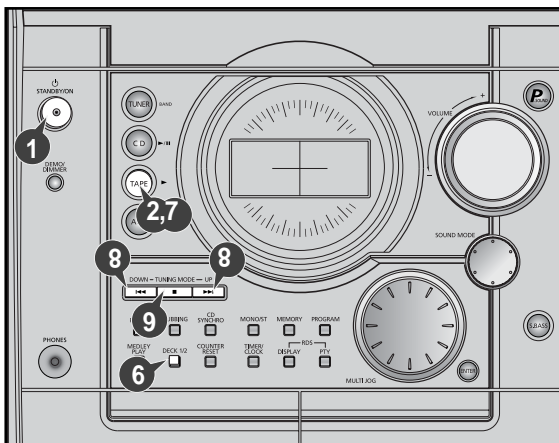

CD Synchro Record Feature

You can record a compact disc on a cassette in two different ways:

- ♦ Synchronised recording
- ♦ Direct recording

This feature enables you to synchronize the start of the recording with the start of the disc or track of your choice.

- 1 Switch the system on by pressing **STANDBY/ON**.
- 2 Insert a blank cassette in Deck 2.
- 3 Select the **CD** function by pressing **CD** on the front panel.
- 4 Load a compact disc.
- 5 Select the required disc.
- 6 Select the required track and press **CD SYNCHRO** or press **CD SYNCHRO** directly to start recording at the beginning of the disc.
Result: **REC** and **SYNC** are displayed and recording starts.
- 7 To stop recording, press ■.

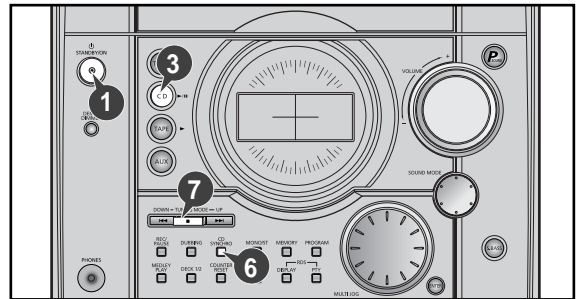

Recording a Compact Disc

The direct recording mode enables you to start recording with any track on the compact disc.

- ♦ You can only record on cassettes in Deck 2.
- ♦ You do not need to adjust the volume, as it has no effect on the recording.

- 1 Switch your system on by pressing **STANDBY/ON**.
- 2 Insert a blank cassette in Deck 2.
- 3 Select the **CD** function by pressing **CD** on the front panel.
- 4 Load the compact disc.
- 5 Select the required disc.
- 6 Select the required track on the compact disc and press ▶/|| on the front panel or ▶/|| on the remote control to set the compact disc player to Pause mode.
- 7 Press the **REC/PAUSE**.
Result: **REC** is displayed.
- 8 Press the ▶/|| to start playing the track.
Result: The track is recorded on the cassette.
- 9 To stop recording, press ■.

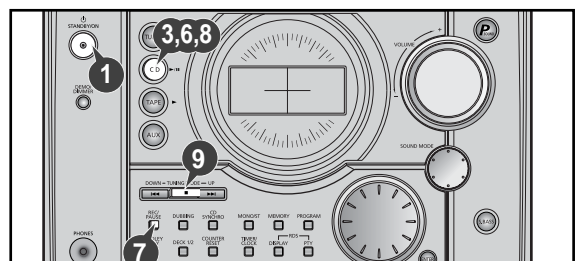

Recording a Radio Program

You can record a radio program of your choice.

- ◆ You can only record on cassettes in Deck 2.
- ◆ You do not need to adjust the volume, as it has no effect on the recording.

- 1 Switch the system on by pressing **STANDBY/ON**.
- 2 Insert a blank cassette in Deck 2.
- 3 Select the **TUNER** function by pressing **TUNER**.
- 4 Select the radio station that you wish to record by pressing **Tuning** \wedge or \vee on the remote control or by press the **Tuning Down Up** on the front panel.
- 5 Press **REC/PAUSE**.
Result: REC is displayed in red and recording starts.
- 6 To stop recording, press \blacksquare .

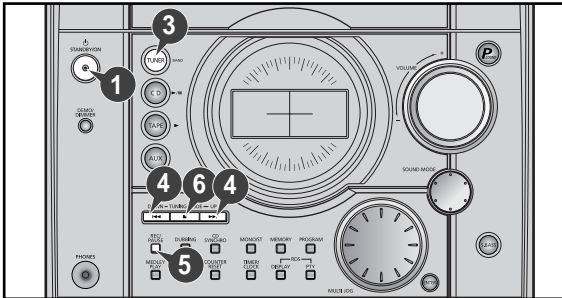

Copying a Cassette (Dubbing)

You can copy a cassette from Deck 1 to Deck 2.

- ◆ Normal speed dubbing in selecting Tape function mode.
- ◆ You do not need to adjust the volume, as it has no effect on the recording.
- ◆ Take care not to insert the tape to be copied in Deck 2, as it will be erased when you start recording.

- 1 Switch your system on by pressing **STANDBY/ON**.
- 2 Insert a blank cassette in Deck 2.
- 3 Insert the tape to be copied in Deck 1.
- 4 **To copy a cassette at...** Press...
Normal speed DUBBING

Result: The appropriate indications are displayed and the cassette in Deck 1 is copied to the cassette in Deck 2.

- 5 To stop dubbing, press \blacksquare .

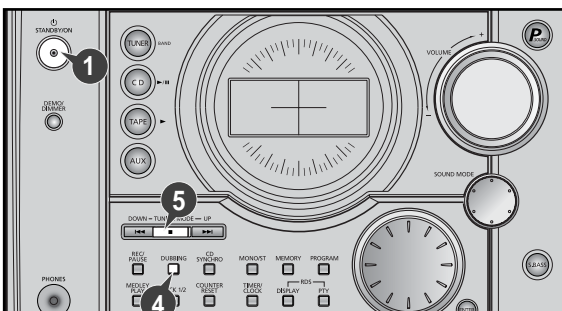

Tape Counter

When playing a cassette in one of the cassette decks, a counter is displayed to enable you to take note of the counter value at the start of each track to start playback at the beginning of the track to which you wish to listen.

- Before starting to record a cassette for which you wish to take note of the counter values at the beginning of each track, reset the counter by pressing **COUNTER RESET**.
- Each cassette deck has a separate counter.

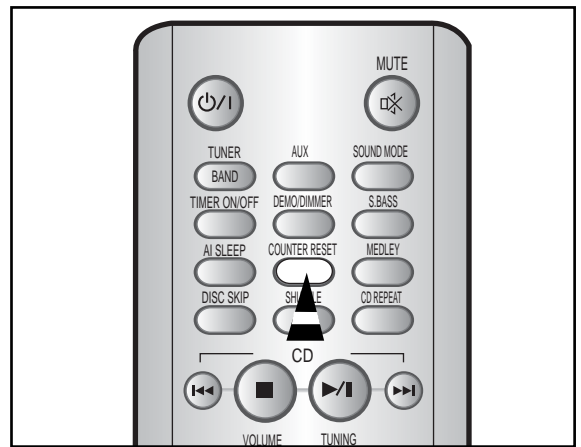
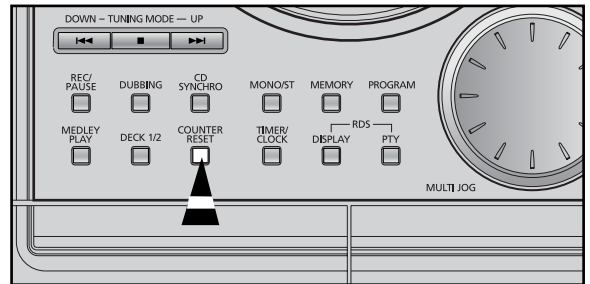

Timer Function



The timer enables you to switch the system on or off at specific times.

Example: You wish to wake up to music every morning.

- If you no longer want the system to be switched on or off automatically, you must cancel the timer.
- ◆ Before setting the timer, check that the current time is correct.
- ◆ For each step, you have a few seconds to set the required options. If you exceed this time, you must start again.

- 1 Switch the system on by pressing **STANDBY/ON**.
- 2 Press **TIMER/CLOCK** until **TIMER** is displayed.
- 3 Press **ENTER**.
Result: **ON TIME** is displayed (instead of the equalizer symbols) for a few seconds, followed by any switch-on time already set; you can set the timer switch-on time.
 - 4 Set the timer switch-on time.
 - a Set the hour by tuning the **MULTI JOG** knob to the right or to the left.
 - b Press **ENTER**.
Result: The minutes flash.
 - c Set the minutes by tuning the **MULTI JOG** knob to the right or to the left.
 - d Press **ENTER**.
Result: **OFF TIME** is displayed (instead of the equalizer symbols) for a few seconds, followed by any switch-off time already set; you can now set the timer switch-off time.
 - 5 Set the timer switch-off time.
 - a Set the hour by tuning the **MULTI JOG** knob to the right or to the left.
 - b Press **ENTER**.
Result: The minutes flash.
 - c Set the minutes by tuning the **MULTI JOG** knob to the right or to the left.
 - d Press **ENTER**.
Result: **VOL XX** is displayed, where **XX** corresponds to the volume already set.
- 6 Press **TUNING Down** and **Up** to adjust the volume level and press **ENTER**.
Result: The source to be selected is displayed.
- 7 Turn the **MULTI JOG** knob to select the source to be played when the system switches on.

If you select...	You must also...
TAPE (cassette)	Insert a recorded cassette in one of the decks before setting the system to standby.
TUNER (radio)	<ol style="list-style-type: none"> a Press ENTER. b Select a preset station by tuning the Multi Jog knob to the right or to the left.
CD (compact disc)	Load one or more compact discs.

- 8 Press **ENTER** to confirm the timer.
- 9 Press **STANDBY/ON** to set the system to standby mode.
Result: **T** is displayed to the top of the time, indicating that the timer has been set. The system will switch on and off automatically at the required times.

➤ If the timer switch on and off times are identical, the word **ERROR** is displayed.

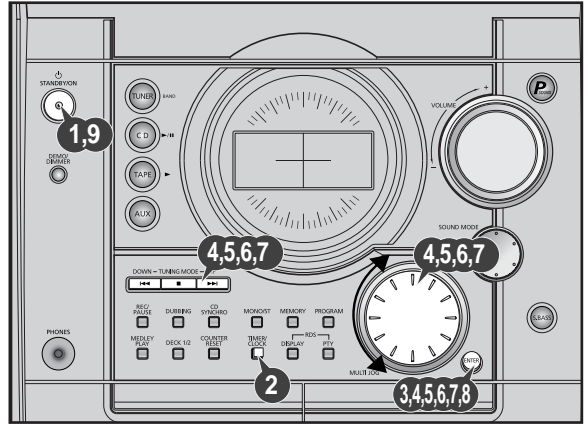

- To set the timer function
 - ◆ You may use **MULTI JOG** or **◀ / ▶** buttons to adjust in step 4, 5, 6, 7.

Cancelling the Timer

After having set the timer, it will start automatically as shown by the **TIMER** indication on the display. If you no longer wish to use the timer, you must cancel it.

➤ You can stop the timer at any time (system on or in standby mode).

To...	Press Timer-On/Off...
Cancel the timer	Once. Result: T is no longer displayed.
Restart the timer	Twice. Result: T is displayed again.



Mute Function

You can turn the sound off temporarily on your system.
Example: You wish to answer a telephone call.

- 1 Press **MUTE**.
- 2 To switch the sound back on , press **MUTE** again or the **VOLUME** buttons.

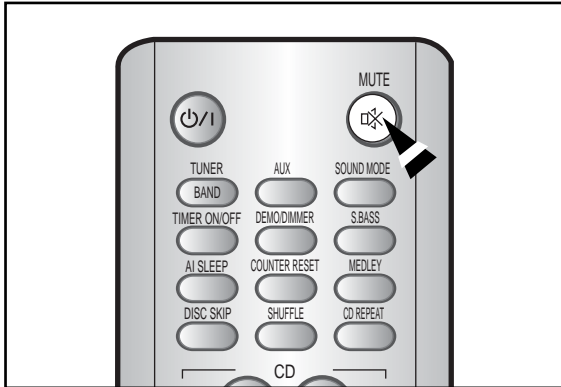

Selecting Sound Mode

Your mini-compact system is equipped with a preset equalizer that allows you to choose the most appropriate balance between treble and bass frequencies, according to the type of music you are listening to.

This model provides D.S.P modes so that you can enjoy virtually original sound.

- 1 Turn **SOUND MODE** on the front panel or Press **SOUND MODE** on the remote control until the required option is selected.

To obtain a...	Select...
Normal balance (linear)	PASS
Balance suitable for pop music	POP
Balance suitable for rock music	ROCK
Balance suitable for classic music	CLASSIC

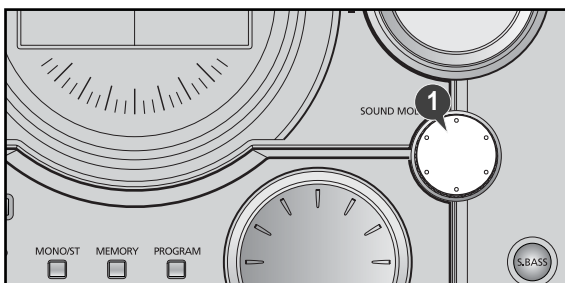

Power Sound Function

Your mini-compact system is equipped with the function of Power Sound .
 The function of Power Sound amplifies bass and improves high key or bass twice as much for you to appreciate powerful real sound.

- 1 Press the **P.SOUND** button on the front panel.
Result: Press **P.SOUND** button on the front panel, "**P.SOUND**" is displayed.
- 2 To cancel this function, press **P.SOUND** button again .

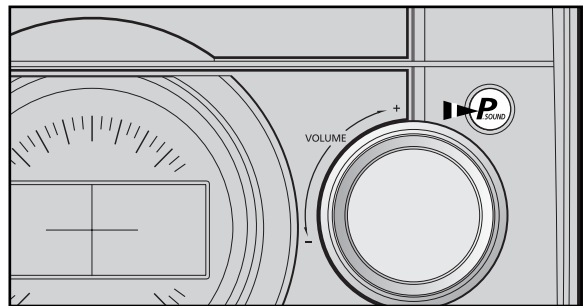

Setting the System to Switch off Automatically

GB

While listening to a compact disc or a cassette, you can set the system to switch off automatically

Example: You wish to go to sleep to music.

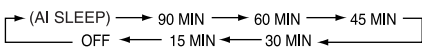
- 1 Press **AI SLEEP**.
Result: playback starts and the following indications are displayed:
90 MIN
- 2 Press **AI SLEEP** once or more times to indicate how long the system should continue playing before it switches off:

 - At any time, you can:
 - ◆ Check the remaining time by pressing **AI SLEEP**
 - ◆ Change the remaining time by repeating Steps 1 and 2
- 3 Press **AI SLEEP** once or more times until **AI SLEEP** is displayed.
Result: The system will automatically switch off at the end of the disc or cassette.
- 4 To cancel SLEEP function, press **AI SLEEP** once or more times until **OFF** is display.



S.BASS Level Function

Your mini-compact system has a bass amplification function called SBS (Super Bass Sound). This function makes the sound more powerful and real.

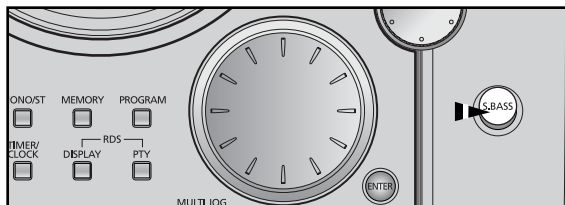
- 1 Press the **S.BASS** button on the front panel.
Result: **S. BASS** is displayed and "SBS ON" is displayed for a few seconds.
- 2 To cancel this function, press **S.BASS** again, "OFF" is displayed for a few seconds.



Connecting Headphones

You can connect a set of headphones to your mini-compact system so that you can listen to music or radio programmers without disturbing other people in the room. The headphones must have a 3.5Ø jack or an appropriate adapter.

Connect the headphones to the **PHONES** jack on the front panel.
Result: The loudspeakers are no longer used to output the sound.

 Prolonged use of headphones at a high volume may damage your hearing.

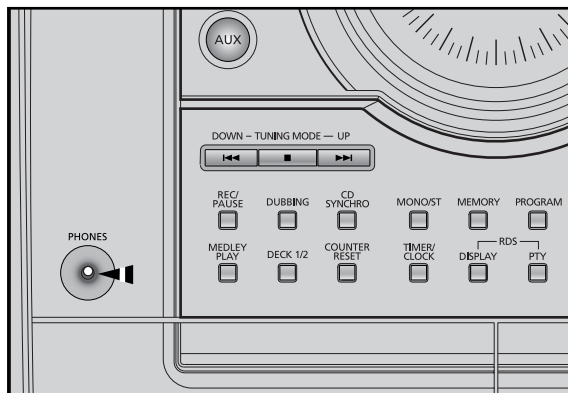

Safety Precautions

The following diagrams illustrate the precautions to be taken when using or moving your mini-compact system.

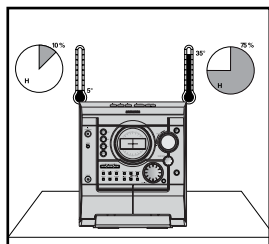

Ambient operating conditions:
Ambient temperature 5°C-35°C
Humidity 10-75%

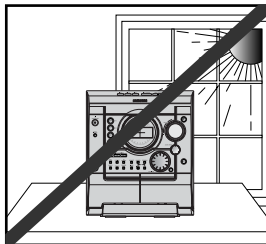

Do not expose the unit to direct sun radiation or other heat sources. This could lead to overheating and malfunction of the unit.

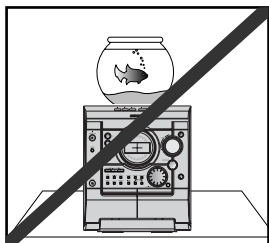

Do not place potted plants or vases on top of the unit. Moisture entering the unit could lead to dangerous electric shock and can cause equipment damage. In such events immediately disconnect the main plug from the socket.

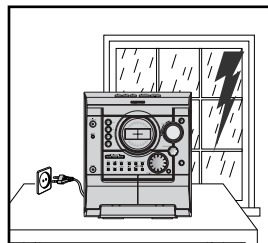

During thunderstorms, disconnect the main plug from the socket. Main voltage peaks due to lightning could damage the unit.

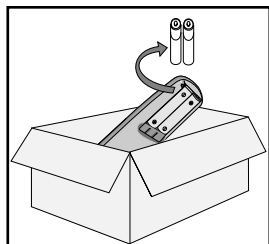

Remove the batteries from the remote control, if not used for any extended period. Leaking batteries can cause serious damage to the remote control.

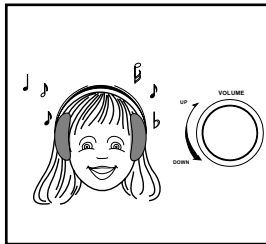

When using headphones, take care not to listen at excessive volumes. Extended use of headphones at high volumes will lead to hearing damage.

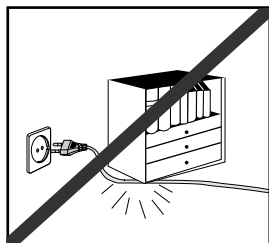

Do not place heavy items on the main lead. Main cable damage can lead to damage of the equipment (fire hazard) and can cause electric shock.

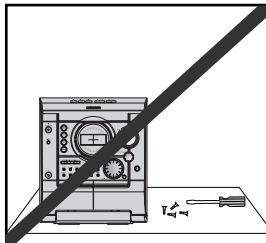

Do not remove any equipment panels. The inside of the unit contains live components, which cause electric shock.

Cleaning Your Mini-Compact System

To obtain the best possible results from your mini-compact system, you must clean the following elements regularly:

- ◆ The outer casing
- ◆ The compact disc player
- ◆ The cassette players (heads, rollers and drive capstans)
- ☛ Always unplug the system from the wall outlet:
 - ◆ Before cleaning it
 - ◆ If you are not going to be using it for a long time

Outer Casing

Clean the outer casing regularly using a soft cloth and a light detergent. Do not use abrasive powders, liquids or aerosol cleaners. Never let any liquids get into the system.

Compact Disc Player

- 1 Before playing a compact disc, clean it with a special CD cleaning agent. Do not use the same cleaning agents as for vinyl LP records. Carefully wipe the disc from the centre outward.
- 2 Regularly clean the player with a special cleaning disc (available from your local dealer).

Tape Decks

- 1 Press **PUSH EJECT** (▲) to open the cassette deck.
- 2 Use a cotton bud and a special cassette cleaning agent to clean the:
 - ◆ Head (1)
 - ◆ Rollers (2)
 - ◆ Drive capstans (3)

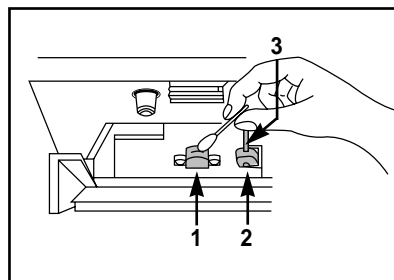

- ☛ If you will not be using the remote control for a long time, remove the batteries to prevent corrosion.
- ◆ Although your system is very hard-wearing, it should not be used in an excessively dusty environment or subjected to shocks or extreme heat (close to heating appliances or in direct sunlight, etc.).
- ◆ If the unit emits an unpleasant odor when in use, unplug it from the main supply and contact the after-sales service.

Precautions When Using Compact Discs



- ◆ Handle your compact discs with care. Always hold them by the edges to avoid leaving fingerprints on the shiny surface.
- ◆ When you have finished playing a compact disc, always put it back in its case.
- ◆ Do not fix paper or adhesive tape to the discs and do not write on the label.
- ◆ Clean them with a special-purpose cloth.
- ◆ Store your compact discs in a clean place, out of direct sunlight, where they will not be exposed to high temperatures.
- ◆ Always use compact discs marked 

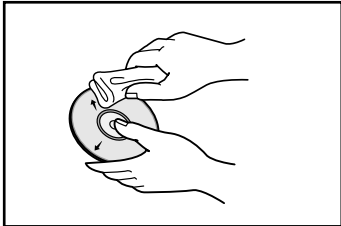

Precautions When Using Audio Cassettes

- ◆ Check that the tape in the cassette is sufficiently taught.
- ◆ To prevent erasing a cassette that you wish to keep, remove the safety tab on the upper edge of the cassette. To record a cassette, where the tab has been broken, simply cover the opening with adhesive tape.
- ◆ When you have finished playing a cassette, always put it back in its case.
- ◆ Store your cassettes in a clean place, out of direct sunlight, where they will not be exposed to high temperatures.
- ◆ Avoid using 120-minute cassettes as they place unnecessary strain on the tape mechanism.

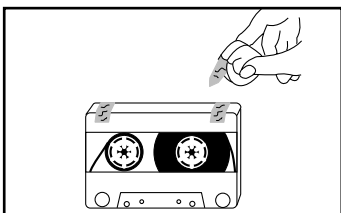
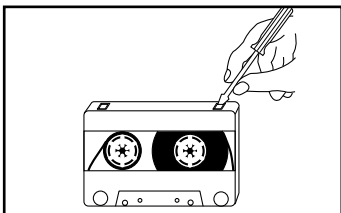
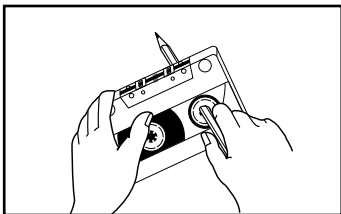

Before Contacting the After-Sales Service

It always takes a little time to become familiar with a new appliance. If you have any of the problems listed below, try the solutions given. They may save you the time and inconvenience of an unnecessary service call.

Problem	Checks/Explanation
The system does not work	<ul style="list-style-type: none"> • The main lead is not correctly plugged into a wall socket or the wall socket is not switched on. • The remote control batteries need replacing or the polarity has not been respected. • The STANDBY/ON button has not been pressed.
There is no sound	<ul style="list-style-type: none"> • The volume has been completely turned down. • The correct function (TUNER, CD, TAPE, AUX) has not been selected. • You have connected a set of earphones. • The loudspeaker wires have been disconnected. • The MUTE button has been pressed.
The Timer does not work	<ul style="list-style-type: none"> • The timer has been stopped by pressing TIMER ON/OFF.
In case it does not work, even the action is taken as above.	<ul style="list-style-type: none"> • Press the P.SOUND button for 5 seconds in power 'OFF'(standby), then it is returned the original position (RESET)
The compact disc player does not start playing	<ul style="list-style-type: none"> • The CD function has not been selected. • The disc has been inserted face down or is either dirty or scratched. • The laser sensor is dirty or dusty. • The system has not been installed on a flat, horizontal surface. • Condensation has formed in the player; leave the system in a warm, airy room for at least one hour.
The tape does not start playing	<ul style="list-style-type: none"> • The TAPE function has not been selected. • The cassette has not been inserted correctly. • The cassette player has not been closed. • The tape is either slack or broken.
The volume falls off	<ul style="list-style-type: none"> • The audio heads are dirty.
The cassette is not erased correctly	<ul style="list-style-type: none"> • The rollers or drive capstans are dirty.
There is excessive wow and flutter	<ul style="list-style-type: none"> • The tape is worn.
Reception is poor or no radio stations are received at all	<ul style="list-style-type: none"> • The TUNER function has not been selected. • The radio frequency has not been correctly selected. • The aerial has been disconnected or is not facing the right way. Turn it until you find the best orientation. • You are in a building that blocks radio waves; you must use an outside aerial.

If the above guidelines do not allow you to solve the problem, take a note of:

- ◆ The model and serial numbers, normally printed on the rear of the system
- ◆ Your warranty details
- ◆ A clear description of the problem

Then contact your local dealer or SAMSUNG after-sales service.

Technical Specifications



SAMSUNG strives to improve its products at all times. Both the design specifications and these user instructions are thus subject to change without notice.

RADIO

LW (OPTION)

Usable sensitivity 60 dB

AM (MW)

Signal/noise ratio 40 dB

Usable sensitivity 54 dB

Total harmonic distortion 2 %

FM

Signal/noise ratio 62 dB

Usable sensitivity 10 dB

Total harmonic distortion 0.3 %

COMPACT DISC PLAYER

Capacity 3 discs

Frequency range 20 Hz - 20 KHz (± 1 dB)

Signal/noise ratio 90 dB (at 1 KHz) with filter

Distortion 0.05 % (at 1 KHz)

Channel separation 74 dB

Disc sizes Diameter: 120 or 80 mm. Thickness: 1.2 mm

TAPE DECK

Frequency range 125 Hz ~ 8 KHz

Signal/noise ratio 40 dB

Channel separation 35 dB

Erasing effect 50 dB

AMPLIFIER

Output power (6 Ω) 2 x 15W RMS, IEC (total harmonic distortion: 10 %)

Channel separation 45 dB

Signal/noise ratio 75 dB

GENERAL

Dimensions 270 (W) x 317 (H) x 370 (D) mm

THIS APPLIANCE IS MANUFACTURED BY:



ELECTRONICS