

SAMSUNG

THREE-CD CHANGER
MINI-COMPACT SYSTEM
MP3-CD/CD-R/RW PLAYBACK
MAX-ZS530

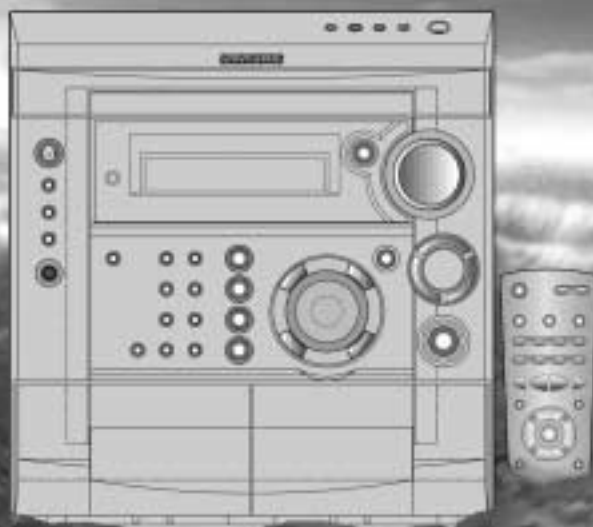

Instruction Manual



Safety Warnings

GB

CLASS 1 LASER PRODUCT
KLASSE 1 LASER PRODUKT
LUOKAN 1 LASER LAITE
KLASS 1 LASER APPARAT
PRODUCTO LASER CLASE 1

	CAUTION RISK OF ELECTRIC SHOCK. DO NOT OPEN	
<p>CAUTION: TO REDUCE THE RISK OF ELECTRIC SHOCK, DO NOT REMOVE REAR COVER. NO USER SERVICEABLE PARTS INSIDE. REFER SERVICING TO QUALIFIED SERVICE PERSONNEL.</p>		

CLASS 1 LASER PRODUCT
This Compact Disc player is classified as a CLASS 1 LASER product.

Use of controls, adjustments or performance of procedures other than those specified herein may result in hazardous radiation exposure.

CAUTION-INVISIBLE LASER RADIATION WHEN OPEN AND INTERLOCKS DEFEATED, AVOID EXPOSURE TO BEAM.



This symbol indicates that dangerous voltage which can cause electric shock is present inside this unit.



This symbol alerts you to important operating and maintenance instructions accompanying the unit.

WARNING: To reduce the risk of fire or electric shock, do not expose this appliance to rain or moisture.

CAUTION: TO PREVENT ELECTRIC SHOCK, MATCH WIDE BLADE OF PLUG TO WIDE SLOT, FULLY INSERT.

Contents

Thank you for buying this
SAMSUNG mini-compact system.

Please take time to read these instructions.
They will allow you to operate your
system with ease and take full advantage
of its features.



◆ SAFETY WARNINGS	2
◆ INSTALLING YOUR MINI-COMPACT SYSTEM	
■ Front Panel View	4
■ Remote Control	5
■ Rear Panel View	6
■ Where to Install Your Mini-Compact System	7
■ Connecting the Loudspeakers	7
■ Inserting Remote Control Batteries	7
■ Connecting the AM (MW) Aerial	8
■ Connecting the FM Aerial	8
■ Connecting to an External Source	8
■ Connecting your System to the Power Supply	9
■ Demo/Dimmer function	9
■ Setting the Clock	9
◆ CD/MP3-CD PLAYER	
■ Loading and Changing Compact Discs	10
■ To replay the CD/MP3-CD	10
■ Selecting a CD in the Disc changer	11
■ Selecting a CD Track	11
■ To select the MP3-CD title and track	11
■ Searching for a Specific Music Passage on a CD	12
■ Function to skip through 10 tracks at a time	13
■ Last Memory Function	13
■ Shuffle Play Function	13
■ Repeating One or All Tracks on the Compact Discs	14
■ Programming the Order of CD Playback	14
■ Checking or Changing Programmed CD Tracks	15
◆ TUNER	
■ Searching for and Storing the Radio Stations	15
■ Selecting a Stored Station	16
■ Improving Radio Reception	16
◆ TAPE DECK	
■ Listening to a Cassette	17
■ CD Synchro Record Feature	17
■ Recording a Compact Disc	17
■ Recording a Radio Programme	18
■ Copying a Cassette (Dubbing)	18
■ Tape Counter	18
■ Selecting the cassette Playback Mode(Only for Deck 2)	18
◆ OTHER FUNCTIONS	
■ Timer Function	19
■ Cancelling the Timer	20
■ Mute Function	20
■ Selecting an Equalizer Preset	20
■ Power Sound Function	20
■ Setting the System to Switch off Automatically	21
■ Super Bass Sound	21
■ Connecting Headphones	21
■ Microphone Function(option)	21
◆ RECOMMENDATIONS FOR USE	
■ Safety Precautions	22
■ Cleaning Your Mini-Compact System	22
■ Precautions When Using Compact Discs	22
■ Precautions When Using Audio Cassettes	23
■ Before Contacting the After-Sales Service	23
■ Technical Specifications	24

Symbols



Press



Push



Important



Note

Front Panel View

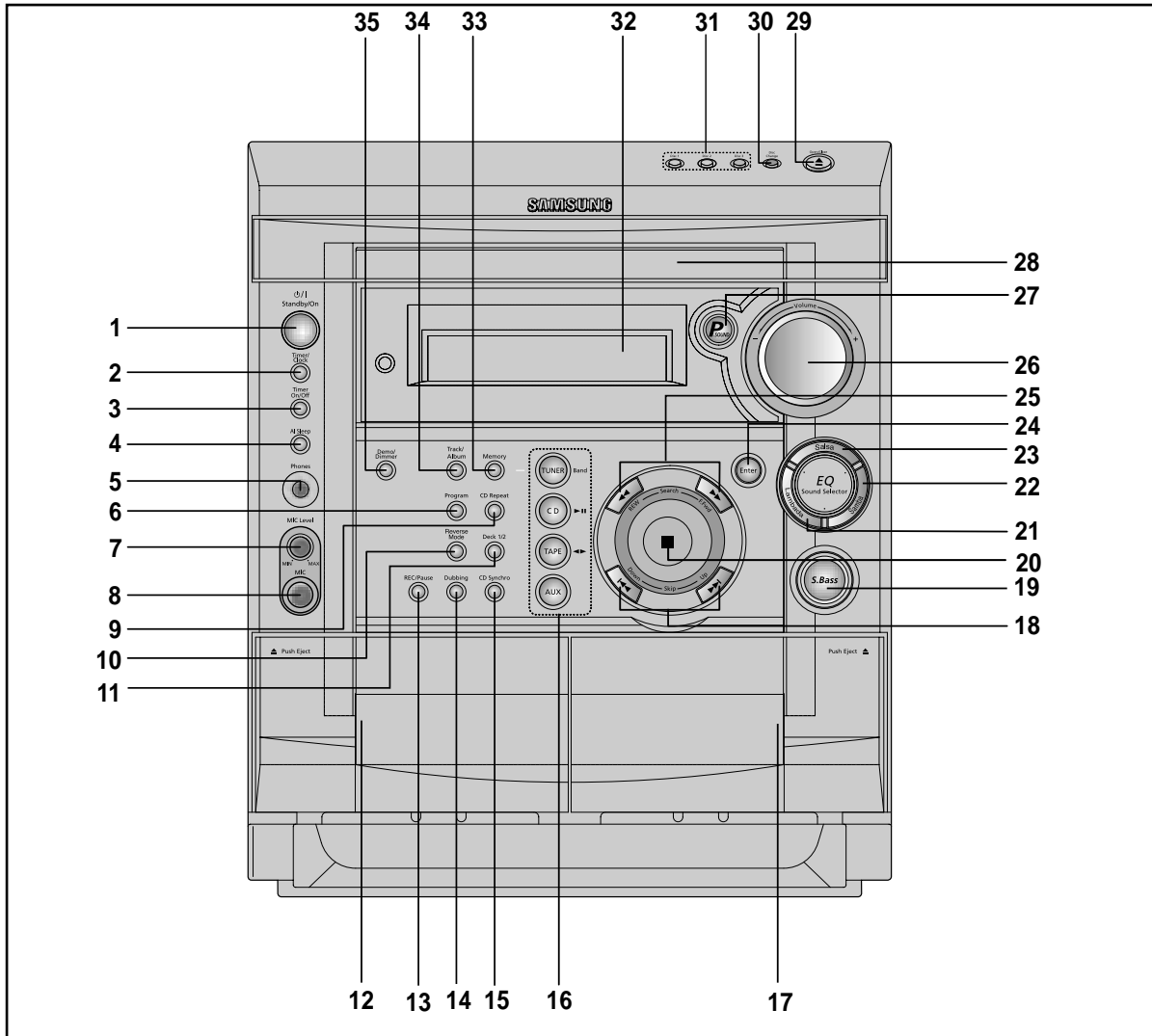

- | | |
|--------------------------------|---|
| 1. Standby/On | 19. S.Bass |
| 2. Timer/Clock | 20. Stop button |
| 3. Timer On/Off | 21. EQ Preset Lambada |
| 4. AI Sleep | 22. EQ Preset Samba |
| 5. Headphone Jack Connector | 23. EQ Preset Salsa |
| 6. Program button | 24. Enter |
| 7. MIC Level(option) | 25. Search Function buttons |
| 8. MIC Jack(option) | 26. Volume |
| 9. CD Repeat | 27. Power Sound |
| 10. Reverse Mode | 28. Compact Disc Compartment |
| 11. Deck 1/2 | 29. CD Open/Close |
| 12. Cassette Deck 1 | 30. Disc Change |
| 13. REC/Pause | 31. Disc Selection buttons |
| 14. TAPE Normal Dubbing | 32. Window Display |
| 15. CD Synchro Recording | 33. Memory Function |
| 16. Function Selection buttons | 34. MP3-CD Track / Album Mode Selection |
| 17. Cassette Deck 2 | 35. Demo/Dimmer |
| 18. Skip Function buttons | |

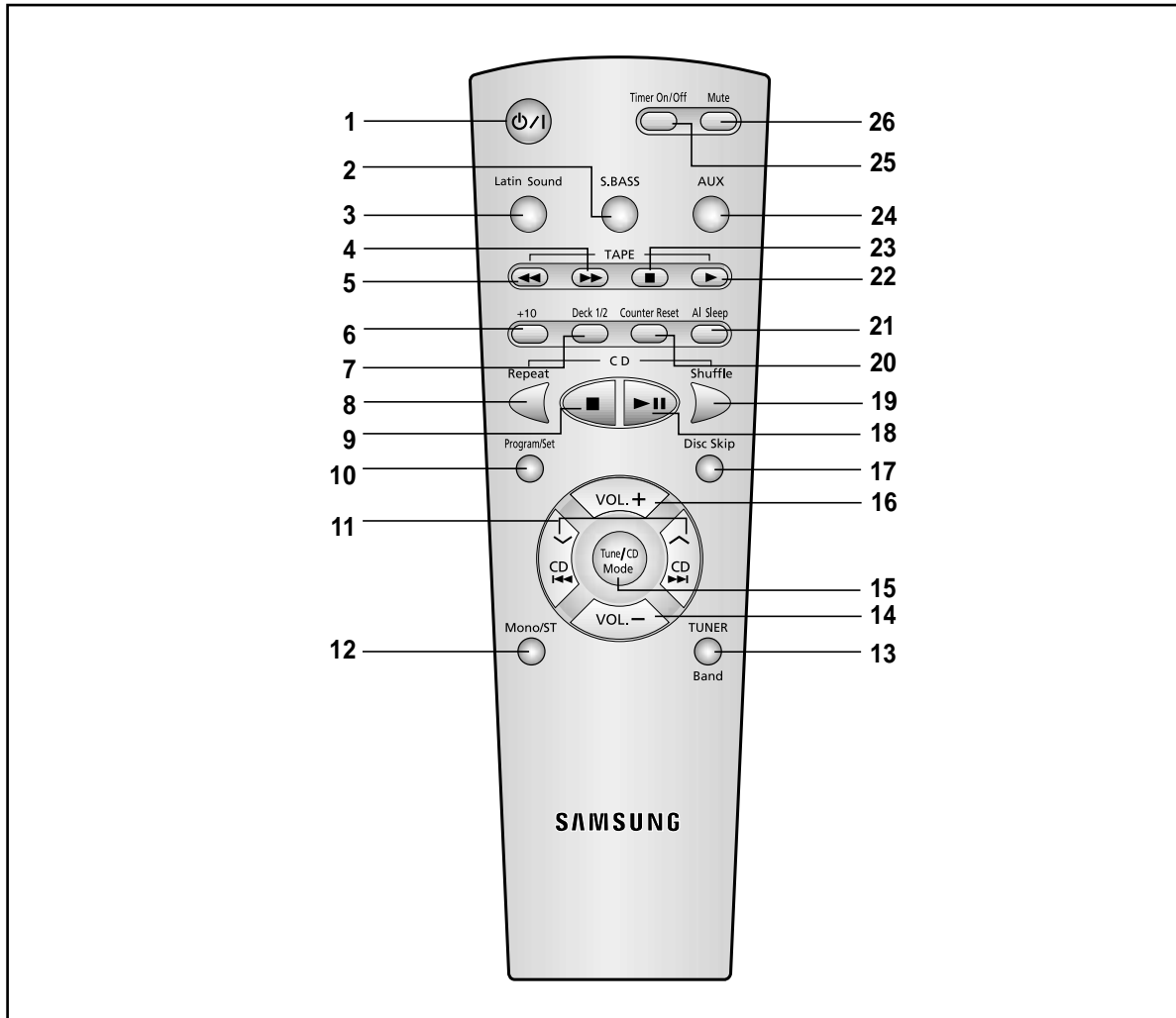

- | | |
|--|---|
| 1. Standby/On | 14. Volume Decrease |
| 2. S.BASS | 15. Tuning Mode(MANUAL,PRESET)
MP3-CD Track / Album Mode Selection |
| 3. Latin Sound | 16. Volume Increase |
| 4. TAPE Fast-Forward | 17. Disc Skip |
| 5. TAPE Rewind | 18. CD Play/Pause |
| 6. +10 | 19. CD Shuffle Play/
MP3-CD Random Play |
| 7. Deck 1/2 | 20. Counter Reset |
| 8. CD Repeat | 21. AI Sleep |
| 9. CD Stop | 22. TAPE Play |
| 10. Program/Set/MP3-CD Last Memory | 23. TAPE Stop |
| 11. CD Track or Radio Station Search(Skip) | 24. AUX |
| 12. Mono/ST. | 25. Timer On/Off |
| 13. Tuner Band | 26. Mute |

Rear Panel View

GB

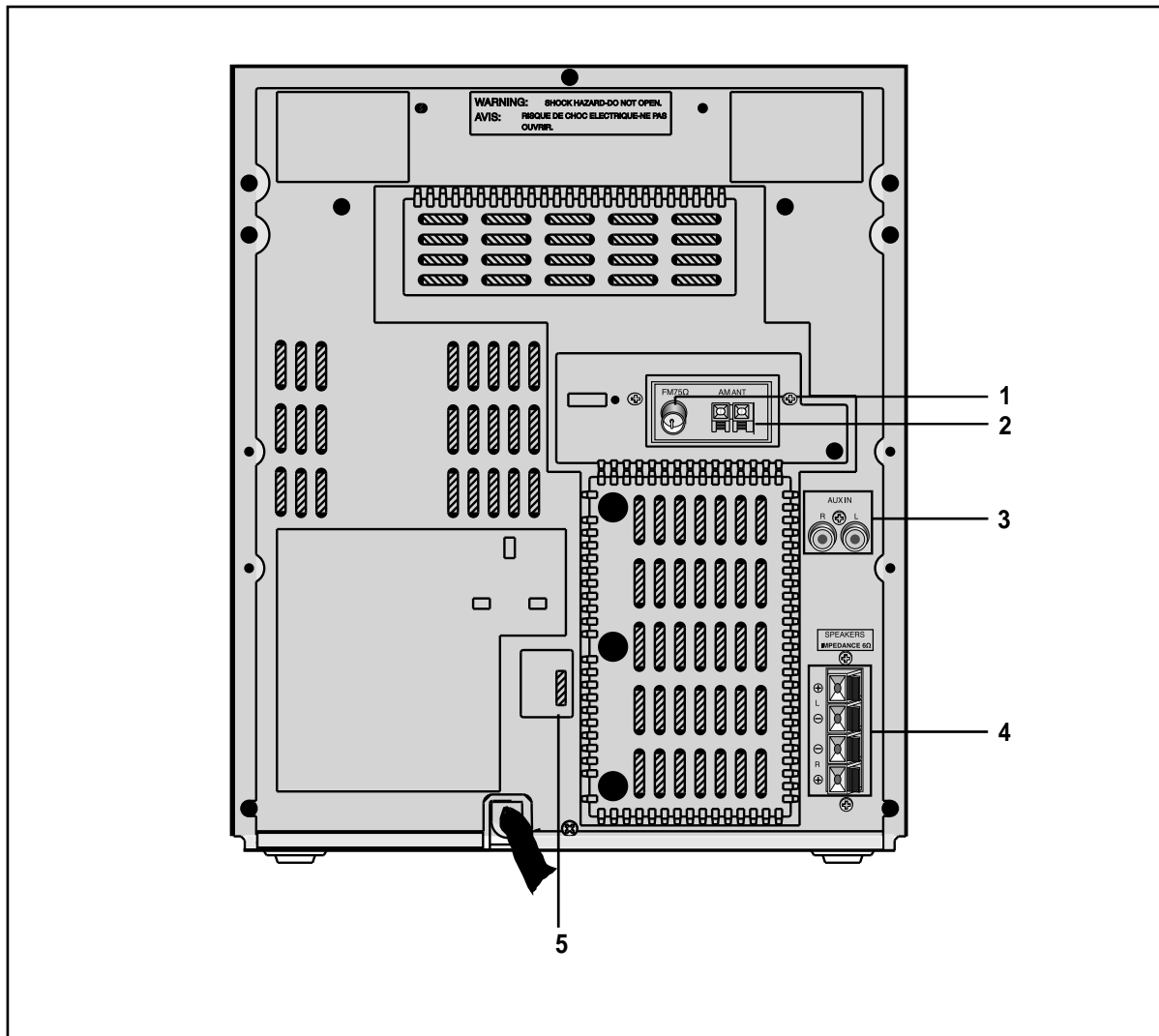

1. FM Aerial Connector Terminal
2. AM Aerial Connector Terminal
3. AUX-Input
4. Loudspeaker Connector Terminals
5. Voltage Selector(option)

Where to Install Your Mini-Compact System

To take full advantage of your new mini-compact system, follow these installation instructions before connecting the unit.

- ◆ Install the system on a flat, stable surface.
- ◆ Never place this unit on carpeting.
- ◆ Never place this unit in an outdoor area.
- ◆ Maintain an open space of approximately 6 inches (15 cm) on the sides and rear of the system, for ventilation purposes.
- ◆ Make sure that you have enough room to open the compact disc compartment easily.
- ◆ Place the loudspeakers at a reasonable distance on either side of the system to ensure good stereo sound.
- ◆ Direct the loudspeakers towards the listening area.
- ◆ For optimum performance, make sure that both speakers are placed at an equal distance above the floor.

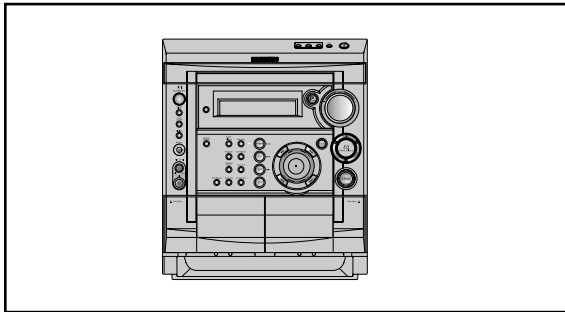

Connecting the Loudspeakers

The loudspeaker connector terminals are located on the rear of the system.

There are four terminals on the system:

- ◆ Two for the left speaker (marked L)
- ◆ Two for the right speaker (marked R)

To achieve the correct sound quality, connect the:

- ◆ Red wire to the + terminals
- ◆ Black wire to the - terminals

- 1 Press and hold the terminal tab.
- 2 Insert the speaker cord.
- 3 Release the finger.

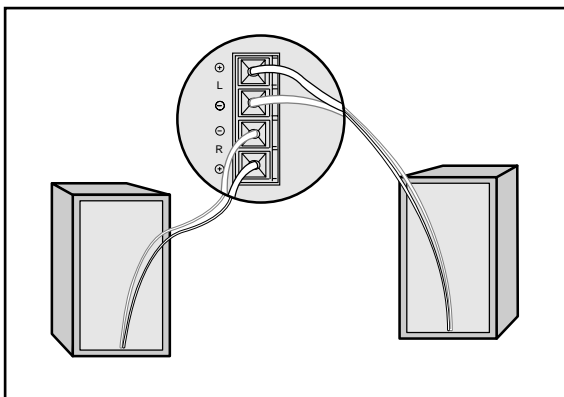

Inserting Remote Control Batteries

GB

Insert or replace remote control batteries when you:

- ◆ Purchase the mini-compact system
- ◆ Find that the remote control is no longer operating correctly

When replacing the batteries, use a new set of batteries and never mix alkaline and manganese batteries.

- 1 Place your thumb on the position marked  on the battery compartment cover (rear of the remote control) and push the cover in the direction of the arrow.
- 2 Insert two AAA, LR03 or equivalent batteries, taking care to respect the polarities:
 - ◆ + on the battery against + on the remote control
 - ◆ - on the battery against - on the remote control
- 3 Replace the cover by sliding it back until it clicks into position.

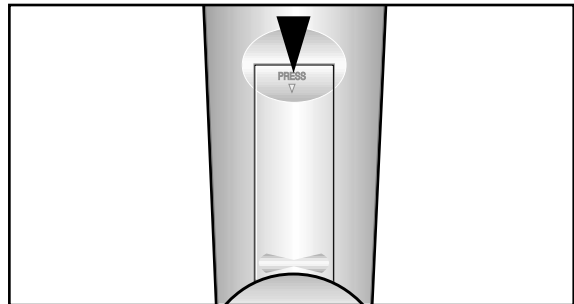

Connecting the AM (MW) Aerial

GB

The AM aerial (for medium wave) can be:

- ◆ Placed on a stable surface
- ◆ Fixed to the wall (you must first remove the base)

The **AM** aerial connector terminals are located on the rear of the system and are marked **AM**.

- ☛ To avoid noise interference, check that the loudspeaker wires do not run close to the aerial wires. Always keep them at least 2 inches (5 cm) away.

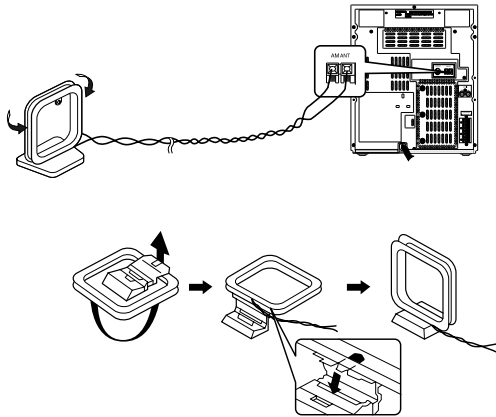

Connecting the FM Aerial

How to connect a COAXIAL TYPE aerial.

- ◆ Connect a 75Ω antenna to the **FM** antenna terminal.
- ◆ Plug the connector on the **FM** aerial supplied into the coaxial socket (75Ω) marked **FM** on the rear of the system.
- ◆ Follow the instructions given on Page 15 to tune into a radio station, and determine the best position for the aerial.
- ◆ If reception is poor, you may need to install an outdoor aerial. To do so, connect an outdoor **FM** aerial to the **FM** socket on the rear of the system using a 75Ω coaxial cable (not supplied).

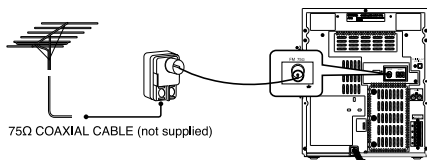
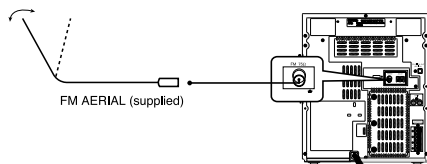

Connecting to an External Source

The auxiliary input can be used to take advantage of the sound quality of your mini-compact system when listening to other sources.

- Examples:**
- ◆ A television
 - ◆ A video disc player
 - ◆ A DAT or DCC cassette player
 - ◆ A Hi-Fi stereo video cassette recorder

- To connect the external source, the source must have an audio output. In addition, you need an RCA connection cable.

- 1 Set the system to standby mode and disconnect it and the external source from the main.

- 2 Connect the audio cable to the rear of the mini-compact system.

Connect the... To the connector marked...

Red jack R (right)

White jack L (left)

- For optimum sound quality, do not invert the right and left channels.

- 3 Plug the system back into the main socket and press **Standby/On** to switch it on.

- 4 Select the **AUX** source by pressing **AUX** on the front panel. **Result:** **AUX** is displayed.

- 5 Switch the external source on.

- 6 Adjust the volume and balance as required:
 - ◆ Volume
 - ◆ Equalizer

Example: You can watch a film and take advantage of stereo sound provided that the original sound track is in stereo, (as if you were in a cinema).

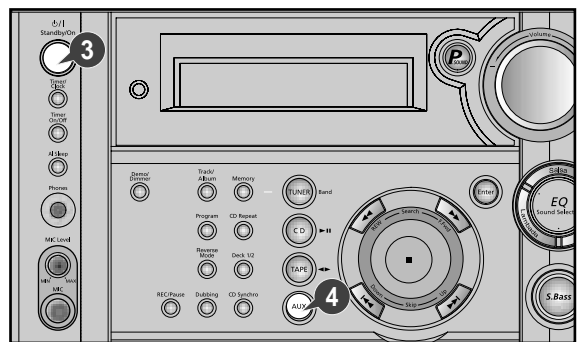
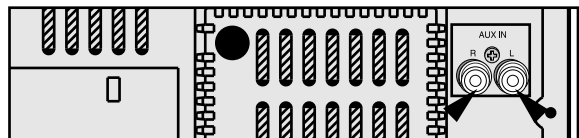

Connecting your System to the Power Supply

The main lead must be plugged into an appropriate socket.

- ☛ Before plugging your system into a main socket, you must check the voltage.

- 1 Check the position of the voltage selector on the rear of the system (OPTIONAL).
- 2 Plug the main lead (marked **AC Cord** on the rear of the system) into an appropriate socket.
- 3 Press the **On/Standby** button to switch your mini-compact system .

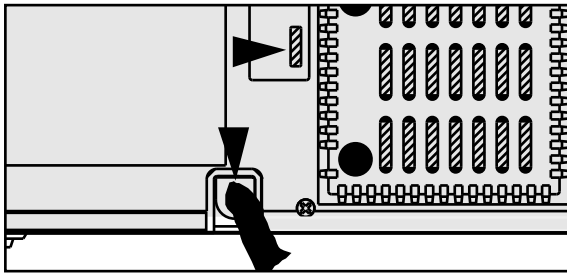

Demo/Dimmer function

All functions available on the system can be viewed on the display and the display's brightness can be switched between "on" and "off".

- 1 Press the **Demo/Dimmer** button.
Result: All functions available on the system appear on the front panel display.
- Each of these are explained in detail in this guide. Please refer to the relevant section.
- 2 Press the **Demo/Dimmer** button again.
Result: The Dimmer function is selected and the display darkens.
 - 3 Press the **Demo/Dimmer** button once again to brighten the front panel display.
- A display brightness control can only be performed while the system power is on.

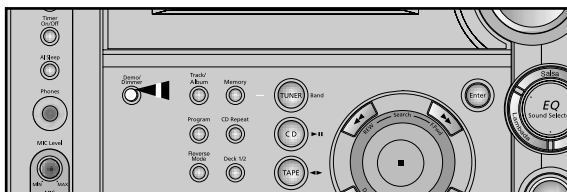

Setting the Clock

Your system is equipped with a clock which allows you to turn your system on and off automatically. You should set the clock:

- ◆ When you purchase the mini-compact system
- ◆ After a power failure
- ◆ After unplugging the unit

- ☛ ◆ For each step, you have a few seconds to set the required options. If you exceed this time, you must start again.

- 1 Switch the system on by pressing **Standby/on**.
 - 2 Press **Timer/Clock** twice.
Result: **CLOCK** is displayed.
 - 3 Press **Enter**.
Result: The hour flashes.
- | To... | Press the... |
|--------------------------|--------------|
| Increase the hours | Tuning Up |
| Decrease the hours | Tuning Down |
- 5 When the correct hour is displayed, press **Enter**.
Result: The minutes flash.
- | To... | Press the... |
|----------------------------|--------------|
| Increase the minutes | Tuning Up |
| Decrease the minutes | Tuning Down |
- 7 When the correct time is displayed, press **Enter**.
Result: The clock starts and is displayed, even when the system is in standby mode.

- ◆ You can display the time, even when you are using another function, by pressing **Timer/Clock** once.
- ◆ You can also use **Program/Set** button on the remote control to instead **Enter** button in step 3,5,7.

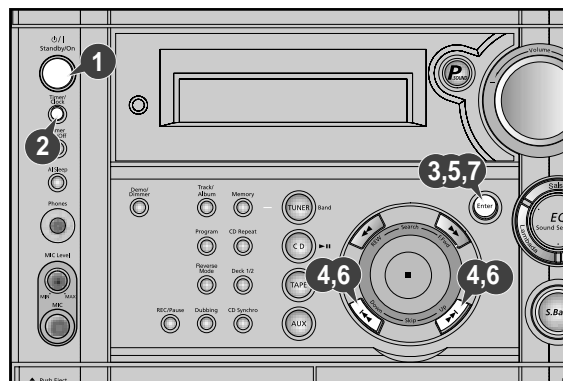

Loading and Changing Compact Discs



The CD disc changer can contain up to three 12 cm or 8 cm compact discs without using an adapter.

- ⚠ Never force the compact disc carousel when opening and closing the compartment.
Never press down or place objects on the carousel.
- Always treat your compact discs with care; refer, if necessary, to the section entitled "Precautions When Using Compact Discs" on page 22.

- 1 Switch the system on by pressing **Standby/on**.
- 2 Press the **Open/Close** (▲) button on the front panel.
Result: The compartment opens.
- 3 Place one or two discs in the front slots of the carousel, with the label on the discs facing upwards.
⚠ Check that the compact disc has been correctly inserted in the holder before closing the compartment.
- 4 If you wish to load a third compact disc, press the **Disc Change** button on the front panel (or **Disc Skip** on the remote control).
Result: The carousel rotates by 120°.
- 5 Close the compartment by pressing the **Open/Close** (▲) button again.
➤ If you wish to start playing a disc directly, you can also proceed as follows.

To play...	Press...
Disc 1	CD (▶) or Disc 1
Disc 2	Disc 2
Disc 3	Disc 3

Result: The compartment closes automatically and the disc selected starts playing.

- 6 To change or unload the compact disc changer, repeat Steps 2 to 5.

- ⚠ Keep the compartment closed whenever you are not using it, to prevent dust from entering.
- ♦ You can load or unload compact discs when the radio, tape or auxiliary source function is selected.

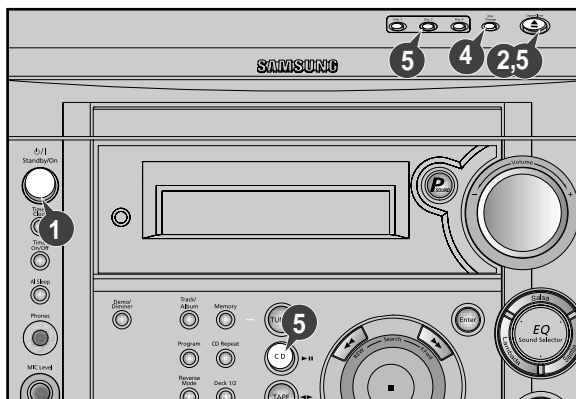

To replay the CD/MP3-CD

This is a player that enables the playback of audio CD, CD-R, CD-RW and MP3-CD and does not possess the function that saves MP3 files.

Do not use CDs of irregular shapes like heart or octagon shapes. The performance of the player may be degraded.

At least more than one CD should be inserted for playbacks.

- 1 Press the **On/Standby** button to switch on the power.
- 2 Press the **CD** (▶||) of the main unit to select the CD function.
- 3 Insert more than one CD or a MP3-CD.
- 4 Press the **CD** (▶||) button of the main unit or the ▶|| button of the remote control.
 - ♦ If there is more than one CD or an MP3-CD inserted, replays are then processed in order.
 - ♦ Your CD Player will take a few moments to scan through all the tracks recorded on a particular MP3-CD.
 - ♦ The English name of the song may be indicated on the display only if directly downloaded from the PC or if the purchased MP3-CD is sorted according to titles(directory). (Other languages besides English may not be indicated.)
 - ♦ The English name of the track may not be indicated depending on the characteristics of the MP3-CD.

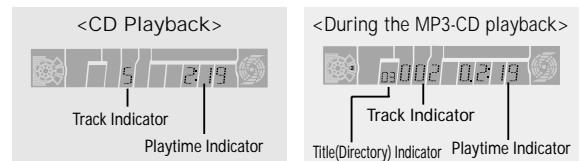

- 5 Adjust the volume according to needs with the following procedures.
 - ♦ Turn the Volume control of the main unit.
 - or
 - ♦ Press the VOL. + or – button of the remote control.
- 6 If it is desired to stop while the playback is processing, press the **CD** (▶||) button.
 - Press the **CD** (▶||) button once again to playback again.
- 7 To stop playback, press the ■ button.

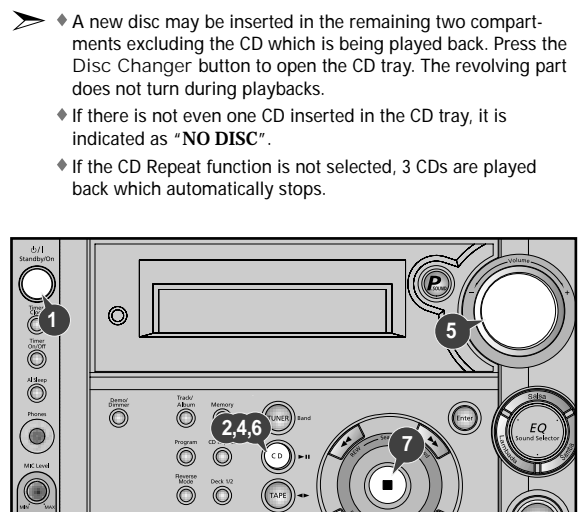

Selecting a CD in the Disc changer

The CD function is automatically selected when Disc Skip is pushed.

To select a specific disc, press the corresponding Disc (1, 2, 3) button on the front panel or Disc Skip on the remote control, until the required disc indicator flashes.

Result: All the discs will be played in turn, starting with the one selected.

- If you wish to play the current disc only, press Repeat on the front panel one or more times, until **1 CD** is displayed.
- ♦ If you use the Disc (1, 2, 3) function when listening to the radio or to a tape, the system switches automatically to the CD mode.
- ♦ If the disc selected is not loaded, the next disc is played automatically.

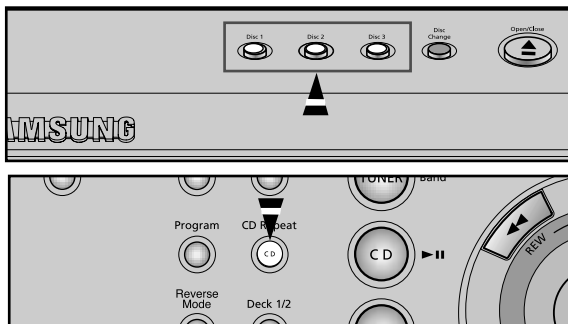

Selecting a CD Track

You can select the track you wish to listen to, either when the compact disc player is stopped or when a disc is playing.

To start playback at the beginning of the... Press the **◀▶** and **▶▶** ...

- Next track Press **▶▶** once
- Current track Press **◀▶** once
- Previous track Press **◀▶** twice
- Track of your choice The appropriate number of pressing the **◀▶** and **▶▶**.

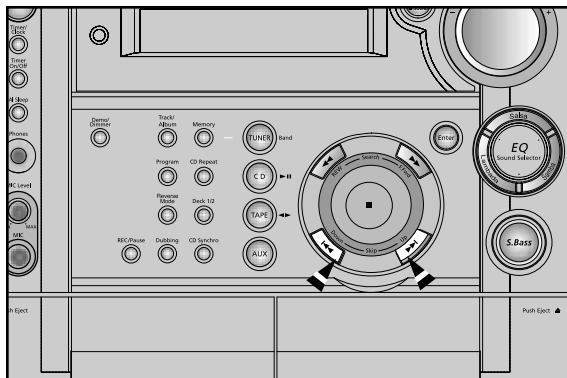

To select the MP3-CD title and track

The title and track of the MP3-CD desired to listen may be selected on stopping or during playbacks.

Main Unit

To move the title(directory), press the **◀▶**, **▶▶** button.



To move the track, press the **◀▶**, **▶▶** button.



- ♦ Moves the track within the title.
- ♦ If the **◀▶**, **▶▶** button is pressed more than the number of tracks within the title, it moves to the next title.

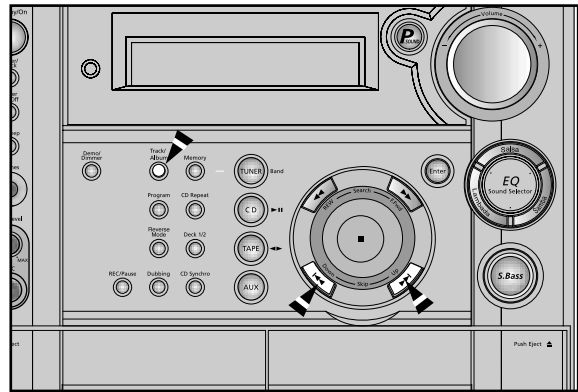

Remote Control

Press the **Tune/CD Mode** button, then select **'Title'** or **'Track'** and press the **◀▶**, **▶▶** button.

- ♦ If **'Title'** is selected in the display, the title moves.
- ♦ If **'Track'** is selected in the display, the track moves.

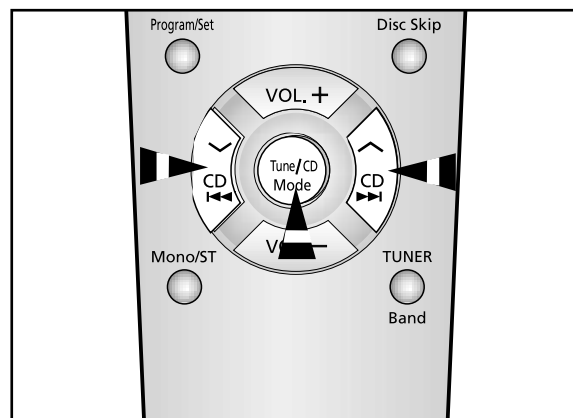

GB

©



What is MP3?

MP3 means MPEG1 Layer 3, the global standard for audio signal compression technology. It uses digital compression technology to compress original sound data by up to 12 times without sound quality degradation.

File Compatibility

- ◆ The unit will playback files created in MP3 format (Mpeg1.Layer3) with *.mp3 as their extension.
- ◆ Files created in MP2 format (Mpeg1.Layer2) with *.mp2 as their extension can also be played back.

How many MP3 files can a CD-R or CD-RW disc record?

The maximum capacity of one CD-R or CD-RW disc is 680MB.

Normally, one MP3 file has a capacity of 4MB, therefore approximately 170 files can be recorded on a single disc.

Regarding the playback of CD-R/RW

- ◆ In the case of an original CD-R(Recordable) recorded in audio CD format, CD-RW(Rewritable) and editing by the user, playback is processed on the respective completed status. (The player may not be played back according to the characteristics of the CD or recorded status.)
- ◆ The CD-RW is comparably less reflexive than CD which causes more time delay to read.

Searching for a Specific Music Passage on a CD

When listening to a compact disc, you can quickly search for a specific music passage on a track.

➤ It is recommended that you turn the volume down before using this function.

To search through the tracks...	Press and hold down...
Forwards.....	▶▶ for at least one second
Backwards.....	◀◀ for at least one second

You can also press and hold down ◀◀ / ▶▶ on the front panel to auto search through the tracks.

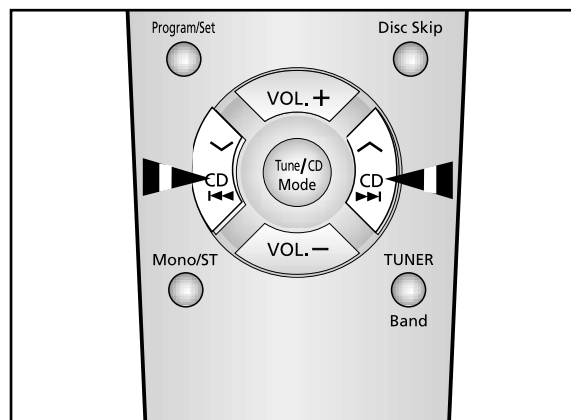

Playback sequence of titles and tracks

- ◆ In case of Window Explorer display.
- ◆ The arrows indicates playback sequence of titles and tracks.
- ◆ Tracks with jpg, wav or doc only are not audio files and therefore will be skipped.

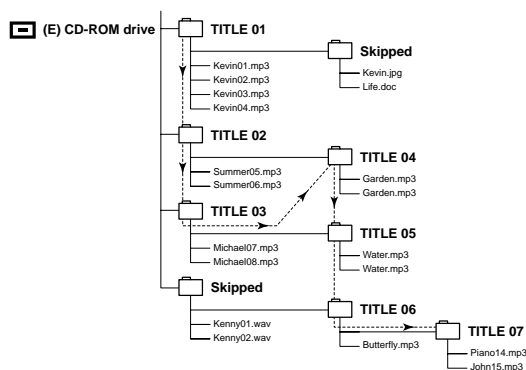

Function to skip through 10 tracks at a time

Press the +10 button briefly while playing back a CD. The track 10 tracks after the current one will then be played back.

Example: If you want to select track 43 during playback of track 15, press the +10 button three times, and then press the ►► button three times.

15 → 20 → 30 → 40 → 41 → 42 → 43

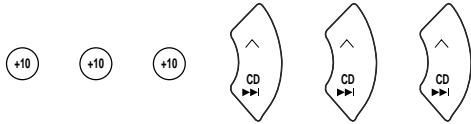

Last Memory Function

*This function is only available during playback of an MP3-CD.

When CD playback is selected again after your CD player has been stopped or turned off, this function allows playback from the start of the track that you last listened to.

◆ Press the Program/Set button while your MP-3 CD is being played back.
The **LAST ON** and **OFF** may be repeatedly selected.

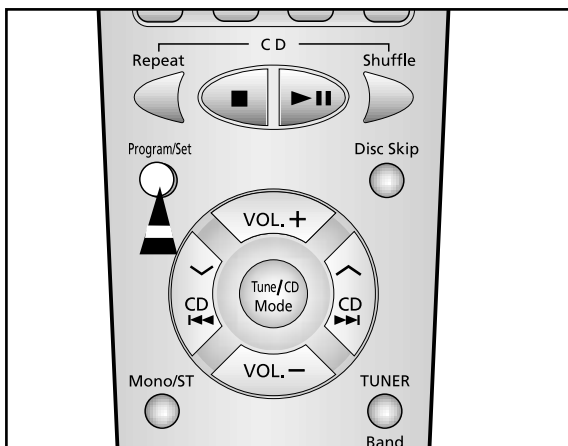
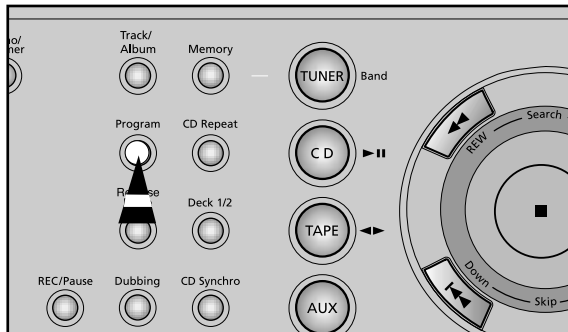

Shuffle Play Function

You can listen to the tracks on a compact disc in a different order each time, as the various tracks will be selected automatically in a random sequence.

- 1 Press the **Shuffle** button.
Result: The SHUFFLE(CD) or RANDOM(MP3-CD) indication appears and all the tracks are played in a random order. Both the track number and the playing time are displayed.
 - 2 When playing tracks in a random order, you can:
 - ◆ Move on to the next track (selected at random) by pressing ►►
 - ◆ Search quickly for a specific point in the current track by pressing ◀◀ more than one second.
 - 3 When you have finished the random playback, press ■ or press the **Shuffle** button again.
- Repeat and CD Synchro function are not available in Shuffle playing mode.

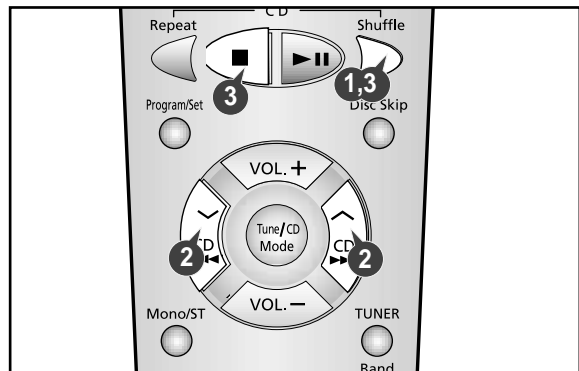

Repeating One or All Tracks on the Compact Discs

GB

You can repeat indefinitely:

- ◆ A specific track on a compact disc.
- ◆ All tracks on the compact disc selected.
- ◆ All discs loaded in the carousel

- 1 To repeat... Press Repeat on the Front Panel one or more times until...**
- | | |
|--------------------------------------|-----------------------------------|
| The current track indefinitely | REPEAT 1 is displayed |
| The selected disc | REPEAT 1 CD is displayed |
| All discs loaded | REPEAT ALL CD is displayed |
- 2** When you wish to stop the Repeat function, press **Repeat** until **ALL CD** or **1 CD** is displayed, or press **■**.

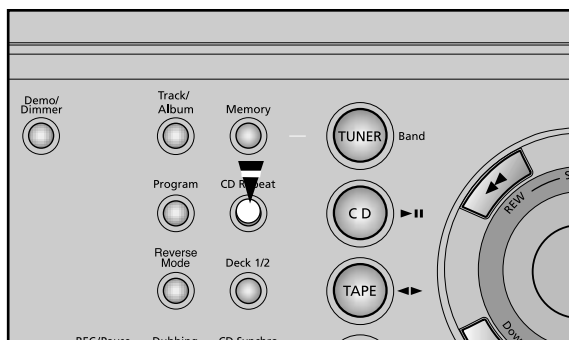

Programming the Order of CD Playback

You can decide:

- ◆ The order in which you listen to the tracks on the discs loaded
- ◆ Which tracks you do not wish to listen to
- ◆ You can programme up to 24 tracks.
- ◆ You must stop the compact disc player before selecting the tracks.
- ◆ This feature can be combined with the Repeat function.

- 1** If the CD function is selected, stop the player by pressing **■**.
- 2** Load the selected CDs.
- 3** Press **Program**.
Result: The following indications are displayed:
- PRGM
01 PR 01 --
- (01 = Programme No, DI = Disc No, -- = Track No on the disc)
- 4** If necessary, select the disc containing the required track by pressing the corresponding **Disc (1, 2, 3)** button.
- 5** Select the required track by pressing the **Up** and **Down** button:
◆ Press **◀** to move back through the tracks
◆ Press **▶** to move forward through the tracks
- 6** Press **Program** to confirm your selection.
Result: The selection is stored and **02 PR 01 --** is displayed.

- 7** To select other tracks, repeat Steps 4 to 6.
- 8** Press **CD (▶▶)** to listen to the track selection in the order programmed.
- 9** **To... Press the ◀◀ and ▶▶...**
- | | |
|---|--|
| Listen to the current track again | Press ◀◀ once |
| Listen to the previous track | Press ◀◀ twice |
| Listen to the next track | Press ▶▶ once |
| Skip forwards or backwards one or more tracks | The appropriate number of pressing the ◀◀ and ▶▶ |
- 10** To cancel the selection, press **■**.
◆ Once if the compact disc player is stopped
Result: **PRGM** is no longer displayed.
- ◆ If you open the compartment, the selection is cancelled.
◆ If you select the number of a disc which is not loaded or a track which does not exist on the CD, the selection skips to the next programmed track.

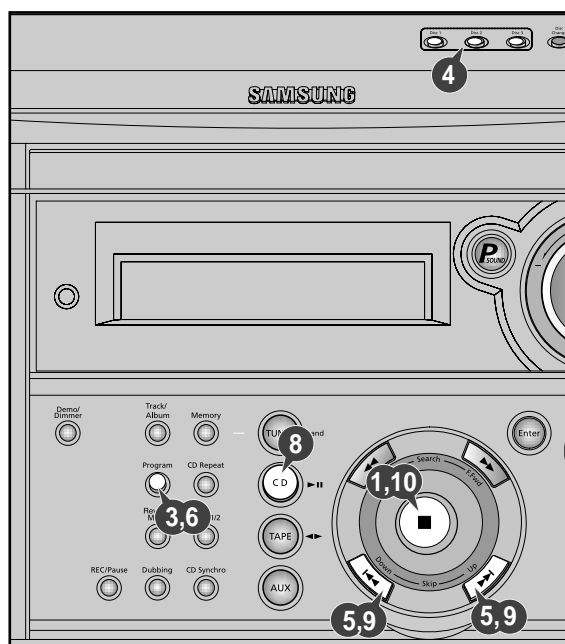

Checking or Changing Programmed Tracks

You can check or change your selection of tracks at any time.

- 1 Press **■** once if you have started listening to the selection.
- 2 Press **Program**.
Result: The following indications appear: (CH = Check, 01=Program No, 01 = Disc No, -- = Track No on the disc)
➤ If you have already programmed 24 tracks, **CH** is displayed instead of **PR** when you press **Program**.
- 3 Press **Program** again.
Result: The first track selected is displayed, together with the letter **CH**(Change).
- 4 Press **Program** one or more times until the track to be changed is displayed.
- 5 If necessary, press the corresponding **Disc (1, 2, 3)** button to change discs.
- 6 Press **◀/▶** to select a different track.
- 7 Press **Program** to confirm your change.
- 8 Press **CD (▶||)** to start listening to the selection.
Result: The first track selected is played.

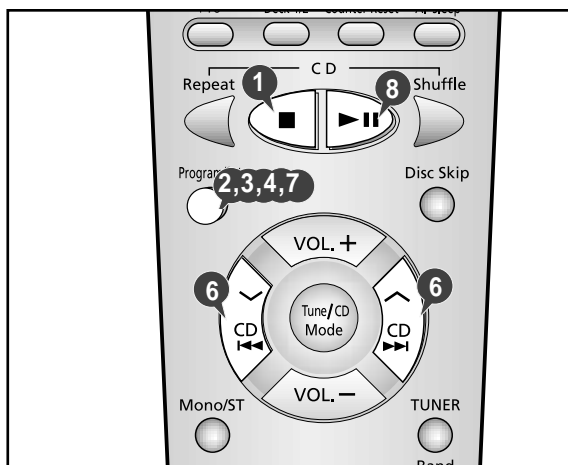
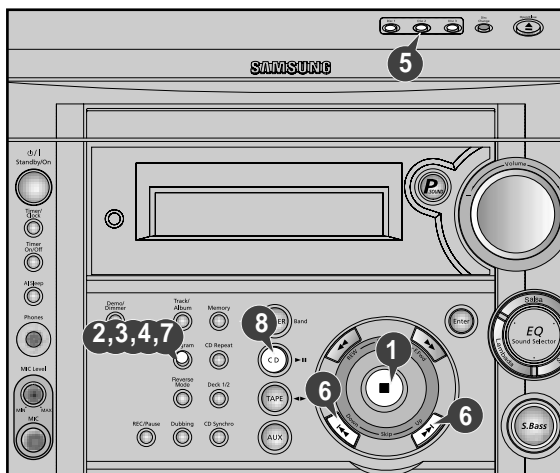

Searching for and Storing the Radio Stations

You can store up to:

- ◆ 15 FM stations
- ◆ 15 AM stations
(8 MW stations, 7 LW stations)



- 1 Switch the system on by pressing **Standby/on**.
- 2 Select the **TUNER** function by pressing **TUNER**.
- 3 Select the required frequency band by pressing **TUNER (Band)** again on the front panel or **TUNER (Band)** on the remote control.
Result: The appropriate indication is displayed:

◆ FM	Frequency Modulation
◆ AM(MW)	Medium Wave
◆ LW(Optional)	Long Wave
- 4 Tune in to the desired station.
 - Manual tuning**
 - ◆ Press the **Tuning Mode** button so that the "MANUAL" indicator lights up on the front panel display.
 - ◆ Press **◀/▶** on the main unit to tune in to the desired station manually.
 - or
 - ◆ Press **Tuning** **∨** or **∧** on the remote control to do the same.

Automatic tuning

- ◆ Press and hold **◀/▶** on the main unit for more than 1 second so that the "AUTO" indicator lights up on the front panel display.
- ◆ Press and briefly hold **◀/▶** on the main unit to begin automatic tuning.
- or
- ◆ Press and briefly hold **Tuning** **∨** or **∧** on the remote control to do the same.
- ◆ Use the manual tuning method if the automatic tuning search does not stop at the desired station because the signal is weak.

➤ For details on the Preset function, see the "Selecting a Stored Station" on page 16.

- 5 Adjust the volume by:
 - ◆ Turning the **Volume** knob on the front panel
 - or
 - ◆ Pressing the **VOL. +** or **-** buttons on the remote control
- 6 Select the FM stereo or mono mode by pressing **Mono/ST.** on the remote control.

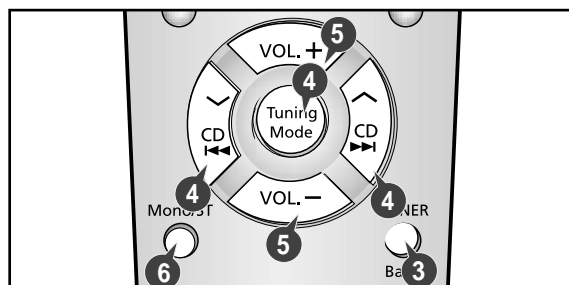
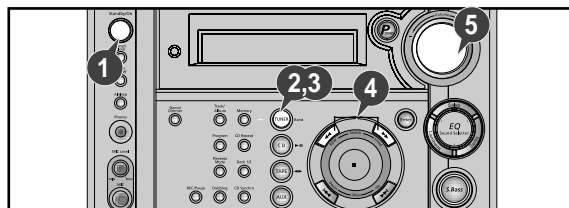

Searching for and Storing the Radio Stations (continued)

GB



- 7 If you do not want to store the radio station found, revert to Step 4 and search for another station.

Otherwise:

- a Press **Memory**.
Result: The **PRGM** is displayed for a few seconds.
- b Press **Tuning Down** and **Up** to assign a programme number between 1 and 15.
- c Press **Memory** to store the radio station.
Result: **PRGM** is no longer displayed and the station is stored.

- 8 To store any other radio frequencies required, repeat Steps 3 to 7.

➤ The PROGRAM function can be used to assign a new station to an existing programme number.

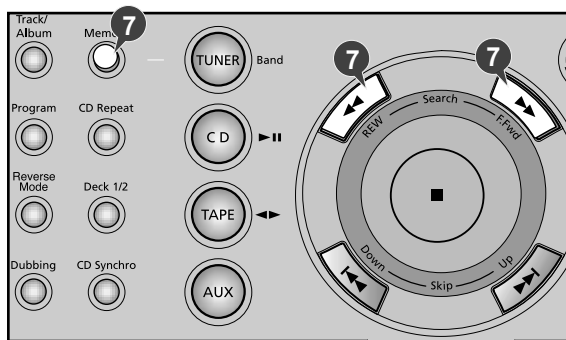

➤ In Tuner Mode

- ◆ In manual tuning mode, you can use **◀▶** button to manual search a radio station.
- ◆ During Tuner auto searching, press **■** button to stop auto searching.
- ◆ In Preset tuning mode, you can use **◀▶** button to search a stored radio station.
- ◆ you can use **Program/Set** button on the remote control to instead **Memory** button in step 7.

Selecting a Stored Station

You can listen to a stored radio station as follows:

- 1 Switch the system on by pressing **Standby/on**.
- 2 Select the TUNER function by pressing **TUNER**.
- 3 Select the required frequency band by pressing **TUNER (Band)** on the remote control or **TUNER (Band)** again on the front panel.
- 4 Press **◀▶** button on the front panel of the unit, or the **Tune/CD Mode** button on the remote control until **"PRESET"** is displayed.
- 5 press **◀▶** on the front panel of the unit to select the desired station.
or
Select the desired station by pressing the station number stored, using the **Tuning** **∨** or **∧** button on the remote control.
Result: The desired station is now received.

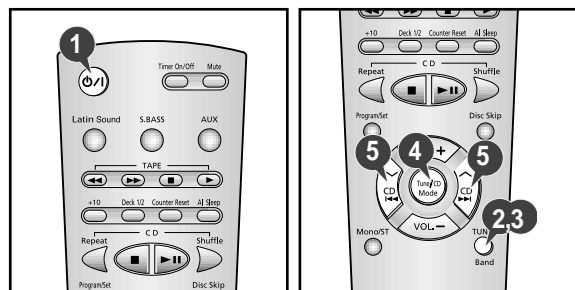

Improving Radio Reception

You can improve the quality of radio reception by:

- ◆ Rotating the FM or AM(MW) aerial
 - ◆ Testing the positions of the FM and AM(MW) aerials before fixing them permanently
- If reception from a specific FM radio station is poor, press **Mono/ST** on the remote control to switch from stereo mode to mono. The quality of the sound will be improved.

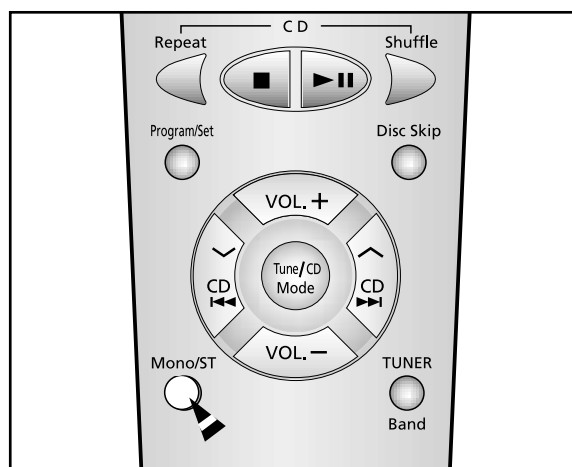

Listening to a Cassette

- Always treat your cassettes with care; refer, if necessary, to the section entitled "Precautions When Using Audio Cassettes" on page 23.

- 1 Switch the system on by pressing the **Standby/On** button.
- 2 Select the TAPE function by pressing **TAPE**.
- 3 Open either cassette deck 1 or 2 by pushing and releasing the deck cover where **Push Eject** (▲) is written.
- 4 Insert the pre-recorded cassette with the open edge of the tape facing downward.
- 5 Close the deck by pushing on it until it clicks into place.
Result: Depending on the deck selected, the 1 or 2 indication is displayed in front of the counter number.

- If you insert a cassette in both decks, the system selects the deck in which you inserted the second cassette.

- 6 If you have inserted two cassettes, press **Deck 1/2** on the front panel or directly the **Deck 1/2** button on the remote control to select the cassette to be played.
Result: Depending on the deck selected, the TAPE 1 or TAPE 2 indication is displayed.

- | To listen to... | Press ... | |
|-----------------|-----------------------|-------------------|
| Side A | TAPE (◀▶) once | Deck 1 and Deck 2 |
| Side B | TAPE (◀▶) twice | Deck 2 only |
- Result:** The cassette starts playing.

When the cassette is stopped, select one of the following functions as required.

- | To... | Press ... |
|---------------------------------|-----------|
| Rewind the cassette | ◀◀ |
| Fast-forward the cassette | ▶▶ |
- 9 When you have finished this function, press **TAPE** ■ on the remote control or ■ on the front panel to stop .

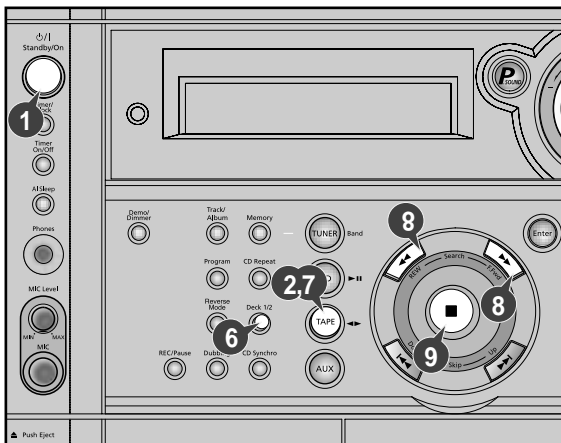

CD Synchro Record Feature

You can record a compact disc on a cassette in two different ways:

- ◆ Synchronised recording

- ◆ Direct recording

This feature enables you to synchronize the start of the recording with the start of the disc or track of your choice.

- ◆ CD Synchro recording not function for MP3-CD

- 1 Switch the system on by pressing **Standby/On**.
- 2 Insert a blank cassette in Deck 2.
- 3 Select the CD function by pressing **CD** on the front panel.
- 4 Load a compact disc.
- 5 Select the required disc.
- 6 Select the required track and press **CD Synchro** or press **CD Synchro** directly to start recording at the beginning of the disc.
Result: "REC" and "CD SYNC" are displayed and recording starts.

- | To stop... | Press ... |
|--|-----------|
| Recording and playing the compact disc | ■ |

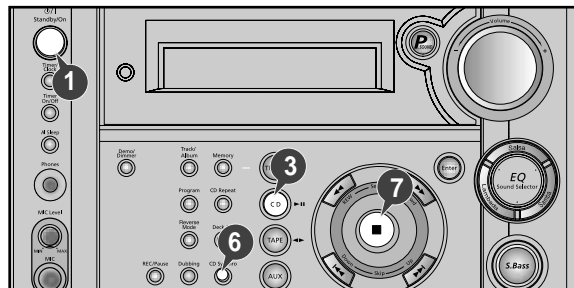

Recording a Compact Disc

The direct recording mode enables you to start recording with any track on the compact disc.

- ◆ You can only record on cassettes in Deck 2.

- ◆ You do not need to adjust the volume, as it has no effect on the recording.

- 1 Switch your system on by pressing **Standby/On**.
- 2 Insert a blank cassette in Deck 2.
- 3 Select the CD function by pressing **CD** on the front panel.
- 4 Load the compact disc.
- 5 Select the required disc.
- 6 Select the required track on the compact disc and press ▶|| on the front panel or ▶|| on the remote control to set the compact disc player to Pause mode.
- 7 Press the **REC/Pause**.
Result: REC is displayed .
- 8 Press the ▶|| to start playing the track.
Result: The track is recorded on the cassette.
- 9 When you have finished recording, press **TAPE** ■ on the remote control or ■ on the front panel to stop recording.

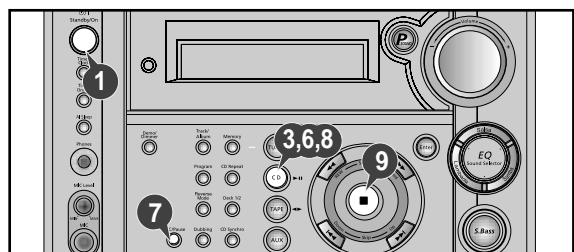

Recording a Radio Programme



You can record a radio programme of your choice.

- ◆ You can only record on cassettes in Deck 2.
- ◆ You do not need to adjust the volume, as it has no effect on the recording.

- 1 Switch the system on by pressing **Standby/On**.
- 2 Insert a blank cassette in Deck 2.
- 3 Select the **TUNER** function by pressing **TUNER**.
- 4 Select the radio station that you wish to record by pressing **Tuning** \wedge or \vee on the remote control or by press the **Tuning Down** or **Up** on the front panel.
- 5 Press **REC/Pause**.
Result: REC is displayed in red and recording starts.
- 6 When you have finished recording, press the **TAPE** \blacksquare on the remote control or \blacksquare on the front panel to stop recording.

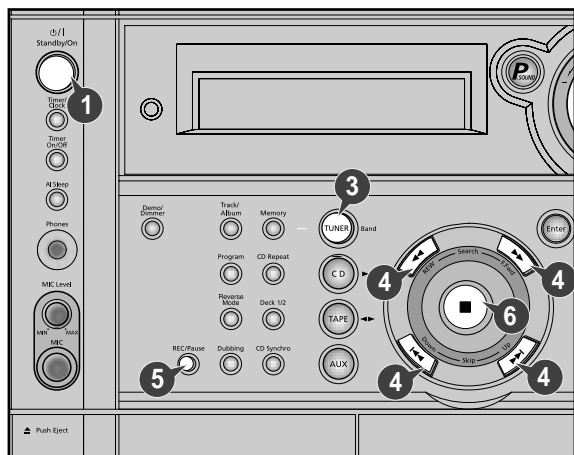

- 5 Press \blacksquare on the front panel or **TAPE** \blacksquare on the remote control when you have finished recording.

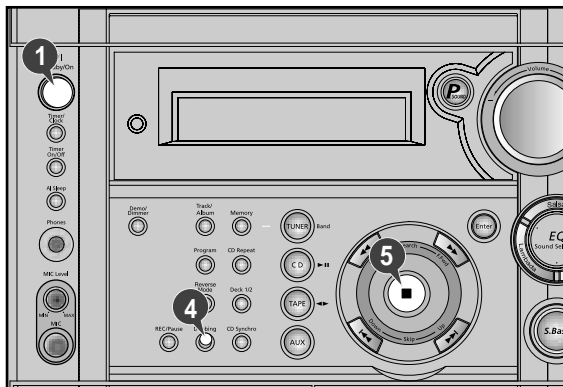

Tape Counter

When playing a cassette, a counter is displayed to enable you to take note of the counter value at the start of each track and thus start playback at the beginning of the track to which you wish to listen.

➤ The counter is only displayed when a cassette is being played. Before starting to record a cassette for which you wish to take note of the counter values at the beginning of each track, reset the counter by pressing **Counter Reset**.



Selecting the Cassette Playback Mode(only for Deck 2)

Your mini-compact system has three cassette playback modes which enable you to listen to both sides of a cassette automatically. Press **REV.** Mode until the appropriate symbol is displayed.

When the display indicates... The mini-compact system plays back...

- One side of the selected cassette and then stops.
- One side of the cassette. The other side of the cassette and then stops.
- Both sides of the cassette indefinitely until you press stop.



Copying a Cassette (Dubbing)

You can copy a cassette from Deck 1 to Deck 2.

- ◆ Normal speed dubbing
- You do not need to adjust the volume, as it has no effect on the recording.
- ◆ Take care not to insert the tape to be copied in Deck 2, as it will be erased when you start recording.

- 1 Switch your system on by pressing **Standby/On**.
- 2 Insert a blank cassette in Deck 2.
- 3 Insert the tape to be copied in Deck 1.
- 4 **To copy a cassette at... Press...**
Normal speed dubbing Dubbing

Result: The appropriate indications are displayed and the cassette in Deck 1 is copied to the cassette in Deck 2.

Timer Function



The timer enables you to switch the system on or off at specific times.

Example: You wish to wake up to music every morning.

➤ If you no longer want the system to be switched on or off automatically, you must cancel the timer.

- ◆ Before setting the timer, check that the current time is correct.
- ◆ For each step, you have a few seconds to set the required options. If you exceed this time, you must start again.

- 1 Switch the system on by pressing **Standby/On**.
- 2 Press **Timer/Clock** until **TIMER** is displayed.
- 3 Press **Enter**.
Result: **ON TIME** is displayed (instead of the equalizer symbols) for a few seconds, followed by any switch-on time already set; you can set the timer switch-on time.
- 4 Set the timer switch-on time.
 - a Set the hour by pressing the **◀▶** buttons.
 - b Press **Enter**.
Result: The minutes flash.
 - c Set the minutes by pressing the **◀▶** buttons.
 - d Press **Enter**.
Result: **OFF TIME** is displayed (instead of the equalizer symbols) for a few seconds, followed by any switch-off time already set; you can now set the timer switch-off time.
- 5 Set the timer switch-off time.
 - a Set the hour by pressing the **◀▶** buttons.
 - b Press **Enter**.
Result: The minutes flash.
 - c Set the minutes by pressing the **◀▶** buttons.
 - d Press **Enter**.
Result: **VOL XX** is displayed, where **XX** corresponds to the volume already set.
- 6 Press **Tuning Down** and **Up** to adjust the volume level and press **Enter**.
Result: The source to be selected is displayed.
- 7 pressing the **◀▶** buttons to select the source to be played when the system switches on .

If you select...	You must also...
TAPE (cassette)	Insert a recorded cassette in one of the decks before setting the system to standby.
TUNER (radio)	<ol style="list-style-type: none"> a Press Enter. b Select a preset station by pressing the ◀▶ buttons.
CD (compact disc)	Load one or more compact discs.
- 8 Press **Enter** to confirm the timer.
- 9 Press **Standby/On** to set the system to standby mode.
Result: **T** appears on the front panel display next to the time, indicating the timer has been set. The timer automatically turns the system on or off at a designated time.

➤ If the timer switch on and off times are identical, the word **ERROR** is displayed.

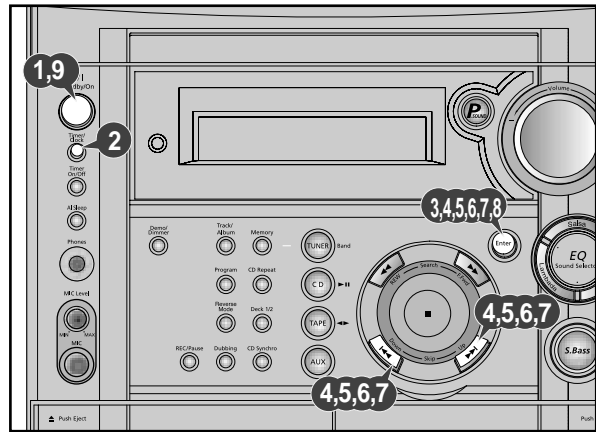

➤ To set the timer function

- ◆ You can also use Program/Set button on the remote control to instead Enter button in step 3,4,5,6,7,8.

Cancelling the Timer



After having set the timer, it will start automatically as shown by the **TIMER** indication on the display. If you no longer wish to use the timer, you must cancel it.

➤ You can stop the timer at any time (system on or in standby mode).

To...	Press Timer-On/Off...
Cancel the timer	Once. Result: is no longer displayed.
Restart the timer	Twice. Result: is displayed again.

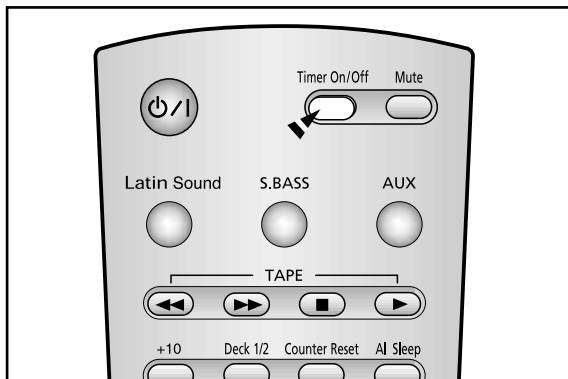

Selecting an Equalizer Preset

Your mini-compact system is equipped with a preset equalizer that allows you to choose the most appropriate balance between treble and bass frequencies, according to the type of music you are listening to.

◆ Press EQ Preset (**Salsa/Samba/Lambada**) on the front panel or **Latin Sound** on the remote control until the required option is selected.

To obtain a...	Select...
Normal balance (linear)	PASS
Balance suitable for Salsa music:	SALSA
Balance suitable for Samba music:	SAMBA
Balance suitable for Lambada music	LAMBADA

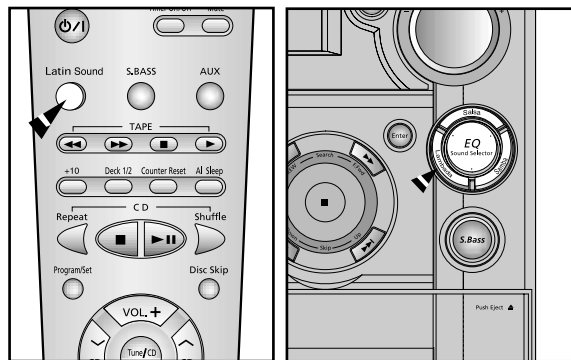

Mute Function

You can turn the sound off temporarily on your system.
Example: You wish to answer a telephone call.

- 1 Press Mute.
- 2 To switch the sound back on (at the same volume as before), press **Mute** again or the **Volume** buttons.

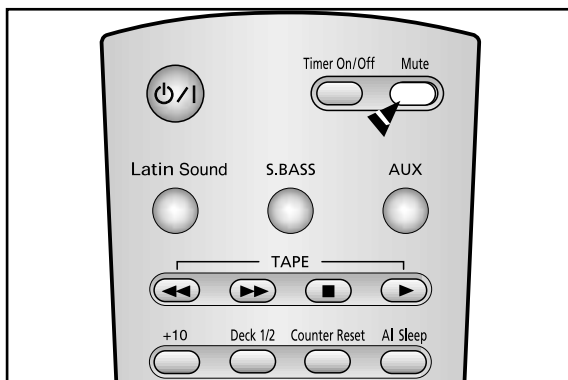

Power Sound Function

Your mini-compact system is equipped with the function of Power Sound .
The function of Power Sound amplifies bass and improves high key or bass twice as much for you to appreciate powerful real sound.

- 1 Press the **P.Sound** button on the front panel.
Result: Press **P.Sound** button on the front panel, "**P.SOUND**" is displayed.
- 2 To cancel this function, press **P.Sound** button again .

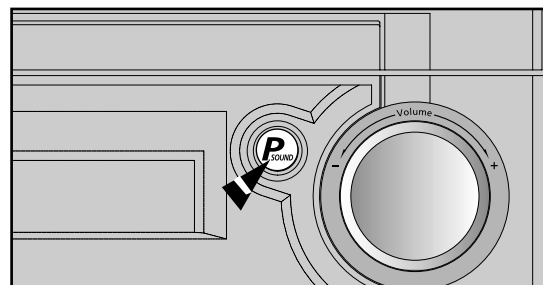

Setting the System to Switch off Automatically

While listening to a compact disc or a cassette, you can set the system to switch off automatically

Example: You wish to go to sleep to music.

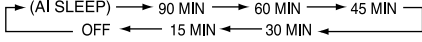
- 1 Press **AI Sleep**.
Result: playback starts and the following indications are displayed:
90 MIN
- 2 Press **AI Sleep** one or more times to indicate how long the system should continue playing before it switches off:

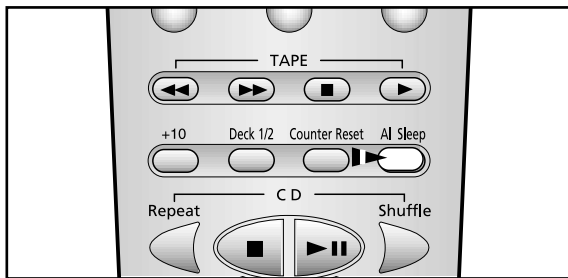
 - At any time, you can:
 - ◆ Check the remaining time by pressing **AI Sleep**
 - ◆ Change the remaining time by repeating Steps 1 and 2
- 3 Press **AI Sleep** one or more times until **AI SLEEP** is displayed.
Result: The system will automatically switch off at the end of disc or cassette.
- 4 To cancel SLEEP or AI OFF function, press **AI Sleep** one or more times until **OFF** is displayed.



Super Bass Sound

Your mini-compact system has a bass amplification function called SBS (Super Bass Sound). This function makes the sound more powerful and real.

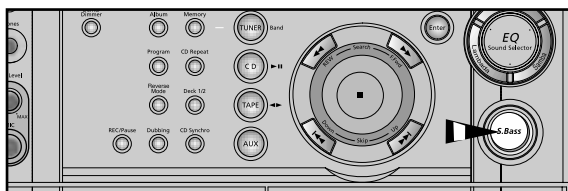
- 1 Press the **S. Bass** button on the front panel.
Result: **S. BASS** is displayed and "SBS ON" is displayed for a few seconds.
- 2 To cancel this function, press **S. Bass** again, "OFF" is displayed for a few seconds.



Connecting Headphones

You can connect a set of headphones to your mini-compact system so that you can listen to music or radio programmers without disturbing other people in the room. The earphones must have a 3.5 ø jack or an appropriate adapter.

Connect the headphones to the **Phones** jack on the front panel.
Result: The loudspeakers are no longer used to output the sound.

➤ Prolonged use of headphones at a high volume may damage your hearing.

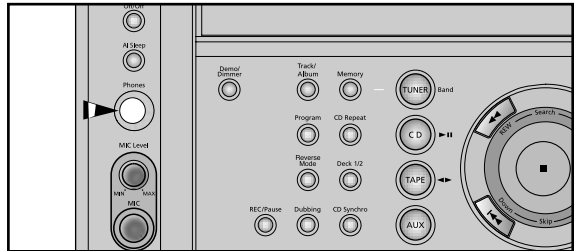

Microphone Function(option)

The microphone enables the user to mix in his or her vocals to sing-along with the music or recording .

Preparation

Plug the microphone with a 6.3mm mic jack into microphone terminal.

- 1 Turn the **MIC Level.** knob to adjust the mic volume.

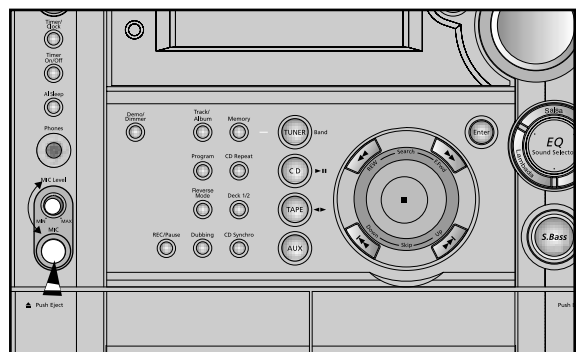

Safety Precautions

GB

The following diagrams illustrate the precautions to be taken when using or moving your mini-compact system.

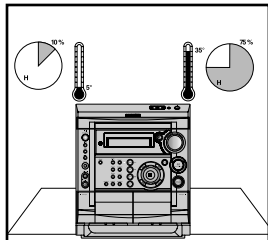

Ambient operating conditions:
Ambient temperature 5°C-35°C
Humidity 10-75%

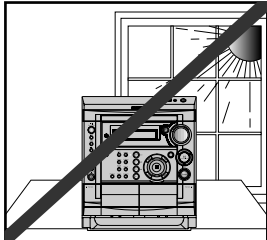

Do not expose the unit to direct sun radiation or other heat sources. This could lead to overheating and malfunction of the unit.

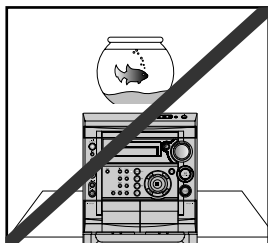

Do not place potted plants or vases on top of the unit. Moisture entering the unit could lead to dangerous electric shock and can cause equipment damage. In such events immediately disconnect the main plug from the socket.

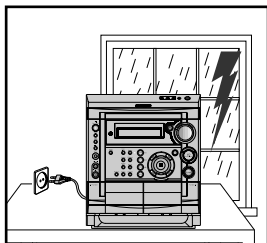

During thunderstorms, disconnect the main plug from the socket. Main voltage peaks due to lightning could damage the unit.

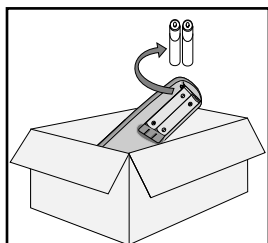

Remove the batteries from the remote control, if not used for any extended periods. Leaking batteries can cause serious damage to the remote control.

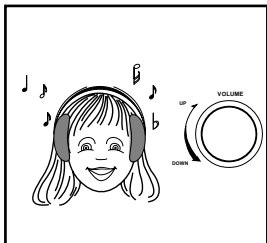

When using headphones, take care not to listen at excessive volumes. Extended use of headphones at high volumes will lead to hearing damage.

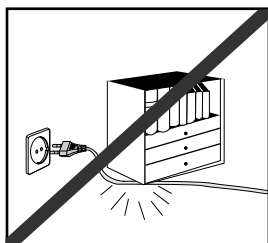

Do not place heavy items on the main lead. Main cable damage can lead to damage of the equipment (fire hazard) and can cause electric shock.

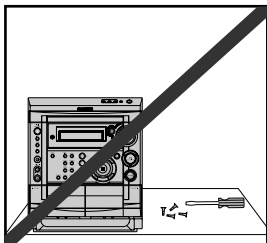

Do not remove any equipment panels. The inside of the unit contains live components, which cause electric shock.

Cleaning Your Mini-Compact System

To obtain the best possible results from your mini-compact system, you must clean the following elements regularly:

- ◆ The outer casing
- ◆ The compact disc player
- ◆ The cassette players (heads, rollers and drive capstans)
- ◆ Always unplug the system from the wall outlet:
 - ◆ Before cleaning it
 - ◆ If you are not going to be using it for a long time

Outer Casing

Clean the outer casing regularly using a soft cloth and a light detergent. Do not use abrasive powders, liquids or aerosol cleaners. Never let any liquids get into the system.

Compact Disc Player

- 1 Before playing a compact disc, clean it with a special CD cleaning agent. Do not use the same cleaning agents as for vinyl LP records. Carefully wipe the disc from the centre outward.
- 2 Regularly clean the player with a special cleaning disc (available from your local dealer).

Tape Decks

- 1 Press Push Eject (▲) to open the cassette deck.
- 2 Use a cotton bud and a special cassette cleaning agent to clean the:
 - ◆ Head (1)
 - ◆ Rollers (2)
 - ◆ Drive capstans (3)

- ◆ If you will not be using the remote control for a long time, remove the batteries to prevent corrosion.
- ◆ Although your system is very hard-wearing, it should not be used in an excessively dusty environment or subjected to shocks or extreme heat (close to heating appliances or in direct sunlight, etc.).
- ◆ If the unit emits an unpleasant odor when in use, unplug it from the main supply and contact the after-sales service.

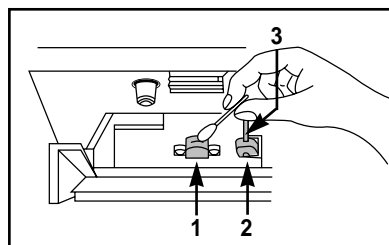

Precautions When Using Compact Discs

- ◆ Handle your compact discs with care. Always hold them by the edges to avoid leaving fingerprints on the shiny surface.
- ◆ When you have finished playing a compact disc, always put it back in its case.
- ◆ Do not fix paper or adhesive tape to the discs and do not write on the label.
- ◆ Clean them with a special-purpose cloth.
- ◆ Store your compact discs in a clean place, out of direct sunlight, where they will not be exposed to high temperatures.
- ◆ Always use compact discs marked **DISC**.

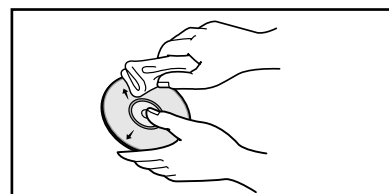

Precautions When Using Audio Cassettes

- ◆ Check that the tape in the cassette is sufficiently taught.
- ◆ To prevent erasing a cassette that you wish to keep, remove the safety tab on the upper edge of the cassette. To record a cassette, where the tab has been broken, simply cover the opening with adhesive tape.
- ◆ When you have finished playing a cassette, always put it back in its case.
- ◆ Store your cassettes in a clean place, out of direct sunlight, where they will not be exposed to high temperatures.
- ◆ Avoid using 120-minute cassettes as they place unnecessary strain on the tape mechanism.

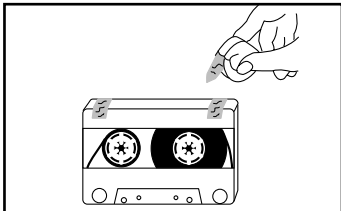
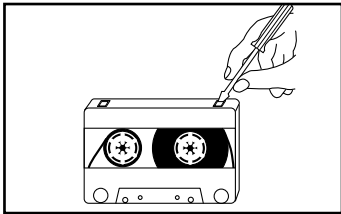
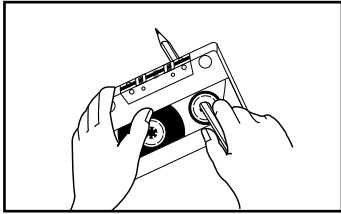

Before Contacting the After-Sales Service

It always takes a little time to become familiar with a new appliance. If you have any of the problems listed below, try the solutions given. They may save you the time and inconvenience of an unnecessary service call.

Problem	Checks/Explanation
The system does not work	<ul style="list-style-type: none"> • The main lead is not correctly plugged into a wall socket or the wall socket is not switched on. • The remote control batteries need replacing or the polarity has not been respected. • The Standby/On button has not been pressed.
There is no sound	<ul style="list-style-type: none"> • The volume has been completely turned down. • The correct function (TUNER, CD, TAPE, AUX) has not been selected. • You have connected a set of earphones. • The loudspeaker wires have been disconnected. • The MUTE button has been pressed.
The Timer does not work	<ul style="list-style-type: none"> • The timer has been stopped by pressing TIMER ON/OFF.
System still doesn't work, even after following steps above.	<ul style="list-style-type: none"> • Press the S.Bass button for 5 seconds in power 'OFF'(standby), the system is returned the original position (RESET)
The compact disc player does not start playing	<ul style="list-style-type: none"> • The CD function has not been selected. • The disc has been inserted face down or is either dirty or scratched. • The laser sensor is dirty or dusty. • The system has not been installed on a flat, horizontal surface. • Condensation has formed in the player; leave the system in a warm, airy room for at least one hour.
The tape does not start playing	<ul style="list-style-type: none"> • The TAPE function has not been selected. • The cassette has not been inserted correctly. • The cassette player has not been closed. • The tape is either slack or broken.
The volume falls off	<ul style="list-style-type: none"> • The audio heads are dirty. • The rollers or drive capstans are dirty. • The tape is worn.
The cassette is not erased correctly There is excessive wow and flutter	<ul style="list-style-type: none"> • The TUNER function has not been selected. • The radio frequency has not been correctly selected.
Reception is poor or no radio stations are received at all	<ul style="list-style-type: none"> • The aerial has been disconnected or is not facing the right way. Turn it until you find the best orientation. • You are in a building that blocks radio waves; you must use an outside aerial.

If the above guidelines do not allow you to solve the problem, take a note of:

- ◆ The model and serial numbers, normally printed on the rear of the system
- ◆ Your warranty details
- ◆ A clear description of the problem

Then contact your local dealer or SAMSUNG after-sales service.



Technical Specifications



SAMSUNG strives to improve its products at all times. Both the design specifications and these user instructions are thus subject to change without notice.

RADIO	
LW(option)	
Usable sensitivity	60 dB
AM (MW)	
Signal/noise ratio	40 dB
Usable sensitivity	54 dB
Total harmonic distortion	2 %
FM	
Signal/noise ratio	62 dB
Usable sensitivity	10 dB
Total harmonic distortion	0.3 %
.....	
COMPACT DISC PLAYER	
Capacity	3 discs
Frequency range	20 Hz - 20 KHz (\pm 1 dB)
Signal/noise ratio	90 dB (at 1 KHz) with filter
Distortion	0.05 % (at 1 KHz)
Channel separation	74 dB
Disc sizes	Diameter: 120 or 80 mm. Thickness: 1.2 mm
.....	
TAPE DECK	
Frequency range	125 Hz ~ 8 KHz
Signal/noise ratio	40 dB
Channel separation	35 dB
Erasing effect	50 dB
.....	
AMPLIFIER	
Output power (6 Ω)	35 Watts/CH RMS, IEC (total harmonic distortion: 10 %)
Channel separation	45 dB
Signal/noise ratio	75 dB
.....	
GENERAL	
Dimensions	270 (W) x 317 (H) x 370 (D) mm

THIS APPLIANCE IS MANUFACTURED BY:

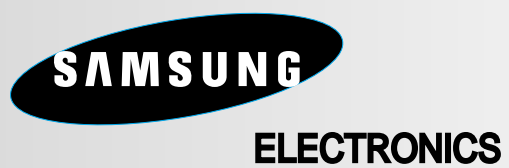

AH68-01230L