

SAMSUNG

SF-530 Series User's Guide

SAMSUNG LASER FACSIMILE
User's Guide

SAMSUNG DIGITall
everyone's invited™

Laser Facsimile

SF-530 Series



Visit us at
<http://www.samsungelectronics.com/mfp>
<http://www.samsungelectronics.com/fax>

P/N. JC68-00648A Rev.3.00

For UK customers:
To reorder your consumables
Call 0800 3164060
For Technical Assistance
Call 0870 2420303

Trademarks

- SmarThru 2, MailBox, Image Manager, Scan Manager, Copy Manager, Image Viewer, AnyPage are trademarks of Samsung Electronics.
- Windows, Windows 95, Windows 98, Windows Me, Windows NT and Windows 2000 are trademarks of Microsoft corporation.
- Other names and trademarks mentioned in this manual are trademarks of their respective holders.

Contents

Chapter 1

Getting Started

Introduction

Welcome!	1.1
Contents	1.3
Identifying Parts	1.4

Setting Up Your Machine

Choosing a Location	1.9
Preparing Your Machine for Use	1.9
Attaching the Supports	1.10
Connecting to the Phone Line	1.12
Connecting to the Computer (SF-531P only)	1.14
Plugging In the Power	1.15
Loading Paper	1.15
Installing the Toner Cartridge	1.18
Setting the Date and Time	1.20
Setting Your Fax Number and Name	1.21
Testing the Machine	1.21
Using Save Modes	1.22

Chapter 2

Installing Samsung Software (SF-531P only)

Samsung SmarThru

About Samsung SmarThru Software	2.1
---------------------------------------	-----

Installing Software

System Requirements	2.3
Installing the Samsung Software	2.4
Configuring the Fax Gate on Your PC	2.6
Configuring the Internet Gate on Your PC	2.9
Using Your Machine with a USB Cable	2.13
Making Installation Diskettes	2.16
Installing Software from Diskettes	2.17
Uninstalling Samsung Software	2.18

Setting Up Stand-alone Fax System

Setting Volume -----	3.1
Setting Alert Tones -----	3.2
Setting User-Selectable System Options -----	3.2

Sending a Fax

Preparing Documents for Faxing or Copying -----	3.7
Setting Document Resolution and Contrast -----	3.8
Loading Documents -----	3.9
Sending a Fax Automatically -----	3.10
Sending a Fax After Talking -----	3.11
Voice Request -----	3.12

Receiving a Fax

About Reception Modes -----	3.13
Loading Paper for Receiving Faxes -----	3.14
Receiving Automatically in FAX Mode -----	3.14
Receiving in AUTO Mode -----	3.15
Receiving Automatically in ANS/FAX Mode -----	3.15
Receiving Manually in TEL Mode -----	3.16
Receiving Manually Using an Extension telephone-----	3.16

Making a Copy

Copying Overview -----	3.17
Making a Single Copy -----	3.17
Using Advanced Copy Features -----	3.18

Automatic Dialling

How To Enter a Name Using the Number Keys -----	3.19
One-Touch Dialling -----	3.21
Speed Dialling -----	3.23
Using the Phonebook on Your Computer (SF-531P only) -	3.25
Searching for a Number in the Memory -----	3.27

Advanced Fax

Broadcasting -----	3.28
Delayed Fax -----	3.29
Priority Fax -----	3.31
Polling -----	3.32
Adding Documents To a Scheduled Operation -----	3.34
Cancelling a Scheduled Operation -----	3.34

Contents (continued)

Chapter

3

Stand-alone Fax (continued)

Additional Functions

Sending a Recall (Flash or R)	3.35
Monitoring a Dual Job Status	3.35
Forwarding Received Faxes	3.36
Toll Save Fax	3.37
Printing Reports	3.38
Group Dialling (for Multi-Address Transmission)	3.40

Chapter

4

Printing (SF-531P only)

Print Media

Selecting Print Media	4.1
Using the Automatic Paper Input Tray	4.3
Using the Manual Paper Input Tray	4.5
Specialty Paper Guidelines	4.8

Printing

Printing a Document	4.9
Cancelling a Print Job	4.12
Printing Help	4.13
Printing Several Pages Per Sheet	4.14
Scaling Your Document	4.15
Fitting Your Document to a Selected Paper Size	4.16
Printing Posters	4.17
Printing Watermarks	4.18
Using Page Overlays	4.20
Printing in a Network Environment	4.24

Chapter 5 Maintenance

Guidelines for Maintenance	5.1
Clearing Memory	5.1
Cleaning the OPC Drum	5.2
Adjusting Shading	5.2
Setting the Machine to be Checked by Phone	5.3
Sending Toner Low Information to the Service Company	5.3
Cleaning the Machine	5.4
Managing the Toner Cartridge	5.7
Automatic Document Feeder Rubber Pad Replacement	5.10

Chapter 6 Troubleshooting

Clearing Paper Jams	6.1
LCD Error Messages	6.5
Fax Problems	6.7
General Printing Problems (SF-531P only)	6.9
Print Quality Problems	6.11

Appendix

Connecting Other Devices to the Phone line	A.1
Specifications	A.4
Safety Information	A.6
Index	A.11



Refer to the SmarThru User's Guide for information on:

- Scanning a document
- Copying a document
- Working with a scanned image
- Recognizing a scanned image as text
- How to use additional features using the Samsung SmarThru 2 program

Environmental and Safety Consideration

Laser Safety Statement

The printer is certified in the U.S. to conform to the requirements of DHHS 21 CFR, chapter 1 Subchapter J for Class I(1) laser products, and elsewhere is certified as a Class I laser product conforming to the requirements of IEC 825.

Class I laser products are not considered to be hazardous. The laser system and printer are designed so there is never any human access to laser radiation above a Class I level during normal operation, user maintenance, or prescribed service condition.

WARNING

Never operate or service the printer with the protective cover removed from Laser/Scanner assembly. The reflected beam, although invisible, can damage your eyes.



CAUTION - INVISIBLE LASER RADIATION WHEN THIS COVER OPEN. DO NOT OPEN THIS COVER.

VORSICHT - UNSICHTBARE LASERSTRAHLUNG, WENN ABDECKUNG GEÖFFNET. NICHT DEM STRAHL AUSSETZEN.

ATTENTION - RAYONNEMENT LASER INVISIBLE EN CAS D'OUVERTURE. EXPOSITION DAN GEREUSE AU FAISCEAU.

ATTENZIONE - RADIACIONE LASER INVISIBILE IN CASO DI APERTURA. EVITARE L'ESPOSIZIONE AL FASCIO.

PRECAUCION - RADIACION LASER IVISIBLE CUANDO SE ABRE. EVITAR EXPONERSE AL RAYO.

ADVARSEL - USYNLIG LASERSTRÅLNING VED ÅBNING NÅR SIKKERHEDSBRYDERE ER UDE AF FUNKTION. UNDGÅ UDSAETTEELSE FOR STRÅLNING.

ADVARSER - USYNLIG LASERSTRÅLNING NÅR DEKSEL ÅPNES. STIRR IKKE INN I STRÅLEN. UNNGÅ EKSPONERING FOR STRÅLEN.

VARNING - OSYNLIG LASERSTRÅLNING NÅR DENNA DEL ÄR ÖPPAND OCH SPÄRREN ÄR URKOPPLAD. BETRAKTA EJ STRÅLEN. STRÅLEN ÄR FARLIG.

VARO! - AVATTAESSA JA SUOJALUKITUS OHITETTAESSA OLET ALTTIINA NÄKYMÄTTÖMÄLLE LASERSÄTEILYLLE ÄLÄ KATSO SÄTEESEEN.



Ozone Safety

During normal operation, the Samsung SF-530 Series produces ozone. The ozone produced does not present a hazard to the operator. However, it is advisable that the machine be operated in a well ventilated area.

If you need additional information about ozone, please request your nearest Samsung dealer.

Power Saver



This printer contains advanced energy conservation technology that reduces power consumption when it is not in active use.

When the printer does not receive data for an extended period of time, power consumption is automatically lowered.

The energy star emblem does not represent EPA endorsement of any product or service.

Radio Frequency Emissions

FCC Regulations

This equipment has been tested and found to comply with the limits for a Class B digital device, pursuant to Part 15 of the FCC Rules. These limits are designed to provide reasonable protection against harmful interference in a residential installation. This equipment generates, uses and can radiate radio frequency energy and, if not installed and used in accordance with the instructions, may cause harmful interference to radio communications. However, there is no guarantee that interference will not occur in a particular installation.

If this equipment does cause harmful interference to radio or television reception, which can be determined by turning the equipment off and on, the user is encouraged to try to correct the interference by one or more of the following measures:

- Reorient or relocate the receiving antenna.
- Increase the separation between the equipment and receiver.
- Connect the equipment into an outlet on a circuit different from that to which the receiver is connected.
- Consult the dealer or an experienced radio/TV technician for help.

Do not make any changes or modifications to the equipment unless otherwise specified in the manual. If such changes or modifications should be made, you must first stop operation of the equipment.

Use of shielded cable is required to comply with Class B limits in Subpart B of Part 15 of FCC Rules.

CAUTION: Changes or modifications not expressly approved by the manufacturer responsible for compliance could void the user's authority to operate the equipment.

Canadian Radio Interference Regulations

This digital apparatus does not exceed the Class B limits for radio noise emissions from digital apparatus as set out in the interference-causing equipment standard entitled "Digital Apparatus", ICES-003 of the Industry and Science Canada.

Cet appareil numérique respecte les limites de bruits radioélectriques applicables aux appareils numériques de Classe B prescrites dans la norme sur le matériel brouilleur: "Appareils Numériques", ICES-003 édictée par l'Industrie et Sciences Canada.



Declaration of Conformity (European Countries) Approvals and Certifications

The CE marking applied to this product symbolises Samsung Electronics Co., Ltd. Declaration of Conformity with the following applicable 93/68/EEC Directives of the European Union as of the dates indicated:

January 1, 1995: Council Directive 73/23/EEC Approximation of the laws of the member states related to low voltage equipment.

January 1, 1996: Council Directive 89/336/EEC (92/31/EEC), approximation of the laws of the Member States related to electromagnetic compatibility.

March 9, 1999: Council Directive 1999/5/EC on radio equipment and telecommunications terminal equipment and the mutual recognition of their conformity.

A full declaration, defining the relevant Directives and referenced standards can be obtained from your Samsung Electronics Co., Ltd. representative.

EC Certification

Certification to 1999/5/EC Radio Equipment & Telecommunications Terminal Equipment Directive (FAX)

This Samsung product has been self-certified by Samsung for pan-European single terminal connection to the analogue public switched telephone network (PSTN) in accordance with Directive 1999/5/EC. The product has been designed to work with the national PSTNs and compatible PBXs of the European countries:

In the event of problems, you should contact the Euro QA Lab of Samsung Electronics Co., Ltd. in the first instance.

The product has been tested against TBR21 and/or TBR 38. To assist in the use and application of terminal equipment which complies with this standard, the European Telecommunication Standards Institute (ETSI) has issued an advisory document (EG 201 121) which contains notes and additional requirements to ensure network compatibility of TBR21 terminals. The product has been designed against, and is fully compliant with, all of the relevant advisory notes contained in this document.



ELECTRONICS

EU Declaration of Conformity (R&TTE)

We, Samsung Electronics Co., Ltd.

1. Samsung Electronics Co.,Ltd.
#259, Gongdan-dong, Gumi-City, Gyung-Buk, KOREA. 730-030
.....
(factory name, address)

2. Shandong Samsung Telecommunications Co., Ltd.
Jinzhou Road, Weihai Hi-Tech, IDZ Shandong Province, China. 264209
.....
(factory name, address)

declare under our sole responsibility that the product

Laser Facsimile & Printer model

" SF-530 / SF-531P / SF-535e "

to which this declaration relates is in conformity with

R&TTE Directive : 1999/5/EC (Annex II)
Low Voltage Directive : 73/23/EEC
EMC Directive : 89/336/EEC. 92/31/EEC

By application of the following standards

R&TTE : TBR 21, TBR 38

.....
LVD : EN 60950:1992 +A1+A2+A3+A4+A11

.....
EMC : EN 55022:1998/55024:1998/61000-3-2:1995/61000-3-3:1995

(Manufacturer)

Samsung Electronics co.,Ltd
#259,Gongdan-Dong,Gumi-City
Gyung-Buk, Korea 730-030

2001-06-14

.....
(place and date of issue)

Yong-Hwan Kim / Senior Manager
(name and signature of authorized person)

(Representative in the EU)

Samsung Electronics Euro QA Lab.
Blackbushe Business Park
Saxony Way, Yateley, Hampshire
GU46 6GG, UK

2001-06-18

.....
(place and date of issue)

In-Seop Lee / Manager
(name and signature of authorized person)

chapter

1

Getting Started

Congratulations on the purchase of your SF-530 series product! This chapter provides information on the following topics:

Introduction

- ◆ Welcome!
- ◆ Contents
- ◆ Identifying Parts

Setting Up Your Machine

- ◆ Choosing a Location
- ◆ Preparing Your Machine for Use
- ◆ Attaching the Supports
- ◆ Connecting to the Phone Line
- ◆ Connecting to the Computer (SF-531P only)
- ◆ Plugging In the Power
- ◆ Loading Paper
- ◆ Installing Toner Cartridge
- ◆ Setting the Date and Time
- ◆ Setting Your Fax Number and Name
- ◆ Testing the Machine
- ◆ Using Save Modes

Introduction

Welcome!

Thank you for purchasing the Samsung SF-530 series, a powerful business tool with the capabilities of a full range of office equipment. With the Samsung SF-530 series, you can:



Fax

Use the Samsung SF-530 series as a **full-featured stand-alone fax machine** to send and receive faxes. Perform advanced tasks such as delayed transmission, broadcasting, and unattended memory sending.

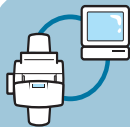

Print (SF-531P only)

You can get 600 x 600 dpi high-quality laserjet printing from the Samsung SF-531P machine. You can create professional documents using the creative printing features on the various kinds of print media, such as plain papers, envelopes, transparencies, label, and so on.



Copy

Make up to **99 copies** of a 20-pages document without having to connect to a PC. You can adjust the contrast, enlarge or reduce the copies, collate, and more. For Samsung SF-531P, if you use the Samsung SmarThru software on the PC, you can copy a scanned image using various copy options, such as multiple pages on a sheet, poster printing, and a cloning feature.

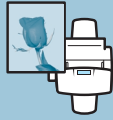

Scan (SF-531P only)

Scan important documents to create electronic files. Use the scanner to add photo or graphic images to other software applications or to jazz up your projects. AnyPage OCR (Optical Character Recognition) software lets you scan text directly into your word processing program.



Use Samsung SmarThru software (SF-531P only)

Samsung SmarThru program consists of several components that provide particular functionality as follows:

- **Scan Manager** — Working with documents or images, you can scan to Image Manager, scan to OCR software, scan to e-mail.
- **Image Manager** — Working with images, you can import, export, store and change images.
- **Copy Manager** — Working with documents or images, you can control the copying process. It can also save a copy of the image or document to Image Manager.
- **MailBox** — Working with e-mail and e-fax messages, you can create, send, browse and store messages. (Note e-mail service is available only if you have subscribed to an Internet service provider and properly configured the Internet gate when you install the Samsung software)
- **Image Viewer** — Working with documents or images, you can view the image in a variety of graphical formats.

Contents

Here's what comes with the SF-530 series.

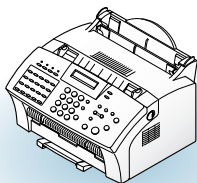

SF-530 series machine

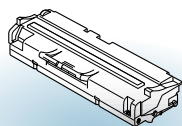

Toner cartridge

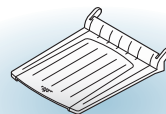

Document output support

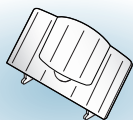

Document input support

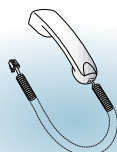

Handset

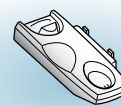

Handset cradle

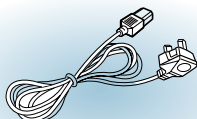

Power cord *



Telephone line cord *

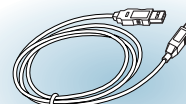

USB cable
(for SF-531P only)

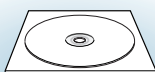

software CD-ROM
(for SF-531P only)

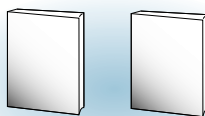

SF-530 series
User's Guide

SmarThru
User's Guide
(for SF-531P only)

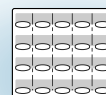

One-touch label
for the front panel

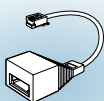

TAM Lead
(for UK only)

*: These may look different depending on the country.

Notes:

- You should use the Telephone line cord which is supplied with the machine. If you are replacing it with the other vendor's part, it should be AWG #26 or lower gage.
- Power cord must be plugged in grounded power socket.

Identifying Parts

Before setting up your machine, make sure you identify the following parts related to the scanner and paper print paths.

Identifying Scanner Path Parts

Items to be faxed, copied, or scanned use the scanner path which consists of the following parts:

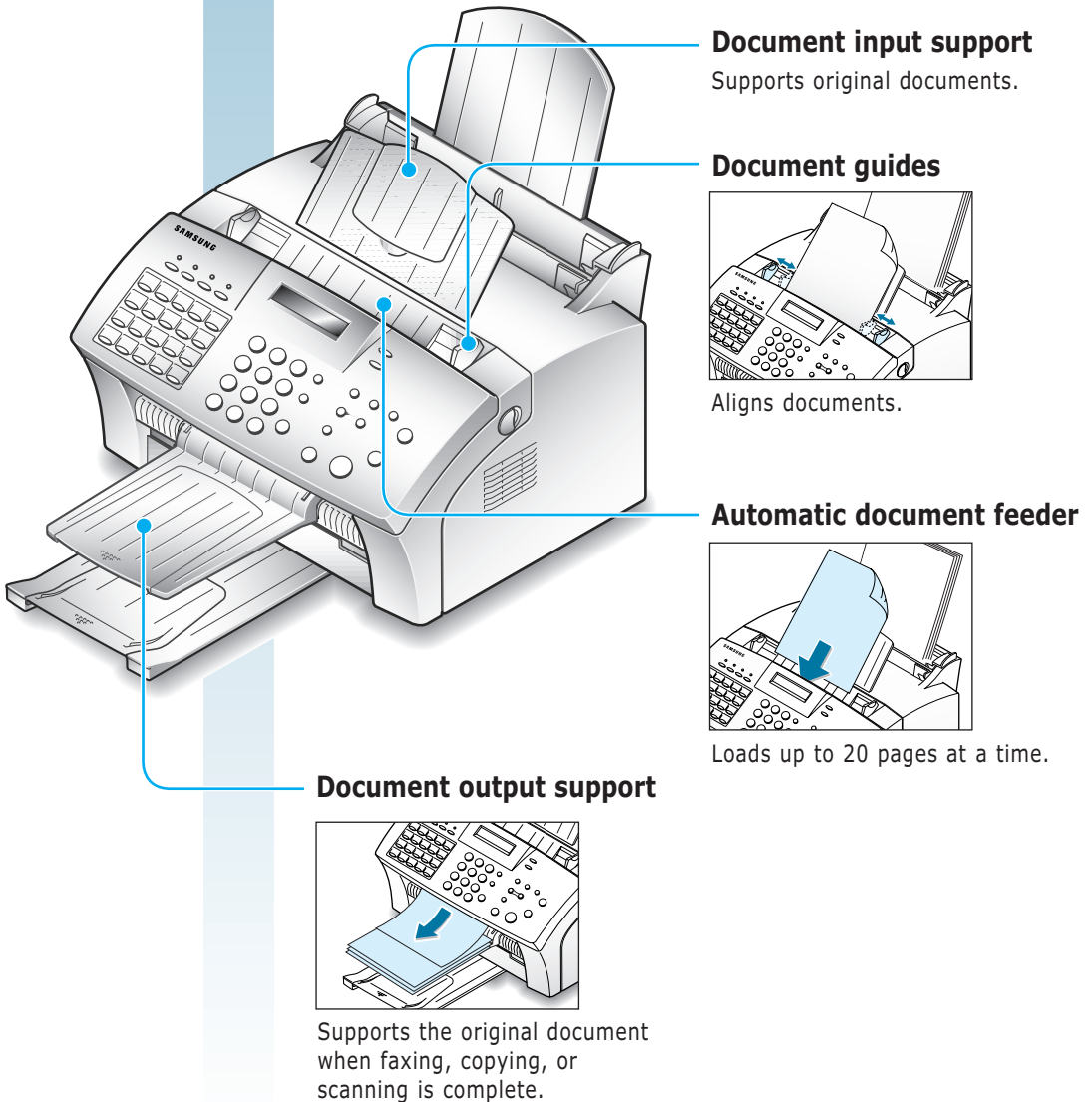

Identifying Printer Path Parts

Paper for printing, receiving faxes and copying follow the printer path. This path consists of the following parts:

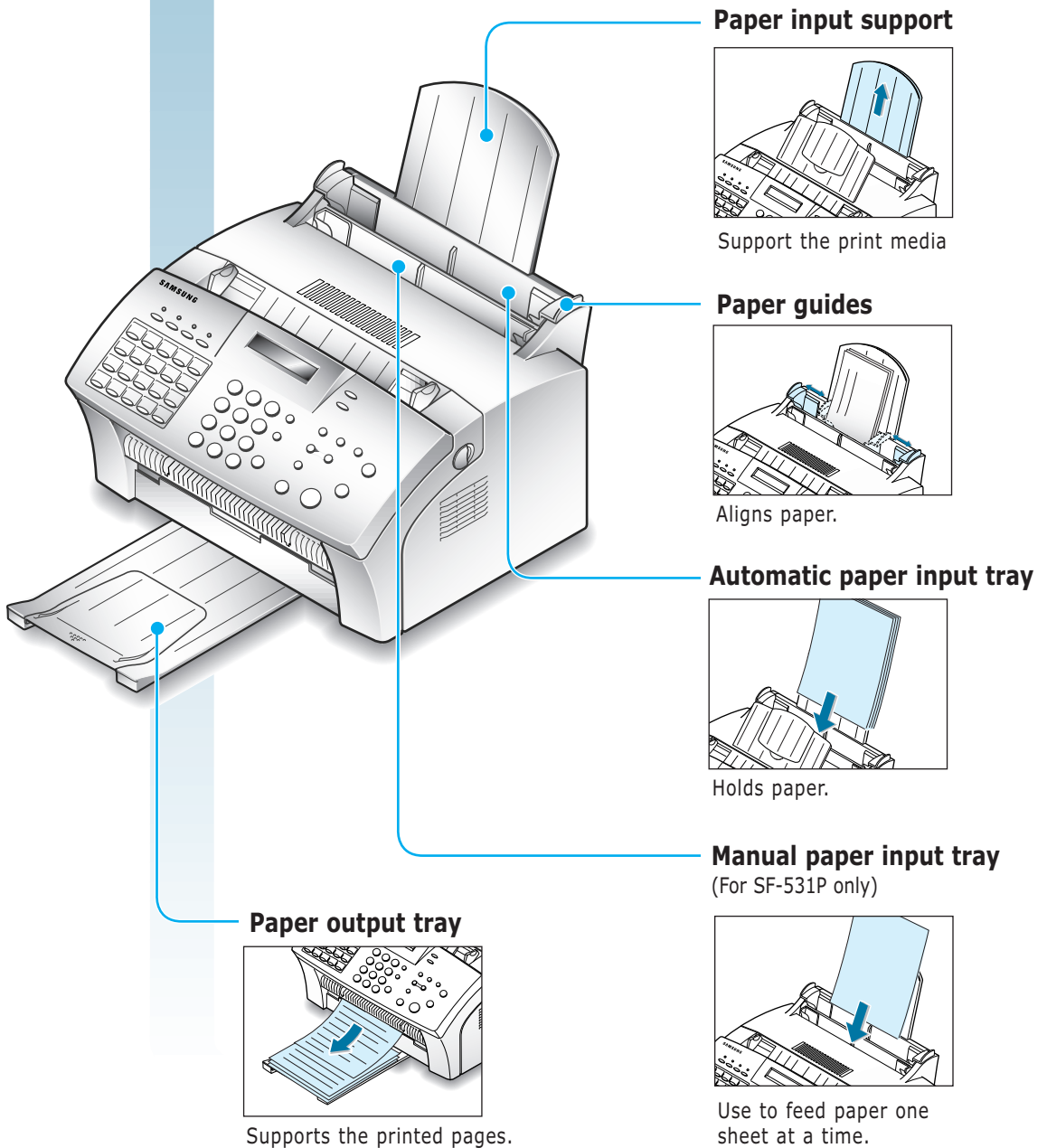

Identifying Front Panel Features

Look for the following keys and features on the front panel. These features are used to fax documents, make copies, and adjust settings.

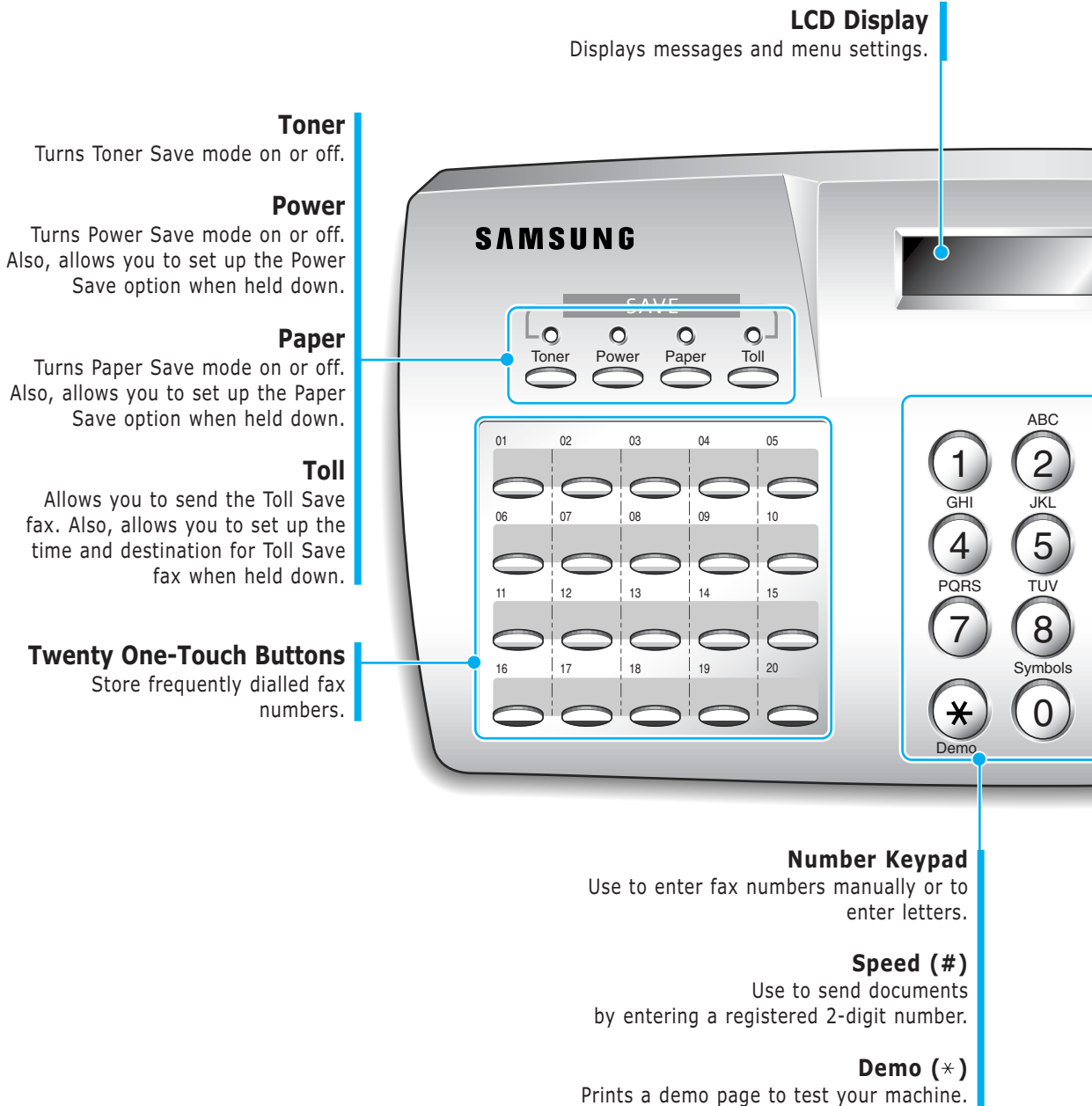

LCD Display

Displays messages and menu settings.

Toner

Turns Toner Save mode on or off.

Power

Turns Power Save mode on or off. Also, allows you to set up the Power Save option when held down.

Paper

Turns Paper Save mode on or off. Also, allows you to set up the Paper Save option when held down.

Toll

Allows you to send the Toll Save fax. Also, allows you to set up the time and destination for Toll Save fax when held down.

Twenty One-Touch Buttons

Store frequently dialed fax numbers.

Number Keypad

Use to enter fax numbers manually or to enter letters.

Speed (#)

Use to send documents by entering a registered 2-digit number.

Demo (*)

Prints a demo page to test your machine.

Rcv. Mode/Contrast

When a document is loaded, choose the contrast characteristic of copied or transmitted documents.

When a document is not loaded, choose the receive mode to use. The selected mode is displayed in Standby mode.

Resolution

Choose the resolution of documents.

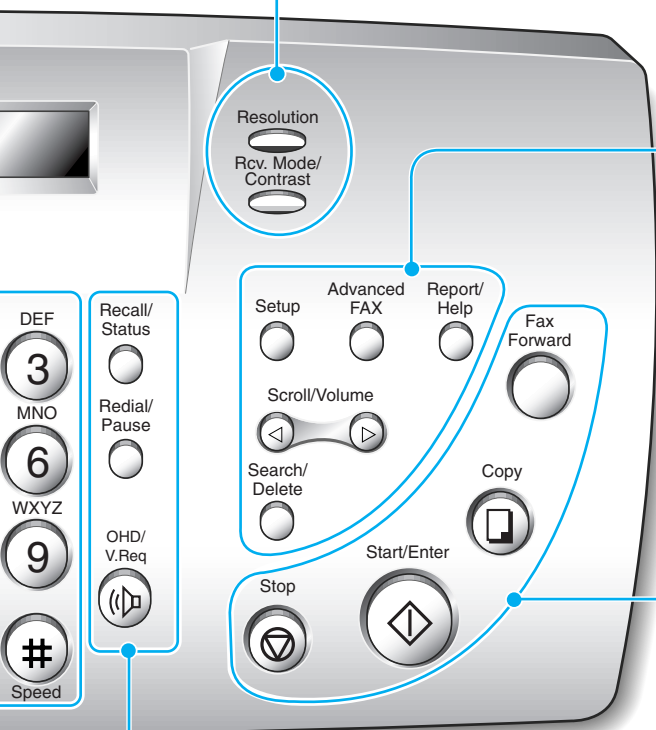

Recall(R or Flash)/Status

Performs a switch-hook operation. Also use to switch the display status while performing dual jobs.

Redial/Pause

Use to redial the last fax number or to insert a pause into a fax number.

OHD/V.Reg

Use to dial numbers without picking up the handset. Also use to make a voice call after sending or receiving a fax.

Setup

Use to set up various system options.

Advanced FAX

Use to access advanced fax operations.

Report/Help

Use to print various reports and the help list.

Scroll/Volume

Use to scroll the menu items or use to move the cursor left or right through the display. Also, use to adjust the ringer volume.

Search/Delete

Use to search for a number in memory or to delete the last digit when typing text.

Fax Forward

Allows you to forward the received faxes to the defined remote fax machine at a specified duration.

Copy

Makes a copy of a document.

Start/Enter

Starts a job. Also use to activate the selection shown on the display.

Stop

Stops an operation at any time.

Identifying Connecting Parts and Others

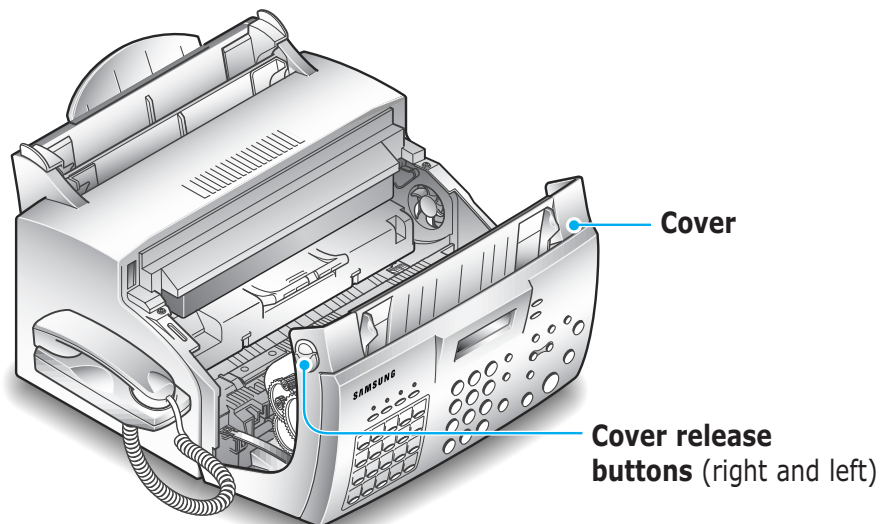
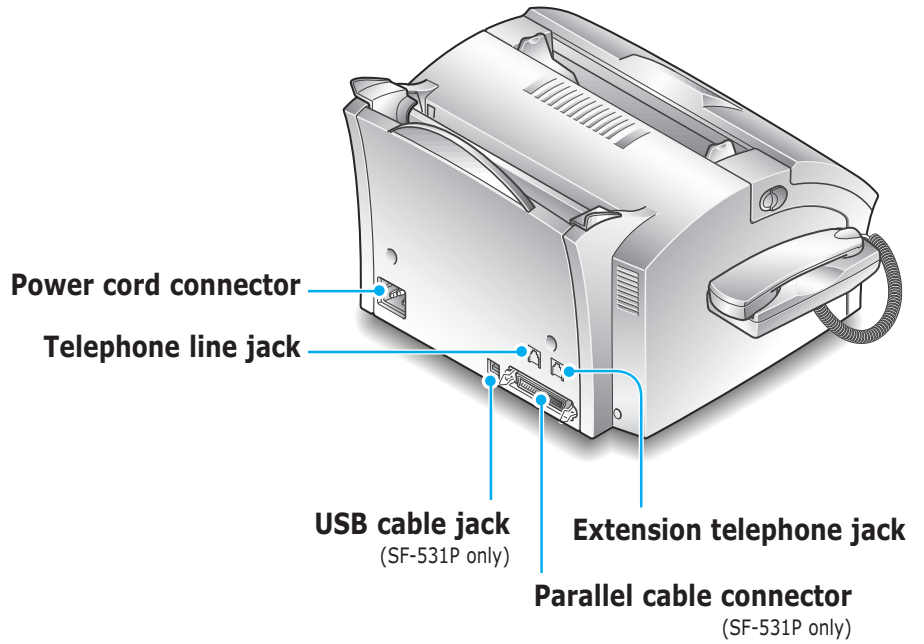

Setting Up Your Machine

Choosing a Location

For the trouble-free operation of your machine, place it on a flat, stable surface near your workstation. Leave enough space to allow for easy paper loading and exiting, as well as opening the front cover.

Do not place your machine:

- In direct sunlight.
- Near heat sources or air conditioners.
- In a dusty or dirty environment.

Preparing Your Machine for Use

When you take the SF-530 series out the box, note that it has been packaged to protect it during shipping. Before you use the machine, make certain that you check for the following items:

- Remove all tapes.
- Remove all packing materials.



Attaching the Supports

Document Input Support

Insert the document input support with the groove pointing to the rear top of the machine.

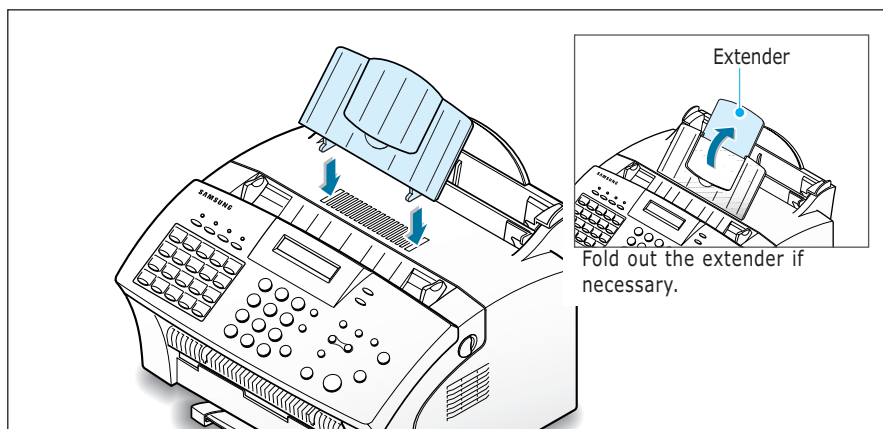

Document Output Support

Insert the two tabs on the document output support into the slots on the front of your machine.

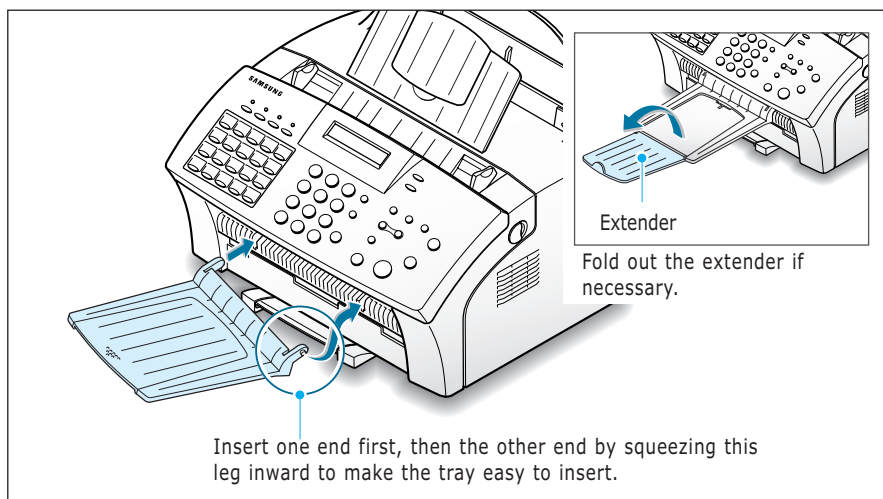

Note: The SF-530 series is shipped with the paper output tray already installed. Extend the tray to use.

Fold out the extender if necessary.

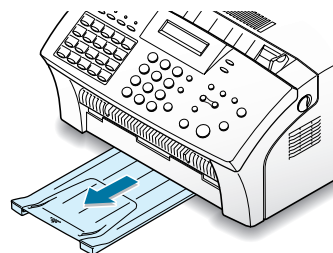

Handset and Handset Cradle

1. Plug the end of the coiled cord of the handset into the jack on the left side of your machine.

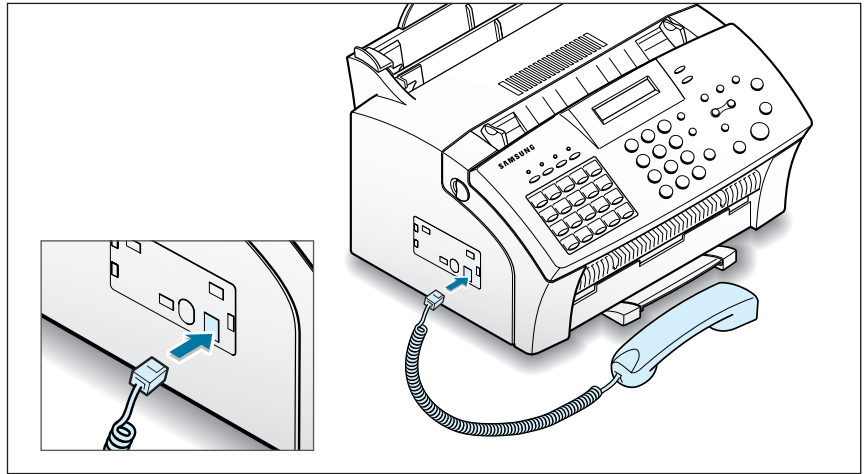

2. Hold the cradle using your hand as shown.

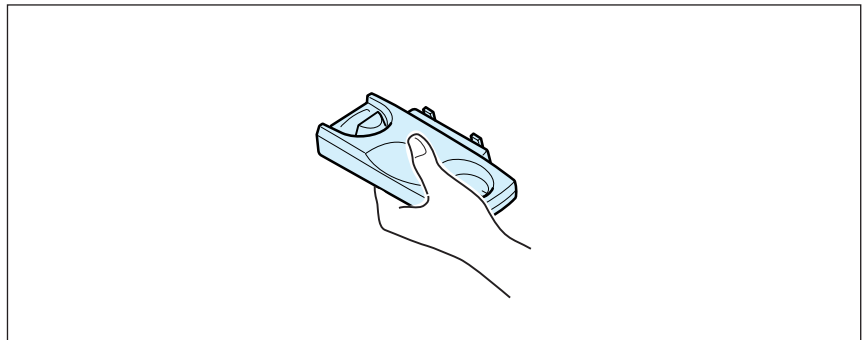

3. Attach the handset cradle to the main body.

Insert the two tabs of the cradle into the slots on the left side of the machine as shown, and while pressing part **A** on the bottom of the cradle, push the cradle toward the machine until it clicks into place.

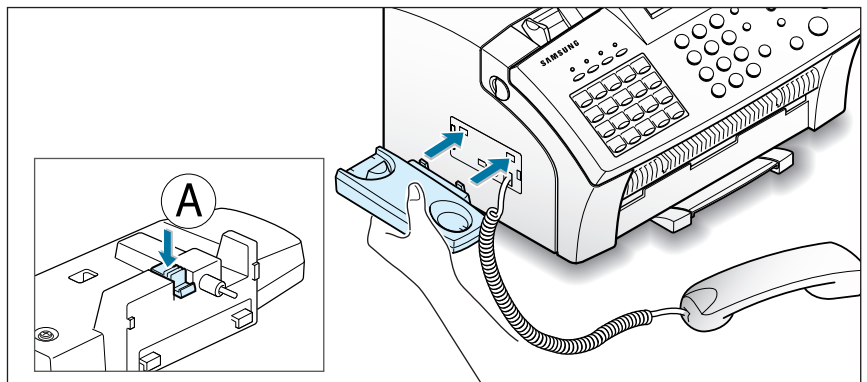

Notes:

- If you want to remove the cradle, while pushing up the part (A), on the bottom of the cradle, slide the cradle down, then take it out.

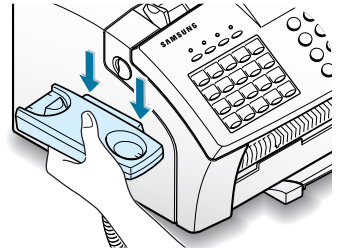

Connecting to the Phone Line

For proper operation, the SF-530 series must be connected to the wall jack. Once you have decided which wall jack you will be using, check a box below and follow the instructions.

- I only have one phone line coming to this wall jack.** (This includes two phone numbers on one line with distinctive ring service.) Go to "To Connect to a Wall Jack that Has Only One Phone Line" on next page.
- I have two phone lines coming to this wall jack.** Go to "To Connect to a Wall Jack that Has Two Phone Lines" on page A.2.

To Connect to a Wall Jack that has Only One Phone Line

1. Plug the included telephone cord into the jack on the back of the unit marked the word **LINE**.

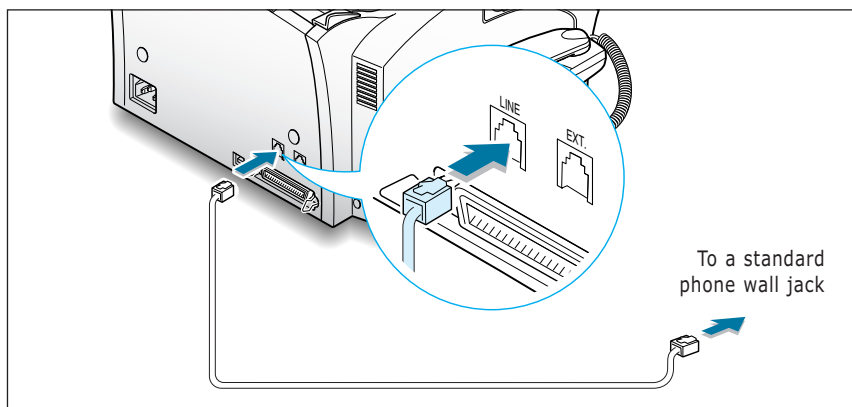

2. If a telephone cord is plugged into the wall jack, unplug the cord and set it aside.
3. Plug the other end of the phone cord into the wall jack.

Notes:

- If you are connecting other devices such as a telephone to the phone line, go to Appendix "Connecting Other Devices To the Phone Line" on page A.1.
- If you are not connecting other devices, go to "Plugging In the Power" on page 1.15.

To Connect to a Wall Jack that Has Two Phone Lines

1. Plug the included telephone cord into the jack on the back of the unit marked the word **LINE**.
2. If a telephone cord is plugged into the wall jack, unplug it and set it aside.
3. If you do not have a wall jack that has a built-in splitter, plug a phone unit splitter (not included) into the wall jack.
4. Plug the cord into the side of the phone unit splitter for the fax number.

Notes:

- If you are connecting other devices such as a telephone to the same phone line, go to Appendix "Connecting Other Devices To the Phone Line" on page A.1.
- If you are not connecting other devices, go to "Plugging In the Power" on page 1.15.

Connecting to the Computer (SF-531P only)

Your machine has a parallel and a USB interface port which allow use with a Windows PC.

Connecting to the Computer Using the Parallel interface

1. Plug the supplied parallel printer cable into the connector on the back of your machine. Push the metal clips down to fit inside the notches on the cable plug.

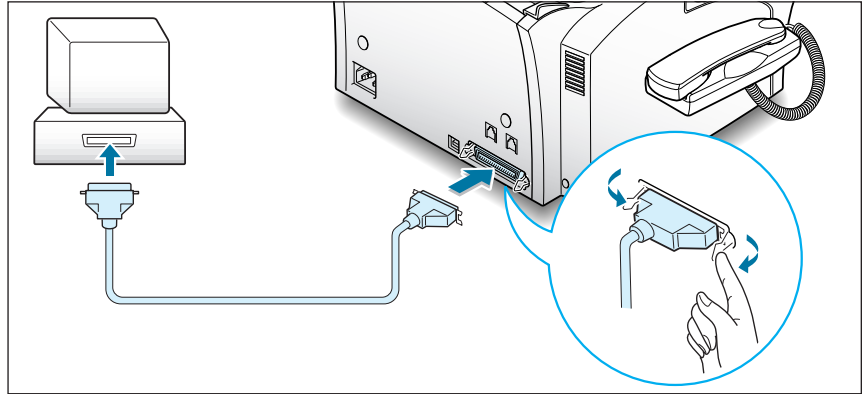

2. Connect the other end of the cable to the parallel interface port on your computer. See your computer documentation for more information.

Connecting to the Computer Using the USB interface

If you have a USB (Universal Serial Bus) port enabled on your computer, and if your computer is running Windows 98, you can connect your SF-531P to the USB chain of devices.

To use your machine using the USB cable, see page 2.13.

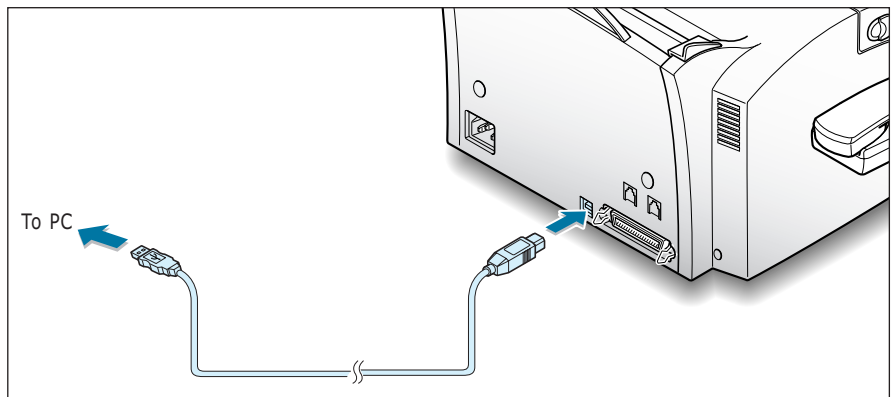

Plugging In the Power

Plug one end of the cord into the back of the machine and the other end into a standard AC power outlet.

The SF-530 series will turn on and the display will show 'SYSTEM INITIAL'. If there is no paper loaded, the displays will show 'NO PAPER.' then if there is no cartridge installed, the display will show 'JAM/NO CARTRIDGE'.

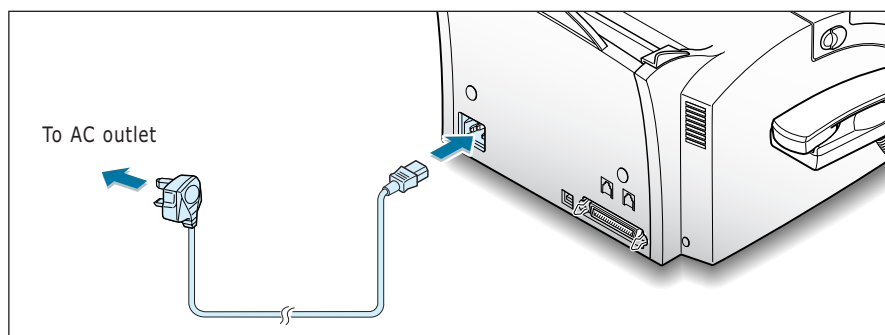

To turn off, unplug the power cord.

Loading Paper

For best results, use high quality xerographic paper. The automatic paper input tray can hold a maximum of 150 sheets of plain paper. The maximum capacity may be less, depending on the paper thickness.

Note: For stand-alone copy and fax operations, the SF-530 series product supports A4, letter, and legal paper. After loading paper, make sure that you select the correct paper size. For more information on setting the paper size, see 'Setting User-Selectable System Options' on page 3.2.

1. Pull the paper input support completely out of the unit.

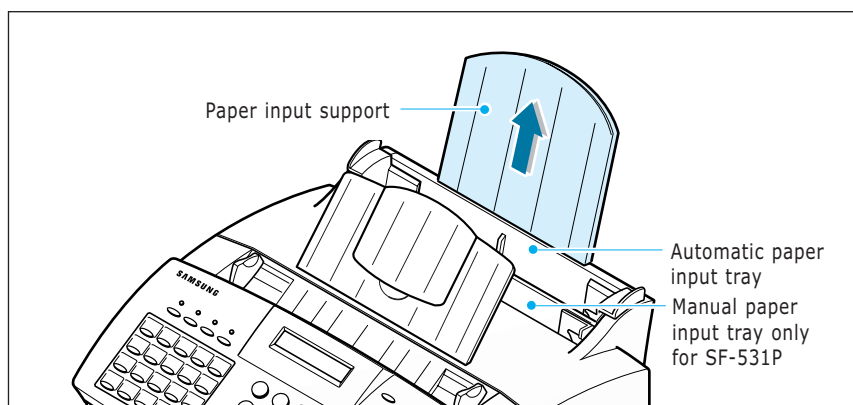

2. Remove a stack of paper from its packaging. Tap the stack on a flat surface to even it up.

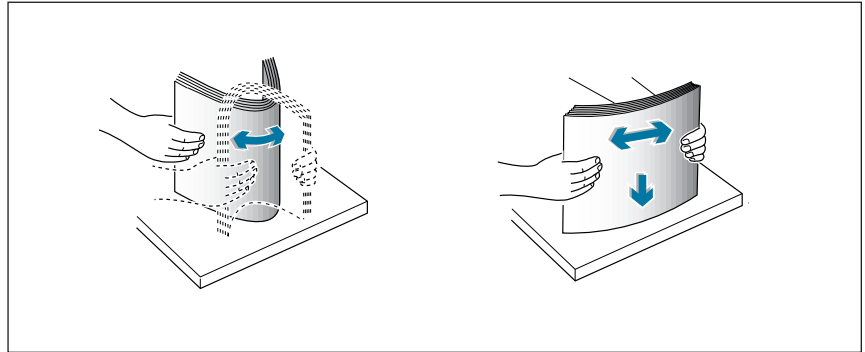

3. Insert the paper with the print side facing you.

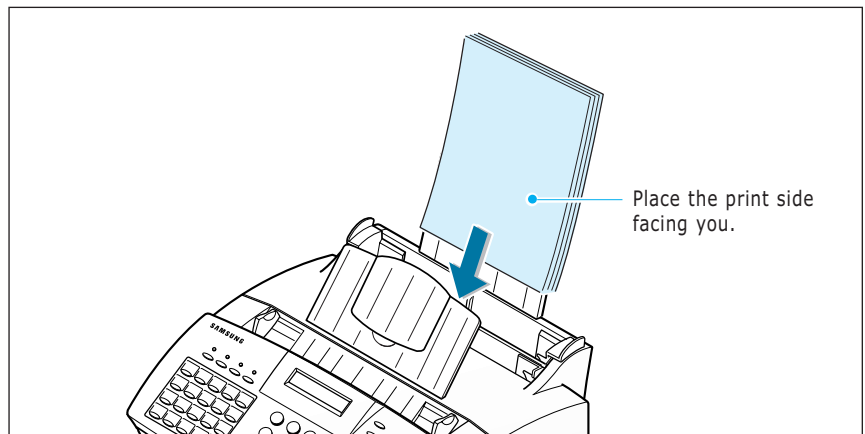

4. Adjust the paper guides to the width of the print media. Slide the guides until they lightly touch the stack of print media. Do not bend the print material.

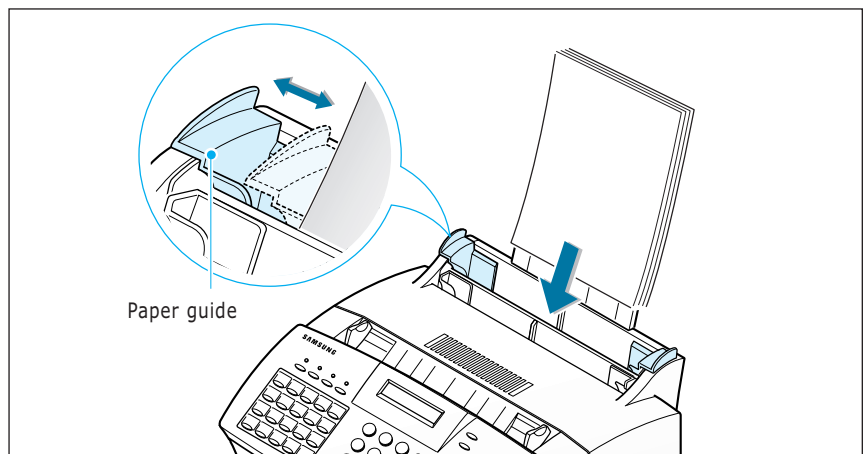

Paper Type and Size

Satisfactory print and receive quality can be obtained with many types of plain paper. Since the quality of plain paper varies widely, test the print quality before buying large quantities of paper. Your machine uses a variety of papers including:

- Xerographic paper
- Bond paper
- Dual-purpose paper

Because all papers vary in physical characteristics, you can receive mixed results from different packages of paper even through the packages contain the same paper. If you encounter undesirable results, try the other side of the paper, a different type, or another package of the same kind of paper.

DO NOT use the following types of paper with your machine:

- Continuous form feed paper
- Synthetic paper
- Thermal paper
- Multi-sheet forms and documents
- Chemically treated paper
- Papers with raised, embossed lettering

To load paper with a preferred print side:

- If you are using xerographic paper, load the paper with the preferred print side facing down.
- If you are using letterhead or bond paper, load the paper with the preferred side facing up.

The following papers can be used in your machine for fax:

- Letter : 216 x 279 mm (8.5 x 11.0 in.) - 60 g/m² ~ 90 g/m² (16 ~ 24 lb)
- A4 : 210 x 297 mm (8.3 x 11.7 in.) - 60 g/m² ~ 90 g/m² (16 ~ 24 lb)
- Legal : 216 x 356 mm (8.5 x 14.0 in.) - 60 g/m² ~ 90 g/m² (16 ~ 24 lb)

Installing the Toner Cartridge

1. Pulling the cover release buttons found on both sides of the machine toward you, open the cover.

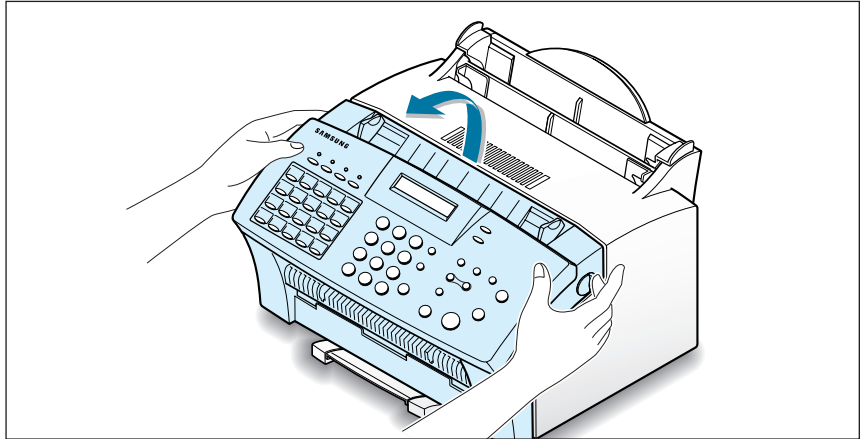

2. Unpack the cartridge from its plastic bag, and then remove the paper rolled the cartridge.

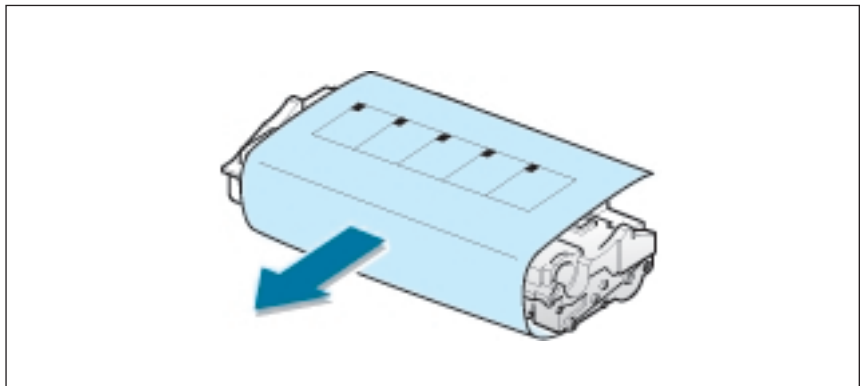

3. Shake the cartridge from side to side 5 or 6 times to redistribute the toner evenly inside the cartridge.

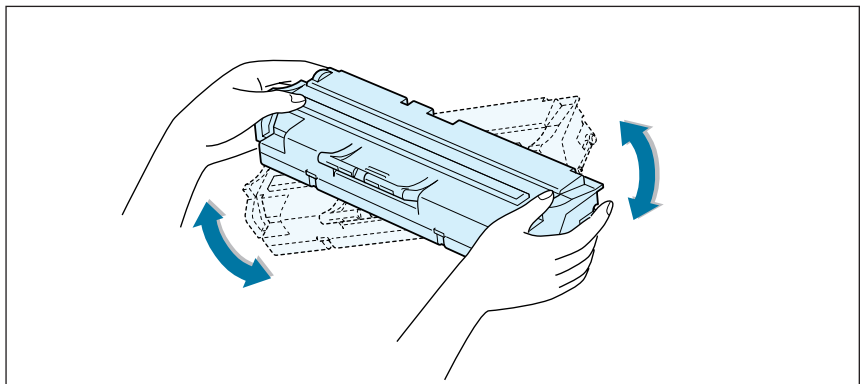

4. Find the cartridge slots inside the machine, one on each side.

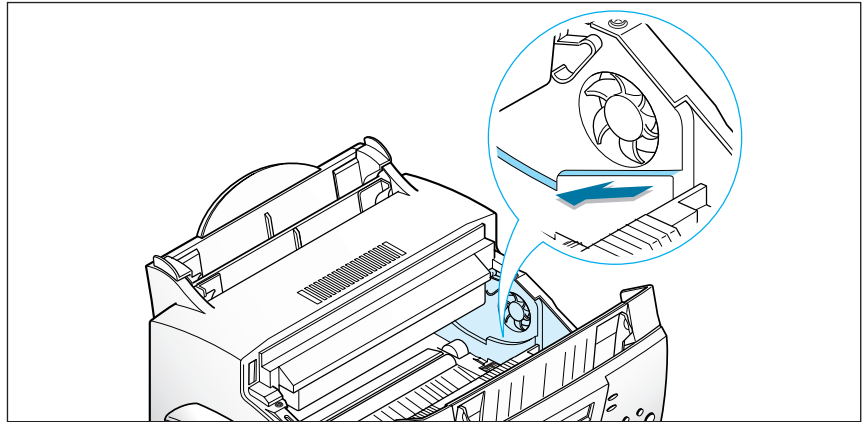

5. Grasp the handle at the front of the cartridge and slide it down between the cartridge slots, and push it firmly.

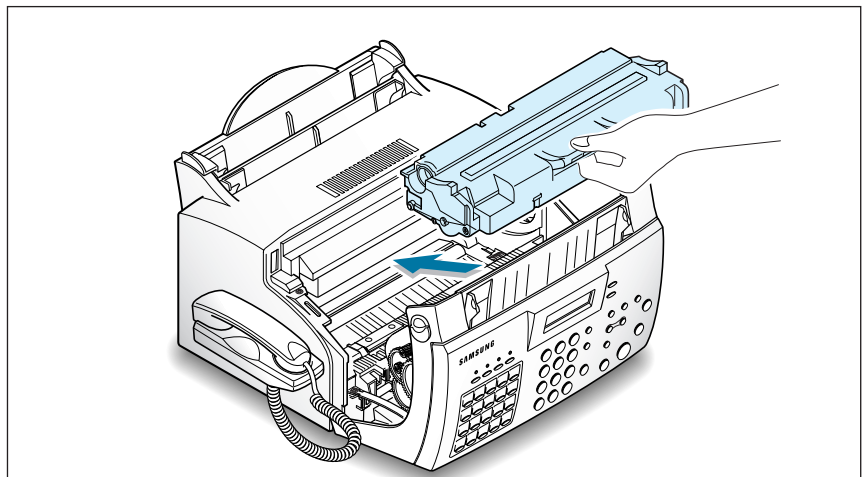

6. Close the cover. Make sure that the cover is securely closed.

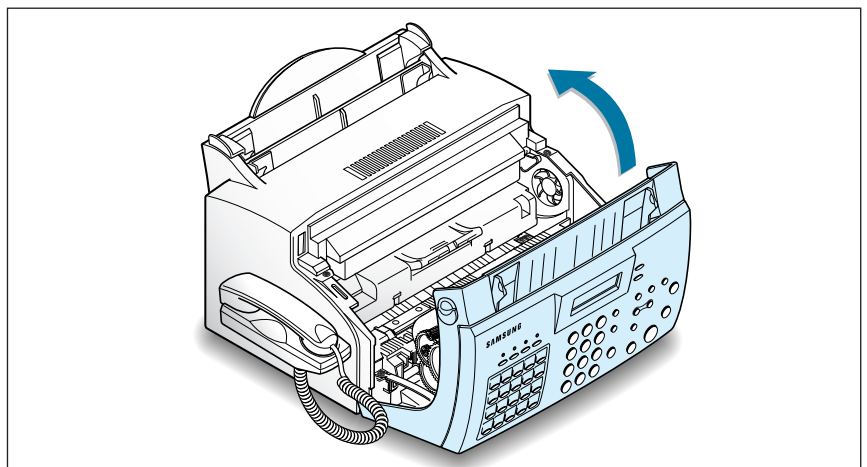

Setting the Date and Time

The current date and time are shown on the display when the machine is on and ready for use (Standby mode). The date and time are printed on all transmitted faxes.

When you install the SF-530 series for the first time, or when the product is without power for about 15 seconds, the display prompts you to reset the date and time.

SET DATE & TIME

1. Press **Setup** on the front panel. the display shows the first setup menu; FAX NUMBER/NAME.
2. Press ◀ or ▶ until 'TIME/DATE SETUP' appears, then press **Start/Enter** to access the Time/Date Setup menu.
3. The display asks you to choose a date format. Press **Start/Enter**.
4. Press ◀ or ▶ until you find the desired date format, then press **Start/Enter**.

If you select USA, the date appears in format of Month-Day-Year. The EUROPE format will be displayed in format of Day-Month-Year.

The display shows the currently set date and time using the selected date format and asks you to set the month.

04-01-2001 10:30 (EUROPE Format)

5. Enter the correct date and time for each item using the number keypad. Each time you enter the appropriate number, the display asks you to enter the next item in the following order: MONTH, DATE, YEAR, HOUR, and MINUTE.

Enter the time in 24-hour format. For example, enter 2230 for 10:30 P.M.

If you enter an invalid number, the display does not proceed to the next step. If this happens, re-enter the correct number.

6. When you are finished, press **Start/Enter** to save the setting. The display returns to Standby mode and shows the date and time you have set.

19-MAR 12:30 FAX (EUROPE Format)

Setting Your Fax Number and Name

Your fax number and name can be printed at the top of each page transmitted.

1. Press **Setup** on the front panel. The display shows the first setup menu; FAX NUMBER/NAME.
2. Press **Start/Enter** to access the Fax Number/Name menu. The display shows 'FAX NUMBER.'
3. Press **Start/Enter**.
If there is a number already set, the number appears.



TEL: _

4. Enter the telephone number your machine is connected to. You can enter up to 20 digits.

Press * for plus sign (+) and # for a hyphen. If you entered a wrong number, press **Search/Delete** to delete it.
5. Press **Start/Enter** when the number on the display is correct.
If there is a name already set, the name appears.



NAME: _

6. Enter your name using number keypad. You can enter up to 40 characters.

For details on how to use the number keypad to enter alphanumeric characters, see page 3.19.
7. Press **Start/Enter** when the name on the display is correct.

Testing the Machine

After installation, you may want to run a simple test on your machine by printing out a demo page.

Press and hold down **Demo (*)** button on the front panel for 2 seconds, and the machine begins printing a demo page.

Using Save Modes

There is four saving mode buttons on the front panel of the SF-530 series. Using these buttons, you can save toner and power consumption, paper for printing, and toll for the fax call.

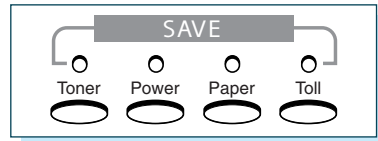

Toner Save Mode

Toner Save mode allows the machine to use less toner on each page.

Press **Toner** on the front panel to turn this mode on or off.

- If the LED is on, Toner Save mode activates and the machine uses less toner by 50% to print a page. Using this mode will extend the life of your toner cartridge and reduce your cost per page, but will reduce print quality.
- If the LED is off, Toner Save mode deactivates and the machine prints in the normal mode.

Power Save Mode

Power Save mode allows you to save the power consumption.

Press **Power** on the front panel to turn this mode on or off.

- If the LED is on, Power Save mode activates and the machine will go to a reduced power state. But it takes long to receive incoming faxes for warming up the machine.
- If the LED is off, Power Save mode deactivates and the machine keeps ready to operate with the minimum warm-up time. This uses more energy to keep your machine warm and ready to print.

To specify how long the machine waits before going to the Power Save mode, press and hold down **Power**, and select the desired time length among **5MIN**, **10MIN** and **15MIN** using ◀ or ▶. Selecting **OFF** turns the Power Save mode off.

Note: Although you turned Power Save mode off by pressing **Power**, it activates if you have set the time length.

Paper Save Mode

With Paper Save mode on, you can save paper by reducing the data and printing two pages on one sheet of paper when copying or printing received document.

Press **Paper** on the front panel to turn this mode on or off.

- If the LED is on, Paper Save mode activates and the machine prints two pages on one sheet of paper when receiving a fax or making a copy of a document. The odd pages will be printed at the bottom of the paper, and the even pages at the top of the paper.

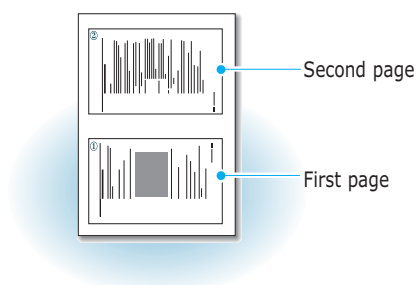

- If the LED is off, Paper Save mode deactivates.

To set up the Paper Save mode option, press and hold down **Paper**, and select the desired option. The following options are available;

2-UP COPY: Uses Paper Save mode only for copying a document. Select **ON** or **OFF** using ◀ or ▶.

2-UP FAX: Uses Paper Save mode only for receiving faxes. Select **ON** to or **OFF** using ◀ or ▶.

- Notes:**
- The data will be reduced in vertical and horizontal at the same rate depending on the paper size you chose in the Fax Paper Size setup menu (see page 3.3).
 - In case of receiving photo image, the 2-up fax printing image would be degraded by reduction.

Toll Save Mode

Toll Save mode allows you to save the toll for the telephone call by transmitting the document stored in memory during the time slot when the call charge is discounted.

For more information on Toll Save fax, see page 3.37.

chapter

2

Installing Samsung Software (S7-531P only)

This chapter provides information on installing the supplied Samsung software. You **MUST** install the Samsung software to use your machine as a printer and scanner.

The topics included in this chapter are:

Samsung SmarThru

- ◆ About Samsung SmarThru Software

Installing Software

- ◆ System Requirements
- ◆ Installing the Samsung Software
- ◆ Configuring the Fax Gate on Your PC
- ◆ Configuring the Internet Gate on Your PC
- ◆ Using Your machine with a USB Cable
- ◆ Making Installation Diskettes
- ◆ Installing Software from Diskettes
- ◆ Uninstalling Samsung Software

Samsung SmarThru

About Samsung SmarThru Software

You must to install the SmarThru CD-ROM after you have setup your machine and connected it to your computer. The SmarThru CD-ROM includes the following:

- MFP Driver
- USB Driver
- SmarThru Software
- OCR Software (AnyPage Lite)

MFP Driver

To use this machine as a printer, scanner, or RCP(Remote Control Panel), you **MUST** install the MFP driver.

USB Driver

To use this machine connected to your computer using a USB cable, you **MUST** install the USB driver and set the USB port.

SmarThru Software

SmarThru consists of several components, each of which provides a particular function:

MailBox – Working with e-mail and fax messages, you can create, send, browse and store messages.

Image Manager – Working with images, you can import, export, store and operate on images.

Scan Manager – Working with documents or images, you can scan to Image Manager, scan to OCR software, or to a fax.

Copy Manager – Working with documents or images, you can control a copying process. You can also save a copy of the image or document to Image Manager.

Image Viewer – Working with documents or images, you can view images in a variety of graphical formats.

OCR Software (AnyPage Lite)

OCR (Optical Character Recognition) is the software that has the ability to recognize most character formats, so that a scanned document can be read and edited on your word processor.

Installing Software

System Requirements

Before you begin, ensure you have the following computer setup:

Minimal requirements:

- **Operating systems:** Windows 95 OSR2/Windows 98/Windows 98 SE/Windows Me/Windows NT 4 Workstation or Server with Service Pack 3/Windows 2000
- **Disk space:** 120 MB for installation
- **Memory:** 32 MB
- **CPU:** Pentium 133
- **Required software:** Internet Explorer 4.01
- **User rights:** Administrative rights should be set for installation on Windows NT and Windows 2000.

Recommended

- **Operating systems:** Windows 98/Windows 98 SE/Windows Me/Windows NT 4 Workstation or Server with Service Pack 5/Windows 2000
- **Disk space:** 120MB for installation, 100MB for message/image database
- **Memory:** 32MB for Windows 9x, 64MB for Windows NT
- **CPU:** Pentium II 200
- **Required software:** Internet Explorer 4.01 or 5.0
- **User rights:** Administrative rights should be set for installation on Windows NT and Windows 2000.

Note: Windows 95 versions prior to OSR2 are not recommended due to compatibility with OLE/COM libraries.

Installing the Samsung Software

Note: For Windows 95/98 users, close “New Hardware Found” screen when the computer boots up.

1. Insert the supplied CD-ROM into your CD-ROM drive.

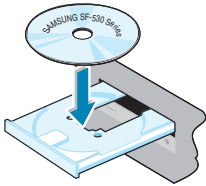

The SmarThru CD-ROM is automatically running and the opening window appears.

If the opening window does not appear, click **Start**, and then **Run**. Type **X:Setup.exe**, replacing “X” with the letter of your drive, and click **OK**.

2. When the opening screen appears, click on **SF-530 Series**, then the language you want to use.

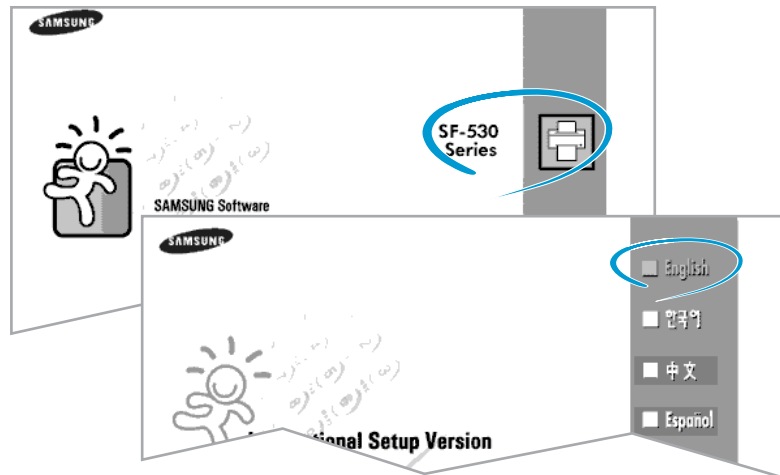

3. Click **Install the Samsung Software on your PC**.

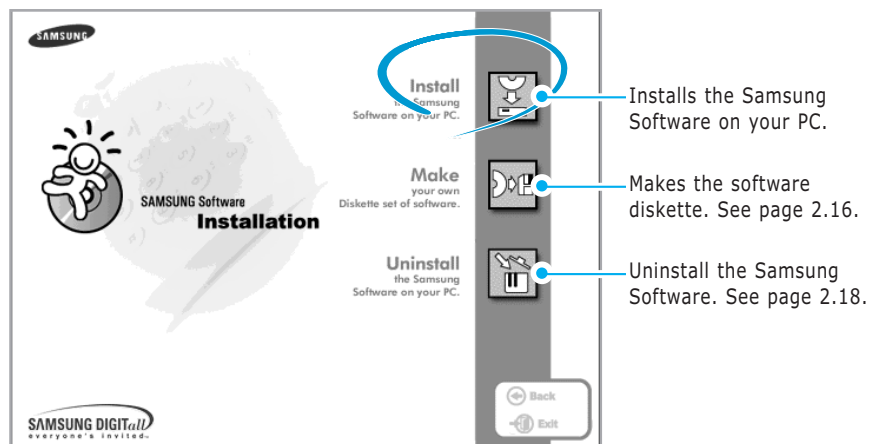

4. Follow the on-screen instructions and click **Next**.

5. The SmarThru installation supports three types of setup:

- **Typical:** Program will be installed with the most common options and is recommended for most users.
- **Compact:** Only the MFP driver will be installed.
- **Custom:** You may choose the options you want to install. Recommended for advanced users.

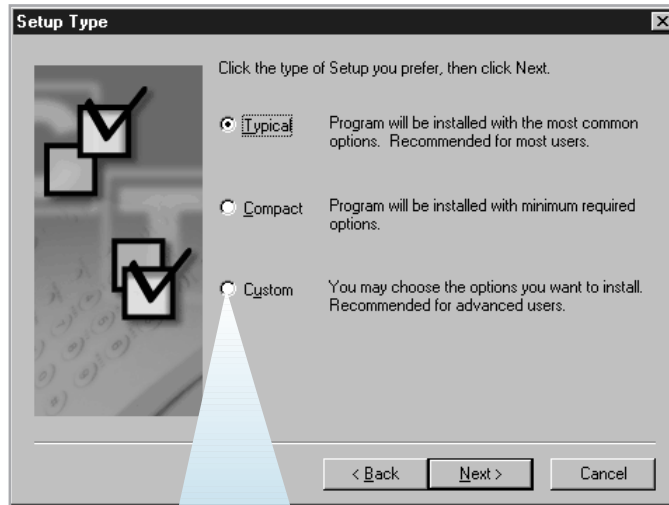

If you select the **Custom** installation, you may choose the options you want to install.

SmarThru software to scan and edit images and work with electronic documents.

AnyPage Lite software to enable OCR.

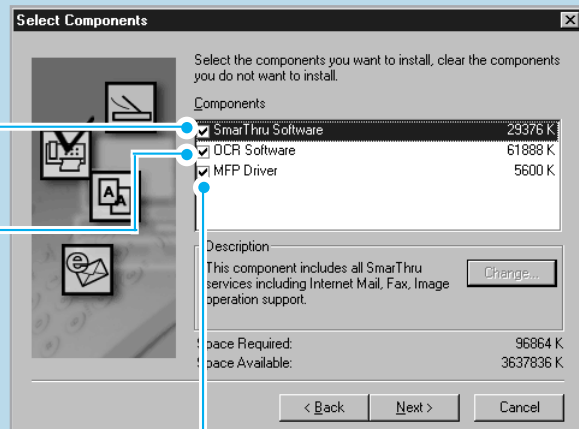

MFP driver to print and scan.

6. Click **Next**.

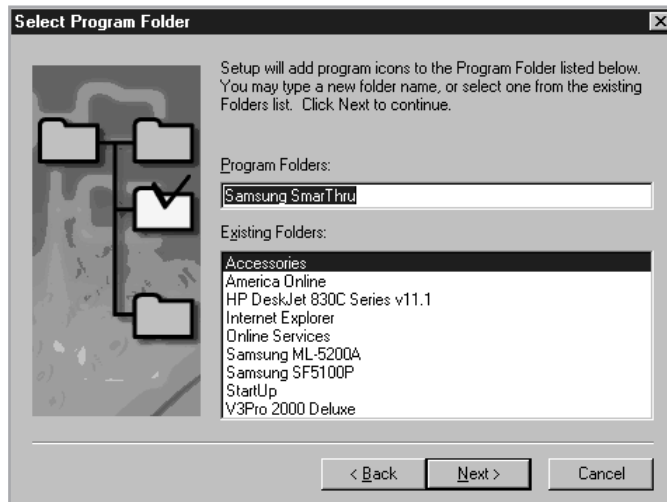

7. When the installation is completed, The message box recommends you restart your computer. Click **Finish**, then Windows restarts.

If your computer does not shut down and restart automatically, you must shut it down manually and restart for the changes to saved.

Note: If you are using Windows NT or Windows 2000, the warning message may appear when your computer boots up, telling you cannot install the fax driver on your computer. Click **OK** and continue the following steps.

Configuring the Fax Gate on Your PC

1. After installing the SmarThru software, Windows will automatically restart. When you see the Samsung SF-530 Series Program folder, close it by clicking on the right-top of the window.

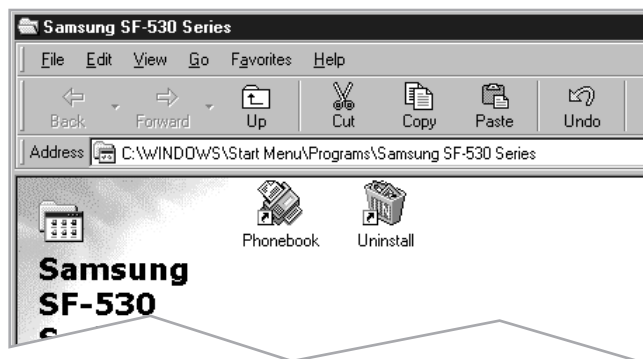

2. The SmarThru Add New Fax Modem dialogue box appears. Click **Next**.



To add a fax modem later or you do not want to have fax service using the SmarThru system, press Cancel, and go to page 2.9 to configure the Internet gate.

3. Choose **Modem** from the list. It will be used by SmarThru Fax Gate for sending and/or receiving PC faxes. Then, click **Next**.

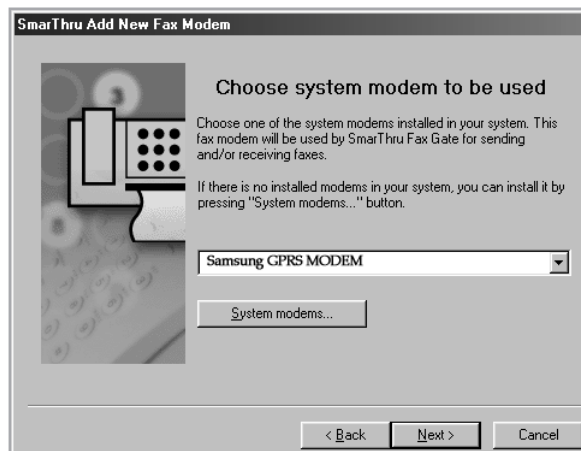

Note: The SmarThru FAX feature is available only if there is a FAX modem installed in your PC.
Press "Cancel" if there is no FAX modem installed in your PC.

4. Enter your fax number or name in the Fax identifier box, and click **Next**.

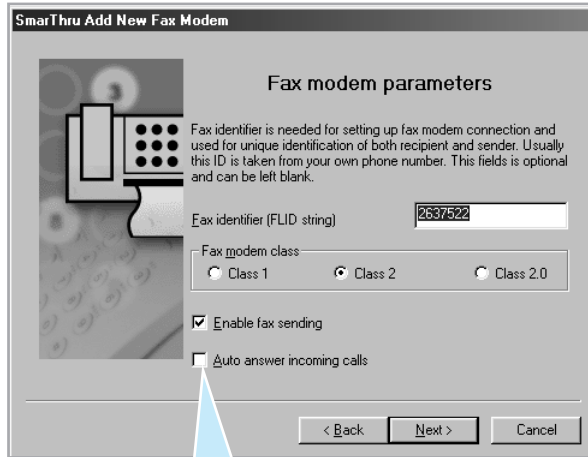

If you put a check mark in this box, the SmarThru system will automatically receive incoming calls. If you want to receive faxes at the SF-530 series, clear this box.

5. When you are finished, click **Finish**.



Note: To edit the advanced properties of Fax service or to add other modems, choose **SmarThru Configuration** from the **Tools** menu when you run the **Samsung SmarThru2**. For details, refer to the SmarThru User's Guide.

Configuring the Internet Gate on Your PC

When the fax modem configuration is complete, the SmarThru software loads the Internet Gate sets up your internet connection.

Note: To configure the internet gate of the SmarThru system, you must enter your e-mail address, SMTP/POP3 server address, POP3 account name and password. Ask your Internet Service Provider or online service provider about the information on your internet gate configuration.

1. The SmarThru Internet Gate Configuration Wizard dialogue box appears. Select the way you are connected to the Internet, then click **Next**.

If you are connected to the Internet over a LAN (i.e. in an office network environment), select **Connection to Internet over LAN**, and skip to Step 4.

If you use dial-up for Internet connection, select **Use Dial-Up for Internet Connection**, and proceed to the next step.

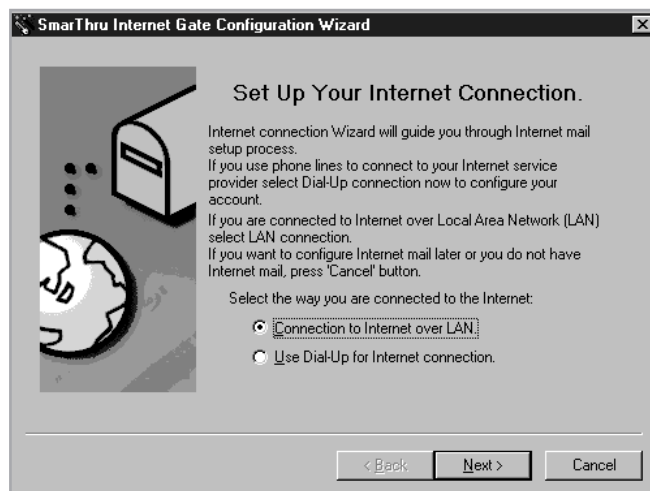

2. If you use a phone line for your Internet connection, configure Dial-Up settings using Windows Dial-Up Networking setup wizard. Click **Configure**.

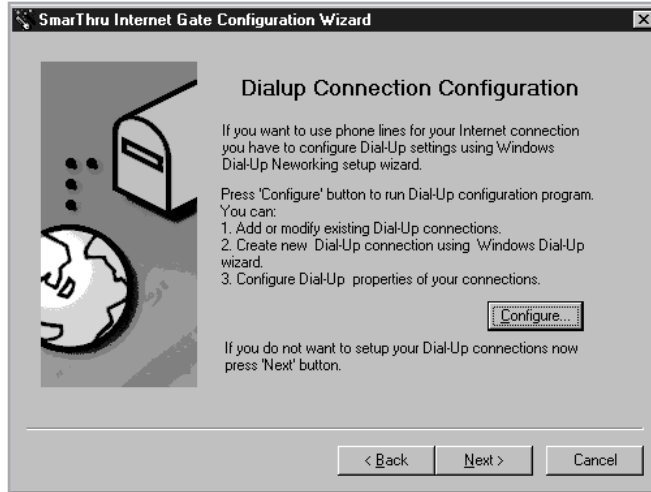

3. Click **Add**. The dial-up connections which are already set up on your computer are displayed. Select one from the list you want to use for Internet connection on the SmarThru system, then click **OK**.

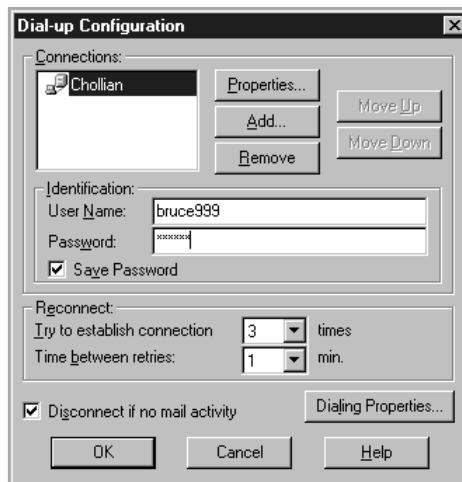

If no connection is available, you cannot use the system Dial-Up in the Samsung SmarThru system.

To modify the Dial-Up connection properties, click **Dialing Properties**.

Note: For details on the Dial-Up Configuration using the Windows Dial-Up Networking setup wizard, please refer to your Windows documentation.

4. Enter your name and e-mail address, then click **Next**. The e-mail address has been assigned to you by your Internet service provider.



The screenshot shows a window titled "SmarThru Internet Gate Configuration Wizard" with a close button in the top right corner. On the left side, there is a graphic of a globe and a mail envelope. The main area is titled "Internet E-mail Address". It contains two text input fields. The first is labeled "Enter your name:" and contains the text "bruce lee". Below it is the example "For example: John A. Smith". The second is labeled "Enter your e-mail address:" and contains "bruce999@chollian.net". Below it is the example "For example: mailbox@company.com". A note at the bottom reads: "Note: Your e-mail address is the address other people use to send e-mail messages to you. This address has been assigned to you by your Internet service provider." At the bottom right, there are three buttons: "< Back", "Next >", and "Cancel".

5. Enter the addresses of your incoming and outgoing mail servers. Choose the incoming mail server type, then click **Next**. Your Internet service provider must provide you this information.

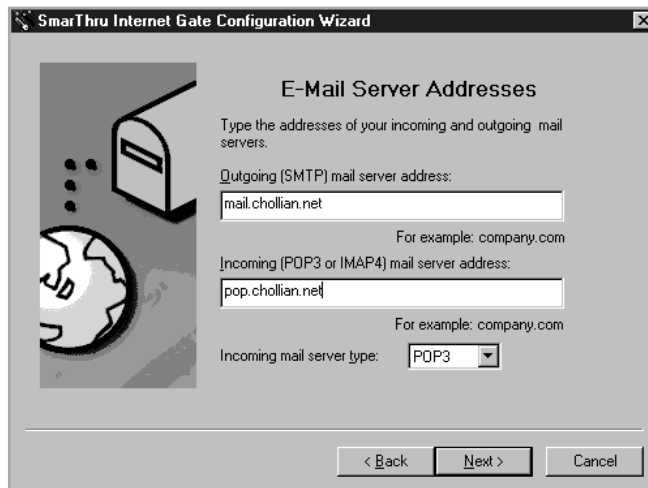

The screenshot shows a window titled "SmarThru Internet Gate Configuration Wizard" with a close button in the top right corner. On the left side, there is a graphic of a globe and a mail envelope. The main area is titled "E-Mail Server Addresses". It contains a text input field for "Outgoing (SMTP) mail server address:" with the text "mail.chollian.net" and the example "For example: company.com". Below it is another text input field for "Incoming (POP3 or IMAP4) mail server address:" with the text "pop.chollian.net" and the example "For example: company.com". At the bottom, there is a dropdown menu for "Incoming mail server type:" with "POP3" selected. At the bottom right, there are three buttons: "< Back", "Next >", and "Cancel".

6. Enter your account name and password to access your Internet mail server, then click **Next**. Your Internet service provider will provide this information.



7. Enter the account record name, then click **Next**.

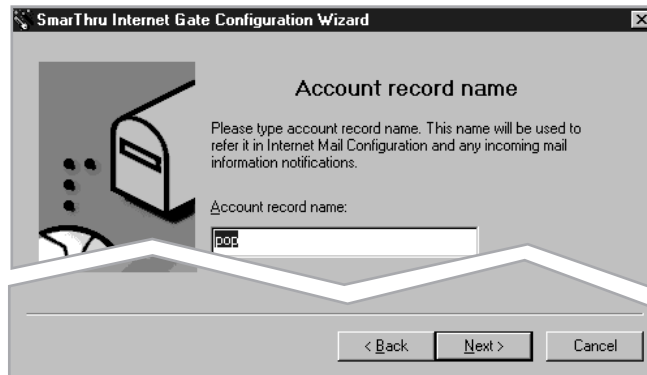

8. Click **Finish** to enable Internet e-mail service.



Note: If you wish, you can enable or reconfigure the Internet connection later. Open the **Samsung SmarThru2**, and select **SmarThru Configuration** from the **Tools** menu. For details, refer to the SmarThru User's Guide.

Using Your Machine with a USB Cable

If you have a USB (Universal Serial Bus) port enabled on your computer, you can connect your SF-530 series to the USB chain of devices.

Installing MFP Driver

To operate your printer with Windows PC, you must install the MFP driver. Place the CD-ROM in the CD-ROM drive and perform the instructions on page 2.4.

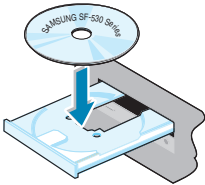

Connecting Your Machine with USB Cable and Installing USB Driver

1. Make sure that both the printer and computer are turned ON.
2. Plug one end of the USB cable into the USB port on the printer and the other end into the USB port (Ⓜ) on the computer.

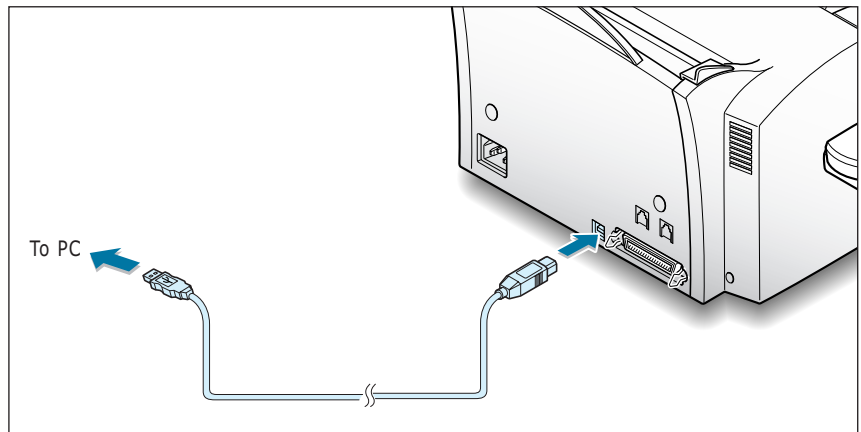

3. The Add New Hardware Wizard dialogue box appears. Click **Next**.



4. Check **Search for the best driver for your device** and click **Next**.



5. Check CD-ROM drive and click **Browse**, then choose **x:\Driver\USB** (where x is the drive letter for the CD-ROM drive).



6. Click **Next**. The USB driver will be installed.



7. Follow the instructions on the screen to complete the installation.

Setting Your PC Printer Port

1. From Window's **Start** menu, select **Settings**, then select **Printers**.
2. Select the Samsung SF-530 series printer icon in the Printers folder.
3. Select **Properties** from the **File** menu.
4. Click the **Details** tab. Select **SSUSB: (SF-530 Series)** in the Print to the following port box. Click **OK**. The setup is now completed.

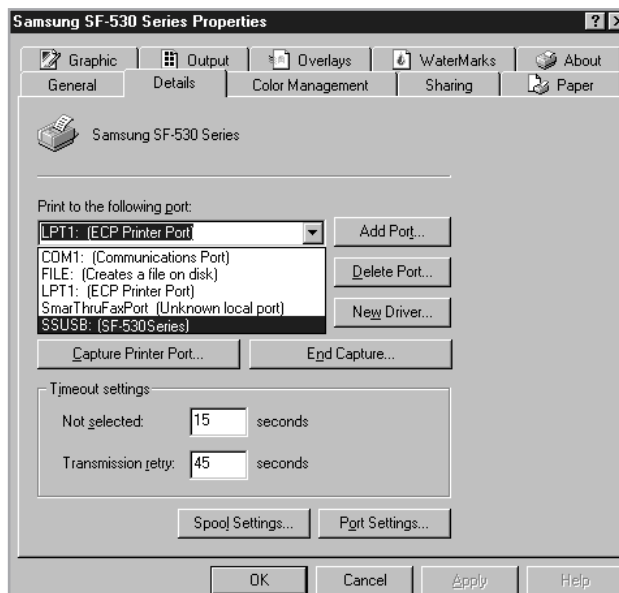

Note: For the installation of printer driver, refer to page 2.4.

Making Installation Diskettes

If you do not have a CD-ROM drive and if you have access to another computer with a CD-ROM drive, you can copy software installation files from the Samsung software CD-ROM onto floppy diskettes. The diskettes can then be used instead of the CD-ROM to install the software.

To make the installation diskettes for an MFP drive, ensure you have several formatted diskettes ready, and follow these steps:

1. Insert the supplied CD-ROM into your CD-ROM drive.

The SmarThru CD-ROM is automatically running and the opening window appears. (If the opening window does not appear, click **Start**, and then Run. Type **X:Setup**, replacing "X" with the letter of your drive, and click **OK**).

2. When the opening screen appears, lick on **SF-530 Series**, then the language you want to use
3. Click **Make your own Diskette set of software**.

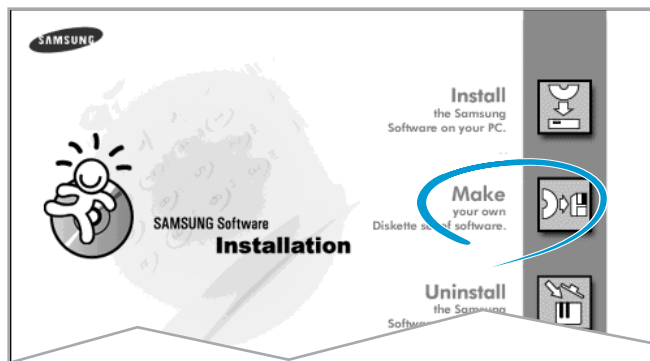

4. The Copy to Floppy dialogue box appears. Click **Copy all disk images**.

If you want to copy a portion of the selected component, select the disk image you want to copy in the Disk Images window, then click **Copy selected disk image**.

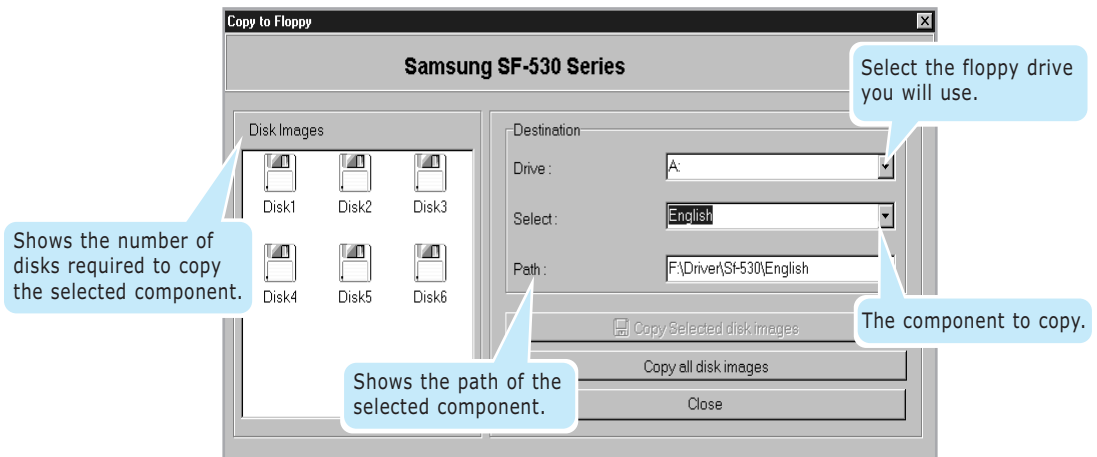

5. When prompted, insert a blank, formatted diskette into the floppy drive, and click **Yes** to copy the first diskette. When the first diskette is finished, you are prompted on the PC screen to insert disk 2.

Label each diskette in the order you create it: MFP driver, disk 1 of 6, etc.

6. When the diskettes have finished copying, click **Close** in the Copy to Floppy dialog box.

Installing Software from Diskettes

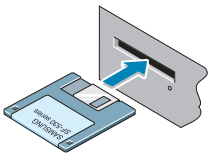

1. Insert the first diskette which contains the MFP driver.
2. From the **Start** menu, select **Run**.
3. Type **A:\setup.exe** in the Open box and click **OK**. (if your floppy drive is not **A**, substitute the correct letter.)
4. Follow the on-screen instructions to complete the installation.

Uninstalling Samsung Software

Un-installing is required if you are upgrading the software or if your installation fails.

Note: Before beginning un-installation, ensure all applications are closed on your PC. A system reboot is required after the software is un-installed.

Un-installing the MFP Driver

1. Start Windows if not already started.
2. From the **Start** menu, select **Programs**, then select **Samsung SF-530 Series**, then select **Uninstall**.



3. When your computer confirms your selection, click **Yes**. The printer driver and all its components are removed from your computer.



4. When un-installation is done, click **OK**.
5. The message box recommends you restart your computer. Click **OK**, then restart Windows.

Un-installing the SmarThru Software

1. Start Windows if not already started.
2. From the **Start** menu, select **Programs**.
3. Select **Samsung SmarThru**, then select **SmarThru 2 Uninstall**.

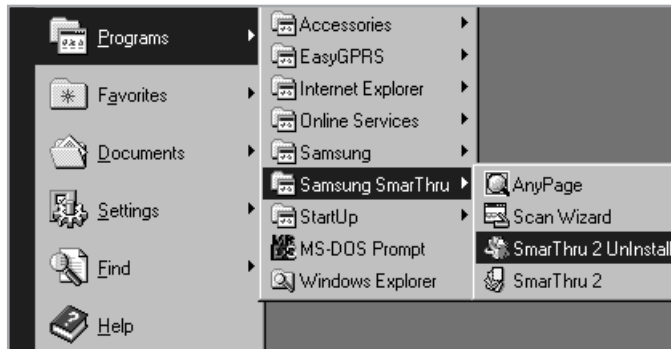

4. When your computer asks you to confirm your selection, click **Yes**. The Select Backup Options dialogue box appears.
5. To remove all messages and address book information from your hard drive, click **Clear All**, then **OK**. When the message box confirms your selection, click **Yes**.

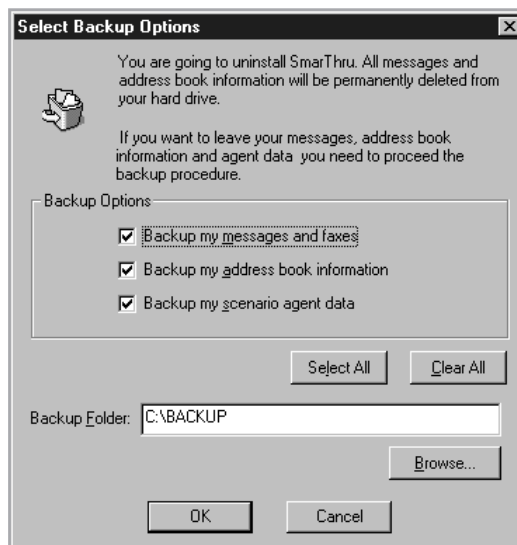

To leave the information, put checkmarks on the check boxes to select options you want to leave or click **Select All**, then click **OK**. The backup proceeds. When the backup is done, click **Close**.

6. Follow the on-screen instructions to complete the un-installation. The SmarThru software and all components will be removed.



7. When un-installing is done, click **OK**. The message box recommends restarting your computer.

8. Click **OK**.

Shut down and restart your computer to complete the un-installation process and save your changes.

Using the SmarThru CD-ROM

You can un-install both the MFP driver and the SmarThru software with the CD-ROM you have used to install the software.

1. Insert the SmarThru CD-ROM into your CD-ROM drive.

The SmarThru CD-ROM is automatically running and the opening window appears. (If the opening window does not appear, select **Run** from the **Start** menu, then type **X:SETUP**, replacing "X" with the letter of your drive and click **OK**.

2. When the opening window appears, lick on **SF-530 Series**, then the language you want to use.
3. Click **Uninstall the Samsung software on your PC**.

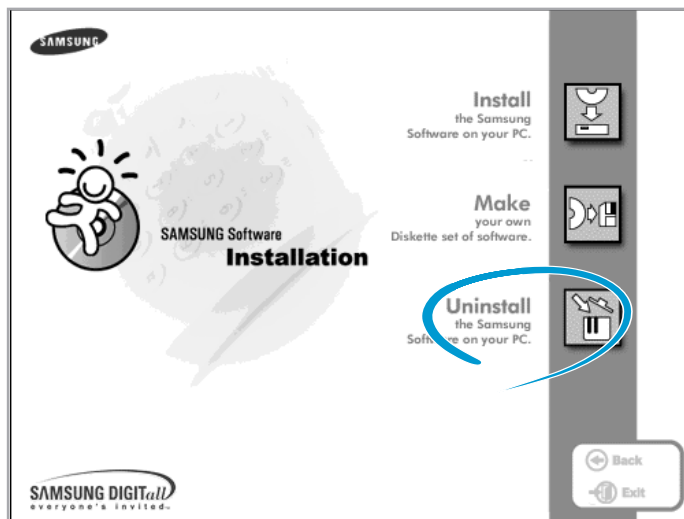

4. Follow the on-screen instructions to complete un-installation.

You must shut down and restart your computer before changes you have made will be in effect.



chapter

3

Stand-alone Fax

This chapter explains how to send and receive faxes from the front panel of the SF-530 series. This chapter also demonstrates how to use the advanced fax features and change the settings on the fax system.

This chapter provides information on the following topics:

- ◆ Setting Up Stand-alone Fax System
- ◆ Sending a Fax
- ◆ Receiving a Fax
- ◆ Making a Copy
- ◆ Automatic Dialling
- ◆ Advanced Fax
- ◆ Additional Functions

Setting up Stand-alone Fax System

Setting Volume

Ringer Volume

You can adjust the volume of the ringer to your desired volume.

1. Press ◀ or ▶ in Standby mode.
The display shows the current ringer volume setting.



RINGER VOL. [3]

2. Press ◀ or ▶ until you find the desired loudness. Four levels are available; 0~3.

You will hear the selected volume and the display will show the level. Setting '0' turns the ringer off. The machine will work normally even if the ringer is set to off.

3. Press **Start/Enter** to save the setting.

Speaker Volume

1. Press **OHD/V.Req** to adjust the speaker volume. If you cannot hear dial tone, check the phone line connection.
2. Press ◀ or ▶ repeatedly until you find the desired loudness.
The display shows the current volume level.

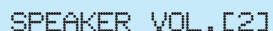

SPEAKER VOL. [2]

3. After choosing the desired volume level, press **OHD/V.Req**.

Setting Alert Tones

You can choose an alarm tone to sound when an error occurs (ALARM VOLUME) or when any key is pressed (KEY VOLUME).

1. Press **Setup** on front panel. The display shows the first setup menu; FAX NUMBER/NAME.
2. Press ◀ or ▶ until 'VOLUME SETUP' appears, then press **Start/Enter**. The display shows 'ALARM VOLUME'.
3. Press **Start/Enter** to access the Alarm Volume menu. To access the Key Volume menu, press ◀ or ▶ until 'KEY VOLUME' appears, then press **Start/Enter**.
4. Press ◀ or ▶ to turn the sound ON or OFF, then press **Start/Enter** to save the setting.
5. To return to Standby mode, press **Stop**.

Setting User-Selectable System Options

Your machine has various user-selectable system options. These options are preset at the factory but you may need to change them. To find out how the options are currently set, print the System Data list. For more information on printing the list, see above.

Setting an Option

1. Press **Setup** on the front panel. The display shows the first menu; FAX NUMBER/NAME.
2. Press ◀ or ▶ until 'SYSTEM SETUP' appears. The display shows the first option menu; LANGUAGE.
3. Scroll through the options by pressing ◀ or ▶ repeatedly.
4. When the option you want appears on the display, press **Start/Enter**.
5. Choose the desired status by pressing ◀ or ▶ repeatedly, or enter the desired value using the number keypad.

6. When setting is done, press **Start/Enter** to save the setting.

You can exit from setup mode at any time by pressing **Stop**. The machine returns to Standby mode without saving the setting you have already changed.

Selectable Options

These instructions assume you have followed the steps on page 3.2 under 'Setting an Option' and the machine is prompting you to change one of the options listed here.

- **LANGUAGE** — You can select the display language. The available languages are **ENGLISH, GERMAN, FRENCH, ITALIAN, SPANISH, PORTUGUESE** and **DUTCH**.

- **SEND FROM MEMORY**—Enables all transmission documents to be automatically scanned into the memory before transmission.

Select **ON** to enable.
Select **OFF** to disable.

- **SENDING CONFIRM** — A confirmation report shows whether the last transmission was successful or not, how many pages were sent, etc.

Select **ERROR** to print only when an error occurs and the transmission was not successful.
Select **ON** to print a confirmation report automatically each time you send a fax.
Select **OFF** to turn off.

- **FAX PAPER SIZE** — Select the paper size you will use for recording. **LETTER, A4** and **LEGAL** sizes are available.

Note: If you set the Auto Reduction menu option, or turned Paper Save mode on, your machine will determine the reduction rate according to this setting.

- **AUTO REDUCTION** — When receiving a document as long or longer than the paper loaded in your machine, the machine can reduce the data in the document to fit into your recording paper size.

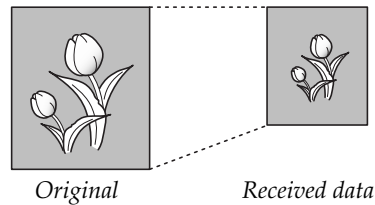

Turn this feature on to reduce an incoming page that may need to be divided into two pages with only a few lines on the second page. If the fax machine cannot reduce the data to fit onto one page with this feature enabled, the data will be divided and printed in actual size on two or more sheets if necessary.

Select **ON** to enable. Note that this feature does not apply to the copy mode.

Select **OFF** to turn this feature off. The overflow data will be printed out on a second page.

- **DISCARD SIZE** — When receiving or copying a document as long as or longer than the paper installed in your machine, you can set the machine to discard any excess image at the bottom of the page to fit onto the recording paper size.

Enter the desired discard size from 0 through 30 mm using the number keypad.

If the received page is outside the margin set, it will be printed on two sheets of paper at the actual size.

If the data is within the margin, and the Auto Reduction feature is on, it will be reduced to fit onto the appropriate size paper (Discard does not take place). If the Auto Reduction feature is turned OFF or fails, the data within the margin will be discarded.

- **RINGS TO ANSWER** —You can select the number of times your machine rings before answering an incoming call. If you are using your machine as both a telephone and a fax machine, we suggest you set the ring count to at least 4 to give you time to answer.

- **STAMP RCV. NAME**—Allows the machine to automatically print the page number, and the date and time of the reception at the bottom of each page of a received document.

Select **ON** to enable.
Select **OFF** to disable.

- **RCV. START CODE** — The remote receive start code allows you to initiate fax reception from an extension phone plugged into the EXT. jack on the back of your machine. If you pick up the extension phone and hear fax tones, enter the remote code and the machine will start receiving. The password is preset to '*9*' at the factory.

Enter the desired code 0 to 9 on the number keypad.

- **ECM MODE** (Error Correction Mode) — This mode compensates for poor line quality and ensures accurate, error-free transmission with another ECM-equipped facsimile machine. If the line quality is poor, transmission time may be increased when the ECM is enabled.

Select **ON** to enable.
Select **OFF** to disable.

- **CALLER ID** — When you receive a call, you can see the number of the person calling you if it is available from the network on which the call was made. (This option may not work when connected to a PABX.)

Select **ON** to turn on caller ID display.
Select **OFF** to disable.

- **JUNK FAX BARRIER** — With this feature set to ON, the system will only accept a fax sent from the remote station of which the fax number is stored in memory as a one-touch or two-digit speed dial number. This feature is useful for blocking any unwanted fax.

Select **ON** to turn this feature on. You can receive only from the registered stations.
Select **OFF** to turn this feature off. Anybody can send you a fax.

Notes:

- This feature needs the number reported by the remote fax to be an exact match to a one-touch or speed dial number in the SF-530 Series. If you have a problem receiving faxes, turn this feature off.

- **DRPD MODE** — “Distinctive Ring” is a telephone company service which enables a user to use a single telephone line to answer several different telephone numbers. The particular number someone uses to call you on is identified by different ringing patterns, which consist of various combinations of long and short ringing sounds. This feature is often used by answering services who answer telephones for many different clients and need to know which number someone is calling in on to properly answer the phone.

Using the Distinctive Ring Pattern Detection feature, your fax machine can “learn” the ring pattern you designate to be answered by the FAX machine. Unless you change it, this ringing pattern will continue to be recognised and answered as a FAX call, and all other ringing patterns will be forwarded to the extension telephone or answering machine plugged into the EXT. jack.

You can easily suspend or change Distinctive Ring Pattern Detection at any time.

Before using the Distinctive Ring Pattern Detection option, Distinctive Ring service must be installed on your telephone line by the telephone company. To setup Distinctive Ring Pattern Detection, you will need another telephone line at your location, or someone available to dial your FAX number from outside.

Select **ON** to turn this feature on.

Select **OFF** to turn this feature off.

Select **SET** to setup or change the Distinctive Ring Pattern Detection. The LCD displays ‘WAITING RING’. Call your fax number from another telephone. It is not necessary to place the call from a fax machine. When your machine begins to ring, do not answer the call. The machine requires several rings to learn the pattern.

When the machine completes learning, the LCD displays ‘END DRPD SETUP’.

With the DRPD feature active, ‘DRPD’ appears in the display and the previously set reception mode is ignored. If you turn off DRPD, the machine returns to any previously set reception mode.

Notes:

- DRPD must be set up again if you re-assign your fax number, or connect the machine to another telephone line.
- After DRPD has been set up, call your fax number again to verify that the machine answers with a fax tone. Then have a call placed to a different number assigned to that same line to be sure the call is forwarded to the extension telephone or answering machine plugged into the EXT. jack.

Sending a Fax

Preparing Documents for Faxing or Copying

To fax or copy documents that are printed on standard letter or A4 size paper, follow these guidelines.

- Do not attempt to feed the following types of documents into the machine:
 - wrinkled, curled, or folded paper
 - chemically processed paper (pressure-sensitive paper, carbon-coated paper, etc.)
 - coated paper (glossy, etc.)
 - thin paper (onion skin, airmail paper, etc.)
 - thick paper
 - small or short paper (such as a label, voucher, etc.)
 - paper made of cloth or metal

To feed any of these documents, make copies using a standard copy machine and insert the copies into the document tray.

- Remove all staples and paper clips before feeding the document.
- Ensure any glue, ink, or correction fluid on the paper is completely dry before feeding the document.
- Do not feed documents with pages that are different sizes or different thicknesses.

ACCEPTABLE DOCUMENTS (for ADF¹)

		Single Sheet	2 or More Sheets
Document Size	Max.	8.5 in. (W) x 14 in. (L) (216 mm x 356 mm)	8.5 in. (W) x 11.7 in. (L) (216 mm x 297 mm)
	Min.	5.8 in. (W) x 5.0 in. (L) (148 mm x 128 mm)	
Effective Scanning Width		8.26 in. (210 mm)	
Number of sheets which can be loaded at a time			Up to 20
Thickness of document		0.05 mm ~ 0.07 mm 0.15 mm ~ 0.2 mm	0.075 mm ~ 0.12 mm
Print Quality		Uncoated on both sides	

¹ ADF stands for Automatic Document Feeder. It allows you to stack original documents, which will be faxed or copied one by one.

Setting Document Resolution and Contrast

We recommend sending documents printed using a typewriter, felt tip pen, black ink, or laserwriter. The paper should be white or very light, and of normal weight – not cardboard. Blue lines on a ruled pad do not fax well.

To send normal documents, there is no need to adjust the resolution and the contrast.

To send documents with unusual contrast characteristics, including photographs, adjust the resolution and contrast.

Resolution

To increase sharpness and clarity, press the **Resolution** button repeatedly after loading a document until you find the desired mode. You can choose between STANDARD, FINE, or SUPER FINE mode.

STANDARD (200X 100 dpi) works well for documents with normal sized characters.

FINE (200 X 200 dpi) is good for documents containing small characters, thin lines, or print from a dot-matrix printer.

SUPER FINE (300 X 300 dpi) works well for documents containing extremely fine details. SUPER FINE works only if the remote machine also has the SUPER FINE features.

Contrast

To compensate for the brightness or darkness of your document, press the **Rcv. Mode/Contrast** button repeatedly after loading a document until you find the desired mode. You can choose between NORMAL, DARKEN, LIGHTEN, or PHOTO.

NORMAL works well for normal documents.

DARKEN works well for light print or faint pencil markings. The light image and text on the document will be darker on the printed page.

LIGHTEN works well for dark print. The dark image and text on the document will be lighter on the printed page.

PHOTO is used when faxing photographs or other documents containing color or shades of gray. When you choose this mode, you should set the resolution to **FINE**.

Loading Documents

1. Load your document **face down** with the top edge first going into the document feeder.
2. Adjust the document guides for the width of the document.
3. Slide the sheet down into the document feeder until it is in the feed area.

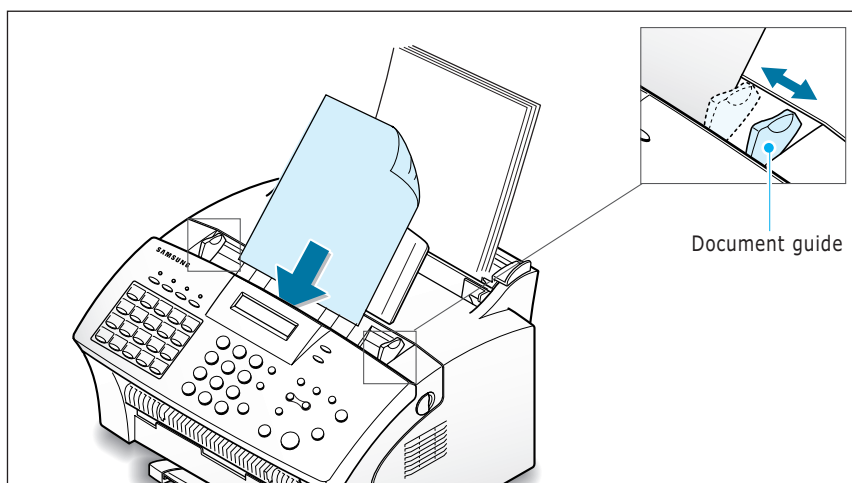

You can insert up to **20 sheets at a time**. If you insert more than one sheet, ensure the bottom sheet enters first. Stagger the leading edge of the document slightly, and insert the document with a slight push to ensure they feed smoothly.

To add pages while the fax is being sent, place them on top of the already loaded sheets.

4. If necessary, use the **Resolution** and **Rcv. Mode/Contrast** buttons to change the resolution and the contrast (see page 3.8).

Sending a Fax Automatically

1. After loading a document, enter the number of the remote fax using the keypad.

One-touch or speed dialling is also available if you have already stored the number into a one-touch or speed dial number. For information on storing and using numbers in the memory, see page 3.19.

If you make a mistake while entering a number, press **Search/Delete** to delete the number.

2. Press **Start/Enter** when the number appears correctly on the display. The machine dials the number and begins to transmit.

Cancelling a Transmission

Press **Stop** any time during transmission. The machine continues to send the fax and the display shows a message warning that the machine is in use. Press **Stop** again.

Confirming a Transmission

When the last document has been sent successfully, the machine beeps and returns to the Standby mode.

If something went wrong during your fax transmission, an error message appears on the display. For a listing of error messages and their meanings, see page 6.5. When you receive an error message, press **Stop** to clear the message and resend the document.

You can print out a confirmation report automatically each time sending is completed. For more information, see 'Setting User-Selectable System Options' on page 3.2.

Automatic Redialling

If the number you have dialled is busy or there is no answer, the machine will automatically redial the number every three minutes up to a maximum of two times.

The display shows 'RETRY REDIAL?.' To redial the number without waiting, press **Start/Enter**. To cancel the automatic redialling, press **Stop**.

Last Number Redialling

Press **Redial/Pause** with a document loaded in the feeder, the machine begins to send.

The redial memory in your machine retains the last 10 numbers called. To search through the redial memory, do as follows:

1. Press and hold **Redial/Pause** for about 2 seconds.
2. Press ◀ or ▶ to search through the memory until you find the desired number.
3. When the desired number appears on the display, press **Start/Enter** to dial.

Sending a Fax After Talking

You can send a fax after talking with the remote location.

1. After loading a document, pick up the handset and call the remote machine.

You can also use the extension phone to call the remote machine.

2. If the remote party answers, talk with her/him.
3. Press **Start/Enter** after you finish talking. The machine begins to transmit.
4. Replace the handset.

Voice Request

If you are sending or receiving a document and need to speak to the other person during the same phone call, use Voice Request to alert the person at the remote site. You can also respond to a Voice Request made by the person at the remote end.

Sending a Voice Request

1. Press **OHD/V Req** while a document is being sent or received. Voice Request signal is stored and then sent to the remote fax machine after the document has been sent or received.
2. When the phone rings, pick up the handset and answer it.

You can cancel a Voice Request by pressing **OHD/V Req** again while you are sending or receiving a document.

Answering a Voice Request

When the phone rings after sending or receiving a fax, pick up the handset and answer it.

If you do not answer the Voice Request, the machine prints out the number that made the Voice Request, as well as the time and date that the request was made.

Receiving a Fax

About Reception Modes

Your machine has four reception modes:

- In **FAX** mode, the machine answers an incoming call and immediately goes into receive mode.
- In **AUTO** mode, the machine answers an incoming call expecting to receive a fax. If the machine does not sense a fax signal, it will continue to sound the ringing tone to tell you it is a phone call. If you do not lift the handset during the ringing, the machine will switch to automatic fax reception mode.
- In **ANS/FAX** mode, the answering machine answers an incoming call, and the caller can leave a message on the answering machine. If the fax machine senses a fax tone on the line, the call automatically switches to the fax machine.

Note: To use the ANS/FAX mode, attach an answering machine to the EXT. jack on the back of your machine (see page A.1).

- In **TEL** mode, the automatic fax reception is turned off. You can receive a fax by picking up the handset or pressing the OHD, and then pressing **Start/Enter** on the front panel of your SF-530 series product.
- In **DRPD** mode, you can receive a call using the Distinctive Ring Pattern Detection (DRPD) feature. "Distinctive Ring" is a telephone company service which enables a user to use a single telephone line to answer several different telephone numbers. This mode is displayed when you have set up the distinctive ring pattern. For details on this feature, see page 3.6.

The current reception mode is displayed when the machine is in Standby mode.



If you seldom use the fax line for voice conversations, set your machine to receive a fax automatically by selecting FAX mode.

Loading Paper for Receiving Faxes

The instructions for loading paper in the paper input tray are the same whether you are printing, faxing, or copying, except that faxes can only be printed on letter-, A4-, or legal-sized paper. See "Loading Paper" on page 1.15 for instructions.

After loading paper for receiving faxes, set the paper size to the size of paper you normally load in the paper input tray. SF-530 series product uses this setting when printing reports and determining autoreduction for incoming faxes. See page 3.3 to set the paper size.

Note: As for SF-531P, the printing function does not use this setting. If you are loading special-sized media only for your current print job, do not change this setting. After you have finished printing, reload the original paper.

Receiving Automatically in FAX Mode

The SF-530 series is preset to FAX mode at the factory. If you have changed the fax mode, take the following steps to receive faxes automatically:

1. Press and hold down **Rcv. Mode/Contrast** on the front panel repeatedly until the display shows 'FAX'.
2. When you receive a call, the machine answers the call on a specified number of rings and receives a fax automatically. To change the number of rings. See 'Setting User-Selectable System Options' on page 3.2.

To adjust the ringer volume, see 'Setting Volume' on page 3.1.

Receiving in AUTO Mode

1. Press and hold down **Rcv.Mode/Contrast** on the front panel repeatedly until the display shows 'AUTO'.
2. When you get a call, the machine answers it.

If a fax is being sent, the machine goes into reception mode.

If the machine does not detect a fax signal, it will continue ringing to tell you it is a phone call. You should pick up the handset to answer the call, or it will switch to automatic reception mode.

Receiving Automatically in ANS/FAX Mode

For this mode, you **MUST** attach an answering machine to the **EXT.** jack on the back of your machine (see page A.1).

1. Press and hold down **Rcv. Mode/Contrast** on the front panel repeatedly until the display shows 'ANS/FAX.'
2. When you receive a call, the answering machine will answer.

If the caller leaves a message, the answering machine stores the message as it would normally. If your machine hears a fax tone on the line, it automatically starts to receive fax.

Notes:

- If you have set your machine to ANS/FAX mode and your answering machine is switched off, or no answering machine is connected to your machine, your machine will automatically go into FAX mode after 6 rings.
- If your answering machine has a 'user-selectable ring counter', set the machine to answer incoming calls within 1 ring.
- If you are in TEL mode (manual reception) when the answering machine is connected to your machine, you must switch off the answering machine, or the outgoing message from the answering machine will interrupt your phone conversation.

Receiving Manually in TEL Mode

You can answer calls using the handset, and start the machine to receive a fax.

1. Press and hold down **Rcv.Mode/Contrast** repeatedly until the display shows 'TEL.'
2. When the telephone rings, pick up the handset and answer it.
3. If you hear a fax tone, or if the person on the other end asks you to receive a document, press **Start/Enter**.
4. Replace the handset. The machine begins receiving and returns to Standby mode when the reception is complete.

Receiving Manually Using an Extension Telephone

This feature works best when you are using an extension telephone connected to the **EXT.** jack on back of your machine (see page A.1). You can receive a fax from someone you are talking to on the extension telephone without having to go to the fax machine.

1. When you receive a call on the extension phone and hear fax tones, press the keys "*** 9 ***" (star nine star) on the extension telephone.

The machine receives the document.

Press the buttons slowly in sequence. If you still hear the fax tone from the remote machine, try pressing "*** 9 ***" once again.

"*** 9 ***" is the remote receive start code preset at the factory. The first and the last asterisks are fixed, but you can change the middle number to whatever you choose. For more information, see page 3.5.

2. When you have finished speaking and receiving documents, replace the handset of the extension telephone.

Making a Copy

Copying Overview

The resolution is automatically set to S.FINE while the copy feature is in use. However, the contrast can be changed to produce optimal copy quality for a particular document containing faint markings, dark image, photographs, or other halftone images.

- **Copy quantity** : 1 to 99 copies of the document can be made.
- **Custom sizing**: You can reduce or expand the image size by 1% increments from 50% to 130%. For SF-531P, you can reduce or expand the image size by 1% increments from 50% to 200%.
- **Print order and sorting** : When the Collate Copy menu is set to YES, the machine sorts the print jobs. All pages of the document are printed in reverse order before the next copy is printed. For example, if you copy a three-page job to print 2 copies, the machine prints page 3, page 2, page 1, page 3, page 2, page 1.

Making a Single Copy

To make a single copy without setting options, take the following steps:

1. Load a document with the print side facing down.
2. Press **Copy** twice. Your machine starts copying.

Using Advanced Copy Features

You can adjust the quantity, size, and print order for copying. Take the following steps:

1. Load your document **face down** with the top edge first going into the document feeder. If necessary, press **Rcv. Mode/Contrast** to change the contrast. For details on the Contrast, see page 3.8.
2. Press **Copy** . The display asks you to enter the copy quantity (1 to 99).
3. If you need two or more copies, enter the desired number and press **Start/Enter**.
4. If you want to reduce or expand the image size, enter the number of the desired zoom rate, then press **Start/Enter**.
5. The display asks you to set the Collate Copy menu. Press ◀ or ▶ to choose YES or NO. Setting YES will reverse the print order and sort the print job.

Example: 2 copies of a 3-page document

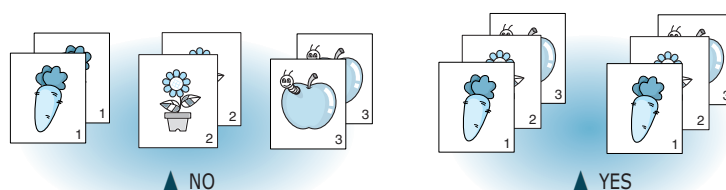

6. When the desired setting is selected, press **Start/Enter** or **Copy** to begin the copying.

Note: Pressing **Copy** at any time begins the copy operation immediately without displaying the remaining options.

Automatic Dialling

How To Enter a Name Using the Number Keys

As you perform various tasks, you will need to enter names and numbers. For example, when you set up your machine, you have to enter your name (or your company's name) and telephone number. When you store a one-touch dial or speed dial, you also enter the telephone numbers and names.

When the display asks you to enter a name, the LCD display reads:



NAME: _

Use the procedures described below to enter alphanumeric characters, special symbols, or spaces.

Entering Alphanumeric Characters

You can also include special symbols in the name by using the **0** key. See 'Keypad Character Assignments' on the next page.

1. Locate the button labelled with the letter you want - then press the button repeatedly until the correct letter appears in the display.



For example, to enter an 'R', press **7** (labelled PRQS). Each time you press **7**, the display shows a different letter—first 'P', then 'Q', 'R', 'S', and finally '7.'

The letter appears on the display as shown below.



- When the letter you want appears on the display, press another number key labelled with the next letter you want.

If the next letter is printed on the same number button, move the cursor right by pressing **▶**, then press the button.

The blinking cursor moves right and the next letter appears on the display.



- Select additional letters in the same way. When you have finished entering the letters, press **Start/Enter**.

KEYPAD CHARACTER ASSIGNMENTS

Key	Assigned numbers, letters, or characters
1	Space → 1
2	A → B → C → 2
3	D → E → F → 3
4	G → H → I → 4
5	J → K → L → 5
6	M → N → O → 6
7	P → Q → R → S → 7
8	T → U → V → 8
9	W → X → Y → Z → 9
0	+ → - → , → . → ' → / → * → # → & → 0

Editing Name

If you make a mistake while entering a number or name, move the cursor under the incorrect digit by ◀ or ▶. Then, press the correct number to change, or press **Search/Delete** to delete the number.

Inserting a Pause While Entering a Number

Some telephone systems require an access code (9, for example) and listen for a second dial tone before dialling an outside number. In such cases, you must insert a pause in the number when setting up a one-touch or a speed dial number.

To insert a pause, press **Redial/Pause** while entering the number.

When you dial a number, the dialling process pauses for a specified time at the point where you pressed **Redial/Pause**.

For a longer pause, press **Redial/Pause** twice.

One-Touch Dialling

One-Touch dialling lets you use any of the 20 one-touch buttons to automatically dial a number.

Storing a Number for One-Touch Dialling

1. Press and hold one of ten one-touch buttons for about 2 seconds. The display shows `Txx:`, where `xx` represents the selected one-touch button number.



Txx: _

If a number has already been stored in the location you chose, the display shows the number. To edit the number, see the next page.

If you press and hold the button used for group dial number, the display shows `GROUP ASSIGNED`, then asks you to press another one-touch button.

2. Enter the number you want to store by using the number keypad, then press **Start/Enter**.

To insert a pause between numbers, press **Redial/Pause**; a 'P' appears on the display.

If you make a mistake while entering a number, press **Search/Delete** and re-enter the correct number.

3. The display asks you to enter a name. For information on how to enter names, see page 3.19.

Or, if you do not want to assign a name, skip this step.

4. Press **Start/Enter** when the name appears correctly or without entering a name. The display asks you to press another one-touch number.
5. To set another one-touch number, press the desired one-touch button and repeat steps 2 through 4.

Or, to return to Standby mode, press **Stop**.

Editing a Number for One-Touch Dialling

1. Press and hold the one-touch button where the phone number has been stored.

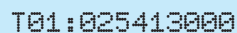

T01:025413000

2. Press ◀ or ▶ to move the cursor to the desired number and edit the number.

Note: When you press the One-Touch dial number stored for group dial, the display briefly shows 'G-REGISTERED' to indicate that the number is used for group dial, then you can edit the number.

3. When you have finished editing, press **Start/Enter**.

Sending a Fax Using a One-Touch Number

1. Load the document **face down** with the top edge first going into the document feeder.
2. Press the one-touch button where you stored a number. The number will be automatically dialled and the document transmitted when the remote fax machine answers.

Using Address Label

A One-touch label sheet is included with your machine. As you store numbers in one-touch dial buttons, make a note of the numbers on the label to remind you which number is stored in each position.

1. Remove the clear cover and label.

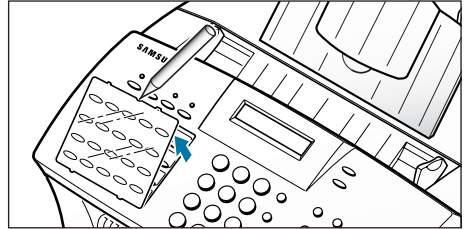

2. Write information on the label and replace the label and cover.

You may want to use pencil in case you wish to change these numbers later.

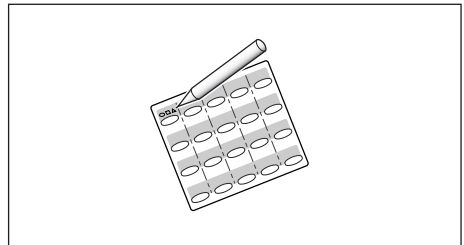

Speed Dialling

You can store up to 80 numbers in 2-digit Speed Dial locations (01-80).

Storing a Number for Speed Dialling

1. Press and hold **Speed(#)** for about 2 seconds.

LOC. [01-80] ►##

2. Enter a 2-digit location number (01 through 80) where you want to store a number, then press **Start/Enter**.

If a number has already been stored in a location, the display shows the number. To edit the number, see the next page.

3. Enter the number you want to store, then press **Start/Enter**.

Sxx:05512637522_

where xx represents the speed location you have selected at step 2.

4. To assign a name to the number, enter the desired name. For information on how to enter names, see page 3.19.

If you do not want to assign a name, skip this step.

5. Press **Start/Enter** when the name appears correctly or simply without entering a name. The display asks you to select another location.
6. To store more speed dial numbers, repeat steps 2 through 5.

Or,

To return to Standby mode, press **Stop**.

Editing a Number for Speed Dialling

1. Press and hold **Speed(#)** for 2 seconds.
2. Enter the 2-digit location number where the phone number you want to edit has been stored, then press **Start/Enter**. The display shows the number.



Sxx:05512637522

3. Press ◀ or ▶ to move the cursor to the desired number and edit the number.

Note: When you press the speed dial number stored for group dial, the display briefly shows 'G-REGISTERED' to indicate that the number is used for group dial, then you can edit the number.

4. When you have finished editing, press **Start/Enter**.

Sending a Fax Using a Speed Number

1. Load the document **face down** with the top edge first going into the document feeder.
2. Press **Speed(#)**, then enter a 2-digit speed dial location number.
3. Press **Start/Enter** to dial the number. The number will be automatically dialed and the document transmitted when the remote fax machine answers.

Using the Phonebook on Your Computer (SF-531P only)

When you install the printer's software on your computer, the Phonebook feature is automatically installed. With the Phonebook feature, you can set up one-touch dial or 2-digit speed dial numbers in your computer and download the information to your SF-531P machine.

Before using the Phonebook feature, you must install SmarThru programme in your computer. Refer to the chapter 2, "Installing Samsung Software."

1. Start your Windows.
2. Click the **Start** menu, and select **Programs** from the Start menu.
3. Select **Samsung SF-530 Series** on the Programs menu, and select **Remote Control Panel**.
4. The Remote Control Panel dialogue box appears.

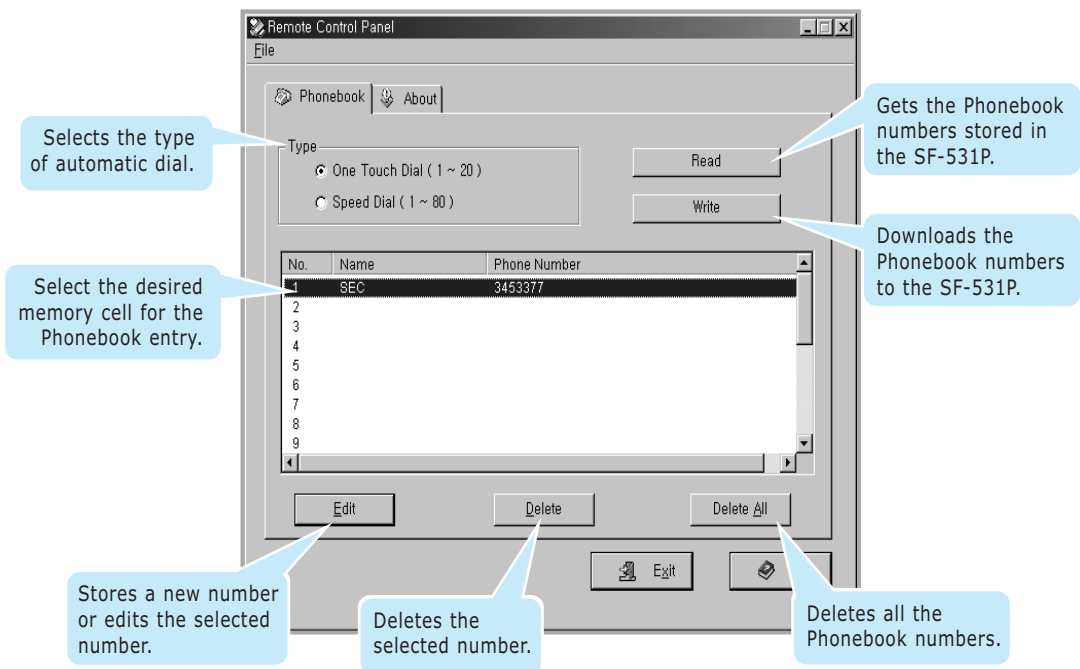

5. If necessary, press **Read** to get the numbers currently stored in your SF-531P machine. The one-touch or speed dial numbers will be uploaded and displayed in the Remote Control Panel dialogue box.
6. Select the desired Phonebook number in the Phonebook list and click **Edit**. The Edit dialogue box will appear.

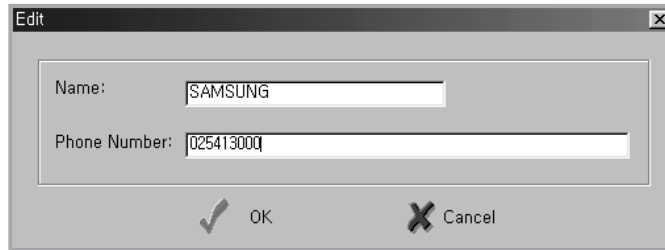

The image shows a screenshot of a dialog box titled "Edit". It contains two text input fields. The first field is labeled "Name:" and contains the text "SAMSUNG". The second field is labeled "Phone Number:" and contains the text "025413000". At the bottom of the dialog box, there are two buttons: "OK" with a checkmark icon and "Cancel" with an "X" icon.

7. Enter any name and number, and click **OK** to save the information you just entered.
8. Repeat steps 6 and 7 to store more numbers.
9. When you have finished, you must click **Write** to download the numbers to your SF-531P machine.
10. Click **Exit**.

Searching for a Number in the Memory

There are two ways to search for a number in the memory. You can either scan from **A** to **Z** sequentially, or you can search using the first letter of the name associated with the number.

Searching Sequentially through the Memory

1. Press **Search/Delete** on the front panel.



PRESS ◀, ▶, A-Z

2. Press ◀ or ▶ to scroll through the memory until you find the name and number you want.

Pressing ◀ or ▶ allows you to search downward through the entire memory in alphabetical order (from **A** to **Z**).

While searching through the machine's memory, you will see that each entry is preceded by one of three letters: '**T**' for one-touch dial, '**S**' for speed, or '**G**' for group dial number. These letters tell you how the number is stored.

3. When the name and number you want appears on the display, press **Start/Enter** to dial.

If a document is loaded, the document begins to be transmitted when the remote fax machine answers the phone.

Searching with a Particular First Letter

1. Press **Search/Delete**, then press the button labelled with the letter you want to search for. A name beginning with the letter appears on the display.

For example, if you want to find the name 'MOBILE,' press the '**6**' button, which is labelled with 'MNO.'

2. Press ◀ or ▶ to display the next name in the list.
3. When the name and number you want appear, press **Start/Enter** to dial.

Advanced Fax

Broadcasting

This feature will allow documents to be sent to multiple locations. After sending, the documents are erased from the memory.

1. Load your document **face down** with the top edge first going into the document feeder. And adjust the resolution and contrast, if necessary. For details, see page 3.8.
2. Press **Advanced FAX** on the front panel. The display shows the first menu; BROADCASTING.
3. Press **Start/Enter** to access the Broadcasting menu.
4. Enter the number of the remote machine using the number keypad.

You can also press a one-touch button including group dial buttons. If not, press **Speed(#)**, enter a 2-digit speed dial number, then press **Start/Enter**. The stored number appears on the display.

5. Press **Start/Enter** to confirm the number. The display asks you to enter another fax number.
6. If you want to send to more than one location, repeat steps 4 and 5.

Note: You cannot use Group dial numbers for another fax number.

Or,

To send to one location or when you complete the last fax number setting, press **Start/Enter**.

- The document will be scanned into memory. The display shows the memory capacity and the number of pages being stored. The machine begins sending the documents in order of the numbers you entered.

Notes:

- If 'MEMORY FULL' occurs while scanning into the memory, the display will show:

JOB ► CANCEL ► DONE

Press ◀ or ▶ to select the option you want. If you select **Cancel**, broadcasting is cancelled. If you select **Done**, your machine performs broadcasting only with the pages already scanned.

- If an error occurs while sending to a specific number, the machine transmits the document to all the other numbers, then retries the number that previously recorded an error. After completing transmission, your machine prints the multi-communication report.

Delayed Fax

The SF-530 series can be set to send a fax at a future time.

- Load your document **face down** with the top edge first going into the document feeder. And adjust Resolution and Contrast, if necessary. For details, see page 3.8.
- Press **Advanced FAX** on the front panel. The display shows the first menu; BROADCASTING.
- Press ◀ or ▶ until 'DELAYED FAX' appears, and press **Start/Enter** to access the Delayed FAX menu.
- Enter the number of the remote machine using the ten number keypad.

You can also press a one-touch button including group dial buttons. If not, press **Speed(#)**, enter a 2-digit speed dial number, then press **Start/Enter**. The stored number appears on the display.
- Press **Start/Enter** to confirm the number. The display asks if you want to enter another fax number.

ENTER ANOTHER NO

6. If you want to send to more than one location, repeat steps 4 and 5.

Note: You cannot use Group dial numbers for another fax number.

Or,

To send to one location or when you complete the last fax number setting, press **Start/Enter**.

7. The display asks you to enter a name. If you want to assign a name to the transmission, enter the name. If not, skip this step.

For details on how to enter the name using the number keypad, see page 3.19.

8. Press **Start/Enter**. The display shows the current time and asks you to enter the time when the fax is to be sent.



The current time

9. Enter the time by using the number keypad, then press **Start/Enter**.

Enter the time in 24-hour format. For example, enter 2230 for 10:30 P.M. If you set a time earlier than the current time, the document will be sent at that time on the following day.

10. The document will be scanned into memory. The display shows the memory capacity and the number of pages being stored.
11. The machine returns to Standby mode and the display alternates between messages to remind that you are in Standby mode and that a Delayed Transmission is set.

Note: To cancel the operation reserved in memory, see 'Cancelling a Scheduled Operation' on page 3.34.

Priority Fax

When the priority fax is enabled, a high priority document can be transmitted ahead of reserved operations. The document is scanned into the memory, then transmitted when the current operation is concluded. In addition, a priority transmission will interrupt a broadcast operation between stations (i.e., when transmission to station A ends, before transmission to station B begins) or between redial attempts.

1. Load the document face down. If necessary, adjust Resolution, or Contrast. For details, see page 3.8.
2. Press **Advanced FAX** on the control panel. The display shows the first menu; BROADCASTING.
3. Press ◀ or ▶ until 'PRIORITY FAX' appears, then press **Start/Enter** to access the Priority Fax menu.

4. Enter the number of the remote machine using the ten number keypad.

You can also press a one-touch button. If not, press **Speed(#)**, enter a 2-digit speed dial number, then press **Start/Enter**. The stored number appears on the display.

5. Press **Start/Enter** to confirm the number. The display asks you to enter a name.
6. If you want to assign a name to the transmission, enter the name. If not, skip over this step.

For details on how to enter a name using the number keypad, see page 3.19.

7. Press **Start/Enter**. The document will be scanned into memory. The display shows the memory capacity and the number of pages being stored.
8. The machine shows the number being dialled, then begins sending the document.

Polling

What is Polling?

Polling is used when one fax machine requests another to send a document. This is useful when the person with the original document is not in the office. The person to receive the document calls the machine holding the original and requests that the document be sent. In other words, it "polls" the machine holding the original.

Polling Transmission

You can program the fax machine to send documents in your absence when polled by a remote fax machine. A polling code is used to prevent unauthorized polling of your machine. When you secure your machine in this manner, only those who know the poll code can poll your machine.

1. Load your document **face down** with the top edge first going into the document feeder, and adjust the resolution and contrast. For details, see page 3.8.
2. Press **Advanced FAX** on the front panel. The display shows the first menu; BROADCASTING.
3. Press ◀ or ▶ until 'SEND POLLING' appears, and press **Start/Enter** to access the Send Polling menu.
4. The display asks you to enter a 4-digit poll code. The poll code is preset to 0000 at the factory which represents no poll code.



POLLCODE [0000]

5. To use a poll code, enter the 4-digit code (except for 0000), then press **Start/Enter**. Or,

If you do not want to secure the transmission with a poll code, press **Start/Enter** when the display shows 0000 for the poll code, or press **0000**.

6. The display asks you to store the document in the machine's bulletin memory.



BULLETIN▶YES▶NO

7. Press ◀ or ▶ to highlight **YES** or **NO**, then press **Start/Enter**.

If you want to store the document in the bulletin board memory, select YES. More than one remote station can poll that document from your machine.

If not, the document will be automatically erased after being polled by a remote machine.

8. The machine stores the document in memory. The display counts the number of pages being stored in memory and the memory capacity remaining.

The machine returns to Standby mode and the display shows a reminder that a Polling Transmission is set. The machine automatically switches to FAX mode (automatic receiving) when set to be polled.

Polling Reception

You can set your machine to automatically receive documents from one or more unattended remote fax machines. This feature permits unattended polling in the evening hours when telephone rates are lower.

Note: The remote machine must be ready for polling.

1. Press **OHD/V.Reg** or pick up the handset and when you hear a dial tone, call the remote fax machine.
2. When you hear the fax tone, press **Advanced FAX**. Then, 'RECEIVE POLLING?' appears.
3. Press **Start/Enter**. The display asks you for a 4-digit code. Poll code '0000' represents no code.
4. If the remote machine is secured with a poll code, you must enter the correct code, and press **Start/Enter**. Or,

If the remote machine is not secured with a poll code, press **Start/Enter** to accept [0000] which represents no code.

5. The machine begins to receive polling.

Notes:

- To cancel the operation, press **Stop** at any time.
- Not all fax machines have polling capability, and polling incompatibility can occur between different manufacturers.

Adding Documents To a Scheduled Operation

You can add documents to the delayed transmission previously reserved in memory.

1. Load the document **face down**, and adjust Resolution, or Contrast, if necessary. For details, see page 3.8.
2. Press **Advanced FAX** on the front panel. The display shows the first menu; BROADCASTING.
3. Press ◀ or ▶ until 'ADD SCHEDULE' appears, and press **Start/Enter**. The display shows the operation, time and name currently reserved in memory.
4. Press ◀ or ▶ repeatedly until you find the operation to which you want to add documents, then press **Start/Enter**.

The machine automatically and stores the documents in memory, and the display shows the memory capacity and the number of pages.

5. After storing, the machine displays the total number of pages, then returns to Standby mode.

Cancelling a Scheduled Operation

1. Press **Advanced FAX** on the front panel. The display shows the first menu; BROADCASTING.
2. Press ◀ or ▶ until 'CANCEL SCHEDULE' appears, and press **Start/Enter**. The display shows the operation, time and number currently reserved in the memory.
3. Press ◀ or ▶ repeatedly until you find the operation you want to cancel, then press **Start/Enter**. The display asks you to confirm your selection.
4. Press **Start/Enter** to cancel the selected operation. The operation is deleted from memory.

Additional Functions

Sending a Recall (R or Flash)

Some special phone services require a switch-hook signal for proper operation. For example, if you have call-waiting, you can put a call on hold and take a second call on the same line by pressing **Recall(R or Flash)/Status**.

1. When you are on the telephone and hear the call waiting signal, press **Recall(R or Flash)/Status** once. The first caller is on hold and you are speaking to the second caller.
2. Press **Recall(R or Flash)/Status** again to talk to the first caller again.

Note: If you do not have a special service that uses the switch-hook signal, do not press **Recall(R or Flash)/Status** during a call. If you do, you could disconnect the line.

Monitoring a Dual Job Status

Your machine can perform more than one of many functions simultaneously. For example, you can;

- Receive a fax into the memory while making a copy.
- Store a fax document for later transmission while printing an incoming fax.

When the machine performs dual tasks, press **Recall(R or Flash)/Status** to see the current status on the display of the other operation. Each time you press **Recall(R or Flash)/Status**, the current status of the two operations displays alternatively.

Forwarding Received Faxes

You can forward all faxes which you receive during the specified period to a specified remote station. This can be useful when you are out of your work station and want to receive your faxes through another station.

Setting Time and Destination for Forwarding Faxes

To forward the received fax, you must define the remote fax machine where the fax is to be sent and the start time and end time of a period when the Fax Forward feature operates.

1. Press and hold down **Fax Forward** for about 2 seconds on front panel.
2. Enter the number of a designated fax machine to where the faxes are delivered using the ten number keypad.

You can also use one of one-touch dial button or a speed dial number.

Note: You cannot use the Group dial number for forwarding a fax.

3. When the correct number displays, press **Start/Enter**.
The displays prompts you to enter the start time.
4. Enter the date and time when the Fax Forwarding feature starts to operate and press **Start/Enter**.
The displays prompts you to enter the end time.
5. Enter the date and time when the Fax Forwarding feature ends and press **Start/Enter**.

Turning the Fax Forwarding Feature On or Off

Press **Fax Forward** on front panel to turn this feature on or off.

- If the LED is on, Fax Forwarding activates. All faxes delivered to your machine during the specified period will be automatically forwarded to a registered station.
- If the LED is off, Fax Forwarding deactivates.

Notes:

- If an error occurs during forwarding a fax, your machine will automatically redial the number every three minutes up to a maximum of two times, just like normal fax operation.
- The Sending Confirmation report showing time when faxes are forwarded, the designated fax number, the transmission result, the contents of the fax and so on will automatically print right before the end time.

Toll Save Fax

The Toll Save Fax feature will save your toll by storing the document in memory and sending it at the specified time during the toll save time slot, which is a period of time when your toll for the telephone call is reduced.

Setting Time for Toll Save Fax

1. Press and hold down **Toll** on the front panel.
The display asks to enter the time when the fax is to be sent.



2. Enter the time in 24-hour format using the number keypad.

Note: Toll save time slot may vary depending on the countries. Contact your telephone company.

3. Press **Start/Enter** when the correct time displays.
The displays shows briefly the time you have set, then returns to Standby mode.

Sending a Toll Save Fax

1. Press **Toll** on the front panel.

Note: If you have not set the toll save time, the display prompts you to set the time.

2. Load your document **face down** with the top edge first going into the document feeder. And adjust the resolution and contrast, if necessary. For details, see page 3.8.
3. Enter the number of the remote machine using the ten number keypad, one-touch button, speed dial or group dial.
4. Press **Start/Enter** on the front panel.
5. The document will be scanned into memory. The display shows the memory capacity and the number of pages being stored.

6. The machine returns to Standby mode and the display alternates between messages to remind that you are in Standby mode and that a Toll Save fax is scheduled.

The scanned document will be sent at the time which you have defined.

Notes:

- To cancel the Toll Save fax operation reserved in memory, see 'Cancelling a Scheduled Operation' on page 3.34.

Printing Reports

You can print help and reports containing useful information.

Notes: The list you have set to print out automatically will not print out when there is no paper loaded or a paper jam has occurred.

Help

Shows the machine's basic functions and commands and can be used as a quick reference guide.

Sent Journal

Shows information concerning fax transmission activities recently made.

Received Journal

Shows information concerning fax reception activities recently made.

Phonebook

Lists all numbers currently stored in memory as One-touch dial numbers, Speed dial numbers, and Group dial numbers.

Sending Confirmation

Shows the fax number, the number of pages, elapsed time of the operation, the communication mode, and the communication results. You can print the this confirmation report in one of the following ways according to your setting in System Setup(see page 3.3):

- Automatically after each transmission (ON)
- Automatically only if an error occurs during transmission (ERROR)
- No report printed at all (OFF). You can print this report manually.

Schedule Information

Shows the document currently stored for Delayed transmission, Priority transmission, Broadcasting, Send polling and Toll Save fax. The list shows the starting time, type of operation, etc.

System Data List

Shows the status of the user-selectable options. After you change any setting, print this list to confirm your changes.

Multi-Communication Report

Is printed automatically after sending documents to or receiving documents from more than one location.

Callback Message

Is printed out automatically when you do not respond to a remote operator's Voice Request.

Power Failure Report

Is printed out automatically when power is restored after a power failure. This report shows data erased by the power failure.

TO PRINT LISTS

1. Press **Report/Help** on the front panel. The display shows the first menu.



HELP

2. Press ◀ or ▶ until you find the list you want to print, then press **Start/Enter**. The selected list will be printed.

Group Dialling (for Multi-Address Transmission)

Multiple one-touch and speed dial numbers can be registered as a group. By using the group number, you can send a document to multiple parties in a single operation. The machine will dial the remote numbers in stored sequence. If the number is busy, the machine will dial the next stored number. After dialing all of the stored numbers, the unit will automatically redial any number that was busy. Before you can use this feature, you must program the group numbers desired.

Storing One-Touch or Speed Dial Numbers for Group Dialling

1. Press **Setup** on the front panel.
The display shows the first menu; FAX NUMBER/NAME.
2. Press ◀ or ▶ until 'GROUP DIAL SETUP' appears, and press **Start/Enter**.
3. Press one of the 20 one-touch buttons that you want to use for group dial.
4. The display asks you to confirm that you use this button for group dialing.



GROUP NO. : T15

Press **Start/Enter** to confirm.

If you do not want to use the one-touch number, press **Stop**.
Then, press another one-touch button.

Note: If the button you chose has already been used for one-touch dialing, the display warns the one-touch number is used.



T15 USED !

Then you are allowed to select 'OTHER' or 'RENEW' by pressing ◀ or ▶. To replace that number and continue, select **RENEW** and to start over with a different location, select **OTHER**. When the desired option is displayed, press **Start/Enter**.

5. The display asks you to press a one-touch button or to enter a 2-digit speed dial number that you wish to include in the group.
6. Press a one-touch button where the fax number you wish to include in the group is stored.
Or,
Enter a 2-digit speed dial location where the fax number you wish to include in the group is stored.
7. Press **Start/Enter**. The display shows the fax number which was stored in the selected location.
8. Repeat step 6 to 7 to enter additional numbers into the selected group.
9. Press **Start/Enter** when you have entered all the desired destinations. The display asks you to enter a name.
10. To assign a name to the group, enter the desired name. See page 3.19 for entering letters.
Or,
If you do not want to assign a name, skip this procedure.
11. Press **Start/Enter**. The display asks you to select a one-touch number for another group dial.
12. To continue storing, press the wanted one-touch button and repeat steps 4 through 11.
13. To stop storing, press **Stop**. The display returns to Standby mode.

Note: You cannot include one group dial number in another group dial number.

Editing Group Dial Numbers

You can edit one-touch or speed dial numbers stored for group dialling.

1. Press **Setup** on the control panel.
The display shows the first menu; FAX NAME/NUMBER.
2. Press ◀ or ▶ until you find 'GROUP DIAL SETUP', then press **Start/Enter**.
3. Press the one-touch group dial button used for the group dial number you want to edit.
4. Press ◀ or ▶ to select the option you want, then press **Start/Enter**.

Select **MEMBER ADD** to add a number, and enter as many numbers as needed. To stop entering numbers, press **Start/Enter**. Note that you cannot include one group number in another group dial number.

Select **MEMBER DELETE** to delete a number. When the number that you want to delete is displayed, press **Start/Enter**.

5. When you are finished editing, press **Stop**.

Sending a Fax Using Group Dialling (Multi-Address Transmission)

You can use Group Dialling for the Delayed Transmission or Memory Transmission.

Follow the procedure of the desired operation (Broadcasting transmission - p.3.28, Delayed transmission - p.3.29 and Toll Save transmission - p.3.37). When the display requests you to enter the remote fax number, press the one-touch button where you stored the group number. You can use only one group number for each operation. Continue the procedure to complete the desired operation.

The machine automatically scans the document into memory and dials each of the numbers included in the group.



Memo

chapter

4

Printing (S7-531P only)

Read this chapter to learn how to select and load print media and how to use the print settings.

The topics included in this chapter are:

Print Media

- ◆ Selecting Print Media
- ◆ Using the Automatic Paper Input Tray
- ◆ Using the Manual Paper Input Tray
- ◆ Specialty Paper Guidelines

Printing

- ◆ Printing a Document
- ◆ Cancelling a Print Job
- ◆ Printing Help
- ◆ Printing Several Pages Per Sheet
- ◆ Scaling Your Document
- ◆ Fitting Your Document to a Selected Paper Size
- ◆ Printing Posters
- ◆ Printing Watermarks
- ◆ Using Page Overlays
- ◆ Printing in a Network Environment

Print Media

Selecting Print Media

The type of media you select affects the performance and print quality.

Selecting Media Types

Most photocopy paper, postcards, index cards, transparencies, envelopes, and labels will work your printer, particularly paper that is marked for use in laser printers. For the best results, use one of the papers developed especially for an laser printer.

What to Consider

- **Desired outcome.** The paper you choose should be appropriate for the project. For example, use greeting card paper when making party invitations.
- **Size.** Choose any size paper that fits easily within the paper adjusters of the printer.
- **Weight.** Use 20~24-pound or 75~90 g/m² plain paper for multipurpose, everyday use.
- **Brightness.** Some papers are whiter than others and produce sharper, more vibrant colors. Use premium photo paper for documents with photographs. Use white paper for documents with any other pictures.
- **Surface smoothness.** The smoothness of the paper affects how crisp the printing looks on the paper. Glossy, coated paper works well for pictures and charts where you want crisp lines.

Get the Right Paper

Your Samsung SF-530 series is designed to work well on most common office paper types and with quality 25% cotton bond paper. Because your printer uses toner to produce an image, paper that accepts toner produces the best results. Be sure to test a variety of paper types before buying large quantities.

Paper that Might Not Work

- Highly textured stock, such as linen, may not print evenly because the toner can bleed.
- Extremely smooth, shiny, or coated papers not specifically designed for laser printers can jam the printer and repel toner.
- Multi-part forms, such as duplicate or triplicate forms can wrinkle and jam; the toner is also more likely to smear.
- Paper in poor condition — with tears, dust, wrinkles, curled or bent edges, or that doesn't lie flat can jam the printer.
- Envelopes with thick or crooked edges; envelopes that are damaged, curled, wrinkled, or irregularly shaped; envelopes that are shiny or embossed; or envelopes with clasps or windows.

Selecting Media Sizes

The paper input tray can hold **up to 150 sheets** of 20 lb (75 g/m²) paper. The single-sheet manual input tray is designed to hold one sheet. Both can be adjusted to hold media measuring **from 3.87 by 6.38 inches** (98.5 by 162 mm) **to 8.5 by 14 inches** (216 by 356 mm). This includes, but is not limited to, the following paper and envelope sizes:

• A4:	8.25 by 11.75 in; 210 by 297 mm
• A5:	5.82 by 8.25 in; 148 by 210 mm
• B5:	7.16 by 10.12 in.; 182 by 257 mm
• Letter:	8.5 by 11 in; 216 by 279 mm
• Folio:	8.5 by 13 in; 216 by 330 mm
• Legal:	8.5 by 14 in; 216 by 356 mm
• Executive:	7.25 by 10.5 in; 184 by 267 mm
• No.10 Envelopes:	4.12 by 9.5 in; 105 by 241 mm
• DL Envelopes:	4.33 by 8.66 in.; 110 by 220 mm
• C5 Envelopes:	6.38 by 9.01 in.; 162 by 229 mm
• C6 Envelopes:	4.49 by 6.38 in.; 114 by 162 mm
• B5 Envelopes:	6.93 by 9.84 in.; 176 by 250 mm
• Monarch Envelopes:	3.87 by 7.5 in; 98.5 by 190.5 mm

 **Note:** Insert all media vertically (portrait orientation) into the paper input tray or single-sheet manual input tray. To print horizontally (landscape orientation), make this selection through software. Do not print on paper smaller than 3.87 by 6.38 inches (98.5 by 162 mm).

Using the Automatic Paper Input Tray

You can stack paper or transparencies in the automatic paper tray to feed automatically. The automatic tray can hold a maximum of 150 sheets of plain paper. The maximum capacity may be reduced depending on the thickness.

For best results, adjust the paper settings each time you change paper (see page 4.10).

Note: If you experience feeding problems, try printing one at a time from the manual input tray. See page 4.5.

1. Pull the paper input support completely out of the unit.

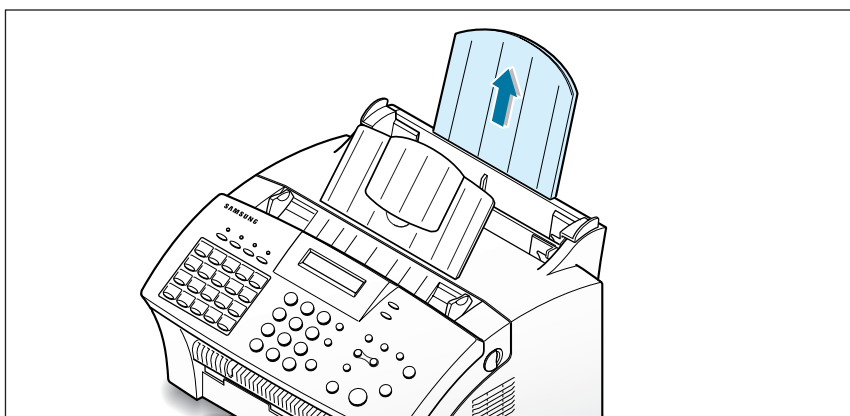

2. Prepare the print material for loading.

- **For paper:**

- Flex or fan the paper back and forth. Do not fold or crease the paper. Straighten the edges on a level surface.

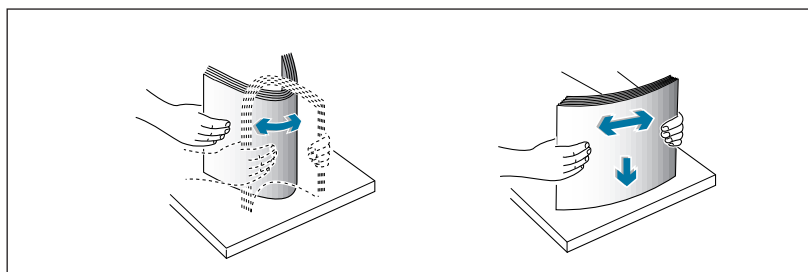

- **For transparencies:**

- Hold the transparencies by the edges and avoid touching the print side.
- Fan the stack of transparencies to prevent feeding failures. Be careful not to scratch or leave fingerprints on the print sides.

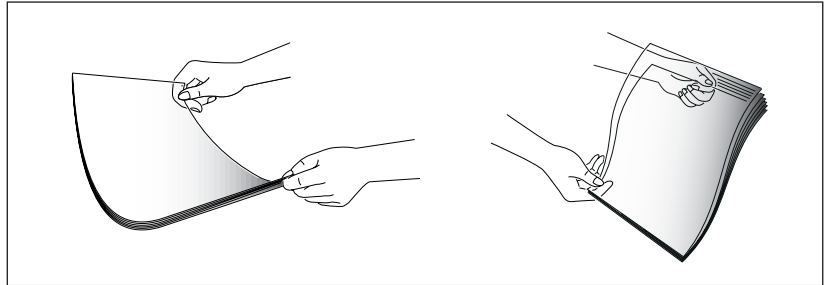

3. Load the print material into the paper tray. Load only as much paper as will fit beneath the lip protruding from the paper-length adjuster. Neatly stacking the paper before loading will help prevent print problems. Do not mix types. See the following directions to load each type of print material.

- Load paper with the print side facing up.

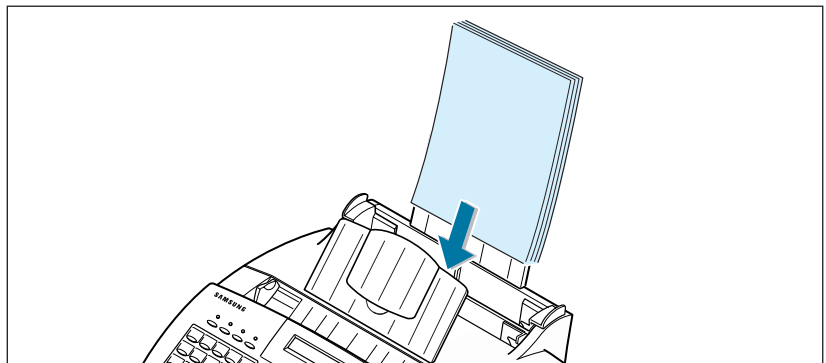

- Load letterhead paper **face up with the top of the page going into the tray first.**

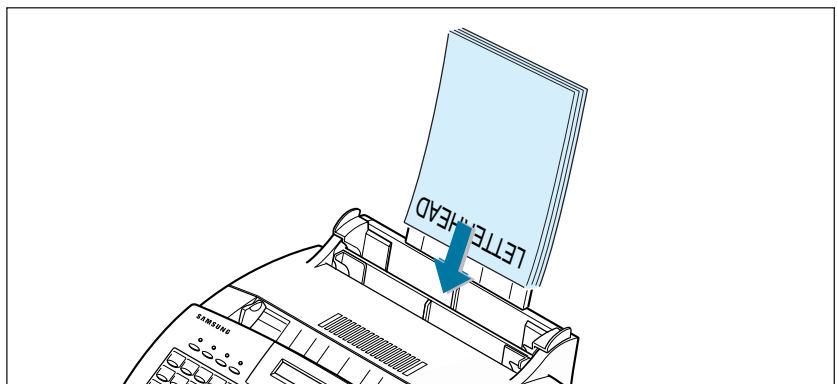

- Slide both paper adjusters to fit against the paper's edges. **Ensure the paper line flat in the tray.**

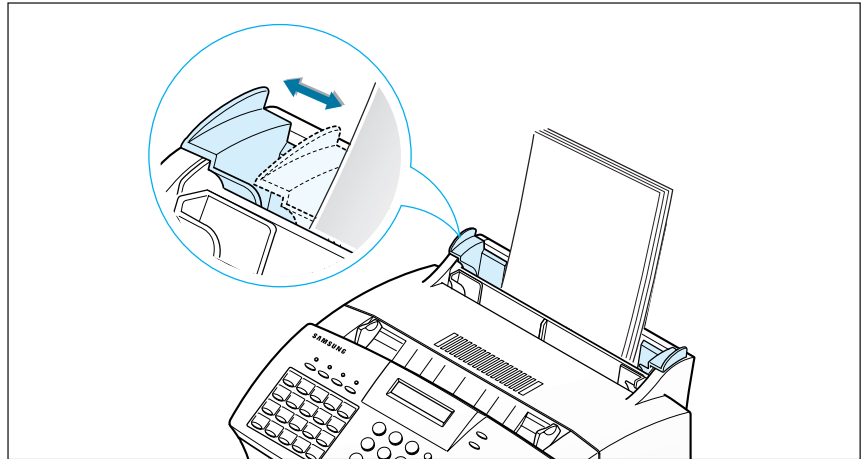

Print Side Up

Most papers prints better on one side than on the other. This is especially true for coated or specially treated paper. The print side is usually indicated on the paper package. Be sure to insert the paper into the paper tray of the printer with the **print side up**.

Using the Manual Paper Input Tray

To load a single envelope, card stock, or specialty paper, use the manual paper input tray. When you use the manual input tray, you must feed one piece of media at a time. Manual feeding is helpful when printing on heavy paper or when experiencing paper jam with the automatic paper input tray.

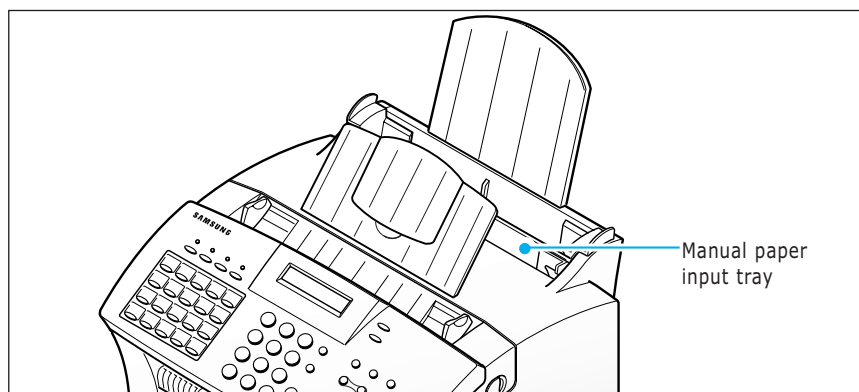

Notes:

- Make sure that you select the **Manual** for **Paper Source** and the correct paper size and type from your software application before starting your print job. See page 4.10.
- When you use the manual paper tray, the paper must be loaded in the automatic paper tray. By doing so, you can prevent the paper jam which might occur in the manual tray.

1. Place the print media in the manual input tray with print side facing up and adjust the paper guides to the width of the print media.

- Load a sheet of the envelope **with the flap side facing away from you**. Make sure that the stamp area is at the top left and the end of the envelope with stamp area enters the tray.

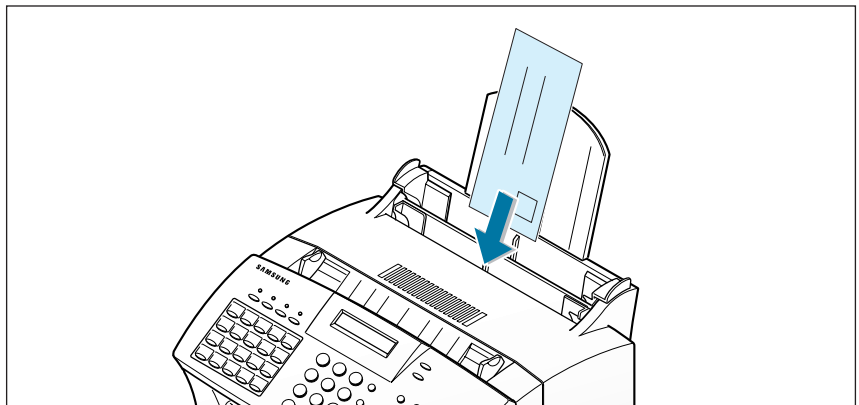

- Load transparencies **face up with the adhesive strip on top going into the tray first**.

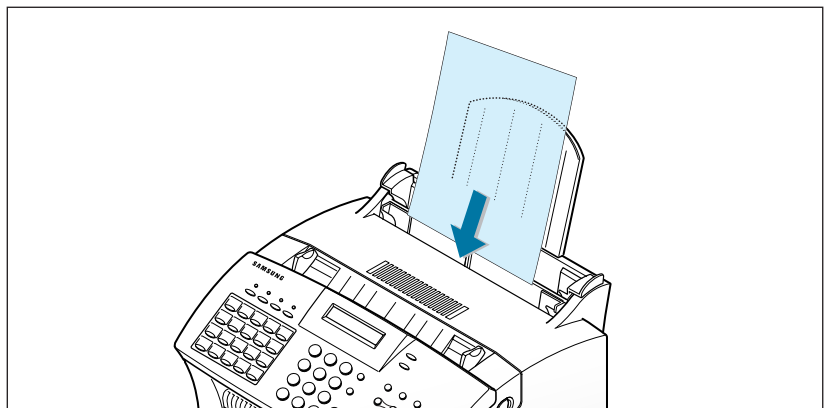

- Load a sheet of the label **with the adhesive backing facing away from you.**

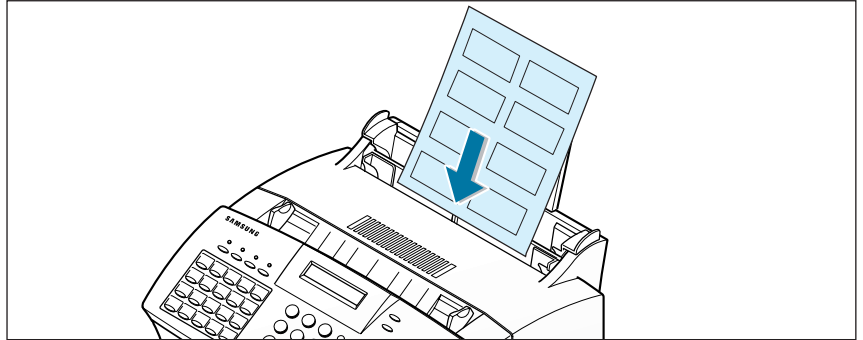

- Load a sheet of the card stock **with print side up, short edge first.**

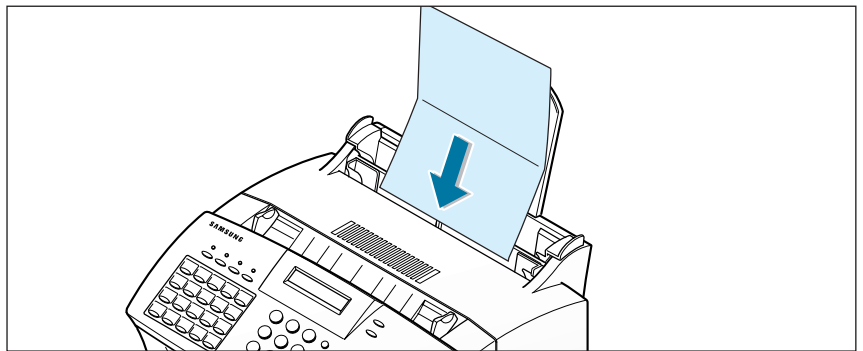

2. In your computer, start printing of the document. the display on the front panel displays 'PC PRINTING...' and 'PRESS START.'
3. Press **Start/Enter** to start manual feeding. If you have more than one page to print, press **Start/Enter** for each page.

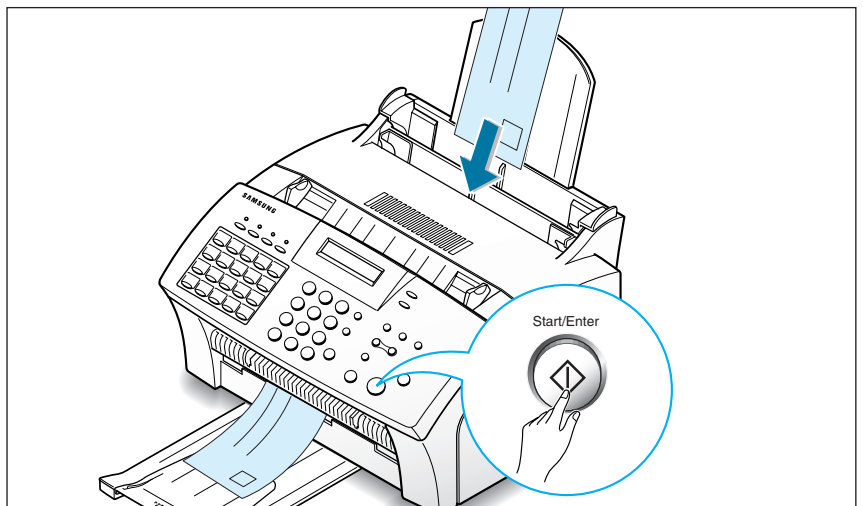

Specialty Paper Guidelines

- Read all instructions that come with special paper for important information regarding how to achieve the highest print quality.
- It is recommended to feed one sheet at a time for special paper types.
- For transparency film, follow these guidelines:
 - Let printed sheets of film dry completely before storing.
 - When a sheet of film has dried completely, cover its printed side with a sheet of plain (not coated) paper before storing; This is recommended even if placed in a clear file or plastic holder.
 - Do not leave the film in the paper tray for long periods of time as dust and dirt may accumulate, resulting in poor copy quality.
 - To avoid fading, do not expose the printed film to prolonged direct sunlight.
 - Store unused papers and films flat. Do not remove papers from their protective packaging until ready for use.
 - Store unused film at temperatures between 59°F to 86°F (15°C to 30 °C). The relative humidity should be between 10% and 70%.
- For labels, follow these guidelines:
 - Verify that the labels' adhesive material can tolerate fusing temperature of 200°C (392°F) for 0.1 second.
 - Make sure that there is no exposed adhesive material between the labels. Exposed areas can cause labels to peel off during printing, which can cause paper jams. Exposed adhesive can also cause damage to printer components.
 - Do not feed a sheet of labels through the printer more than once. The adhesive backing is designed for one pass through the printer.
 - Do not use labels that are separating from the backing sheet or are wrinkled, bubbled, or otherwise damaged.
- If the print density of your page is very high, light paper stock may curl slightly due to the large amount of toner. To print dense graphics, try printing on heavier stock.
- Do not use paper that is thicker than the specifications as it may damage the toner cartridge.

Printing

Printing a Document

The following procedure describes the steps required for printing from various Windows applications. The exact steps for printing a document may vary depending on the application program. Refer to your software application's documentation for the exact printing procedure.

1. Start the program to create the document, and open the document you want to print.
2. Select **Print** from the **File** menu. You see the Print dialogue box for your application (the Print dialogue box for your application may look slightly different).

The basic print settings you required are usually selected within the Print dialogue box. These settings include the number of copies, paper size, and page orientation.

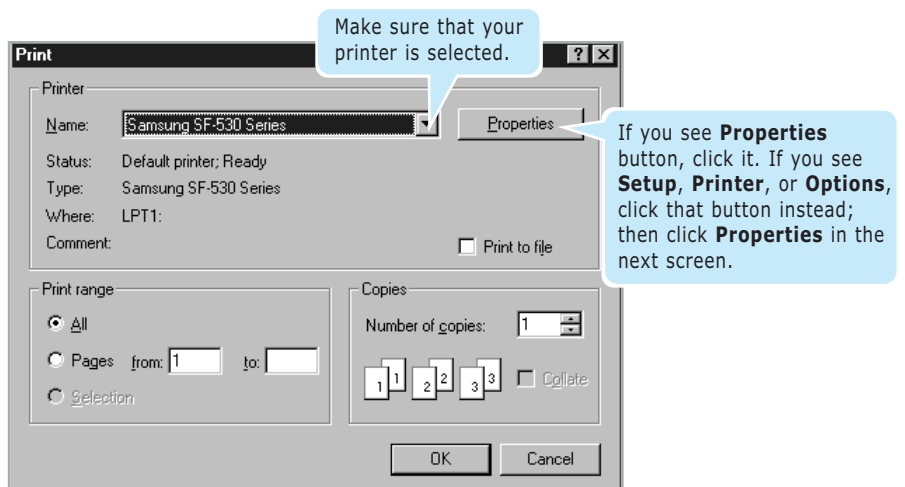

3. To take advantage of the printer features provided by the SF-530 series, click **Properties** in the application's Print dialogue box and go to step 4.

If you see **Setup**, **Printer**, or **Options**, click that button instead. Then click **Properties** in the next screen.

4. The dialogue box allows you to access all information necessary for using your printer.

If necessary, click the **Paper** tab to display the settings shown below. The Paper tab contains the options for setting the basic paper handling.

Select the number of copies to be printed.

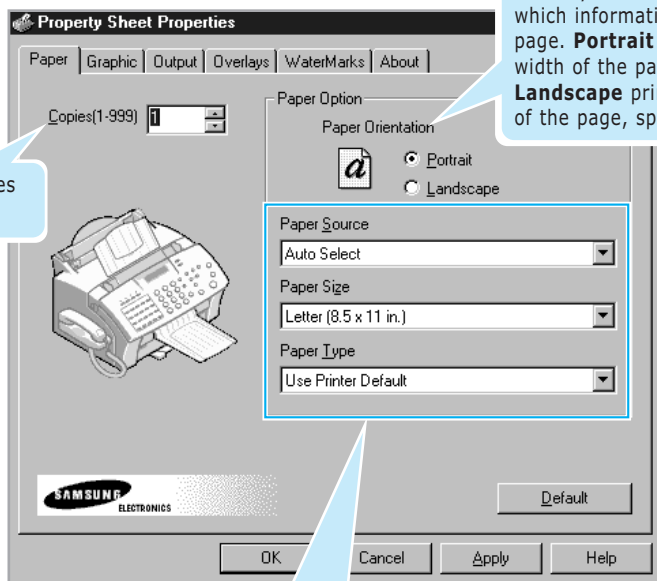

The **Paper Orientation** option allows you to select the direction in which information is printed on a page. **Portrait** prints across the width of the page, letter style. **Landscape** prints across the length of the page, spreadsheet style.

- **Paper Source:** Make sure the **Paper Source** is set to **Auto Select**. If you use the manual input slot on the back of the printer (see page 4.5), select **Manual**.
- **Paper Size:** Select the paper size you have loaded in your printer.
- **Paper Type:** The **Paper Type** option allows you to select the paper type you want to use.

5. If you want to change the setting for print quality, click the **Graphic** tab.

The **Resolution** option allows you to select the print resolution. The higher the setting, the sharper the clarity of printed characters. Higher settings may increase the time it takes to print a document.

The **Toner Save Mode** option allows the printer to use less toner on each page.

- **Printer Setting:** this feature is determined by the setting you've made on the control panel of the printer.
- **Standard:** does not save toner to print a document.
- **Save:** allows the printer to use less toner on each page.

Note: You can turn this feature on or off by the **Toner** button on the front panel (see page 1.22). The setting on the printer's properties will override the setting on the front panel.

- **Altitude Correction:** To optimize print quality, the **Altitude Correction** should be checked for high place.
- **Dark Text:** When the **Dark Text** is checked, all text in your document is allowed to print darker than normal document.
- **All Text to Black:** When the **All Text to Black** is checked, all text in your document is allowed to print solid black, regardless of the color it appears on the screen. When it is not checked, colored text is allowed to print in shades of gray.

6. When you complete changing print settings, click **OK** until you see the Print dialogue box again.

7. Click **OK** to start printing.

Notes:

- Most Windows applications will override settings you specify in the printer driver. Change all print settings available in the software application first, and any remaining settings with the printer driver.
- The settings you change here remain in effect while you are using the current program. **To make your changes permanent**, make them in the Printers folder as follows:

1. Click the Windows **Start** button.
2. Select **Settings**, then **Printers** to open the Printers window.

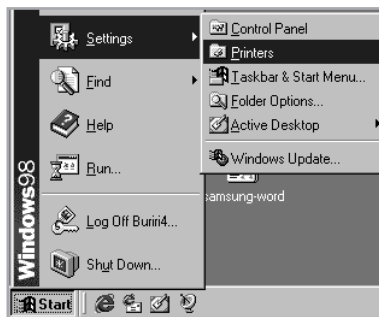

3. Select the **Samsung SF-530 Series**.
4. Click the right mouse button and select **Properties** to open the properties window.

Cancelling a Print Job

There are two ways to cancel a print job:

- If your print job has not started to print, cancel from the print spooler in Windows 95, 98, Me or NT 4.0.
- If your print job is currently printing, press **Stop** twice on the front panel of your printer.

CAUTION: If a fax job is currently being transmitted or received, this procedure will also clear it.

Printing Help

Samsung SF-530 series printer has the help screen that can be activated from the **Help** button in the printer properties dialogue box. These help screens give detailed information about the printer features provided by the SF-530 series printer driver.

From the upper right hand corner, click  then click on a setting for more information.

To restore default printer properties setting when you change the print settings, click **Defaults** in the properties dialogue box.

Printing Several Pages Per Sheet

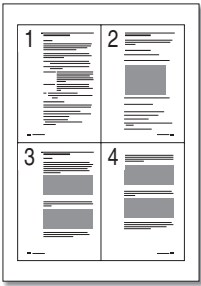

Your printer is equipped with an option that prints several pages on one sheet of paper by reducing the size of each page and organizing them in rows and columns.

1. Load letter or A4 paper into the paper input tray.
2. To change the print settings from your software application, access the printer properties. See page 4.9 to access the printer properties. From the **Paper** tab, select the paper orientation, source and size.
3. Click the **Output** tab, and choose **Multiple Pages Per Sheet** in the **Type** drop down list under the **Output Mode** section.
4. Select the number of pages to print per sheet (2, 4, 9, or 16) in the **Pages per sheet** drop-down list. When you make a selection, the graphic above the option changes to show how the printed page will look.
5. Click **Print Page Borders** when you want each page image in your document to print with a border.

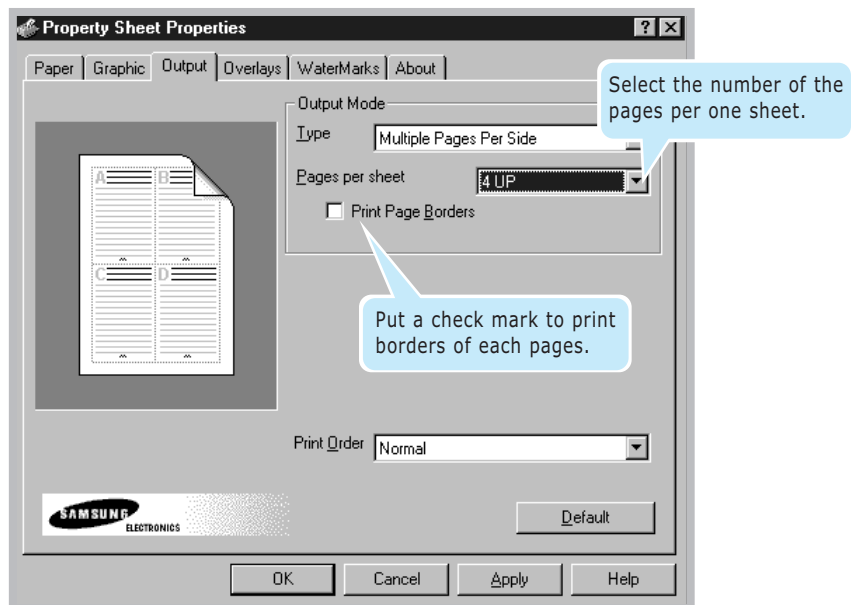

6. Click **OK**, then start printing.

Scaling Your Document

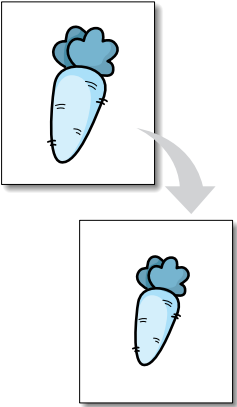

This printer feature allows you to scale your print job on a page.

1. When you change the print settings from your software application, access the printer properties. See page 4.9 to access the printer properties.
2. Click the **Output** tab, and select **Scale Printing** in the **Type** drop down list under the **Output Mode** section.
3. Enter the desired scaling rate in the Scale input field.

You can also click the ▲ or ▼ buttons.

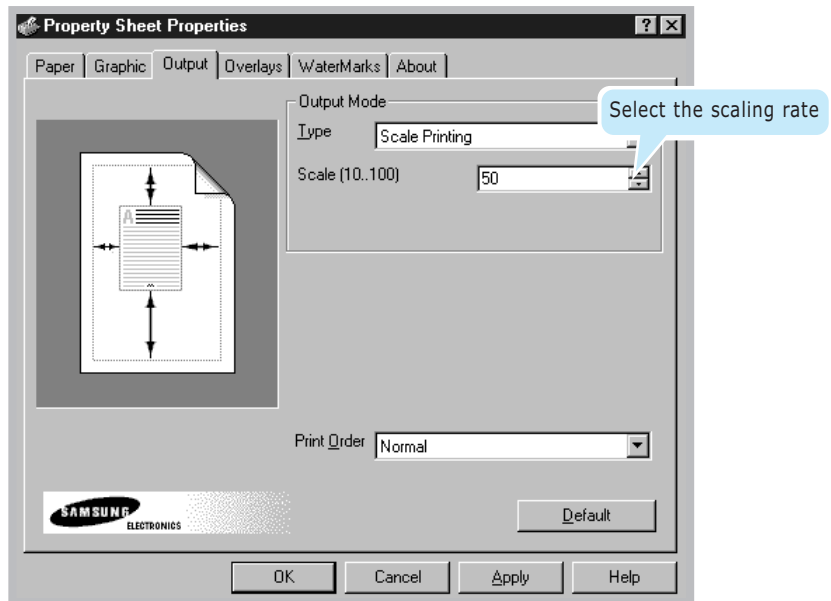

4. Click **OK**, then start printing.

Fitting Your Document To a Selected Paper Size

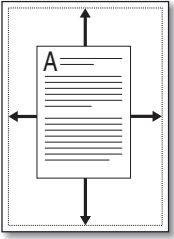

This printer feature allows you to scale your print job to any selected paper size regardless of the digital document size. This can be useful when you want to check fine details on a small document.

1. When you change the print settings from your software application, access the printer properties. See page 4.9 to access the printer properties.
2. Click the **Output** tab, and select **Fit to Page** in the **Type** drop down list under the **Output Mode** section.
3. You'll see the Application page size and be prompted to select the Fit to Paper Size. Select the correct size from the drop-down list.

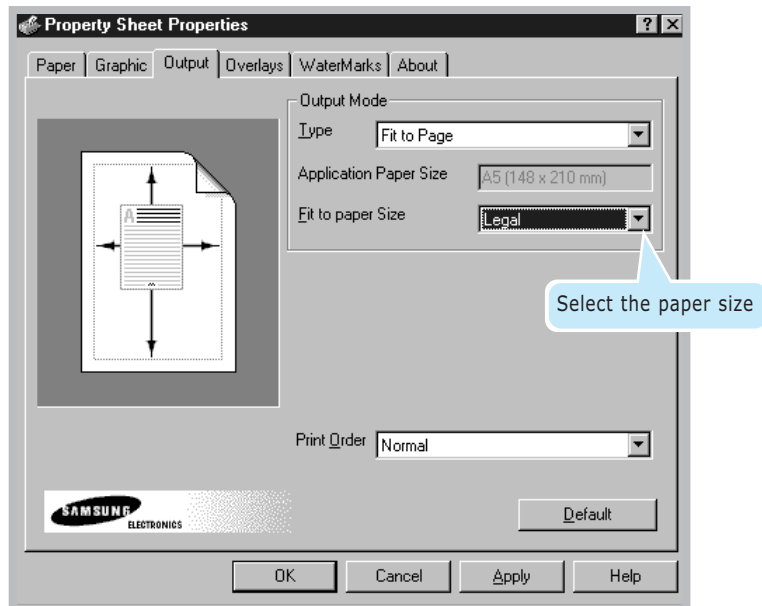

4. Click **OK**, then start printing.

Printing Posters

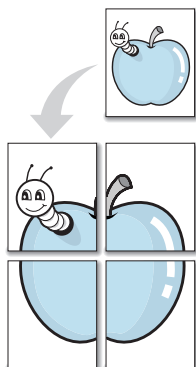

This feature allows you to print a single-page document onto up to 16 sheets of paper which can be pasted together to form one poster-size document.

1. To change the print settings from your software application, access the printer properties. See page 4.9 to access the printer properties.

From the **Paper** tab, select the paper orientation, source and size.

2. Click the **Output** tab, and **Poster Printing** in the **Type** drop down list under the **Output Mode** section.

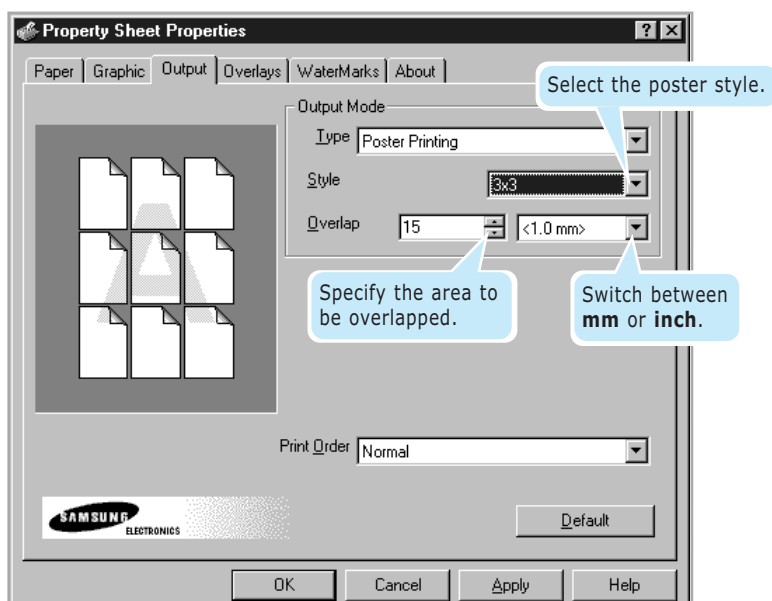

3. To determine the scaling factor, select the Style; 2x2, 3x3 or 4x4.

For example, if you select 2x2, the output will be automatically stretched to cover 4 physical pages.

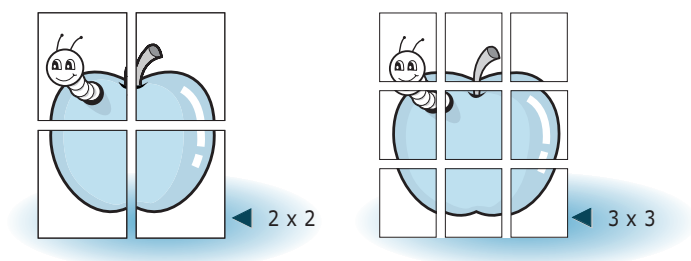

- You may specify an overlap in millimeter or inch to make it easier to reconstruct the resulting poster.

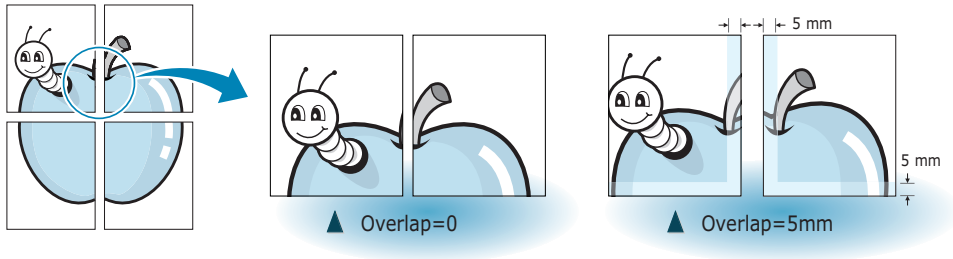

- Click **OK**, then start printing.

Printing Watermarks

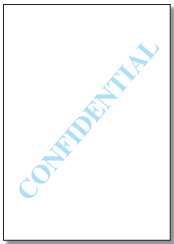

The Watermark option allows you to print text over an existing document. For example, you may want to have large gray letters reading “Draft” or “Confidential” printed across the first page or all pages of a document.

There are several predefined watermarks that come with the SF-530 series, and they can be modified or you can add new ones to the list.

To use an existing watermark

- When you change the print settings from your software application, access the printer properties. See page 4.9 to access the printer properties.
- Click the **Watermark** tab, and select the desired watermark in the **Message** drop-down list. You will see the selected watermark in the preview window.

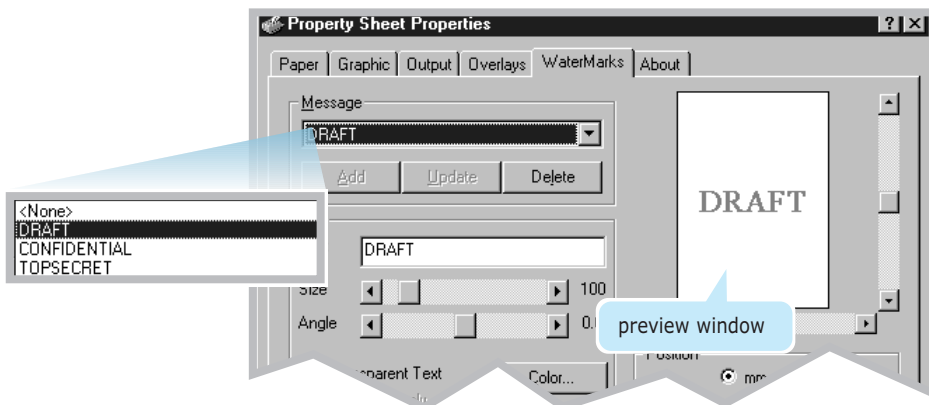

- Click **OK**, then start printing.

To create or edit a watermark

1. When you change the print settings from your software application, access the printer properties. See page 4.9 to access the printer properties.
2. Click the **Watermark** tab, and enter the desired text message in the Text field. This will be displayed in the preview window. The preview window is provided so that you can see how the watermark will appear on the printed page.
3. Select the desired watermark options. You can select the font type and size, color and angle. There are three checkboxes at the bottom of the dialog box:
 - **Transparent Text** – Allows the document to show through the watermark.
 - **As Outline Only** – Prints the text outline of the watermark. This setting globally effects all watermarks in the list.
 - **On First Page Only** – Prints the watermark only on the first page.

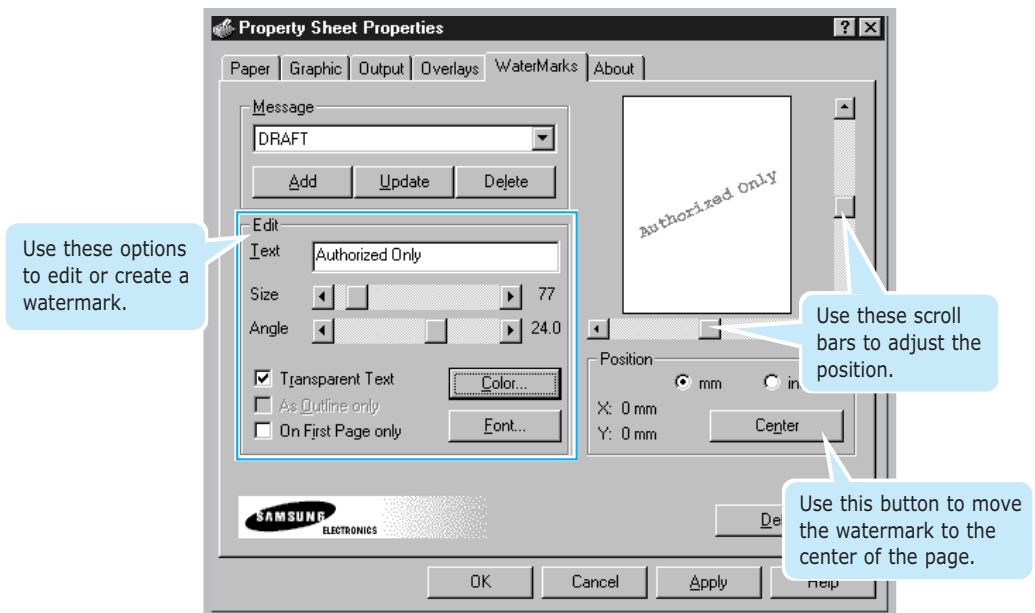

4. If you have created a new or edited an existing watermark, the **Add** and **Update** button is enabled.

To add a new watermark to the list, click **Add**.

5. If you want to edit, select the desired watermark from the list, edit, then click **Update**.

6. When you complete the edit, click **OK**, then start printing.

To stop printing the watermark, select **None** in the Message drop-down list.

To delete a watermark

1. When you change the print settings from your software application, access the printer properties. See page 4.9 to access the printer properties.
2. From the Watermark tab, select the watermark you want to delete in the Messages drop-down list.
3. Click **Delete**.
4. Click **OK**.

Using Page Overlays

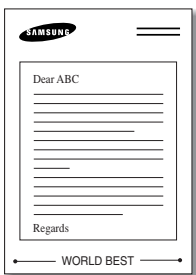

What is an Overlay?

An overlay is text and/or images stored in the computer HDD as a special file format that can be printed on any document you choose. Overlays are often used to take the place of preprinted forms and letterhead paper. Rather than using preprinted letterhead, for example, you can create an overlay containing the exact same information as is currently on your letterhead. Then when you want to print a letter with your company's letterhead, you do not need to load preprinted letterhead paper in the printer. You need only to tell the printer to print the letterhead overlay on your document.

Creating a New Page Overlay

To use a page overlay, you must create a new page overlay containing your logo or image.

1. Create or open a document containing a text or image you want to use for page overlay. Position the items exactly as you wish them to appear when printed as an overlay. If needed, save the file for later use.
2. Select **Print** from the **File** menu. Then click **Properties** in the application's Print dialog box to access the printer properties. For details, see page 4.9.
3. Click the **Overlays** tab, and click **Create Overlay**.

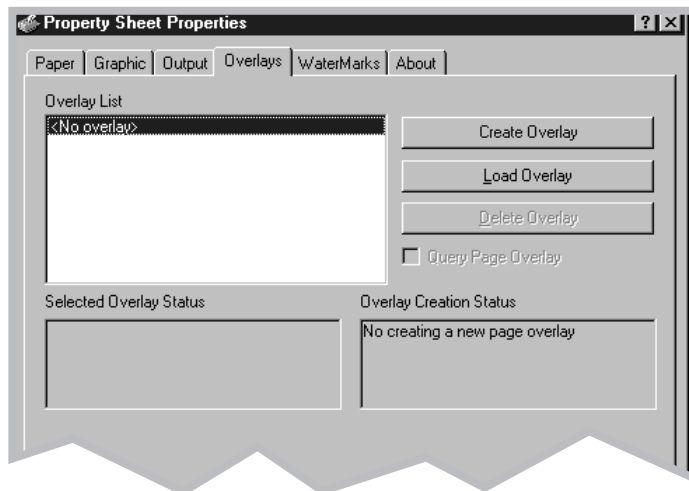

4. In the Create Overlay dialog box, type a name of up to eight characters in the File name box. Select the destination path if necessary.

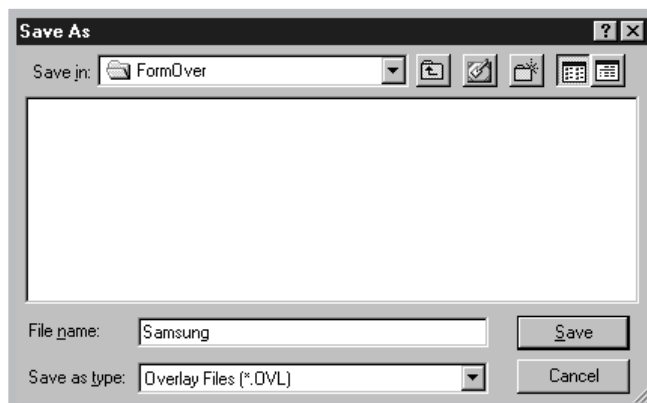

5. Click **OK**. You will see the name in the Overlay List box.
6. Click **OK** or **Yes** until you complete the creation.

The file is not printed out. Instead it will be stored on your computer HDD disk.

Note: The overlay document size must be the same as documents you will print with the overlay.

Using Page Overlay

After an overlay has been created, it is ready to be printed with your document. To print an overlay with a document:

1. Create or open the document you want to print.
2. When you change the print settings from your software application, access the printer properties. See page 4.9 to access the printer properties.
3. Click the **Overlays** tab, and select the desired overlay from the Overlay List box.
4. If the desired overlay file does not appear in the Overlay List box, click **Load Overlay**, and select the overlay file.

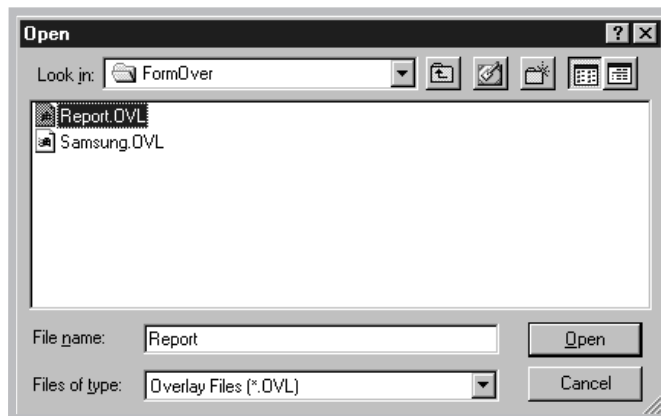

If you have stored the overlay file you want to use into an external source, you can also load the file when you access this Load Overlay window.

After you select the file, click **OK**. The file is now shown in the Overlay List box and is available for printing. Select the overlay from the Overlay List box.

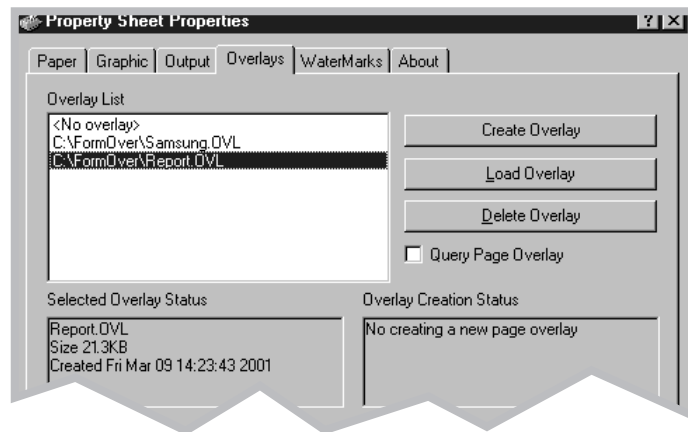

5. If necessary, click the **Query Page Overlay** check box. If this box is checked, a message box will appear each time you submit a document for printing, asking you to confirm your wish to print an overlay on your document.

Answering **Yes** to the message box means that the selected overlay will be printed with your document.

Answering **No** to the message box cancels overlay printing.

If this box is empty, and an overlay has been selected, the overlay will be automatically printed with your document.

6. Click **OK** or **Yes** until the printing starts.

The selected overlay will be downloaded with your print job and printed on your document.

Deleting a Page Overlay

You can delete page overlays that are no longer used.

1. In the printer properties dialog box, click the **Overlays** tab.
2. Select the overlay you want to delete from the Overlay List box.
3. Click **Delete Overlay**.
4. Click **OK** until you exit the Print dialog box.

Printing in a Network Environment

If you work in a network environment, you can connect your SF-530 series printer directly to a selected computer (called the "host computer") on the network. The printer can then be shared by other users on the network through a Windows 9x, Me, NT 4.0 or 2000 network printer connection.

Note: You need to install the Samsung SF-530 Series printer driver on each computer that will print documents to the printer.

Setting Up Host Computer

1. Start Windows.
2. From the **Start** menu, select **Control Panel**, and double-click on the **Network** icon.
3. Check the **File and Print Sharing** box, then click **OK**. Close the window.
4. Click **Start** and select **Printers** from **Settings**, then double-click your printer name.
5. Select **Properties** in the Printers menu.
6. Click the **Sharing** tab, then check the **Shared As** box. Fill in the **Shared Name** field, then click **OK**.

Setting Up Client PC

1. Right-click the **Start** menu, and select **Explorer**.
2. Open your network folder in the left column.
3. Right-click the shared name, and select **Capture Printer Port**.
4. Select the port you want, check the **Reconnect at log on** box, then click **OK**.
5. From the **Start** menu, select **Settings**, then **Printers**.

6. Double-click your printer icon.
7. From the **Printers** menu, select **Properties**.
8. Press the **Details** tab, select the printer port, then click **OK**.

Printing a Document

Print your document following the procedures described in page 4.9.

chapter

5

Maintenance

This chapter provides suggestions for high-quality and economical operating and information for maintaining the toner cartridge and the machine.

The topics included in this chapter are:

- ◆ Guidelines for Maintenance
- ◆ Clearing Memory
- ◆ Cleaning the OPC Drum
- ◆ Adjusting Shading
- ◆ Setting the Machine to be checked by Phone
- ◆ Sending Toner Low Information to the Service Company
- ◆ Cleaning the Machine
- ◆ Managing the Toner Cartridge
- ◆ Automatic Document Feeder Rubber Pad Replacement

Guidelines for Maintenance

For optimal performance of the SF-530 series, follow these guidelines:

- Place the machine on a stable surface.
- Do not install your machine near devices that contain magnets or generate magnetic fields, such as speakers.
- Keep your machine clean. Dust accumulation can prevent the unit from operating properly.
- For your safety, unplug the power cord from the machine during electrical storms.
- Lift the machine from the bottom only. Do not lift the unit by the front panel or any of the trays.

Clearing Memory

You can selectively clear information stored in your machine's memory.

1. Press **Setup** on the control panel. The display shows the first menu; FAX NUMBER/NAME.
 2. Press ◀ or ▶ until 'MEMORY CLEAR' appears, then press **Start/Enter**. The display shows the items you can clear.
 - **FAX NUMBER/NAME**: your fax number and name are cleared from the machine's memory.
 - **DIAL/SCHEDULE**: clears the one-touch, speed dial, or group dial numbers stored in the memory. In addition, all the Schedule Job operations you have reserved are also cancelled.
 - **JOURNAL**: clears all records of transmissions & receptions.
 - **DEFAULT SETUP**: restores all the option settings to factory default.
 3. Press ◀ or ▶ until you find the item you want to clear, then press **Start/Enter**. The display asks you to confirm your selection.
 4. Press **Start/Enter** to confirm. The selected memory is cleared, then the display asks you to continue clearing the next item.
 5. Repeat steps 3 through 5 to clear another item.
- Or, to return to Standby mode, press **Stop**.

Cleaning the OPC Drum

If you are getting streaks or spots on your print, you may clean the OPC drum.

1. Make sure that the paper is loaded in the automatic input tray.
2. Press **Setup** on the control panel.
The display shows the first setup menu; FAX NUMBER/NAME.
3. Press ◀ or ▶ until 'MAINTENANCE' appears, then press **Start/Enter**.
4. The display shows the first menu, 'CLEAN DRUM', then press **Start/Enter**.

The machine automatically pulls in a sheet of paper, and prints it out. The toner particles on the OPC drum surface are fixed to the paper.

5. Press **Stop** to return to Standby mode.

Adjusting Shading

The scanning unit becomes dirty, it can alter the shading value. If your print has black lines or is blurred, adjust the shading setting. Take the following steps:

1. Load a sheet of white paper into the document feeder.
2. Press **Setup** on the front panel.
The display shows the first setup menu; FAX NUMBER/NAME.
3. Press ◀ or ▶ until 'MAINTENANCE' appears, then press **Start/Enter**.
The display shows the first menu; CLEAN DRUM.
4. Press ◀ or ▶ until you find 'ADJUST SHADING', then press **Start/Enter**.

The white paper is scanned through the document feeder.

Setting the Machine to be Checked by Phone

The Remote Test feature allows your machine to be checked out by a service company at a remote place by phone.

1. Press **Setup** on the control panel.
The display shows the first setup menu; FAX NUMBER/NAME.
2. Press ◀ or ▶ until 'MAINTENANCE' appears, then press **Start/Enter**.
The display shows the first menu; CLEAN DRUM.
3. Press ◀ or ▶ until you find 'REMOTE TEST', then press **Start/Enter**.
4. Press ◀ or ▶ to turn this feature ON or OFF, then press **Start/Enter**.

If you want to protect your machine from being opened by an unauthorized person, select OFF.

5. Press **Stop** to return to Standby mode.

Sending Toner Low Information to the Service Company

If you have set this Notify Toner Low menu option to ON, when the toner cartridge needs to be replaced, your machine automatically sends a fax to your service company or the dealer to notify them that your machine requires a new toner cartridge. This feature will be activated only when the phone number of the service company or the dealer is stored in your machine's memory by technician. Ask your dealer for more information.

1. Press **Setup** on the control panel.
The display shows the first setup menu; FAX NUMBER/NAME.
2. Press ◀ or ▶ until 'MAINTENANCE' appears, then press **Start/Enter**.
The display shows the first menu; CLEAN DRUM.
3. Press ◀ or ▶ until you find 'NOTIFY TONER LOW', then press **Start/Enter**.
4. Press ◀ or ▶ to turn this feature ON or OFF, then press **Start/Enter**.
5. Press **Stop** to return to Standby mode.

Cleaning the Machine

To maintain print quality, follow the cleaning procedures below every time the toner cartridge is replaced or whenever print quality problems occur. As much as possible, keep your machine free from dust and debris.

Note:

- Do not use ammonia-based sprays or volatile solvents such as thinner to clean the machine, as these can damage the machine's surface.
- While cleaning the inside of the machine, be careful not to touch the transfer roller (located underneath the toner cartridge). The oil from your hands on the roller can cause print quality problems.

Cleaning the Outside

Wipe the outside surfaces of your machine with a soft, clean, and lint-free cloth. You can dampen the cloth slightly with water, but be careful not to let any water drip onto the machine or inside it.

Cleaning the Inside

During the printing process, paper, toner, and dust particles can accumulate inside the machine. Over time, this buildup can cause print quality problems such as toner specks or smearing. Cleaning inside the printer will eliminate or reduce these problems.

1. Turn the machine off and unplug the power cord, then wait for the machine to be cool.
2. Pulling the cover release buttons toward you, open the cover and remove the toner cartridge.

Note: To prevent damage to the toner cartridge, do not expose it to light for more than a few minutes. Cover it with a piece of paper, if necessary.

3. With a dry, lint-free cloth, wipe away any dust and spilled toner from the toner cartridge area and the toner cartridge cavity.

Cleaning the Document Scanner

To keep your machine working properly, occasionally clean the white roller, ADF rubber, and the scanning glass.

Note: Do not turn the power off to clean the scanner, as documents stored in the memory will be lost.

1. Lift the front panel by grabbing the panel along the top edge and open the cover.
2. Disassemble the white roller as follows:
Pull the handle of the bushing on the end of the roller slightly outward(A), rotate it until it reaches a slot(B), then pull the roller upward.

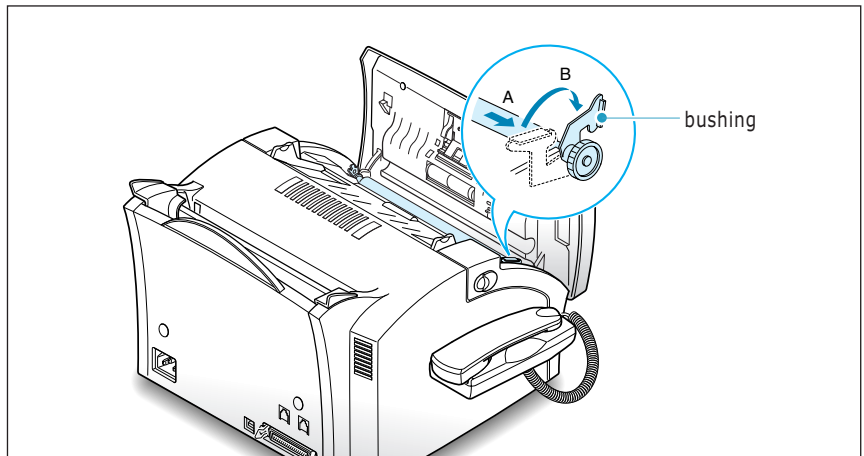

3. Wipe the roller surface with a soft cloth dampened with water.

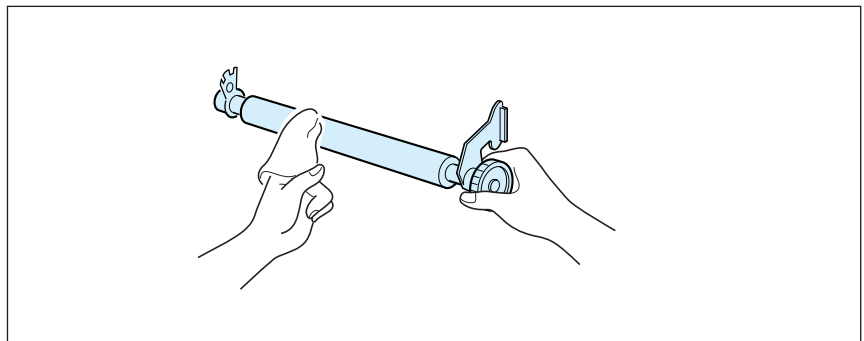

4. Clean the ADF rubber piece.

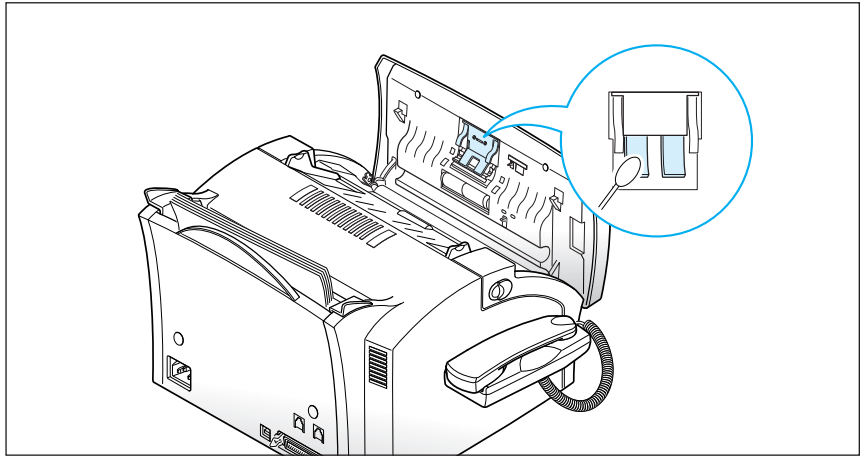

5. Carefully wipe the scanning glass with a soft, dry cloth.

If the glass is very dirty, first wipe it with a slightly dampened cloth, then with a dry cloth. Be very careful not to scratch the glass surface.

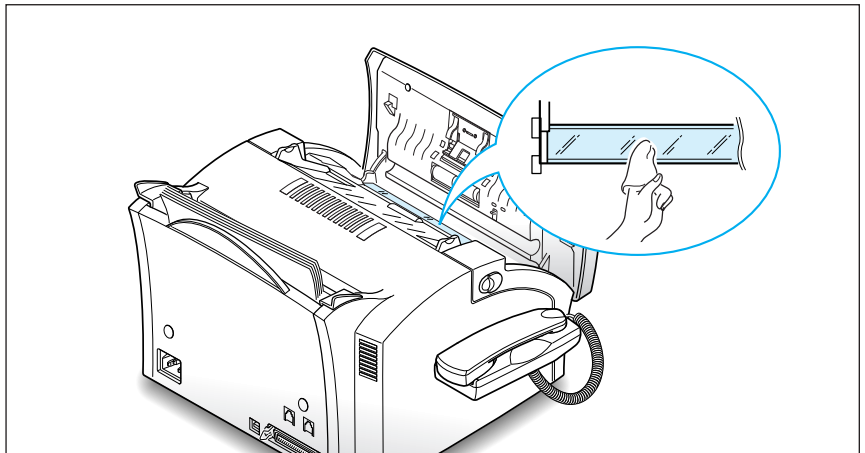

6. Replace the roller in reverse order, and then close the front panel firmly until it clicks into place.

Managing the Toner Cartridge

Expected Cartridge Life

The life of your toner cartridge depends on the amount of toner used in each print job. For instance, when you print a typical business letter with about 5% page coverage, you can expect a toner cartridge life of approximately 2,500 pages (1,000 pages only for the toner cartridge shipped with your machine). The actual number may vary according to the print density of the page you print. If you print a lot of graphics, you may need to change the cartridge more often.

You can extend the life of your toner cartridge by using Toner Save Mode on the printer properties (page 4.11) or on the front panel (page 1.22). The Toner Save Mode uses less toner than normal printing. The printed image is much lighter, and is adequate for printing drafts or proofs.

Redistributing the Toner Cartridge

When the toner cartridge is near the end of its life, white streaks or hue changes will occur. You can temporarily re-establish the print quality by re-distributing the remaining toner in the cartridge.

1. Open the cover and remove the toner cartridge.
2. Gently shake the cartridge to distribute the toner evenly inside the cartridge.

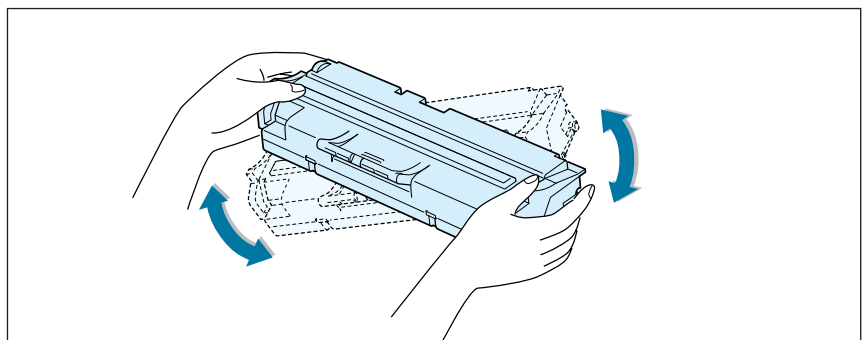

3. Reinstall the cartridge and close the cover.

This is typically successful one time only. When the toner eventually runs out, only blank pages will print when a print job is sent, or when a fax is received. At this stage, the toner cartridge needs to be replaced. See the following page.

Take the following steps to replace the toner cartridge:

1. Pulling the cover release buttons toward you, open the cover.

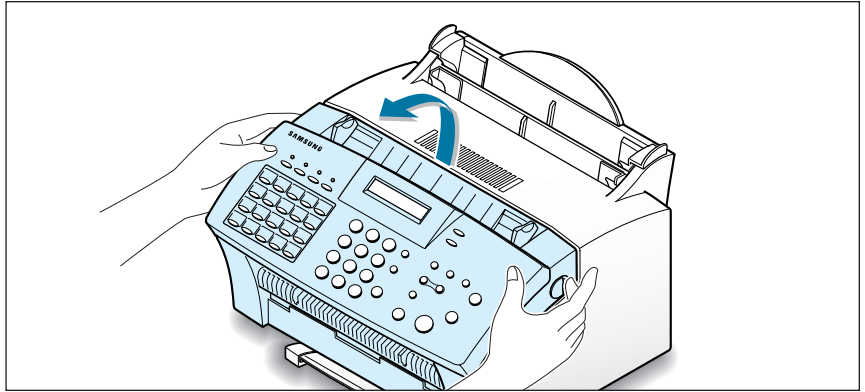

2. Remove the old toner cartridge. Follow the instructions printed on the cartridge box to recycle the used cartridge.

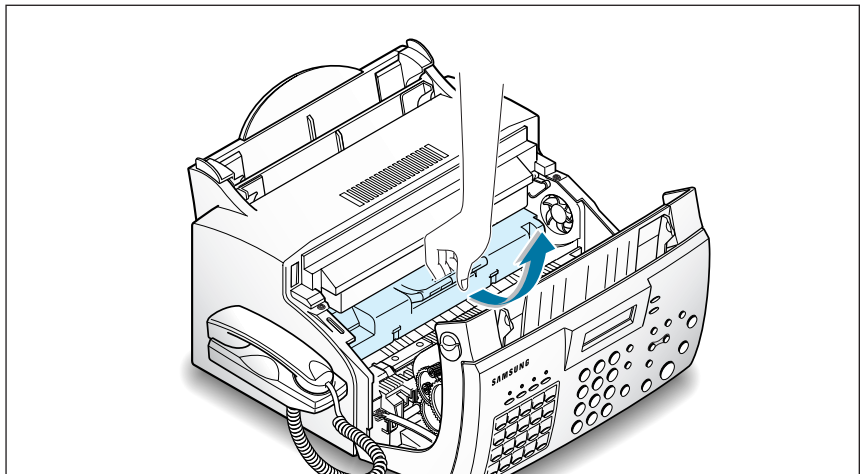

3. Unpack a new toner cartridge from its plastic bag, and then remove the paper rolled the cartridge.

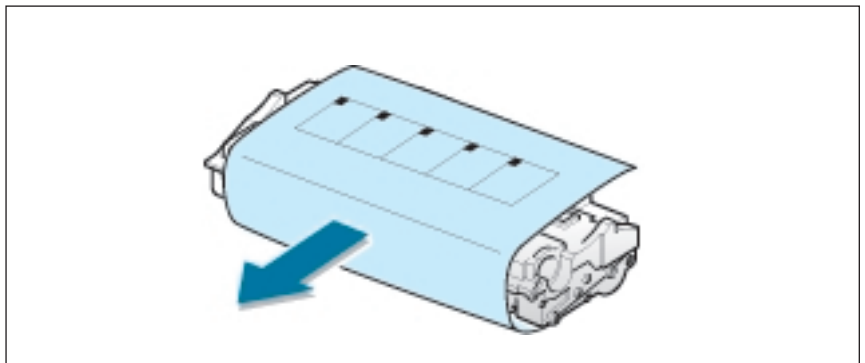

4. Shake the cartridge from side to side 5 or 6 times to distribute the toner evenly inside the cartridge.

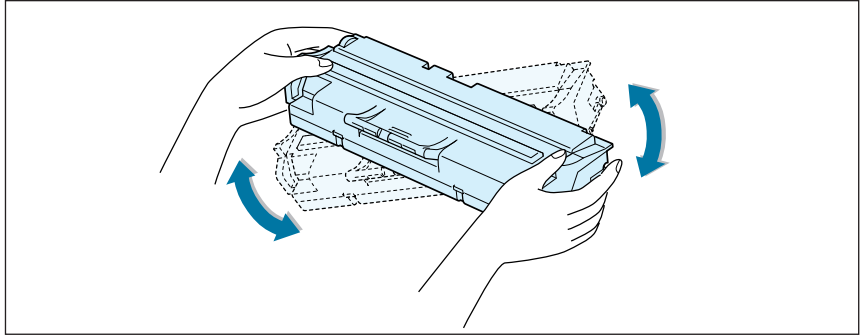

5. Find the cartridge slots inside the machine, one on each side. Grasp the handle and slide the cartridge down between the cartridge slots until it drops into place.

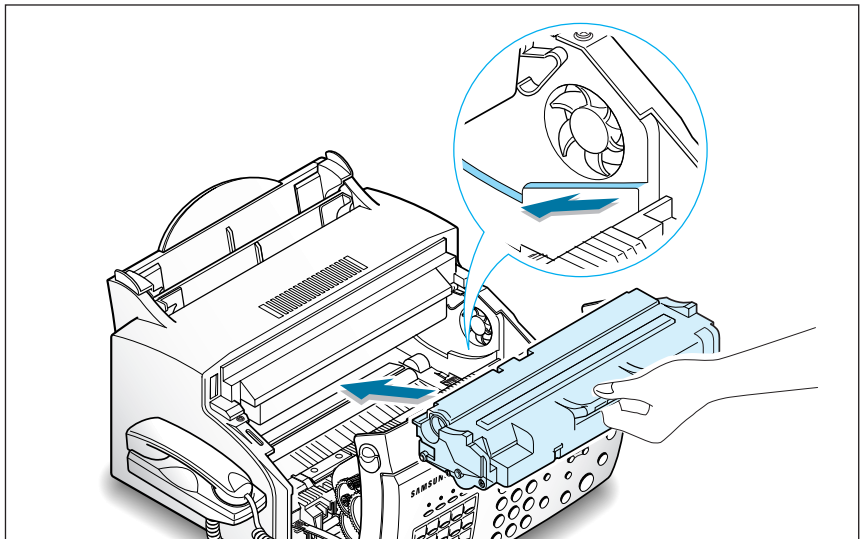

6. Close the cover firmly until it snaps closed.

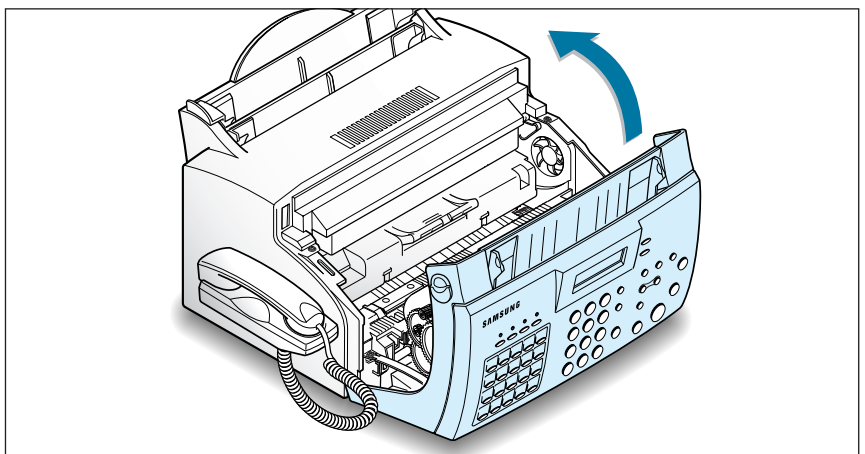

Automatic Document Feeder Rubber Pad Replacement

You can purchase the ADF rubber from an authorized service center

1. Open the Control Panel Cover.
2. Insert a small flat blade screwdriver under the right and left sides of the ADF Holder.

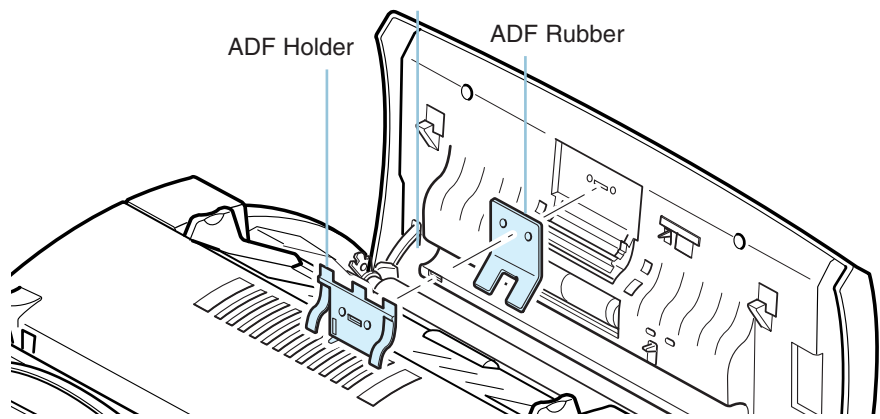

3. Apply upward pressure to release the two locking tabs on each side of the assembly.
4. Remove the assembly and replace the ADF Rubber.
5. Reassemble the components in the order shown in the diagram above.
6. Place the assembly back onto the ADF Holder.
7. Press down on the assembly until it locks into position.
8. Close the Control Panel.



chapter

6

Troubleshooting

This chapter gives helpful information for what to do if you encounter a operating error.

It provides information on the following topics:

- ◆ Clearing Paper Jams
- ◆ LCD Error Messages
- ◆ Fax Problems
- ◆ General Printing Problems (SF-531P only)
- ◆ Print Quality Problems

Clearing Paper Jams

Document Jams While Sending a Fax

If a document jams while you are sending it, 'DOCUMENT JAM' appears on the display. Do not pull the document out of the slot. If you do this, it could harm your machine.

1. Lift the front panel by grabbing the panel along the top edge.

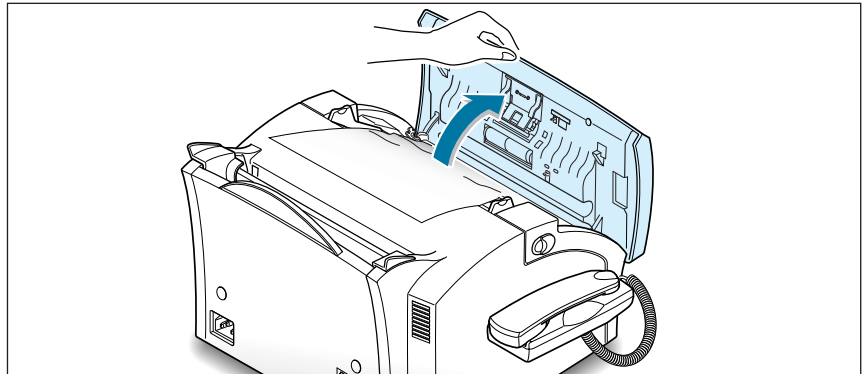

2. Carefully remove the jammed document.

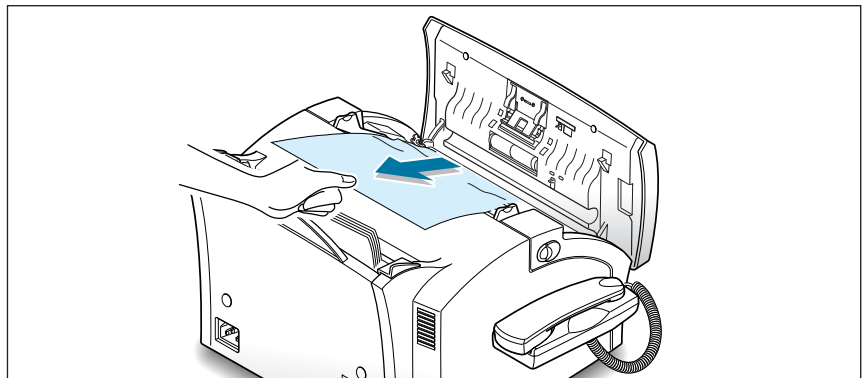

3. Close the front panel firmly until it clicks into place.

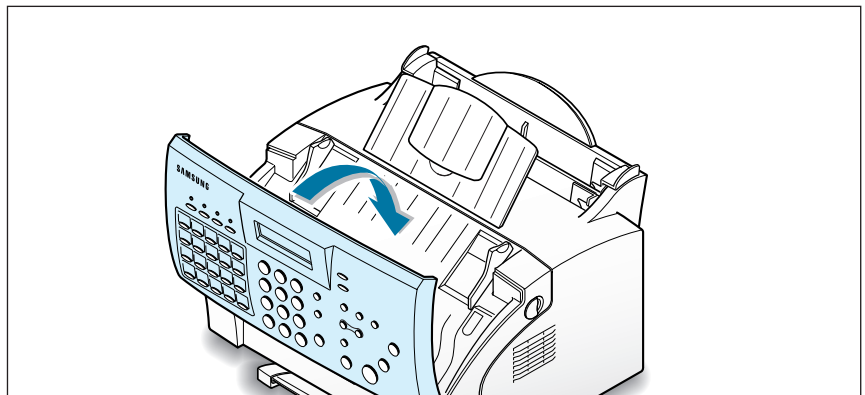

Paper Jams While the Machine is Printing

By carefully selecting the paper type and loading them properly, you should be able to avoid most paper jams. If paper jams occur, an error message appears on the display. Follow the steps below to clear the jam. To avoid tearing the paper, pull the jammed paper out gently and slowly.

IF JAMMED IN THE PAPER INPUT TRAY

1. Remove the jammed paper by carefully pulling it out of the tray.

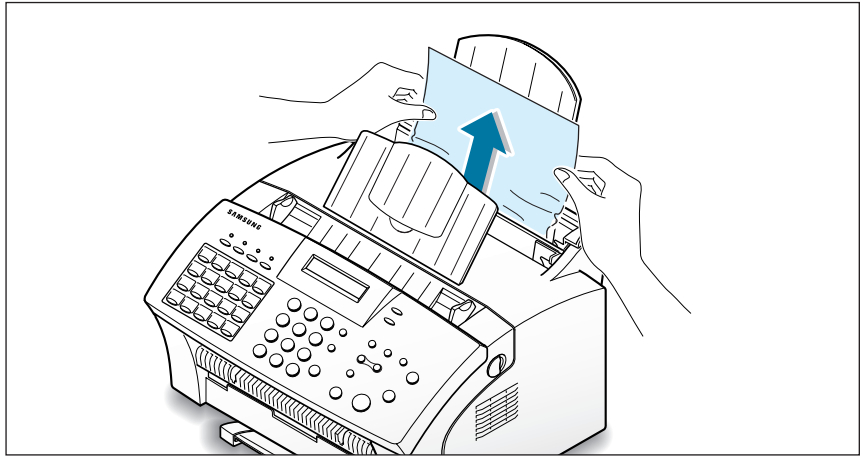

2. After you have removed the jammed paper, load the paper with the print side facing you.

IF JAMMED IN THE PAPER OUTPUT AREA

If the paper jams as it exits to the paper output tray and a long portion of the paper is visible, pull the paper straight out.

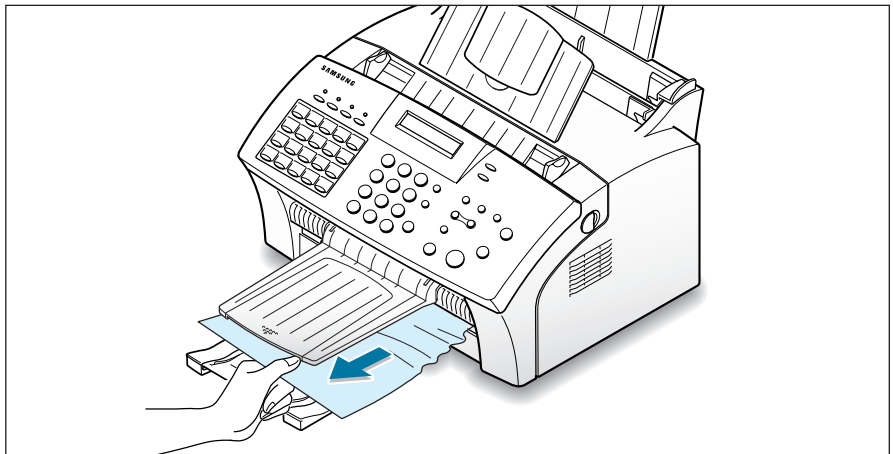

If there is any resistance, and the paper does not move immediately when you pull, stop pulling. Continue with the next step.

IF JAMMED INSIDE THE MACHINE

1. Pulling the cover release buttons toward you, open the cover.

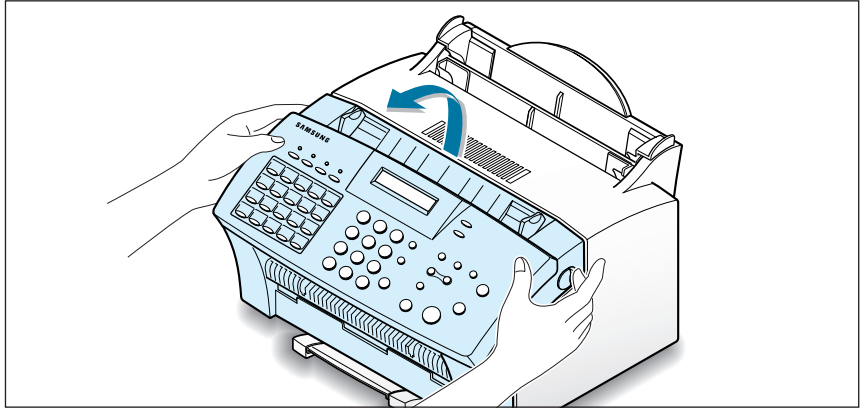

2. Remove the toner cartridge.

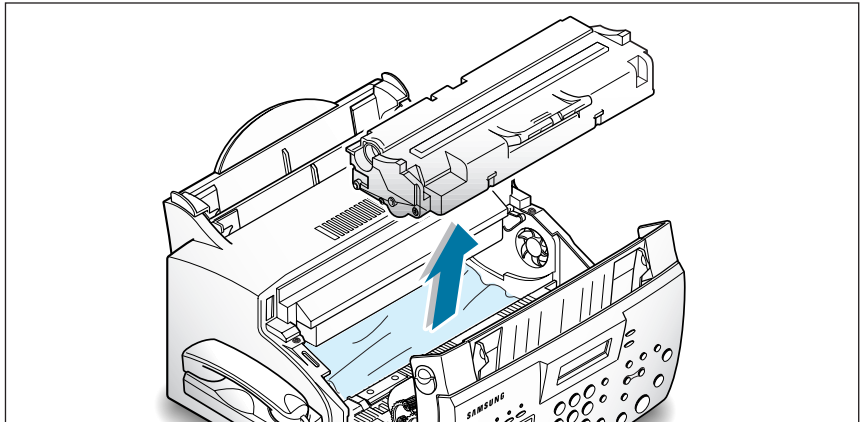

3. Remove the jammed paper by carefully pulling it out of the machine.

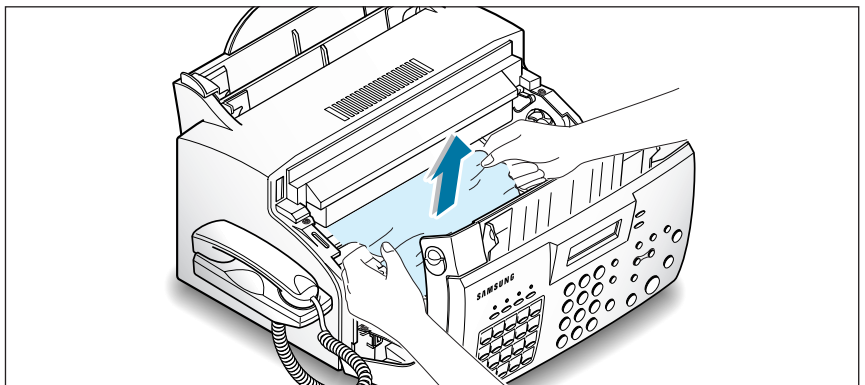

4. Check that there is no other paper inside the machine.
5. Replace the toner cartridge and close the cover.

Tips for Avoiding Paper Jams

By carefully selecting print materials and loading them properly, you should be able to avoid most paper jams. If jams do occur, follow the steps outlined in "Clearing Paper Jams" starting on page 6.1. If jams occur frequently, make sure that you are following these preventative tips:

- Follow the procedures in "Loading Paper" on page 1.15 to load paper properly. Make sure that the adjustable guides are positioned correctly.
- Do not overload the paper. Up to 150 sheets can be loaded in the automatic paper input tray at a time and the manual input tray holds only one sheet at a time.
- If you are needed to add more sheets of paper while printing, remove the remaining paper from the tray at first. Then, reinsert them with the new paper. Note that adding new paper into the remains in the tray may cause paper jams or multiple feeding.
- Envelopes with self-stick adhesives may cause wrinkling, creasing, or even jams and may even damage your machine.
- Fan stacks of labels or transparencies before loading them into the automatic paper input tray. If jams occur when using the paper input tray, try feeding one sheet at a time in the manual input tray.
- Do not load wrinkled, creased, damp, or highly curled paper.
- Do not mix paper sizes in the paper input tray.
- Use only recommended print media.
- Make sure that the recommended print side is facing up when loading it in the paper input tray.
- Keep print media stored in a suitable environment.

LCD Error Messages

Display	Meaning	Solution
DOCUMENT JAM	The loaded document has jammed in the feeder.	Clear the document jam.
DOOR OPEN	The front cover is not securely latched.	Press down on the cover until it clicks in place.
FUSER ERROR	There occurs a problem in the fuser unit.	Unplug the power cord and plug it back in. If the problem still persists, please call for service.
JAM/NO CARTRIDGE	Recording paper has jammed inside the unit, or the toner cartridge is not installed.	Clear the jam, or install the cartridge
LINE ERROR	Your unit cannot connect with the remote machine, or has lost contact because of a problem on the phone line.	Try again. If failure persists, wait an hour or so for the line to clear, then try again. Or, turn the ECM mode on. See 'Setting User-Selectable System Options' on page 3.2.
LOAD DOCUMENT	You have attempted to set up a sending operation with no document loaded.	Load a document and try again.
LSU ERROR	A problem has occurred in the LSU (Laser Scanning Unit).	Unplug the power cord and plug it back in. If the problem still persists, please call for service.
MEMORY FULL	The memory is full.	Either delete unnecessary documents, or retransmit after more memory becomes available, or split the transmission into more than one operation.
NO ANSWER	The remote machine has not answered after all the redial attempts.	Try again. Make sure the remote machine is operational.
NO. NOT ASSIGNED	The one-touch or speed dial location you tried to use has no number assigned to it.	Dial the number manually with the keypad, or assign a number.

Display	Meaning	Solution
NO PAPER	The recording paper has run out.	Load the recording paper.
OVER HEAT	The printer part in your unit has overheated.	Please wait until it cools down. If you cannot solve the problem, please call for service.
PAPER JAM 0	Recording paper has jammed in the paper feeding area.	Press Stop and clear the jam. See page 6.1.
PAPER JAM 2	Jammed paper still remains inside the unit.	Clear the jam. See page 6.1.
POLLING ERROR	The remote fax machine you want to poll is not ready to respond to your poll. Or When setting up to poll another fax machine, you have used an incorrect poll code.	The remote operator should know in advance that you are polling and have their fax unit loaded with the original document. Enter the correct poll code.
POWER FAILURE	A power failure has occurred.	If documents have been stored in the memory, a 'Power Failure Report' will be automatically printed when the power is restored.
RECEIVE ERROR	A fax has not been received successfully.	A problem with the facsimile communications has occurred. Ask the sender to try again.
RETRY REDIAL ?	The machine is waiting for a specified time interval to redial a previously busy station.	You can press Start/Enter to immediately redial, or Stop to cancel the redial operation.
SEND ERROR	Your fax has not gone through successfully.	A problem with the facsimile communications has occurred. Try again.
TONER EMPTY	The toner cartridge has run out. The machine stops.	Replace with a new toner cartridge.
TONER LOW	The toner is almost empty.	Take out the toner cartridge and gently shake it. By doing this, you can temporarily re-establish printing operations.
WARMING UP	The printer is warming up and is off-line.	Wait until the machine is on-line.

Fax Problems

Symptom	Cause and Solution
The machine is not working, there is no display and the buttons are not working.	<ul style="list-style-type: none">• Unplug the power cord and plug it in again.• Check that your socket is active.
No dial tone.	<ul style="list-style-type: none">• Check that the phone line is connected properly.• Check that the phone socket in the wall by plugging in another phone.
The numbers stored in the memory do not dial correctly.	<ul style="list-style-type: none">• Make sure that the numbers are stored in the memory correctly.• Print a Phonebook list. See page 3.38.
The document does not feed into the machine.	<ul style="list-style-type: none">• Make sure that the document is not wrinkled and you are putting it in correctly. Check the document is the right size, not too thick or thin.• Make sure that the cover is firmly closed.
You cannot receive faxes automatically.	<ul style="list-style-type: none">• The FAX mode should be selected.• Is there paper in the machine?• Check if the display shows 'MEMORY FULL.'
Your machine cannot receive faxes manually.	<ul style="list-style-type: none">• Did you hang up the handset of the machine before you pressed Start/Enter?
Your machine will not send anything.	<ul style="list-style-type: none">• Make sure that the document is loaded face down.• 'TX' should show up on the display.• Check the other machine you are sending to, to see if it can receive your fax.

Symptom	Cause and Solution
You cannot poll another machine.	<ul style="list-style-type: none"> • The fax machine you are polling may be using a poll code.
The incoming fax has blank spaces or you received a poor-quality copy.	<ul style="list-style-type: none"> • The machine sending you the fax may be faulty. • The fax machine sending you a fax may have a dirty scan glass. • A noisy phone line can cause line errors. • Check your machine by making a copy. • The toner cartridge may be empty.
Are some of the words on the incoming fax stretched?	<ul style="list-style-type: none"> • The machine sending you the fax had a temporary document jam.
There are lines on the copies or documents you send.	<ul style="list-style-type: none"> • Check your scan glass for marks, and clean it. See page 5.5.
The machine dials a number, but fails to make a connection with another fax machine.	<ul style="list-style-type: none"> • The other fax machine may be turned off, out of paper, or cannot answer incoming calls. Speak with the other machine operator and ask them to sort out the problem.
You cannot store a document in the memory.	<ul style="list-style-type: none"> • There may not be enough memory to store the document. If the display shows a 'MEMORY FULL' message, delete any documents you no longer need from the memory, then restore the document.
Blank areas appear at the bottom of each page or on other pages, with only a small strip of text printed at the top.	<ul style="list-style-type: none"> • You may have chosen the wrong paper settings in the user option setting. See page 3.3 to choose a proper paper size.

General Printing Problems (SF-531P only)



Problem	Possible Cause and Remedy
Your machine does not print.	<ul style="list-style-type: none">• A paper jam has occurred. Remove the jammed paper. See page 6.1.• The toner cartridge is not installed properly. Remove and reinsert the toner cartridge.• The printer cable is not connected properly. Check the printer cable connection.• The printer cable is defective. Swap the cable with one known to work.• The port setting is incorrect. Check the Windows printer settings to make sure that the print job is being sent to the correct port (for example, LPT1).• The printer properties may be configured incorrectly. Check the application to make sure that all print settings are correct.• The printer driver may be incorrectly installed. Uninstall the MFP driver and reinstall the MFP driver. Then try printing a test page. Refer to 'Uninstalling SmarThru Software' on page 2.19.
The paper is not fed into the machine.	<ul style="list-style-type: none">• Paper has not been inserted correctly. Remove and reinsert the paper correctly. See 'Using Automatic Paper Input Tray' on page 4.3 or 'Using Manual Paper Input Tray' on page 4.5.• There is too much paper in the paper input tray. Remove some of the paper from the input tray.
The paper keeps jamming.	<ul style="list-style-type: none">• There is too much paper in the paper input tray. Remove some of the paper from the tray. (If printing onto envelopes or labels, insert them one at a time in the manual paper input tray.)• The paper setting method may be incorrect. If printing onto envelopes, insert the envelopes so that there is a gap of approximately 1 mm (1/32") between the left and right edge of the envelopes at the paper guide.

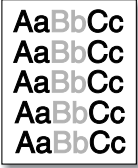
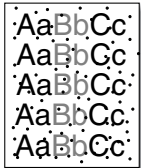
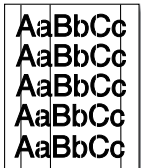

Problem	Possible Cause and Remedy
Half of the page is blank.	<ul style="list-style-type: none"> • The page layout is too complex. Simplify the page layout and remove any unnecessary graphics from the document if possible. • The page orientation setting may be incorrect. Change the page orientation in the Printer Properties dialogue box. • The paper size and the software paper size settings do not match. Insert the correct paper into the machine or change the software paper size settings. • Scaling may be set to less than 100%. Change the Scaling setting in the Printer Properties dialogue box. • The printer cable specifications may be incorrect. Use or replace the cable with an IEEE-1284 rated cable.
Your machine prints the wrong data, or it prints incorrect characters.	<ul style="list-style-type: none"> • The printer cable might not be connected properly. Check the printer cable connection. • There may be a problem with the printer driver software. Exit Windows and reboot the computer. Turn the printer off and then back on again. • The printer cable specifications may be incorrect. Use or replace the cable with an IEEE-1284 rated cable.
Printing is too slow.	<ul style="list-style-type: none"> • If using Windows 95/98/Me, the Spooling Setting may be set incorrectly. From the Start menu, select Settings and Printers. Click your printer icon with the right mouse button, select Properties, click the Details tab, and then click the Spool Settings button. Select the desired spool setting from the available choices. • If you are using Windows NT/2000, the Scheduling setting may be set incorrectly. From the Start menu, select Settings and Printers. Click your printer icon with the right mouse button, select Properties, click the Scheduling tab. Then, select the desired scheduling setting from the available choices.
Scanner is busy receiving or printing data. When the current job is completed, tray again.	There may be a copying or printing job in progress. When the current job is completed, try the job again.

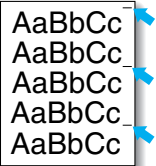

Print Quality Problems

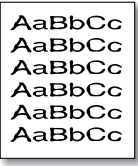
Problem	Possible Cause and Remedy
<p>Light or faded print</p> 	<p>If a vertical white streak or faded area appears on the page:</p> <ul style="list-style-type: none"> • The toner supply is low. You may be able to temporarily extend the toner cartridge life. See "Redistributing the Toner" on page 5.7. If this does not improve the print quality, install a new toner cartridge. • The paper may not meet paper specifications (for example, the paper is too moist or too rough). See "Paper Type and Size" for faxing on page 1.17 and "Selecting Print Media" for PC printing on page 4.1. • If the whole page is light, Toner Save Mode may be on. Turn the Toner Save Mode option off on front panel or within the printer properties as your setting. See page 1.22 and 4.11 respectively. • A combination of faded and smeared defects may indicate that the toner cartridge needs cleaning. See "Cleaning the OPC Drum" on page 5.2. • The surface of scanner parts inside the machine may be dirty. See "Cleaning the Document Scanner" on page 5.5.
<p>Toner specks</p> 	<ul style="list-style-type: none"> • The paper may not meet paper specifications. See "Paper Type and Size" for faxing on page 1.17 and "Selecting Print Media" for PC printing on page 4.1. • The transfer roller area may be dirty. See "Cleaning the Inside" on page 5.4. • The paper path may need cleaning. See "Cleaning the Inside". • The surface of scanner parts may need cleaning. See "Cleaning the Document Scanner" on page 5.5.
<p>Vertical lines</p> 	<p>If black vertical streaks appear on the page:</p> <ul style="list-style-type: none"> • The photosensitive drum inside the toner cartridge has probably been scratched. Install a new toner cartridge.

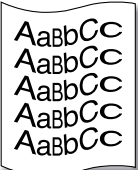
Problem	Possible Cause and Remedy
<p data-bbox="238 220 345 253">Dropouts</p> <div data-bbox="222 301 358 469" style="border: 1px solid black; padding: 5px; width: fit-content;"> <p>AaBbCc AaBbCc AaBbCc AaBbCc AaBbCc</p> </div>	<p data-bbox="496 220 1185 285">If faded areas, generally rounded, occur randomly on the page:</p> <ul data-bbox="509 307 1222 871" style="list-style-type: none"> <li data-bbox="509 307 1195 372">• A single sheet of paper may be defective. Try reprinting the job. <li data-bbox="509 397 1222 568">• The moisture content of the paper is uneven or the paper has moist spots on its surface. Try a different kind or brand of paper. See "Paper Type and Size" for faxing on page 1.17 and "Selecting Print Media" for PC printing on page 4.1. <li data-bbox="509 593 1199 693">• The paper lot is bad. The manufacturing processes can cause some areas to reject toner. Try a different kind or brand of paper. <li data-bbox="509 718 1140 784">• The toner cartridge may be defective. See "Vertical repetitive defects" on page 6.13. <li data-bbox="509 809 1160 875">• If these steps do not correct the problems, contact a service representative.
<p data-bbox="189 935 392 967">Gray background</p> <div data-bbox="212 1016 348 1184" style="border: 1px solid black; padding: 5px; width: fit-content;"> <p>AaBbCc AaBbCc AaBbCc AaBbCc AaBbCc</p> </div>	<p data-bbox="496 935 1192 1035">If the amount of background toner shading becomes unacceptable, the procedures below may help to clear the condition:</p> <ul data-bbox="509 1056 1243 1427" style="list-style-type: none"> <li data-bbox="509 1056 1243 1161">• Change the paper to a lighter basis weight. See "Paper Type and Size" for faxing on page 1.17 and "Selecting Print Media" for PC printing on page 4.1. <li data-bbox="509 1186 1215 1286">• Check the printer's environment; very dry (low humidity) or high humidity (higher than 80 % RH) conditions can increase the amount of background shading. <li data-bbox="509 1311 876 1344">• Install a new toner cartridge. <li data-bbox="509 1369 1188 1427">• Adjust the shading setting. See "Adjusting Shading" on page 5.2.
<p data-bbox="216 1497 364 1530">Toner smear</p> <div data-bbox="222 1559 358 1727" style="border: 1px solid black; padding: 5px; width: fit-content;"> <p>AaBbCc AaBbCc AaBbCc AaBbCc AaBbCc</p> </div>	<ul data-bbox="509 1497 1243 1734" style="list-style-type: none"> <li data-bbox="509 1497 1243 1562">• Clean the inside of the printer. See "Cleaning the Inside" on page 5.4. <li data-bbox="509 1588 1215 1688">• Check the paper type and quality. See "Paper Type and Size" for faxing on page 1.17 and "Selecting Print Media" for PC printing on page 4.1. <li data-bbox="509 1713 954 1746">• Try installing a new toner cartridge.

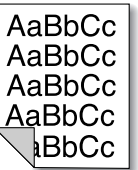
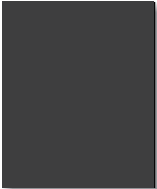
Problem	Possible Cause and Remedy
<p data-bbox="145 233 444 262">Vertical repetitive defects</p> 	<p data-bbox="504 227 1247 291">If marks repeatedly appear on the printed side of the page at even intervals:</p> <ul data-bbox="513 320 1218 668" style="list-style-type: none"> • The toner cartridge may be damaged. Print a cleaning sheet several times by cleaning the OPC drum (see page 5.2). After the printout, if you still have the same problems, install a new toner cartridge. • Parts in the machine may have toner on them. If the defects occur on the back of the page, the problem will likely correct itself after a few more pages. • The fusing assembly may be damaged. Contact a service representative.
<p data-bbox="179 722 410 751">Background scatter</p> 	<p data-bbox="491 716 1204 780">Background scatter results from bits of toner distributed on the printed page.</p> <ul data-bbox="513 809 1243 1228" style="list-style-type: none"> • The paper may be too damp. Try printing with a different batch of paper. Do not open packages of paper until necessary so that the paper does not absorb too much moisture from the air. • If background scatter occurs on an envelope, change your printing layout to avoid printing over areas that have overlapping seams on the reverse side. Printing on seams can cause this problem. • If background scatter covers the entire surface of a printed page, adjust the print resolution through your software application or the printer properties.
<p data-bbox="170 1280 423 1309">Misformed characters</p> 	<ul data-bbox="504 1280 1254 1537" style="list-style-type: none"> • If characters are improperly formed, producing hollow images, the paper stock may be too slick. Try a different paper. See "Paper Type and Size" for faxing on page 1.17 and "Selecting Print Media" for PC printing on page 4.1. • If characters are improperly formed, producing a wavy effect, the scanner unit may need service. Verify that it also occurs on a demo page. <p data-bbox="529 1561 1201 1624">Press Demo (*) on the front panel when the machine is ready.</p> <p data-bbox="529 1653 1163 1682">If you need service, contact a service representative.</p>

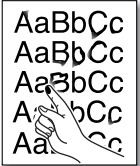
Problem	Possible Cause and Remedy
<p>Page skew</p> 	<ul style="list-style-type: none"> • Check the paper type and quality. See "Paper Type and Size" for faxing on page 1.17 and "Selecting Print Media" for PC printing on page 4.1. • Make sure that the paper or other media is loaded correctly and the guides are not too tight or too loose against the paper stack.
<p>Curl or wave</p> 	<ul style="list-style-type: none"> • Check the paper type and quality. Both high temperature and humidity will cause paper curl. See "Paper Type and Size" for faxing on page 1.17 and "Selecting Print Media" for PC printing on page 4.1. • Turn over the stack of paper in the input tray. Also try rotating the paper 180° in the input tray.
<p>Wrinkles or creases</p> 	<ul style="list-style-type: none"> • Make sure that paper is loaded properly. • Check the paper type and quality. See "Paper Type and Size" for faxing on page 1.17 and "Selecting Print Media" for PC printing on page 4.1. • Turn over the stack of paper in the input tray. Also try rotating the paper 180° in the tray.
<p>Back of printouts dirty</p> 	<ul style="list-style-type: none"> • The transfer roller area may be dirty. See "Cleaning the Inside" on page 5.4. • Check if the toner is leaking. Clean inside the machine. See page 5.4.
<p>Black pages</p> 	<ul style="list-style-type: none"> • The toner cartridge may not be installed properly. Remove the cartridge and reinsert it. • The toner cartridge may be defective and need replacing. Install a new toner cartridge. • The printer may require repairs. Contact a service representative.

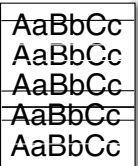
Problem	Possible Cause and Remedy
<p data-bbox="225 227 364 255">Loose toner</p> 	<ul data-bbox="513 227 1215 523" style="list-style-type: none"> • Clean the inside of the printer. • Check the paper type and quality. See "Paper Type and Size" for faxing on page 1.17 and "Selecting Print Media" for PC printing on page 4.1. • Try installing a new toner cartridge. • If the problem persists, the printer may require repairs. Contact a service representative.
<p data-bbox="200 585 389 612">Character Voids</p> 	<p data-bbox="502 581 1243 643">Character voids are white areas within the parts of characters that should be solid black:</p> <ul data-bbox="513 672 1243 1020" style="list-style-type: none"> • If you are using transparencies when you experience this problem, try another type of transparency. (Because of the composition of transparency media, some character voids are normal.) • You may be printing on the wrong surface on the paper. Remove the paper and turn it around. • The paper may not meet paper specifications. See "Paper Type and Size" for faxing on page 1.17 and "Selecting Print Media" for PC printing on page 4.1.
<p data-bbox="189 1078 400 1105">Horizontal stripes</p> 	<p data-bbox="502 1074 1153 1101">If horizontally aligned black streaks or smears appear:</p> <ul data-bbox="513 1130 1215 1373" style="list-style-type: none"> • The toner cartridge may be installed improperly. Remove the cartridge and reinsert it. • The toner cartridge may be defective. Install a new toner cartridge. • If the problem persists, the printer may require repairs. Contact a service representative.



Appendix

- ◆ **Connecting Other Devices to the Phone Line**

- ◆ **Specifications**

 - General

 - Printer

 - Scanner

 - Copy

 - Fax

- ◆ **Safety Information**

Connecting Other Devices to the Phone Line

You can connect other devices to the same phone line as the SF-530 series product.

Deciding What to Connect

You have connected the SF-530 series to the wall jack. Generally, there are three other devices that can be connected to the same phone line:

- a telephone
- an answering machine
- an external modem or a computer with an internal modem

Which, of these you connect to this phone line depends on your configuration. Please see the following configurations.

Situation 1

You connected the SF-530 series to a wall jack with a phone line for fax calls only (a dedicated fax line).

You do not need to connect any other devices. However:

- You can connect an external modem or a computer with an internal modem to this phone line if you want to use the fax line to access the Internet or e-mail.
- You can connect an extra telephone to this wall jack if you would like to make outgoing voice calls.

To connect any of these devices to the same phone line, go to "Connecting Other Devices, Overview" on page A.3. If you have another wall jack for this phone line, you can connect the extra phone and/or external modem or computer with internal modem to the other wall jack.

Note: Because this is a dedicated fax line, you should never have an answering machine or computer connected. Or, using computer voicemail, you must connect the computer with internal modem or the external modem to your dedicated voice line. You will connect to the Internet or e-mail using the dedicated voice line.

Situation 2

You connected the SF-530 series to a wall jack with a phone line for fax and voice calls (a shared line).

Connect any other devices you have to this phone line. To connect the other devices you have to the same wall jack as the product, go to Appendix "Connecting Other Devices, Overview" on page A.3.

If you have another wall jack for this phone line, you can connect some of the devices to that wall jack. However, if you have an answering machine or computer with voicemail, make sure to connect it to the same wall jack as the SF-530 series.

Special Situations

You have two phone lines coming into one wall jack.

When you connected the SF-530 series, you should have plugged it into a phone unit splitter connected to the wall jack. Proceed as if that side of the phone unit splitter is a phone line for fax calls only (a dedicated line). See "Situation 1" on page A.1.

You have one phone line with two phone numbers and distinctive ring service.

Use the same guidelines in "Situation 2" above for connecting other devices. You can change settings for distinctive ring later.

Connecting Other Devices, Overview

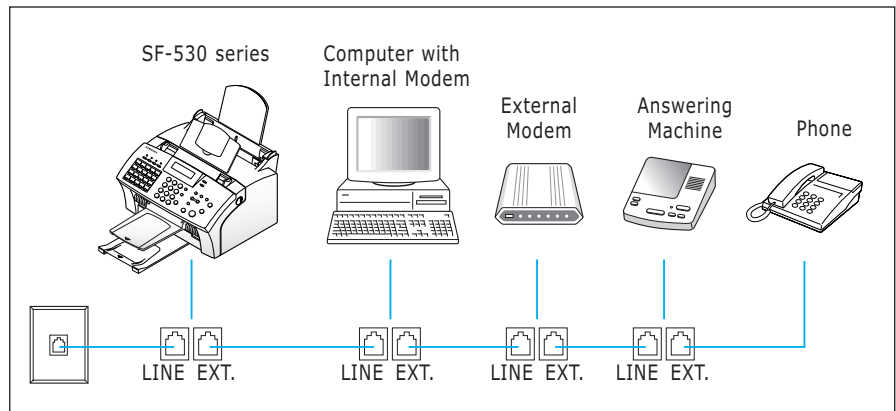

Connect other device in the order indicated.

Note:

- The SF-530 series product the device connected to the wall jack. If it isn't, it cannot answer incoming fax calls.
- As the drawing indicates, always plug the **LINE** jack into one device and the **EXT.** jack into another device.
- Some computers have a second **LINE** jack which is used to connect the computer to a dedicated voice line. If you have a second **LINE** jack, check your computer's documentation to ensure you are connecting to the correct **LINE** jack.

Specifications

General

Item	Specification and Description
Size (W x D x H) mm	370 x 356 x 195 mm
Weight (with accessories)	7.7 Kg
Interface (SF-531P Only)	Parallel: IEEE 1284, USB: 1.0 compliant

Printer

Item	Specification and Description
Technology	Laser Beam
Paper Path-Recording	Rear to Front
Paper Path-Document	Rear to Front
Speed	8 ppm mono, 5% Coverage in draft mode
Resolution	600 x 600 dpi
Effective Printing Width	202 mm
Manual Feed	Rear to Front
O/S	Windows 95/98/Me, Windows NT/2000
Emulation	Samsung PrinThru

Copy

Item	Specification and Description
Resolution	SF-530: 200 x 200 dpi, SF-531P: 300 x 300 dpi
BW Contrast Control	Normal, Darken, Lighten, Photo
Multiple Copy	99 pages
Reduce & Enlarge	SF-530 : 50 ~ 130 %, SF-531P : 50 ~ 200 %

Scanner

Item	Specification and Description
Scan Method	Contact Image Sensor (CIS)
Scan Width	Max. 216 mm, Effective: 210 mm
Scan Resolution-Optical	SF-530: 200 x 200 dpi, SF-531P: 300 x 300 dpi
Scan(Copy) Speed	SF-530: 9 sec/page, SF-531P: 6 sec/page
Feeding Method	Sheet-fed
ADF Capacity	Max 20 sheets
BW Contrast Control	Normal, Darken, Lighten, Photo

Fax

Item	Specification and Description
Modem Speed	33.6 kbps
Compatibility	ITU-T Group 3
Resolution (Selectable by 1-key & LCD)	Standard: 200 x 100 dpi (Default) Fine: 200 x 200 dpi SuperFine: 300 x 300 dpi
Compression	MH/MR/MMR
ECM Support	Yes
Halftone	Photo: 64 grayscales
TAD Interface	Yes
Memory	2 MB
Memory Backup	30 Min.
Receive Mode	TEL, FAX, AUTO, ANS/FAX

Safety Information

Important Precautions and Safety Information

When using this fax machine, these basic safety precautions should always be followed to reduce risk of fire, electric shock, and injury to persons:

1. Read and understand all instructions.
2. Use common sense whenever operating electrical appliances.
3. Follow all warnings and instructions marked on the product and in the literature accompanying the product.
4. If an operating instruction appears to conflict with safety information, heed the safety information. You may have misunderstood the operating instruction. If you cannot resolve the conflict, contact your sales or service representative for assistance.
5. Unplug the fax machine from the AC wall socket and/or telephone jack before cleaning. Do not use liquid or aerosol cleaners. Use only a damp cloth for cleaning.
6. Do not place the fax machine on an unstable cart, stand, or table. It may fall, causing serious damage.
7. Your fax machine should never be placed on, near, or over a radiator, heater, air conditioner, or ventilation duct.
8. Do not allow anything to rest on the power, telephone. Do not locate your fax machine where the cords will be abused by persons walking on them.
9. Do not overload wall outlets and extension cords. This can diminish performance, and may result in the risk of fire or electric shock.
10. Do not allow pets to chew on the AC power, telephone, or PC interface cords.
11. Never push objects of any kind into the fax machine through case or cabinet openings. They may touch dangerous voltage points, creating a risk of fire or shock. Never spill liquid of any kind onto or into the fax machine.

12. Your product may have a heavy cover for optimal pressure on the document for the best scanning and/or faxing (usually the flatbed-type product). In this case, replace the cover after placing document on the scan glass, by holding and moving it down slowly until it seats on its location.
13. To reduce the risk of electric shock, do not disassemble the fax machine. Take it to a qualified service technician when repair work is required. Opening or removing covers may expose you to dangerous voltages or other risks. Incorrect reassembly could cause electric shock when the unit is subsequently used.
14. Unplug the machine from the telephone jack, PC, and AC wall outlet, and refer servicing to qualified service personnel under the following conditions:
 - When any part of the power cord, plug, or connecting cable is damaged or frayed.
 - If liquid has been spilled into the product.
 - If the product has been exposed to rain or water.
 - If the product does not operate properly after instructions have been followed.
 - If the product has been dropped, or the cabinet appears damaged.
 - If the product exhibits a sudden and distinct change in performance.
15. Adjust only those controls covered by the operating instructions. Improper adjustment of other controls may result in damage, and may require extensive work by a qualified service technician to restore the product to normal operation.
16. Avoid using this fax machine during a lightning storm. There may be a remote risk of electric shock from lightning. If possible, unplug the AC power and telephone for the duration of the lightning storm.
17. SAVE THESE INSTRUCTIONS.

In Case of Interference

In normal operation, your SAMSUNG fax machine produces and uses radio-frequency energy. In some cases, this can cause interference to other electronic equipment. Part 15 of the FCC rules establishes guidelines limiting the amount of radio-frequency energy which may be produced by electronic equipment. Tests have proven that your Samsung FAX machine meets or exceeds these guidelines, and is classified a "Class B Digital Device" for operation in a residential environment. When installed and operated according to instructions, your SAMSUNG fax machine should not cause interference to the types of equipment expected to be found in a normal residential environment.

Unauthorized changes or modifications could void the user's authority to operate the equipment.

In the event your SAMSUNG fax machine appears to cause interference to other electronic equipment, it can often be easily remedied. First determine if the source of interference really is your FAX machine. To do this, turn its power off and on while observing the equipment experiencing the interference. If the interference disappears when you turn the FAX machine off, the following steps can be very effective in correcting interference problems:

- Connect the FAX machine to an AC outlet which is on a different circuit breaker from the equipment experiencing interference.
- Increase the distance between the FAX machine and the equipment experiencing interference.
- Cable TV amplifiers and splitters are extremely prone to interference. Be certain that they are as far as possible from the FAX machine and its AC power and telephone cords.
- Replace "twin lead" antenna wire with shielded coaxial cable, and use proper connectors and adaptors.
- Turn or relocate the receiving antenna. In most cases this is easily done by simply moving a radio. A TV antenna may need to be re-oriented or installed in another area of the building.
- Consult your dealer, a reputable radio/TV technician, or an Amateur Radio Operator for help.

* To locate an Amateur Radio Operator in your area, contact The American Radio Relay League, 610 Main St., Newington, CT 06111.

Fax Branding

The Telephone Consumer Protection Act of 1991 makes it unlawful for any person to use a computer or other electronic device to send any message via a telephone facsimile machine unless such message clearly contains in a margin at the top or bottom of each transmitted page or on the first page of the transmission the following information:

- (1) the date and time of transmission
- (2) identification of either business, business entity or individual sending the message; and
- (3) telephone number of either the sending machine, business, business entity or individual.

See pages 1.22 to 1.23 for instructions on how to enter this information into your Samsung FAX machine's memory.

The Telephone Company may make changes in its communications facilities, equipment operations, or procedures where such action is reasonably required in the operation of its business and is not inconsistent with the rules and regulations in FCC Part 68. If such changes can be reasonably expected to render any customer terminal equipment incompatible with telephone company communications facilities, or require modification or alteration of such terminal equipment, or otherwise materially affect its use or performance, the customer shall be given adequate notice in writing, to allow the customer an opportunity to maintain uninterrupted service.

Telephone Company Information

FCC IDENTIFICATION NUMBER

The Ringer Equivalence Number and FCC Registration Number for this equipment may be found on the label located on the bottom or rear of the machine. In some instances you may need to provide these numbers to the telephone company.

RINGER EQUIVALENCE NUMBER

The Ringer Equivalence Number (REN) is a measure of the electrical load placed on the telephone line, and is useful for determining whether you have "overloaded" the line. Installing several types of equipment on the same telephone line may result in problems making and receiving telephone calls, especially ringing when your line is called. The sum of all Ringer Equivalence Numbers of the equipment on your telephone line should be less than five in order to assure proper service from the telephone company. In some cases, a sum of five may not be usable on your line. If any of your telephone equipment is not operating properly, you should immediately remove it from your telephone line, as it may cause harm to the telephone network.

WARNING:

FCC Regulations state that changes or modifications to this equipment not expressly approved by the manufacturer could void the user's authority to operate this equipment. In the event that terminal equipment causes harm to the telephone network, the telephone company should notify the customer that service may be stopped. However, where prior notice is impractical, the company may temporarily cease service, providing that they:

- a) Promptly notify the customer.
- b) Give the customer an opportunity to correct the equipment problem.
- c) Inform the customer of the right to bring a complaint to the Federal Communication Commission pursuant to procedures set out in FCC Rules and Regulations Subpart E of Part 68.

You should also know that:

- Your Samsung FAX machine is not designed to be connected to a digital PBX system.
- If you intend to use a computer modem or fax modem on the same phone line as your FAX machine, you may experience transmission and reception problems with all the equipment. It is recommended that no other equipment, except for a regular telephone, share the line with your FAX machine.
- If your area experiences a high incidence of lightning or power surges, we recommend that you install surge protectors for both the power and the telephone lines. Surge protectors can be purchased from your dealer or telephone and electronic specialty stores.
- When programming emergency numbers and/or making test calls to emergency numbers, use a non-emergency number to advise the emergency service dispatcher of your intentions. The dispatcher will give you further instructions on how to actually test the emergency number.
- This equipment may not be used on coin service or party lines.
- This telephone provides magnetic coupling to hearing aids.
- You may safely connect this equipment to the telephone network by means of a standard modular jack, USOC RJ-11C.

Replacing the fitted plug (for UK Only)

Important

The mains lead for this machine is fitted with a standard (BS 1363) 13 amp plug and has a 13 amp fuse. When you change or examine the fuse, you must re-fit the correct 13 amp fuse. You then need to replace the fuse cover. If you have lost the fuse cover, do not use the plug until you get another fuse cover from the people whom you bought the machine.

The 13 amp plug is the most widely used type in the UK and should be suitable.

However, some buildings (mainly old ones) do not have normal 13 amp plug sockets. You need to buy a suitable plug adaptor. Do not remove the moulded plug.

Warning

**If you cut off the moulded plug, get rid of it straight away.
You cannot rewire the plug or you may get an electric shock
if you put it into a socket.**

Important warning: You must earth this machine.

The wires in the mains lead have the following colour code:

- Green and Yellow : Earth
- Blue : Neutral
- Brown : Live

If the wires in the mains lead do not match the colours marked in your plug, do the following:

You must connect the green and yellow wire to the pin marked by the letter 'E', or by the safety 'Earth symbol' or coloured green and yellow or green.

You must connect the blue wire to the pin which is marked with the letter 'N' or coloured black.

You must connect the brown wire to the pin which is marked with the letter 'L' or coloured red.

You must have a 13 amp fuse in the plug, adaptor, or at the distribution board.

Index

A

- adding documents 3.34
- address label, using 3.23
- adjusting shading 5.2
- alert tone, setting 3.2
- automatic dial
 - one-touch dial 3.21
 - speed dial 3.23
 - using remote control panel 3.25
- automatic input tray
 - loading paper 1.15, 4.3
 - paper source setting 4.10

B

- broadcasting transmission 3.28

C

- cancel
 - print job 4.12
 - scheduled operation 3.34
- cleaning
 - document scanner 5.5
 - machine 5.4
 - OPC drum 5.2
- connecting
 - other devices A.1
 - parallel cable 1.14
 - phone line 1.12
 - power cord 1.15
 - USB cable 2.13
- contents 1.3
- copying
 - using advanced features 3.18
 - overview 3.17
 - single copying 3.17

D

- date and time, setting 1.20
- delayed transmission 3.29
- diskette,
 - making 2.16
 - installing software 2.17
- document contrast, setting 3.8
- document feeder, loading 3.9
- document resolution, setting 3.8
- document scanner, cleaning 5.5
- driver,
 - access 4.9
 - install 2.4
 - remove 2.18

E

- entering, name 3.19
- error messages 6.5

F

- fax problem, solving 6.7
- fitting document to selected paper 4.16
- forwarding received faxes 3.36
- front panel, features 1.6

G

- group dialing 3.40

H

- handset, inserting 1.11

I

- install
 - printer software 2.4
 - software from diskette 2.17
 - toner cartridge 1.18
- introduction
 - SF-530 series 1.1
 - SmarThru software 2.1

L

- load, document 3.9
- load, paper
 - in the automatic input tray 1.15, 4.3
 - in the manual input tray 4.5
- location, choosing 1.9

M

- manual input tray
 - loading paper 4.5
 - paper source setting 4.10
- memory
 - clearing 5.1
 - searching 3.27
- monitoring status 3.35
- multiple pages on one sheet, print 4.14

N

- network, setting 4.24
- notifying toner low 5.3
- number and name, setting 1.21

O

- one-touch dialing 3.21
- one-touch label plate 3.23
- OPC drum, cleaning 5.2
- orientation 4.10
- overlay, using 4.20

P

- paper
 - in automatic input tray 1.15, 4.3
 - in the manual input tray 4.5
 - selecting 1.17, 4.1
 - setting 3.3, 4.10
- paper jam, clear 6.8
 - document 6.1
 - inside the machine 6.3
 - output area 6.2
 - paper input tray 6.2
 - tips avoiding paper jams 6.4
- paper orientation, setting 4.10
- paper save mode 1.23
- paper size, setting 4.10
- paper source, setting 4.10
- paper type, setting 4.10
- parallel, connection 1.14
- parts, identifying 1.4
- pause, inserting 3.21
- phone line, connection 1.12
- polling
 - reception 3.33
 - transmission 3.32
- poster, printing 4.17
- power, plugging 1.15
- power save mode 1.22
- print media *see paper*
- print quality problem, solving 6.11
- print quality, setting 4.11
- print resolution 4.11
- printer driver *see driver*
- printer software, install 2.4
- printing problem, solving 6.9
- printing
 - cancel 4.12
 - cleaning page 5.2
 - document 4.9
 - general problems, solving 6.9
 - help 4.13
 - in network environment 4.24
 - several pages per sheet 4.14
 - quality problems, solving 6.11
 - reports 3.38

P *(continued)*

priority transmission 3.31
problem, solving
 error messages 6.5
 fax 6.7
 general printing 6.9
 paper jam 6.1
 print quality 6.11

Q

quality, problems 6.11

R

receiving fax
 by an extension telephone 3.16
 in ANS/FAX mode 3.15
 in AUTO mode 3.15
 in DRPD mode 3.6
 in FAX mode 3.14
 in TEL mode 3.16
reception mode 3.13
redialling
 automatic 3.10
 last number 3.11
Redistributing, toner cartridge 5.8
remote test 5.3
reports, printing 3.38

S

scaling document 4.15
searching, memory 3.27
send
 fax 3.10
 flash 3.35

setting
 alert tones 3.2
 date and time 1.20
 fax number and name 1.21
 resolution and contrast 3.8
 volume 3.1
 stand-alone fax system 3.2
specifications A.4
speed dialing 3.23
storing
 group dial 3.40
 one-touch 3.21
 speed dial 3.23
supports, attaching 1.10
system options, 3.2
system requirements, for software 2.3

T

tape, removing 1.9
toll save transmission 3.37
toner cartridge
 installing 1.18
 replacing 5.7
toner save mode 1.22, 4.11
troubleshooting *see problem, solving*

U

uninstall,
 MFP driver 2.18
 SmarThru software 2.19
 using CD-ROM 2.21
USB port, connection 2.13
user-selectable options 3.3

V

voice request 3.12
volume, setting 3.1

W

watermarks, printing 4.18