

**SAMSUNG**

# INSTRUCTION MANUAL

**SR-S25/26/28NTA****SR-S25/26/28BTA****SR-S24/25/27FTA****SR-S24/25/27DTA**

## REFRIGERATOR

Before operating the unit, please read this manual thoroughly,  
and retain for future reference.

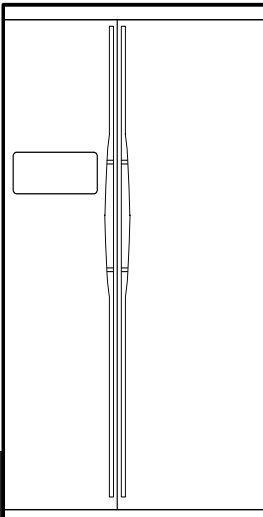
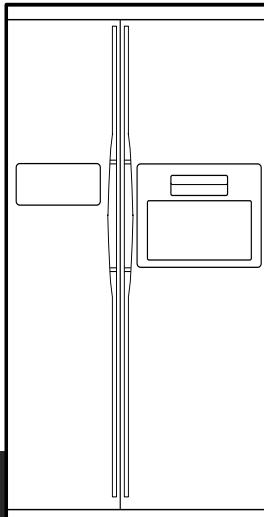
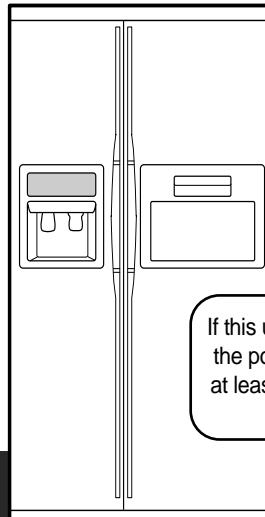
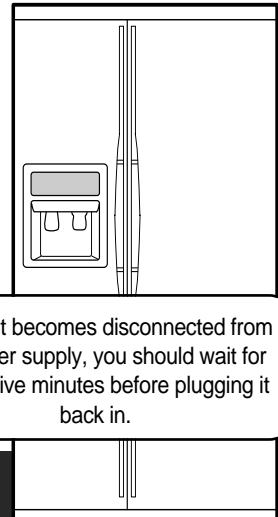
**NTA****BTA****FTA****DTA**

If this unit becomes disconnected from the power supply, you should wait for at least five minutes before plugging it back in.

# FEATURES

## Energy saving refrigerator!

- Power consumption is kept to a minimum by the separate distribution of cool air in the refrigerating and freezing sections.

## Faster cooling times!

- The power freezing and power refrigerating functions allow you to freeze or chill food more quickly.

## High humidity keeps food fresh!

- You can keep foods, fruits, and vegetables fresh because your refrigerator supplies highly humidified cold air. This can be up to 4-5 times more effective than a normal refrigerator.

## Three wavelength fluorescent lamp in the refrigerating section!

- The refrigerator's three wavelength fluorescent lamp does not dazzle the eyes. It high lights the natural colour of foods.
- The effective lighting system makes the refrigerator easy to use.

## Alarm sounds when the door is open

- When the refrigerator door is left open for more than two minutes, self-detection triggers an alarm which emits warning music. This feature saves energy and preserves stored foods.

## An abundant supply of ice and cold water!

- Ice/water dispensers provide ice and cold water at any time.

## Place frequently used foods in the extra refrigerating compartment!

- You do not have to open the main door to access food in the extra refrigerating compartment. This saves time and money.



## What is the meaning of H. M. Cycle (High-efficiency Multi-evaporator Cycle)?

- Refrigerating and freezing sections has an evaporator each other. Because of this isolated system, freezing and refrigerating compartments are cooled so fast separately. Food odour from the refrigerating section does not effect food in the freezer section because the two are not connected.

# CONTENTS

FEATURES .....	1
SAFETY WARNINGS .....	2
CAUTION .....	4
INITIAL OPERATION.....	6
INSTALLATION .....	7
INSTALLATION METHOD .....	8
FRONT CONTROL PART.....	9
TEMPERATURE CONTROL METHODS FOR FREEZER AND REFRIGERATOR.....	11
ICE DISPENSER .....	14
COLD WATER DISPENSER .....	15
FOOD STORAGE METHODS .....	16
DISASSEMBLING METHOD .....	21
EXTRA REFRIGERATING COMPARTMENT.....	25
CLEANING METHOD FOR ACCESSORIES.....	26
CHANGING THE INSIDE LAMP.....	28
ICE-MAKING FILTER .....	29
CHECKS PRIOR TO SERVICE REQUEST.....	30

# SAFETY WARNINGS

These warnings are to prevent injury to users or other persons. Please observe them. After reading these warnings. Please keep them in a safe place for later referral.

## SYMBOLS

	Represents prohibition.
	Represents the prohibition of disassembly.
	Represents the prohibition of contact.
	Represents what must be observed.
	This symbol indicates that a power plug must not be connected to a socket.
	Represents that something must be earthed to prevent electric shock.

## CAUTION/WARNING SYMBOLS DISPLAYED

	Indicates that a danger of death or serious injury exists.
<b>WARNING</b>	
	Indicates that a risk of personal injury or material damage exists.
<b>CAUTION</b>	

## WARNING

<p><b>Do not use with multi-plug adapter.</b></p> <ul style="list-style-type: none"> <li>• This causes a potential fire hazard.</li> </ul>	<p><b>Make sure that the power plug is not cramped or damaged by the back side of the refrigerator.</b></p> <ul style="list-style-type: none"> <li>• Damaged power plug may cause fire due to overheating.</li> </ul>	<p><b>Do not allow water to splash or run on refrigerator.</b></p> <ul style="list-style-type: none"> <li>• May cause fire or electric shock.</li> </ul>
<p><b>Do not use aerosols near the refrigerator.</b></p> <ul style="list-style-type: none"> <li>• May cause explosion or fire.</li> </ul>	<p><b>Do not place heavy articles on the power cord.</b></p> <ul style="list-style-type: none"> <li>• May cause fire.</li> </ul>	<p><b>Do not insert the power plug with a wet hand.</b></p> <ul style="list-style-type: none"> <li>• May cause electric shock.</li> </ul>

**⚠ WARNING**

**Do not put a container filled with water on the product.**

- May lead to fire or electric shock.

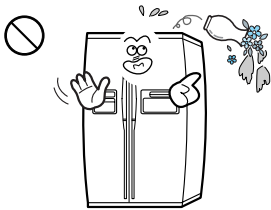

**Do not install the refrigerator in a damp place or a place where water might splash.**

- Deterioration of insulation of electric parts may cause electric shock or fire.

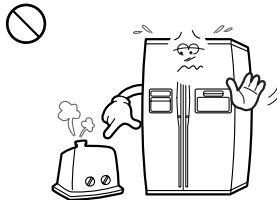

**Do not store volatile or inflammable substances in the refrigerator.**

- Storage of benzene, thinner, alcohol, ether, LP gas, etc., may cause explosions.



**Do not disassemble, repair or alter.**

- It may cause fire or abnormal operation which lead to injury.

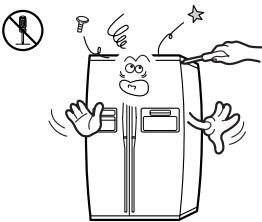

**Pull the power plug out to change the interior lamp of the refrigerator.**

- It may cause electric shock.

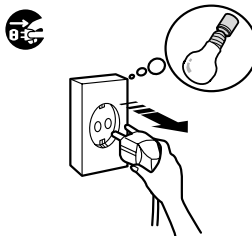

**If you want to throw away the refrigerator, throw it away after tearing off the door and its packing.**

- If a child plays in the refrigerator, the door can close and the child can become trapped. The child will die from suffocation.

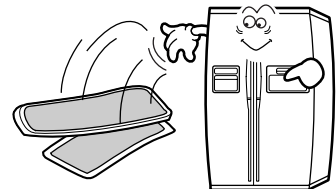

**Be sure to earth.**

- If the appliance is not properly earthed, it may breakdown or cause electric shock.

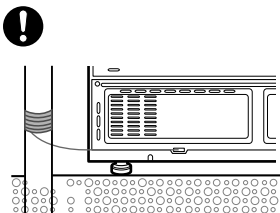

**If gas leaks, ventilate the room without touching the refrigerator or the plug.**

- Explosion of gas may cause fire.

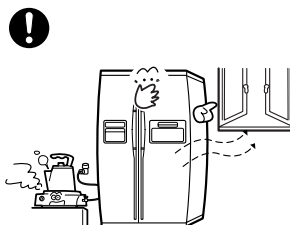

# CAUTION

## ⚠ CAUTION

### Do not overfill the refrigerator with foodstuffs.

- Injury may be caused if food drops out after the doors are open.

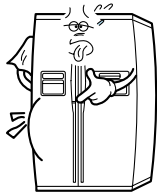

### Do not bottles or kinds of glass in the freezing section.

- Freezing of the contents may break glass and lead to injury.

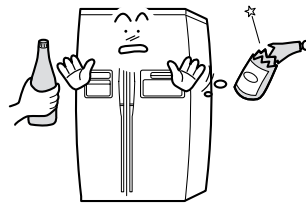

### If the power plug socket is loose, do not insert the power plug.

- It may cause electric shock or fire.

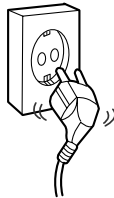

### Do not remove the power cord by pulling on its lead.

- Damage of the cord lead may cause fire and electric shock.
- If the power cord is damaged, to avoid a hazard it must be replaced by the manufacturer, a certified service agent, or qualified service personnel.



### Do not store articles on the product.

- Opening or closing of the door may cause articles to drop which may inflict a wound.



### Do not store medicine, scientific materials, etc., in the refrigerator.

- Check product labels to make sure that refrigeration is not prohibited.



### Do not let children hang from the door.



### Do not touch the inside freezer section walls, or products stored the freezer section, with a wet hand.

- It may cause frostbite.



**CAUTION**

**Do not use a wet or damp cloth when cleaning the plug. Please wipe out foreign materials of the metal portion of the power plug cleanly.**  
• Use of it as it is may cause fire.

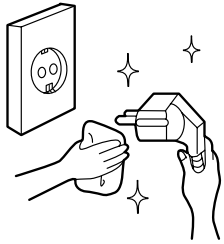

**Do not put your hand under the refrigerator.**  
• Sharp edge may inflict a wound.

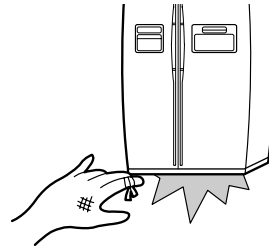

**Move it by catching the back handle and the bottom handle.**

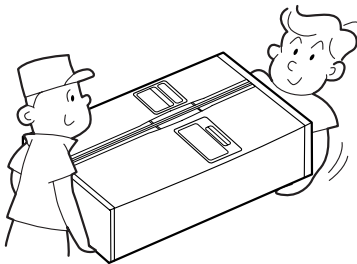

**If this unit becomes disconnected from the power supply you should wait for at least five minutes before plugging it back in.**

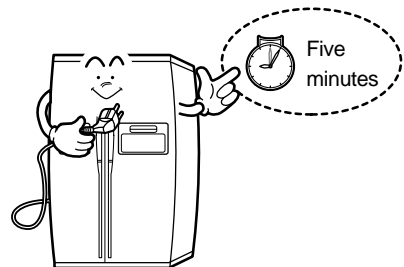

**If the refrigerator is not to be used for a long time, pull out the power plug.**

• Due to deterioration of insulation, may cause fire.

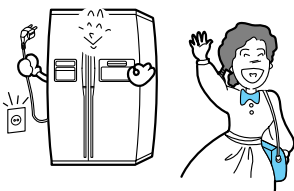

**In case of abnormal sound, smell or smoke, pull out the power plug immediately and contact SAMSUNG Electronics service center.**

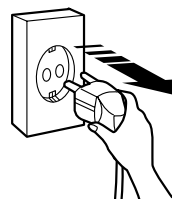

# INITIAL OPERATION

It should be satisfied when you test the refrigerator following below items. If not, check power supply and electricity state. If you can not any control, contact SAMSUNG service center.

**1**

Place the shelves and containers which were removed for transportation in their appropriate positions. (refer to pages 21~24)

**4**

Set temperature control to "HIGH" position and let refrigerator operate for one hour. The freezer compartment should get slightly chilled and the motor should run smoothly producing a soft humming noise.

**2**

Clean refrigerator and parts to remove dust incurred in shipping and packing. (refer to pages 26~27)

**5**

Store food after the temperature in the refrigerator gets sufficiently low. It takes a few hours after starting the refrigerator to reach the proper temperature.

**3**

When you plugged the refrigerator in, interior lamp should light on during refrigerator door is opened.

Your refrigerator is operated by a compressor which switches "on and off" to maintain the internal temperature. When the compressor is new, it requires a running in period which can last for up to 5 months. During this period it may operate a little noisily. This is quite normal and does not represent a fault.

# INSTALLATION

1

**Please allow sufficient space install on a flat surface.**

- If your unit is not level, the internal cooling system may not work.

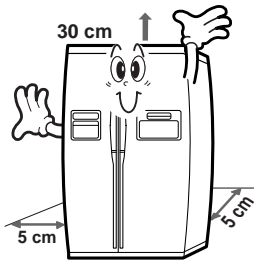

2

**Cleaning your refrigerator.**

- It is necessary to wipe the inside and outside of your refrigerator clean with a dry dish cloth.

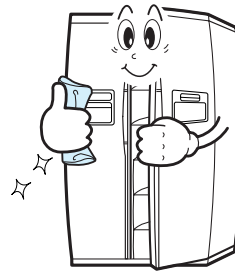

3

**Loading the refrigerator.**

- Wait for at least 2-3 hours after plugging your unit in before loading it with food and other items.

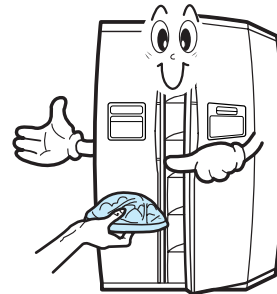

**WARNING**



## HOW TO GROUND

**The refrigerator must be grounded.**

The purpose of grounding is to prevent any power leakage or electric shock caused by the current leakage from the refrigerator.

- Never use gas pipes, telephone lines, or other potential lightning rods for the purpose of grounding.

**In case of power plug without ground terminal.**

- Connect one side of the ground wire (yellow/green or green color) with the ground screw, another side of the ground terminal with steel or copper pipe such as water pipe tap.

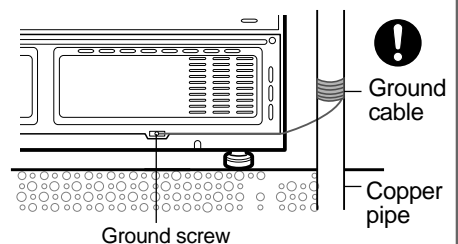

# INSTALLATION METHOD

Allowing a 5cm space on the right, left and back sides when installing the unit, gives you an advantage by saving power.

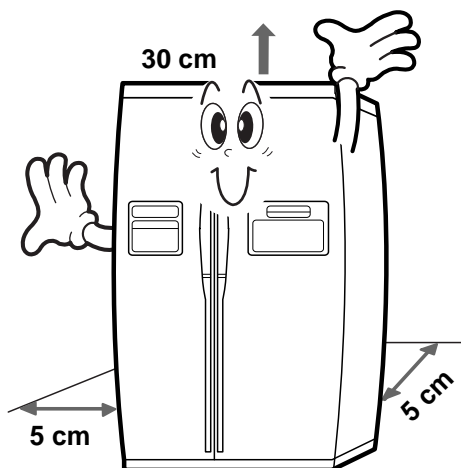

## THE LEVELLING METHOD

When you level the refrigerator, set the front legs higher than the rear legs, you can open and close the door easily.

**First disassemble leg coverage and then level the refrigerator.**

**1**

**To adjust the left side of your refrigerator.**

Turn the left adjusting screw to level the refrigerator.

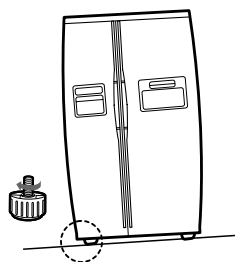

**2**

**To adjust the right side of your refrigerator.**

Turn the right adjusting screw to level the refrigerator.

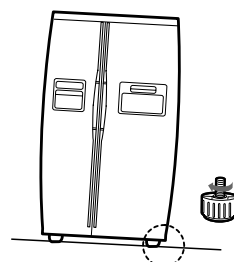

# FRONT CONTROL PART

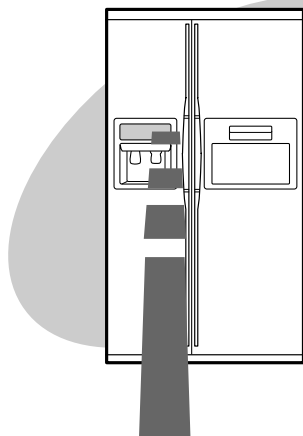
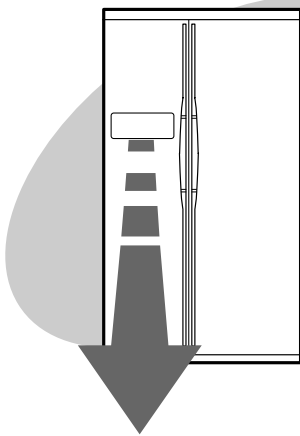

NTA, BTA

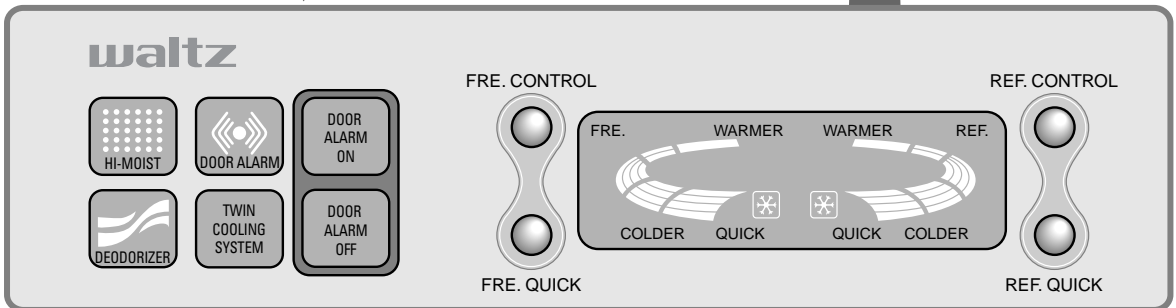

DTA, FTA

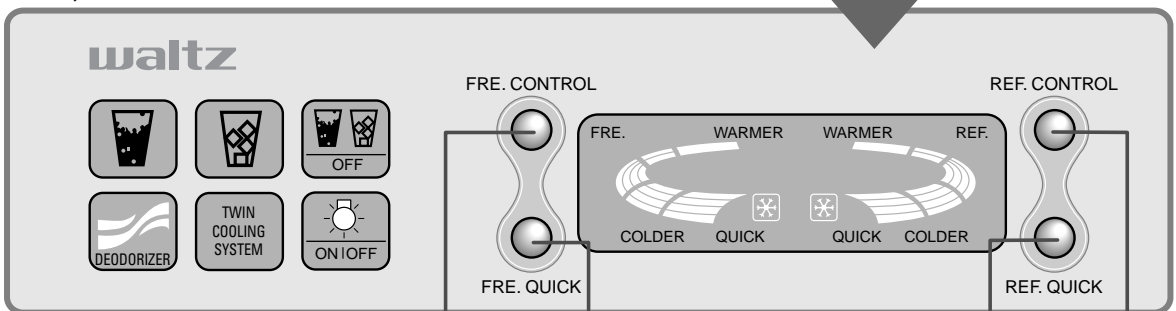

**FRE. CONTROL BUTTON**  
Controls the temperature of the freezing compartment.  
MED → MED COLDER → COLDER → WARMER → WARMER MED are chosen respectively when pushing the button.

**FRE. QUICK BUTTON**  
This button speeds up the freezing process in the freezer section.

**REF. QUICK BUTTON**  
This button speeds up the refrigerating process in the refrigerating section.

**REF. CONTROL BUTTON**  
Controls the temperature in the freezer section.  
MED → MED COLDER → COLDER WARMER → WARMER MED are chosen respectively when pushing the button.



## INDICATORS (NTA, BTA)

### High humidity refrigeration function

The high humidity function light turns on during operation.



### Door alarm function



When the door alarm light is on, the door alarm is activated.

- Activate the door alarm by pressing the DOOR ALARM ON button.
- When the door is opened over 2 minutes, it sound alarming for 10 seconds. So it inform you that the door is opened.



When the door alarm light is off, the door alarm is not activated.

- Deactivate the door alarm by pressing the DOOR ALARM OFF button.
- Turn the door alarm off when you do not want the alarm to sound, (When you are cleaning the refrigerator, for example)



### The deodorizer function

When the deodorizer light is on, the deodorizer function is operating.



### Separate freezing function

When the unit is operating, the ON LIGHT of the twin cooling system means that the freezing machine and fan, deployed separately in refrigerating section, work.



# TEMPERATURE CONTROL METHODS FREEZER,



## FRE. QUICK/TEMPERATURE CONTROL FOR FREEZER

### **FRE. QUICK : When foods are frozen quickly.**

- Choose 'FRE. QUICK' for power freezing. Quick lamp is on.
- Press the button again to cancel 'FRE. QUICK'.

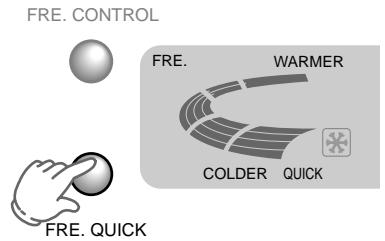

### **WARMER : When only a small amount of food will be stored.**

- Please choose 'WARMER' by pressing the temperature control button on the front control panel.
- Temperature is selected 'WARMER/MED → MED' respectively

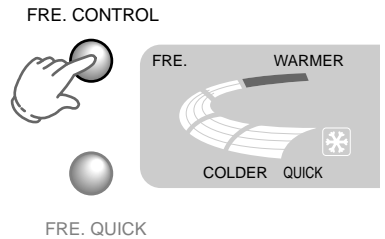

### **MED : When you are using in normal state.**

- Taking the amount of food you have stored into account, choose an appropriate setting between WARMER and COLDER.
- The MEDIUM temperature is proper.

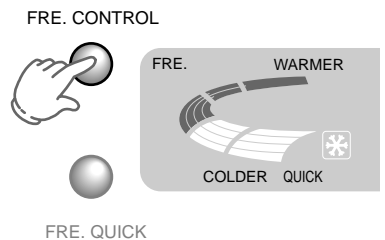

### **COLDER : When storing a considerable amount of food.**

- Please press 'COLDER' button on the front control panel.

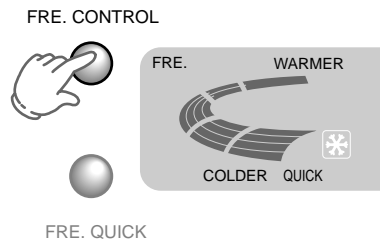

# REFRIGERATOR



## REF.QUICK/TEMPERATURE CONTROL FOR REFRIGERATOR

**REF.QUICK** : When you want to refrigerate foods quickly.

- Press 'REF.QUICK' button for power refrigeration.
- Quick lamp is on.
- Press button once more to cancel 'REF.QUICK'.

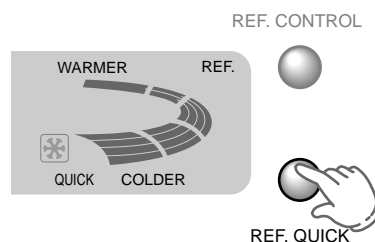

**WARMER** : When only a small amount of food will be stored.

- Select 'WARMER'
- Temperature is selected 'WARMER/MED → MED' in order when you press the temperature button.

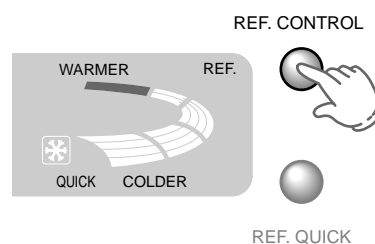

**MED** : When you are using in normal state.

- Taking the amount of food you have stored into account, choose an appropriate setting between WARMER and COLDER.
- The MEDIUM temperature is proper in normal state.

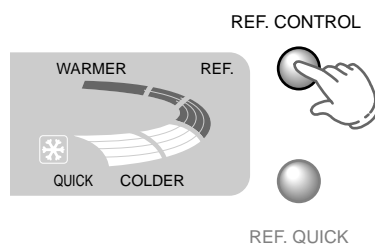

**COLDER** : When refrigeration is poor or the refrigerator section is overfilled.

- Press 'COLDER'.
- If you press the button once more, it change to WARMER temperature state.

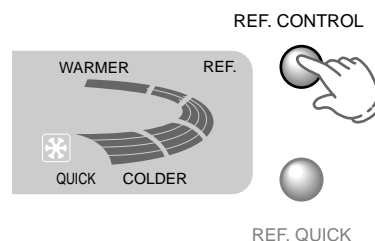



## INDICATORS (FTA, DTA)

### Crushed Ice

Please the CRUSHED ICE button to make crushed ice.

- The CRUSHED ICE button will light up to indicate that this function has been selected.
- CRUSHED ICE will be automatically selected following disconnection from the power supply or a power failure.



### Ice Cubes

Press the ICE CUBES button to make ice cubes.

- The ICE CUBES button will light up to indicate that this function has been selected.



### No Ice

Press the OFF button to turn off the ice making function.



### Deodorizer function

The deodorizer light is always on during operation.

- If you do not any control, deodorizer function is maintained.



### Separate cooling function

Freezing and refrigerating sections has an evaporator each other. So it can cooling the sections faster than system which has an evaporator only one.



### Light

- Pressing this button will turn the external light on, allowing you to collect ice and water more easily.
- The light will turn off automatically after a few seconds.



### Open door alarm function

Alarm sound two minutes later door opened.



### NOTE

#### Energy saving function of interior light

- The inside lamp in the freezing section turns off automatically if door is open for over 10 minutes.
- The inside lamp of the refrigerating section is a fluorescent lamp and it has no automatic on/off function.

# ICE DISPENSER

Ice making device makes 8 cubes at a time and 80 cubes a day automatically.

The output from the ice making device may be influenced by such factors as the temperature of the freezer section and the number of times that the door is opened. When your unit is first plugged in, crushed ice is selected automatically.

## Select ice type after pressing ICE button.

- Please the CRUSHED ICE button to make crushed ice.
- Press the ICE CUBES button to make ice cubes.

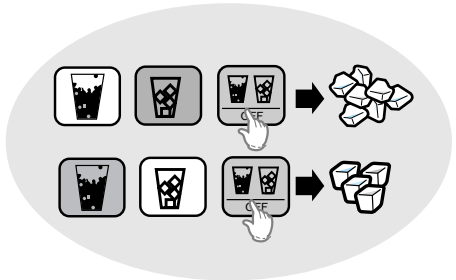

## Push after placing a cup at ice dispenser.

- Please place a cup near the dispenser to prevent ice jumping.
- If you want to use the ice dispenser in conjunction with the cold water dispenser, please use the ice dispenser first.

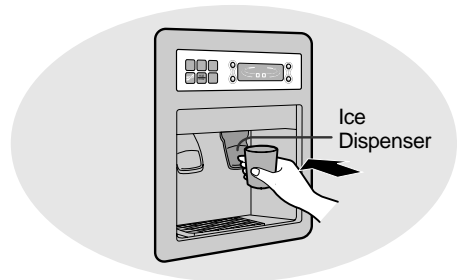

## POOR OPERATION

### Ice is gathering

- When the ice is gathering, taking it out and throw away.
- If the size of ice is too small, you have to control the amount of water supplied.  
Refer to installation advice or contact SAMSUNG service center.

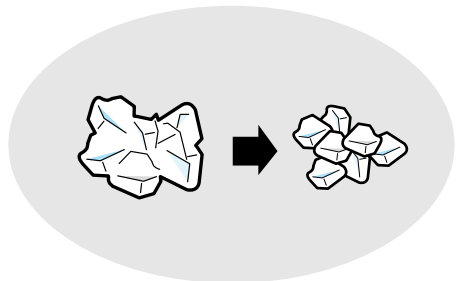

### Ice and cold water explained.

- ✱ The service person connects household water pipe with the hose at the back of refrigerator.
- Water from the household water pipe is filtered through ice making filter installed on refrigerator and then stored. Stored water moves to the ice making machine when it is required. The water also moves to the cold water dispenser when required.

### Power failure.

- Ice in ice storage case is then melted and dropped into the freezer section. Remove ice storage case and empty any accumulated water return the case.
- When the power is turned on after a power failure, CRUSHED ICE is automatically selected.

### New installation

- Newly installed refrigerator can make ice 12 hours after installation.

# COLD WATER DISPENSER

Water function can dispense 6 glasses of water in succession.

After six glasses have been dispensed in succession, please wait for several minutes to allow the stored water to cool again.

## Cold Water

- Push after placing a cup at water dispenser.
- The first 6 glasses of water should be thrown away after installation. This will help to remove the plastic smell of the water storage case.

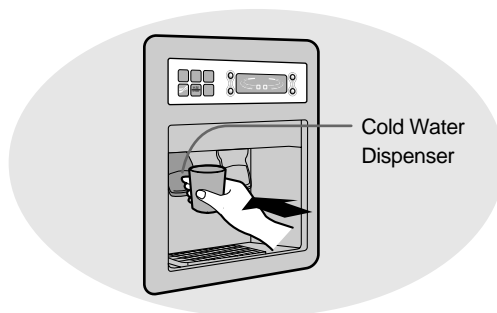

## If the water is not cold

- If the water from the cold water dispenser is not chilled, empty the warm water and add ice from the ice dispenser before filling your glass with water.

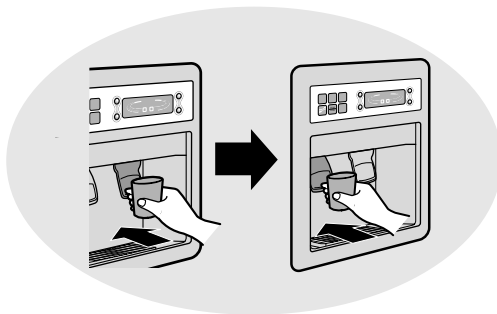

**Do not disassemble the ice-making machine.**



**Do not let children play with the ice/water dispensers.**

- Serious injury can result.



**Do not fully fill the cup with ice.**

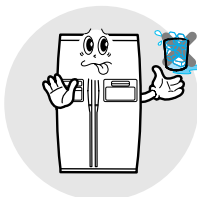

**Do not use a crystal glass or fragile bowl to collect ice.**

- Ice can be used in a crystal glass. However, great care must be taken. The ice must be collected in a sturdy container first. Then it should be added to the crystal glass using tongs.
- Glass or bowl can be broken.

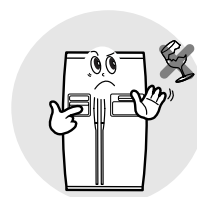

**After installation, please generate ice and water from the ice/water dispensers. This initial output should then be thrown away.**

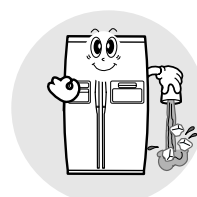

**In case of abnormally coloured ice, please stop operation and contact SAMSUNG service center.**

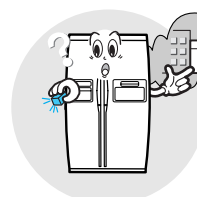

# FOOD STORAGE METHODS



## FROZEN FOOD STORAGE METHODS (NTA, BTA)

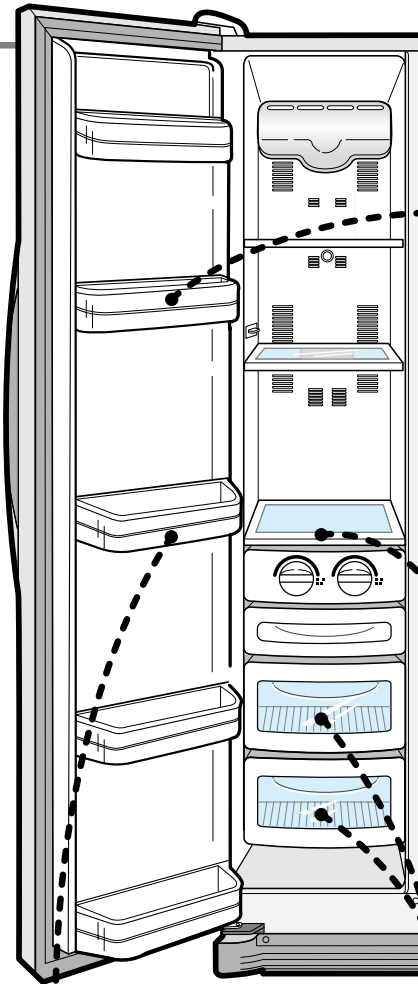

### Multiple guard.

- Small packages of frozen foods.

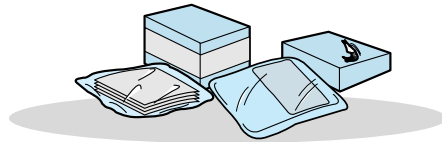

### The enforced glass shelf of freezer section

- Frozen foods can be stored here.
- ✱ The reinforced glass shelf can be used safely because it will not break if it falls.

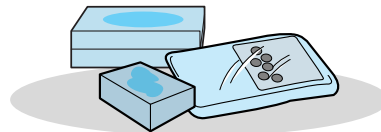

### Door guard.

- Frozen foods such as ice-cream can be stored here.



### Meat and dried goods storage compartment.

- Use this compartment to store meat and dried goods. Stored food should be wrapped securely using foil or other suitable material.

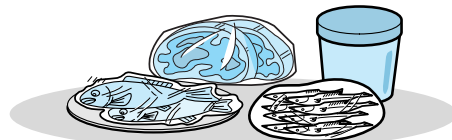



## HOW TO MAKE ICE

1

Please pull out ice container.

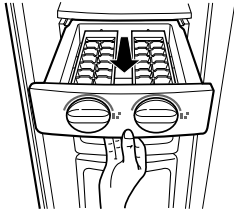

2

Add water until the water level reaches the water height indicator.

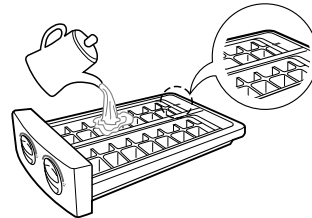

3

Please reinsert the ice tray.

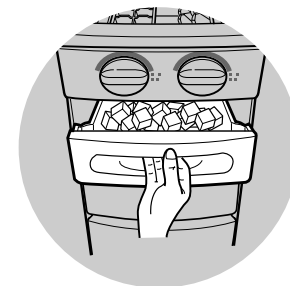
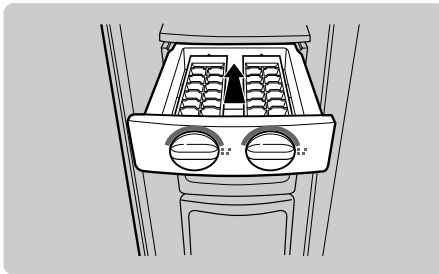

### How to store ice

- The ice will be made in about 2-3 hours. After it is made, turn the ice container knob in order to tilt the ice container. This will release the ice into the ice storage container. If any ice remains, repeat the turning action.
  - Do not turn the ice container knob until the ice is fully formed.
  - Using liquid other than water for ice making purposes should be avoided. Liquid other than water can create ice which is difficult to remove.



### When you want to make ice more quickly.

- When you want to make ice quickly or lots of ice, please select the quick function by pressing power freezing button.
- When the freezer is in power freezing mode, ice can become cracked or blurred because air may be unable to escape from the water.



## FROZEN FOOD STORAGE METHODS (FTA,DTA)

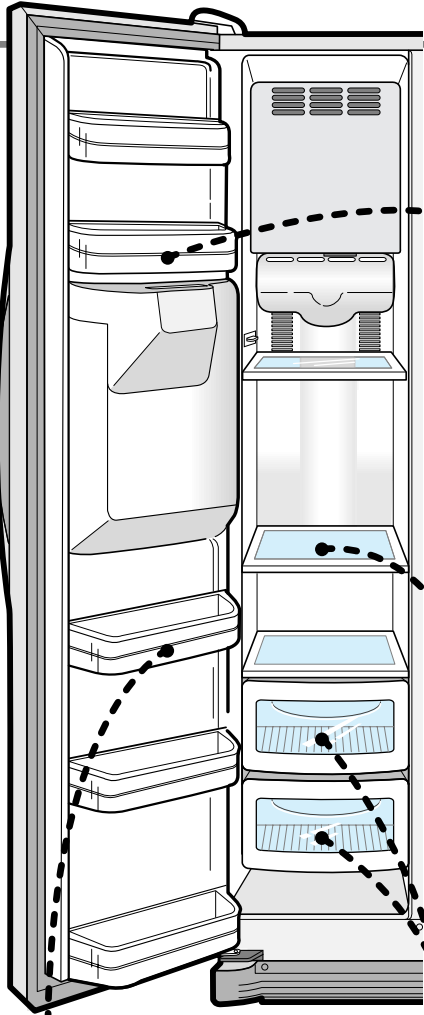

### Multiple guard.

- Small packages of frozen foods.

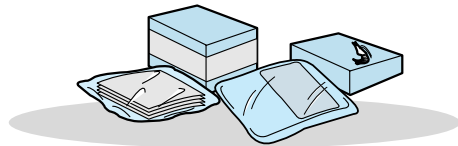

### The enforced glass shelf of freezer section

- Frozen foods can be stored here.
- ✱ The reinforced glass shelf can be used safely because it will not break if it falls.

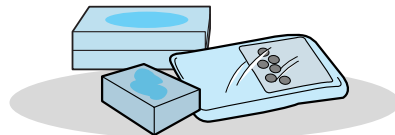

### Door guard.

- Frozen foods such as ice-cream can be stored here.



### Meat and dried goods storage compartment.

- Use this compartment to store meat and dried goods. Stored food should be wrapped securely using foil or other suitable material.

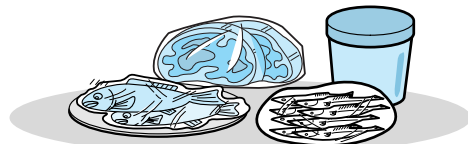

# REFRIGERATED FOOD STORAGE METHODS



## REFRIGERATED FOOD STORAGE METHODS

### The reinforced glass shelf

- ✳ The reinforced glass shelf can be used safely because it will not break if it falls.

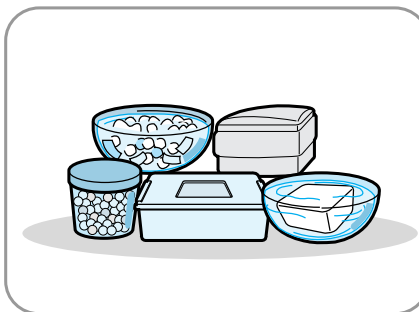

### High-humidity chilled compartment

- ✳ Please meats or fish which will be stored for long periods of time in the freezer section.

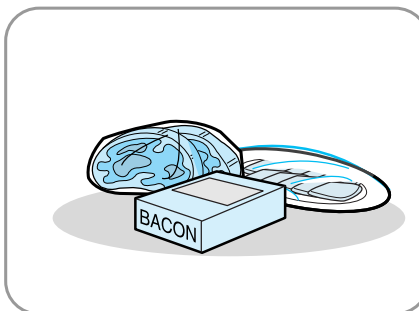

### High-humidity vegetable compartment

- Keeps the vegetables in this compartment.
- ✳ This compartment is air tight. Therefore the cooling system does not directly effect the food stored. Keeps the water in foods and maintains the freshness of the foods for a long time.



### Fruits compartment

- Keep the fruits in this compartment.
- ✳ Preserves freshness for a long time by maintaing the moisture of foods.

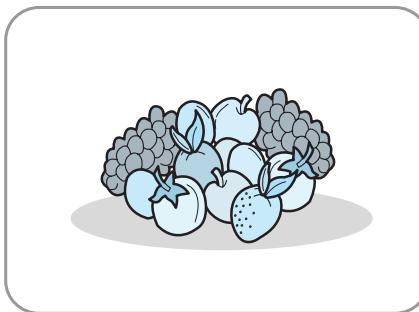

SR-S24FTA(DTA), S25NTA(BTA)  
SR-S25FTA(DTA), S26NTA(BTA)

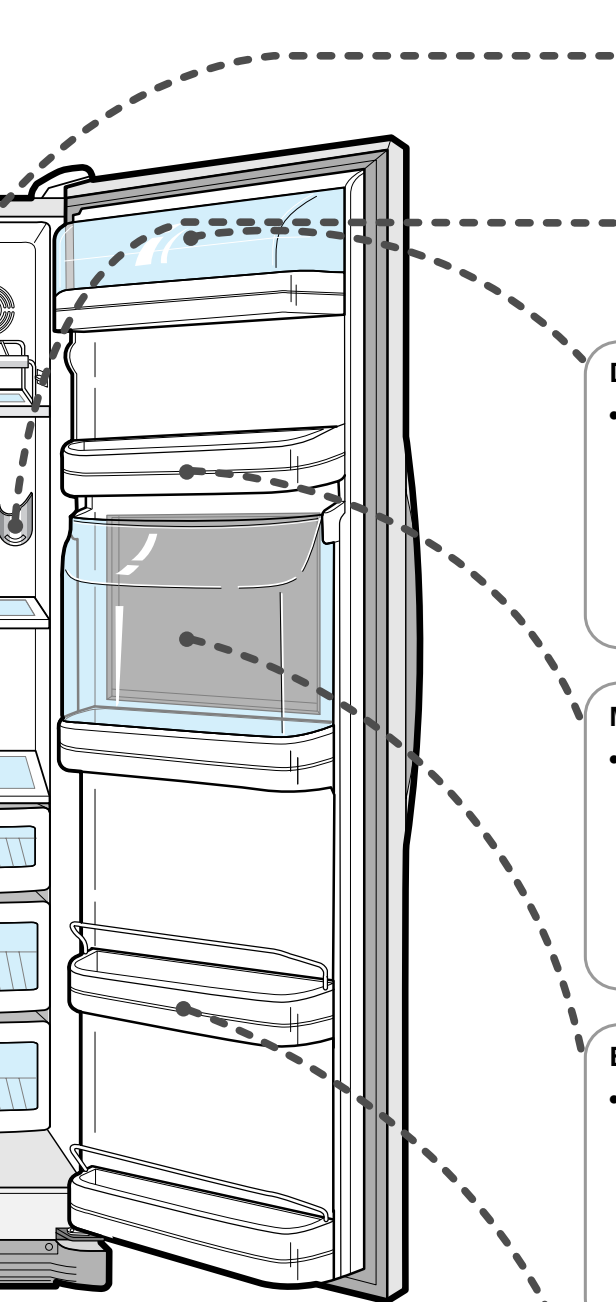

SR-S27FTA(DTA)  
SR-S28NTA(BTA)



SR-S27FTA(DTA)  
SR-S28NTA(BTA)

### Dry compartment

- Can be used to store fatty foods like butter and cheese.



### Multiple guard

- Can be used to store foods with small packages such as milk and yoghurt.



### Extra refrigerating compartment.

- Can be used to store frequently used items such as beverages.



### Beverage shelf

- Can be used to store a variety of bottles, cans, and cartons.



### NOTE

- Put eggs in the egg storage case and then place it on the reinforced glass shelf.

# DISASSEMBLING METHOD FOR FREEZER (NTA)

## The reinforced glass shelf in the freezer section

- Pull the shelf out until it stops. Then raise it upwards and remove.

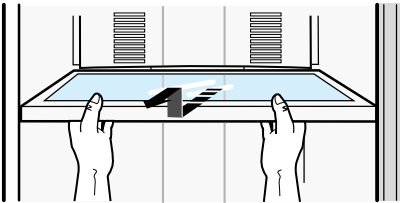

## Multiple guard and door guard

- Grab multiple guard and door shelf by both hands, and then raise it upwards.

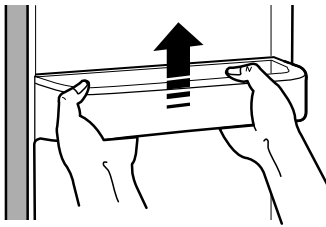

## Meat and dried goods storage compartment

- Remove by pulling the compartment out and raising it slightly.

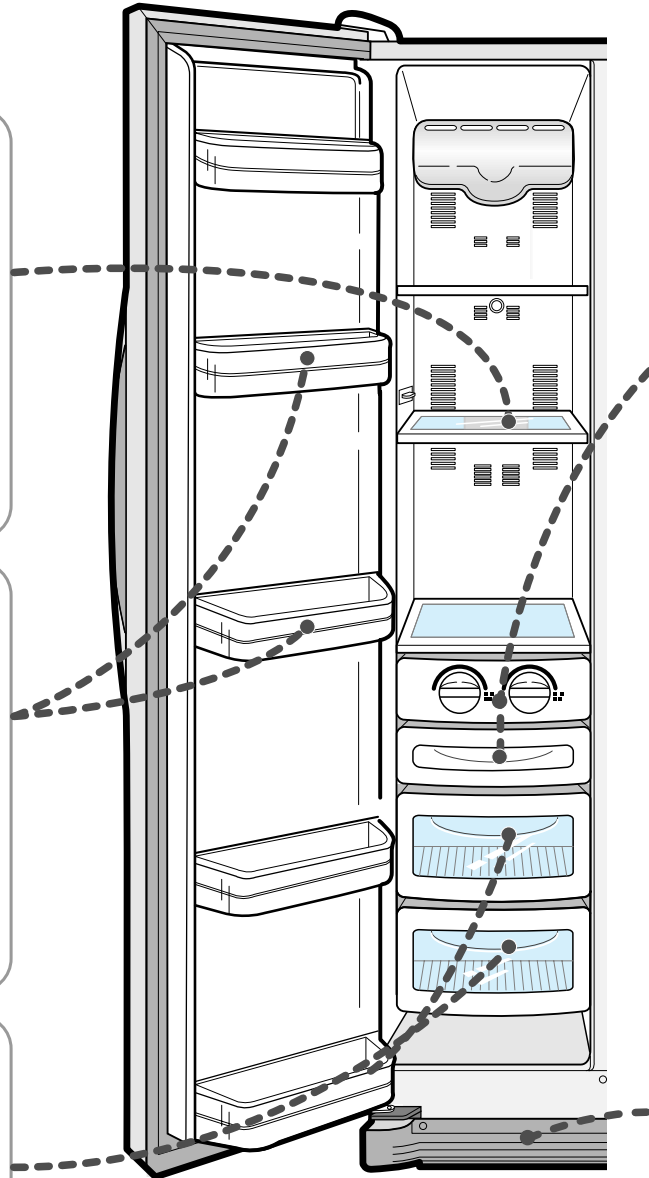
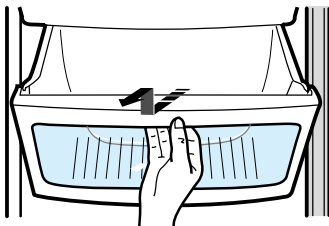

**NOTE**

- Do not use excessive force when disassembling, may cause damage.

### Ice storage container and ice container

- Remove the ice storage container by pulling it forward. Then remove the ice container.

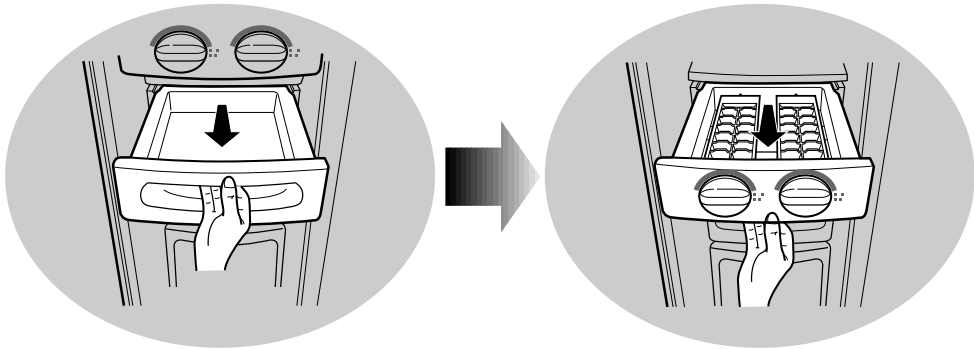

### Leg Coverage

- After opening the doors of the freezer and refrigerator sections please remove the coverage after removing the 3 spiral pins.
- In assembling, set the cover-leg front and fix 3 screws.
- ※ Disassembling is not recommended if unnecessary.

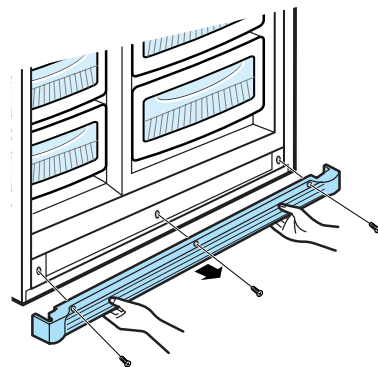

# DISASSEMBLING METHOD FOR REFRIGERATOR

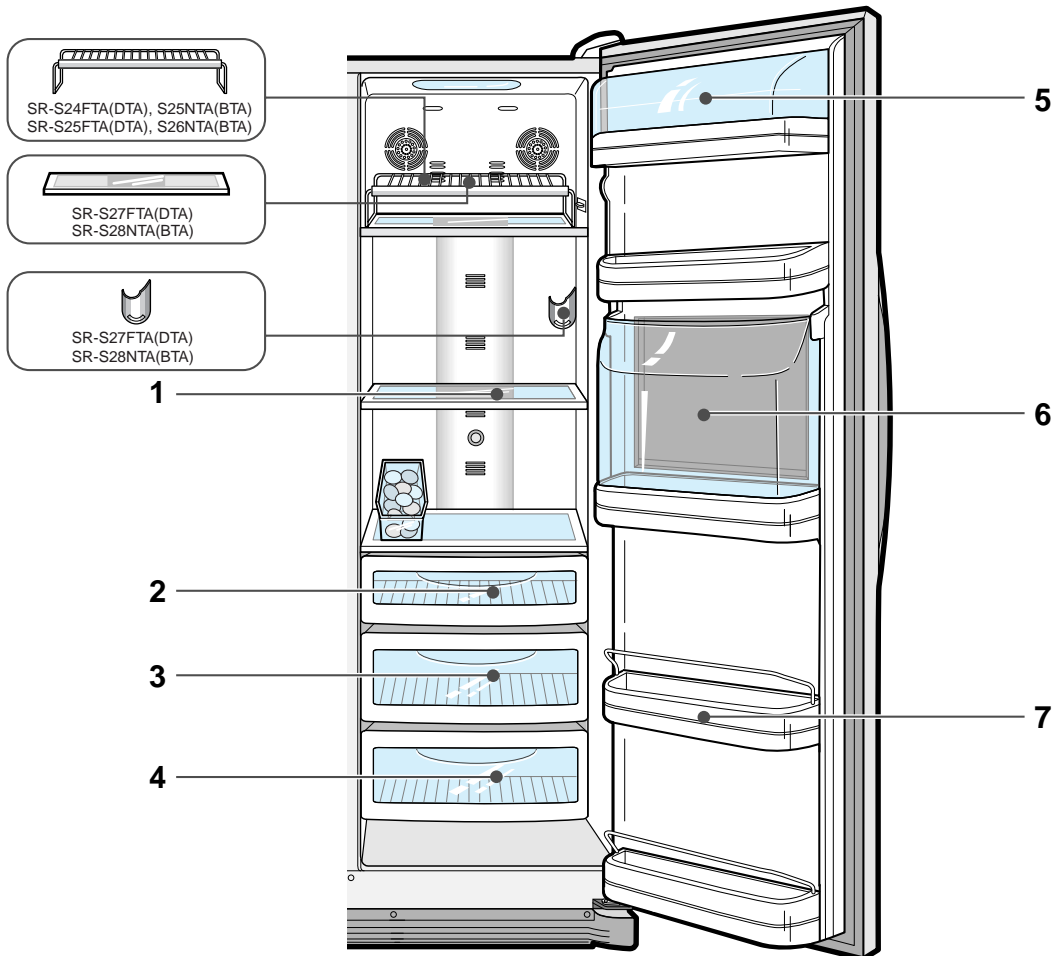

**1**

**The reinforced glass shelf of the refrigerator section.**

- Pull the shelf out until it stops. Then raise it upwards and remove.

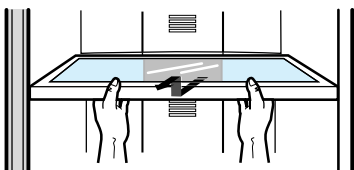

**2**

**High-humidity chilled compartment**

- Remove by gripping the handle and pulling the compartment outward, raising it slightly.

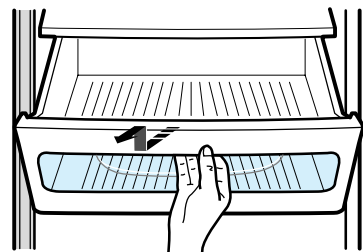

**3****Higt-humidity vegetable compartment and cover**

- Remove by gripping the handle and pulling the compartment outward, raising it slightly.
- Remove the cover by pulling forward.

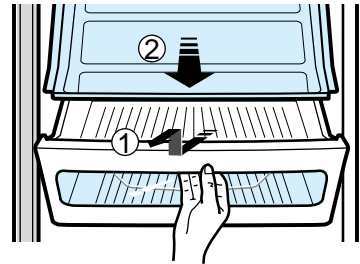
**4****Fruit compartment and cover**

- Remove by gripping the handle and pulling the compartment outward, raising it slightly.
- Remove the cover by pulling forward.

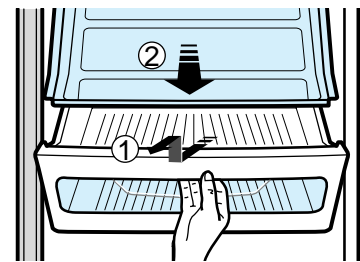
**5****Dry compartment**

- Open the cover slightly. Then hold with both hands, push to the left, and pull.
- Remove the dry compartment by pulling it outwards and raising it upwards.

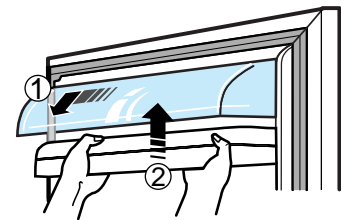
**6****Extra refrigerating compartment**

- Grip the cover with both hands. Then pull outwards while pushing to the left.

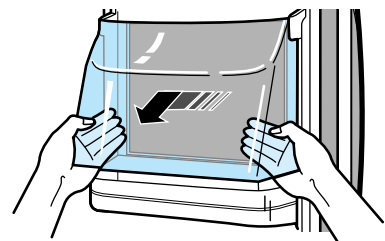
**7****Beverage shelf**

- Grip the shelf with both hands and remove it by raising upwards.

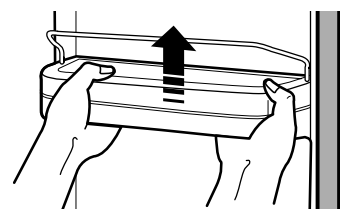

# EXTRA REFRIGERATING COMPARTMENT

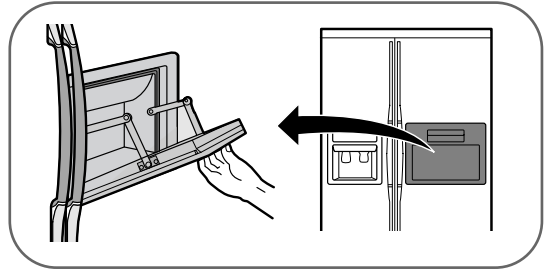

**To gain access to the extra refrigerating compartment, grip the compartment door's handle and pull downwards.**

- The extra refrigerating compartment gives you added convenience because you do not need to open the main refrigerator door. In addition, this saves energy.

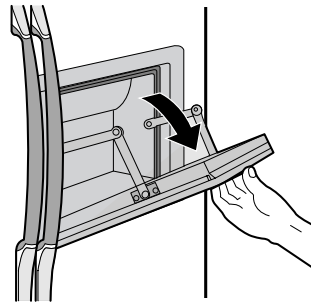

**It is recommended that you use the extra refrigerating compartment for frequently used foods like beverages.**

- An automatic supply of cold air ensures that the correct temperature for food storage is maintained.

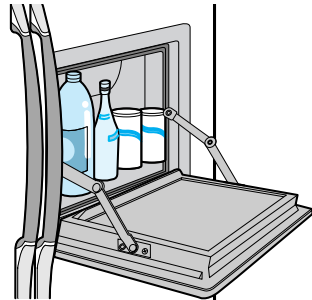

**When the door is open it can be used as a tray to support items such as beverage bottles and glasses.**

- Do not scratch the surface of the door.

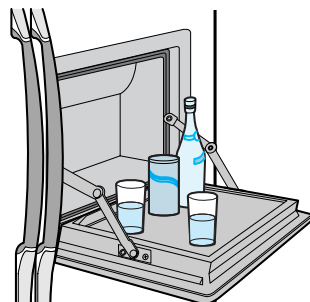

- The door of the extra refrigerating compartment should never be removed. The extra refrigerating compartment cannot function if the door is missing.
- When closing the extra refrigerating compartment's door, be careful not to put your hands or fingers in a position which might lead to them being caught or injured.
- When using the open door as a tray, do not place heavy objects on it. Do not allow children to hang from the open door. Injury or damage to the unit may result.

# CLEANING METHOD FOR ACCESSORIES

## Inside

- Clean parts using disinfectant. Then wipe with a dry cloth.
- After washing accessories, make sure that they are dry before using.

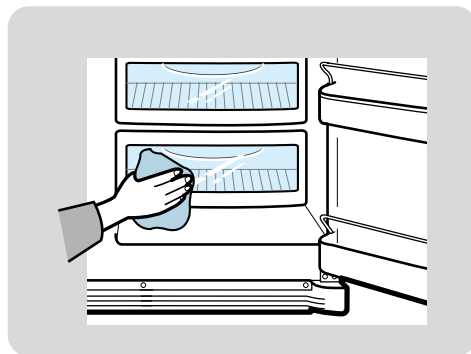

## Exterior

- Wipe the front control panel with a clean cloth.
- The doors and door handles should be cleaned with a mild detergent and dish cloth. Make sure that they are dried with a clean cloth.
- The exterior should be polished with kitchen wax once or twice a year.

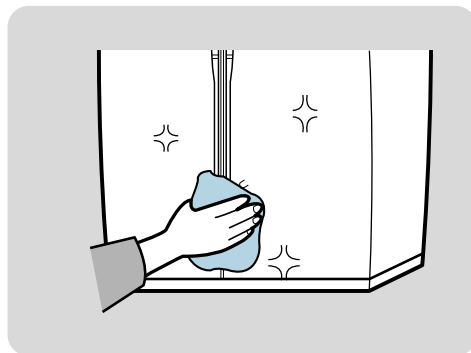

## Back side

- Use a vacuum-cleaner to remove dust once or twice a year.

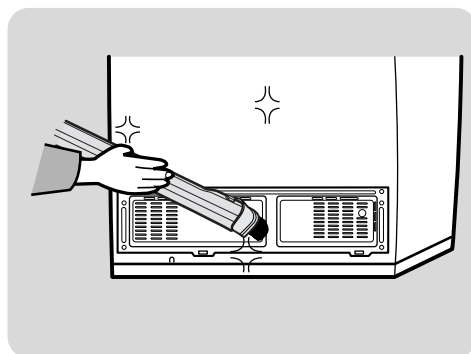

### Ice water dispenser and drainage grid (for DTA, FTA)

- Use a damp cloth to clean the ice/water dispensers. Then wipe with a dry cloth.
- Keep the Ice/water dispenser and drainage grid dry.



### Extra refrigerating compartment (for FTA)

- Use a damp cloth to clean the extra refrigerating compartment. Then wipe with a dry cloth.

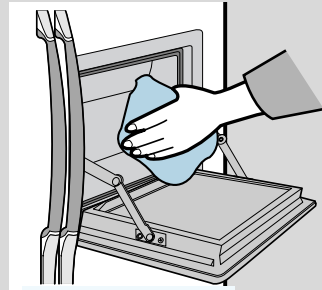

### Rubber door seals

- If the rubber door seals are dirty, the door will not close properly and the refrigerator and freezer sections will be unable to function efficiently. Please make sure that they are cleaned with a mild detergent and a damp cloth. Then wipe with a dry cloth.



### NOTE

- In cleaning or long period of unuse, please remove power plug and keep dry with door open.
- Do not clean by spraying water directly.
- Don't clean with benzene, thinner or car detergent.

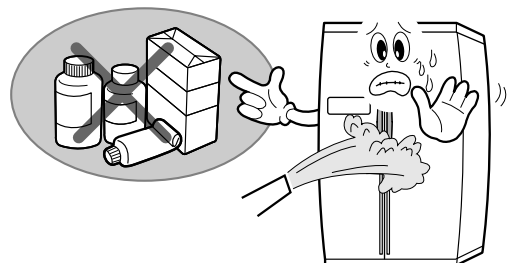

# CHANGING THE INSIDE LAMP



## WRARNING

Before changing the inside lamp, make sure that your unit has been disconnected from the power supply. If you experience difficulty when attempting to change the lamp, contact your service center.



## INDOOR LAMP IN THE FREEZER

**1**

After place  $\ominus$  driver at the designated location (○), please push to arrow direction.

**2**

Pull the cover following arrow.

**3**

After exchanging the lamp in the freezing section. Fix the lamp cover.

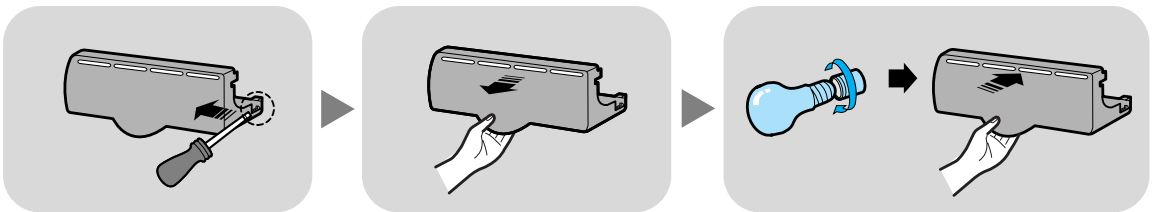

## INDOOR LAMP IN THE REFRIGERATOR

**1**

Remove the screw with  $\oplus$  driver and lamp cover.

**2**

Pull the old interior lamp downward to remove. Then replace with new interior lamp.

**3**

After locate the lamp cover on the original position. Fix the screw with  $\oplus$  driver following arrow direction.

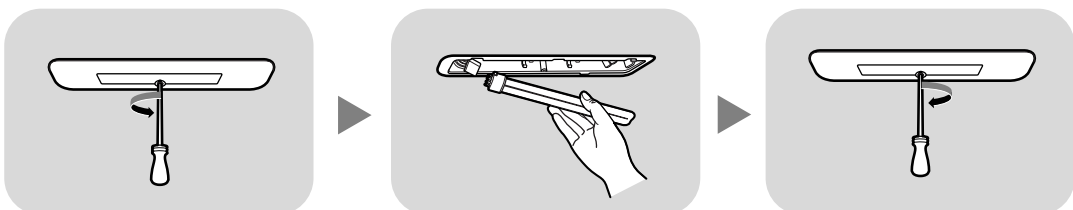

# THE ICE-MAKING FILTER



## What is the ice-making filter?

---

- The ice-making filter is a device which removes impure materials from the water.

## How do I install the ice-making filter?

---

- Connect the ice-making filter provided with water line tap.  
(Please refer to separate manual)
- Please remove the residue in the ice-making filter by passing water in it.

## How often should I change the ice-making filter?

---

- Every 6 month on an ? but it may differ depending on locational specification. (the difference of water quality)

## Filtering chemicals and purifying effect

---

- ▶ The ice-making filter uses carbon to filter chemicals and other impure materials.
- ▶ Purifying effect  
ex) CARBON
  - Remove harmful chemicals in the water.

# CHECKS PRIOR TO SERVICE REQUEST

**The refrigerator doesn't work at all or the refrigeration is weak**

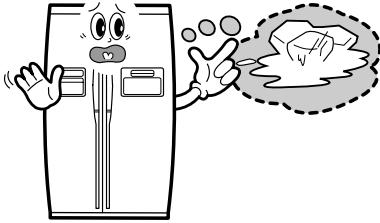

- Check whether power plug is properly connected.
- Check whether power plug fuse is blown or not.
- Is the temperature control on the front control panel indicating WARMER?
- Does sunshine on the refrigerator or is the refrigerator located near a heat source?
- Is the back of the refrigerator too close to the wall?

**The foods in the refrigerator are frozen**

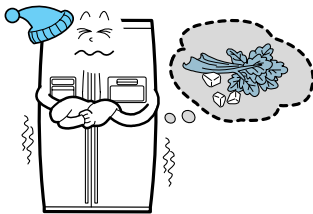

- Is the temperature control on the front control panel indicating COLDER?
- Is the surrounding temperature too low?
- Did you put the watery foods into the cold place where is deep location in the refrigerating section.

**Unusual noise and sounds**

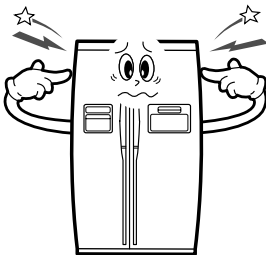

- Please check whether the installation location is flat or weak.
- Is the back of the unit too near to the wall.
- Was any thing dropped behind or under the refrigerator.
- Is the noise from the compressor in the unit?
- Sound of "ticking" may be heard from the unit's inside, but it is not out of order. This sound comes when various parts are contracted or expanded by cooling unction.

**The front corners and sides of the refrigerator are hot. Dewdrops are made.**

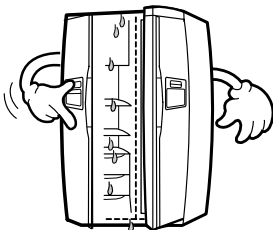

- Heat-proof pipes are installed in the front corners of the refrigerator to prevent dew.
- It can be happened dewdrops in case of high ambient temperature and moisture, door opened too long, preserve the watery foods without wrapping in the refrigerating section.

**Ice doesn't come**

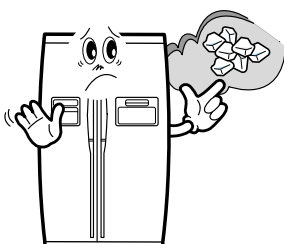

- Did you stop the ice-making function?
- Is there no ice in ice storage case?
- No water supply or no connection with water pipe at refrigerator?
- Is the temperature in freezer section too warm? (Select the temperature button 'COLDER')
- Did you allow 12 hours to pass after installation? It is necessary to wait for this period of time before making ice.

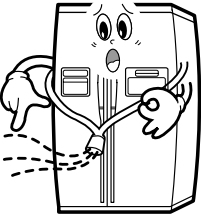
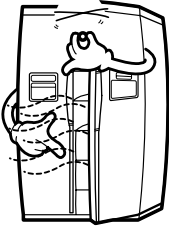
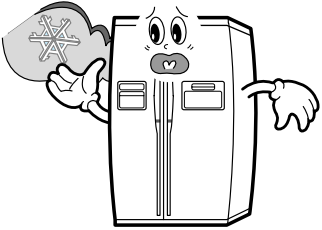
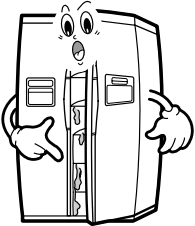
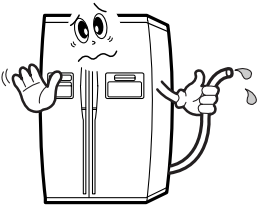
<p><b>Water babbling in the refrigerator</b></p> 	<ul style="list-style-type: none"> <li>• This is a babbling of refrigerant which makes strong sound inside.</li> </ul>
<p><b>Odoring inside</b></p> 	<ul style="list-style-type: none"> <li>• You did not seal the foods which have a strong odour or foreign material is tucked at the coding entrance.</li> <li>• Seal foods which have a strong odour. Throw away any food which has gone off.</li> </ul>
<p><b>A frost on the wall of freezing section</b></p> 	<ul style="list-style-type: none"> <li>• Is the air blocked?</li> <li>• Allow the space between foods to circulate air efficiently.</li> <li>• Is the door closed fully?</li> </ul>
<p><b>Dewdrops on the walls of refrigerating section and vegetables</b></p> 	<ul style="list-style-type: none"> <li>• In cause of the opened door for a long time and preserve watery foods without wrapping.</li> <li>• Air-tight storage may be necessary.</li> </ul>
<p><b>No water supply</b></p> 	<ul style="list-style-type: none"> <li>• Water pipe closed or no connection?</li> <li>• Water pipe blocked?</li> <li>• Is the water tank frozen because the temperature in the refrigerator section is too low? Select a warmer setting via the front control panel.</li> </ul>

# MEMO



**ELECTRONICS**