

**SENCOR®**

**Let's live!**

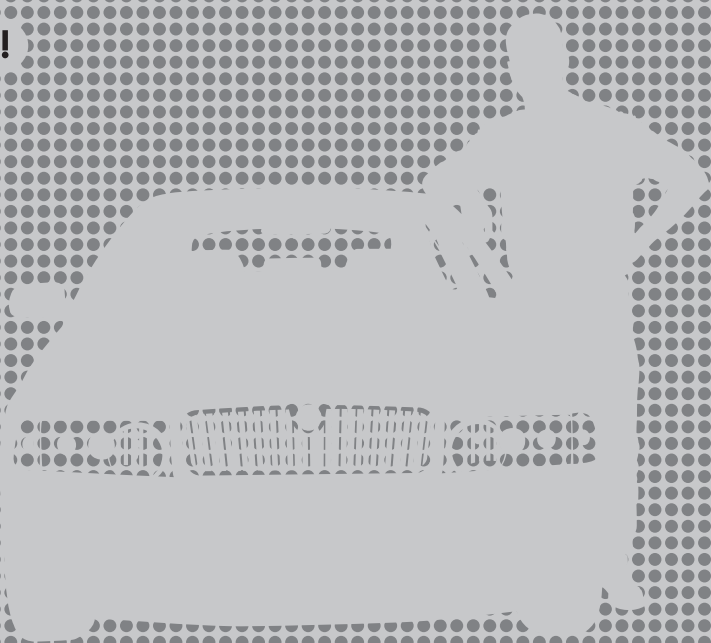

**CAR RADIO  
WITH MULTIMEDIA PLAYER,  
RDS AND RADIO RECEIVER**

**SCT 3017MR**

**USER'S MANUAL  
EN**





# Contents

1. Installation instructions.....	2
2. Installation.....	3
2.1. Installation procedure.....	3
2.2. Electronic connection.....	5
3. Control panel and remote control.....	6
3.1. Remote control and batteries.....	6
3.2. Basic controls.....	7
3.3. Radio.....	9
3.4. RDS control.....	11
3.5. USB / SD INPUT.....	14
4. Troubleshooting.....	16
5. Technical specifications.....	17

To be able to use this product properly, read this user's manual carefully and keep it for future reference. If you plan to give (sell) this device to a third person, include all documentation, including this manual, with the transaction.

## 1. Installation instructions

- The device is powered by 12 V DC. Before installing the unit, make sure that your vehicle is powered by 12 V with the minus pole to the ground.
- Minus pole of the battery must be disconnected before making connections. This will reduce the likelihood of damage to the equipment by possible short circuits.
- Make sure that the wiring of the unit is correct according to the colored wires and as pictured in the diagram. Incorrect connection may cause failure of the unit or damage to the car electrical system.
- Do not forget to connect the speaker wire labelled (-) to (-) terminal. Never connect the left and right speaker wire together or to the body of the vehicle.
- Do not cover the ventilation openings of the unit. Their blockage could cause overheating within the unit and lead to its damage or fire.
- This device can play MP3 files and WMA digital music files.
- Do not try to modify the unit, any modification of the unit can cause malfunction or damage of the device.
- Stop the vehicle before carrying out any operation that could interfere with your driving.
- Do not switch on the device in extremely high or low temperatures. Normal operation temperature is between -20 and +60 °C.



### **NOTICE:**

**Ensure correct wiring, especially of power (greater consumption) and of memory backup (small consumption). This keeps the tiny consumption in off-mode and storing your presets in the radio memory.**

## 2. Installation

The following accessories are included.

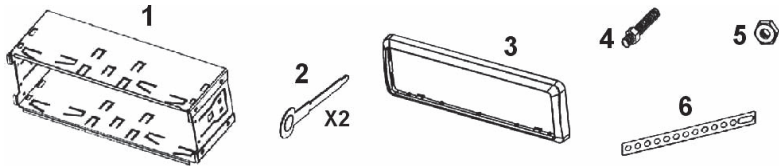

### 2.1. Installation procedure

1. Insert the mounting sleeve into the dashboard.

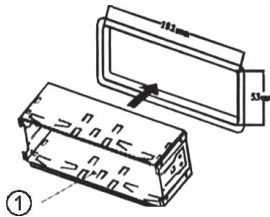

2. Bend the tabs inwards into the dashboard for secure installation.

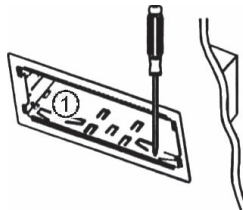

- If necessary, use a metal strap for fastening the rear part of the unit. The strap may be bent manually into a required angle.

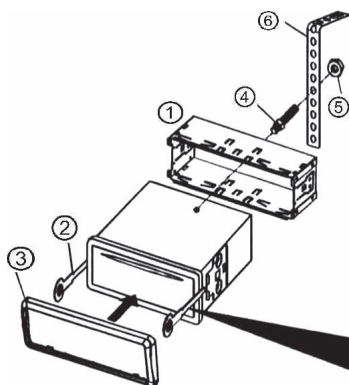

- To release the unit insert the keys on either side and pull the unit out of the dashboard.

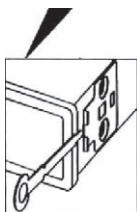

#### Notes:

- Store small objects in a location that is not accessible to children.
- Installation only with supplied screws.
- Installation changes according to the type of car and supplied parts. You should have the unit installed by a qualified technician.

#### Disconnecting the front panel

Before disconnecting the front panel make sure that the unit is switched off. Press the release (disconnect) button of the panel and the front panel opens. Press **opened** front panel to the right and remove the panel from the left pivot of the main unit by gently pulling the left side forward. Then easily slide the panel slightly to the left to pull the panel off the right pivot. The panel is released.

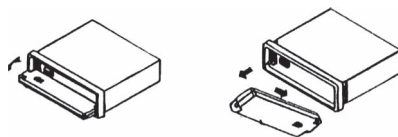

## Connecting the front panel

First, insert the right side of the **opened** panel in the right pivot of the main unit. Then press the left side of the panel to the left pivot of the main unit until it snaps. Use slight movement to test that the panel easily rotates on pivots, or remove it and try again. Only then close the panel by upward move until the lock snaps. The panel is installed, the connection is well connected.

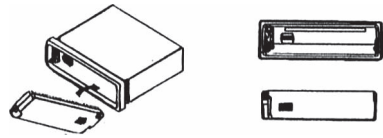

### NOTICE:

Do not touch the connectors on the front panel of the main unit – poor electrical contact might be consequence. Wipe the connectors only using clean and dry cloth. After disconnecting the front panel from the main unit, store in a protective case (if available).

## 2.2. Electronic connection

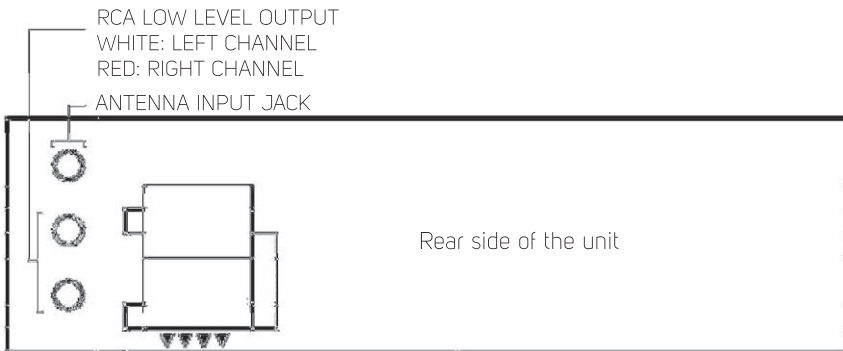

### PLUG A (INSERT INTO PLUG (A))

- WHITE: FRONT LEFT SPEAKER (+)
- WHITE / BLACK: FRONT LEFT SPEAKER (-)
- GREEN: REAR LEFT SPEAKER (+)
- GREEN / BLACK: REAR LEFT SPEAKER (-)
- GREY: FRONT RIGHT SPEAKER (+)
- GREY / BLACK: FRONT RIGHT SPEAKER (-)
- PURPLE: REAR RIGHT SPEAKER (+)
- PURPLE / BLACK: REAR RIGHT SPEAKER (-)

### PLUG B (INSERT INTO PLUG (B))

- RED: POWER (B+)
- BLACK: GROUND / SKELETON (B-)
- YELLOW: MEMORY BACKUP (B+)
- BLUE: CAR ANTENNA POWER SUPPLY

### 3. Control panel and remote control

Following pictures show control panel and remote control. Images and symbols in the figure above may differ from the actual control panel and remote control. Follow the exact functions, which are on the device.

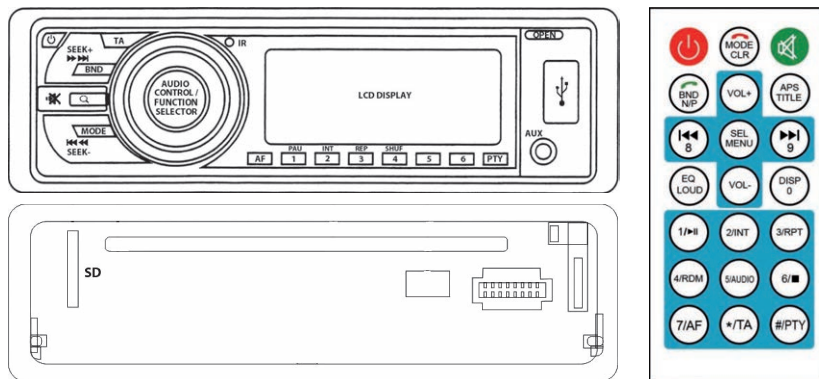

#### 3.2.1. Batteries replacement

If the length of the range of the remote control shortens or the device does not respond to any functions during operation, replace the battery. Make sure that you keep the correct polarity when inserting the battery in the remote control. Please see the following procedures for replacing the battery.

#### 3.1. Remote control and batteries

- Do not expose the remote control and batteries to direct sunlight or heat sources, such as radiators, heat exchangers, ovens or other appliances (including amplifiers) producing heat. Do not use and do not leave the device near an open fire.
- Remote control and batteries may not be exposed to dripping or running water and no objects filled with water should be placed on them, for example, vases. Protect them from getting wet, from being sprayed or from spilled liquid of any kind. Do not use outdoors. Failure to respect these instructions can lead to the remote controller or battery becoming damaged.
- Do not use the device close to water.
- The impact the battery disposal has on the environment shall be monitored carefully.
- Using the batteries incorrectly can result in leakage and corrosion. Follow the following instructions to ensure proper remote control operation:
  - Do not insert the batteries in the wrong direction.
  - Do not charge, heat, open or short the batteries.
  - Do not throw batteries into a fire.
  - Do not leave dead batteries in the remote controller.

- Do not combine various types of batteries or old and new batteries.
- If you do not use the remote controller for a longer period of time, remove the batteries to prevent damaging the remote controller by the batteries leaking out.
- If the remote control does not work properly or its effective range decreases, change all the batteries for new ones.
- If there is an electrolyte leakage from the batteries, have the remote control serviced by an authorized technician.

## 3.2. Basic controls

Main unit = MU

Remote control = RC

### On/Off

MU: Press the button  to switch the device on or off.

RC: Press the button  to switch the device on or off.

### Mode selection

MU: Press MODE repeatedly to select the required mode.

RC: Press MODE repeatedly to select the required mode.

### Disconnection of the front panel

MU: Press the button **OPEN** to release the control panel from the main unit. Panel tilts down. Press the tilted panel to the right and disconnect it from the main unit for securing it against theft. Also, after you tilt down the panel you can insert SD card into the slot for playing multimedia files.

### AUX input

MU: Connect external device to the AUX connector for playing sound through the unit.

### Volume control

MU: Turn the sound selector on the main unit to set the volume level.

RC: Press repeatedly **VOL + / VOL-** or press and hold **VOL + / VOL-** to set the volume level.

### Muting sound

MU: Press the button  to mute the sound and again to resume it.

RC: Press the button  to mute the sound and again to resume it.

### Volume setting (Audio Control / Function Selector)

MU: Press repeatedly the controller **Audio Control / Function Selector** to select control mode. Turn the controller **Audio Control / Function Selector** after the selection to set value:

- **BAS** (bass control)
- **TRE** (treble control)
- **BAL** (left right balance)
- **FAD** (front rear balance)
- **LOUD ON/LOUD OFF** (loudness)

- **CLASSIC/POP/ROCK/DSP OFF** (equalizer setting )
- **LOCAL/DX** (local/ remote reception)
- **STEREO/MONO** (stereo/mono selector)
- **VOL** (volume control)

RC: Press repeatedly the button **SEL** to select control mode. Press buttons **VOL+ /VOL-** after selection to set value:

- **BAS** (bass control)
- **TRE** (treble control)
- **BAL** (left right balance)
- **FAD** (front rear balance)
- **LOUD ON/LOUD OFF** (loudness)
- **CLASSIC/POP/ROCK/DSP OFF** (equalizer setting )
- **LOCAL/DX** (local/ remote reception)
- **STEREO/MONO** (stereo/mono selector)
- **VOL** (volume control)

**Note:**

Choices local /remote reception and stereo /mono selection are available only in FM radio mode.

### Equalizer

MU: See previous section **Setting audio (Audio Control / Function Selector)**.

RC: Press briefly and repeatedly the button **EQ**, to select the equalizer mode, Classic/Pop/Rock/Off (OFF).

### Loudness

MU: See previous section **Setting audio (Audio Control / Function Selector)**.

RC: Press and hold the button **LOUD** to switch on or off loudness (bass boost).

### Display of time and settings

RC: During operation of the unit press **DISP** to display time.

Manual setting (has preference): In regular mode press and hold the button **DISP**, until the clock numbers start flashing. Using **VOL+ / VOL-** set hours. Press the button **SEL**, to set minutes. Using **VOL+ / VOL-** set minutes. When you complete the setting, press briefly the button **DISP** and start the clock.

**Note:**

Once the RDS data are acquired with time and you do not have the time on the device set manually, the clock synchronizes with the broadcast time. The time since connecting the battery is calculated in. The obtaining of time from broadcast is not immediate, leave the reception of station with RDS on for a while. If the station broadcasts also other RDS data, you can switch between them by pressing **DISP**.

### LCD display

MU: LCD display shows the status of the operation of the unit.

### Remote control sensor

MU: You can control the main unit using remote control. Point the remote control at the IR remote control sensor and press the control buttons to operate it.

## 3.3. Radio

### Mode selection

MU: During operation press repeatedly the button **MODE** and select the radio mode.

RC: During operation press repeatedly the button **MODE** and select the radio mode.

### Bandwidth selection

MU: Press repeatedly **BND** to select the required bandwidth.

RC: Press repeatedly **BND** to select the required bandwidth.

### Automatic search and store stations

MU: Press and hold the button **Q** in the radio mode while the functions TA, AF & PTY are off to start search for a frequency and signal power control until the search is finished (message "SEARCH"). Strong station signals are then saved in the preselected numbers 1-6. The device then goes through the stations stored in memory and starts brief broadcasts. Press again **Q** during this process to stop this function.

RC: Press and hold the button **APS** while the functions TA, AF & PTY are off to start frequency search and signal power control until the search is finished. Strong station signals are then saved in the preset numbers 1-6. The device then goes through the stations stored in memory and starts brief broadcasts. Press again the button **APS** during this process to stop this function.

**Note:** the automatic search saves stations with acceptable/good quality reception. In areas with poor reception(e.g. also due to inadequate antenna) it does not store any usable station. In this case, improve the reception with a better quality antenna.

### Manual search and store stations

You can store the station (found using the buttons **▶▶/◀◀**) in memory of the selected bandwidth under the numbers 1-6 by pressing and holding a number from 1-6. While you hold the selected number, it flashes. Once the light stops flashing, the station is saved.

MU: use the buttons on the main unit.

RC: Use the buttons on the remote control.

### Manual tuning up/down

MU: Press and hold **▶▶/◀◀** to activate manual tuning and the word "MANUAL" appears briefly on the LCD display. When using manual tuning mode press repeatedly the buttons **▶▶/◀◀** to tune frequencies up and down to find the required frequency. In the event that manual tuning will not be active for 5 seconds automatic mode will be set again and the word "AUTO" appears briefly on the LCD.

RC: Press and hold briefly **▶▶/◀◀** to activate manual tuning and the word "MANUAL" appears briefly on the LCD display. When using manual tuning mode press repeatedly the buttons **▶▶/◀◀** to tune frequencies up and down to find required frequency. In the event that manual tuning will not be active for 5 seconds automatic mode will be set again and the word "AUTO" appears briefly on the LCD.

### Memory presets

Each bandwidth (FM1-3, AM1-2) selected using **BND**, has 6 preset positions.

MU: Press in the radio mode one of the numbers 1-6 to select a station which was stored in memory.

RC: Press in the radio mode one of the numbers 1-6 to select a station which was stored in memory.

### Automatic scan of preset stations

MU: Press briefly **Q** in the radio mode. The device will go through stations stored in memory and briefly starts their broadcast. Press again **Q** during this process to stop this function.

RC: Press briefly **APS** in the radio mode. The device will go through stations stored in memory and briefly starts their broadcast. Press again the button **APS** during this process to stop this function.

### Automatic search up/down

MU: In the radio mode press button **▶▶/◀◀** while functions TA, AF & PTY are off to search frequencies up/down to find the next strong signal.

RC: In the radio mode press button **▶▶/◀◀** while functions TA, AF & PTY are off to search frequencies up/down to find the next strong signal.

### Local/remote reception

MU: In the radio mode press repeatedly **FUNCTION SELECTOR**, until you reach the local (LOCAL) and remote (DX) mode. Then turn the controller **FUNCTION SELECTOR** to change between local (LOCAL, reception of strong station signals) or remote (DX reception of weak station signals).

RC: In FM radio mode press repeatedly **SEL** until you reach the local (LOCAL) and remote (DX) mode. The using **VOL+/VOL-** select radio reception as local (LOCAL) setting (reception of strong station signals) or remote (DX) setting (reception of weak station signals as well).

### Mono / Stereo

MU: In FM radio mode press repeatedly **FUNCTION SELECTOR**, until you reach stereo (STEREO) and mono (MONO) mode. Then turn the controller **FUNCTION SELECTOR** for radio reception in mono (MONO) setting or stereo (STEREO) setting.

RC: In FM radio mode press repeatedly **SEL**, until you reach stereo (STEREO) and mono (MONO) mode. Then using **VOL+/VOL-** select the radio reception in mono (MONO) setting or stereo (STEREO) setting.

**Note:**

When the radio is receiving a stereo signal, the stereo indicator appears on the LCD. The indicator turns off for mono reception, whether it is due to a weak signal or forced by the operator.

## 3.4. RDS control

### 3.4.1. Review of RDS functions

Radio Data System (RDS) is service enabling stations with FM frequencies to broadcast more digital information together with regular program signal. Some of them follow. It depends on the particular station which possible data transmission is used and when. The device monitors the received data, and reacts according to your settings.

**Important notice**

RDS works only in countries or areas that have RDS broadcasts. Not all countries or regions have full RDS broadcast function. RDS may not work properly if the signal is weak or if the stations that are tuned do not broadcast RDS data. RDS reception is affected by geographical conditions.

**AF (Alternative Frequencies)**

List of alternative frequencies providing information on the various transmitters broadcasting the same program in the same or neighbouring area.

**TA (Traffic Announcement)**

Information whether the traffic reports are currently transmitted.

**PI (Program Identification)**

This is a code which identifies an RDS station.

**PS (Program Service Name)**

Name of currently broadcasting station shown on the display. Sometimes it is used for other messages of the broadcaster.

**TP (Traffic Program)**

Information that the given station uses a system of traffic reports – traffic announcements.

**PTY (Program Type Codes)**

This code is used to mark the current program material. With this function, you can search for stations that match your selected program type, such as news, light music, sports and more. The types of programs are quite numerous and the inclusion of a broadcast under certain type depends on the station programming.

**EON (Enhanced Other Networks Information)**

It is an additional service that allows radio to obtain information not only from the current station, but also from other stations of certain network. E.G. if traffic reports are not broadcast by your station, but by another station in the same network.

### 3.4.2. Setting RDS mode

Set the device according to your needs so that when you receive the specific RDS information (described above) it responds accordingly.

#### Alternative frequencies AF

When the AF is on (AF ON) the device will monitor the quality of the reception. If it is reduced it searches according to broadcast data a better quality reception of the same station and if it finds it, it automatically switches to stronger signal of given station.

MU: Press **AF** to switch on or off the AF operation. The AF indicator comes on or off.

Or – press and hold controller **FUNCTION SELECTOR** to set RDS function and in this mode press repeatedly the control **FUNCTION SELECTOR**, until it shows **AF ON /AF OFF**. Then turn the controller **FUNCTION SELECTOR** to select on (AF ON) or off (AF OFF).

RC: Press **AF** to switch on or off the AF operation. The AF indicator comes on or off.

OR press and hold **SEL** to set RDS functions and in this mode press repeatedly **SEL** until it shows **AF ON/AF OFF**. Then using **VOL+/VOL-** select either on (AF ON) or off (AF OFF).

#### Note:

When the AF mode is on and you use the buttons **▶▶/◀◀** to search for stations, the device will always find stations, which provide RDS broadcast.

#### Traffic announcements

When TA function is switched on, the device searches for a station that broadcasts traffic announcements ("TA SEEK"). Once it finds it, it stays tuned to it and the indicator TP is on. If the reception quality drops, the search starts again for reception of another station with sufficient quality.

MU: Press **TA** to switch on or off the reception of the traffic announcements function. The TA indicator comes on or off.

Or – press and hold controller **FUNCTION SELECTOR** to activate various functions and press repeatedly controller **FUNCTION SELECTOR** in this mode until **TA ON/TA OFF** is displayed. Then turn the controller **FUNCTION SELECTOR** to select on (TA ON) or off (TA OFF).

RC: Press **TA** to switch on or for function of reception of traffic announcements. The TA indicator comes on or off.

Or – press and hold **SEL** to activate various functions and press repeatedly **SEL** in this mode until **TA ON/TA OFF** is displayed. Then using **VOL+/VOL-** select either on (TA ON) or off (TA OFF).

If the TA mode is on and currently broadcasts traffic reports:

- the device increases the volume to level set by you as TA-V if you currently listen to lower volume than the one stored as TA-V (test the correct volume and set it prudently).
- the TA indicator flashes on the screen or the display shows the text "TRAFFIC"

- when the device is in a different operating mode than FM radio, it temporarily switches to the radio and switches on EON linked station when EON function detects traffic report on another station.

### Setting volume for traffic report TA-V

MU: Press and hold the controller **FUNCTION SELECTOR** to activate various functions and press repeatedly controller **FUNCTION SELECTOR** in this mode until **TA-V** is displayed. Then turn the controller **FUNCTION SELECTOR** to set the volume for traffic announcements.

RC: Press and hold briefly **SEL** to activate various functions and press repeatedly the button **SEL** in this mode until **TA-V** is displayed. The using **VOL+/VOL-** set volume for the traffic announcements.

When the TA function is on:

- And you use the buttons **▶▶/◀◀** to search stations it always finds the stations, which provide TA broadcasts.
- A station with TP information is tuned, TP appears on the display.

### Regional programs

MU: press and hold **AF** to activate regional programming. Press repeatedly the button **AF** in this mode to switch on or off the regional program (REG ON/REG OFF).

RC: Press repeatedly the button **AF** in this mode to switch on or off the regional program (REG ON/REG OFF).

At certain times some broadcasting stations may change their program from normal broadcasting to regional. When the regional mode is off, the identification of region in PI code is ignored. The radio can switch to local variant of broadcast of current program. When the regional broadcast mode is on, the radio switches only to a program bearing the exact same PI code.

### Setting EON local / remote

MU: press and hold the button **TA** to enter the mode. Press repeatedly **TA** to select local EON (EON LOC) or remote EON (EON DX).

RC: press and hold the button **TA** to enter the mode. Press repeatedly **TA** to select local EON (EON LOC) or remote EON (EON DX).

Modes local EON and remote EON should reduce unwanted switching of EON TA, when EON TA is received from a current station and the radio switches to EON linked station, but no information is received, because the EON linked station is too remote. The radio switches back. During this process, the listener hears the wrong program or the sound is switched off temporarily.

### EON local mode

When the field strength of EON is below a threshold level, the radio does not tune in to this station and the listener hardly hears any noise,

### EON remote mode

EON remote mode switches based on information from the current station.

### PTY program – selection

MU: Press repeatedly **PTY** to select **PTY Music Group** (music) / **PTY Speech Group** (spoken word) / **PTY Off** (PTY off).

Press and hold briefly the controller **FUNCTION SELECTOR** to activate various functions and press repeatedly the controller **FUNCTION SELECTOR** in this mode until PTY is displayed. Then turn the controller **FUNCTION SELECTOR** to select the required PTY mode (music, spoken word, off).

When you select the mode “Music” or “Spoken word” press controller **FUNCTION SELECTOR** to enter or turn the controller **FUNCTION SELECTOR** to select the required type of broadcast station.

RC: Press repeatedly **PTY** to select **PTY Music Group** (music) / **PTY Speech Group** (spoken word) / **PTY Off** (PTY off).

Press and hold briefly **SEL** to activate various functions and press repeatedly the button **SEL** in this mode until **PTY** is displayed. Then using **VOL+/VOL-** select the required PTY mode (music, spoken word, off).

After selection of the PTY mode the radio starts to search the matching PTY information and stops when it detects the matching PTY information. If a matching PTY information does not exist, PTY mode returns automatically to regular mode.

## 3.5. USB / SD INPUT

### Selection of USB / SD mode

MU: During operation press repeatedly the button **MODE** and select either USB or SD input.

RC: During operation press repeatedly the button **MODE** and select either USB or SD input.

### USB port

MU: Insert the USB device in the USB port to play music files MP3/WMA. Once the device is inserted into USB port the playing will start automatically.

### SD slot

MU: Press **OPEN** to tilt down the front panel. Insert SD card into SD slot for playback of music files MP3/WMA.

#### Note:

Make sure that you insert the USB device / SD card the correct way. Do not insert the USB device /SD card in the unit by force. In that case you could damage the USB device / SD card and the unit.

### Play/Pause (PLAY / PAUSE)

MU: Press **PAU (1)** to pause playback and to resume regular playback. “PAUSE” appears on the display.

RC: Press **▶|| (1)** to pause playback and to resume regular playback. “PAUSE” appears on the display. In stop mode press **▶|| (1)** to start playback from the beginning.

**Fast forward / Fast rewind (FAST FORWARD / FAST REWIND)**

MU: Press and hold buttons **▶▶/◀◀** for fast forward or fast rewind. When the button for search is released the device will continue regular playback.

RC: Press and hold buttons **▶▶/◀◀** for fast forward or fast rewind. When the button for search is released the device will continue regular playback.

**Music selection**

MU: Press repeatedly **▶▶/◀◀** to select song. Press buttons **5 / 6** to select 10 songs in one step (up or down) to select the desired track. Press and hold button **5 / 6** to select directory for playback (available for devices with directories).

RC: Press repeatedly **▶▶/◀◀** to select song. Press **APS** to enter the track selection mode and here use the buttons **VOL+/VOL-** or number buttons to select a track and confirm by pressing **SEL**. Press and hold button **5 / 6** to select directory for playback (available for devices with directories).

**Playing intro**

MU: Press **INT (2)** to start or cancel playing intros.

RC: Press **INT (2)** to start or cancel playing intros.

**Repeat playback**

MU: Press **REP (3)** to select playback repeat mode.

RC: Press **RPT (3)** to select playback repeat mode.

**Shuffle playback**

MU: Press **SHUF (4)** to start or cancel shuffle playback.

RC: Press **RDM (4)** to start or cancel shuffle playback.

**MP3 ID3 display**

MU: In the playback of MP3 device mode you can press repeatedly **BND** to display on the LCD ID3 tags of music files. The music files contain directory, album, name of the artist and music.

RC: In the playback of MP3 device mode you can press repeatedly **BND** to display on the LCD ID3 tags of music files. The music files contain directory, album, name of the artist and music.

**Note:**

Depending on the recorded music files the ID3 display will be various or will not be available.

## 4. Troubleshooting

### **Device does not work:**

- Check, if all the wiring is correctly connected.
- Check, if a fuse did not blow.

### **No audio**

- Check, if the speakers are correctly connected.

### **The device “froze”**

- Switch off the device and restart it or disconnect it from power and reconnect.

### **When pressing buttons the device does not react**

- Switch off the device and restart it or disconnect it from power and reconnect.

### **Poor reception or unavailability of radio signal.**

- Check if the antenna is connected and high-quality connection cable is not interrupted.
- The antenna does not have required length. Extend the length of the antenna.
- The antenna is not properly grounded. Ground the antenna properly.

### **No reception of stereo signal**

- Tune the required frequency exactly.
- The signal is too weak, set the MONO mode.

### **The remote control does not work**

- Replace batteries in the remote control.
- Point the remote control at the remote control sensor on the main unit.
- Clean the surface of the sensor.

#### **Note:**

If after the above steps the device still does not work, contact your vendor. Never try to disassemble or repair the device yourself.

## 5. Technical specifications

### General

Required power DC 12 V, negative ground

Speakers impedance .....4 Ohm

Maximum output power.....40 W × 4 channels

The dimensions of the chassis (built-in) .....178 (w) × 110 (d) × 50 (h) mm

Weight ..... about 0,8 kg

### Audio

Maximum output level.....2 Vrms (+ / - 3 dB)

Frequency range.....20 Hz up to 20 kHz

Signal to noise ration.....85 dB

Channel separation.....80 dB

### FM radio

Frequency range .....87,5–108 MHz

MF .....10.7 MHz

### AM radio

Frequency range .....522-1620 kHz

MF .....450 kHz

The above given specifications can change without prior notice.

Manufacturer address: FAST ČR, a.s., Černokostecká 1621, 251 01 Říčany

The original version is in Czech.

The CE symbol shown on the unit, in the user's manual and on the package indicates the unit meets the basic requirements of guideline R&TTE, 1995/5/EC, Guideline for low voltage 73/23/EEC. The declaration of conformity can be found at [www.sencor.cz](http://www.sencor.cz).

## INSTRUCTIONS AND INFORMATION REGARDING THE DISPOSAL OF USED PACKAGING MATERIALS

Dispose of packaging material at a public waste disposal site.



### DISPOSAL OF USED ELECTRICAL AND ELECTRONIC APPLIANCES

The meaning of the symbol on the product, its accessory or packaging indicates that this product shall not be treated as household waste. Please, dispose of this product at your applicable collection point for the recycling of electrical & electronic equipment waste. Alternatively in some states of the European Union or other European states you may return your products to your local retailer when buying an equivalent new product.

The correct disposal of this product will help save valuable natural resources and help in preventing the potential negative impact on the environment and human health, which could be caused as a result of improper liquidation of waste. Please ask your local authorities or the nearest waste collection centre for further details. The improper disposal of this type of waste may fall subject to national regulations for fines.

#### For business entities in the European Union

If you wish to dispose of an electrical or electronic device, request the necessary information from your seller or supplier.

#### Disposal in other countries outside the European Union

If you wish to dispose of this product, request the necessary information about the correct disposal method from local government departments or from your seller.



This appliance complies with EU rules and regulations regarding electromagnetic and electrical safety.

Changes to the text, design and technical specifications may occur without prior notice and we reserve the right to make these changes.

# SENCOR®

## EN Warranty conditions

**Warranty card is not a part of the device packaging.**

This product is warranted for the period of 24 months from the date of purchase to the end-user. Warranty is limited to the following conditions. Warranty is referred only to the customer goods using for common domestic use. The claim for service can be applied either at dealer's shop where the product was bought, or at below mentioned authorized service shops. The end-user is obligated to set up a claim immediately when the defects appeared but only till the end of warranty period. The end user is obligated to cooperate to certify the claiming defects. Only completed and clean (according to hygienic standards) product will be accepted. In case of eligible warranty claim the warranty period will be prolonged by the period from the date of claim application till the date of taking over the product by end-user, or the date the end-user is obligated to take it over. To obtain the service under this warranty, end-user is obligated to certify his claim with duly completed following documents: receipt, certificate of warranty, certificate of installation.

### **This warranty is void especially if apply as follows:**

- Defects which were put on sale.
- Wear-out or damage caused by common use.
- The product was damaged by unprofessional or wrong installation, used in contrary to the applicable instruction manual, used in contrary to legal enactment and common process of use or used for another purpose which has been designed for.
- The product was damaged by uncared-for or insufficient maintenance.
- The product was damaged by dirt, accident of force majeure (natural disaster, fire, and flood).
- Defects on functionality caused by low duality of signal, electromagnetic field interference etc.
- The product was mechanically damaged (e.g. broken button, fall).
- Damage caused by use of unsuitable media, fillings, expendable supplies (batteries) or by unsuitable working conditions (e.g. high temperatures, high humidity, quakes).
- Repair, modification or other failure action to the product by unauthorized person.
- End-user did not prove enough his right to claim (time and place of purchase).
- Data on presented documents differs from data on products.
- Cases when the claiming product cannot be indentified according to the presented documents (e.g. the serial number or the warranty seal has been damaged).

### **Authorized service centers**

Visit [www.sencor.eu](http://www.sencor.eu) for detailed information about authorized service centers.





**SENCOR®**

**Let's live!**



[www.sencor.cz](http://www.sencor.cz)

Designed in Europe by Sencor®, Made in China

