

SENCOR®

Let's live!

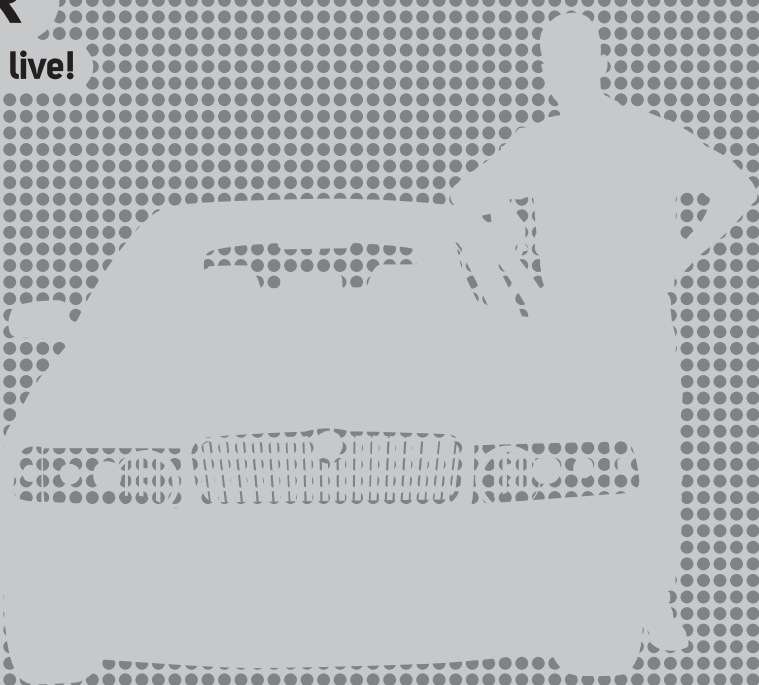

Car radio with USB/SD/MMC
SCT 4055MR

USER'S MANUAL
EN







DEAR CUSTOMER,
CONGRATULATIONS FOR YOUR PURCHASE!
PLEASE READ THIS MANUAL CAREFULLY, AND KEEP IT FOR FUTURE REFERENCE.
IF YOU NEED EXTRA SUPPORT, PLEASE WRITE TO WWW.SENCOR.EU.

Contents

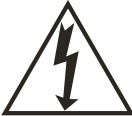
1. Operation	4
1.1. Features.....	4
1.2. Control panel layout.....	5
2. Wiring diagram	8
3. Troubleshooting	11
4. Specification	12

Important safety instructions

	<p style="text-align: center;">CAUTION</p> <p style="text-align: center;">RISK OF ELECTRIC SHOCK, DO NOT OPEN</p>	
<p>Caution: To reduce the risk of electric shock do not open this device, there are not serviceable parts for customers. Please refer any maintenance or repair to qualified personnel.</p>		
	<p>This sign means the existence of dangerous voltage at the inside of the unit, which states a risk of electric shock.</p>	
	<p>This sign means that there are important instructions of operation and handling in the manual that comes with this device.</p>	

Note:

This unit may be submitted to changes in specifications, characteristics and/ or operation without prior notice to the user, in order to continue improving and developing its technology.

Important safety precautions

- Read these instructions. Follow this manual and the instructions inside.
- Heed all warnings.
- Follow all instructions.
- Use only the attachments and accessories specified by the manufacturer.
- You must not put an open flame on the device, e.g. a burning candle.
- Use the device in temperate climate.
- Under no circumstances are the manufacturer or vendor liable for any direct or indirect damage caused by the failure to observe the instructions for installation, configuration, operation, treatment and cleaning of this device included within this manual.
- Protect the device against impacts, falls, blows, shocks, vibration, moisture and dust.
- Before you agree to the use of the device by children, the children must be instructed in an age-appropriate manner about safe use of the device.

- Leave free space around the device, it is necessary for proper air circulation.
- The device must not be exposed to dripping or running water and you must not place upon it objects filled with liquid, e.g. vases. Protect the device against becoming wet, sprayed on or poured on by any liquid, do not leave or install the device outdoors. You risk electric shock or fire by not adhering to these instructions.
- Do not use gasoline, thinner or other solvents or abrasives, scouring pads, or sponges with scouring pads to clean the device.

The radio should be operated only if the traffic situation allows it.

The volume of the audio output should be set to always hear acoustic signals from outside, e.g. police, ambulance and fire brigade siren sound.



WARNING

Pay full attention to the traffic! As a driver you are fully responsible for road safety. When using the radio always have all traffic situations of your vehicle under control!

1. Operation

1. The radio is designed to operate from the vehicle electrical system voltage of 12 V using a grounded negative (minus) pole. Be careful when installing the radio in some buses, trucks, construction machinery, caravans, etc. – some of these vehicles use electrical system 24 V – connecting the radio to this voltage you risk irreparable damage. Electrical system of the vehicle is shown in its documentation.
2. No shock is permitted. Do not overexert when installing or operating.
3. Please avoid over high temperature, damp or dusty environment when selecting install place. Please do not put connected cords on the ground messily for yourself and others's safety.
4. This unit only can be placed in the environment of +5°C – +45°C.
5. Comparative moisture under +45°C environment should not more than 50%.
6. Work environment only limited in altitude -20 m ~ -2000 m.
7. You will be permitted to operate this unit after you have familiar with all functions. Unprofessional personnel are not permitted to operate this unit due to most of damages are caused by their improperly operations.
8. Forbid clean this unit with solvent or corrosive cleanser. Suggest clean it with a soft, a little dampen cloth.
9. Please be sure to use original packing when remove the player.
10. To prevent bring unnecessary trouble, please do not clear the list bar code of this unit.
11. Any damage caused by improperly operating method differ from this manual will not included in the serving range. Besides, it may result in the risk of short circuit, burn out and electric shock.

1.1. Features

1. USB / SD / MMC compatible or MP3 Playback.
2. MP3 ID3 Tag name display.
3. Seamless Loop.
4. RVS Effect.
5. BRAKE Effect.
6. SCRATCH Effect.
7. Shockproof function protecting against external vibrations.
8. Manual BPM Input.
9. Improved interface operation thanks to a large jog/Shuttle
10. Wheel and track select knob.
11. Pitch/Pitch Adjust.
12. The Model can be easily mounted on a standard 3U rack.

1.2. Control panel layout

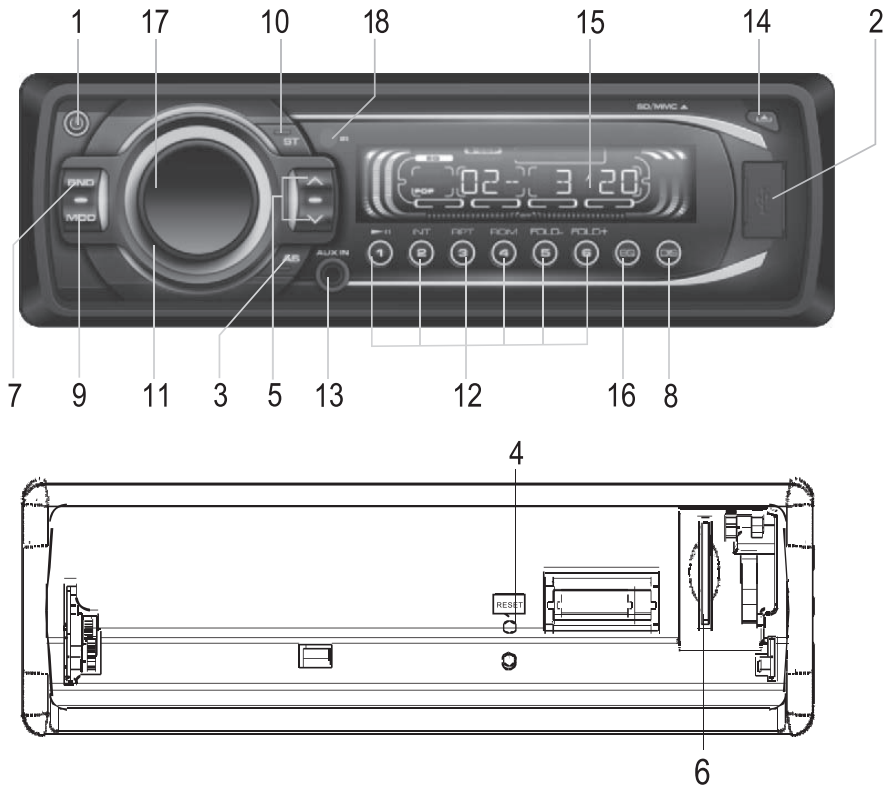

- | | |
|----------------------------|---------------------------------------|
| 1. Power Button | 10. ST Button |
| 2. USB Slot | 11. Volume Knob |
| 3. AS Button | 12. Number Button |
| 4. RESET Button | 13. AUX IN |
| 5. Tuning/Selecting Tracks | 14. Release Button |
| 6. SD Card Slot | 15. LCD Display |
| 7. BND Button | 16. EQ Button |
| 8. DISP Button | 17. Setting The Sound Characteristics |
| 9. MOD Button | 18. Remote Control Sensor |

1. LCD Display

When the Player is power on, the LCD will display the current time.



1. Press button **1** will turn on the player, the LCD will display WELCOME.



2. If you turn off the player, press button **1**. The LCD will display (GOOD BYE).



2. USB Port

When USB is inserted into the USB Port, the unit will automatically play the content of the USB.

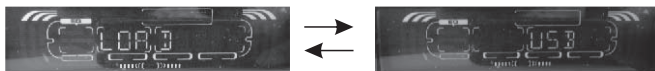

3. AF/TA/PTY button

AF/TA

If the radio signal is poor, turn on AF (Alternate Frequency) to search for another station with stronger signal. Short press AF/TA button to turn On/Off AF function. If you do not want to miss traffic announcement when enjoying music, turn on the TA (Traffic Announcement) function. Long press AF/TA button to turn On/Off TA function.

PTY

Before tuning to RDS stations, you can select program type and let the unit search only for programs of the selected category.

1. Press **PTY** button to select **MUSIC** → **SPEECH** → **PTY OFF**.
2. In **MUSIC** category, press **1-6** to select EQ function.
3. In **SPEECH** category, press **1-6** to select other function.

4. AUX button



When press **AUX** button the LCD will display AUX in it turns to audio-in put mode.

Band selector

1. Press **7** (BND) button repeatedly to select bands in the following order:

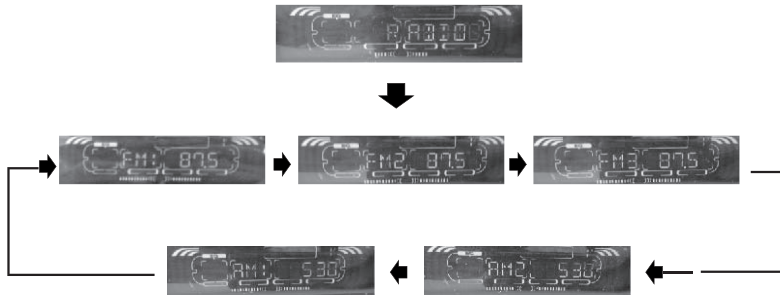

Note:

Press **7** (BAND) button to switch PAL or NTSC system.

2. Manual/Automatic Tuning

Manual Tuning: Press **5** (+>>> or <<<-) button continuously to select a station upward or downward respectively.

Automatic Tuning: Press and hold **5** (+>>> or <<<-) button for more than 2 seconds, the radio automatically searches a station upward or downward respectively and plays when it find a station.

3. MO/ST Selector

Press **10** (ST) button to select **MONO** or **STEREO** mode.



4. In the radio mode, number **1-6** button is the station store button, can store button, can store the current station. Press anyone of the number **1-6** button more than 2 seconds, can store the current station. Then press station. Then press anyone of the number **1-6** button can play the station which it have stored.
5. **Inserting card method see the picture**



6. Remote Control for RGB Lighting

Press the SEL button on the Remote Control and when LCD displays "LED AUTO", then press "VOL+" or "VOL-" to Control the RGB Lighting.

7. RGB Option

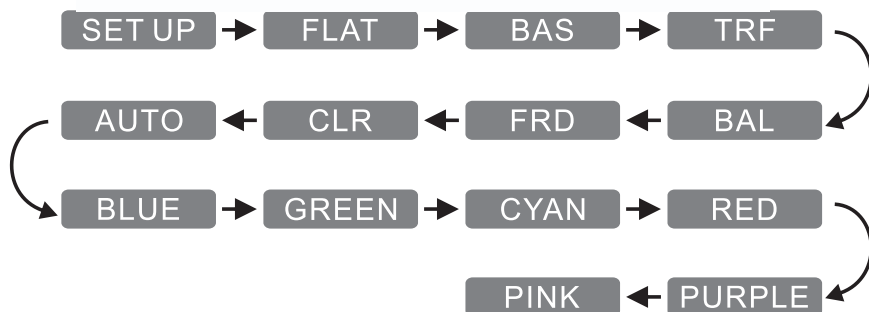

1. Press SEL Button shortly to find "CLR", the adjustment mode will change in the following order: "FLAT" – "BAS" – "TRF" – "BAL" – "FRD" – "CLR"
2. When seeing the Words of "CLR", the default color is "Auto", rotate the SEL Button to select the color, the color will change in the following order: "AUTO" – "BLUE" – "GREEN" – "CYAN" – "RED" – "PURPLE" – "PINK"
3. Rotating VOL+ or VOL- button to select LOUD On/Off, LOCAL/DX, MONO/STEREO.
4. To select the color, just need to rotate to the color then press the SEL Button, so the lighting will change to your selected color. For example, if you want the lighting in Purple only, then rotate the button from Auto to Purple and then press the Button, the lighting will be changed to Purple only.

2. Wiring diagram

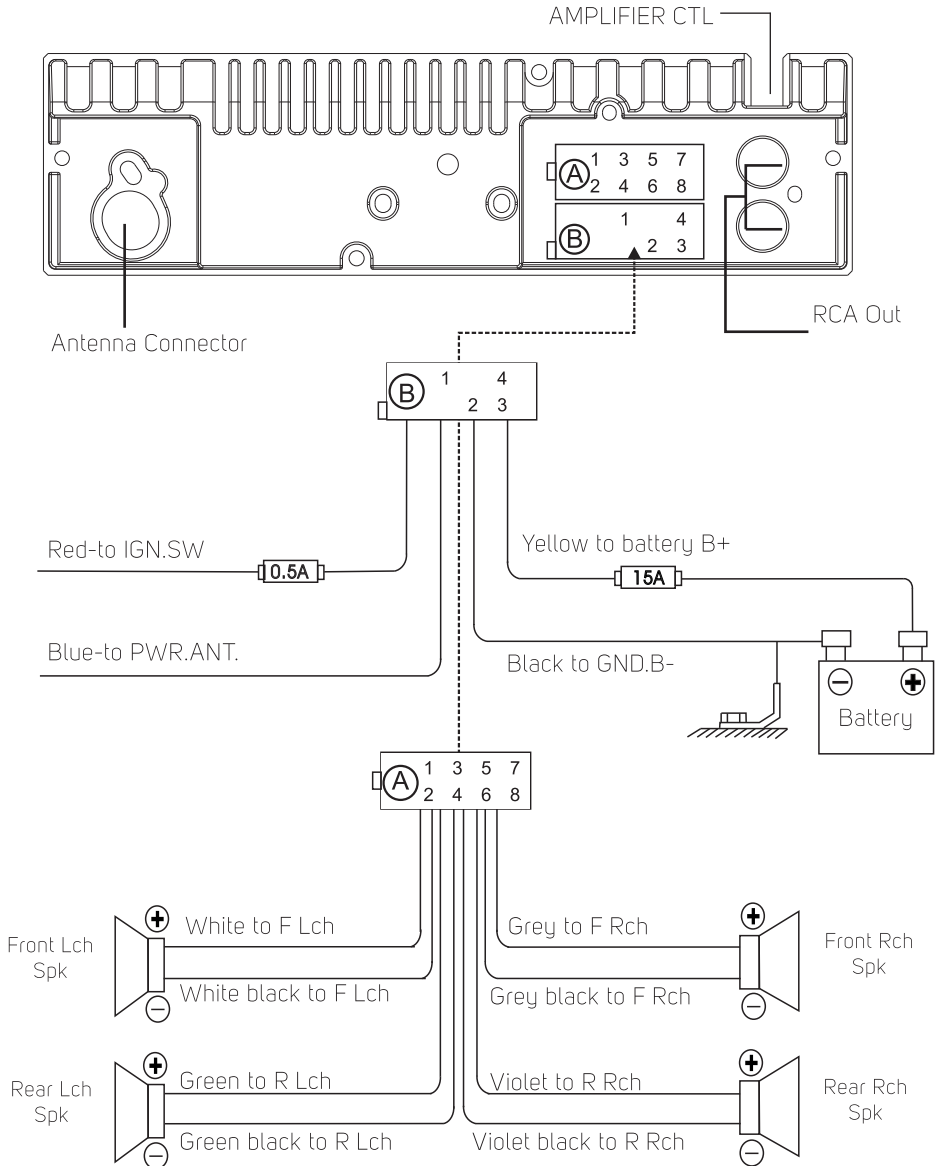

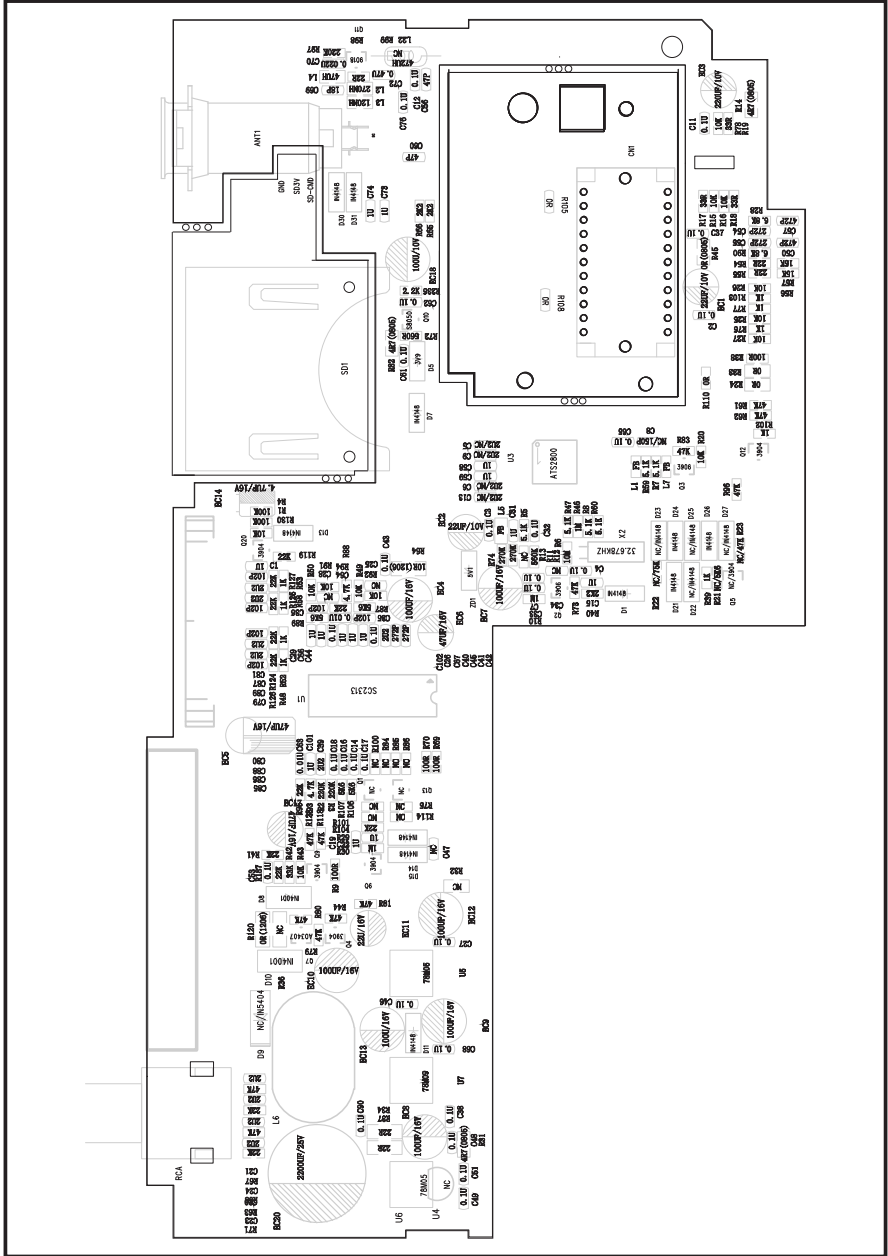

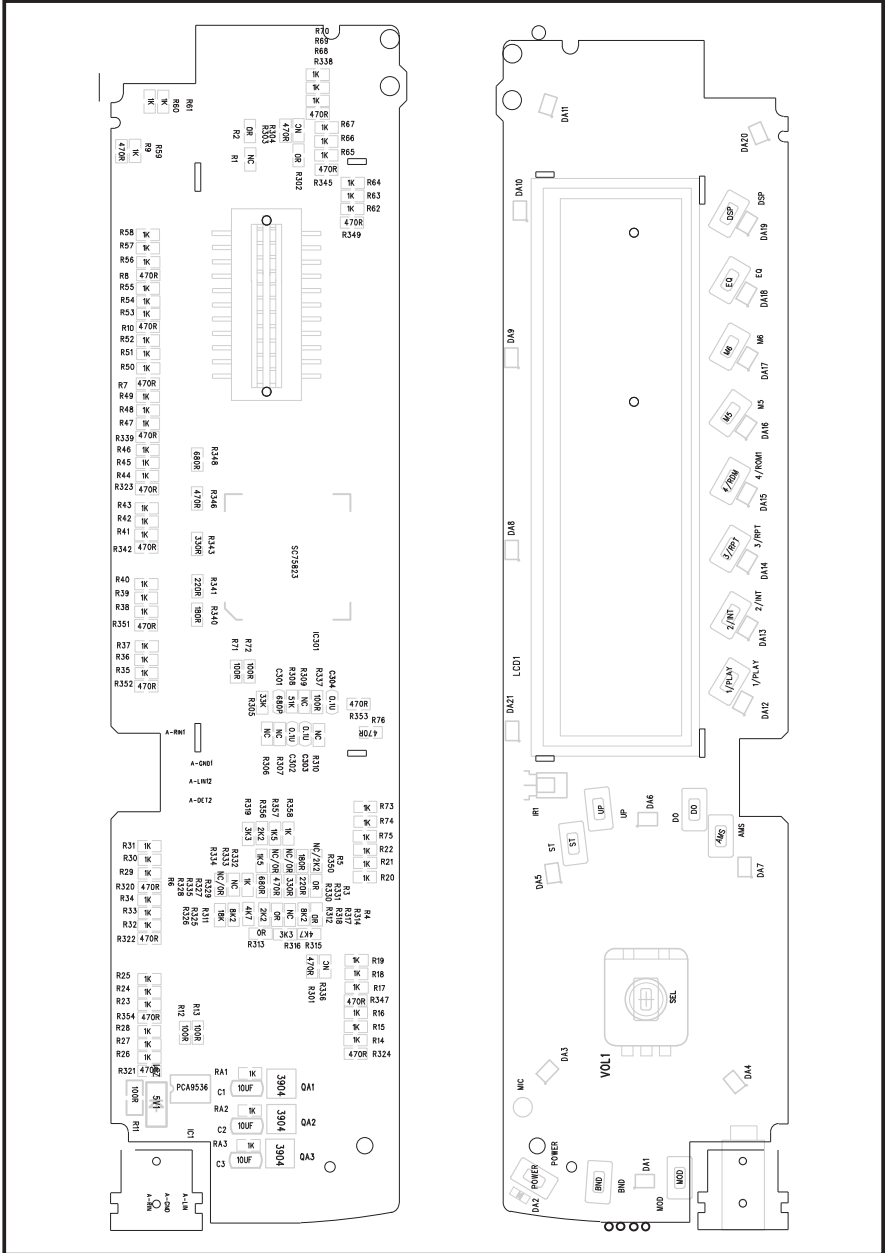

3. Troubleshooting

Incorrect operations can be mistaken as malfunction. If you believe the unit has troubles, please consult the chart below. Sometimes malfunction may be caused by another component. Therefore, please check the other electrical apparatus being used at the same time. If the problem still persists, contact with your dealer for help.

Malfunction	Cause	Solution
No sound	Check connection of mixer and power amplifier	Replace connection
Noise	Incorrect connection of Mixer and power amplifier	Check quality of electrical wire and outlet

4. Specification

General

Power Requirements:	14.4 VDC
Load Impedance:	4 Ω
Max. Power Output:	4x 40 W
Tone Controls:	\pm 8 dB (Bass 100Hz, Treble 10 kHz)
Dimensions:	Approx. 192 × 178 × 50 mm (d × w × h)
Mounting Dimensions:	Approx. 169 × 182 × 53 mm (d × w × h)
Weight:	Approx. 1.75 kg

USB Play Section

Signal-to-noise Ratio:	65 dB
Separation:	60 dB (1 kHz)
Distortion:	0.1%

AM Tuner Section

Tuning Range:	530-1710 kHz
IF Range:	450 kHz
Usable Sensitivity (-30 dB):	15 dB

FM Tuner Section

Tuning Range:	87.5-107.9 MHz
IF Range:	10.7 MHz
Usable Sensitivity (-30 dB):	15 dB
Signal-to-noise Ratio:	60 dB
Stereo Separation:	30 dB (1 kHz)
Frequency Response:	30 – 15000 Hz

Note:

Due to continuous product improvement, specifications and design are subject to change without notice.

INSTRUCTIONS AND INFORMATION REGARDING THE DISPOSAL OF USED PACKAGING MATERIALS

Dispose of packaging material at a public waste disposal site.



DISPOSAL OF USED ELECTRICAL AND ELECTRONIC APPLIANCES

The meaning of the symbol on the product, its accessory or packaging indicates that this product shall not be treated as household waste. Please, dispose of this product at your applicable collection point for the recycling of electrical & electronic equipment waste. Alternatively in some states of the European Union or other European states you may return your products to your local retailer when buying an equivalent new product.

The correct disposal of this product will help save valuable natural resources and help in preventing the potential negative impact on the environment and human health, which could be caused as a result of improper liquidation of waste. Please ask your local authorities or the nearest waste collection centre for further details. The improper disposal of this type of waste may fall subject to national regulations for fines.

For business entities in the European Union

If you wish to dispose of an electrical or electronic device, request the necessary information from your seller or supplier.

Disposal in other countries outside the European Union

If you wish to dispose of this product, request the necessary information about the correct disposal method from local government departments or from your seller.



This appliance complies with EU rules and regulations regarding electromagnetic and electrical safety.

Changes to the text, design and technical specifications may occur without prior notice and we reserve the right to make these changes.

SENCOR®

EN Warranty conditions

Warranty card is not a part of the device packaging.

This product is warranted for the period of 24 months from the date of purchase to the end-user. Warranty is limited to the following conditions. Warranty is referred only to the customer goods using for common domestic use. The claim for service can be applied either at dealer's shop where the product was bought, or at below mentioned authorized service shops. The end-user is obligated to set up a claim immediately when the defects appeared but only till the end of warranty period. The end user is obligated to cooperate to certify the claiming defects. Only completed and clean (according to hygienic standards) product will be accepted. In case of eligible warranty claim the warranty period will be prolonged by the period from the date of claim application till the date of taking over the product by end-user, or the date the end-user is obligated to take it over. To obtain the service under this warranty, end-user is obligated to certify his claim with duly completed following documents: receipt, certificate of warranty, certificate of installation.

This warranty is void especially if apply as follows:

- Defects which were put on sale.
- Wear-out or damage caused by common use.
- The product was damaged by unprofessional or wrong installation, used in contrary to the applicable instruction manual, used in contrary to legal enactment and common process of use or used for another purpose which has been designed for.
- The product was damaged by uncared-for or insufficient maintenance.
- The product was damaged by dirt, accident of force majeure (natural disaster, fire, and flood).
- Defects on functionality caused by low duality of signal, electromagnetic field interference etc.
- The product was mechanically damaged (e.g. broken button, fall).
- Damage caused by use of unsuitable media, fillings, expendable supplies (batteries) or by unsuitable working conditions (e.g. high temperatures, high humidity, quakes).
- Repair, modification or other failure action to the product by unauthorized person.
- End-user did not prove enough his right to claim (time and place of purchase).
- Data on presented documents differs from data on products.
- Cases when the claiming product cannot be indentified according to the presented documents (e.g. the serial number or the warranty seal has been damaged).

Authorized service centers

Visit www.sencor.eu for detailed information about authorized service centers.

SENCOR®

Let's live!

www.sencor.cz

Designed in Europe by Sencor®, Made in China

