

SENCOR®

Let's live!



LED Television

SLE 2463TC

USER'S MANUAL

EN



CAREFULLY READ THIS USER'S MANUAL BEFORE PUTTING THE TELEVISION INTO OPERATION. KEEP IT FOR FUTURE USE. RECORD THE MODEL NUMBER AND THE SERIAL NUMBER OF THE TELEVISION. SEE THE LABEL ON THE REAR COVER AND PROVIDE THIS INFORMATION TO YOUR VENDOR IN THE EVENT THAT YOU REQUIRE REPAIRS.

Content

1.	Important safety instructions.....	2
2.	Stand assembly.....	9
3.	Device description.....	10
	3.1. Control panel button function.....	10
	3.2. TV terminal connections.....	10
4.	Remote control.....	11
5.	First time setup.....	14
	5.1. Select Language.....	14
	5.2. Select Country.....	14
	5.3. Surrounding.....	15
	5.4. Auto Tuning.....	15
6.	Menu.....	16
	6.1. Channel menu.....	16
	6.2. Picture menu.....	20
	6.3. Sound menu.....	23
	6.4. Time menu.....	25
	6.5. Lock menu.....	27
	6.6. Hotel mode.....	30
	6.7. Setup menu.....	31
	6.8. Screen menu (only PC mode).....	36
	6.9. ATV Channel (Channel) menu.....	37
	6.10. Menu SCART / Component / HDMI / AV.....	38
7.	USB.....	39
	7.1. Photo menu.....	40
	7.2. Music menu.....	41
	7.3. Movie menu.....	42
	7.4. Text menu.....	43
8.	Trouble shooting guide.....	44
9.	Technical specifications.....	47

1. Important safety instructions

If you want to use this product correctly, carefully read this user's manual and store it for future reference. If you give (sell) the appliance to somebody, please also include all the documentation together with this appliance, including this user's manual.



The flash symbol in an equilateral triangle indicates that there is dangerous voltage inside this appliance, which presents a risk of injury by electrical shock.

To reduce the risk of injury by electrical shock do not remove the cover (or the rear side). There are no components inside which the user can repair. Have all repairs or adjustments performed at an authorised service centre.



The exclamation mark in an equilateral triangle symbol indicates important operating or servicing instructions in the appliance's documentation.

General safety instructions

- Carefully read this manual before using the appliance. Follow the instructions contained in this user's manual.
- Heed all warnings.
- Adhere to all instructions.
- Use only accessories determined by the manufacturer.
- **AN OPEN FLAME MUST NOT BE PLACED ON THE APPLIANCE, E.G. A BURNING CANDLE. DO NOT PLACE HOT ITEMS OR OBJECTS WITH AN OPEN FLAME E.G. CANDLES OR NIGHT LAMPS ON OR IN THE VICINITY OF THE APPLIANCE. HIGH TEMPERATURES MAY MELT PLASTIC PARTS AND CAUSE A FIRE.**
- Use the appliance in a temperate climate zone.
- Under no condition does the manufacturer or the vendor of the appliance take responsibility for any direct or indirect damages caused by not adhering to instructions for installation, setup, use, service or cleaning of this appliance as described in this user's manual.
- Protect the appliance against being knocked, dropped, hit and shaken and against vibrations, humidity and dust.
- Before allowing children to use the appliance, they must be appropriately to their age, informed about the correct and safe use of the player.
- If the appliance is equipped with a headphone jack, do not use headphones set to an extreme volume. There is a danger of hearing damage or loss.

Installation, operation

- Install the appliance according to the instructions in the user's manual.
- Leave free space on all sides of the appliance necessary for proper air circulation. This removes the heat created during operation. Covering the ventilation openings of the appliance's case creates a risk of overheating or damaging the appliance. It is necessary to ensure that the ventilation openings are not blocked, e.g. by a newspaper, table cloth, curtain, etc. Follow the installation instructions in the user's manual.
- This appliance should not be located in a confined area such as a bookshelf or rack, if sufficient ventilation is not provided for or the instructions of the manufacturer are not followed.
- Never insert any items into any ventilation or other openings because they could come into contact with points with dangerous voltage levels or cause a short circuit of parts, which could cause a fire or injury by electric shock. Never pour any liquid into the appliance.
- Do not install the appliance in direct sunlight or near sources of heat, such as heaters, heat exchangers, stoves or other appliances (including amplifiers) producing heat. High temperatures significantly reduce the lifetime of electronic components in the appliance. Do not use or leave the appliance in the vicinity of an open fire.
- The appliance must not be exposed to dripping or running water and objects filled with water must not be placed on it, e.g. vases. Protect the appliance against rain, spray or contact with any other liquid, do not leave or install the appliance outdoors. Do not use the appliance outdoors. Not adhering to these instructions creates a risk of electrical shock or fire hazard.
- Do not use this appliance near water.
- Treat the glass panel and appliance cover with care. The screen glass can break on impact and cause serious injuries.
- Make sure that the power cord is not stepped on or compressed, particularly near the power plug, power socket and at the point where it exits the appliance or the adapter. The power plug (adapter) is used as a disconnection device and must be easily accessible.
- Never use a appliance with a damaged power cord or plug. If the power cord or plug are damaged, turn off the appliance, disconnect it from the power source and contact an authorised service centre. A damaged power cord or plug may only be replaced by qualified personnel. Under no circumstances attempt to replace the power cord or plug yourself.
- Do not attempt to circumvent the polarised power plug safety feature. If the power plug cannot be inserted into your power socket, contact a qualified electrician to replace the old type of power socket.
- Before connecting the appliance into a power socket, check that the voltage in your power socket corresponds to the voltage on the rating label of the appliance or on its power adapter. If you are not certain about the type of the power sources in your home, contact your vendor or the local energy company.

- Before turning on the appliance, check that the electrical connection is performed properly and in accordance with the instructions of the manufacturer. Before connecting or changing the connection, turn off the appliance and disconnect it from the mains.
- Remember to always disconnect the power plug (adapter) from the power socket before disconnecting the power cable from the rear side of the appliance.
- Insert the power plug into a independent power socket. Do not overload wall sockets with extension cords or multi-socket adapters. There is a risk of injury by electric shock.
- When disconnecting, hold the power cord by the plug and not by the cord itself.
- Disconnect the appliance from the power socket during storms or if you will not be using it for a longer time.
- Avoid moving the appliance from a cold environment to a warm one or vice versa, or when using the appliance in a very humid environment. Air humidity may condense on some components inside the case of the appliance and the appliance may stop working temporarily. If this occurs leave the appliance in a warm and well ventilated place and wait 1 – 2 hours until the moisture evaporates and the appliance can once more be used as usual. Take care especially during the first use of the player immediately after its purchase during a cold season.
- Do not place this appliance on an unstable cart, pedestal, stand, bracket or table. The appliance could fall and cause serious injuries to children or adults or could be seriously damaged or damage other items. Only use the appliance with a cart, pedestal, stand or table designated by the manufacturer or sold with the appliance. Any mounting of the appliance should be carried out according to the manufacturer's instructions and the mounting accessories recommended by the manufacturer should be used.
- Do not lean on the appliance, do not lean over it or use it as a step. Protect it against violent movements. Ensure that children do not play with the appliance.



If using the cart, be careful when moving it. Stopping suddenly, excessive force and uneven surfaces could cause the cart to fall over with the appliance.

- Neither the manufacturer nor the vendor of the appliance under any condition takes responsibility for any direct or indirect damages caused by not adhering to the instructions for installation, setup, use, service or cleaning of this appliance as described in this user's manual.
- Protect the appliance against being knocked, dropped, hit and shaken and against vibrations, humidity and dust.
- Do not expose the appliance to extreme temperatures or humid conditions.

Note:

If the appliance is powered by an adapter, use only the adapter and AC power cord supplied with the appliance. Do not use faulty power sockets. Check that the power plug is properly inserted into the power socket. If the power plug is loose, arcing could result in a fire. Contact a qualified electrician to have your socket replaced.

Note:

Only connect the appliance to a properly grounded socket with a protective grounding pin.

Note:

If you will be installing the appliance on a wall or to the ceiling, follow the manufacturer's instruction found in the user's manual of the particular appliance.

Repairs and maintenance

- To prevent risk of injury through electric shock or the creation of a fire, do not take the appliance out of the case - there are no parts inside the case repairable or adjustable by the user without appropriate equipment and qualifications. Should the appliance require adjustment or repair, contact a professional service centre.
- In the case of any unusual events occurring during the use of the appliance, e.g. if there is a distinct smell of burning insulation or smoke comes out of the appliance, immediately turn off the appliance, disconnect the appliance from the power source and do not use the appliance until you have received the results of an inspection by the employees of the professional service centre.
- Have all repairs carried out by qualified personnel. Repairs are necessary if the appliance has been damaged in any way, for example if the power cord is damaged, liquid was poured on the appliance, foreign objects have entered the appliance, the appliance has been exposed to rain or moisture, if the appliance is not working as usual or if it has fallen.
- In the event of repair or replacement of a part of the appliance, ensure that the service technician uses components designated by the manufacturer or that these components have the same specifications as the original ones. Unauthorised replacements could cause a fire, lead to a danger of injury by electrical shock or other dangers.
- Before cleaning, carrying or other maintenance, disconnect the plug (adapter) from the power socket.
- Clean the appliance only with a dry cloth.
- For cleaning do not use petrol, thinners or any other solvents or use any abrasive cleaning agents, steel wool or any sponges with steel wool.

Note:

Do not throw the appliance into ordinary household waste. For disposal follow all local laws and regulations.

Remote control and batteries

- Do not expose the remote control or the batteries to direct sunlight or sources of heat, such as heaters, heat exchangers, stoves or other appliances (including amplifiers) that produce heat. Do not use or leave the appliance in the vicinity of an open fire.
- Ensure that the sensor is not exposed to a strong light source (e.g. sunlight) or light from fluorescent light tubes, which could reduce the effectiveness and reliability of the remote control.
- Neither the remote control nor the batteries may be exposed to dripping or running water and objects filled with water must not be placed on them, e.g. vases. Protect against exposure to rain, spraying or pouring of any kind of liquid. Do not use outdoors. Not following these instructions creates a danger of damage to the remote control or to the battery.
- Do not use this appliance near water.
- It is necessary to pay attention to the environmental impact aspects of battery disposal.
- The incorrect use of batteries may cause the leakage of the electrolyte and corrosion. To ensure that the remote control works correctly, proceed according to the instructions below:
 - Do not insert the batteries in the wrong polarity orientation.
 - Do not charge, heat, open or short circuit the batteries.
 - Do not throw batteries into a fire.
 - Do not leave discharged batteries in the remote control.
 - Do not combine various types of batteries or new and old batteries.
 - If you will not be using the remote control for a longer period of time, remove the batteries to prevent potential damage caused by a subsequent battery leakage.
 - If the remote control is not working correctly or its operational range is reduced, change all batteries for new ones.
 - If electrolyte leaks out from the batteries, have the remote control cleaned by an authorised service centre.



ATTENTION

To prevent a fire hazard or injury by electrical shock, do not expose this appliance to rain or humidity.



ATTENTION

Batteries must not be exposed to excessive heat, for example sunlight, fire, etc.



This symbol indicates that the appliance has double insulation between the dangerous mains voltage and the parts accessible to the user. In the event of repairs use only identical spare parts.

SENCOR® Supplement to the LCD TV user's manual

Measures to take when a static image is displayed; red/blue/green pixels on the screen

A static image can permanently damage the display part of the television

- Do not leave a static image on an LCD screen for longer than 2 hours, because this could damage the screen. This type of damage is known as "screen burn-in".
- Similar damage to the LCD screen can be caused by a statically located TV channel logo.
- Watching television in 4:3, 16:9 formats or similar (formats not covering the entire area of the screen) for a long time may leave marks on the right or left side, or possibly in the middle of the picture as a result of the differences in light emission. Similar damage may also occur when watching a DVD or playing games.
- The display of a static image from video games or computers for an extended period of time may cause a partial effect of a "persistent image". To prevent this effect from occurring, lower the brightness and contrast when displaying a static picture.



Damage to the screen resulting from the above mentioned causes is not covered by the warranty!

Red/blue/green/black pixels may appear on the screen

- This is a characteristic feature of liquid crystal displays and does not represent a problem. LCD screens are manufactured using a very precise technology in order to achieve a very fine picture resolution. From time to time several inactive pixels may appear on the screen as a permanently red, blue, green or black pixel (up to 0.001% of the total number of pixels on the screen). This does not in any way affect the features and performance of your television.

Notes on the USB connector:

- USB memory devices must be inserted into the appliance directly. To prevent data transmission failure or its interference, do not use USB extension cables. Electrostatic discharges may cause the appliance to malfunction. In such an event the user must restart the appliance.
- Before using a USB flash drive test its ability to communicate with the appliance and its data reading and writing speed.
- To achieve maximum reading speed we recommend that you keep disk space defragmented. Use the FAT32 file system, a single partition, without protection. If reading and writing on the USB memory device is not continuous, undesirable effects may occur such as partial image loss (distortions/checkering effects) or complete image loss, audio defects, and in extreme cases the operation will be stopped. Unexpected behaviour of the connected memory device, or the presence of viruses or other damaging software may cause the functions of the appliance to stop working, necessitating a restart.
- The USB connector is the standard type and is not able to power a USB device with a high power usage (e.g. hard disk drives HDD). Use devices with independent power supplies and power them from their own power supplies.
- The appliance was designed to achieve maximum compatibility with memory devices. With respect to the variety of devices on the market it is not possible to guarantee compatibility with every USB device. In the event of difficulties try formatting the flash drive directly in the appliance. If problems persist, use a different flash drive.

Due to the wide range of USB devices available on the market it is not possible to guarantee the compatibility of the appliance with all USB devices.

Serial number of the appliance

The serial number of the appliance is unique and unequivocally identifies your appliance. Enter the serial number of your appliance together with other details necessary for the definite identification of your appliance below.

Serial number: _____

Date of purchase: _____

Note:

1. The graphics in this manual is informative.
2. The menu on your TV screen may be slightly different from the illustrations in this manual.
3. The information in the document are subject to change without notice.
The manufacturer accepts no liability for damages incurred directly or indirectly from errors, incompleteness or discrepancies between the instruction manual and the product described.

2. Stand assembly

Before attaching/detaching the stand, ensure the television is switched off and unplugged from the power outlet.

Before performing work spread cushioning (e.g. soft blanket) over the base area to lay the LED TV on this will prevent it from being damaged. Make sure the stand is properly assembled so that the TV would be stable.

Place the assembled television on a solid and flat base.

Stand installation instructions

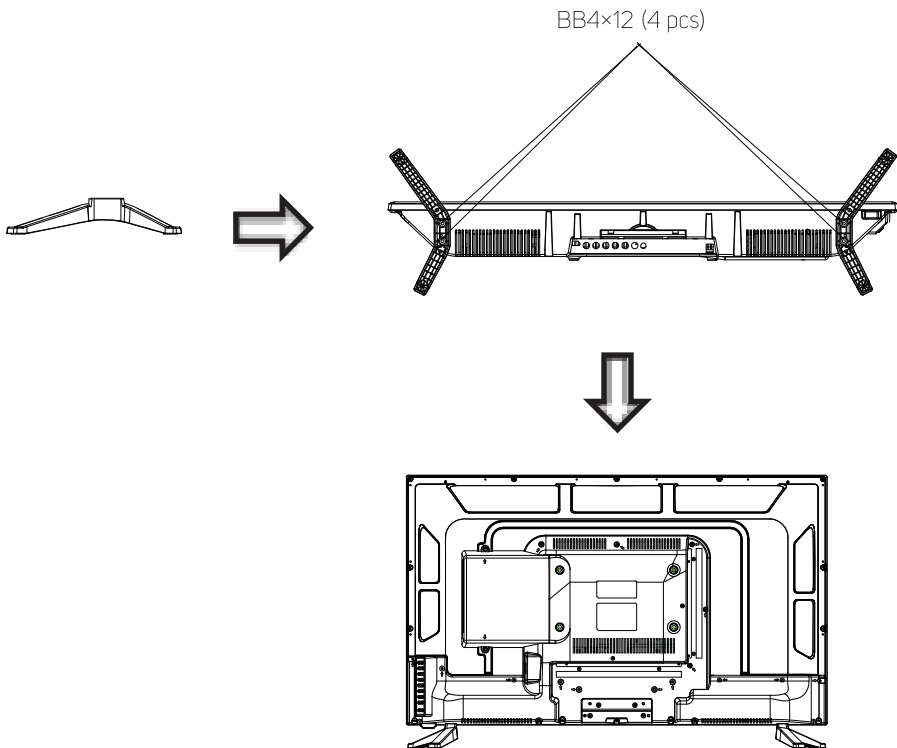
**Note:**

The installation of the stand depends on the specific television model. Certain models already come with a stand installed. If this is the case, skip these instructions.

3. Device description

3.1. Control panel button function

The buttons on the lower-right panel control your TV's basic features, including the on-screen menu. To use the more advanced features, you should use the remote control.

Note:

Pictures are only for illustration.

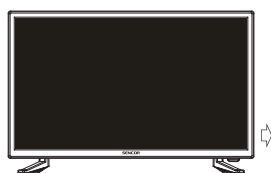

1. Turn on/off
2. **VOL-**
3. **VOL+** } VOL+/-: adjust volume
4. **CH-**
5. **CH+** } CH+/-: channel select
6. **MENU**: into or exit from the menu (use CH+/- buttons to select item, use VOL+/- buttons to adjust items)
7. **INPUT**: source select

3.2. TV terminal connections

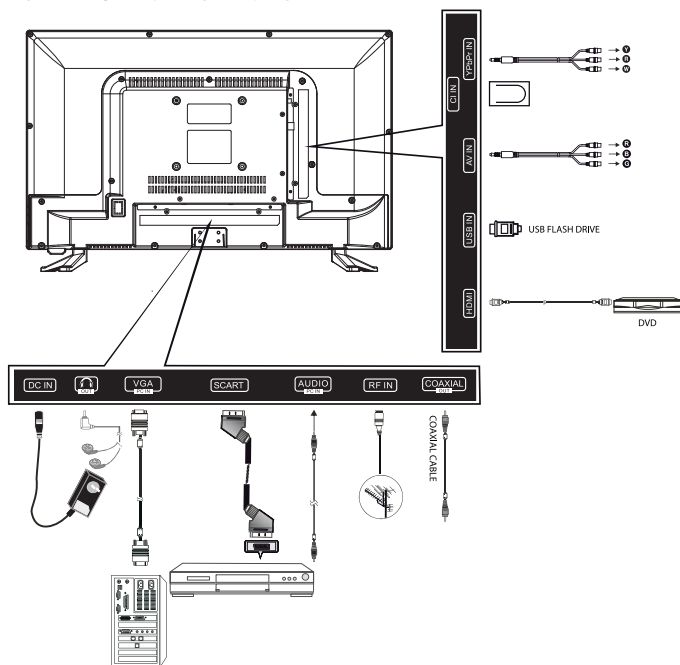

4. Remote control

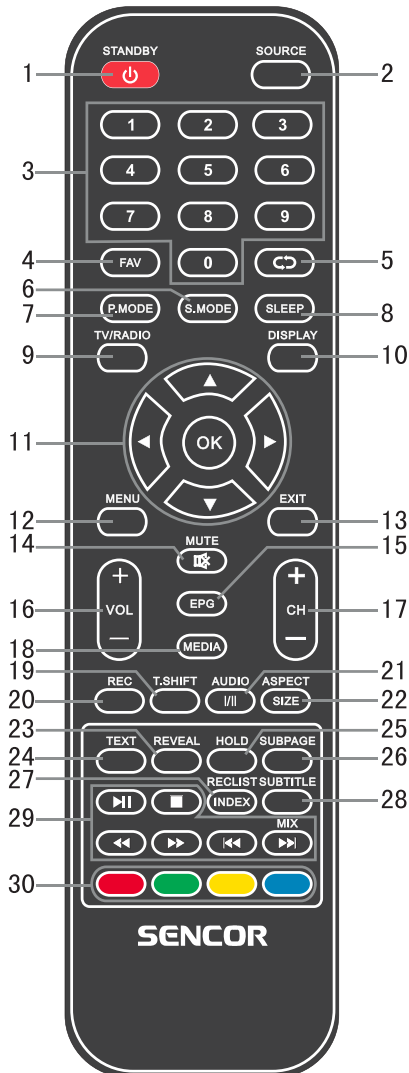

1. **STANDBY button**
Turns the television on/from the stand-by mode.
2. **SOURCE button**
Press to select the desired input.
3. **Numerical buttons 0-9**
Press 0-9 buttons directly to select a TV channel while watching the TV. Enter the page number in the teletext mode, etc.
4. **FAV button**
Press to enter/exit the favourites menu in the TV mode.
5. **C button**
Button to switch the previously watched channel.
6. **S.MODE mode**
Press repeatedly to select a sound mode.
7. **P.MODE button**
Press repeatedly to select a picture mode.
8. **SLEEP button**
Set the automatic shut off time for the television.
9. **TV/RADIO button**
Switch between the television and radio modes
10. **DISPLAY button**
Press to show the source and information about channels.
11. **▲/▼/◀/▶/OK buttons**
Used to navigate in a menu on the screen and to set up the TV according to your preferences.
12. **MENU button**
It displays TV main menu in TV mode.
13. **EXIT button**
Exit the menu or a screen.
14. **MUTE button**
Press to mute the sound. Press is again to restore the sound or press VOL + button.

15. EPG button

Press to show/hide the electronic program guide.

16. VOL+/- buttons

Press to increase/decrease the volume.

17. CH +/- buttons

Press to switch among channels.

18. MEDIA button

Press to switch to the Media (USB) mode.

19. T.SHIFT button

It is used to start recording with a time shift (i.e. time shift). Function is only available in the DTV mode and connected USB flash memory.

20. REC button

press to start recording (only DTV mode).

21. AUDIO button

DTV/MEDIO mode: select a background sound if available.

ATV mode: select a sound mode: Stereo / Dual I/II / Mono.

Other sources: select left/right channel

22. SIZE button

Press SIZE button to change the size of the screen in MEDIA mode.

23. REVEAL button

Press REVEAL button to display / hide hidden teletext information (depends on the broadcast).

24. TTX button

Turn teletext on / off.

Note: The teletext function is optional and the availability of buttons depends on the model. Teletext information fully depends on the operator of the channel.

25. HOLD button

Holds the current display.

26. S.PAGE button

Press S.PAGE button to enter a teletext subpage.

27. RECLIST button

Enter the list of recordings

28. SUBTITLE button

Press to show/hide subtitles in the bottom part of the screen, if they are available.

29. ►|| / ■ / ◀◀ / ▶▶ / ◀◀◀ / ▶▶▶ / MIX buttons

►|| button: play/pause or start a time shift recording.

■ button: stop recording / playback

◀◀ button: fast rewind

▶▶ button: fast forward

◀◀◀ button: Skip to previous track.

▶▶▶ button: skip to the next track

MIX button: TV picture and teletext content are simultaneously displayed on the screen.

30. COLOUR buttons

It corresponds to various colour functions in the menu or teletext

Note:

Remove batter during storage or when you are not using the device for a long time. To control the device using the remote control, point the remote control at the device and then press the button with the required function. The maximum range of the remote control is about 5 meters with a deviation of up to +/- 30° from the perpendicular direction to the reception sensor of the remote control on the front side of the device. The falling capacity of the batteries gradually reduces the remote control range. There must be no solid obstacles in the area between the remote control and the device when the remote control is being used. During standard use the lifetime of batteries in the remote control is about 1 year. When the effective range of the remote control is substantially reduced, or when there are problems with its use, change both the batteries in the remote control. If you are not using the remote control for a longer period of time, take out both batteries from it – in this way you will prevent potential damage caused by their leakage.

Avoid strong impact of light (e.g. sunlight or light from strong fluorescent/saving sources) which can reduce the effectiveness and reliability of IR remote control.

5. First time setup

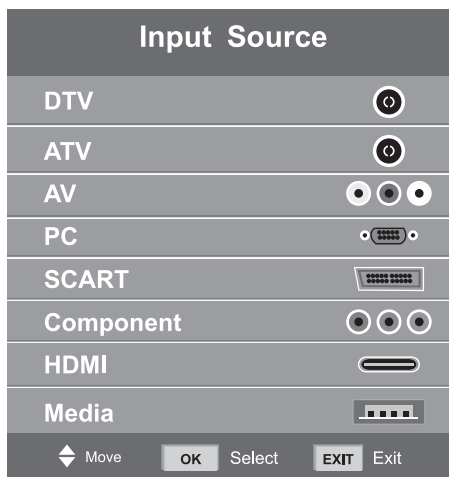

Press **SOURCE** button to display the input source list.

Press ▼ / ▲ or **SOURCE** button to select the desired input source.

Press **OK** button to enter the input source.

Press **EXIT** button to quit.

Connect an RF cable from the Tv's input called "RF-In" and to your TV Aerial socket (antenna, common antenna, cabel, ...).

5.1. Select Language

Press ◀ / ▶ button to select the language to be used for menus and message.

5.2. Select Country

Press ▼ / ▲ button to highlight country menu.

Press ◀ / ▶ button to select the country you want to.

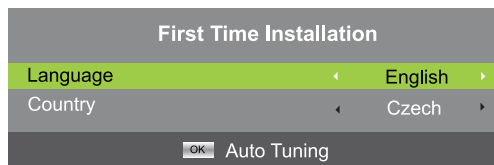

5.3. Surrounding

Choose between Home (Home/Off) or Shop (Shop/On).

Note: Using of Shop, the system will set some parameters of the device to the highest settings to present the device in a surrounding with extreme lightning, accompanying by higher ballast and consumption. Therefore, the switch to a Shop surrounding is accompanied by a question of the device where you should confirm your aim.

For common use, it is recommended to set Home surrounding.

5.4. Auto Tuning

Select among Analogue (ATV) or digital (DVT) or leave both sources ATV+DTV. ATV tuning will start first. If you want to skip ATV tuning, press MENU button and left arrow button.

Then DTV tuning will start. To skip DTV tuning, press MENU button and left arrow button.

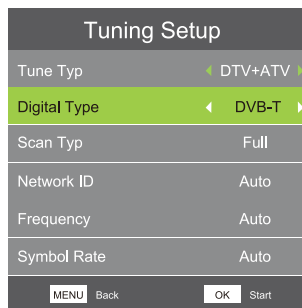

Note:

If an automatic tuning do not find any receivable channel (e.g. inconvenient antenna) or you have paused it manually, you can still tune channels manually, one by one, as it is described down in the manual. To do so, you will need some technical data about channel you wish to tune, such as broadcast way, frequency, audio modes, broadcast speed etc.

A successful finished automatic tuning ends by saving the list of available TV channels and radio stations that you can take in. In case of a multiple presence of the same or similar channels (e.g. due to a local variations of the same central channel or distant interference or local "net" reception), verify which channels will suit you more and amend the list if necessary.

6. Menu

6.1. Channel menu

Press **MENU** button to display the main menu.

Press ◀ / ▶ button to select **CHANNEL** in the main menu.

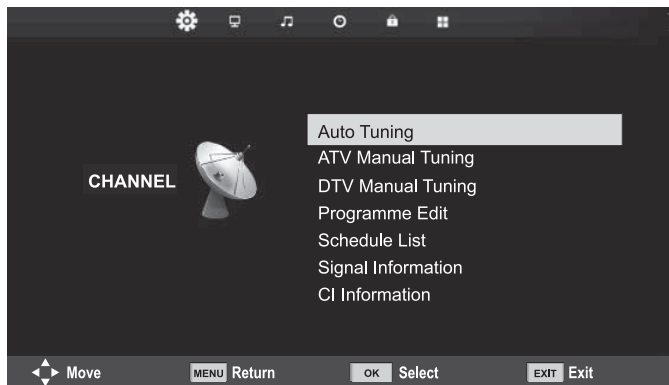

1. Press ▼ / ▲ button to select the option that you want to adjust in the **CHANNEL** menu.
2. Press **OK** button to adjust.
3. After finishing your adjustment, Press **MENU** button to save and return to the previous menu.

6.1.1. Auto tuning

Press ▼ / ▲ button to select **Auto Tuning**, then press **OK** button to enter.

The system will run the same operation as for the first time setup, all previously channels will be deleted.

6.1.2. ATV manual tuning

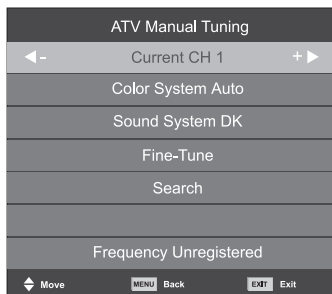

Current CH

Set the channel number.

Color System

Select the color system (available systems: AUTO, PAL, SECAM).

Sound System

Select the sound system.

Fine-Tune

Adjust the frequency of the channel finely.

Search

Start searching channel.

6.1.3. DTV manual tuning

Press ▼ / ▲ button to select **DTV Manual Tuning**, then press **OK** button to enter sub-menu.

Press ◀ / ▶ button to select channel, then press **OK** button to search program.



6.1.4. Program Edit

Press ▼ / ▲ button to select **Program Edit**, then press **OK** button to enter sub-menu.

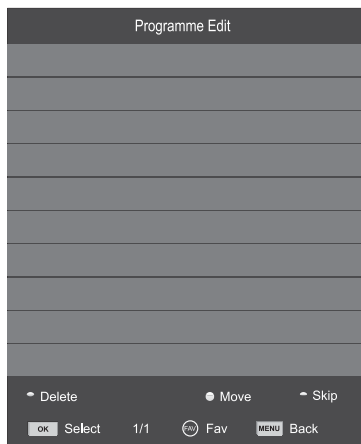

The three colored key **Red** **Yellow** **Blue** is the shortcut key for programming the channel.

First press ▼ / ▲ to highlight the channel you want to select, then:

Press the **Red** button to delete the program in the list.

Press the **Yellow** button to move the channel in favorite list.

Press the **Blue** button to skip the selected channel.

Press **FAV** button to add or remove the channel to your favorite list. (Your TV set will skip the channel automatically when using CH+/- to view the channels.)

6.1.5. Schedule list

You can program certain events fixed in time in digital broadcasting. Such planned (programmed) events are saved in the List.

Press ▼ / ▲ button to select **Schedule List**, then press **OK** button to enter sub-menu. It is available in source.

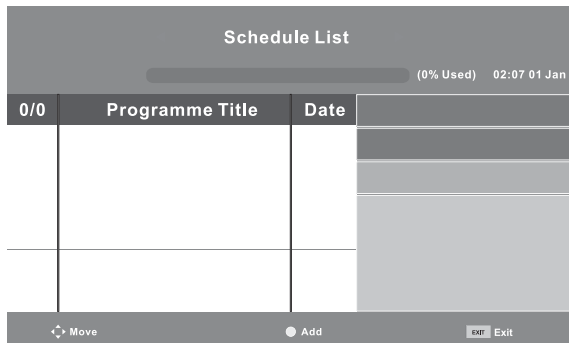

Press the **YELLOW** button to enter the interface below.



When the time appointment is conflict, it will produce a warning message.

6.1.6. Signal information

Press **▼ / ▲** button to select **Signal Information**, press the **OK** button to see the detail information about the signal. Only available when there is signal in DTV.

Use programs/channels with the highest values of both variables, max. is 100 for a satisfactory reception.

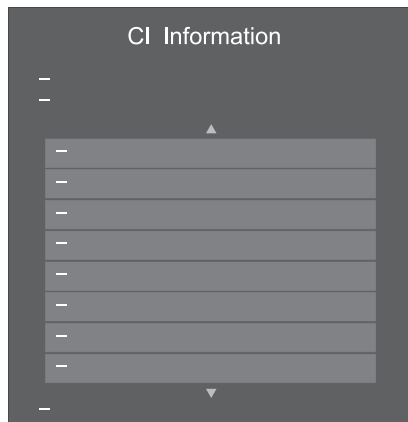

6.2. Picture menu

Press **MENU** button to display the main menu.

Press **◀ / ▶** button to select **PICTURE** in the main menu.

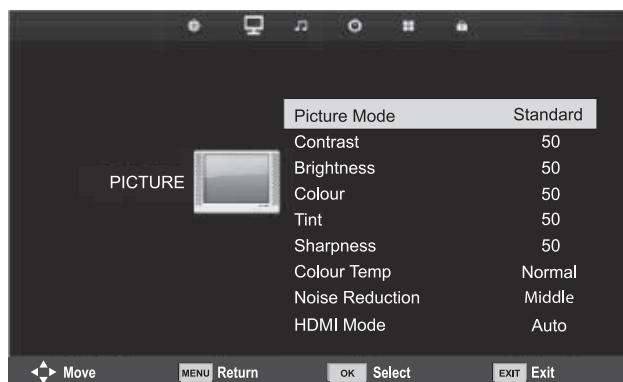

1. Press **▼ / ▲** button to select the option that you want to adjust in the **PICTURE** menu.
2. Press **Enter** button to adjust.
3. After finishing your adjustment, Press **Enter** button to save and return to the previous menu.

6.2.1. Picture mode

Press ▼ / ▲ button to select **Picture Mode**, then press **OK** button to enter sub-menu. You can change the value of contrast, brightness, color, sharpness and tint when the picture is in **Personal** mode.



Tip:

You can press **PMODE** button to change the Picture Mode directly.

Contrast/ Brightness/ Color/ Tint / Sharpness

Press ▼ / ▲ button to select option, then press ◀ / ▶ button to adjust.

Contrast Adjust the highlight intensity of the picture, but the shadow of the picture is invariable.

Brightness Adjust the optical fiber output of the entire picture, it will affect the dark region of the picture.

Color Adjust the saturation of the color based on your own like.

Tint Use in compensating color changed with the transmission in the NTSC code.

Sharpness Adjust the peaking in the detail of the picture.

Note:

Items are available only for **Personal** mode.

6.2.2. Color Temp

Change the overall color cast of the picture.

Press ▼ / ▲ button to select **Color Temperature**, then press **OK** button to enter sub-menu.

Press ◀ / ▶ button to select. (Available Picture mode: Cool, Medium, Warm).



- Cold** Increase the blue tone for the white.
- Normal** Increase the sex-linked colors for the white.
- Warm** Increase the red color for the white.

6.2.3. Noise Reduction

To filter out and reduces the image noise and improve picture quality.

Press ▼ / ▲ button to select **Noise Reduction**, then press **OK** button to enter sub-menu.



- Off** Select to turn off video noise detection.
- Low** Detect and reduce low video noise.
- Middle** Detect and reduce moderate video noise.
- High** Detect and reduce enhanced video noise.
- Default** Set as Default.

6.2.4. HDMI mode

Select **Video** (e.g. for a satellite receiver), or **PC**, or **AUTO** for the current connected source into HDMI input. This will adapt the picture processing and its size of the current source.

If no source is detected, HDMI is inactive.

6.3. Sound menu

Press **MENU** button to display the main menu.

Press ◀ / ▶ button to select **SOUND** in the main menu.

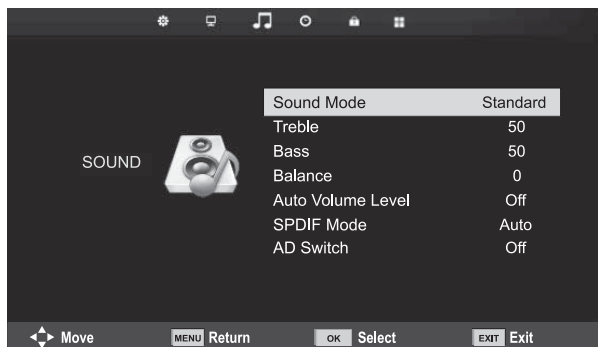

1. Press ▼ / ▲ button to select the option that you want to adjust in the **SOUND** menu.
2. Press **OK** button to adjust.
3. After finishing your adjustment, Press **MENU** button to save and return to the previous menu.

6.3.1. Sound mode

Press ▼ / ▲ button to select **Sound Mode**, then press **OK** button to enter sub-menu.

Press ▼ / ▲ button to select.

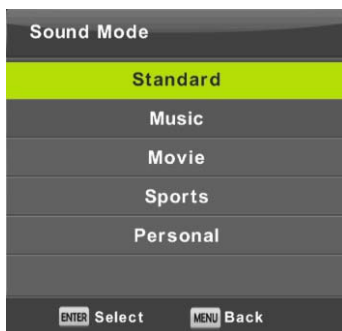

You can change the value of Treble and Bass when the sound is in **User** mode.

Tip:

You can press **S.MODE** button on the remote control to change the Sound Mode directly.

- Standard** Produces a balanced sound in all environments.
- Music** Preserves the original sound. Good for musical programs.
- Movie** Enhances treble and bass for a rich sound experience.
- Sports** Enhances vocals for sports.
- Personal** Select to customize picture settings.

Note:

The treble and bass are only available in **User** mode, you can adjust them as you like.

6.3.2. Balance

Press ▼ / ▲ button to select **Balance** option. Press ◀ / ▶ button to adjust.

6.3.3. Auto volume level

Press ▼ / ▲ button to select Auto Volume Level, then press ◀ / ▶ button to select **On** or **Off**.

6.3.4. SPDIF Mode

Press ▼ / ▲ button to select **SPDIF Mode**, then press ◀ / ▶ button to select **Off / PCM / Auto**. It is use to perform a digital sound from an external source.

6.3.5. AD Switch

Press ▼ / ▲ button to select AD Switch, then press ◀ / ▶ button to select **On** or **Off**. Amblyopia function for the blind, the tracks will be mixed describe the current screen. It need code stream to support. When this function is on, it show also comments of an audio description which are provided by a broadcaster, setting a volume to the original sound.

Note:

Balance: This item can adjust the speaker's output, it enables you to listen to best at your position.

Auto Volume: This item is used for reducing the difference between channel and program's volume automatically.

6.4. Time menu

Press **MENU** button to display the main menu.

Press ◀ / ▶ button to select **TIME** in the main menu.

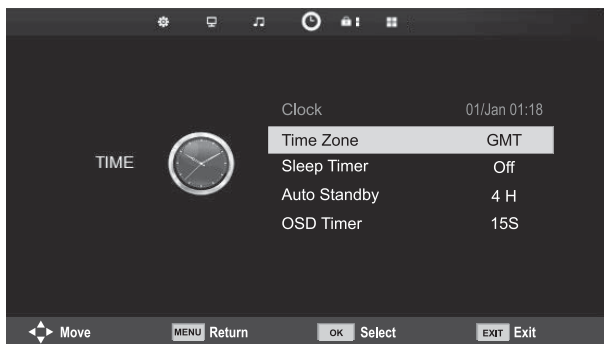

1. Press ▼ / ▲ button to select the option that you want to adjust in the **TIME** menu.
2. Press **OK** button to adjust.
3. After finishing your adjustment, Press **OK** button to save and return to the previous menu.

6.4.1. Time zone

Press ▼ / ▲ button to select **Time Zone**, then press **OK** button to enter sub-menu.

Press ▼ / ▲ / ◀ / ▶ button to select time zone.



Note:

Correct set time (including summer time) is important for more functions of a digital broadcasting, such as EPG. Very accurate time is presented at broadcasting and the device is synchronized upon it. It is necessary to select the correct time zone from the user's point of view.

6.4.2. Sleep timer

Press ▼ / ▲ button to select **Sleep Timer**, then press **OK** button to enter sub-menu.
Press ▼ / ▲ button to select. (Available options are: Off, 10min, 20min, 30min, 60min, 90min, 120min, 240min).

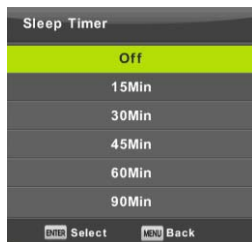

6.4.3. Auto standby

Press ▼ / ▲ button to select **Auto Standby**, then press **OK** button to enter sub-menu.
Press ▼ / ▲ button to select.

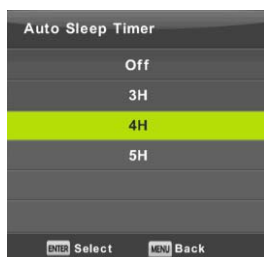

Tip:

If the remote control does not make any operation in the hypothesis time, it will close down automatically. If you do any operation by the remote control, it will reset the time. Long time is sufficient for the vast majority of applications. Off function can be also completely deactivated by selecting OFF.

6.4.4. OSD timer

Press ▼ / ▲ button to select **OSD Timer**, then press **Enter** button to enter sub-menu.
Press ▼ / ▲ button to select how long the setting will be displayed before automatic shut off.



6.5. Lock menu

Press **MENU** button to display the main menu.
Press ◀ / ▶ button to select **LOCK** in the main menu.

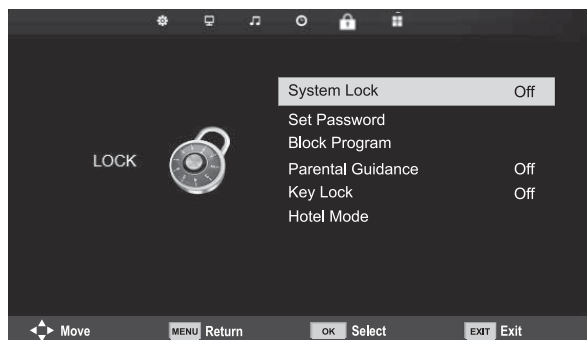

1. Press ▼ / ▲ button to select the option that you want to adjust in the **LOCK** menu.
2. Press ◀ / ▶ button to adjust.
3. After finishing your adjustment, Press **MENU** button to save and return to the previous menu.

Default password is 0000, and if forget what you set, please call the service center.

6.5.1. Lock system

Press ▼ / ▲ button to select **Lock System**, then press **OK** button to make the following 3 options valid.



6.5.2. Set password

Press ▼ / ▲ button to select **Set Password**, then press **OK** button to enter sub-menu to set new password.



6.5.3. Channel lock

Press ▼ / ▲ button to select **Channel Lock**, then press **OK** button to enter sub-menu to select.

Press **Green** button to lock or unlock the channel.

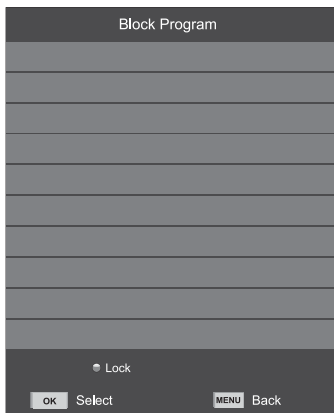

6.5.4. Parental Guidance

Press ▼ / ▲ button to select **Parental Guidance**, then press **OK** button to enter sub-menu to select the number of age which is suitable for your children.

Broadcaster may equip channels by information about the recommended or minimum age for watching. If a channel is broadcasted with a hidden index of a minimum age, the device will compare it with your set data and it may ask you to enter a password in order you can watch a program with higher age setting.

6.5.5. Key lock

Press ▼ / ▲ button to select **Key Lock**, then press ◀ / ▶ button to select **Off** or **On**.
When Key Lock's statue is on, you can't use the Key panel button.

6.6. Hotel mode

Hotel mode serves to limit the TV functions for easier usage in place where for example maximum volume or tuning should be limited.

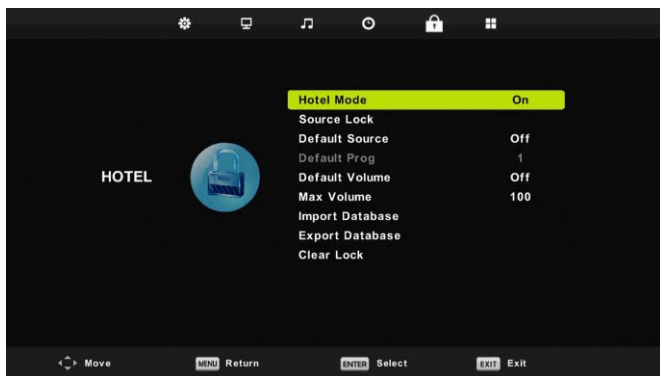

1. Press ▼ / ▲ button on the remote control to select hotel mode in the **Lock** menu.
2. Press **OK** button on the remote control to enter the sub-menu.
3. After finishing your adjustment, Press **MENU** button to save and return back to the previous menu.

6.6. Hotel mode

Press ▼ / ▲ button to select **Hotel Mode**, then press ◀ / ▶ button to select **on** or **off**.

6.6.1. Source lock

Press ▼ / ▲ button to select **Source Lock**, then press **Enter** button to enter sub-menu to select.

6.6.2. Default source

Press ▼ / ▲ button to select **Default Source**, then press **Enter** button to enter sub-menu to select.

6.6.3. Default prog

Press ▼ / ▲ button to select **Default Prog**, then press ◀ / ▶ button to adjust. It is available when the default source is TV.

6.6.4. Max volume

Press ▼ / ▲ button to select **Max Volume**, then press ◀ / ▶ button to adjust.

6.6.5. Clear lock

Press ▼ / ▲ button to select **Clear Lock**, then press **OK** button to clear the setting you have done before.

6.7. Setup menu

Press **MENU** button to display the main menu.

Press ◀ / ▶ button to select **SETUP** in the main menu.

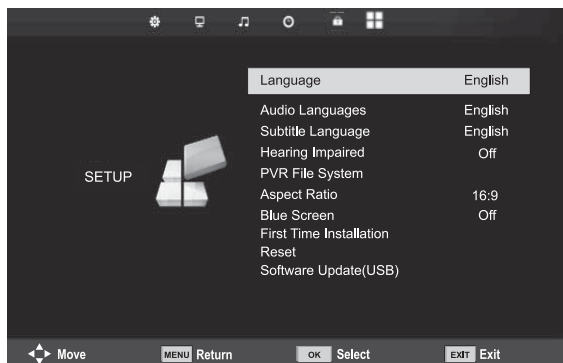

1. Press ▼ / ▲ button to select the option that you want to adjust in the **SETUP** menu.
2. Press ◀ / ▶ button to adjust.
3. After finishing your adjustment, Press **MENU** button to save and return to the previous menu.

6.7.1. OSD language

Select an OSD menu language can be displayed. Default English is selected as menu language.

Press ▼ / ▲ / ◀ / ▶ button to select Menu Language.



6.7.2. TT language

Press ▼ / ▲ button to select **TT Language**, then press **Enter** button to enter sub-menu.
Press ▼ / ▲ / ◀ / ▶ button to select TT language.



6.7.3. Audio Languages

Press ▼ / ▲ button to select **Audio Languages**, then press **OK** button to enter sub-menu. It serves to automatically select a certain language if this is available. You can select 2 languages – first and second. If the desired language is not available, the system will select a language of the broadcaster.

Press ◀ / ▶ button to select the primary/secondary of Audio Languages.

Press ▼ / ▲ / ◀ / ▶ button to select the Audio Languages.



6.7.4. Subtitle Language

Press ▼ / ▲ button to select **Subtitle Language**, then press **OK** button to enter sub-menu. It serves to automatically select a certain language if this is available. You can select 2 languages – first and second. If the desired language is not available, the system will select a language of the broadcaster.

Press ◀ / ▶ button to select the primary of Subtitle Language.

Press ▼ / ▲ / ◀ / ▶ button to select the Subtitle Language.



6.7.5. Hearing Impaired

Press ▼ / ▲ button to select **Hearing Impaired**, then press **OK** button to select **On** or **Off**. It depends on the channel broadcasting.

6.7.6. PVR File System

This option is used to set up recording of the digital broadcasting to your USB flash memory. Due to the data size coming from the digital broadcasting, the setting is more detailed.

Press ▼ / ▲ button to select **PVR File System**, then press **OK** button to enter sub-menu.

Press ▼ / ▲ button to select **Check PVR File System**, then press **OK** button to enter.

Then it will check the USB speed. The result shows what best broadcasting is available for your USB flash memory. In case of unsatisfactory result, format the device in the TV which will try to better adapt the USB device to record the digital broadcasting. Select lower values to limit the file size and recording. Higher values quickly increase demands on your memory stick, both in size and particularly speed.

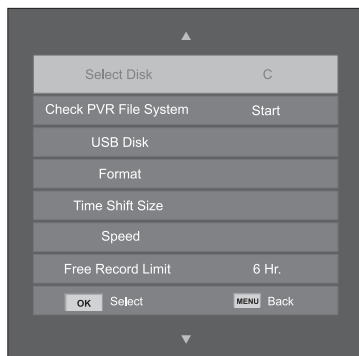

WARNING

Formatting will delete all data on the memory stick!

Note:

Firstly try each USB device for speed and record reliability. In case of unsatisfactory result, change it to other one, particularly faster. USB device speed is a key parameter of a reliable record and time shift.

6.7.7. Aspect Ratio

Press ▼ / ▲ button to select **Aspect Ratio**, then press **OK** button to enter sub-menu. Press ▼ / ▲ button to select aspect ratio. (Available options are: Auto, 4:3, 16:9, Zoom1, Zoom2).



6.7.8. Blue Screen

Press ▼ / ▲ button to select **Blue Screen**, then press **OK** button to select **On** or **Off**. Function will be activated only if no useful picture sound is available.

6.7.9. First Time Installation

Press ▼ / ▲ button to select **First time installation**, then press **OK** button to enter. This will delete all previously settings and tunings and you will start again the process of setting into operation.

6.7.10. Reset

Press ▼ / ▲ button to select **Reset**, then press **OK** button to enter sub-menu. This function restores TV to the factory setting, excluding deleting the tuned channel list.

6.7.11. Software Update (USB)

Press ▼ / ▲ button to select **Software Update (USB)**, plug your USB device in the USB slot, then press **Enter** button to update the right software.



WARNING

Run the software update only if you have an original software to the correct model from the manufacturer including the changes description. Using not original software, even in case of a small differences, can damage TV and that is not covered by warranty.

6.7.12. Surrounding

Choose between Home (Home/Off) or Shop (Shop/On).

Note: Using of Shop, the system will set some parameters of the device to the highest settings to present the device in a surrounding with extreme lightning, accompanying by higher ballast and consumption. Therefore, the switch to a Shop surrounding is accompanied by a question of the device where you should confirm your aim.

For common use, it is recommended to set Home surrounding.

6.8. Screen menu (only PC mode)

Press **MENU** button to display the main menu.

Press ◀ / ▶ button to select **SCREEN** in the main menu.

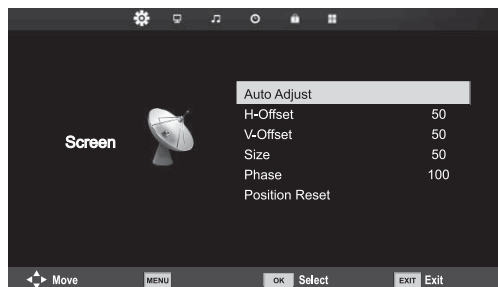

1. Press ▼ / ▲ button to select the option that you want to adjust in the **SCREEN** menu.
2. Press **OK** button to adjust.
3. After finishing your adjustment, Press **MENU** button to save and return to the previous menu.

6.8.1. Auto adjust

Press **OK** button to start adjusting **H-Offset/V-Offset/Size/Phase** automatically.

6.8.2. H-Offset

Adjust the horizontal position of the picture.

Press ▼ / ▲ button to select **H-Offset**, then press **OK** button to enter sub-menu.

6.8.3. V-Offset

Adjust the vertical position of the picture.

Press ▼ / ▲ button to select **V-Offset**, then press **OK** button to enter sub-menu

6.8.4. Size

Adjust the display size.

Press ▼ / ▲ button to select **Size**, then press **OK** button to enter sub-menu.

6.8.5. Phase

Adjust the horizontal interfering lines.

Press ▼ / ▲ button to select **Phase**, then press **OK** button to enter sub-menu.

6.8.6. Position Reset

Press ▼ / ▲ button to select **Position Reset**, then press **OK** button to enter.

Notes:

1. Noise Reduction in **PICTURE** option is invalid.
2. **SOUND** menu and description are the same as that for DTV mode.
3. **TIME** menu has no clock option.
4. **LOCK** menu and description are the same as that for DTV mode.
5. **Hearing Impaired** and **PVR File System** in **SETUP** option is invalid.

6.9. ATV Channel (Channel) menu

Press **MENU** to enter the main menu (in ATV mode).

Press **◀/▶** to select a **CHANNEL** in the main menu.

1. Press **▼/▲** to select the option you want to adjust the settings menu Antenna TV.
2. Press **◀/▶** to adjust.
3. After completing the adjustment, press the **MENU** button to save the settings and return to the previous menu.

6.9.1. Automatic tuning

Press **▼/▲** to select the Auto Tuning, then click OK to start it.

6.9.2. Manual tuning of ATV

Press **▼/▲** to select the ATV Manual Tuning, and then click OK to enter the sub-menu.

6.9.3. Manual tuning of DTV

Press **▼/▲** to select the DTV Manual Tuning, and then press OK to enter the sub-menu.

6.9.4. Editing Channels

Press **▼/▲** to select the Programme Edit, and then press OK to enter the sub-menu.

Notes:

1. Sound menu and its description is exactly the same as in mode DTV (AD switch is not available).
2. Lock menu and its description is exactly the same in both DTV.
3. In the Time menu there is no time in hours and the option to select the time zone.
4. In the Setup menu there are not available the hearing impaired and PVR file system.

6.10. Menu SCART / Component / HDMI / AV

Notes:

1. Menu image and its description are the same as in the mode of DTV.
2. Sound menu and its description are the same as in DTV. (AD switch is inactive).
3. Lock menu and description are the same in both DTV.
4. In the AV / Component / SCART / HDMI no channel menu.
5. In the settings menu no choice time and time zone.
6. SCART and AV do not support the option for the hearing impaired/filesystem PVR; Component and HDMI unsupported language Teletext / option for the hearing impaired.

7. USB

Note:

Before operating **Media** menu, plug in USB device, then press **SOURCE** button to set the **Source** to **Media**. TV will recognise majority of USB devices and it will shortly show the menu for playback. If there is no action, menu disappears and the previous mode will be on.

Press **▼** / **▲** button to select **Media** in the Source menu, then press **OK** button to enter.

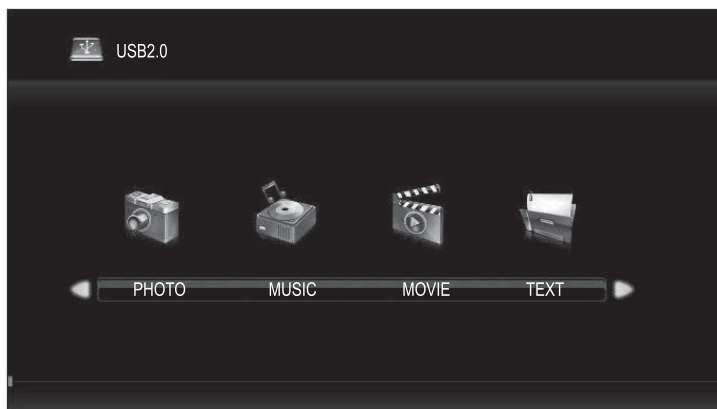

Press **◀** / **▶** button to select the option you want to adjust in the main **Media** menu, then press **OK** button to enter.

7.1. Photo menu

Press ◀ / ▶ button to select **PHOTO** in the main menu, then press **OK** button to enter. Press **Exit** button to return to the previous menu and exit menu to quit.



Press ◀ / ▶ button to select the file you want to watch in the file selecting menu, then press **OK** button to display picture.

Basic Function

Repeat ALL

Press ◀ / ▶ to select the repeat settings, press **OK** to select **Repeat off / repeat all /**

Repeat 1.

Music

Press button to select **Music**, press **OK** button ◀ / ▶ to play background music.

Playlist

Press ◀ / ▶ button to select Playlist, press **OK** button to enter.

Info

Press ◀ / ▶ to select information, press **OK** to enter. You can see detailed information about the image.

Rotate

Press ◀ / ▶ to rotate the image. You can select the direction of rotation independently.

Zoom in/Zoom Out

You can choose to enlarge or reduce the picture.

Move View

If the picture big enough to surpasses the screen, you may use this function to move the picture.

7.2. Music menu

Press ◀ / ▶ button to select **MUSIC** in the main menu, then press **OK** button to enter. Press **Exit** button to return to the previous menu and exit menu to quit.



Press ◀ / ▶ button to select drive disk you want to watch, then press **OK** button to enter. Press **down** arrow to hide the information bar, press **OK** to display it again. Press **Exit** button to stop playing, you will return to the directory list. When highlighting the option you select, the file information will appear on the right and picture will be previewed in the center.

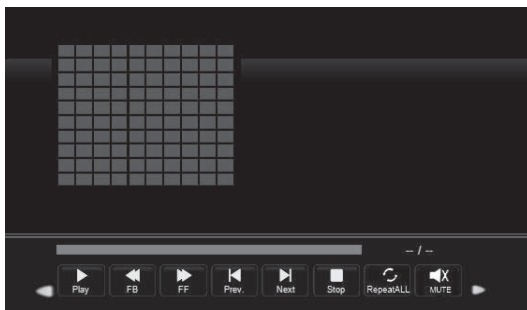

Press ◀ / ▶ button to select return option to the previous menu.

7.3. Movie menu

Press ◀ / ▶ button to select **MOVIE** in the main menu, then press **OK** button to enter. Press **Exit** button to return to the previous menu and exit menu to quit.



Press ◀ / ▶ button to select drive disk you want to watch, then press **OK** button to enter. Press media button to play the selected movie if it is suitable to play, especially its codec.

Press display button to select menu in the bottom you want to run, then press **Enter** button to operate. If a directory contains a movie with external subtitles with the same title as a movie, the device will show them (**SUBTITLE** button). You can select **CharSet** in the information bar among the multi nation alphabets. When highlighting the option you select, the file information will appear on the right and picture will be previewed in the center.

Press **Exit** button to back to the previous menu and exit button to quit the entire menu.



7.4. Text menu

Press ◀ / ▶ button to select **TEXT** in the main menu, then press **Enter** button to enter.
Press **Exit** button to return to the previous menu and exit menu to quit



Press ◀ / ▶ button to select drive disk you want to watch, then press **Enter** button to enter.
Press ◀ / ▶ button to select return option to back to the previous menu.

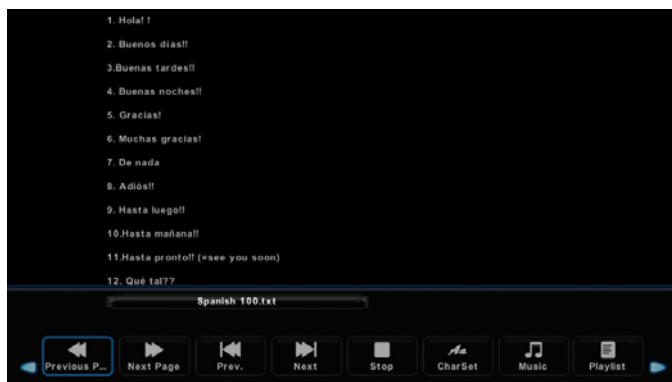

8. Trouble shooting guide



WARNING

Under no circumstances should you try to repair the device yourself, the device does not contain any parts that a user could repair himself. Always take the device to the authorised service centre in case of repair, adjustment or any other maintenance. Unauthorised intervention into the device can be considered a breach and loss of warranty claim. Importer, supplier, distributor or seller are not responsible for any loss caused by breach of regulations listed in this manual. Do not open the device because of danger of electric shock. In case of device failure, check the following problems and their solution first. If you cannot solve such problem by yourself, contact your seller.

Symptoms	Possible solutions
No power.	Check that the power cord is connected to the wall power socket. Unplug the power cord, and plug it again after 60 seconds.
No picture	Check the antenna connection. Station may be experiencing problems, tune to another station. Adjust the contrast and brightness.
Good picture but no sound	Increase volume. Is the sound muted? Press the MUTE button. Check the sound setting. If external devices are use, check their volumes are not set too low or turned off. If using AVI or Component inputs, make sure cables are connected properly and not loose. If using DVI to HDMI cable, a separate audio cable is required. Make sure a headphone jack is not connected.
Good sound but abnormal color or no picture	Check antenna connection and antenna condition. If using Component input, check Component connections, incorrect or loose connections may cause color problems or cause the screen to be blank.

Symptoms	Possible solutions
No response to remote control	Batteries of remote control may have exhausted, if necessary, change the batteries. Clean the remote control lens. The distance between LED TV and remote control should be within 8m, within recommended operating angle and path is free of obstructions. Avoid impact of strong light (daily, sunshine or light from lamps and bulbs) on television and remote control sensor.
Full screen flickering under VGA.	V-HEIGHT value may be set to big, restart computer and enter safe mode, then set monitor parameters to correct value according to adjustment description.
Horizontal stripes under VGA.	Sample phase may be deflected, adjust phase according to picture position.
Colored dots may be present on the screen	Although the LED screen is made with high-precision technology and 99.99% or more of the pixels are effective, black dots may appear or bright points of light (red, blue or green) may appear constantly on the LED screen. This is a structural property of the LED screen and not a malfunction.
Picture is breaking up	Keep the TV away from noisy electrical sources such as cars, hair dryers, welders and all optional equipment. Electrical atmospheric interferences such as local or distant lightning storms may cause picture to break up. When installing optional equipment, leave some space between the optional equipment and the TV. Check the antenna and connection. Keep the antenna away from any power or input / output cables.
After auto tuning only some channels are available.	Check your area is covered by Digital video broadcasts. Try re-tuning or manually tuning missing channels. Check that you are using the correct antenna type – see “Antenna connection”.
Channel cannot be selected.	Check if the channel has been blocked in the main menu setting.
USB is not playing	Check the USB cable and power supply. Hard drive has not been formatted. Make sure USB disk is compatible and the multimedia data formats are supported.

Symptoms	Possible solutions
Picture is distorted, macroblock, small block, dots, pixelization, etc.	Compression of video contents may cause distortion especially on fast moving pictures such as sports and action movies.
Noise from speakers	Check cable connections, make sure a video cable is not connected to an audio input. Low signal level may cause sound distortion.
TV turns off automatically	Check if the off timer or Sleep timer is turned on.
TV turns on automatically.	Check if the on timer or set to on is the Setup menu.
Picture is not shown in full screen.	First check if it is caused by the input signal, then try to adjust zoom in function menu.

Picture defects and the reason

Snowy picture

Snowy picture is usually due to weak signal. Adjust antenna or install an antenna amplifier.

Double image or ghosts

Double image is usually caused by reflections from tall buildings. Adjust the direction of the antenna or raise it.

Radio wave interference

Wave patterns are moving on the screen which are usually caused by nearby radio transmitters of short-wave receiving equipment.

High temperature electrothermal interference

Diagonal or herringbone patterns appear on the screen or part of picture is missing. This is probably caused by high temperature electrothermal equipment in a nearby hospital.

9. Technical specifications

Model	SLE 2463TC
Panel size	23,6" (60 cm)
Consumption	28 W
Standby power consumption	<0.5 W
Nominal voltage	12 V
Remote control	Included
VESA wall mount	No
Dimensions with stand (W × H × D)	557 x 367 x 165 mm
Dimensions w/o stand (W × H × D)	557 x 334 x 75 mm
Dimensions of package (W × H × D)	624 x 480 x 112 mm
Weight netto with stand	2.3 kg
Weight netto w/o stand	2.2 kg
Connections	
RF IN	1x
AV in	1x
SCART	1x
Component YPbPr	1x
VGA (D-Sub 15 pin)	1x
HDMI	1x
SPDIF coaxial	1x
USB	1x
USB supported formats	AVI, MPEG, MPEG-4, TS, MKV, FLV, VC-1/WMV9, RMVB, MP3, AAC, WAV, JPG, JPEG, TXT
CI slot	Yes
Other features	
WXGA resolution	1366 x 768
Brightness (cd/m ²)	200
Aspect ratio	16:9
Dynamic contrast	100.000:1
Response time (ms)	14ms
Colours	16.7 M
Colour temperature settings	Cool, standard, warm
Viewing angle	H: 178°, V:178°

Video system	PAL, SECAM/MPEG-2, MP@ML, MPEG-2, MP@HL, H.264
Audio system	BG/DK/I, L/L /MPEG-1 layer 1/2, DD, DD+, AAC, HE-AAC
Stereo sound	NICAM/A2
Sound output	Headphone jack
PVR recording to USB	Yes
Pitch correction	No
Progressive Scan	Yes
Timeshift function	Yes
Electronic Programme Guide EPG	Yes
Teletext	Yes
Teletext pages	1000
Comb filter	3D
OSD menu	Yes
Zoom	Yes
Noise reduction	Yes
Timer off /on/sleep	Yes
Subtitles	Yes
Audio language	Yes
Channel list	Yes
Favourites list	Yes
Picture freeze	Yes
Radio	Yes
Lock	No
Parent lock	Yes
Hotel mode	Yes

Note:

Technical specifications may change without prior notice.

Czech is the original version.

Manufacturer address: FAST ČR, a.s., Černokostecká 1621, 251 01 Říčany, Česká republika

Information sheet

Importer: FAST ČR, a.s., Černokostelecká 1621, 251 01 Říčany

Brand	Sencor
Model	SLE 2463TC
Energy efficiency class	B
Screen diagonal in cm/inches [cm/"]	60/23,6
Electric energy consumption when on [W]	28
Annual electric energy consumption* [kWh]	41
Electric energy consumption in standby mode [W]	≤0.5W
Screen resolution [pixely]	1366 x 768

* Electric energy consumption 41 kWh per year based on the power consumption of the television set operating 4 hours a day for 365 days. The actual electric energy consumption will depend on how the television is used.

INSTRUCTIONS AND INFORMATION REGARDING THE DISPOSAL OF USED PACKAGING MATERIALS

Dispose of packaging material at a public waste disposal site.



DISPOSAL OF USED ELECTRICAL AND ELECTRONIC APPLIANCES

The meaning of the symbol on the product, its accessory or packaging indicates that this product shall not be treated as household waste. Please, dispose of this product at your applicable collection point for the recycling of electrical & electronic equipment waste. Alternatively in some states of the European Union or other European states you may return your products to your local retailer when buying an equivalent new product. The correct disposal of this product will help save valuable natural resources and help in preventing the potential negative impact on the environment and human health, which could be caused as a result of improper liquidation of waste. Please ask your local authorities or the nearest waste collection centre for further details. The improper disposal of this type of waste may fall subject to national regulations for fines.

For business entities in the European Union

If you wish to dispose of an electrical or electronic device, request the necessary information from your seller or supplier.

Disposal in other countries outside the European Union

If you wish to dispose of this product, request the necessary information about the correct disposal method from local government departments or from your seller.



This product meets all the basic EU regulation requirements that relate to it.

Changes to the text, design and technical specifications may occur without prior notice and we reserve the right to make these changes.

SENCOR®

EN Warranty conditions

Warranty card is not a part of the device packaging.

This product is warranted for the period of 24 months from the date of purchase to the end-user. Warranty is limited to the following conditions. Warranty is referred only to the customer goods using for common domestic use. The claim for service can be applied either at dealer's shop where the product was bought, or at below mentioned authorized service shops. The end-user is obligated to set up a claim immediately when the defects appeared but only till the end of warranty period. The end user is obligated to cooperate to certify the claiming defects. Only completed and clean (according to hygienic standards) product will be accepted. In case of eligible warranty claim the warranty period will be prolonged by the period from the date of claim application till the date of taking over the product by end-user, or the date the end-user is obligated to take it over. To obtain the service under this warranty, end-user is obligated to certify his claim with duly completed following documents: receipt, certificate of warranty, certificate of installation.

This warranty is void especially if apply as follows:

- Defects which were put on sale.
- Wear-out or damage caused by common use.
- The product was damaged by unprofessional or wrong installation, used in contrary to the applicable instruction manual, used in contrary to legal enactment and common process of use or used for another purpose which has been designed for.
- The product was damaged by uncared-for or insufficient maintenance.
- The product was damaged by dirt, accident of force majeure (natural disaster, fire, and flood).
- Defects on functionality caused by low duality of signal, electromagnetic field interference etc.
- The product was mechanically damaged (e.g. broken button, fall).
- Damage caused by use of unsuitable media, fillings, expendable supplies (batteries) or by unsuitable working conditions (e.g. high temperatures, high humidity, quakes).
- Repair, modification or other failure action to the product by unauthorized person.
- End-user did not prove enough his right to claim (time and place of purchase).
- Data on presented documents differs from data on products.
- Cases when the claiming product cannot be indentified according to the presented documents (e.g. the serial number or the warranty seal has been damaged).

Authorized service centers

Visit www.sencor.eu for detailed information about authorized service centers.

SENCOR®

Let's live!



www.sencor.cz

Designed in Europe by Sencor®, Made in China

