

Portable IC Audio Player
Network Walkman

Operating Instructions



NW-E3

For the customers in the Netherlands

Voor de klanten in Nederland



Bij dit product zijn batterijen geleverd. Wanneer deze leeg zijn, moet u ze niet weggoien maar inleveren als KCA.

Notice for users

On the supplied software

- Copyright laws prohibit reproducing the software or the manual accompanying it in whole or in part, or renting the software without the permission of the copyright holder.
- In no event will SONY be liable for any financial damage, or loss of profits, including claims made by third parties, arising out of the use of the software supplied with this player.
- In the event a problem occurs with this software as a result of defective manufacturing, SONY will replace it.
However, SONY bears no other responsibility.
- The software provided with this player cannot be used with equipment other than that which is so designated.
- Please note that, due to continued efforts to improve quality, the software specifications may be changed without notice.
- Operation of this player with software other than that provided is not covered by the warranty.

Program©2000 Sony Corporation
Documentation©2000 Sony Corporation

NOTES:

- The recorded music is limited to private use only. Use of the music beyond this limit requires permission of the copyright holders.
- Sony is not responsible for music files that are not saved on your computer due to unsuccessful recording from CD or music downloading.
- A Backup/Restore function requires the use of the Backup/Restore service which Sony is currently developing. For authentication, this service requires the Internet. Details on the Backup/Restore service will be available on the OpenMG Web site (<http://www.openmg.com/>).
- If your PC has optical output, the music played back on OpenMG Jukebox will not send digital data through that optical output.

Table of Contents

Overview	4
What you can do with “Network Walkman”	4
On copyright protection.....	5
Other features	6
System requirements	6
About this manual	7
To use the Help files	7

Getting Started

Step 1: Unpacking	8
Step 2: Inserting the battery	9
Step 3: Installing the OpenMG Jukebox software	10

Basic Operations

Transferring music data from the computer to Network Walkman (Check-Out)	12
Listening to music with Network Walkman	15
On other operations	16
On the display	17
Transferring data from Network Walkman to the computer (Check-In)	18

Advanced Operations (Network Walkman)

Adjusting the sound	19
Emphasizing the bass sound (MEGA BASS)	19
Protecting your hearing (AVLS) ..	19
Adjusting the playback mode	20
Changing the display mode	20
Locking the controls (Hold)	21

Advanced Operations (OpenMG Jukebox)

Names and functions of the OpenMG Jukebox window	22
Menu Reference	24
OpenMG Jukebox	24
OpenMG CD Recorder	26
Uninstalling the OpenMG Jukebox	26

Other Information

Precautions	27
Troubleshooting	28
To reset the player	28
What happened ?	28
Messages	30
Specifications	31
Glossary	32
Features of copyright protection by OpenMG	33
Looking at the controls	34
Index	35

Notes

- The illustrations in this manual may differ from the actual software.
- Explanations in this manual assume that you are familiar with basic operations of Windows 98. For how to use your computer and operating system, please refer to the respective manuals.

Overview

What you can do with “Network Walkman”

Network Walkman is a portable IC audio player. You can easily transfer digital sound data from your computer to Network Walkman.

The OpenMG compliant software “OpenMG Jukebox,” which is supplied with your Network Walkman enables you to store digital music data on your computer’s hard drive, manage playlists, and transfer music to Network Walkman.

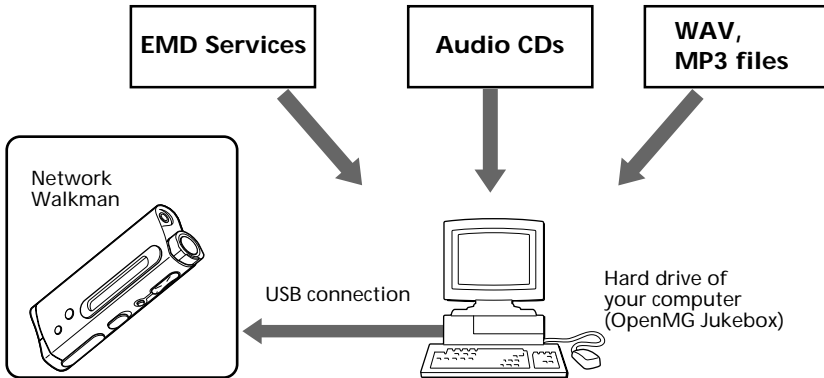

The supplied OpenMG Jukebox software allows you to import digital sound data to the hard drive of your computer as follows:

- downloads sound data provided by Electronic Music Distribution (EMD) services over digital networks such as the Internet (Please refer to the online help.)
- records audio CDs onto the hard drive of your computer (the imported tracks are compressed and encoded in ATRAC3 format) (See pages 13 - 14.)
- encodes the existing MP3 and WAV format audio files to ATRAC3 and encrypts them in OpenMG format. (Please refer to the online help.)

The OpenMG Jukebox encrypts sound data in OpenMG format and stores it on the hard drive of your computer to prevent unauthorized distribution.

Transfer of sound data from your computer to Network Walkman “Check-In/Out”

The supplied application software (OpenMG Jukebox) enables you to transfer the sound data stored on your computer’s hard drive to Network Walkman (Check-Out) and transfer it from Network Walkman to your computer (Check-In).

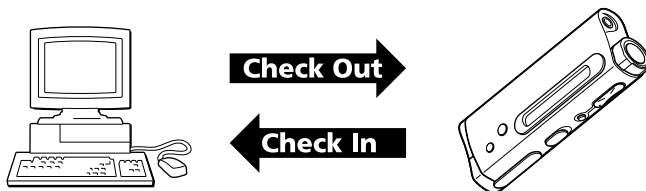

Check-In/Out has the following features:

- You can have 3 simultaneous “Check-Outs” of a song. (Some audio contents will vary.)
- Songs “Checked-Out” from one computer cannot be moved to another computer. Songs must be “Checked-In” to the computer from which they were “Checked-Out.”

For details, see “Glossary” on page 32.

On copyright protection

The OpenMG technology* allows you to enjoy digital music, while maintaining the copyrights of its holders.

Network Walkman has some features on recording and playback to protect copyrights.

For details, see “Features of copyright protection by OpenMG” on page 33.

* The copyright protection technology of Network Walkman conforms to the SDMI (Secure Digital Music Initiative) specifications.

Restrictions on sound data

Some sound data is distributed with restrictions on recording or playback of the data to maintain the copyrights of its holders.

Network Walkman employs copyright protection technology that enables you to record or play music within the limits determined by the copyright holders. For example, songs which have playback period restrictions can be played back only within the given period of time.

Other features

- Compact size, light weight
- Anti-skip function: you can enjoy uninterrupted enjoyment of music during physical activities such as jogging or commuting.
- Select record time: up to 60 min., 80 min., 120 min.*
- Full-dot LCD screen: song titles and artist names can be displayed.
- Shuttle switch: easy to operate.
- High speed data transfer using the supplied dedicated USB cable.
- OpenMG Jukebox software enables you to record compact discs using the ATRAC3 format (high sound quality, high compression) to the hard drive.

* Differs according to the bit rate when recording. In this case, the figures for the recordable time are when recording at 132kbps, 105kbps, and 66kbps.

System requirements

- IBM PC/AT or Compatible
CPU: MMX™ Pentium® 233 MHz or higher
Hard disk drive space: 50 MB or more
RAM: 64 MB or higher
CD-ROM drive
Sound Board
USB port
- Operating System: Windows® 98/Windows® 98 Second Edition (manufacturer installed)
The following environments are not supported.
–Windows 95, Windows NT and Windows 2000
–Upgraded from Windows 3.1/95 to Windows 98 (or Windows 98 Second Edition)
–Dual boot with Windows 2000 and Windows 98 (or Windows 98 Second Edition)
- Display: High (16bit) Color or more (800 × 480 dot or more)
- Internet access: for Web registration and EMD services

Note

We do not assure trouble-free operation for all computers satisfying the system requirements.

Network Walkman is trademark of Sony Corporation.

OpenMG and its logo are trademarks of Sony Corporation.

WALKMAN and  are registered trademarks of Sony Corporation.

IBM and PC/AT are registered trademarks of International Business Machines Corporation.

Microsoft and Windows are trademarks of Microsoft Corporation, registered in the U.S.A. and other countries.

Copyright ©1995 Microsoft Corporation. All Rights Reserved.

Portion Copyright ©1995 Microsoft Corporation

MMX and Pentium are registered trademarks of Intel Corporation.

All other trademarks and registered trademarks are trademarks or registered trademarks of their respective holders.

US and foreign patents licensed from Dolby Laboratories Licensing Corporation.

About this manual

This manual explains how to operate Network Walkman. For details on how to use the supplied software (OpenMG Jukebox), refer to the OpenMG Jukebox Help files.

To use the Help files

Displaying the Help files



The supplied software includes two types of Help files:

- OpenMG Jukebox Help: Help files on how to use the OpenMG Jukebox software.
- Network Walkman Help: Help files on how to use Network Walkman when connected to a computer.

You can display the Help files by either of the following ways:

- Click [Start]-[Programs]-[OpenMG Jukebox]-[OpenMG Jukebox Help] or [Network Walkman Help].
- Start the OpenMG Jukebox software, then click [Help]-[OpenMG Jukebox Help] or [Network Walkman Help].

Selecting a topic from the contents

- Double click  to display the items included in the title.
- Double click  to display the contents of the item.
- Click the underlined item to display reference page on the item.



Searching using a keyword

-
- 1 Select the [Index] tab from the Help dialog box.
The Keyword list appears.

 - 2 Enter the keyword you want to apply, or scroll through the keyword list.

 - 3 Select a topic, then click [Display].
Topics related to the keyword appear.
-

Step 1: Unpacking

Your Network Walkman comes with the following items.

- Network Walkman (1)

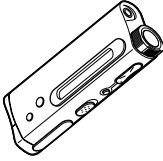

- Size AAA (LR03) (1)

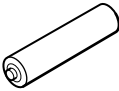

- Headphones (1)

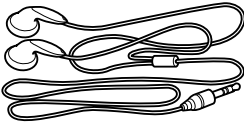

- Headphones extension cord (1)

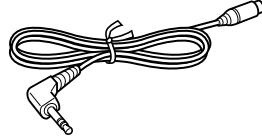

- Dedicated USB cable (1)

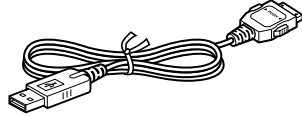

- Carrying pouch (1)
- CD-ROM
(OpenMG Jukebox installation disc) (1)
- Operating Instructions (1)

Note

Be sure to keep the CD-ROM and CD key in a secure place.

Step 2: Inserting the battery

Insert the size AAA (LR03) alkaline battery (supplied) with correct polarity. Be sure to insert it from the  side as illustrated.

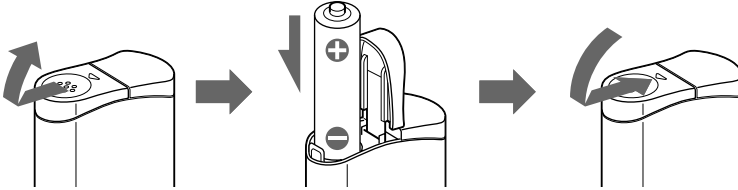

Battery duration

About 5 hours*.

* The battery life may be shorter due to operating conditions and the temperature of the location.

On the remaining battery indication

The battery icon in the display changes as shown below.

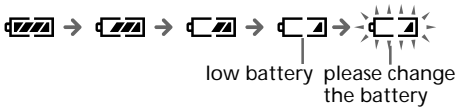

If "LOW BATT" is displayed in the display, you need to change the battery.

Notes

If you do not use the battery correctly, it may become damaged from leakage and corrosion. For best results:

- Use the alkaline battery.
- Make sure the polarity is correct.
- Do not charge a dry cell battery.
- Remove the battery, if you do not intend to use the player for an extended period of time.
- If you have battery leakage, replace with a new battery after cleaning the battery compartment.

If the battery compartment lid is accidentally detached, attach it as illustrated.

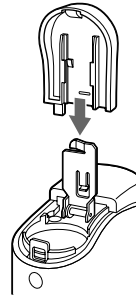

Step 3: Installing the OpenMG Jukebox software

This section describes how to install the OpenMG Jukebox software to your computer. Before installation, turn on your computer, and start Windows 98.

Note

Be sure to install the software **before** connecting Network Walkman with the supplied dedicated USB cable. Do not install the software while connecting the dedicated USB cable. Connect the dedicated USB cable only after you have restarted the computer after installation.

-
- 1 Insert the supplied CD-ROM into the CD-ROM drive of your computer.
 - ① Find the folder labeled with the language you want to select in the CD-ROM. For example, if you want to install the OpenMG Jukebox with help files in English, select the [English] folder.
 - ② Open the desired folder, and double-click [Setup.exe] inside the folder. The Setup program starts up and the following window appears.



-
- 2 Follow the instructions in the Installer window to complete the installation. When the Input window for the CD key appears, input the CD key written on the CD-ROM case label. When the installation is finished, the following dialog box appears in the display.



Click [Finish] to restart the computer.

Note

Do not delete, move or modify the installed folder.

About the “OpenMG(NW-E3) Registration” icon on the desktop

When you restart the computer after installing the software, the “OpenMG(NW-E3) Registration” icon will appear on the desktop. Make sure that you can connect to Internet, then double-click this icon to start customer registration for this product (Network Walkman) and for the EMD services.

For details on registration, refer to the supplied leaflet in the box.

Notes on EMD (Electronic Music Distribution) services

To use OpenMG-enabled EMD services on the Internet, the following conditions are required.

- You need Internet access from your computer. (Sign up an Internet service provider.)
- You need to download several programs (e.g., EMD key installer).
To download these programs, double-click the “OpenMG(NW-E3) Registration” icon, then follow the displayed instructions.
- You need to register yourself with the EMD service provider you are going to use. Consult the provider for details.

Notes for existing OpenMG Jukebox users

- 1** In order to update your OpenMG Jukebox software, your current software must be registered. If your software is not registered, please register your current software now. If you are a registered user, proceed to step 2.
- 2** Insert the CD-ROM supplied with your new product. This will automatically run. If the program does not start, double-click [Setup.exe]. Please follow the on-screen instructions to retain all existing music files and update your software.
- 3** After your update is completed, restart the computer. Then double-click the “OpenMG(NW-E3) Registration” icon on your desktop and follow the instructions to register.

Notes

- If the OpenMG Jukebox icon is displayed on the task tray, right-click the icon to choose [Remove from the task tray], then proceed with the installation.
- Be sure to input the CD keys of the CD-ROM you are going to install. If an error message appears in the display, check if the CD keys are of the correct CD-ROM case label.

Transferring music data from the computer to Network Walkman (Check-Out)

This section describes how to record the contents of a compact disc onto the hard drive of your computer, and then how to transfer it to Network Walkman (Check-Out).

You can also download by using EMD Services, or convert MP3 files and WAV format audio files. Please refer to the online help for more information.

1 Connect Network Walkman to your computer.

Connect the wide connector of the supplied dedicated USB cable into the dedicated USB jack on Network Walkman, then the narrow connector to the USB jack of your computer.

"CONNECT" appears in the display.

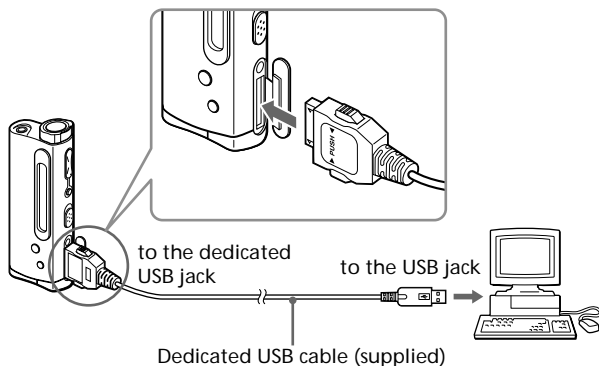

To remove the USB connector from Network Walkman

While pressing the buttons on both sides of the connector, pull it out.

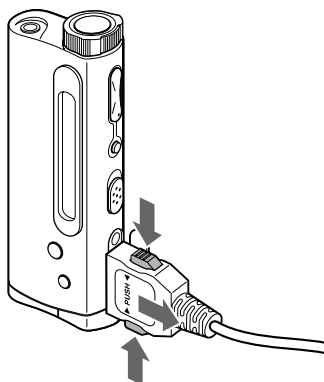

Notes

- Do not connect more than two USB devices to your computer. Normal operation will not be guaranteed.
- Use of this player with a USB hub or a USB extension cable is not guaranteed.
- A malfunction may occur depending on the USB devices connected at any one time.
- Be sure to insert the battery into Network Walkman when connecting it to your computer.
- When connecting Network Walkman to your computer for the first time, the USB driver Installer window appears. Please follow the instructions in the Installer window.
- Connect Network Walkman only as necessary. Disconnect the dedicated USB cable while you do not use Network Walkman with the computer connected.

2 Start the OpenMG Jukebox software.

Double click the OpenMG Jukebox icon on the desktop or click [Start]-[Programs]-[OpenMG Jukebox]-[OpenMG Jukebox].

The OpenMG Jukebox window appears.

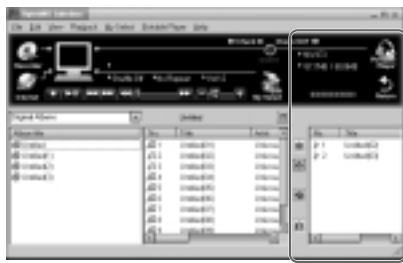

Portable Player window
(The music files inside Network Walkman appear.)

If the Start-Up function is ON

The OpenMG Jukebox software automatically starts when Network Walkman is connected to your computer. (Please refer to the online help for more information.)

3 Start recording.

You can record music from a compact disc onto the hard drive of your computer, using the OpenMG CD Recorder software.

- ① Insert the compact disc you want to record into the CD-ROM drive of your computer. If the OpenMG CD Recorder automatically starts, go to ③.
- ② Click the [Recorder] button in the OpenMG Jukebox window.
The OpenMG CD Recorder window appears showing the contents of the compact disc.

If the message “Do you want to check your CD Drive to optimize for recording ?” appears in the display

This message appears when you use the OpenMG CD Recorder for the first time. We recommend you to choose [Yes]. You can optimize the CD drive later, too. Please refer to the online help for more information. (It may take up to 20 minutes to optimize the CD drive.)

- ③ Click ●.



bit rate
● button

The recording begins. When recording is finished, the recorded music will appear in the OpenMG Jukebox window as a new album.

continued

Transferring music data from the computer to Network Walkman (Check-Out) (continued)

To stop the recording

Click **■**. The recording will be interrupted.

Click **●** again to continue the recording.

To select only certain items

Click the check box of the contents you do not want to record to remove the check, then click **●**.

On the bit rate

You can choose the bit rate (page 17, 32) among 132kbps, 105kbps, 66kbps. If you choose a higher bit rate, recording will have better sound quality, however the recordable time will be shorter. If you choose a lower bit rate, you can record longer, however the sound will not be as good. See below for the recording time according to the bit rate.

- 132kbps: maximum 60 min.
- 105kbps: maximum 80 min.
- 66kbps: maximum 120 min.

(The recording time differs according to the number of songs you are recording.)

To choose the bit rate, click [Control]-[Settings]. The Settings window appears. Click the Recording Setup tab and choose from the ATRAC3 Bit rate list. Please refer to the online help for more information.

To name a new album or song

You can enter the name using the keyboard or bring the name from the Internet database.

Please refer to the online help for more information.

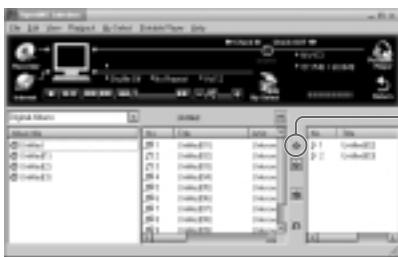

4 Transfer the music file to Network Walkman (Check-Out).

- ① Check that the Portable Player window (page 13) is displayed on the right side of the OpenMG Jukebox window.
- ② Click the album which contains the songs you want to Check-Out.
The contents of the album appear.
- ③ Click the music item you want to Check-Out.
Click the music item while pressing the Ctrl key to choose more than one music item.
- ④ Click the  button.
The desired music item appears in the Portable Player window as Check-Out candidate.



Click here

To cancel the song added as Check-Out candidate, click the respective song in the Portable Player window, then click the  button.

- ⑤ Click the START button.
The desired music item is Checked-Out to Network Walkman.
During Check-Out, the STOP button flashes and "ACCESS" flashes in the Network Walkman's display. When Check-Out is finished, the  indication changes to .

To quit Check-Out

Click the STOP button.

To Check-In

See page 18.

Listening to music with Network Walkman

Please insert the battery before use (see page 9).

Note

When using Network Walkman, be sure to disconnect it from the computer.

1 Connect the headphones.

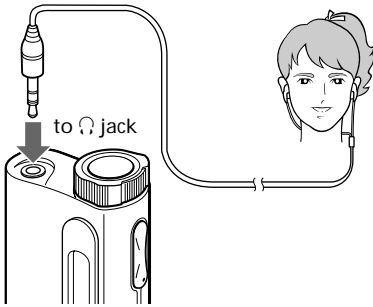

To use the headphones extension cord

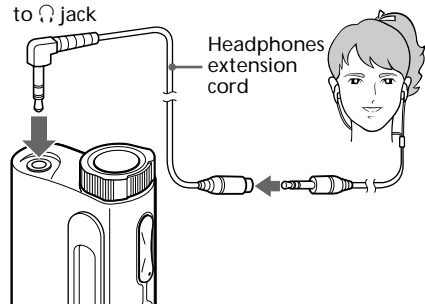

2 Start playback.

① Press the ►■ button

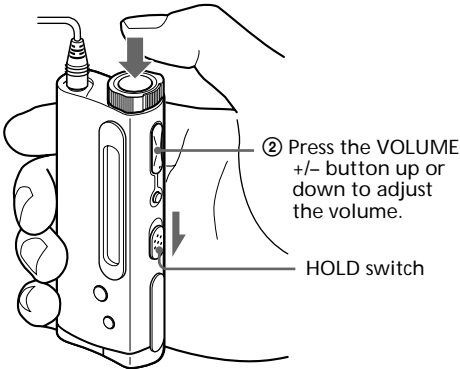

Playback stops automatically when the music reaches the end (only when the REPEAT mode is off).

If playback does not start

The HOLD switch may be switched up. Please release it down (page 21).

To stop playback

Press the ►■ button.

Tip

If you do not operate the player for 3 seconds while in stop mode, the display automatically turns off.

On other operations

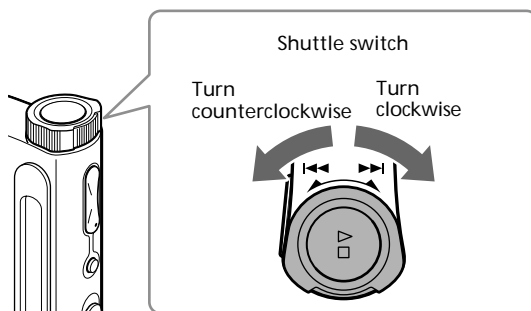

To	Operation of the shuttle switch
Go to the beginning of the next track	Turn clockwise once.
Go to the beginning of the succeeding tracks	Turn clockwise continuously.
Go to the beginning of the actual track	Turn counterclockwise once.
Go to previous tracks	Turn counterclockwise continuously.
Go forward *	While playback, turn clockwise and hold still.
Go backward *	While playback, turn counterclockwise and hold still.

* If you turn the shuttle switch and hold still for more than 5 seconds during playback, the search speed increases.

On the display

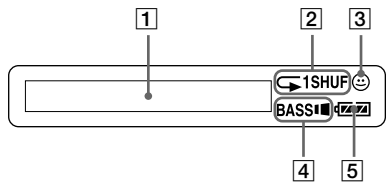

1 Text/graphic information display (page 20)

The following information is displayed according to the display mode.

• Elapsed time mode

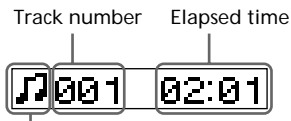

Play status
 During playback: or is displayed alternately.
 In stop mode: is displayed.
 While locating tracks: or is displayed.
 While searching a point in a track: or is displayed.

• Title mode

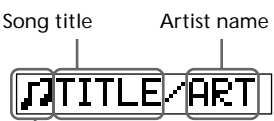

Play status

• Graphic mode

Spectrum analyzer



Bit rate (page 14, 32)
: songs recorded at 132kbps
: songs recorded at 105kbps
: songs recorded at 66kbps
: songs recorded at 47kbps*

* If you convert a monaural audio MP3/WAV file, the bit rate will be 47kbps.

2 Play mode indication (page 20)

The selected play mode is displayed.

3 AVLS indication (page 19)

The indication lights up while the AVLS function is activated.

4 MEGA BASS indication (page 19)



The indication lights up while the MEGA BASS function is activated.

5 Battery remain indication (page 9)

The remaining battery power is displayed.

Transferring data from Network Walkman to the computer (Check-In)

You can return the tracks recorded on Network Walkman back to the hard drive of your computer (Check-In). You can return them only to the same computer from which the tracks have been Checked-Out.

- 1** Connect Network Walkman to your computer and start the OpenMG Jukebox software.
The Portable Player window appears. See pages 12 and 13 for details.
 - 2** Click the track you want to Check-In in the Portable Player window, then click the  button.
Click the track while pressing the Ctrl key to choose more than one track.
To Check-In all the tracks, click the  button.
 - 3** Click the START button.
The desired tracks are Checked-In. During Check-In, the STOP button flashes. When Check-In is finished, the song titles disappear from the Portable Player window.
-

To cancel Check-In

Click the STOP button.

Adjusting the sound

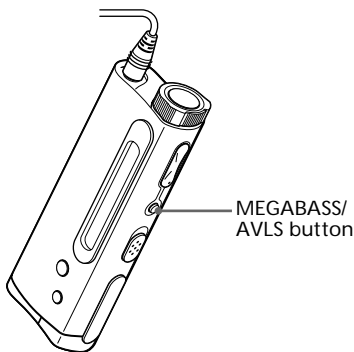

Emphasizing the bass sound (MEGA BASS)

Mega Bass function intensifies low frequency sound for richer quality audio reproduction.

Press the MEGABASS/AVLS button.

Each time you press the MEGABASS/AVLS button, the MEGABASS indication changes as follows:



Display indication	Sound quality
BASS I	Mega Bass (moderate effect)
BASS II	Mega Bass (strong effect)
none	normal play

Note

If the sound becomes distorted when emphasizing the bass, turn down the volume.

To cancel the MEGA BASS effect

Press the MEGABASS/AVLS button repeatedly until the MEGA BASS indication goes off.

Protecting your hearing (AVLS)

The AVLS (Automatic Volume Limiter System) function keeps down the maximum volume to protect your ears.

Press and hold the MEGABASS/AVLS button.

The ☺ (AVLS) indication lights up in the display.

The volume is kept to a moderate level.

To cancel AVLS

Press and hold the MEGABASS/AVLS button until the ☺ indication goes off.

Adjusting the playback mode

You can play tracks repeatedly in three ways— all repeat, single repeat and shuffle repeat.

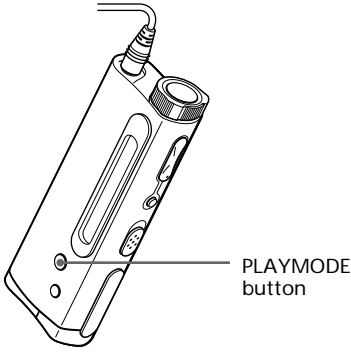

Press the PLAYMODE button.

Each time you press the PLAYMODE button, the play mode indication changes as follows:

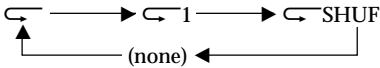

Display indication	Playback mode
←	all tracks repeatedly
← 1	current track repeatedly
← SHUF	all tracks repeatedly in random order
none	normal

To cancel the playback mode

Press the PLAYMODE button repeatedly until the play mode indication goes off.

Changing the display mode

You can change the display mode and display the song titles, spectrum analyzer, etc. while in playback or stop mode.

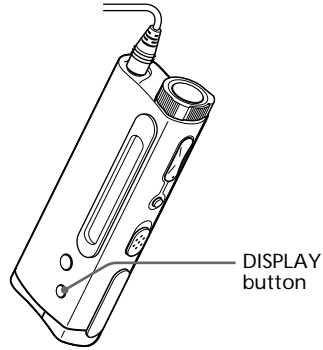

Press the DISPLAY button.

Each time you press the DISPLAY button, the display changes as shown below.

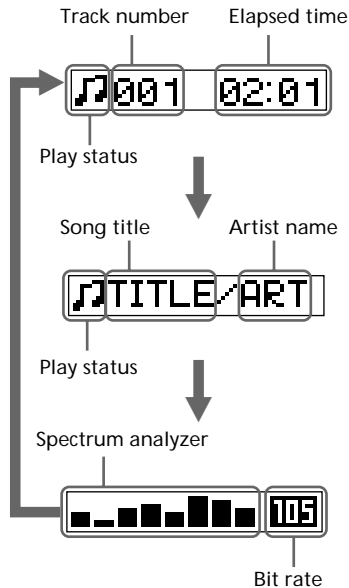

Locking the controls (Hold)

To prevent the controls from being accidentally operated when you carry the player, use this function.

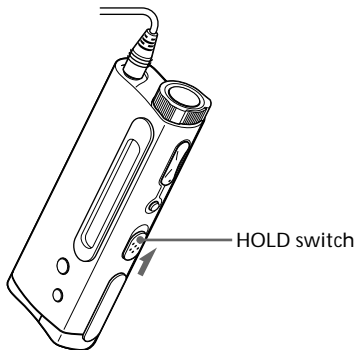

Slide the HOLD switch in the direction of the arrow.

No controls will be able to operate.

If you press buttons while the HOLD switch is ON, "HOLD" appears in the display.

To release the Hold function

Slide the HOLD switch in the opposite direction of the arrow.

Names and functions of the OpenMG Jukebox window



- 1 Menu bar: for details on each menu items, see page 24.
- 2 Operation buttons: you can play or adjust the volume, etc.
- 3 Close button: quits the OpenMG Jukebox software. (You can also quit by clicking [File]-[Quit])
- 4 Portable Player: opens the Portable Player window (page 23)
- 5 Edit My Select: opens the My Select window.
- 6 Song title list: displays the song titles listed in the selected album/Filter
- 7 Album title list: displays the album/Filter titles in the OpenMG Jukebox

- 8 Album view select box: You can select albums and songs that you want to view.
Original Albums: Displays an original album and the songs included in that album.
My Selections: Displays a My Select album and the songs included in that album.
Original & My Selections: Displays both albums and the songs included in those albums.
Various Search: Displays only the albums and songs which match a certain condition.
- 9 Internet: for using EMD services
- 10 Recorder: opens the OpenMG CD Recorder window
- 11 Playback mode buttons: you can set the shuffle mode, repeat mode, etc.

Portable Player window

When you connect Network Walkman to the computer, the Portable Player window appears in the display on the right side of the OpenMG Jukebox.

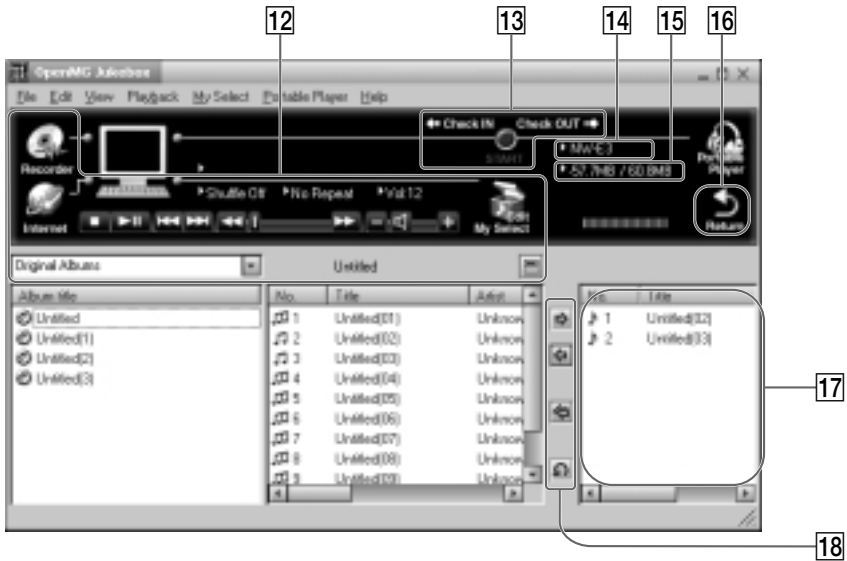

- 12 You can use these buttons to operate the OpenMG Jukebox software (see page 22 for more information).
- 13 CHECK IN/OUT START (STOP) button: starts or stops the Check-In/Out
- 14 Name of the connected portable player (such as Network Walkman)
- 15 Memory space on Network Walkman or memory used for audio files, and total memory capacity*

- 16 RETURN button: closes the Portable Player window
 - 17 Displays the song titles recorded on Network Walkman
 - 18 Check-In/Out buttons (to start Check-In/Out, click the START button next)
- * "60.6MB" appears in the display as the total memory capacity. This number is a result of subtracting memory for the system operation of Network Walkman.

Menu Reference

OpenMG Jukebox

[File] menu

CD Recorder

Opens the OpenMG CD Recorder window.

Internet

Accesses the Web site for the EMD service supporting OpenMG or CD database.

File Import

MP3/WAV: Starts up OpenMG File Importer.
Windows Media: Starts up OpenMG Internet File Importer (if available).

Settings

Displays the “Settings” window of the OpenMG Jukebox.

Exit

Exits the OpenMG Jukebox.

[Edit] menu

Delete

Deletes the currently selected album/song.

Divide

Divides the currently played song.

Combine

Combines the selected two songs.

Get CD Info

Automatically registers audio CD information such as the titles of an album or a song by accessing a CD database.

URL

Displays the web pages related to an album, registered in advance.

Rename

Changes the name of the currently selected album/song.

Enter Search Keyword

Displays the dialog box for entering search keywords for [Find by Artist], [Find by Song] or [Find by Genre] of the “Various Search” window.

Note

You cannot select this command when “Original Album” list, “My Select Album” list or search methods other than [Find by Artist], [Find by Song] or [Find by Genre] are displayed.

Properties

Shows information on the currently selected album/song.

[View] menu

Simple Mode

Switches the OpenMG Jukebox to “Simple Mode” window.

Cover Art

Displays images registered in the album as jacket illustrations.

Music Visualizer

Starts up Music Visualizer.
Shown only with Sony VAIO series computers in which Media Bar 3.0 or later is installed.

Operation Panel

Shows/hides the button/control information of the OpenMG Jukebox.

Status Bar

Shows/hides the Status Bar of the OpenMG Jukebox.

Original Album

Displays the “Original Album” list.

My Selection

Displays the “My Select Album” list.

Various Search

Displays the album list which matches a certain condition.

Refresh

Updates the various information shown on the OpenMG Jukebox to the latest data.

[Playback] menu

Play

Plays the currently selected album/song.

Pause

Pauses playback.

Stop

Stops playback.

Next

Locates the beginning of the next song in the currently played album.

Previous

Locates the beginning of the currently played song.

Repeat All

Repeats all songs in the currently played album.

Single Repeat

Repeats the currently played song.

No Repeat

Cancels repeat play and returns to normal playback.

Shuffle

Turns on and off the shuffle playback which plays the songs in an album in random order.

[My Select] menu

New

The “Edit My Select” window opens to create a new “My Select Album.”

Rename Album

Changes the name of a “My Select Album.”

Add Songs

Adds the currently selected song to the currently created “My Select” album.

Remove songs

Deletes the currently selected song from the “My Select Album” shown in the “Edit My Select” window.

Close

Closes the “Edit My Select” window.

[Portable Player] menu

Open

Opens the “Portable Player” window.

Execute

Checks in/out the “Check In/Check Out” candidates.

Stop

Stops “Check In/Check Out” before it is completed.

Undo

Cancels all the registration of the “Check In/Check Out” candidates.

Check Out

Registers the currently selected album/song as a “Check Out” candidate.

Check In

Registers the currently selected album/song as a “Check In” candidate.

Check In All

Registers all the songs in the portable player as “Check In” candidates.

Delete

Deletes the currently selected song from the portable player.

Rename

Changes the name of the currently connected portable player.

Select

When two or more portable players are connected to the computer, switches the player operated on the “Portable Player” window.

Initialize...

Initializes the memory of the connected portable player.

Note

Depending on the type of the portable player to connect to your computer, this function may not be utilized.

Close

Closes the “Portable Player” window.

[Help] menu

OpenMG Jukebox Help

Shows the help file for OpenMG Jukebox.

Network Walkman Help

Shows the help file for Network Walkman.

About OpenMG Jukebox

Shows the version, the CD key information, etc. of the OpenMG Jukebox.

If you have installed the OpenMG Jukebox with two or more CD-ROMs, the CD key of the CD you used first is displayed here.

Menu items for the “Simple Mode”

Play

Plays the currently selected album/song.

Pause

Pauses playback.

Stop

Stops playback.

Next

Locates the beginning of the next song in the currently played album.

Previous

Locates the beginning of the currently played song.

Repeat All

Repeats all songs in the currently played album.

Single Repeat

Repeats the currently played song.

No Repeat

Cancels repeat play and returns to normal playback.

Shuffle

Turns on/off the shuffle play with which the songs in an album are played back in random order.

Select Album

Selects the album for playback. The [Select Album] dialog box appears. Choose the desired album and click [OK].

Always On Top

Shows the “Simple Mode” window always on top of other software.

continued

Menu Reference (continued)

Full Mode

Returns to the “Full Mode” window of the OpenMG Jukebox.

Skin

Selects a Skin to use in the “Simple Mode.” The [Select Skin] dialog box appears. If more than one Skins are registered, choose the one you like and click [OK].

Exit

Exits the OpenMG Jukebox.

OpenMG CD Recorder

[Control] menu

Rec

Starts recording of an audio CD.

Stop

Stops recording of an audio CD.

Play

Plays an audio CD. You cannot play an audio CD while recording is performed.

Pause

Pauses playback of an audio CD.

Eject

Ejects an audio CD.

CD Info.

Automatically registers audio CD information such as the titles of an album or a song by accessing a CD database.

Internet

Accesses the Web site for the EMD service supporting OpenMG or CD database.

Select All Tracks

Selects all tracks in an audio CD for recording.

Clear All Tracks

Removes all the check marks for recording.

Settings

Displays the “Settings” window.

Launch OpenMG Jukebox

Starts up the OpenMG Jukebox.

Exit

Exits the OpenMG CD Recorder.

[Help] menu

Contents

Shows the help file for OpenMG Jukebox.

About OpenMG CD Recorder

Shows the version information of the OpenMG CD Recorder.

Uninstalling the OpenMG Jukebox

Follow the instructions below on how to uninstall the OpenMG Jukebox.

- 1 Click [Start]–[Settings]–[Control Panel] to display the Control Panel.
 - 2 Double-click [Add/Remove programs].
The Add/Remove programs Property window appears.
 - 3 Click “OpenMG Jukebox” from the list.
 - 4 Click [Add/Remove].
The OpenMG Jukebox software is uninstalled.
-

Note

After uninstallation, the compact disc may not start playing automatically when inserted into the CD-ROM drive. In this case, refer to the instruction manual or online help of the player software you are using to set to start automatically.

Precautions

On installation

- Never use the player where it will be subjected to extremes of light, temperature, moisture or vibration.
- Never wrap the player in anything when it is being used with the AC power adaptor. Heat build-up in the player may cause malfunction or damage.

On the headphones

Road Safety

Do not use headphones while driving, cycling, or operating any motorized vehicle. It may create a traffic hazard and is illegal in many areas. It can also be potentially dangerous to play your player at high volume while walking, especially at pedestrian crossings. You should exercise extreme caution or discontinue use in potentially hazardous situations.

Preventing hearing damage

Avoid using headphones at high volume. Hearing experts advise against continuous, loud and extended play. If you experience a ringing in your ears, reduce the volume or discontinue use.

Caring for others

Keep the volume at a moderate level. This will allow you to hear outside sounds and to be considerate of the people around you.

On cleaning

- Clean the player casing with a soft cloth slightly moistened with water or a mild detergent solution. Do not use any type of abrasive pad, scouring powder or solvent such as alcohol or benzene as it may mar the finish of the casing.
- Clean the headphones plug and extension cord plug periodically.

If you have any questions or problems concerning your Network Walkman, please consult your nearest Sony dealer.

Troubleshooting

If you experience any of the following difficulties while using Network Walkman, use this troubleshooting guide to help you remedy the problem. Should any problem persist, consult your nearest Sony dealer. For trouble concerning operations while connecting with your computer, please refer to the supplied software's online help "Troubleshooting" contents, too.

To reset the player

If Network Walkman does not operate normally or if there is no sound, even after checking the troubleshooting guide below, remove the battery, then re-insert it.

What happened ?

On playback

Symptom	Cause/Remedy
There is no sound.	→ Adjust the volume. (page 15) → Connect the headphones securely to the headphones jack.
The controls on the player do not work.	→ If the player is connected to the computer, disconnect it. → Make sure that the Hold function is deactivated (page 21). → Condensation may have developed inside the player. Allow it to sit for about 2 or 3 hours. → If the battery is weak, replace it with a new one. → Check that the battery is inserted correctly.
The volume does not increase.	→ Cancel the AVLS function. (page 19)
Sound is distorted.	→ Record with a higher bps value. (page 14)
There is no sound from the right channel of the headphones.	→ Make sure that the headphones plug is connected securely.
Playback has stopped suddenly.	→ The battery is exhausted. You need to change it. (page 9)

On the display window

Symptom	Cause/Remedy
"□" appears instead of the album title.	→ Use the OpenMG Jukebox to rename the title with characters which can be displayed on the player.

On the connection with the computer and the supplied software

Symptom	Cause/Remedy
The software cannot be installed.	→ Check your system. (page 6)
The installation does not begin automatically.	→ Run the Setup.exe. file on the supplied CD-ROM. (page 10)
"CONNECT" does not appear in the display window when connecting to the computer with the supplied dedicated USB cable.	→ Please wait for the authentication of the OpenMG Jukebox (page 32) to be finished. → If another software is active on your computer, wait for a while, then reconnect the dedicated USB cable. If the problem persists, disconnect the dedicated USB cable, restart your computer, then connect the dedicated USB cable to your computer again. → Make sure the dedicated USB cable is correctly connected.

Symptom	Cause/Remedy
The computer does not identify the player when it is connected to the computer.	→ Make sure the dedicated USB cable is correctly connected. (page 12)
The computer/player do not operate normally when connected.	→ If you are connecting both devices with a USB hub or a USB extension cable, normal operation is not guaranteed. Please use only the supplied dedicated USB cable.
“Failed to authenticate the portable player” appears on the display when the player is connected to the computer.	→ You cannot use this player anymore. Please contact your nearest Sony dealer.
Cannot Check-Out.	<ul style="list-style-type: none"> → The dedicated USB cable is not fully plugged in. Disconnect the dedicated USB cable and re-connect it. → A song cannot be Checked Out more than three times. Check the song back in from one of your other portable players so that Checking Out is enabled again. → The available memory space in the Network Walkman may be insufficient. → If the song has a limited playing period or playing count, you may not be able to check it out to the Network Walkman, depending on the restrictions set by the copyright holders. For details on the settings of each song, contact the service, or see the OpenMG Web site by clicking the Internet icon in OpenMG Jukebox. → You may be trying to check out 121 or more songs to the Network Walkman. The maximum number of songs that can be checked out to the Network Walkman is 120.
There are only a few songs I can Check-Out. (The recordable time is short.)	→ The free memory space of Network Walkman may be less than the data of the song you want to Check-Out. Check-In unnecessary songs to make more memory space.
Cannot Check-In.	<ul style="list-style-type: none"> → The songs can only be checked in to the computer from which they were checked out. → If a song is deleted from the computer, it cannot be Checked In.
Check-In starts automatically when the player is connected to the computer.	→ If you delete songs using another computer’s OpenMG Jukebox software, when you reconnect to your computer, the OpenMG Jukebox software will register those songs as Checked In, and the remaining available Check-Out count is restored.
The CD cannot be recorded.	→ Clean the CD.

Other

Symptom	Cause/Remedy
The player gets warm.	→ The player gets warm during playback.
The buttons do not operate.	<ul style="list-style-type: none"> → Make sure the HOLD switch is OFF. (page 21) → You must change the battery. (page 9)

Messages

Follow the instructions below if a message appears in the display.

Message	Meaning	Remedy
ACCESS	The player is accessing the flash memory.	This is not an error. This message appears during Check-Out and during initialization of the flash memory.
AVLS	The volume exceeds the maximum level.	Turn down the volume or cancel the AVLS function (page 15, 19).
CONNECT	The player is connected to the computer.	This is not an error. You can operate using the OpenMG Jukebox software, but you cannot operate the controls on the player.
FLASH ERR	The player cannot read the data in the memory.	There is an error in the data. Initialize the memory (page 30).
HI DC IN	The DC IN voltage is too high.	The connected computer may have trouble. Disconnect the dedicated USB cable and examine the computer.
HOLD	The HOLD switch is ON, and no operating buttons are available.	This is not an error. Switch the HOLD switch to OFF before operating the buttons. (page 21)
LOW BATT	The battery is low, and needs to be changed.	You must change the battery. (page 9)
LOW DC IN	The DC IN voltage is too low.	The connected computer may have trouble. Disconnect the dedicated USB cable and examine the computer.
NO MUSIC	There are no tracks inside the player.	Use the OpenMG Jukebox to Check-Out music items. (page 12)

To initialize the flash memory

If “FLASH ERR” appears in the display, there is an error in the data in the built-in flash memory. In this case, initialize the flash memory following the steps below.

1 Connect the Network Walkman to your computer.

After the computer recognizes the Network Walkman, the Portable Player window opens and the song titles stored in the Network Walkman appear. (pages 12 and 13)

2 Click [Initialize] from the [Portable Player] menu of the OpenMG Jukebox.

The confirmation dialog box appears.

3 Click [Yes.]

Initializing starts automatically and “ACCESS” flashes in the display.

After initializing, all song titles are cleared in the Portable Player window. If the portable player name is specified, it is also cleared.

4 Remove the dedicated USB cable from the Network Walkman.

Be sure to remove the cable before performing the next operation.

Note

Do not disconnect the dedicated USB cable during initialization.

Specifications

Recording time

Approx. 60 min. (132kbps)

Approx. 80 min. (105kbps)

Approx. 120 min. (66kbps)

Sampling frequency response

44.1kHz

Recording format

ATRAC3

Frequency response

20 to 20,000 Hz (single signal measurement)

Output

Headphone: stereo mini-jack

Signal-to-noise ratio (S/N)

More than 80dB (excluding 66 kbps)

Dynamic range

More than 85dB (excluding 66 kbps)

Operating temperature

5°C to 35°C (-41°F to 95°F)

Power source

Size AAA (LR03) battery (1)

Battery life

Approx. 5 hours

Dimensions (approx.)

81 × 32 × 14.6 mm (3 1/4 × 1 1/4 × 19/32 inches)

(w/h/d, projecting parts not included)

Mass (approx.)

45g (1.6 oz) (battery included)

Memory capacity

64MB (including the system software: 60.6MB available)

Supplied accessories

Size AAA (LR03) battery

Headphones

Headphones extension cord

Dedicated USB cable

CD-ROM

Carrying pouch

Operating Instructions

Design and specifications are subject to change without notice.

Glossary

ATRAC3

ATRAC3, which stands for Adaptive Transform Acoustic Coding3, is audio compression technology that satisfies the demand for high sound quality and high compression rates.

The ATRAC3 compression rate is double that of the Mini Disc, resulting in increased data capacity for the media.

Bit rate

Quantity, per second, of information. The unit is bps (bit per second). You can choose from 132kbps/105kbps/66kbps when recording a compact disc or converting an MP3/WAV file to an ATRAC3 file. For example, 105kbps means there are 105000 bits of information per second being transferred. Bigger the number, larger is the information. When comparing audio files of the same format, you can enjoy a better sound quality when recorded at 132kbps than at 105kbps, also better at 103kbps than at 66kbps. (Audio files cannot be compared if of different format)

“Check-In /Check-Out”

Check-Out is to transfer music files managed on a personal computer by an OpenMG-compliant software to a portable player (such as Network Walkman). Returning the Checked-Out music files back to that computer is to Check-In. (You cannot move a Checked-Out audio data to another computer.)

You can also Check-Out a music file, Check it back In, and then Check it Out again.

The SDMI rules provide that up to four copies of a music file can be created unless a special condition for usage is set. Thus, unless a special restriction exists while one copy is saved in the computer, the other three can be Checked-Out to the Portable Players.

MP3

Abbreviation for MPEG-1 Audio Layer3. A standard for audio data compression determined by the Motion Picture Experts Group, which is an ISO (International Organization for Standardization) working group.

It enables compression of audio data to about 1/10 of the data size of a standard compact disc. Since the MP3 encoding algorithm is disclosed, there are various encoders/decoders compliant with this standard, including freeware that is available for no charge. Thus, the MP3 standard is widely used in the computer field.

OpenMG

Copyright protection technology that securely manages music content from the EMD/Audio CD on a personal computer. Application software that is installed on the computer encrypts the digital music content when recording on the hard drive. This allows you to enjoy music content on the computer, but prevents unauthorized transmission of this content across a network (or elsewhere). This PC copyright protection allows you to transfer digital music content from a PC's hard drive to a compliant device.

SDMI

SDMI which stands for Secure Digital Music Initiative, is a forum that consists of over 130 companies in the fields of recorded audio content, computers, and consumer electronics, dedicated to developing an integrated method of copyright protection technology that can be used worldwide.

SDMI is working to create a framework for preventing improper usage of audio files and to promote legal music distribution services. The copyright protection technology OpenMG is based upon the SDMI standard.

Features of copyright protection by OpenMG

This product (NW-E3) features OpenMG, a copyright protection technology developed by Sony to protect music copyrights.

OpenMG uses a high-level cryptographic technology to protect music contents with computers. Users should be notified of the restrictions mentioned below.

1. This product can only be used with a computer on which the supplied OpenMG Jukebox software has been installed.
2. Music recorded on the hard disk using the OpenMG Jukebox software cannot be played if copied onto other computers.
3. Music contents Checked-Out from a computer cannot be played if copied onto other computers.
4. Music contents Checked-Out from a computer must be Checked-In to the same computer. You cannot Check-In to other computers.
5. Installation of the same OpenMG Jukebox software onto other computers is not permitted.

6. Usage Rules for using music

If a Usage Rule is included in the music by way of the copyright holder or the distributor, operation will be restricted to use permitted by the Usage Rule. For music, such as compact discs, that does not contain a Usage Rule, the Default Usage Rule of SDMI will be followed. This Default Usage Rule states that one file can be Checked-Out up to three times only.

7. On music contents that are not compatible with the OpenMG Jukebox software

Under the supervision of SDMI, this software prohibits recording of music with a copy prohibition signal.

8. Upgrading the supplied OpenMG Jukebox

This software was developed in accordance with the current arrangement between Sony and SDMI. If this arrangement is modified in the future, some of the software functions may become unavailable. Sony may offer an upgrade kit in this case at additional user expense.

Looking at the controls

Network Walkman

(front)

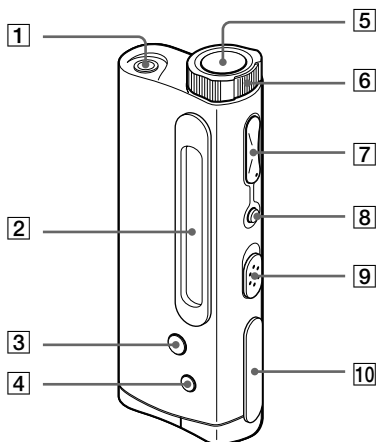

(rear)

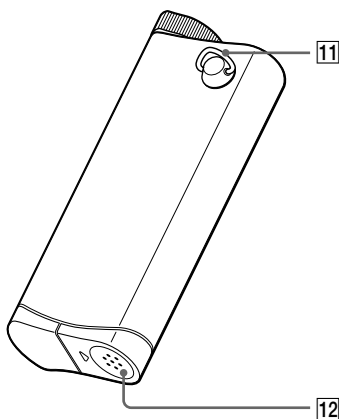

- 1 (Headphones) jack (page 15)
- 2 Display (page 17, 20)
- 3 PLAYMODE button (page 20)
- 4 DISPLAY button (page 20)
- 5 (play/stop) button (page 15)
- 6 Shuttle switch (page 16)
- 7 VOLUME+/- button (page 15)
- 8 MEGABASS/AVLS button (page 19)
- 9 HOLD switch (page 21)
- 10 Dedicated USB jack (page 12)
- 11 Strap hole for attaching the strap (page 34)
- 12 Battery compartment (page 9)

Display

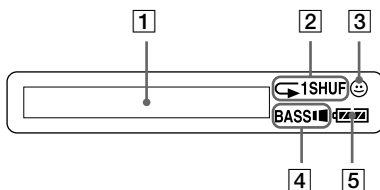

- 1 Text/graphic information display (page 17, 20)
- 2 Play mode indication (page 20)
- 3 AVLS indication (page 19)
- 4 MEGA BASS indication (page 19)
- 5 Battery remain indication (page 9)

To use the strap

The strap is not supplied.

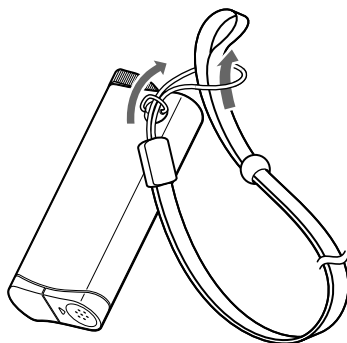

Index

A

album title 14, 22
ATRAC3 32
AVLS 19

B

Battery 9
MEGA BASS 19
beginning of the track 16
Bit rate 14, 32

C

CD (compact disc) 13
CD drive 13
CD Recorder 13
CD-ROM 10
Check-In 5, 18, 32
Check-Out 5, 14, 32
computer 4, 10, 12
copyright protection technology
5, 33

D

display 17, 20
DISPLAY button 20
display mode 20
download 4, 11
driver (USB) 12

E

EMD services 11

F

Features 33

G

go backward 16
go forward 16

H

hard drive 4, 12, 18
headphones 8, 15
 extension cord 8, 15
help file 7
HOLD 15, 21
Hold switch 15, 21

I

install 10
Internet (EMD services) 11

L

listen to music 15

M

MP3 32

O

online help 7
OpenMG 4, 32
OpenMG Jukebox software
4, 10, 13, 22
 OpenMG CD Recorder 13
optimizing the CD drive
13

P

playback 15
playback mode 20
Portable Player window
23
previous tracks 16

Q

quit (software) 22

Index (continued)

R

record	13
repeat	20

S

SDMI	5, 32
Shuttle switch	16
song title	14, 22
start (software)	13
succeeding tracks	16
supplied accessories	8

T

transferring	12, 18
to your computer	18
to Network Walkman	12
troubleshooting	28

U

uninstalling	26
upgrading	33
Usage Rule	33
USB cable	8, 12, 28
USB driver	12

V

volume	15
--------	----

W

WAV format	4
window	22