



***Digital
Percussion***
DD-35

Lighting Pads

 **Hand Percussion Mode**



100 SONGS

Owner's Manual

SPECIAL MESSAGE SECTION

This product utilizes batteries or an external power supply (adapter). DO NOT connect this product to any power supply or adapter other than one described in the manual, on the name plate, or specifically recommended by Yamaha.

This product should be used only with the components supplied or; a cart, rack, or stand that is recommended by Yamaha. If a cart, etc., is used, please observe all safety markings and instructions that accompany the accessory product.

SPECIFICATIONS SUBJECT TO CHANGE:

The information contained in this manual is believed to be correct at the time of printing. However, Yamaha reserves the right to change or modify any of the specifications without notice or obligation to update existing units.

This product, either alone or in combination with an amplifier and headphones or speaker/s, may be capable of producing sound levels that could cause permanent hearing loss. DO NOT operate for long periods of time at a high volume level or at a level that is uncomfortable. If you experience any hearing loss or ringing in the ears, you should consult an audiologist.

IMPORTANT: The louder the sound, the shorter the time period before damage occurs.

NOTICE:

Service charges incurred due to a lack of knowledge relating to how a function or effect works (when the unit is operating as designed) are not covered by the manufacturer's warranty, and are therefore the owners responsibility. Please study this manual carefully and consult your dealer before requesting service.

ENVIRONMENTAL ISSUES:

Yamaha strives to produce products that are both user safe and environmentally friendly. We sincerely believe that our products and the production methods used to produce them, meet these goals. In keeping with both the letter and the spirit of the law, we want you to be aware of the following:

Battery Notice:

This product MAY contain a small non-rechargeable battery which (if applicable) is soldered in place. The average life span of this type of bat-

tery is approximately five years. When replacement becomes necessary, contact a qualified service representative to perform the replacement.

This product may also use "household" type batteries. Some of these may be rechargeable. Make sure that the battery being charged is a rechargeable type and that the charger is intended for the battery being charged.

When installing batteries, do not mix batteries with new, or with batteries of a different type. Batteries MUST be installed correctly. Mismatches or incorrect installation may result in overheating and battery case rupture.

Warning:

Do not attempt to disassemble, or incinerate any battery. Keep all batteries away from children. Dispose of used batteries promptly and as regulated by the laws in your area. Note: Check with any retailer of household type batteries in your area for battery disposal information.

Disposal Notice:

Should this product become damaged beyond repair, or for some reason its useful life is considered to be at an end, please observe all local, state, and federal regulations that relate to the disposal of products that contain lead, batteries, plastics, etc. If your dealer is unable to assist you, please contact Yamaha directly.

NAME PLATE LOCATION:

The name plate is located on the bottom of the product. The model number, serial number, power requirements, etc., are located on this plate. You should record the model number, serial number, and the date of purchase in the spaces provided below and retain this manual as a permanent record of your purchase.

Model

Serial No.

Purchase Date

92-BP (bottom)

PLEASE KEEP THIS MANUAL

FCC INFORMATION (U.S.A.)

1. IMPORTANT NOTICE: DO NOT MODIFY THIS UNIT!

This product, when installed as indicated in the instructions contained in this manual, meets FCC requirements. Modifications not expressly approved by Yamaha may void your authority, granted by the FCC, to use the product.

2. IMPORTANT: When connecting this product to accessories and/or another product use only high quality shielded cables. Cable/s supplied with this product MUST be used. Follow all installation instructions. Failure to follow instructions could void your FCC authorization to use this product in the USA.

3. NOTE: This product has been tested and found to comply with the requirements listed in FCC Regulations, Part 15 for Class "B" digital devices. Compliance with these requirements provides a reasonable level of assurance that your use of this product in a residential environment will not result in harmful interference with other electronic devices. This equipment generates/uses radio frequencies and, if not installed and used according to the instructions found in the users manual, may cause interference harmful to the operation of other electronic devices. Compliance with FCC regulations does not guar-

antee that interference will not occur in all installations. If this product is found to be the source of interference, which can be determined by turning the unit "OFF" and "ON", please try to eliminate the problem by using one of the following measures:

Relocate either this product or the device that is being affected by the interference.

Utilize power outlets that are on different branch (circuit breaker or fuse) circuits or install AC line filter/s.

In the case of radio or TV interference, relocate/reorient the antenna. If the antenna lead-in is 300 ohm ribbon lead, change the lead-in to co-axial type cable.

If these corrective measures do not produce satisfactory results, please contact the local retailer authorized to distribute this type of product. If you can not locate the appropriate retailer, please contact Yamaha Corporation of America, Electronic Service Division, 6600 Orangethorpe Ave, Buena Park, CA90620

The above statements apply ONLY to those products distributed by Yamaha Corporation of America or its subsidiaries.

* This applies only to products distributed by YAMAHA CORPORATION OF AMERICA.

(class B)

OBSERVERA!

Apparaten kopplas inte ur växelströmskällan (nätet) så länge som den är ansluten till vägguttaget, även om själva apparaten har stängts av.

ADVARSSEL: Netspændingen til dette apparat er IKKE afbrudt, så længe netledningen sidder i en stikkontakt, som er t endt — også selvom der er slukket på apparatets afbryder.

VAROITUS: Laitteen toisiopiiriin kytketty käyttökytin ei irroita koko laitetta verkosta.

(standby)

Entsorgung leerer Batterien (nur innerhalb Deutschlands)

Leisten Sie einen Beitrag zum Umweltschutz. Verbrauchte Batterien oder Akkumulatoren dürfen nicht in den Hausmüll. Sie können bei einer Sammelstelle für Altbatterien bzw. Sondermüll abgegeben werden. Informieren Sie sich bei Ihrer Kommune.

(battery)

PRECAUTIONS

PLEASE READ CAREFULLY BEFORE PROCEEDING

* Please keep these precautions in a safe place for future reference.



WARNING

Always follow the basic precautions listed below to avoid the possibility of serious injury or even death from electrical shock, short-circuiting, damages, fire or other hazards. These precautions include, but are not limited to, the following:

- Do not open the instrument or attempt to disassemble the internal parts or modify them in any way. The instrument contains no user-serviceable parts. If it should appear to be malfunctioning, discontinue use immediately and have it inspected by qualified Yamaha service personnel.
- Do not expose the instrument to rain, use it near water or in damp or wet conditions, or place containers on it containing liquids which might spill into any openings.
- If the AC adaptor cord or plug becomes frayed or damaged, or if there is a sudden loss of sound during use of the instrument, or if any unusual smells or smoke should appear to be caused by it, immediately turn off the power switch, disconnect the adaptor plug from the outlet, and have the instrument inspected by qualified Yamaha service personnel.
- Use the specified adaptor (PA-3B or an equivalent recommended by Yamaha) only. Using the wrong adaptor can result in damage to the instrument or overheating.
- Before cleaning the instrument, always remove the electric plug from the outlet. Never insert or remove an electric plug with wet hands.
- Check the electric plug periodically and remove any dirt or dust which may have accumulated on it.



CAUTION

Always follow the basic precautions listed below to avoid the possibility of physical injury to you or others, or damage to the instrument or other property. These precautions include, but are not limited to, the following:

- Do not place the AC adaptor cord near heat sources such as heaters or radiators, and do not excessively bend or otherwise damage the cord, place heavy objects on it, or place it in a position where anyone could walk on, trip over, or roll anything over it.
 - When removing the electric plug from the instrument or an outlet, always hold the plug itself and not the cord.
 - Do not connect the instrument to an electrical outlet using a multiple-connector. Doing so can result in lower sound quality, or possibly cause overheating in the outlet.
 - Unplug the AC power adaptor when not using the instrument, or during electrical storms.
 - Always make sure all batteries are inserted in conformity with the +/- polarity markings. Failure to do so might result in overheating, fire, or battery fluid leakage.
 - Always replace all batteries at the same time. Do not use new batteries together with old ones. Also, do not mix battery types, such as alkaline batteries with manganese batteries, or batteries from different makers, or different types of batteries from the same maker, since this can cause overheating, fire, or battery fluid leakage.
 - Do not dispose of batteries in fire.
 - Do not attempt to recharge batteries that are not intended to be charged.
 - When the batteries run out, or if the instrument is not to be used for a long time, remove the batteries from the instrument to prevent possible leakage of the battery fluid.
 - Keep batteries away from children.
 - If the batteries do leak, avoid contact with the leaked fluid. If the battery fluid should come in contact with your eyes, mouth, or skin, wash immediately with water and consult a doctor. Battery fluid is corrosive and may possibly cause loss of sight or chemical burns.
 - Before connecting the instrument to other electronic components, turn off the power for all components. Before turning the power on or off for all components, set all volume levels to minimum. Also, be sure to set the volumes of all components at their minimum levels and gradually raise the volume controls while playing the instrument to set the desired listening level.
 - Do not expose the instrument to excessive dust or vibrations, or extreme cold or heat (such as in direct sunlight, near a heater, or in a car during the day) to prevent the possibility of panel disfiguration or damage to the internal components.
 - Do not use the instrument near other electrical products such as televisions, radios, or speakers, since this might cause interference which can affect proper operation of the other products.
 - Do not place the instrument in an unstable position where it might accidentally fall over.
 - Before moving the instrument, remove all connected adaptor and other cables.
 - When cleaning the instrument, use a soft, dry cloth. Do not use paint thinners, solvents, cleaning fluids, or chemical-impregnated wiping cloths. Also, do not place vinyl, plastic or rubber objects on the instrument, since this might discolor the panel or keyboard.
 - Do not rest your weight on, or place heavy objects on the instrument, and do not use excessive force on the buttons, switches or connectors.
 - Do not operate the instrument for a long period of time at a high or uncomfortable volume level, since this can cause permanent hearing loss. If you experience any hearing loss or ringing in the ears, consult a physician.
- Yamaha cannot be held responsible for damage caused by improper use or modifications to the instrument, or data that is lost or destroyed.
- Always turn the power off when the instrument is not in use.
Make sure to discard used batteries according to local regulations.
- * The illustrations and LED displays as shown in this owner's manual are for instructional purposes only, and may be different from the ones on your instrument.

Congratulations!

Thank you for purchasing the Yamaha DD-35. The DD-35 has been developed to respond and play like a drum set — but with greater ease, flexibility and sophisticated functions. Before you use the instrument, we recommend that you carefully read through this manual.

Contents

Setting Up	5	Playing the Game	15
Power Requirements.....	5	Selecting and Playing a Game Song	15
Front Panel	6		
Playing the Demo Song	8		
Play the Pads	9	Appendix	16
Pad Names.....	9	Troubleshooting	16
Hand Percussion ON/OFF	10	Drum Voice List.....	17
Assigning a Drum Kit to the Pads.....	10	Song List	19
Assigning a Voice to Individual Pads (“C” Custom Kit).....	11	Drum Kit List.....	20
		Specifications	22
Playing a Song	12		
Selecting a Song	12		
Tap Start.....	13		
Adjusting the Tempo	13		
Pad Light ON/OFF.....	14		

● Supplied Accesories

- Drum Stick (x2)
- Owner’s Manual

This section contains information about setting up your DD-35 for playing. Make sure to read this section carefully before using the instrument.

Power Requirements

Although the DD-35 will run either from an optional AC adaptor or batteries, Yamaha recommends use of an AC adaptor whenever possible. An AC adaptor is more environmentally friendly than batteries and does not deplete resources.

Using an AC Power Adaptor

- ① Make sure that the [STANDBY/ON] switch of the DD-35 is set to STANDBY.
- ② Connect the AC adaptor (PA-3B or other adaptor specifically recommended by Yamaha) to the power supply jack.
- ③ Plug the AC adaptor into an AC outlet.

⚠ WARNING

- Use **ONLY** a Yamaha PA-3B AC Power Adaptor (or other adaptor specifically recommended by Yamaha) to power your instrument from the AC mains. The use of other adaptors may result in irreparable damage to both the adaptor and the DD-35.
- Unplug the AC Power Adaptor when not using the DD-35, or during electrical storms.

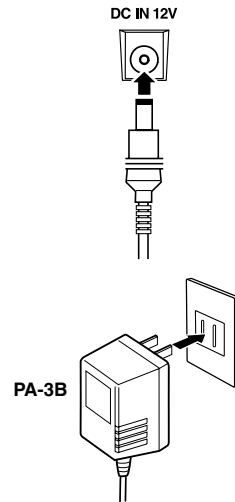

Using Batteries

For battery operation the DD-35 requires six 1.5V “AA” size, R6P (LR6) or equivalent batteries. (Alkaline batteries are recommended.) When the batteries need to be replaced, the volume may be reduced, the sound may be distorted, and other problems may occur. When this happens, turn the power off and replace the batteries, as described below.

- ① Open the battery compartment cover located on the instrument’s bottom panel.
- ② Insert the six new batteries, being careful to follow the polarity markings on the inside of the compartment.
- ③ Replace the compartment cover, making sure that it locks firmly in place.

⚠ CAUTION

- When the batteries run down, replace them with a complete set of six new batteries. NEVER mix old and new batteries.
- Do not use different kinds of batteries (e.g. alkaline and manganese) at the same time.
- If the instrument is not to be in use for a long time, remove the batteries from it, in order to prevent possible fluid leakage from the battery.
- Plugging or unplugging the AC power adaptor while the batteries are installed will reset the DD-35 to the defaults.

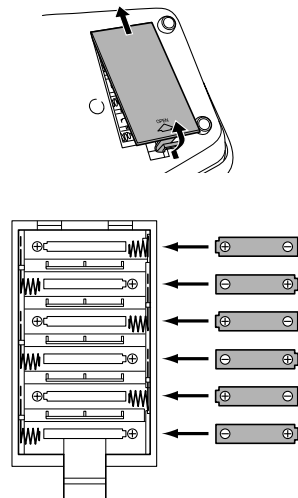

Front Panel

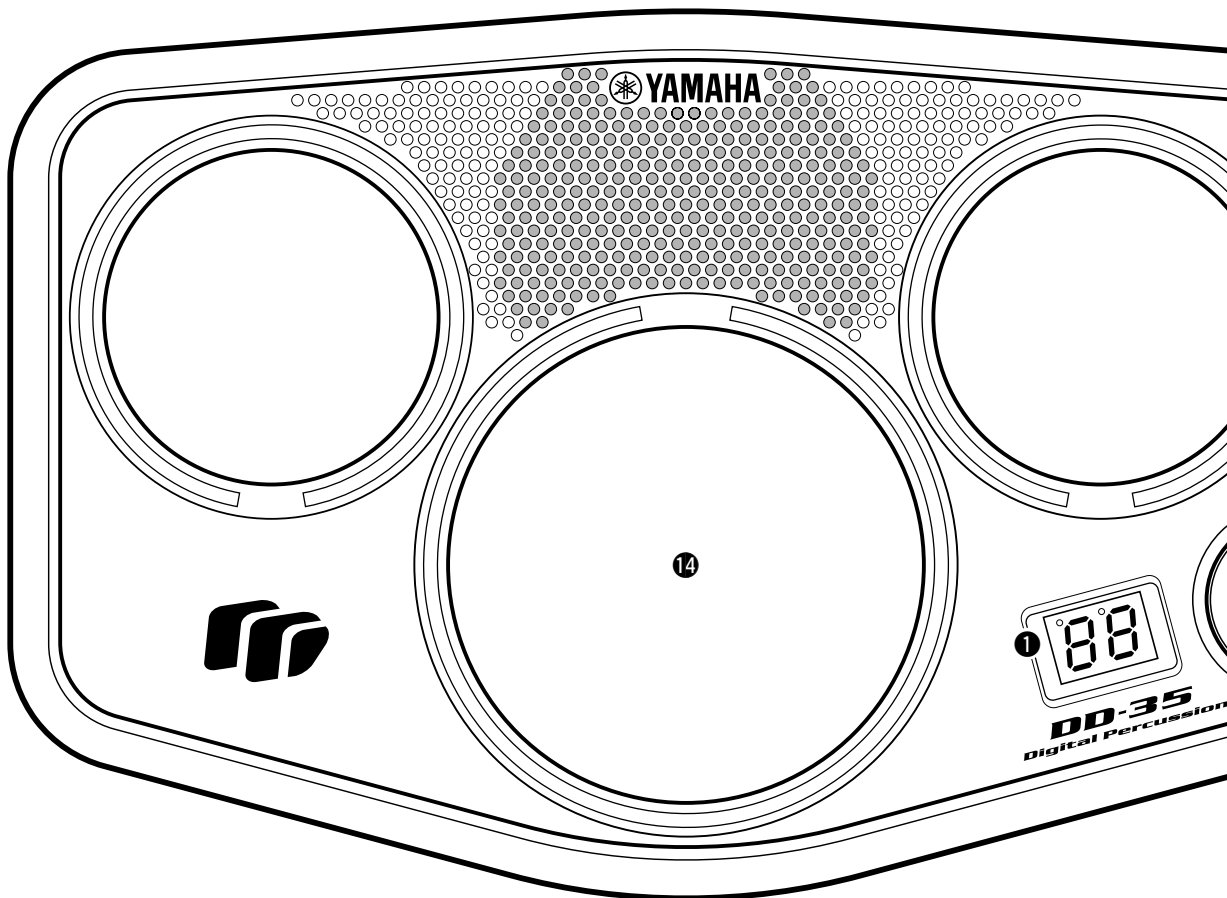

Front Panel

❶ DISPLAY	10
❷ DIAL	8
❸ PAD button	11
❹ KIT button	10
❺ SONG button.....	12, 14, 15
❻ TEMPO/TAP button.....	13, 14
❼ DRUM GAME button.....	15
❽ LIGHT ON/OFF button.....	14
❾ HAND PERC button	10
❿ START/STOP button	8, 12, 13, 15
⓫ DEMO button	8
⓬ VOLUME [▲], [▼] buttons	8
⓭ STANDBY/ON Switch	8
⓮ Drum Pads (x4)	9

Side Panel (Right)

⓯ PHONES/OUTPUT Jack.....	7
⓰ DC IN 12V (AC Adaptor) Jack	5

Side Panel (Right)

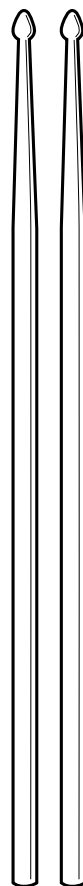
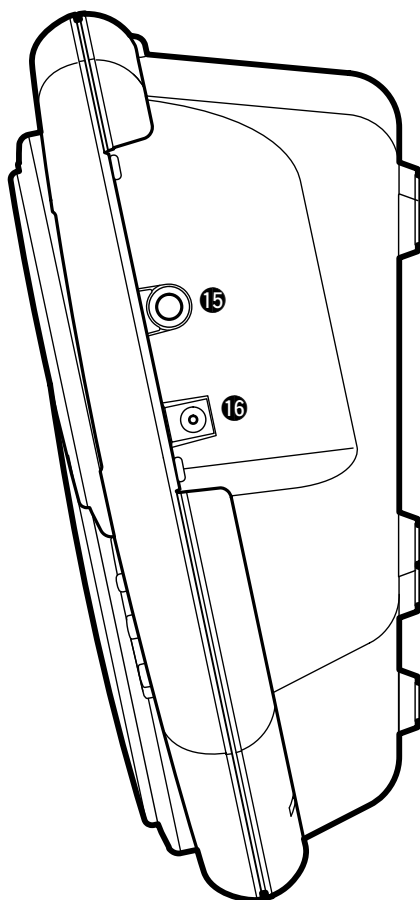
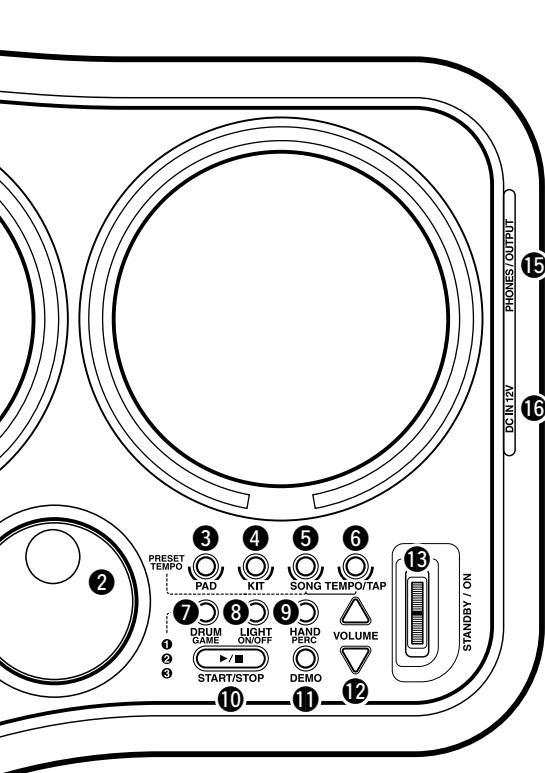

Using a pair of headphones

A standard pair of stereo headphones can be plugged in here for private practice or late-night playing. The internal speaker system is automatically shut off when a pair of headphones is plugged into the PHONES/OUTPUT jack.

Do not listen with the headphones at high volume for long periods of time. Doing so may cause hearing loss.



CAUTION

- Connect the DD-35 to external equipment only after turning off power for all devices. To prevent damage to the speakers, set the volume of the external devices at the minimum setting before connecting them. Failure to observe these cautions may result in electric shock or equipment damage.

CAUTION

- Use the sticks with caution. Do not use them for anything other than playing the instrument. Also, to avoid damage or injury, refrain from waving them recklessly or throwing them.

Playing the Demo Song

The DD-35 features a demonstration song, specially created to show you the dynamic possibilities of the instrument.

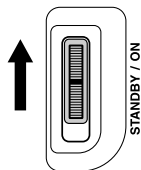

1 Turn on the power.

Turn the [STANDBY/ON] switch ON.

CAUTION

- Even when the switch is in the "STANDBY" position, electricity is still flowing to the instrument at the minimum level. When you are not using the DD-35 for a long time, make sure you unplug the AC power adaptor from the wall AC outlet, and/or remove the batteries from the instrument.

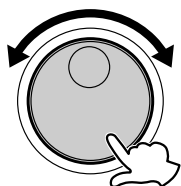
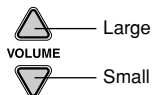

2 Start the Demo Song.

Press the [DEMO] button and the demo song starts playing.

● MASTER VOLUME

The overall volume level of the DD-35 is controlled by two **VOLUME** [▲], [▼] buttons (9 volume levels L1 - L9).

Press the **VOLUME** [▲] button to increase the overall volume by one level. Press the **VOLUME** [▼] button to decrease the overall volume by one level. Holding down either of the buttons increases or decreases the volume level rapidly.

The **DIAL** can also be used to adjust the volume.

L 1	← L 5 →	L 9
Small	← Volume Level →	Large

3 Stop the Demo Song.

To stop playback, press the [DEMO] button again or press the [START/STOP] button.

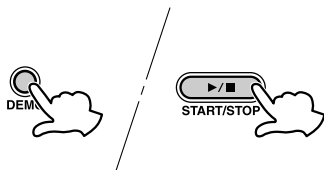

Play the Pads

Strike the pad with the supplied drum sticks or your hand to play the drum voices. When playing the pads with your hand, turn the Hand Percussion feature on by pressing the [HAND PERC] button (“ON” is indicated). The volume of the pads’ sounds responds to your playing; when you play soft the volume is soft, and when you play strongly the volume is loud. The actual loudness of the sound may vary according to which part of the pad is struck.

Pad Names

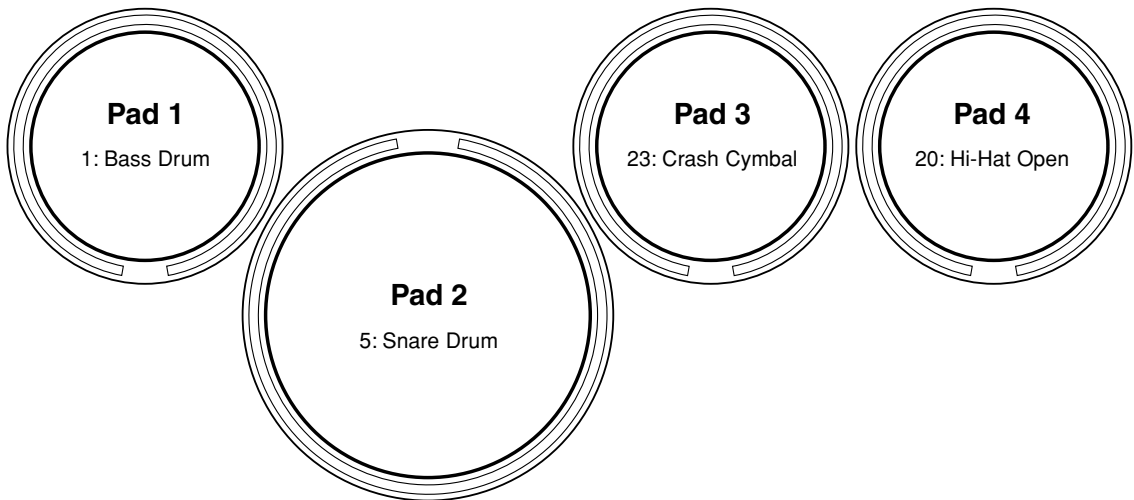

Ex. shown, Drum Kit 09



- If you hit a pad too strongly, the adjacent pad(s) may inadvertently sound as well.

Hand Percussion ON/OFF

You can play the pads of the DD-35 either with the supplied sticks or with your hands.

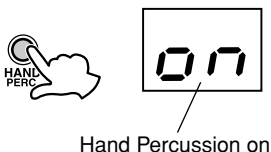

1 Press the [HAND PERC] button.

When you press the [HAND PERC] button, “ON” appears in the display, and the pad sensitivity is automatically adjusted for optimum playing by hand.



- When Hand Percussion is on, a special set of sounds ideal for playing by hand are automatically assigned to the pads (see the “Drum Voice List” page 17).
- While “ON” or “OFF” is indicated in the display, the dial can also be used to turn Hand Percussion on or off.

CAUTION

- When Hand Percussion is on, do not strike the pads with drumsticks or anything other than your hands.

Assigning a Drum Kit to the Pads

The DD-35 allows you to choose from 100 different Drum Kits (00 - 99 : see the “Drum Kit List” page 20) quickly and easily. 100 of the kits have preset voice combinations that will be set to the pads when the kit is selected.

Select some different kits and try playing them.

The DD-35 also has one Custom Drum Kit allowing you to assign the desired voices to the four pads (see “Assigning a Voice to Individual Pads” page 11).



1 Press the [KIT] button.

Pressing the [KIT] button, the currently selected Drum Kit number appears in the display.

2 Select a Drum Kit Number.

Turn the DIAL to select a Drum Kit number. Drum Kit numbers will increase as the DIAL is turned to the right (clockwise), and decrease as the DIAL is turned to the left (counter-clockwise).



- Drum Kit number 09 is normally selected when the power is turned on.
- The “CU” Drum Kit is the Custom Kit. Changes made to any one of the preset drum kits will be saved here (see “Assigning a Voice to Individual Pads” page 11).
- When a song is selected, a suitable kit is automatically assigned for optimum playing with the selected song.
- For some drum kits (90 - 99), the sound changes each time you strike the pad.

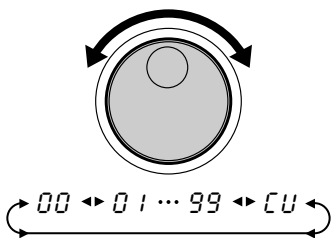

Assigning a Voice to Individual Pads (“CU” Custom Kit)

The DD-35 contains a total of 148 high quality drum sounds (see the “Drum Voice List” page 17) — and you can assign these freely to each of the four drum pads. Try assigning some different voices and create your own “CU” Custom Drum Kit.



- Any changes made to one of the preset drum kits will automatically be saved in the “CU” Custom Drum Kit.
- Any data assigned to the custom kit will be replaced by factory default values (“00”) when the power is turned off.
- Both the Custom and “00” drum kit contents are the same until modified (see the “Drum Kit List” page 20).

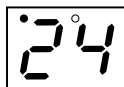

1 Press and hold the [PAD] button.

Press and hold the [PAD] button, and the latest assigned voice number is shown in the display.

Voice number	Display	Comment
24	24	—
124	24	Values of 100 and over are indicated by a single dot.

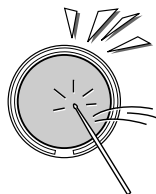

2 Enable a pad for voice selection by simultaneously holding the [PAD] button and striking the appropriate pad.

The currently assigned voice number for the pad is shown in the display.

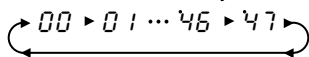
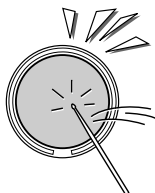

3 Select a Voice Number.

You can select the voice by repeatedly striking the pad, (while listening to the voice) or by turning the **DIAL**.

● Striking the pad to select a voice.

While holding down the [PAD] button, strike the desired pad repeatedly, to increment through the voice numbers one-by-one.

● Using the DIAL to select a voice.

Simultaneously hold down the [PAD] button and turn the **DIAL** clockwise to continuously step up through the voice numbers, and turn the **DIAL** counter-clockwise to step down through the voice numbers.

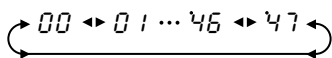
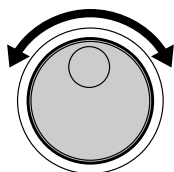

Repeat the previous steps 2 and 3 for any or all of the DD-35’s pads.



4 Play the Pads.

After you’ve assigned a voice to the desired pad, and you release the [PAD] button, the DD-35 automatically saves your edits to the custom kit. You can now play the sounds you have assigned to the pads.

Playing a Song

The DD-35 features 100 different songs that can be used to provide accompaniment (see the “Song List” page 19). Select one of the songs and have a listen.

The DD-35 also has special lesson songs (5 - 59 and 65 - 94), which feature the model playing of a teacher. By trying to match the teacher’s performance, you can master the various rhythm patterns. You can also use the Game function with these songs. (See “Playing the Game” on page 15.)

Song numbers 60 - 64 are for playing a single, entire song. Song numbers 95 - 99 are specifically for use with the Game function.



• The DD-35 has a total simultaneous polyphony of 16 notes.

Selecting a Song

1 Press the [SONG] button.



Press the [SONG] button, the currently selected song number will appear in the display.

2 Select a song number.

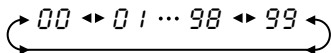
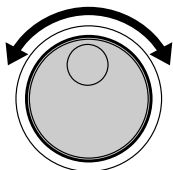

Song numbers will increase in value as the **DIAL** is turned to the right (clockwise) and decrease as the **DIAL** is turned to the left (counter-clockwise). (See the “Song List” page 19.)



- Song number “00” is automatically selected whenever the power is turned on.
- Selecting a song will also automatically select the best suited Drum Kit for that song.
- The relative difficulty or playing level of each song is indicated in the “Song List” on page 19.

3 Press the [START/STOP] button.



Press the [START/STOP] button, the song will start playback. To stop playback of the song, press the [START/STOP] button once again.



- You can also use the TAP START function to start songs (see page 13).

Tap Start

The Tap Start function allows you to set the song's overall tempo as well as start the accompaniment — simply by tapping out the rhythm.

The accompaniment will playback at the tempo with which the pads are struck.



1 Press the [TEMPO/TAP] button.

While song playback is stopped, press the [TEMPO/TAP] button. The DD-35 is set to Tap Start standby.

To cancel the Tap Start mode, simply press the [TEMPO/TAP] button once again.

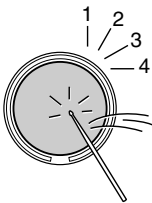

2 Play the Tap Start.

In the case of a song in 4/4, strike any pad four times, and the accompaniment will start at the desired tempo.



- The number of times needed to strike the pad will change according to the following time signatures; 5/4, 5 times; 4/4, 4 times; 3/4, 3 times; 6/8, 2 times.



3 Stop the Song Playback.

Press the [START/STOP] button and the song accompaniment will stop.

Adjusting the Tempo

The song tempo can be set anywhere from 40 to 240 beats per minute. The higher the tempo value, the faster the tempo.

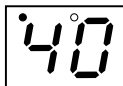

1 Press the [TEMPO/TAP] button.

When you press the [TEMPO/TAP] button, the current tempo value (40 - 240) appears in the display.

Tempo	Display	Comment
90	90	—
140	·40	Values of 100 and over are indicated by a single dot.
240	·40	Values of 200 and over are indicated by two dots.

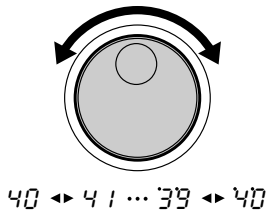

2 Set the Tempo.

Use the **DIAL** to select the TEMPO. Turn the **DIAL** to the right (clockwise) to increase the Tempo value, and turn it to the left (counter-clockwise) to decrease the value. (The Tempo range is 40 - 240.) To exit from the Tempo setting mode, press the **[SONG]** button, or wait a second for the DD-35 to exit automatically.



- When both the **[SONG]** and **[TEMPO/TAP]** buttons are pressed simultaneously, the pre-set tempo of the currently selected song is automatically applied.

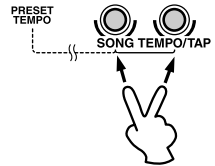

● About the Beat Indicator

During song playback, the two beat lamps in the display will flash in a specific pattern to help you in keeping the beat.

For a song in 4/4 time, at a tempo of 80 bpm

Display	Comment
	1st beat of each measure
	2nd, 3rd, 4th beat

Pad Light ON/OFF

When the Pad Light function is on, pads that sound during song playback light up. The pads also light when they are struck.

Pad Light is also used with the Game function. When playing a Game Song, the pads light along with the rhythm, indicating which pads are to be played.



1 Press the **[LIGHT ON/OFF]** button.

When you press the **[LIGHT ON/OFF]** button, the current setting ("ON" or "OFF") appears in the display. Press the **[LIGHT ON/OFF]** button, repeatedly if necessary, until the desired setting is shown.



- You can also determine the setting by using the dial while "ON" or "OFF" is indicated on the display.
- When the Game function is used, Pad Light is automatically set to "ON."

2 Try striking the pads.

The played pad lights up.

⚠ CAUTION

- **Playing while looking at the lights for a long period of time may cause eye strain and stiff neck/shoulders. For your health and comfort, we recommend that you take a ten-minute break for every hour.**



Playing the Game

The DD-35 features a variety of songs specifically designed to be played with the fun and educational Game function. Select one of these special songs (05 - 99) and play one of the three game types along with them — and see how well you can keep rhythm with the song.

Game ①.....In this game type, you don't need to worry about hitting the right pad — any pad will do. Just try to play the pad in time with the rhythm and the flashing lights.

Game ②.....In this game type — a step up from Game 1 — you'll need to play the specific pads in rhythm as they light. If your timing is off or you hit the wrong pad, the pad will not sound.

Game ③.....In this game type (a step up from Game 2) you can play along with the song as you like here — everything sounds just as you play it. However, if you miss a beat or hit the wrong pad, the evaluation function will let you know!

* The DD-35 features a variety of lesson songs (5 - 59 and 65 - 94), specially designed for learning and practicing purposes. You'll hear the DD-35 announce "Ready!" and the teacher's model performance will play back. When the DD-35 announces "Go," play the rhythm yourself. This is an exceptionally easy and fun way to master the drums.

Song numbers 60 - 64 are for playing a single, complete song. This is an excellent way to develop your timing and work on your ability to keep the rhythm for the length of an entire song. The pads light to guide you through the song — try to hit each pad as it lights, and master the rhythm.

The DD-35 also features special game songs (95 - 99). These arcade game-like songs challenge you to hit the pads as soon as they light — without providing a rhythmic guide for you to follow. Try them out and see how fast your response is.

DD-35 has a built-in evaluation function that monitors your playing, and just like a real teacher, it tells you how well you performed in each game.

Selecting and Playing a Game Song

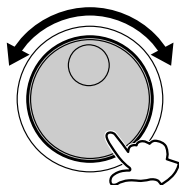

1 Press the [SONG] button, then use the dial to select the desired demo song for game function.

Select from song numbers 05 - 99.

2 Press the [DRUM GAME] button to select the type of game and start the game.

Press the [DRUM GAME] button repeatedly to select the desired game type: 1, 2, 3, or off ("OFF"). (The DD-35 announces this step.) To play back the song normally, select "OFF".

When [DRUM GAME] is pressed, the Game is automatically started.

3 Press the [START/STOP] button to stop the game.

The DD-35 evaluates your playing and tells you the grade when game is finished.

"OK", "Good", "Very Good", "Excellent"

Troubleshooting

In many cases, problems or malfunctions that occur during use can be remedied easily.

Please check the following list before deciding that your DD-35 is damaged.

If the suggested remedy is ineffective, take the DD-35 to an authorized Yamaha dealer for proper diagnosis and repair. Do not attempt to repair this digital instrument by yourself as serious damage may occur.

Problem	Cause/Solution
A buzz or click occurs momentarily when the DD-35 is turned ON or OFF	This is a normal power surge noise that occurs when the POWER switch is operated
The LED display is completely dark. When the pads are struck, the display is dark and returns to "00".	The batteries are low and should be replaced with a complete set of six new batteries immediately. Ideally, an optional AC adaptor PA-3B should be used to power the DD-35 (see page 5).
The custom pad voice assignments have disappeared or defaulted.	
No sound comes from the speakers.	<ul style="list-style-type: none"> • The volume is set too low. Adjust the volume (see page 8). • A plug is inserted into the PHONES/OUTPUT jack and should be taken out (see page 7).
The selected voice does not sound when the pad is struck.	The desired voice has not been assigned to the pad. Use the PAD ASSIGN function to program the desired voice to the appropriate pad (see page 11).
The drum pads suddenly light.	If you are not touching or playing the DD-35, the pads will light automatically.

Drum Voice List.....

● Panel Voice List

Voice No.	Voice Name
0	Bass Drum + Crash Cymbal
1	Bass Drum
2	Bass Drum Soft
3	Bass Drum Hard
4	Elec. Bass Drum
5	Snare Drum
6	Snare Drum Soft
7	Snare Drum Hard
8	Elec. Snare Drum
9	Sticks
10	Rim Shot
11	High Tom
12	Mid Tom
13	Low Tom
14	Floor Tom
15	Elec. High Tom
16	Elec. Mid Tom
17	Elec. Low Tom
18	Elec. Floor Tom
19	Hi-Hat Close
20	Hi-Hat Open
21	Elec. Hi-Hat Close
22	Elec. Hi-Hat Open
23	Crash Cymbal
24	Elec. Cymbal
25	Ride Cymbal
26	Hand Clap
27	Chinese Cymbal
28	Tambourine
29	Cowbell
30	Conga H Mute
31	Conga H Open
32	Conga Muff
33	Conga L Open
34	Bongo H
35	Bongo L
36	Timbale H
37	Timbale L
38	Samba Whistle H
39	Samba Whistle L
40	Agogo H

Voice No.	Voice Name
41	Agogo L
42	Cuica Mute
43	Cuica Open
44	Surdo Close
45	Surdo Open
46	Cabasa
47	Shaker
48	Maracas
49	Guiro Long
50	Guiro Short
51	Claves
52	Castanet
53	Wood Block H
54	Wood Block L
55	Triangle Mute
56	Triangle Open
57	Vibraslap
58	Bell Tree
59	Tamborim Solto
60	Tamborim Ponta
61	Tamborim Nylon Volta
62	Timpani H
63	Timpani L
64	One
65	Two
66	Three
67	Four
68	Applause
69	Explosion
70	FX
71	Omen-FX
72	FMTB2
73	FMTB1
74	Signal
75	Reverse
76	BLJ Trill
77	Sharp Hit
78	Scratch
79	Tweet
80	Ping Pong
81	OK

Voice No.	Voice Name
82	Good
83	Very Good
84	Excellent
85	Uhh + Hit
86	Uhh
87	Yo-Kurt
88	Ooh
89	Huea
90	Hihfh
91	Come On
92	GetUp!
93	Gallop 1
94	Gallop 2
95	Gallop 3
96	Horse
97	Goat
98	Cow
99	Dog
100	Cat
101	Rooster
102	Chick
103	Duck
104	Big Trash Can
105	Mid Trash Can
106	Small Trash Can
107	Lid Trash Can
108	China Small Gong
109	Tee Off
110	Falling Ball
111	Ball In Hole
112	Ball In Water
113	Cork
114	Glass
115	Apple
116	Foot Step
117	Door Squeak
118	Clown Horn
119	Rubber Duck
120	Spring
121	Buzzer
122	Laughing Man
123	Laughing Girl
124	Screaming
125	Oops
126	Kiss 1
127	Kiss 2

Voice No.	Phrase Name
128	Drum Fill 1
129	Drum Fill 2
130	Hard Drum
131	Hard Drum Fill
132	Conga Play
133	Timbales Play
134	Vinyl Groove
135	Electro Fill
136	Scratch Play
137	Yo! Yo! Yo! Yo!
138	Applause(Fade In)
139	Comedy
140	Gallop(Fade Out)
141	Gallop(Fade In)
142	Hole In One
143	Water In One
144	Blast
145	Haunted House
146	Missed Shot
147	Celebration

Song List

Song No.	Song Name	Difficulty
Demo		
0	Funk Rock	Demo
1	Hard Rock	
2	Sound Effects	
3	Salsa	
4	DJ	
Pattern		
5	8 Beat Pop	Easy
6	Rock	Normal
7	Twist	
8	Love Song	
9	Hard Rock	Difficult
10	Funk Rock	
11	Thrash Metal	
12	Contemporary R & B	
13	16 Beat	Normal
14	16 Beat Pop	Difficult
15	Blues Rock	Easy
16	Oldies	
17	6/8 Jazzy	Normal
18	Shuffle	
19	Funk	Difficult
20	Motor Town	Easy
21	R & B	Normal
22	Bossa Nova	Easy
23	Samba	Normal
24	Acid Jazz	Difficult
25	Break Beats	
26	Hip Hop	
27	Dance Mix	
28	Big Band	Normal
29	March	
Fill in		
30	8 Beat	Easy
31	Groove Rock	Normal
32	Pops	

Song No.	Song Name	Difficulty
33	Hard Rock 1	Difficult
34	Hard Rock 2	
35	Mellow Funk	Easy
36	Fusion	Normal
37	16 Beat Funky	
38	Love Ballad	
39	Blues Shuffle	
Latin		
40	Son	Normal
41	Mambo	
42	Rumba Guaguanco	Difficult
43	Cha Cha Cha	Normal
44	Bolero	
45	6/8 African	Difficult
46	Songo	Normal
47	Mozambique	Difficult
48	Afro Cuban	Normal
49	Samba Batucada	Easy
50	Samba De Partido Alto	Normal
51	Bossa Nova	
52	Baion	Easy
53	Calypso	
54	Lambada	
55	Merengue	Difficult
56	Zouk	
57	Reggae	Easy
58	African Pops	Difficult
59	JUJU	
Song		
60	Rock & Roll	Difficult
61	Hard Rock	
62	Dance Pop	
63	Salsa	
64	Big Band Swing	Song Effect
65	SFX 1	

Song No.	Song Name	Difficulty
66	SFX 2	Easy
67	SFX 3	
68	SFX 4	
69	SFX 5	
70	SFX 6	Normal
71	SFX 7	
72	SFX 8	Easy
73	SFX 9	Difficult
74	SFX 10	Normal
75	SFX 11	Difficult
76	SFX 12	Easy
77	SFX 13	Normal
78	SFX 14	
79	SFX 15	Easy
80	SFX 16	Difficult
81	SFX 17	Easy
82	SFX 18	Normal
83	SFX 19	Difficult
84	SFX 20	
DJ		
85	DJ 1	Easy
86	DJ 2	Normal
87	DJ 3	Easy
88	DJ 4	
89	DJ 5	Normal
90	DJ 6	
91	DJ 7	Difficult
92	DJ 8	Easy
93	DJ 9	Difficult
94	DJ 10	
Hit The Spot		
95	Hit The Spot 1	Easy
96	Hit The Spot 2	Normal
97	Hit The Spot 3	
98	Hit The Spot 4	Difficult
99	Hit The Spot 5	

Demo: These songs demonstrate the drum sounds and rhythms. The pads light in sync with the rhythms.

Pattern: These are special loop-repeating patterns for drum practice. A variety of basic patterns are included in this type.

Fill in: These are special fill patterns appropriate for use with many rhythms.

Latin: These are special loop-repeating Latin rhythm patterns.

Song: These include drum and fill-in patterns, and are ideal for general practice purposes.

Song Effect: These enhanced songs feature effect processing.

DJ: These are special games with DJ-style beats.

Hit The Spot: These are special arcade-like games that challenge your reflexes — hit the pads as quickly as you can when they light.

Drum Kit List.....

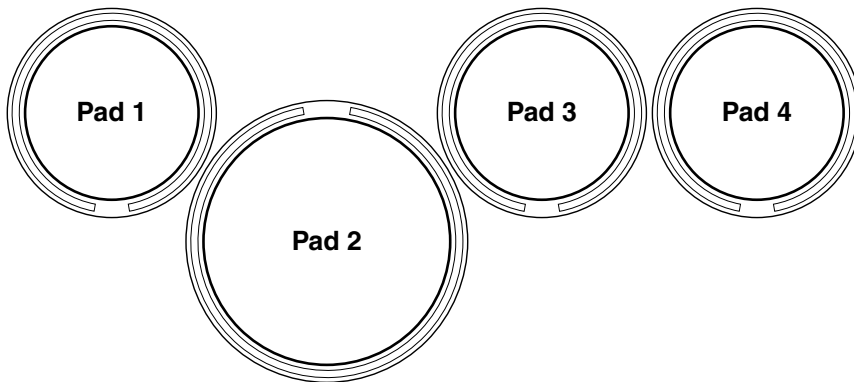

Category	Kit No.	Pad 1	Pad 2	Pad 3	Pad 4				
Normal	0	0	Bass Drum + Crash Cymbal	5	Snare Drum	1	Bass Drum	20	Hi-Hat Open
	1	0	Bass Drum + Crash Cymbal	5	Snare Drum	1	Bass Drum	128	Drum Fill 1
	2	0	Bass Drum + Crash Cymbal	5	Snare Drum	1	Bass Drum	129	Drum Fill 2
	3	0	Bass Drum + Crash Cymbal	5	Snare Drum	1	Bass Drum	131	Hard Drum Fill
	4	0	Bass Drum + Crash Cymbal	5	Snare Drum	12	Mid Tom	14	Floor Tom
	5	0	Bass Drum + Crash Cymbal	7	Snare Drum Hard	1	Bass Drum	13	Low Tom
	6	0	Bass Drum + Crash Cymbal	7	Snare Drum Hard	1	Bass Drum	128	Drum Fill 1
	7	0	Bass Drum + Crash Cymbal	7	Snare Drum Hard	1	Bass Drum	131	Hard Drum Fill
	8	0	Bass Drum + Crash Cymbal	7	Snare Drum Hard	12	Mid Tom	14	Floor Tom
	9	1	Bass Drum	5	Snare Drum	23	Crash Cymbal	20	Hi-Hat Open
	10	1	Bass Drum	5	Snare Drum	19	Hi-Hat Close	20	Hi-Hat Open
	11	1	Bass Drum	5	Snare Drum	25	Ride Cymbal	26	Hand Clap
	12	3	Bass Drum Hard	7	Snare Drum Hard	1	Bass Drum	131	Hard Drum Fill
	13	9	Sticks	6	Snare Drum Soft	23	Crash Cymbal	2	Bass Drum Soft
	14	10	Rim Shot	5	Snare Drum	1	Bass Drum	20	Hi-Hat Open
	15	10	Rim Shot	5	Snare Drum	1	Bass Drum	26	Hand Clap
	16	10	Rim Shot	6	Snare Drum Soft	2	Bass Drum Soft	14	Floor Tom
	17	10	Rim Shot	6	Snare Drum Soft	2	Bass Drum Soft	23	Crash Cymbal
	18	10	Rim Shot	6	Snare Drum Soft	25	Ride Cymbal	0	Bass Drum + Crash Cymbal
	19	10	Rim Shot	28	Tambourine	12	Mid Tom	14	Floor Tom
	20	11	High Tom	10	Rim Shot	12	Mid Tom	14	Floor Tom
	21	11	High Tom	5	Snare Drum	1	Bass Drum	14	Floor Tom
	22	11	High Tom	5	Snare Drum	12	Mid Tom	14	Floor Tom
	23	11	High Tom	6	Snare Drum Soft	12	Mid Tom	14	Floor Tom
	24	11	High Tom	12	Mid Tom	13	Low Tom	14	Floor Tom
	25	12	Mid Tom	5	Snare Drum	1	Bass Drum	14	Floor Tom
	26	12	Mid Tom	7	Snare Drum Hard	14	Floor Tom	131	Hard Drum Fill
	27	12	Mid Tom	7	Snare Drum Hard	13	Low Tom	14	Floor Tom
	28	12	Mid Tom	6	Snare Drum Soft	2	Bass Drum Soft	14	Floor Tom
	29	12	Mid Tom	6	Snare Drum Soft	14	Floor Tom	19	Hi-Hat Close
	30	13	Low Tom	6	Snare Drum Soft	1	Bass Drum	20	Hi-Hat Open
	31	20	Hi-Hat Open	10	Rim Shot	1	Bass Drum	25	Ride Cymbal
	32	23	Crash Cymbal	5	Snare Drum	1	Bass Drum	20	Hi-Hat Open
	33	23	Crash Cymbal	6	Snare Drum Soft	2	Bass Drum Soft	19	Hi-Hat Close
	34	23	Crash Cymbal	6	Snare Drum Soft	12	Mid Tom	14	Floor Tom
	35	8	Elec. Snare Drum	5	Snare Drum	1	Bass Drum	20	Hi-Hat Open
	36	63	Timpani L	6	Snare Drum Soft	2	Bass Drum Soft	62	Timpani H
	37	128	Drum Fill 1	130	Hard Drum	131	Hard Drum Fill	129	Drum Fill 2
	38	128	Drum Fill 1	5	Snare Drum	1	Bass Drum	129	Drum Fill 2
39	12	Mid Tom	6	Snare Drum Soft	4	Elec. Bass Drum	135	Electro Fill	

Category	Kit No.	Pad 1		Pad 2		Pad 3		Pad 4		
Electronic	40	26	Hand Clap	8	Elec. Snare Drum	15	Elec. High Tom	17	Elec. Low Tom	
	41	29	Cowbell	8	Elec. Snare Drum	4	Elec. Bass Drum	26	Hand Clap	
	42	15	Elec. High Tom	8	Elec. Snare Drum	16	Elec. Mid Tom	17	Elec. Low Tom	
	43	10	Rim Shot	30	Conga H Mute	31	Conga H Open	33	Conga L Open	
Percussion	44	10	Rim Shot	36	Timbale H	37	Timbale L	23	Crash Cymbal	
	45	29	Cowbell	36	Timbale H	37	Timbale L	23	Crash Cymbal	
	46	31	Conga H Open	33	Conga L Open	34	Bongo H	35	Bongo L	
	47	32	Conga Muff	30	Conga H Mute	31	Conga H Open	33	Conga L Open	
	48	36	Timbale H	31	Conga H Open	33	Conga L Open	37	Timbale L	
	49	39	Samba Whistle L	42	Cuica Mute	43	Cuica Open	38	Samba Whistle H	
	50	40	Agogo H	37	Timbale L	36	Timbale H	41	Agogo L	
	51	41	Agogo L	61	Tamborim Nylon Volta	60	Tamborim Ponta	40	Agogo H	
	52	43	Cuica Open	40	Agogo H	41	Agogo L	42	Cuica Mute	
	53	44	Surdo Close	45	Surdo Open	59	Tamborim Solto	60	Tamborim Ponta	
	54	44	Surdo Close	45	Surdo Open	56	Triangle Open	55	Triangle Mute	
	55	50	Guiro Short	36	Timbale H	37	Timbale L	49	Guiro Long	
	56	51	Claves	34	Bongo H	35	Bongo L	54	Wood Block L	
	57	51	Claves	30	Conga H Mute	31	Conga H Open	33	Conga L Open	
	58	51	Claves	36	Timbale H	37	Timbale L	25	Ride Cymbal	
	59	51	Claves	36	Timbale H	37	Timbale L	29	Cowbell	
	60	53	Wood Block H	42	Cuica Mute	56	Triangle Open	54	Wood Block L	
	61	54	Wood Block L	30	Conga H Mute	31	Conga H Open	33	Conga L Open	
	62	55	Triangle Mute	56	Triangle Open	53	Wood Block H	54	Wood Block L	
	63	133	Timbales Play	36	Timbale H	37	Timbale L	132	Conga Play	
	DJ	64	1	Bass Drum	104	Hand Clap	90	Hihfh	89	Huea
		65	64	One	65	Two	66	Three	67	Four
		66	71	Omen-FX	76	BLJ Trill	72	FMTB2	70	FX
67		71	Omen-FX	69	Explosion	29	Cowbell	70	FX	
68		74	Signal	71	Omen-FX	72	FMTB2	73	FMTB1	
69		75	Reverse	71	Omen-FX	73	FMTB1	86	Uhh	
70		85	Uhh + Hit	71	Omen-FX	74	Signal	70	FX	
71		85	Uhh + Hit	87	Yo-Kurt	90	Hihfh	92	GetUp!	
72		87	Yo-Kurt	91	Come On	26	Hand Clap	78	Scratch	
73		87	Yo-Kurt	90	Hihfh	89	Huea	92	GetUp!	
74		87	Yo-Kurt	90	Hihfh	78	Scratch	92	GetUp!	
75		87	Yo-Kurt	86	Uhh	78	Scratch	89	Huea	
76		135	Electro Fill	134	Vinyl Groove	136	Scratch Play	137	Yo! Yo! Yo! Yo!	
SFX		77	80	Ping Pong	121	Buzzer	142	Hole In One	143	Water In One
		78	97	Goat	102	Chick	99	Dog	103	Duck
		79	97	Goat	96	Horse	101	Rooster	98	Cow
	80	99	Dog	102	Chick	103	Duck	100	Cat	
	81	101	Rooster	100	Cat	102	Chick	99	Dog	
	82	103	Duck	113	Cork	118	Clown Horn	120	Spring	
	83	104	Big Trash Can	106	Small Trash Can	108	China Small Gong	105	Mid Trash Can	
	84	106	Small Trash Can	105	Mid Trash Can	107	Lid Trash Can	104	Big Trash Can	
	85	109	Tee Off	112	Ball In Water	111	Ball In Hole	110	Falling Ball	
	86	110	Falling Ball	120	Spring	122	Laughing Man	123	Laughing Girl	
	87	138	Applause(Fade In)	147	Celebration	139	Comedy	144	Blast	
	88	140	Gallop(Fade Out)	96	Horse	103	Duck	141	Gallop(Fade In)	
	89	145	Haunted House	118	Clown Horn	120	Spring	146	Missed Shot	
Sequence	90	Rock Beat								
	91	Rock & Roll								
	92	Rock Ballad								
	93	Hard Rock								
	94	Funk Beat								
	95	Fill								
	96	Electro Beat								
	97	Conga Beat								
98	Pandiero Beat									
99	1-2-3-4									

Specifications

Drum Pads

4 pads (125mm x 1, 88mm x 3), Touch Sensitive

Maximum Polyphony

16

Drum Kits

100 Preset + 1 Custom

Songs

100

Drum Voices

148

Functions

Track ON/OFF, TAP START, DEMO,
HAND PERCUSSION, LIGHT ON/OFF,
GAME 1, 2, 3

Panel Controls

[STANDBY/ON] switch, [PAD] button, [KIT] button,
[SONG] button, [TEMPO/TAP] button,
VOLUME [▲], [▼] buttons, [DRUM GAME] button,
[LIGHT ON/OFF] button, [HAND PERC] button,
[DEMO] button, [START/STOP] button, DIAL

LED Display

Song/Drum Kit/Tempo etc.

Auxiliary jacks

DC IN12 V
PHONES/OUTPUT

Main Amplifier

5W (EIAJ)

Speaker

10 cm

Power Consumption

10 W (when using PA-3B power adaptor)

Power Supply

Adaptor : DC12V

(Yamaha PA-3B sold separately)

Batteries: Six "AA" size, R6P(LR6), or equivalent
batteries (sold separately)

Dimensions (WxDxH)

460 x 227 x 105 mm (18" 1/8 x 9" x 4" 1/8)

Weight

1.6Kg (3 lbs. 8 oz)

Supplied Accessories

Drum stick x 2, Owner's Manual

Optional Accessories

Headphones HPE-150

* Specifications and descriptions in this owner's manual are for information purposes only. Yamaha Corp. reserves the right to change or modify products or specifications at any time without prior notice. Since specifications, equipment or options may not be the same in every locale, please check with your Yamaha dealer.

Limited Warranty

90 DAYS LABOR

1 YEAR PARTS

Yamaha Corporation of America, hereafter referred to as Yamaha, warrants to the original consumer of a product included in the categories listed below, that the product will be free of defects in materials and/or workmanship for the periods indicated. This warranty is applicable to all models included in the following series of products:

PSR SERIES OF PORTATONE ELECTRONIC KEYBOARDS

If during the first 90 days that immediately follows the purchase date, your new Yamaha product covered by this warranty is found to have a defect in material and/or workmanship, Yamaha and/or its authorized representative will repair such defect without charge for parts or labor.

If parts should be required after this 90 day period but within the one year period that immediately follows the purchase date, Yamaha will, subject to the terms of this warranty, supply these parts without charge. However, charges for labor, and/or any miscellaneous expenses incurred are the consumers responsibility. Yamaha reserves the right to utilize reconditioned parts in repairing these products and/or to use reconditioned units as warranty replacements.

THIS WARRANTY IS THE ONLY EXPRESS WARRANTY WHICH YAMAHA MAKES IN CONNECTION WITH THESE PRODUCTS. ANY IMPLIED WARRANTY APPLICABLE TO THE PRODUCT, INCLUDING THE WARRANTY OF MERCHANTABILITY IS LIMITED TO THE DURATION OF THE EXPRESS WARRANTY. YAMAHA EXCLUDES AND SHALL NOT BE LIABLE IN ANY EVENT FOR INCIDENTAL OR CONSEQUENTIAL DAMAGES.

Some states do not allow limitations that relate to implied warranties and/or the exclusion of incidental or consequential damages. Therefore, these limitations and exclusions may not apply to you.

This warranty gives you specific legal rights. You may also have other rights which vary from state to state.

CONSUMERS RESPONSIBILITIES

If warranty service should be required, it is necessary that the consumer assume certain responsibilities:

1. Contact the Customer Service Department of the retailer selling the product, or any retail outlet authorized by Yamaha to sell the product for assistance. You may also contact Yamaha directly at the address provided below.
2. Deliver the unit to be serviced under warranty to: the retailer selling the product, an authorized service center, or to Yamaha with an explanation of the problem. Please be prepared to provide proof purchase date (sales receipt, credit card copy, etc.) when requesting service and/or parts under warranty.
3. Shipping and/or insurance costs are the consumers responsibility.* Units shipped for service should be packed securely.

*Repaired units will be returned PREPAID if warranty service is required within the first 90 days.

IMPORTANT: Do NOT ship anything to ANY location without prior authorization. A Return Authorization (RA) will be issued that has a tracking number assigned that will expedite the servicing of your unit and provide a tracking system if needed.

4. Your owners manual contains important safety and operating instructions. It is your responsibility to be aware of the contents of this manual and to follow all safety precautions.

EXCLUSIONS

This warranty does not apply to units whose trade name, trademark, and/or ID numbers have been altered, defaced, exchanged removed, or to failures and/or damages that may occur as a result of:

1. Neglect, abuse, abnormal strain, modification or exposure to extremes in temperature or humidity.
2. Improper repair or maintenance by any person who is not a service representative of a retail outlet authorized by Yamaha to sell the product, an authorized service center, or an authorized service representative of Yamaha.
3. This warranty is applicable only to units sold by retailers authorized by Yamaha to sell these products in the U.S.A., the District of Columbia, and Puerto Rico. This warranty is not applicable in other possessions or territories of the U.S.A. or in any other country.

Please record the model and serial number of the product you have purchased in the spaces provided below.

Model _____ Serial # _____ Sales Slip # _____

Purchased from _____ Date _____
(Retailer)

YAMAHA CORPORATION OF AMERICA
Electronic Service Division
6600 Orangethorpe Avenue
Buena Park, CA 90620

KEEP THIS DOCUMENT FOR YOUR RECORDS. DO NOT MAIL!

For details of products, please contact your nearest Yamaha or the authorized distributor listed below.

Pour plus de détails sur les produits, veuillez-vous adresser à Yamaha ou au distributeur le plus proche de vous figurant dans la liste suivante.

Die Einzelheiten zu Produkten sind bei Ihrer unten aufgeführten Niederlassung und bei Yamaha-Vertragshändlern in den jeweiligen Bestimmungsländern erhältlich.

Para detalles sobre productos, contacte su tienda Yamaha más cercana o el distribuidor autorizado que se lista debajo.

NORTH AMERICA

CANADA

Yamaha Canada Music Ltd.
135 Milner Avenue, Scarborough, Ontario, M1S 3R1,
Canada
Tel: 416-298-1311

U.S.A.

Yamaha Corporation of America
6600 Orangethorpe Ave., Buena Park, Calif. 90620,
U.S.A.
Tel: 714-522-9011

CENTRAL & SOUTH AMERICA

MEXICO

**Yamaha de Mexico S.A. De C.V.,
Departamento de ventas**
Javier Rojo Gomez No.1149, Col. Gpe Del Moral,
Deleg. Iztapalapa, 09300 Mexico, D.F.
Tel: 686-00-33

BRAZIL

Yamaha Musical do Brasil LTDA.
Av. Rebouças 2636, São Paulo, Brasil
Tel: 011-853-1377

ARGENTINA

Yamaha de Panamá S.A. Sucursal de Argentina
Viamonte 1145 Piso2-B 1053, Buenos Aires,
Argentina
Tel: 1-4371-7021

PANAMA AND OTHER LATIN AMERICAN COUNTRIES/ CARIBBEAN COUNTRIES

Yamaha de Panamá S.A.
Torre Banco General, Piso 7, Urbanización Marbella,
Calle 47 y Aquilino de la Guardia, Ciudad de Panamá,
Panamá
Tel: 507-269-5311

EUROPE

THE UNITED KINGDOM

Yamaha-Kemble Music (U.K.) Ltd.
Sherbourne Drive, Tilbrook, Milton Keynes,
MK7 8BL, England
Tel: 01908-366700

IRELAND

Danfay Ltd.
61D, Sallynoggin Road, Dun Laoghaire, Co. Dublin
Tel: 01-2859177

GERMANY/SWITZERLAND

Yamaha Europa GmbH.
Siemensstraße 22-34, 25462 Rellingen,
F.R. of Germany
Tel: 04101-3030

AUSTRIA

Yamaha Music Austria
Schleiergasse 20, A-1100 Wien Austria
Tel: 01-60203900

THE NETHERLANDS

Yamaha Music Nederland
Kanaalweg 18G, 3526KL, Utrecht, The Netherlands
Tel: 030-2828411

BELGIUM

Yamaha Music Belgium
Keiberg Imperiastraat 8, 1930 Zaventem, Belgium
Tel: 02-7258220

FRANCE

**Yamaha Musique France,
Division Claviers**
BP 70-77312 Marne-la-Vallée Cedex 2, France
Tel: 01-64-61-4000

ITALY

Yamaha Musica Italia S.P.A.
Viale Italia 88, 20020 Lainate (Milano), Italy
Tel: 02-935-771

SPAIN/PORTUGAL

Yamaha-Hazen Electronica Musical, S.A.
Ctra. de la Coruna km. 17, 200, 28230
Las Rozas (Madrid) Spain
Tel: 91-201-0700

GREECE

Philippe Nakas S.A.
Navarinou Street 13, P.Code 10680, Athens, Greece
Tel: 01-364-7111

SWEDEN

Yamaha Scandinavia AB
J. A. Wettergrens Gata 1
Box 30053
S-400 43 Göteborg, Sweden
Tel: 031 89 34 00

DENMARK

YS Copenhagen Liaison Office
Generatorvej 8B
DK-2730 Herlev, Denmark
Tel: 44 92 49 00

FINLAND

F-Musiikki Oy
Kluuvikatu 6, P.O. Box 260,
SF-00101 Helsinki, Finland
Tel: 09 618511

NORWAY

Norsk filial av Yamaha Scandinavia AB
Grini Næringspark 1
N-1345 Østerås, Norway
Tel: 67 16 77 70

ICELAND

Skifan HF
Skeifan 17 P.O. Box 8120
IS-128 Reykjavik, Iceland
Tel: 525 5000

OTHER EUROPEAN COUNTRIES

Yamaha Europa GmbH.
Siemensstraße 22-34, 25462 Rellingen,
F.R. of Germany
Tel: 04101-3030

AFRICA

**Yamaha Corporation,
Asia-Pacific Music Marketing Group**
Nakazawa-cho 10-1, Hamamatsu, Japan 430-8650
Tel: 053-460-2312

MIDDLE EAST

TURKEY/CYPRUS

Yamaha Europa GmbH.
Siemensstraße 22-34, 25462 Rellingen,
F.R. of Germany
Tel: 04101-3030

OTHER COUNTRIES

Yamaha Music Gulf FZE
LB21-128 Jebel Ali Freezone
P.O.Box 17328, Dubai, U.A.E.
Tel: 971-4-881-5868

ASIA

HONG KONG

Tom Lee Music Co., Ltd.
11/F., Silvercord Tower 1, 30 Canton Road,
Tsimshatsui, Kowloon, Hong Kong
Tel: 2737-7688

INDONESIA

**PT. Yamaha Music Indonesia (Distributor)
PT. Nusantik**
Gedung Yamaha Music Center, Jalan Jend.
Gatot Subroto Kav. 4, Jakarta 12930, Indonesia
Tel: 21-520-2577

KOREA

Yamaha Music Korea Ltd.
Tong-Yang Securities Bldg. 16F 23-8 Yoido-dong,
Youngdungpo-ku, Seoul, Korea
Tel: 02-3770-0661

MALAYSIA

Yamaha Music Malaysia, Sdn. Bhd.
Lot 8, Jalan Perbandaran, 47301 Kelana Jaya,
Petaling Jaya, Selangor, Malaysia
Tel: 3-703-0900

PHILIPPINES

Yupango Music Corporation
339 Gil J. Puyat Avenue, P.O. Box 885 MCPO,
Makati, Metro Manila, Philippines
Tel: 819-7551

SINGAPORE

Yamaha Music Asia Pte., Ltd.
11 Ubi Road #06-00, Meiban Industrial Building,
Singapore
Tel: 65-747-4374

TAIWAN

Yamaha KHS Music Co., Ltd.
10F, 150, Tun-Hwa Northroad, Taipei, Taiwan, R.O.C.
Tel: 02-2713-8999

THAILAND

Siam Music Yamaha Co., Ltd.
121/60-61 RS Tower 17th Floor,
Ratchadaphisek RD., Dindaeng,
Bangkok 10320, Thailand
Tel: 02-641-2951

THE PEOPLE'S REPUBLIC OF CHINA AND OTHER ASIAN COUNTRIES

**Yamaha Corporation,
Asia-Pacific Music Marketing Group**
Nakazawa-cho 10-1, Hamamatsu, Japan 430-8650
Tel: 053-460-2317

OCEANIA

AUSTRALIA

Yamaha Music Australia Pty. Ltd.
Level 1, 99 Queensbridge Street, Southbank,
Victoria 3006, Australia
Tel: 3-9693-5111

NEW ZEALAND

Music Houses of N.Z. Ltd.
146/148 Captain Springs Road, Te Papapa,
Auckland, New Zealand
Tel: 9-634-0099

COUNTRIES AND TRUST TERRITORIES IN PACIFIC OCEAN

**Yamaha Corporation,
Asia-Pacific Music Marketing Group**
Nakazawa-cho 10-1, Hamamatsu, Japan 430-8650
Tel: 053-460-2312

HEAD OFFICE Yamaha Corporation, Pro Audio & Digital Musical Instrument Division

Nakazawa-cho 10-1, Hamamatsu, Japan 430-8650
Tel: 053-460-3273

[PK] 22

M.D.G., Pro Audio & Digital Musical Instrument Division, Yamaha Corporation
© 2001 Yamaha Corporation

V740960 ???PO???.?-02B0 Printed in Malaysia



Yamaha PK CLUB (Portable Keyboard Home Page, English only)
<http://www.yamahaPKclub.com/>

Yamaha Manual Library (English versions only)
<http://www2.yamaha.co.jp/manual/english/>