

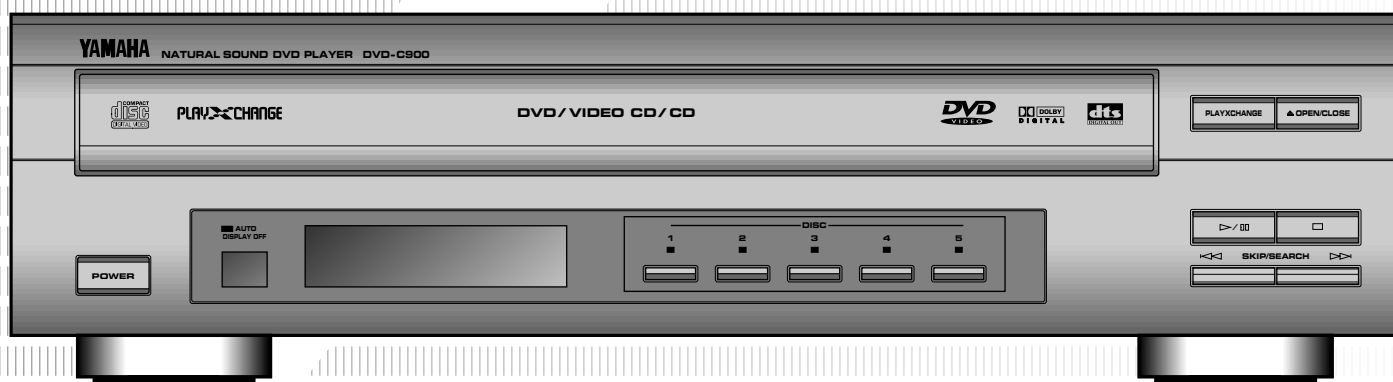

DVD-C900

NATURAL SOUND DVD PLAYER
LECTEUR DVD



OWNER'S MANUAL
MODE D'EMPLOI

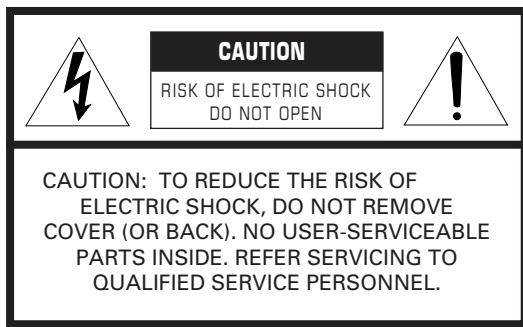

IMPORTANT
Please record the serial number of your unit in the space below.
Model:
Serial No.:

The serial number is located on the rear of the unit.
Retain this Owner's Manual in a safe place for future reference.

• Explanation of Graphical Symbols

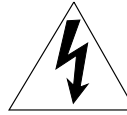

The lightning flash with arrowhead symbol, within an equilateral triangle, is intended to alert you to the presence of uninsulated "dangerous voltage" within the product's enclosure that may be of sufficient magnitude to constitute a risk of electric shock to persons.



The exclamation point within an equilateral triangle is intended to alert you to the presence of important operating and maintenance (servicing) instructions in the literature accompanying the appliance.

WARNING
TO REDUCE THE RISK OF FIRE OR ELECTRIC SHOCK, DO NOT EXPOSE THIS UNIT TO RAIN OR MOISTURE.

SAFETY INSTRUCTIONS

- 1 Read Instructions – All the safety and operating instructions should be read before the appliance is operated.
- 2 Retain Instructions – The safety and operating instructions should be retained for future reference.
- 3 Heed Warnings – All warnings on the appliance and in the operating instructions should be adhered to.
- 4 Follow Instructions – All operating and use instructions should be followed.
- 5 Cleaning — Unplug this video product from the wall outlet before cleaning. Do not use liquid cleaners or aerosol cleaners. Use a damp cloth for cleaning.

Exception: A product that is meant for uninterrupted service and that for some specific reason, such as the possibility of the loss of an authorization code for a CATV converter, is not intended to be unplugged by the user for cleaning or any other purpose, may exclude the reference to unplugging the appliance in the cleaning description otherwise required in item 5.
- 6 Attachments — Do not use attachments not recommended by the video product manufacturer as they may cause hazards.
- 7 Water and Moisture – Do not use this video product near water – for example, near a bathtub, washbowl, kitchen sink, laundry tub, in a wet basement, or near a swimming pool, and the like.
- 8 Accessories — Do not place this video product on an unstable cart, stand, tripod, bracket, or table. The video product may fall, causing serious injury to a child or adult, and serious damage to the appliance. Use only with a cart, stand, tripod, bracket, or table recommended by the manufacturer, or sold with the video product. Any mounting of the appliance should follow the manufacturer's instructions, and should use a mounting accessory recommended by the manufacturer.
- 8A An appliance and cart combination should be moved with care. Quick stops, excessive force, and uneven surfaces may cause the appliance and cart combination to overturn.
- 9 Ventilation — Slots and openings in the cabinet are provided for ventilation and to ensure reliable operation of the video product and to protect it from overheating, and these openings must not be blocked or covered. The openings should never be blocked by placing the video product on a bed, sofa, rug, or other similar surface. This video product should never be placed near or over a radiator or heat register. This video product should not be placed in a built-in installation such as a bookcase or rack unless proper ventilation is provided or the manufacturer's instructions have been adhered to.
- 10 Power Sources — This video product should be operated only from the type of power source indicated on the marking label. If you are not sure of the type of power supply to your home, consult your appliance dealer or local power company. For video products intended to operate from battery power, or other sources, refer to the operating instructions.
- 11 Grounding or Polarization — This video product is equipped with a polarized alternating-current line plug (a plug having one blade wider than the other). This plug will fit into the power outlet only one way. This is a safety feature. If you are unable to insert the plug fully into the outlet, try reversing the plug. If the plug should still fail to fit, contact your electrician to replace your obsolete outlet. Do not defeat the safety purpose of the polarized plug.

Alternate Warnings — This video product is equipped with a 3-wire grounding-type plug, a plug having a third (grounding) pin. This plug will only fit into a grounding-type power outlet. This is a safety feature. If you are unable to insert the plug into the outlet, contact your electrician to replace your obsolete outlet. Do not defeat the safety purpose of the grounding-type plug.
- 12 Power-Cord Protection – Power-supply cords should be routed so that they are not likely to be walked on or pinched by items placed upon or against them, paying particular attention to cords at plugs, convenience receptacles, and the point where they exit from the appliance.



- 13 Outdoor Antenna Grounding** — If an outside antenna or cable system is connected to the video product, be sure the antenna or cable system is grounded so as to provide some protection against voltage surges and built-up static charges. Article 810 of the National Electrical Code, ANSI/NFPA No. 70, provides information with regard to proper grounding of the mast and supporting structure, grounding of the lead-in wire to an antenna discharge unit, size of grounding conductors, location of antenna-discharge unit, connection to grounding electrodes, and requirements for the grounding electrode. See the figure below.

EXAMPLE OF ANTENNA GROUNDING

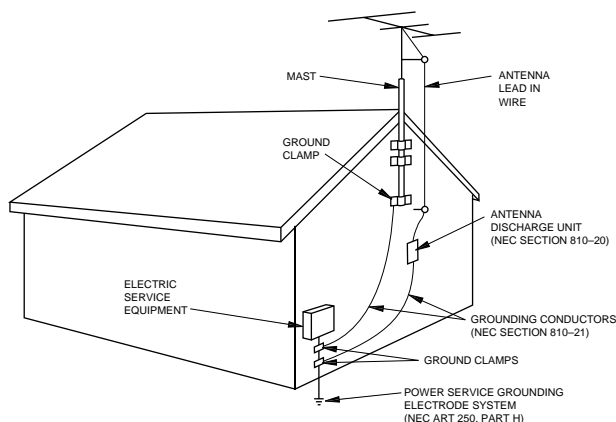

NEC - NATIONAL ELECTRICAL CODE

- 14 Lightning** — For added protection for this video product receiver during a lightning storm, or when it is left unattended and unused for long periods of time, unplug it from the wall outlet and disconnect the antenna or cable system. This will prevent damage to the video product due to lightning and power-line surges.
- 15 Power Lines** — An outside antenna system should not be located in the vicinity of overhead power lines or other electric light or power circuits, or where it can fall into such power lines or circuits. When installing an outside antenna system, extreme care should be taken to keep from touching such power lines or circuits as contact with them might be fatal.

- 16 Overloading** — Do not overload wall outlets and extension cords as this can result in a risk of fire or electric shock.
- 17 Object and Liquid Entry** — Never push objects of any kind into this video product through openings as they may touch dangerous voltage points or short-out parts that could result in a fire or electric shock. Never spill liquid of any kind on the video product.
- 18 Servicing** — Do not attempt to service this video product yourself as opening or removing covers may expose you to dangerous voltage or other hazards. Refer all servicing to qualified service personnel.
- 19 Damage Requiring Service** — Unplug this video product from the wall outlet and refer servicing to qualified service personnel under the following conditions:
- When the power-supply cord or plug is damaged.
 - If liquid has been spilled, or objects have fallen into the video product.
 - If the video product has been exposed to rain or water.
 - If the video product does not operate normally by following the operating instructions. Adjust only those controls that are covered by the operating instructions as an improper adjustment of other controls may result in damage and will often require extensive work by a qualified technician to restore the video product to its normal operation.
 - If the video product has been dropped or the cabinet has been damaged.
 - When the video product exhibits a distinct change in performance — this indicates a need for service.
- 20 Replacement Parts** — When replacement parts are required, be sure the service technician has used replacement parts specified by the manufacturer or have the same characteristics as the original part. Unauthorized substitutions may result in fire, electric shock or other hazards.
- 21 Safety Check** — Upon completion of any service or repairs to this video product, ask the service technician to perform safety checks to determine that the video product is in proper operating condition.

FCC INFORMATION (for US customers only)

1. IMPORTANT NOTICE : DO NOT MODIFY THIS UNIT!

This product, when installed as indicated in the instructions contained in this manual, meets FCC requirements. Modifications not expressly approved by Yamaha may void your authority, granted by the FCC, to use the product.

- 2. IMPORTANT :** When connecting this product to accessories and/or another product use only high quality shielded cables. Cable/s supplied with this product MUST be used. Follow all installation instructions. Failure to follow instructions could void your FCC authorization to use this product in the USA.

- 3. NOTE :** This product has been tested and found to comply with the requirements listed in FCC Regulations, Part 15 for Class "B" digital devices. Compliance with these requirements provides a reasonable level of assurance that your use of this product in a residential environment will not result in harmful interference with other electronic devices.

This equipment generates/uses radio frequencies and, if not installed and used according to the instructions found in the users manual, may cause interference harmful to the operation of other electronic devices.

Compliance with FCC regulations does not guarantee that interference will not occur in all installations. If this product is found to be the source of interference, which can be determined by turning the unit "OFF" and "ON", please try to eliminate the problem by using one of the following measures:

Relocate either this product or the device that is being affected by the interference.

Utilize power outlets that are on different branch (circuit breaker or fuse) circuits or install AC line filter/s.

In the case of radio or TV interference, relocate/reorient the antenna. If the antenna lead-in is 300 ohm ribbon lead, change the lead-in to coaxial type cable.

If these corrective measures do not produce satisfactory results, please contact the local retailer authorized to distribute this type of product. If you can not locate the appropriate retailer, please contact Yamaha Electronics Corp., U.S.A. 6660 Orangethorpe Ave, Buena Park, CA 90620.

The above statements apply ONLY to those products distributed by Yamaha Corporation of America or its subsidiaries.

CONTENTS

SAFETY INSTRUCTIONSInside of the front cover	
Features	1
Caution	2
Getting started	4
Unpacking	4
Installing batteries in the remote controller	5
Notes about the remote controller	5
Names of parts and their functions	6
Connections	9
Speaker setup	9
■ Speaker configuration	9
■ Placing speakers	9
Audio connections	10
■ Connecting to an AV amplifier (or receiver) equipped with a Dolby Digital, MPEG or DTS decoder, or connecting to a Dolby Digital, MPEG or DTS decoder	10
■ Connecting to an AV amplifier (or receiver) equipped with 6 channel input terminals <For China and General models only>	12
■ Connecting to a stereo amplifier that has neither 6 channel audio signal input terminals nor Dolby Digital decoder	13
Video connections	14
■ Connecting to an amplifier equipped with an RCA type video signal input terminal (including an S-video input terminal)	14
■ Connecting to a TV equipped with component video input terminals	15
Basic operation	16
Basic playback	16
Playing back a preferred scene or track	19
■ Beginning playback from a preferred chapter (or track)	19
■ Skipping to a preferred chapter (or track) on the disc (Skip search)	19
■ Beginning playback from a preferred title (for DVDs) or index number (for Video CDs/CDs).....	20
■ Beginning playback from a preferred time point on the disc.....	21
Other ways of playback	22
■ To advance or reverse playback rapidly (Rapid search).....	22
■ To still picture (or suspend playback).....	22
■ Frame advance [DVD and VCD only].....	22
■ To advance or reverse playback in a preferred speed (Multi-speed playback) [DVD and VCD only].....	23
■ Operations unique for a Video CD in the Playback Control mode [VCD only]	25
■ Changing the audio output mode (to enjoy using a multisound disc etc.) [VCD and CD only]	26
Displaying various information	27
Switching the time display	27
On Screen Display	29
Advanced operation	32
Repeat play	32
Repeat play between specified two points (A-B repeat play)	33
Program play	34
Random play	37
Changing subtitle language [DVD only]	38
Changing audio sound track language [DVD only]	39
Using a title menu [DVD only].....	40
Using a DVD menu [DVD only].....	41
Viewing from another angle [DVD only].....	42
Initial settings (on the SET UP menu)	43
Items	43
Common procedure for setting change	44
Item description and setting change	45
DVD Settings	
1 TV Type	45
2 Display Mode	46
3 Menu Language	47
4 Subtitle Language	48
5 Audio Language	49
6 Rating Level	50
VCD Settings	
1 Playback Control	52
Display Settings	
1 Guide Display	53
2 OSD Language	54
3 Background Screen	55
4 Screen Saver	56
5 FL Dimmer	57
6 Signal System Conversion [DVD and VCD only] <For China and General models only>	58
Audio Settings	
1 Digital Output	59
2 Dynamic Range Control <For China and General models only>	61
3 Speaker [DVD only] <For China and General models only>	62
Appendix	64
Troubleshooting	64
Definition of terms	66
Language code list	67
Region management information	68
Notes about handling discs	68
Specifications	69

- **5-Disc Carousel Auto-Changer (for Playing DVDs, Video CDs and Compact Discs)**
- **Full Opening Disc Table for Changing 5 Discs at a Time**
- **Compatible with Almost of All Utility Functions of DVD Discs**
- **PLAYXCHANGE; Disc Changing Capability while Playing Another**
- **Program Play**
- **Random Play**
- **Single Track/Full Disc Repeat Play and A-B Repeat Play for Repeating a Section between Two Specified Points**
- **Multi-Speed Playback Capability**
- **On Screen Display Function (Displays This Unit's Operation Status and Disc Information on the TV Monitor)**
- **SET UP Menu Which Provides You with Various Changeable or Adjustable Items for Using This Unit in the Most Suitable Condition**
- **1 OPTICAL and 1 COAXIAL Digital Terminals to Output Digital Audio Signals Encoded with Dolby Digital, DTS, MPEG or Linear PCM**
- **S VIDEO and COMPONENT VIDEO Outputs for High-Quality Picture Reproduction**
- **Remote Control Capability**

China and General models only

- **Built-in Dolby Digital Decoder to Provide You with High-quality 5.1-channel Surround Sound of Sources Encoded with Dolby Digital**



Manufactured under license from Dolby Laboratories. "Dolby" and the double-D symbol are trademarks of Dolby Laboratories. Confidential Unpublished Works. © 1992–1997 Dolby Laboratories, Inc. All rights reserved.

About the symbols used in this manual

A section whose title has one of the following symbols is applicable only to the disc represented by the symbol.

DVD

Video CD



CD

* A section with no symbol is applicable to all discs.

Caution: Read this before operating your unit.

- 1 To ensure the finest performance, please read this manual carefully. Keep it in a safe place for future reference.
- 2 The voltage to be used must be the same as that specified on this unit. Using this unit with a higher voltage than that which is specified is dangerous and may result in a fire or other type of accident causing damage. YAMAHA will not be held responsible for any damage resulting from use of this unit with a voltage other than that which is specified.
- 3 Install your unit in a cool, dry, clean place – away from windows, heat sources, and too much vibration, dust, moisture or cold. Avoid sources of hum (transformers, motors). To prevent fire or electrical shock, do not expose to rain or water.
- 4 This unit should not be placed on appliances, such as amplifiers, that produce heat, or placed in a cabinet that impedes the flow of air. This may result in a failure in this unit. Install this unit in a well ventilated place. In addition, do not place objects on this unit.
- 5 The generated digital signals may interfere with other equipment such as tuners or receivers. Move the system farther away from such equipment if interference is observed.
- 6 Sudden temperature changes and storage or operation in an extremely humid environment may cause condensation inside the cabinet.
Condensation can cause the unit to malfunction.
To eliminate condensation, leave the power on with no disc in the unit until normal playback becomes possible (about 1 hour).
- 7 Do not operate the unit upside-down. It may overheat, possibly causing damage.
- 8 Never open the cabinet. If a foreign object drops into the unit, contact your dealer.
- 9 To prevent lightning damage, unplug the power cord and remove the antenna cable during electrical storms.
- 10 Do not attempt to clean the unit with chemical solvents; this might damage the finish. Use a clean, dry cloth.
- 11 Do not use force on switches, knobs or cords. When moving the set, first turn the unit off. Then gently disconnect the power plug and the cords connecting to other equipment. Never pull the cord itself.
- 12 Always set the volume control on the amplifier to minimum before starting a disc play: increase the volume gradually to an appropriate level after play has started.
- 13 Be sure to read the "TROUBLESHOOTING" section on common operating errors before concluding that your unit is faulty.

This unit can play discs of the following types only.

Type of disc	Mark printed on the disc	Type of signal recorded	Size (Dimension)	Maximum possible play time
DVD		Sound + Picture (Movie)	12 cm	Approx. 4 hours (One side only) Approx. 8 hours (Both sides)
			8 cm (Single type)	Approx. 80 minutes (One side only) Approx. 160 minutes (Both sides)
Video CD		Sound + Picture (Movie)	12 cm	74 minutes
			8 cm (Single type)	20 minutes
CD		Sound only	12 cm	74 minutes
			8 cm (Single type)	20 minutes

Video CDs are classified into two types, version 1.1 and 2.0. This unit can play not only discs of version 1.1, but also version 2.0 on which a Playback Control can be made.

Never attempt to play back a disc other than above with this unit because it may cause a damage to this unit and/or other units connected to this unit.

Examples of disc types which this unit cannot play back:

CD-R, CD-EXTRA, CD-ROM, CD-G, PHOTO CD, DVD-ROM, VSD, CDV, etc.

Note

DVDs and Video CDs can only utilize the features with which they were designed by the software creators. Depending on the contents of each disc, some operations described in this manual may become inoperative. Be sure to refer to the instruction for each respective disc.

To prevent a malfunction of this unit:

- Do not use any nonstandard shaped disc (heart etc.) available on the market, because it may damage the unit.

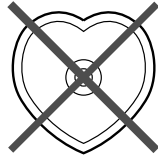

- Do not use a disc with tape, seals, or paste on it, because damage to the unit may result.

Some nonstandard discs are available on the market though they look the same as the standard ones. This unit may not be able to play back such discs in the ways described on this owner's manual.

This unit is designed for home use only. Do not use this unit for business purposes.

Be sure to place this unit on a level surface. If not so, this unit will fail to work normally at the PLAYXCHANGE operation and cause damage to the disc(s) and this unit itself.

Caution for moving this unit

- When moving this unit, first remove all discs from the disc table and close the table by pressing the **OPEN/CLOSE** button, and then switch off the power after you confirm that the front panel display indicates as follows.

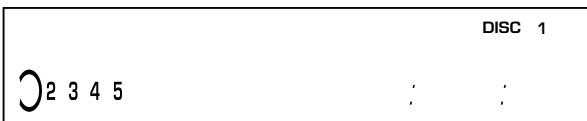

Never switch off the power if the front panel display is not pictured as above, otherwise the unit will break down during moving because the internal mechanism is not locked.

- Be sure not to lift or tip the unit with discs remaining in it.

FOR CANADIAN CUSTOMERS

TO PREVENT ELECTRIC SHOCK, MATCH WIDE BLADE OF PLUG TO WIDE SLOT AND FULLY INSERT.

THIS CLASS B DIGITAL APPARATUS MEETS ALL REQUIREMENTS OF THE CANADIAN INTERFERENCE-CAUSING EQUIPMENT REGULATIONS.

We Want You Listening For A Lifetime

YAMAHA and the Electronic Industries Association's Consumer Electronics Group want you to get the most out of your equipment by playing it at a safe level. One that lets the sound come through loud and clear without annoying blaring or distortion – and, most importantly, without affecting your sensitive hearing.

Since hearing damage from loud sounds is often undetectable until it is too late, YAMAHA and the Electronic Industries Association's Consumer Electronics Group recommend you to avoid prolonged exposure from excessive volume levels.

**WARNING**

To reduce the risk of fire or electric shock, do not expose this unit to rain or moisture.

To avoid electrical shock, do not open the cabinet. Refer servicing to qualified personnel only.

DANGER

Invisible laser radiation when open and interlock failed or defeated.

Avoid direct exposure to beam.

CAUTION

DVD/VIDEO CD/CD PLAYER IS A CLASS 1 LASER PRODUCT. HOWEVER THIS DVD/VIDEO CD/CD PLAYER USES A VISIBLE LASER BEAM WHICH COULD CAUSE HAZARDOUS RADIATION EXPOSURE IF DIRECTED. BE SURE TO OPERATE THE DVD/VIDEO CD/CD PLAYER CORRECTLY AS INSTRUCTED.

WHEN THIS DVD/VIDEO CD/CD PLAYER IS PLUGGED TO THE WALL OUTLET, DO NOT PLACE YOUR EYES CLOSE TO THE OPENING OF THE DISC TRAY AND OTHER OPENINGS TO LOOK INTO THE INSIDE OF THIS PLAYER.

USE OF CONTROLS OR ADJUSTMENTS OR PERFORMANCE OF PROCEDURES OTHER THAN THOSE SPECIFIED HEREIN MAY RESULT IN HAZARDOUS RADIATION EXPOSURE.

DO NOT OPEN COVERS AND DO NOT REPAIR YOURSELF. REFER SERVICING TO QUALIFIED PERSONNEL.

Laser component in this product is capable of emitting radiation exceeding the limit for Class 1.

CAUTION	-VISIBLE LASER RADIATION WHEN OPEN. DO NOT STARE INTO BEAM.
ATTENTION	-RAYONNEMENT LASER EN CAS D'OUVERTURE. NE PAS REGARDER DANS LE FAISCEAU.
VORSICHT	-LASERSTRAHLUNG, WENN ABDECKUNG GEÖFFNET. NICHT IN DEN STRAHL BLICKEN.
ADVARSEL	-LASERSTRÅLING VED ÅBNING. SE IKKE INN I STRÅLEN.
ADVARSEL	-LASERSTRÅLING NÅR DEKSEL ÅPNES. STIRR IKKE INN I STRÅLEN.
VARNING	-LASERSTRÅLNING NÅR DENNA DEL ÄR ÖPPNAD. STIRRA EJ IN I STRÅLEN.
VARO!	AVATTAESSA OLET ALTTIINA LASERSÄTEILYLLE. ÄLÄ TUJOTA SÄTEESEEN.
注意	— 当打开这里时会出现激光， 请不要直视激光。
注意	— ここを開くとレーザー光が出ます。 レーザー光をのぞき込まないでください。

(Inside of product)

Getting started

Unpacking

Carefully take this unit and accessories out of the box. You should find the unit itself and the following accessories.

Remote controller

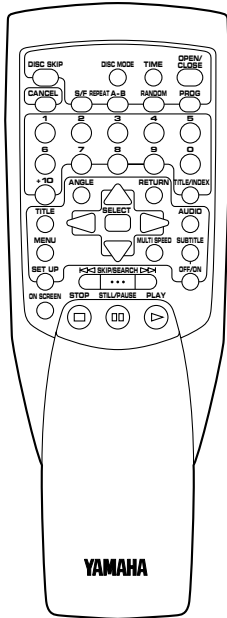

Batteries (size AA, R6, UM-3)

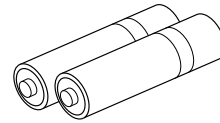

Audio/Video connection cord

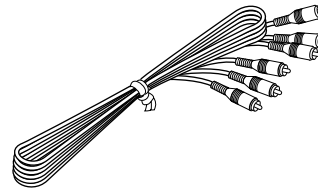

Installing batteries in the remote controller

Since the remote controller will be used for many of this unit's control operations, you should begin by installing the supplied batteries.

1. Turn the remote controller over and slide the battery compartment cover in the direction of the arrow.
2. Insert the batteries (R6, AA, UM-3 type) according to the polarity markings on the inside of the battery compartment.
3. Close the battery compartment cover.

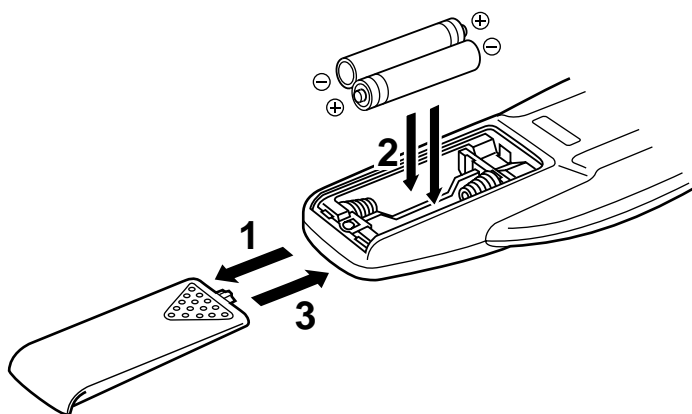

Notes about the remote controller

Battery replacement

If you find that the remote controller must be used closer to the main unit, the batteries are weak. Replace both batteries with new ones.

Notes

- Use only AA, R6, UM-3 batteries.
- Be sure the polarities are correct. (See the illustration inside the battery compartment.)
- Remove the batteries if the remote controller is not used for an extended period of time.
- If batteries leak, dispose of them immediately. Avoid touching the leaked material and contact with clothing, etc. Clean the battery compartment thoroughly before installing new batteries.

Remote controller operation range

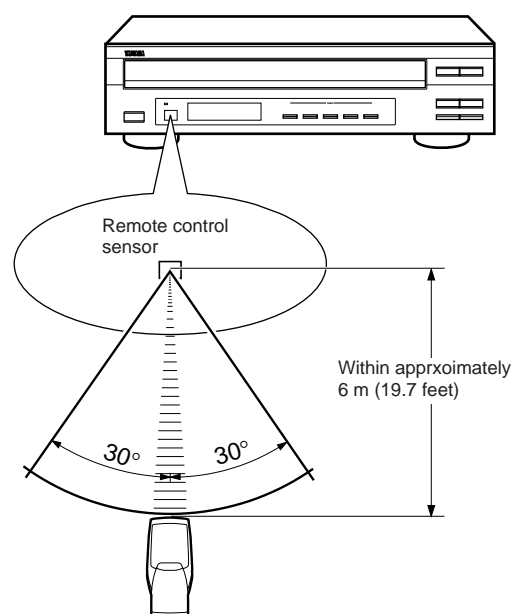

Notes

- The area between the remote controller and the main unit must be clear of large obstacles.
- Do not expose the remote control sensor to strong lighting, in particular, an inverter type fluorescent lamp. Otherwise, the remote controller may not work properly. If necessary, position the main unit away from direct lighting.

Names of parts and their functions

See the pages in parenthesis for details regarding operation.

Front panel

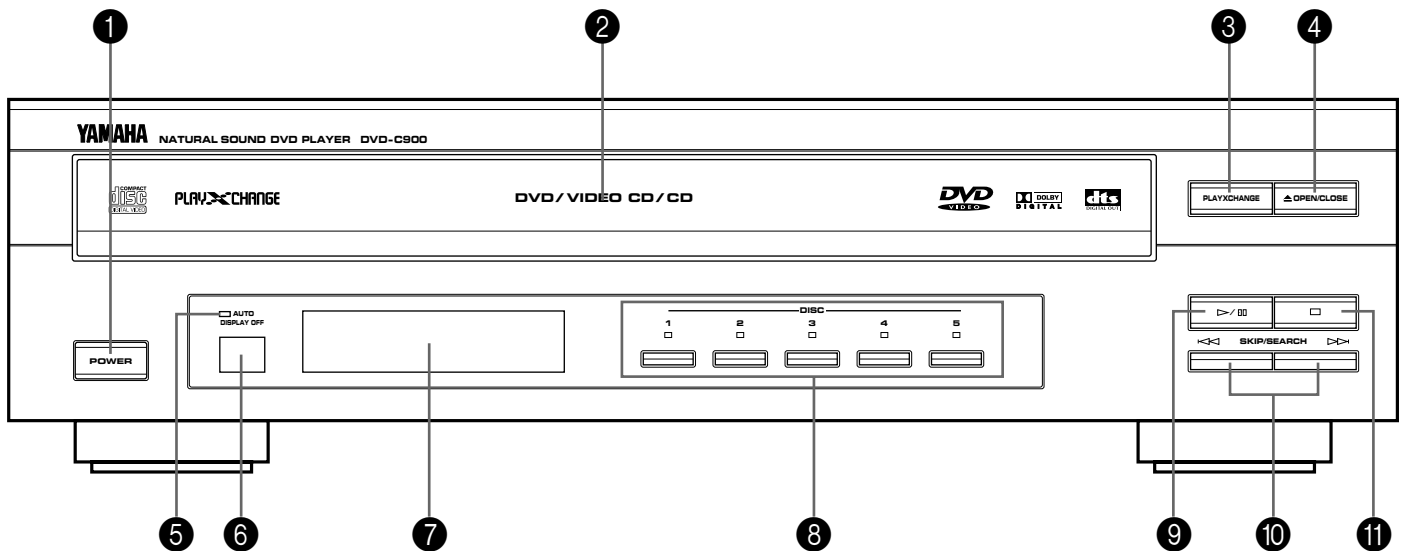

Remote controller

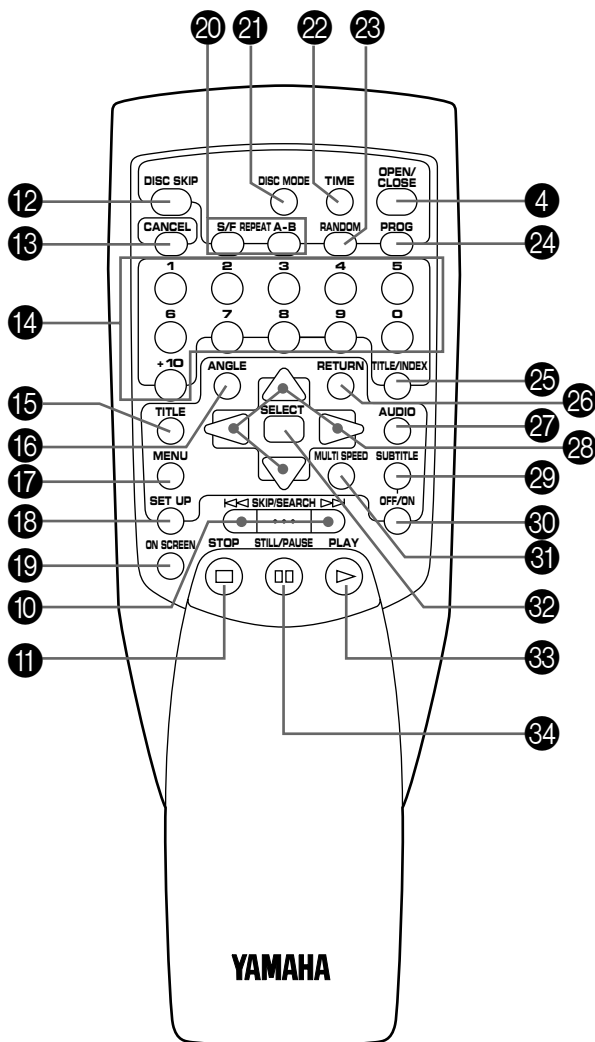

1 POWER switch (p. 16, 17)

Press this switch to turn on the power. Press this switch again to turn off the power.

2 Disc table (p. 16)

Up to 5 discs can be loaded on the disc table. Five disc-setting positions on the disc table are numbered from 1 to 5.

3 PLAYXCHANGE button (p. 18)

Press this button to open and close the disc table while playing a disc. This function enables you to exchange discs other than the one being played.

4 OPEN/CLOSE button (p. 16)

Opens and closes the disc table.

5 AUTO DISPLAY OFF Indicator (p. 57)

Lights up when "5 FL Dimmer" on the SET UP menu is set to "OFF".

6 Remote control sensor

Receives signals from the remote controller.

7 Display panel

See page 8.

8 DISC (1, 2, 3, 4, 5) buttons and indicators (p. 16, 18, 34)

Pressing a button selects the corresponding number of disc. The illumination of an indicator shows that the corresponding number of tray has a disc which this unit can playback.

9 ▷/⏸ (PLAY/PAUSE) button (p. 16, 21, 22, 32, 34, 36, 37)

Pressing this button starts playback. If this button is pressed during playback, playback is suspended or a picture is kept still, and if this button is pressed again, normal playback resumes.

10 SKIP/SEARCH buttons (p. 19, 22, 24, 25)**SKIP ▷▷ :**

Press this button to locate the beginning of the next chapter or next track.

SKIP ◀◀ :

Press this button to locate the beginning of the currently playing chapter or track, or the previous chapter or track.

SEARCH ▷▷ :

Press and hold this button to advance the playback rapidly.

SEARCH ◀◀ :

Press and hold this button to reverse the playback rapidly.

11 STOP (□) button (p. 17, 36, 37)

Stops playback.

12 DISC SKIP button (p. 16, 34, 37)

Whenever this button is pressed, the selected disc changes.

13 CANCEL button (p. 36)

Used to cancel some specific mode or setting of this unit. See the pages for operating methods for details.

14 Numeric buttons

(p. 17–21, 24, 34, 36, 40, 41, 44, 47, 50)

Used to select a title number, chapter number, track number, etc.

15 TITLE button (p. 40)

Press this button to display the title menu of a DVD disc on the monitor screen. For a disc which has no title menu, pressing this button is ineffective. For Video CDs and CDs, pressing this button is ineffective.

16 ANGLE button (p. 42)

Whenever pressed, the viewing angle of the picture changes. This button is effective only for scenes (on a DVD) which have some angles of view.

17 MENU button (p. 41)

Press this button to display the DVD menu of a DVD disc on the monitor screen. For a disc which has no DVD menu, pressing this button is ineffective.

18 SET UP button (p. 44)

Press this button to display the SET UP menu on the monitor screen.

19 ON SCREEN button (p. 29)

Press this button to turn on and off the OSD (On Screen Display) screen on the TV monitor. It gives you information about the current status of this unit and the selected disc.

20 S/F REPEAT button (p. 32)

Whenever you press this button, repeat play mode changes. The selected mode is shown on the front panel display for single or full repeat. This button also allows you to turn off the mode.

A/B REPEAT button (p. 33)

Makes this unit repeatedly play a section between 2 points (A and B) you designate on the disc.

21 DISC MODE button (p. 16, 37)

Changes the disc play mode between the single-disc play mode and the all-disc play mode. In the single-disc play mode, only a selected disc is played back. In the all-disc play mode, all discs on the disc table are played back sequentially.

22 TIME button (p. 27, 28, 34, 35)

Switches the time display mode.

23 RANDOM button (p. 37)

Press this button to play back titles or tracks on a designated disc or all discs on the disc table in a random order.

24 PROG button (p. 34)

Used for programming titles, tracks or a mixture of them in your desired order.

25 TITLE/INDEX button (p. 20, 21)

Whenever you press this button, search mode changes. The selected mode is shown on the monitor screen for title (or index) search or time search. This button also allows you to turn off the mode.

26 RETURN button (p. 17, 25, 44, 62)

Press this button to show the previous menu on the monitor screen.

27 AUDIO button**For DVDs (p. 39)**

Changes the audio sound track language if the selected DVD has two or more audio sound track languages.

For Video CDs and CDs (p. 26)

Changes the output mode of the audio signal output terminals. Every time this button is pressed, the output mode changes to "left channel only", "right channel only", "left and right channels", and repeated.

28 △/▽/◀/▷ (p. 17, 23, 40, 41, 44–62)

Move cursors or change selections on the monitor screen.

29 SUBTITLE button (p. 38)

Changes the subtitle language if the selected DVD has two or more subtitle languages.

30 (SUBTITLE) OFF/ON button (p. 38)

Turns on and off the showing of subtitles on the monitor screen.

31 MULTI SPEED button (p. 23)

Makes this unit enter into the multi-speed mode during playback. When this unit is stopped, pressing this button is ineffective.

32 SELECT button (p. 17, 40, 41, 44–62)

Activates the selected menu item or input value.

33 PLAY button (p. 16, 21, 22, 32, 34, 36, 37)

Starts playback.

34 STILL/PAUSE button (p. 21, 22)

Suspends playback temporarily or keep a picture still. Press the **PLAY** or ▷/■ button to return to the standard speed playback.

Front panel display

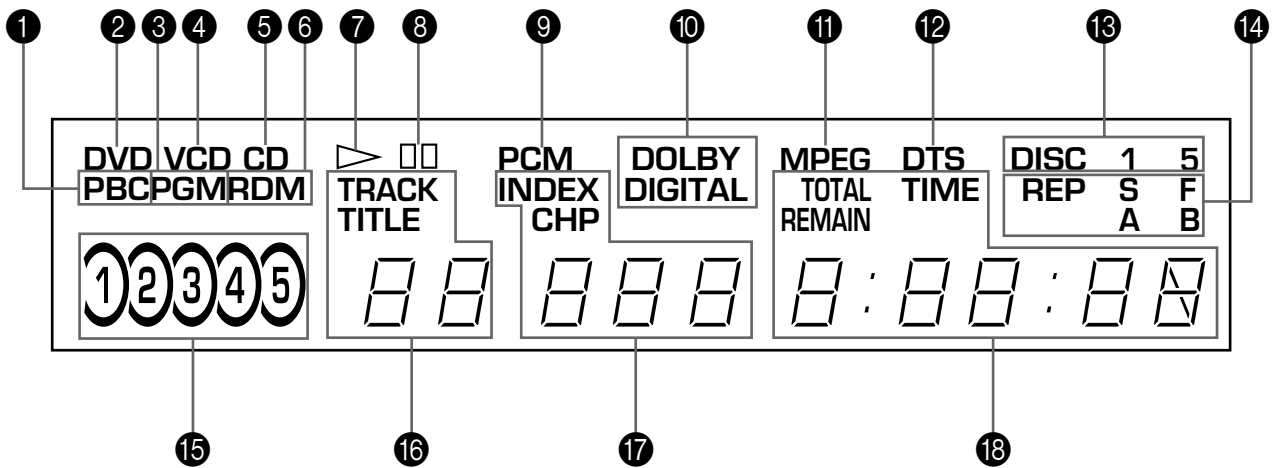

1 PBC

Lights up when this unit is in the Playback Control mode for playing a Video CD, version 2.0.

2 DVD

Lights up when the selected disc is a DVD.

3 PGM

Lights up when this unit is in the program play mode.

4 VCD

Lights up when the selected disc is a Video CD.

5 CD

Lights up when the selected disc is a compact disc.

6 RDM

Lights up when this unit is in the random play mode.

7 ▷

Lights up during playback.

8 ◻◻

Lights up while playback is paused.

9 PCM

Lights up when a source recorded in Linear PCM is played back.

10 DOLBY DIGITAL

Lights up when a source encoded with Dolby Digital is played back.

11 MPEG

Lights up when a source encoded with MPEG 1 or MPEG 2 is played back.

12 DTS

Lights up when a source encoded with DTS is played back.

13 DISC 1

Lights up when this unit is in the single-disc play mode.

DISC 5

Lights up when this unit is in the all-disc play mode.

14 REP S

Lights up when this unit is in the single-repeat play mode.

REP F

Lights up when this unit is in the full-repeat play mode.

REP A B

Lights up or flashes when this unit is in the A-B repeat play mode.

15

Tray numbers with discs only light up. The circle enclosing the currently selected tray number lights up.

16 TITLE

Lights up with the selected title number.

TRACK

Lights up with the selected track number.

17 CHP

Lights up with the selected chapter number.

INDEX

Lights up with the selected index number.

18 Shows a playing time, for example the elapsed time of a playing chapter and the remaining time (REMAIN) of a playing chapter.

Speaker setup

We recommend you to set up a multi-speaker system to enjoy the 5.1 channel surround sound of sources encoded with Dolby Digital, MPEG or DTS.

■ Speaker configuration

The most recommended speaker configuration is the 6 speaker configuration: 2 main speakers, 2 effect speakers, a center speaker and a subwoofer.

The main speakers are used for the main source sound. The effect speakers are used for the effect and surround sounds, and the center speaker is for the center sounds (dialog etc.). The subwoofer is for reinforcing low frequencies on your audio system and low frequency effect sounds of the subwoofer-channel.

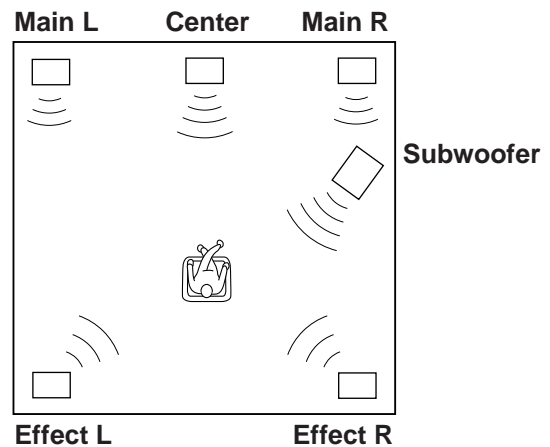

■ Placing speakers

- Main speakers:** On both sides of the TV and almost the same height as the TV.
- Effect speakers:** Behind your listening position, facing slightly inward. Nearly 1.8 m (approx. 6 feet) up from the floor.
- Center speaker:** Precisely between the main speakers. (To avoid interference with TV sets, use a magnetically shielded speaker.)
- Subwoofer:** The position of the subwoofer is not so critical because low bass tones are not highly directional.

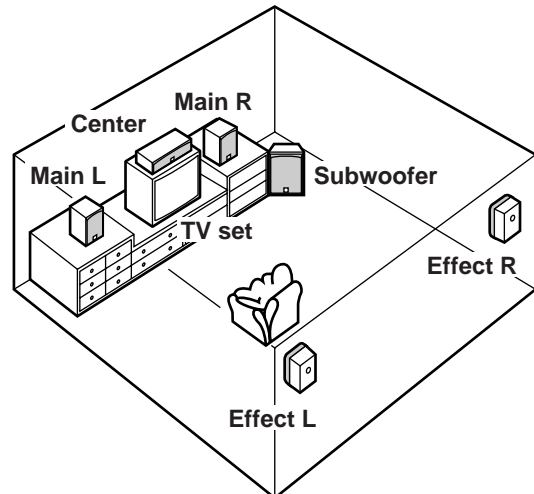

For China and General models only

This unit is designed to output signals of 5.1 channels efficiently according to your speaker system if you cannot set up a full 6 speaker configuration. It depends on the setting of "3 Speaker" on the SET UP menu. Refer to pages 62 to 63 for details. However, this setting is effective only on audio signals output from the 6CH DISCRETE terminals.

Caution: Plug in this unit and other components after all connections are completed.
 All connections must be correct, observing the color coding of terminals between this unit and other components.

Audio connections

■ Connecting to an AV amplifier (or receiver) equipped with a Dolby Digital, MPEG or DTS decoder, or connecting to a Dolby Digital, MPEG or DTS decoder

When you connect this unit to an AV amplifier or receiver equipped with a Dolby Digital, MPEG or DTS decoder, connect this unit's OPTICAL (or COAXIAL) terminal to the amplifier's optical (or coaxial) digital signal input terminal.

- * If the amplifier and Dolby Digital (or MPEG or DTS) decoder are separated, connect this unit's OPTICAL (or COAXIAL) terminal to the decoder's optical (or coaxial) digital signal input terminal.
- * When you use the Dolby Digital, MPEG or DTS decoder, be sure to use "1 Digital Output" on the SET UP menu of this unit to select the "Disc Original" mode for "Dolby Digital", "MPEG" or "DTS". (Refer to page 59 for details.)

Also, connect this unit's MIXED 2CH AUDIO OUT terminals to the amplifier's analog signal input terminals regardless of making the digital terminal connection. This is necessary for playing back a source in 2 channel stereo or with Dolby Pro Logic decoded.

A digital terminal connection is necessary between this unit and the amplifier (or decoder) for sending the playback signals of a source encoded with Dolby Digital, MPEG or DTS to the amplifier (or decoder). This connection allows you to enjoy a theater-like surround sound in your home.

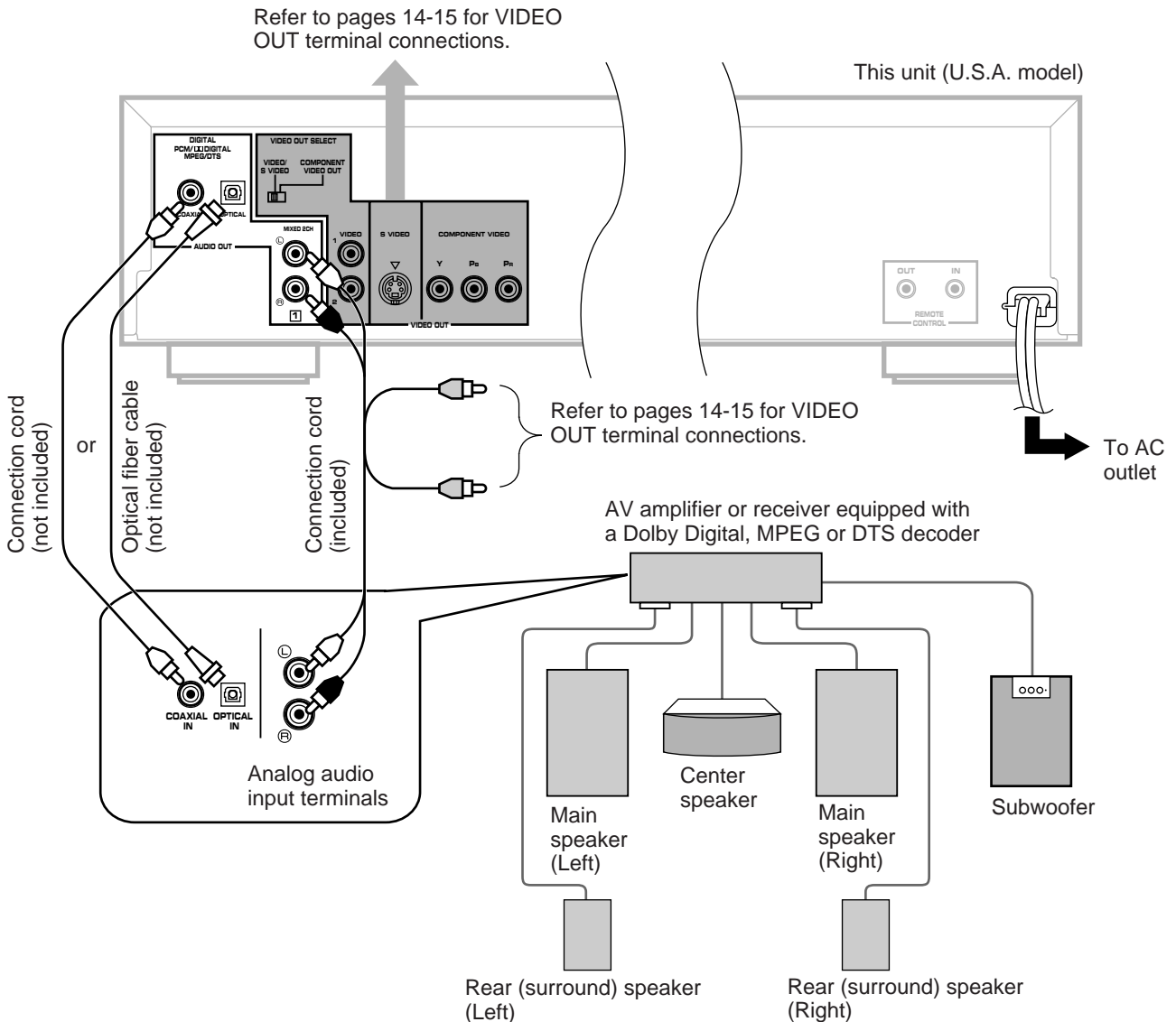

Notes on connecting to this unit's OPTICAL terminal

- Before using this terminal, remove the terminal's cover by pulling it.
- Make the connection from this terminal to the optical input terminal of an amplifier by using a commercially available optical fiber cable.
 - * Use an optical fiber cable that conforms to EIAJ standards. Other cables might not function correctly.
- Be sure to attach the terminal's cover when this terminal is not being used, in order to protect the terminal from dust.

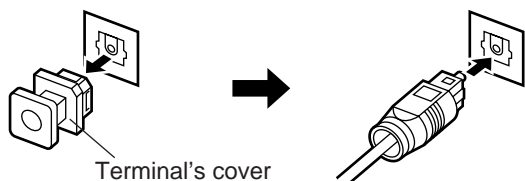

When you connect this unit's OPTICAL or COAXIAL terminal to the optical or coaxial digital input terminal of the amplifier which does not include a Dolby Digital, MPEG or DTS decoder

Use "1 Digital Output" on the SET UP menu to select the "PCM" mode for "Dolby Digital" and "MPEG", and select the "OFF" mode for "DTS". (Refer to page 59 for details.)

Digital signal output from this unit

For a DVD disc only, the format of digital signal output from this unit can be selected by the setting of "1 Digital Output" on the SET UP menu. (See page 59.)

Disc format	Audio format	Digital signal output from the OPTICAL and COAXIAL terminals of this unit	
		When "Disc Original" is selected on "1 Digital Output"	When "PCM" is selected on "1 Digital Output"
DVD	Dolby Digital	Dolby Digital bitstream (2–5.1ch)	PCM (2 ch) (48 kHz/16 bit)
		MPEG (2 or 1) audio	PCM (2 ch) (48 kHz/16 bit)
	DTS	DTS bitstream	No output
		Linear PCM (96 kHz)	Linear PCM (2 ch) (48 kHz)
	Linear PCM (48 kHz 16/20/24 bit)	Linear PCM (2 ch) (48 kHz 16/20/24 bit)	No output
		Linear PCM (2 ch) (44.1 kHz/16 bit)	No output
Video CD	MPEG 1 audio	PCM (2 ch) (44.1 kHz/16 bit)	
CD	Linear PCM	PCM (2 ch) (44.1 kHz/16 bit)	

For your reference:

- Linear PCM is a signal recording format used in CDs. While CDs are recorded in 44.1 kHz/16 bit, DVDs are recorded in 48 kHz/16 bit up to 96 kHz/24 bit.
- If you have a Dolby Pro Logic Surround decoder or your AV amplifier includes a Dolby Pro Logic Surround decoder, you will obtain the full benefit of Dolby Pro Logic from the same DVD movies that provide full 5.1-channel Dolby Digital sound tracks, as well as from titles with the Dolby Surround mark.
- Digital signal for linear PCM (48 kHz 20/24 bit) will be converted into 48 kHz 16 bit and will be output if a DVD you play back is formatted with code scramble system (copyright-protection).

■ Connecting to an AV amplifier (or receiver) equipped with 6 channel input terminals

For China and General models only

This unit includes a Dolby Digital decoder. This enables the playback of DVDs encoded with Dolby Digital without the need for an external Dolby Digital decoder. When this unit is connected to an AV amplifier with 6 channel input terminals, you can enjoy theater-like surround sounds in your home when playing back discs encoded with Dolby Digital.

Notes

- After connections are completed, change the settings of “3 Speaker” on the SET UP menu according to your speaker system. (See page 62.)
- When you play back a disc recorded in 2 channel stereo, the signals are output from the 6CH DISCRETE MAIN terminals only.
- You can also connect the OPTICAL or COAXIAL DIGITAL AUDIO OUT terminal to the amplifier if the amplifier has the corresponding digital input terminal(s).
If either of those terminals is connected to the amplifier which does not include a Dolby Digital, MPEG or DTS decoder, use “1 Digital Output” on the SET UP menu to select the “PCM” mode for “Dolby Digital” and “MPEG”, and select the “OFF” mode for “DTS”. (Refer to page 59 for details.)

Refer to pages 14-15 for VIDEO OUT terminal connections.

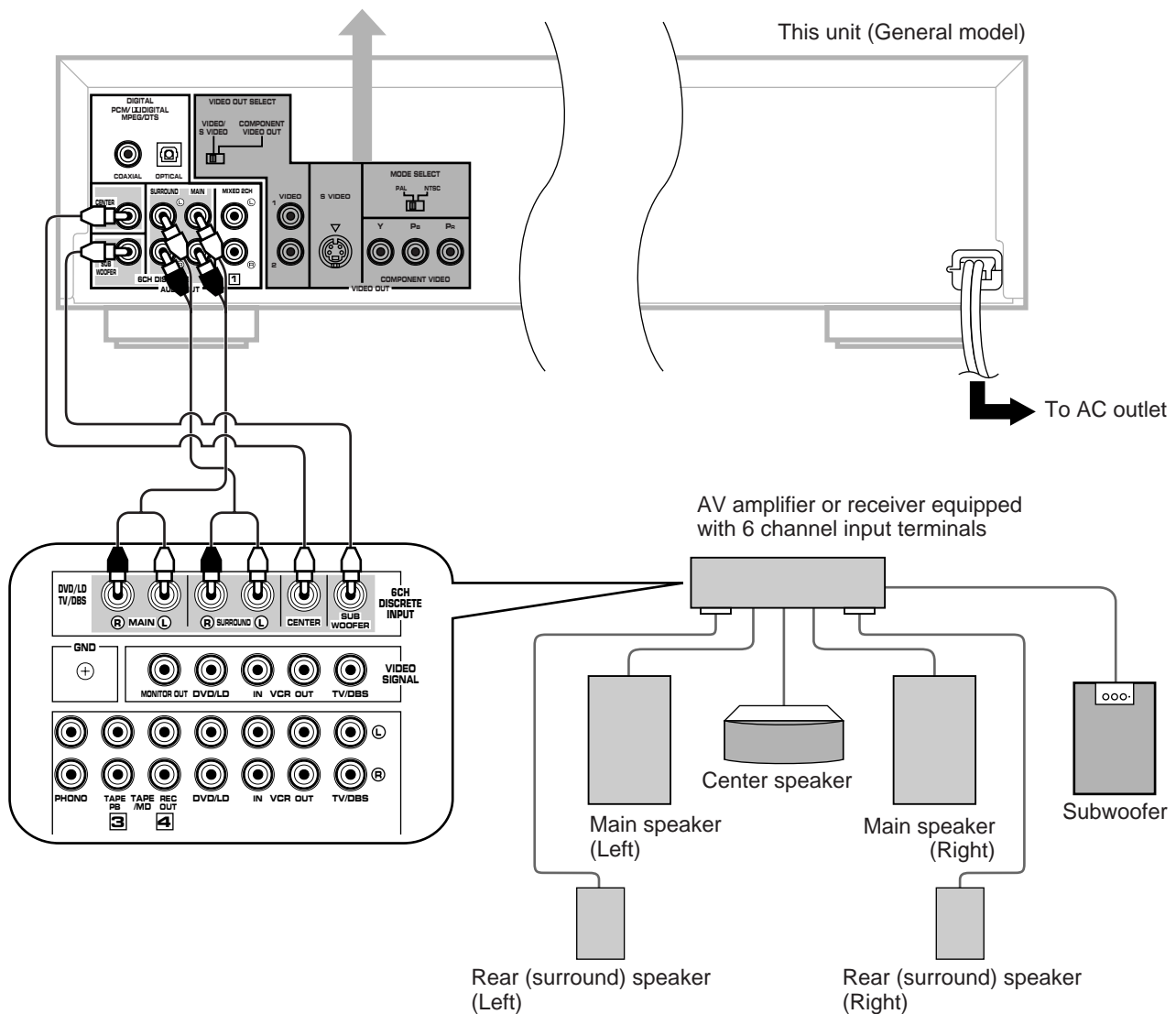

■ Connecting to a stereo amplifier that has neither 6 channel audio signal input terminals nor Dolby Digital decoder

Connect this unit's MIXED 2CH AUDIO OUT terminals to the amplifier's audio signal input terminal printed as "DVD", "VIDEO", "AUX", etc.

6 channel audio signals encoded with Dolby Digital are mixed down into 2 channels and output from the MIXED 2CH AUDIO OUT terminals.

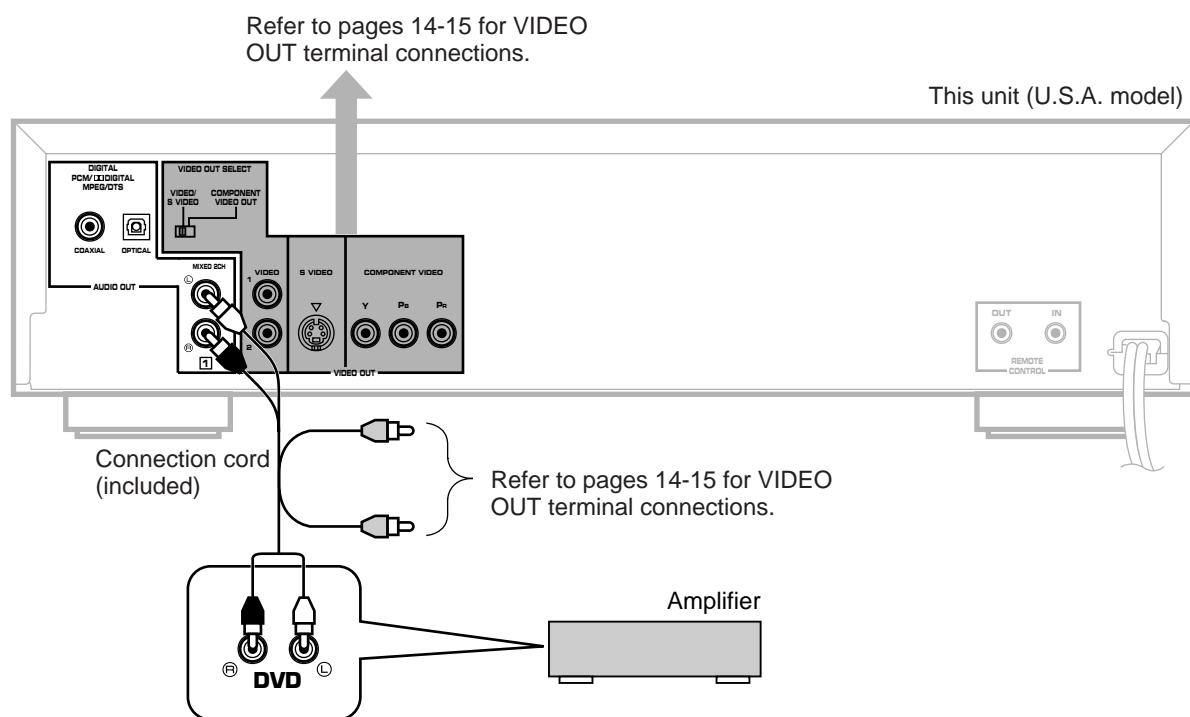

Note
If you have no stereo amplifier available, you can connect this unit's MIXED 2CH AUDIO OUT terminals to your TV's audio signal input terminals (if your TV is equipped with RCA type audio signal input terminals).

For Custom Installer For U.S.A. model only

REMOTE CONTROL (IN, OUT) terminals

These terminals are used for custom installation system. When this unit is connected to the components for custom installation system, you can operate this unit with the system remote control.

Connect the **REMOTE CONTROL IN** terminal of this unit to the output terminal of the central controller for custom installation system.

By connecting the **REMOTE CONTROL OUT** terminal of this unit to the REMOTE CONTROL IN terminal of the other component, you can also operate it with the system remote control. In this way, up to 6 components can be connected in series.

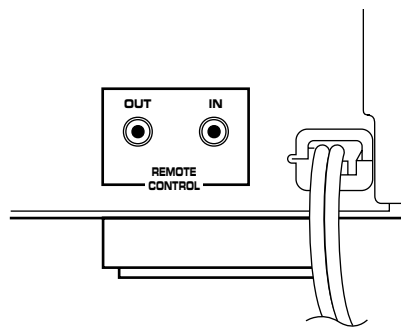

Video connections

■ Connecting to an amplifier equipped with an RCA type video signal input terminal (including an S-video input terminal)

Connect this unit's VIDEO 1 (or 2) terminal to the amplifier's RCA type video signal input terminal (labeled "DVD/LD" etc.). If your amplifier has an S-video input terminal, you can connect this unit's S VIDEO terminal to the amplifier's S-video input terminal by using a commercially available S-connector cable.

When the connection is made in one of these ways, **be sure to set the VIDEO OUT SELECT switch to the "VIDEO/S VIDEO" side.**

This unit has two VIDEO terminals. The other terminal can be connected to another amplifier or TV.

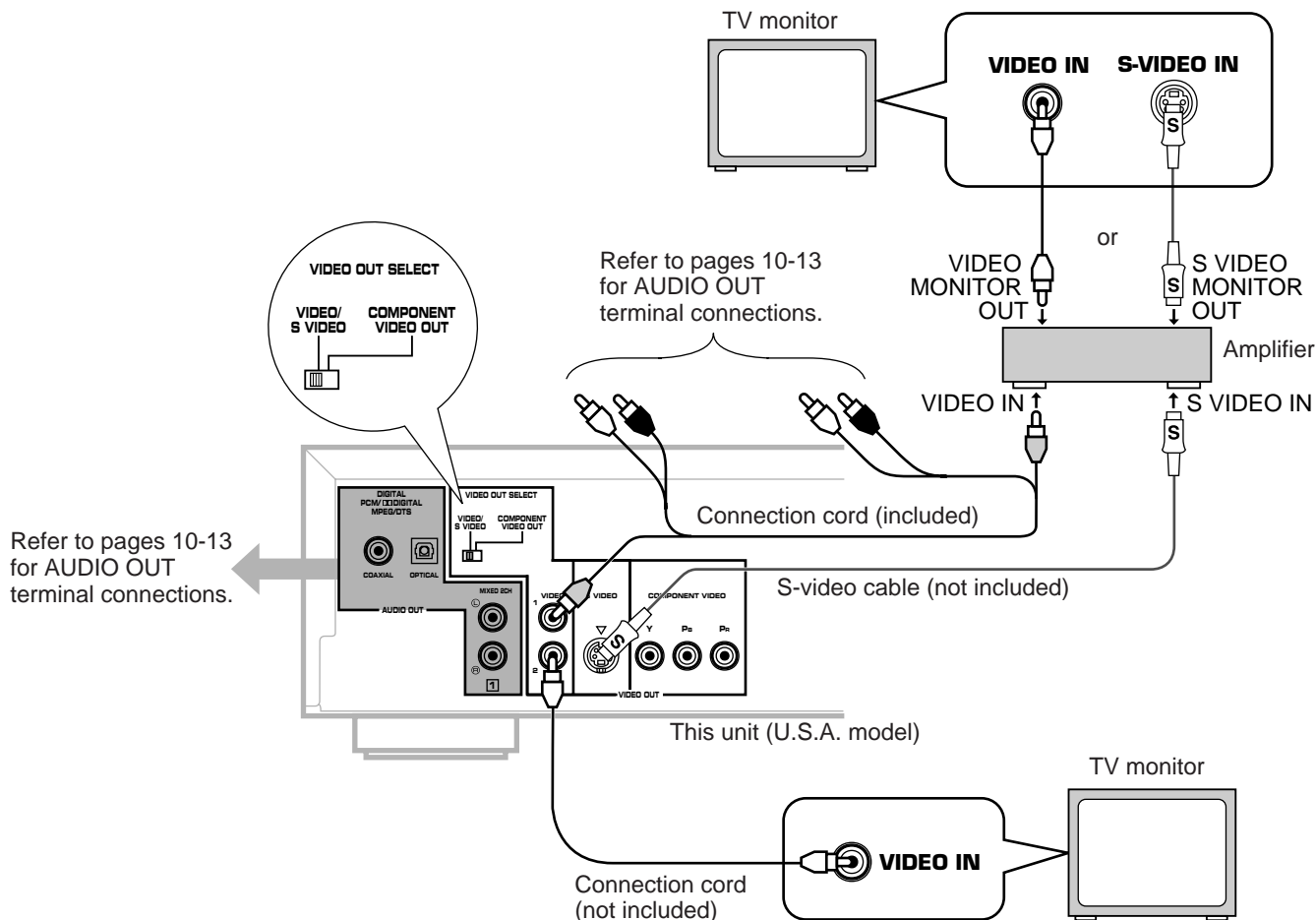

Notes

- If your TV has an RCA type video signal input terminal (including an S-video input terminal), this unit can be connected to the TV directly.
- Do not connect this unit to the TV through a video cassette recorder. Otherwise, the picture may not be played back normally with some DVDs. This is because the copyright protection circuit built-in this unit operates.
- **Be sure to change the setting of the VIDEO OUT SELECT switch only when this unit is turned off or the power cord of this unit is disconnected from the AC outlet.**

S VIDEO terminal

This unit provides you with a S VIDEO terminal in addition to standard type VIDEO terminals. The S VIDEO terminal transmits video signals separated into luminance (Y) signals and color (C) signals. High quality pictures are obtained from this terminal. In comparison with the S VIDEO terminal, standard type VIDEO terminals transmit "composite" video signals.

MODE SELECT (PAL/NTSC) switch <China and General models only>

This unit is designed for use with the NTSC and PAL television formats. Set this switch to the position for the format your TV monitor employs.

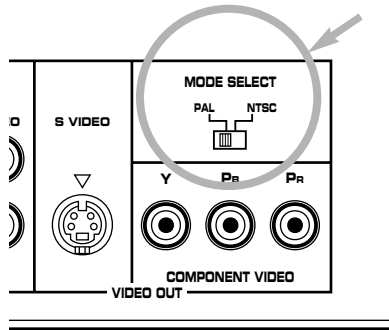

PAL: Set to this position if your TV monitor employs the PAL format.

NTSC: Set to this position if your TV monitor employs the NTSC format.

Notes

- **Be sure to change the setting of this switch only when this unit is turned off or the power cord of this unit is disconnected from the AC outlet.**
- If "6 Signal System Conversion" on the SET UP menu is set to "Disc", the setting of this switch becomes ineffective when a DVD or Video CD disc is played back. The format employed on the disc currently played back is automatically selected.

■ Connecting to a TV equipped with component video input terminals

You can connect this unit's COMPONENT VIDEO OUT terminals to your TV or projector, if your TV or projector has component video signal input terminals. The COMPONENT VIDEO OUT terminals output three types of chrominance signals separately. By this connection, you can enjoy high quality pictures with vivid colors.

If you make this connection, be sure to set the VIDEO OUT SELECT switch to the "COMPONENT VIDEO OUT" position.

Note

Do not connect this unit's COMPONENT VIDEO OUT terminals to component video input terminals special for HD (High-Definition) TV.

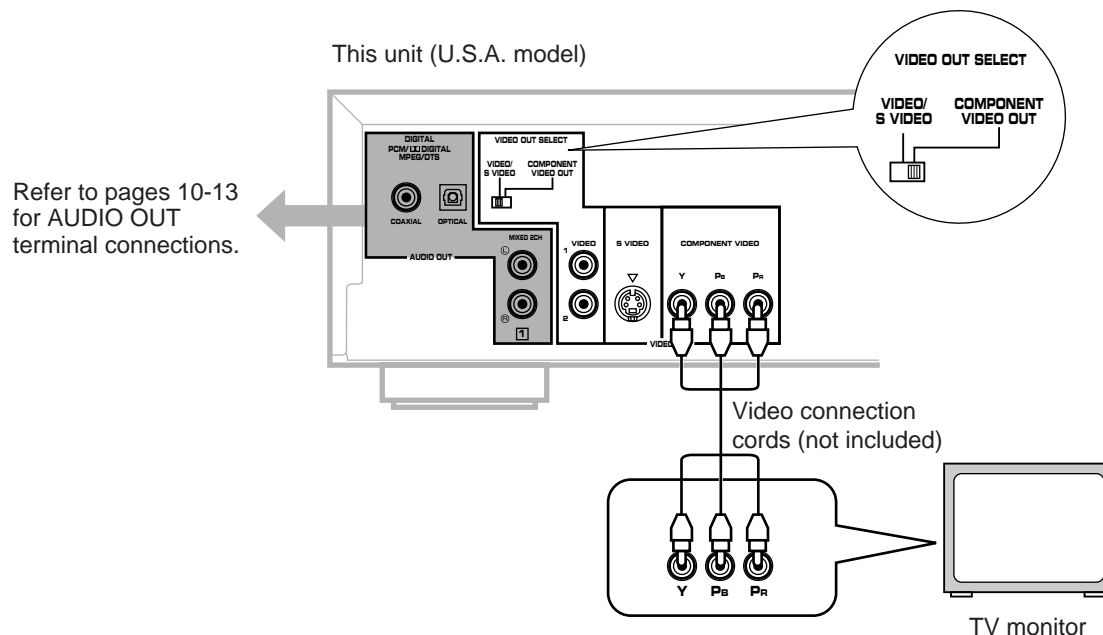

Basic operation

The On-Screen Display language of your model has been factory preset as follows:

U.S.A. and General models: English

China model: Chinese

If you would like to change the On-Screen Display language to another language, please refer to "OSD Language" on the SET UP menu on page 54.

Preparations

- If you play back a DVD or a Video CD, turn the TV on and make some setting changes on the TV if necessary.
- Turn on the power of your stereo system if this unit is connected to the stereo system.

Basic playback

- 1 Press **POWER** to turn on the power.
- 2 Press **OPEN/CLOSE** to open the disc table.
- 3 Place discs on the trays, label side upward.
 - * Up to five discs can be loaded on the trays. The trays are numbered 1 to 5.
 - * 8 cm (3") discs can be played back without an adaptor.
- 4 Press **OPEN/CLOSE** to close the disc table.
 - * The disc on the tray 1 is ready to be played back. Playback may begin automatically depending on some DVDs.
 - * If no disc is loaded on the disc tray 1, select another disc by following step 6.
- 5 If necessary, change the disc play mode (to "DISC 1" or "DISC 5") by pressing **DISC MODE** on the remote controller confirming it on the front panel display.
 - When "DISC 1" is illuminated:** Only a designated disc is played back.
 - When "DISC 5" is illuminated:** All discs on the disc table are played back sequentially.
- 6 If you want to select another disc, press **DISC SKIP** on the remote controller once or more, or press **DISC (1, 2, 3, 4 or 5)** on the front panel.
- 7 Press **PLAY** on the remote controller or **▶/⏪** on the front panel to begin playback.
 - * Playback begins.
 - * You can skip this step if the disc is already played back automatically.

When a screen menu appears on the monitor screen, go on to step 8.

In case of DVDs with menu or Video CDs with Playback Control, a screen menu appears on the monitor screen.

Example)

TITLE MENU	
1 Sights	3 Foods
2 Hotels	4 Souvenirs

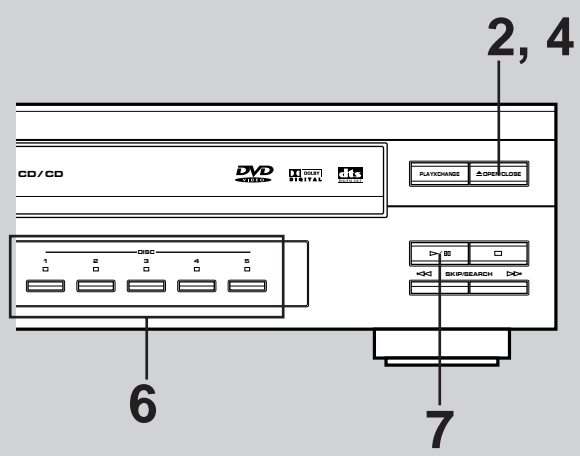
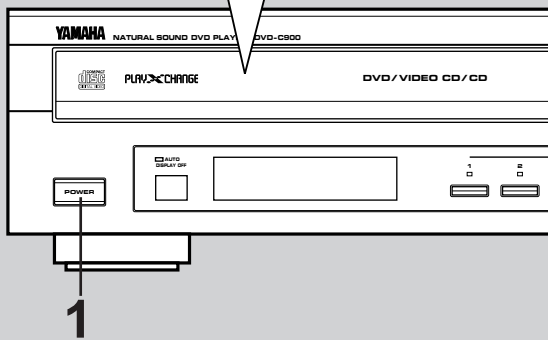
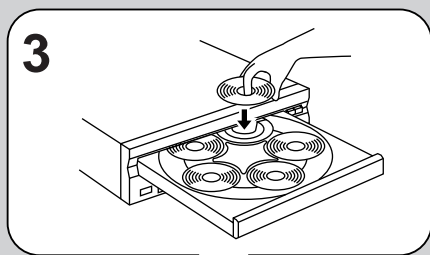
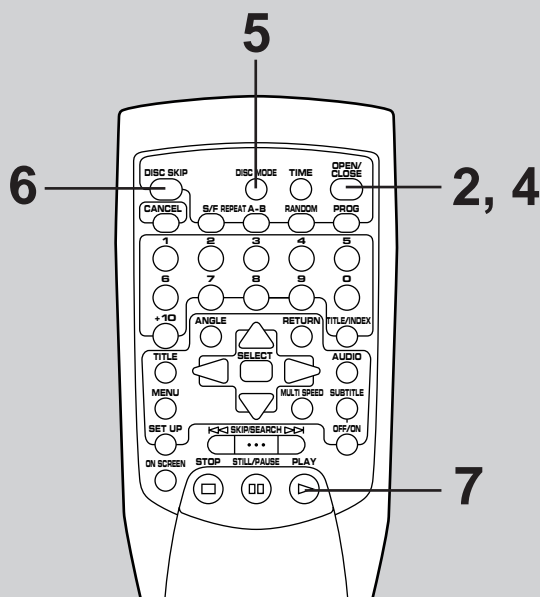

- 8 Select the preferred item by using $\Delta/\nabla/\triangleleft/\triangleright$ and then press **SELECT**, or select the item simply by pressing the corresponding numeric button(s).
* Refer to page 18 for how to use the numeric buttons.

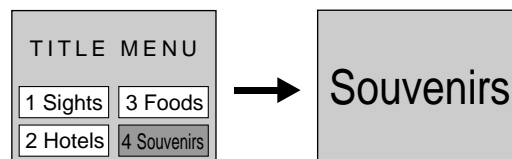

Playback of the selected item begins.

Note

For Video CDs, only the numeric buttons can be used to select the preferred item.

To stop playback and return to the screen menu

- **For DVDs**
Press **TITLE**, **MENU** or **RETURN**.
(The button to be used differs depending on the disc used.)
- **For Video CDs**
Press **RETURN**.

To stop playback

Press **STOP (□)**.

- * When playback is stopped, the unit memorizes the point where **STOP (□)** was pressed (**Playback Resumption**). Press **PLAY** again, and playback will resume from this point. When the table is opened or **STOP (□)** is pressed again, the memory will be cleared.

The **Playback Resumption** works only with discs for which playing time appears on the front panel display during playback.

This feature will not be cleared when the power is turned off.

Note

There may be a case that the **Playback Resumption** does not work depending on a part of the disc played back.

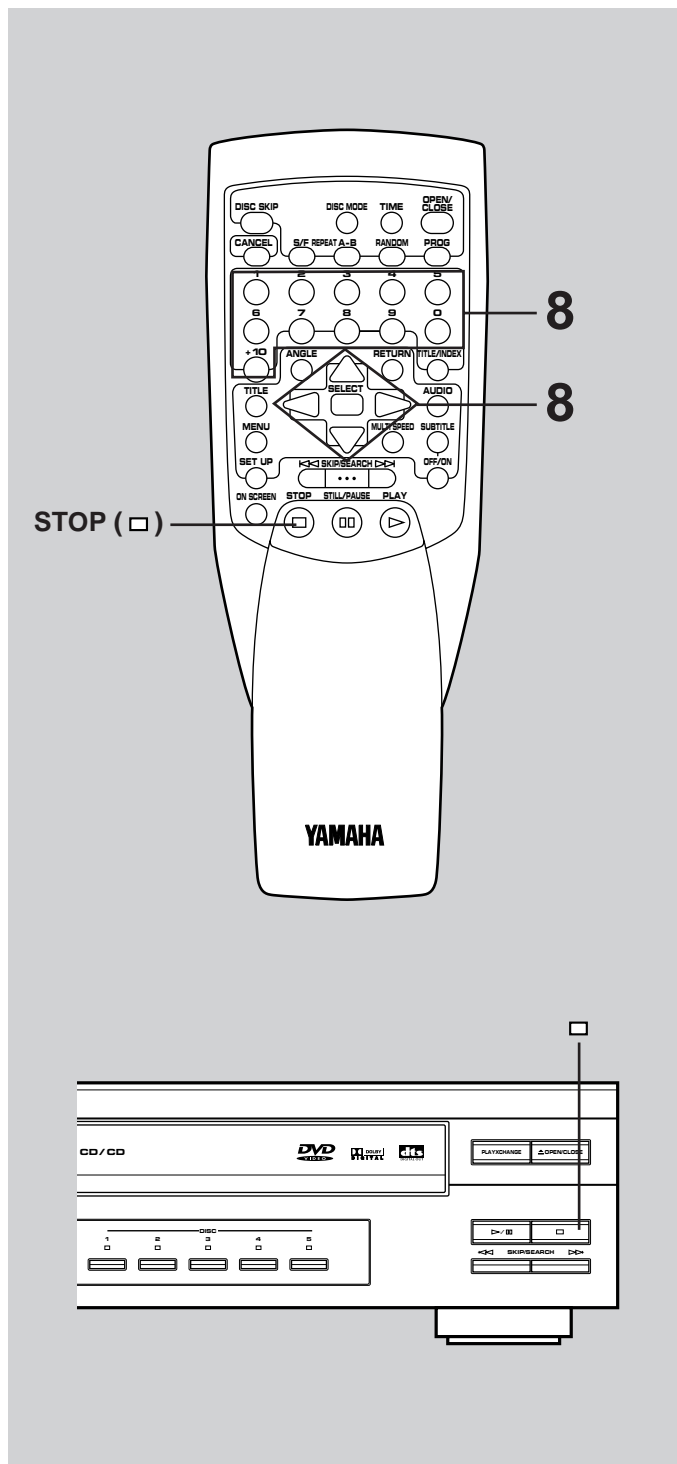

Direct playback

- Pressing **DISC** (1, 2, 3, 4 or 5) on the front panel will select the disc directly (even if the disc table is open), and playback will begin automatically.
- Even if the disc table is open, pressing **PLAY** will close the disc table and begin playback of the disc 1.

PLAYXCHANGE

During playback, you can open the disc table by pressing **PLAYXCHANGE** without interrupting playback. While **PLAYXCHANGE** is working, pressing **DISC SKIP** has no effect.

Note

You can load or replace discs on the trays when the disc table is opening, however, **never load a disc on the tray hidden inside the unit. In doing so, the disc and the unit may be damaged, because the tray already has a disc which is being played back.**

Automatic playback-starting function (for DVDs only)



If you load a disc which includes the information for automatic playback-starting, playback starts automatically without an operation of starting playback.

How to use the numeric buttons to select a number

(Example)

- To select number 8.
Press "8".
- To select number 10
Press "+10" and "0" in succession.
- To select number 15
Press "+10" and "5" in succession.
- To select number 26.
Press "+10" twice, then press "6".

Notes

- There may be a case that  appears on the monitor screen when a button is pressed. It means that the corresponding operation is prohibited by this unit or the disc currently played back.
- **For DVDs and Video CDs:**
The disc continues to rotate while the menu is displayed on the monitor screen even after the playback of an item is finished. If no further selection is to be played back, be sure to press **STOP** () to clear the menu.

Precautions

- Subjecting the unit to shock or vibration can cause mistracking.
- Do not pull open the disc table forcibly with your hands.
- Do not push the disc table while it is moving.
- The temperature range for playing back discs is recommended to be 5°C (41°F) – 35°C (95°F).

Front panel display information at basic playback

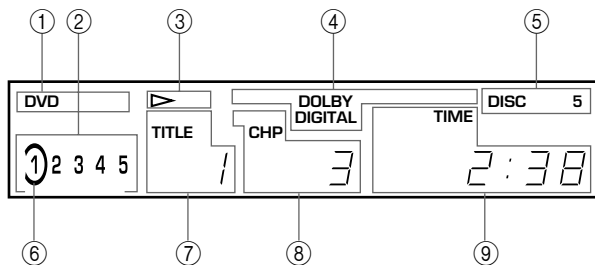

- ① Type of the selected disc
- ② Lights up the tray numbers with discs only.
- ③ "▶" lights up during playback and "⏸" lights up when the playback is paused.
- ④ Audio format of the played disc
- ⑤ Disc play mode
- ⑥ Encloses the tray number of the selected disc.
- ⑦ Shows the selected title (or track) number.
- ⑧ Shows the selected chapter (or index) number.
- ⑨ Shows the time displays. (Refer to "Switching the time display" on pages 27 to 28.)

Playing back a preferred scene or track

■ Beginning playback from a preferred chapter (or track)

You can select and play back a preferred chapter (for a DVD) or track (for a Video CD or CD) simply by entering its number with the numeric buttons.

* Refer to page 18 for how to use the numeric buttons.

Note

For Video CDs only:

This operation is ineffective when this unit is in the Playback Control mode.

For DVDs only:

Pressing “+10” may be ineffective when a title is changing. In this case, press **CANCEL** and try again.

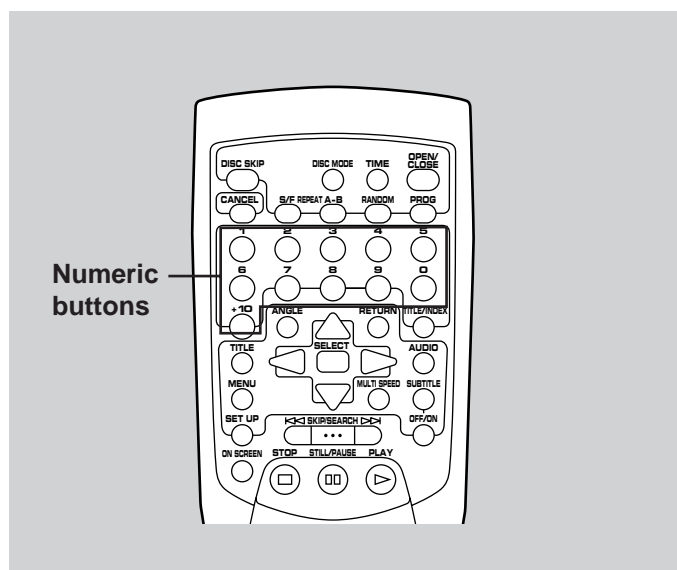

■ Skipping to a preferred chapter (or track) on the disc (Skip search)

The beginning of any chapter (for DVDs) or track (for Video CDs or CDs) can be found easily.

- 1 Select a disc and begin playback.
- 2 Press \triangleright to advance or \triangleleft to reverse through the title (or disc). Press once for each chapter (or track) to be advanced or reversed.
 - Press \triangleright once to advance to the next chapter (or track).
 - Press \triangleleft once to return to the start of the current chapter (or track).
 - Press \triangleleft once at the beginning of the current chapter (or track) to return to the chapter (or track) before the current chapter (or track).

Notes

- This function can also be performed while this unit is stopped. Press **PLAY** when your desired chapter (or track) number appears on the front panel display. Playback will begin from the beginning of the chapter (or track).
- This function will be performed forward or backward from any point on the title (or disc). However, it will not move forward during playback of the final chapter (or track).
- **For Video CDs only:**
 - * This operation is ineffective when this unit is in the Playback Control mode.
 - * \triangleleft and \triangleright are used in the Playback Control mode as the functions of “PREV” and “NEXT” respectively.

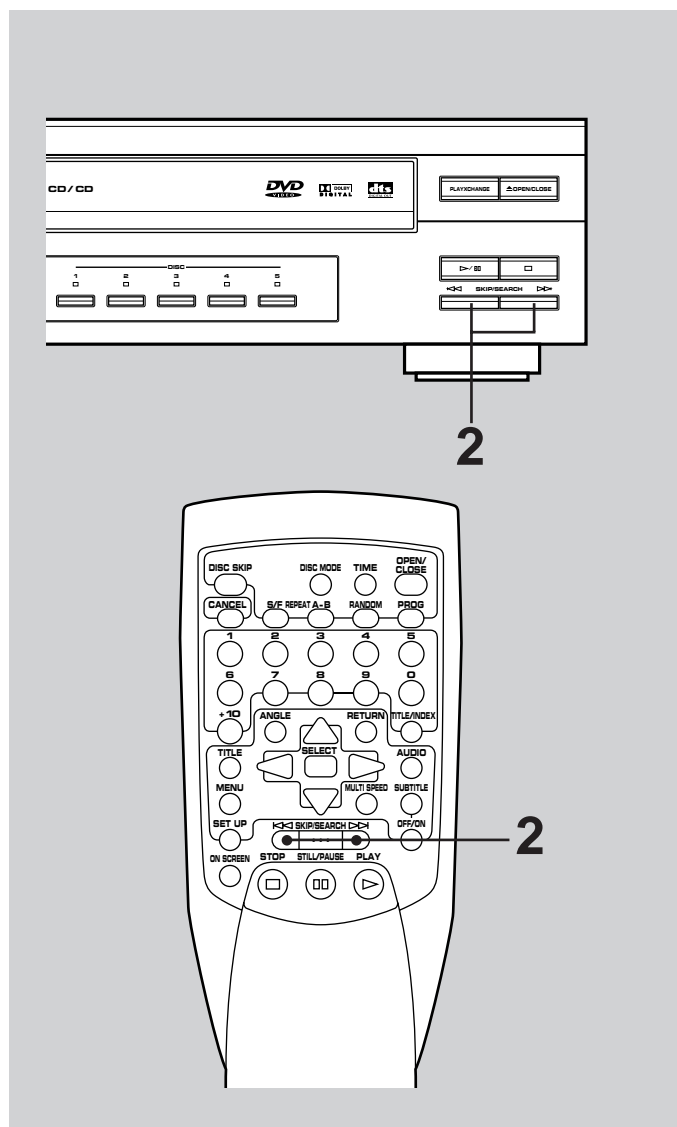

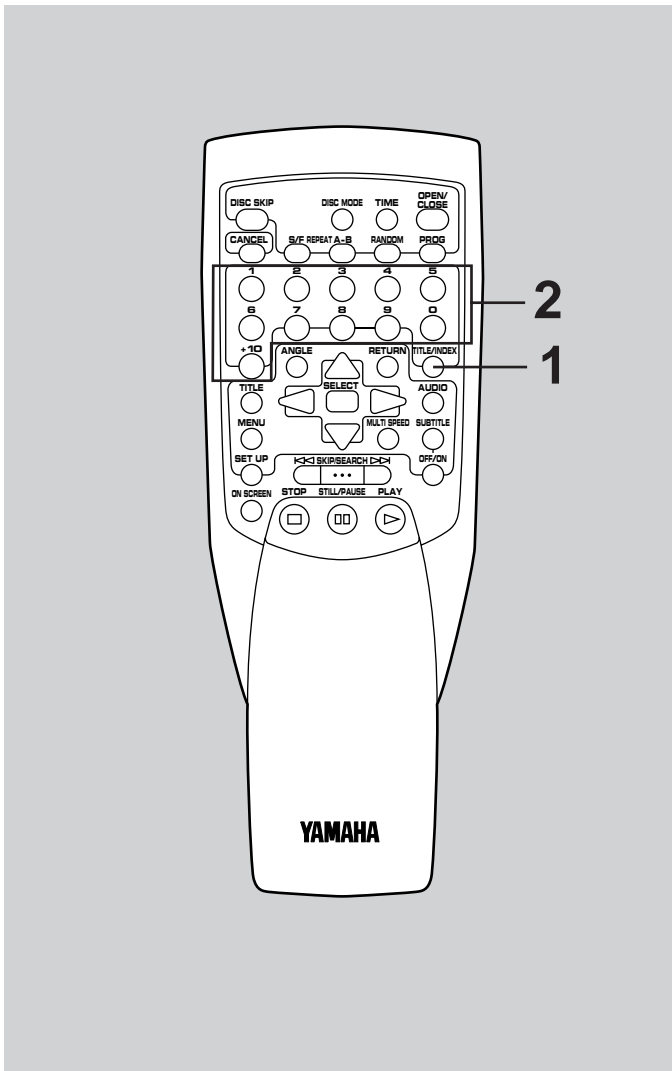

■ Beginning playback from a preferred title (for DVDs) or index number (for Video CDs/CDs)

For DVDs:

You can select any preferred title on the disc.

For Video CDs/CDs:

You can select any index number if the disc has index numbers.

1 Press **TITLE/INDEX** to select the title (index) search mode.

* "TITLE --" (or "INDEX ---") appears on the monitor screen.

* Every time **TITLE/INDEX** is pressed, the search mode changes as follows.

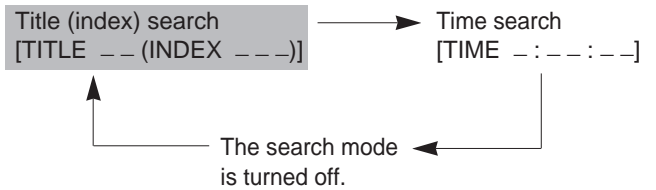

2 Enter the preferred title (or index) number with the numeric button(s).

* Playback begins from the selected number.

Note

For DVDs only:

Depending on the disc used, it may not be possible to perform this search operation.

How to use the numeric buttons to select a number (Example)

- To select number 8.
Press "8".
- To select number 10
Press "+10" and "0" in succession.
- To select number 15
Press "+10" and "5" in succession.
- To select number 26.
Press "+10" twice, then press "6".

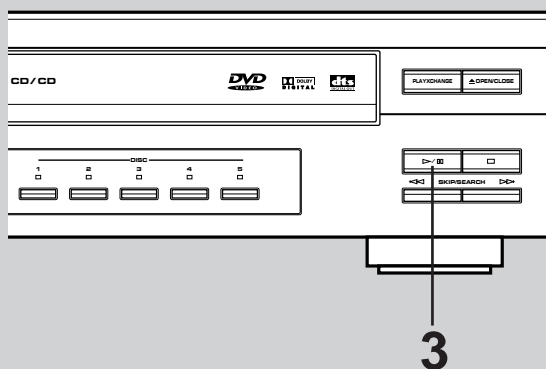
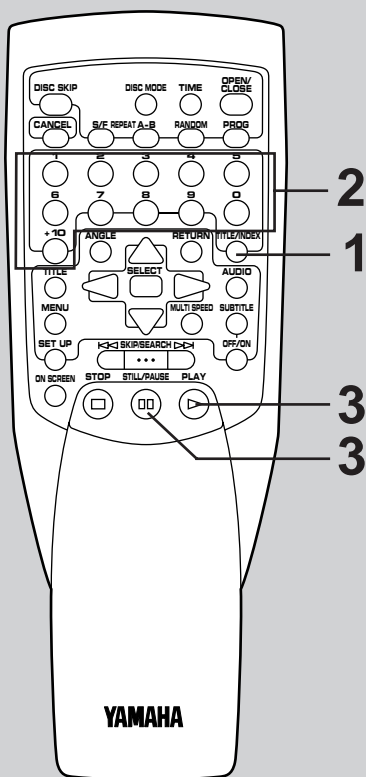

■ Beginning playback from a preferred time point on the title (or disc)

You can locate a preferred time point on the title (or disc) by designating the time, and begin playback from the point or suspend playback at the point.

- 1 Press **TITLE/INDEX** once or more to select the time search mode.

* "TIME -- : -- : --" appears on the monitor screen.

* Every time **TITLE/INDEX** is pressed, the search mode changes as follows.

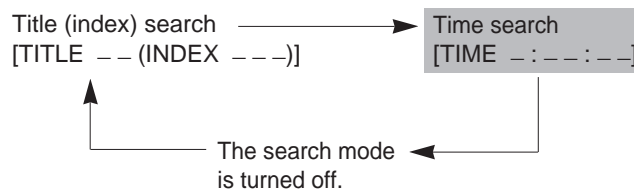

- 2 Enter the preferred time with the numeric button(s).
- 3 Press **PLAY** to begin playback from the time point.
Press **STILL/PAUSE** to suspend playback at the time point.

Notes

- If the time longer than the total play time of the title (or disc) is entered, the operation will be canceled.
- **For DVDs only:**
 - * Depending on the disc used, it may not be possible to perform this search operation.
 - * Depending on the disc used, playback may not begin from the specified time point even when the operation have been performed correctly.
 - * This search operation may be ineffective when a title is changing. In this case, press **CANCEL** and try again.
- **For Video CDs only:**
This search operation cannot be made when this unit is in the Playback Control mode.

How to use the numeric buttons to enter the time (Example)

- To enter 45 minutes and 23 seconds
Press "4", "5", "2" and "3" sequentially.
- To enter 2 hours, 15 minutes and 10 seconds
Press "2", "1", "5", "1" and "0" sequentially.

Other ways of playback

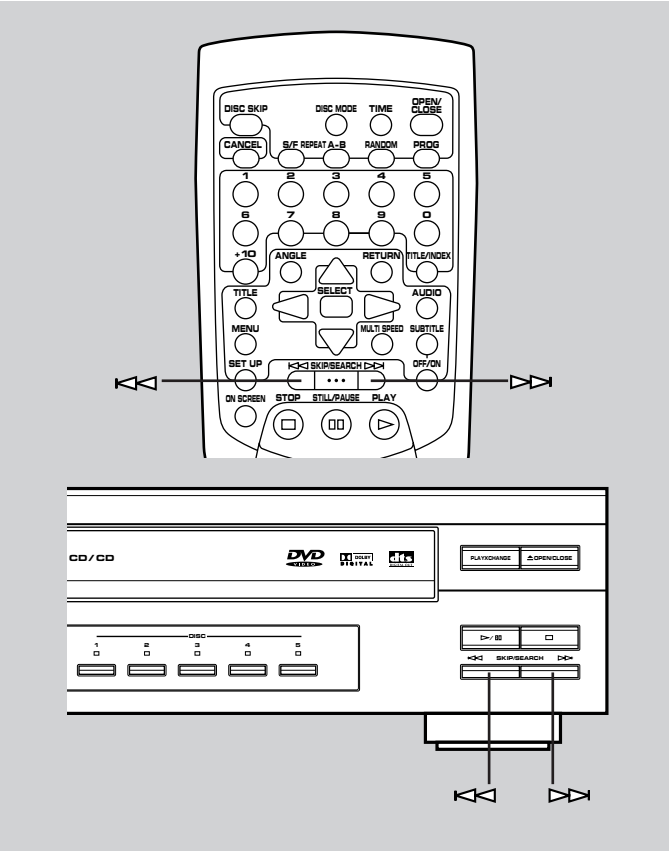

To advance or reverse playback rapidly (Rapid search)

During playback, press and hold **▷▷** to advance playback rapidly, and **◀◀** to reverse playback rapidly.

Notes

- The rapid search can also be performed while playback is paused.
- When using **▷▷** or **◀◀**:
Be careful not to release the button just after it is pressed, otherwise the play is skipped to the beginning of the next chapter (or track) or returned to the beginning of the current chapter (or track).
- **For Video CDs and CDs only:**
The sound can be heard (although slightly garbled) during the rapid search in either direction. This is convenient for locating a precise position within the disc, or for reviewing the contents quickly. However, no sound will be heard if the rapid search is performed while playback is paused.

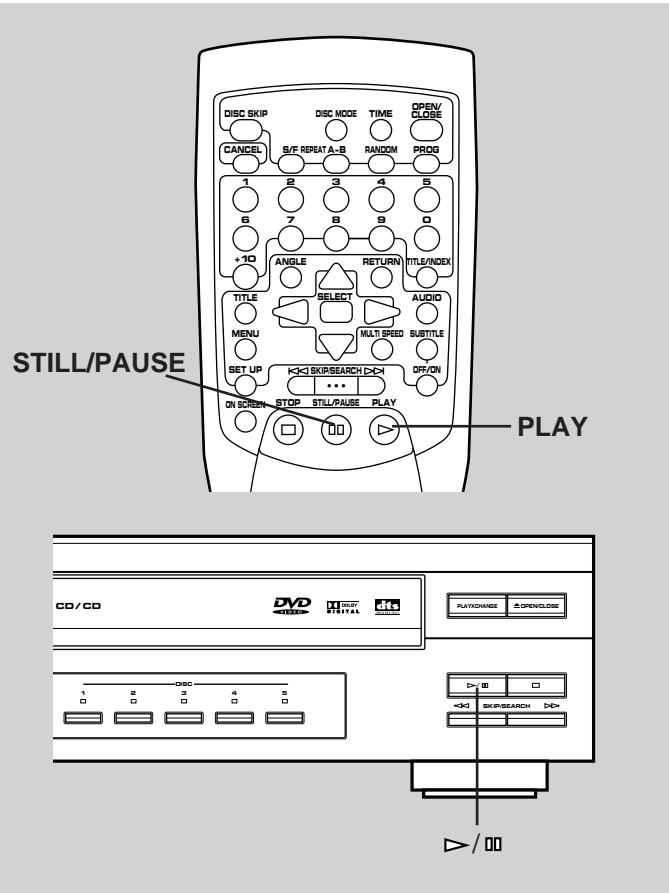

To still picture (or suspend playback)

Press **STILL/PAUSE** (or **▷/▣**) during playback.

- **For DVDs/Video CDs:**
This unit turns into the still picture mode.
* This operation is ineffective when playing back a still picture which is originally contained in the disc.
- **For CDs:**
This unit turns into the pause mode.

To restore normal playback

Press **PLAY** (or **▷/▣**).

Frame advance [DVD and VCD only]

Press **STILL/PAUSE** repeatedly in the still picture mode.

Picture is advanced by one frame every time the button is pressed.

To restore normal playback

Press **PLAY** (or **▷/▣**).

■ To advance or reverse playback in a preferred speed (Multi-speed playback) [DVD and VCD only]

You can change the playback speed in 6 steps (slowly or rapidly).

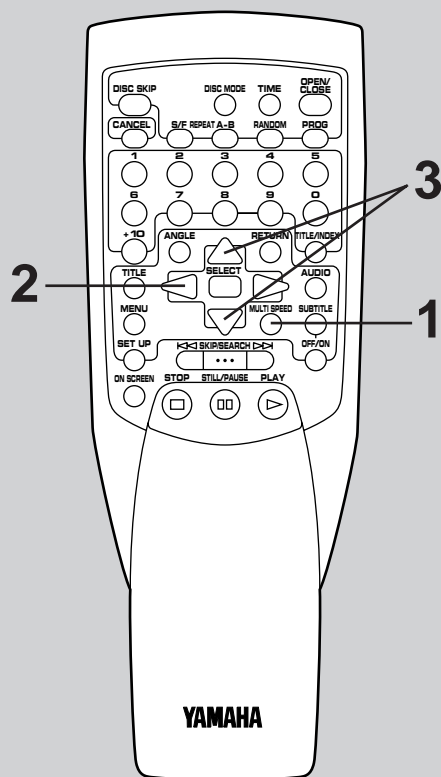

1 Press **MULTI SPEED** during playback.

* This unit turns into the still picture mode.

2 If you want to reverse playback, press \triangleleft .

3 Press \triangle or ∇ once or more to select the desired speed.

* Every time a button is pressed, the speed changes as follows:

For DVDs

- When playback is advanced

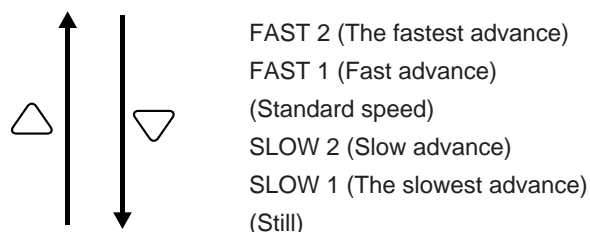

- When playback is reversed

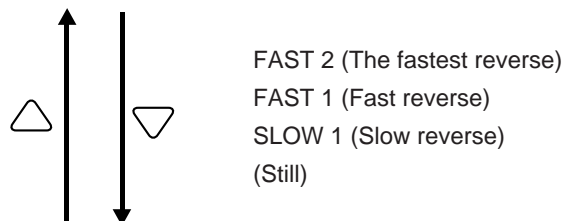

For Video CDs

- When playback is advanced

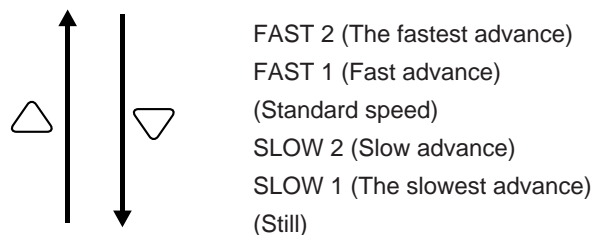

- When playback is reversed

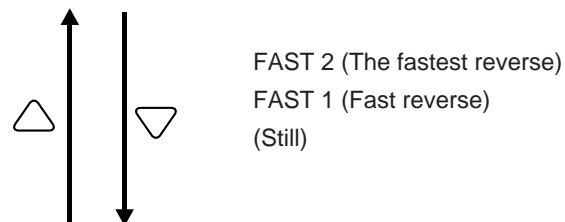

Note

In the still mode, pressing \triangleright advances and \triangleleft reverses playback by one frame.

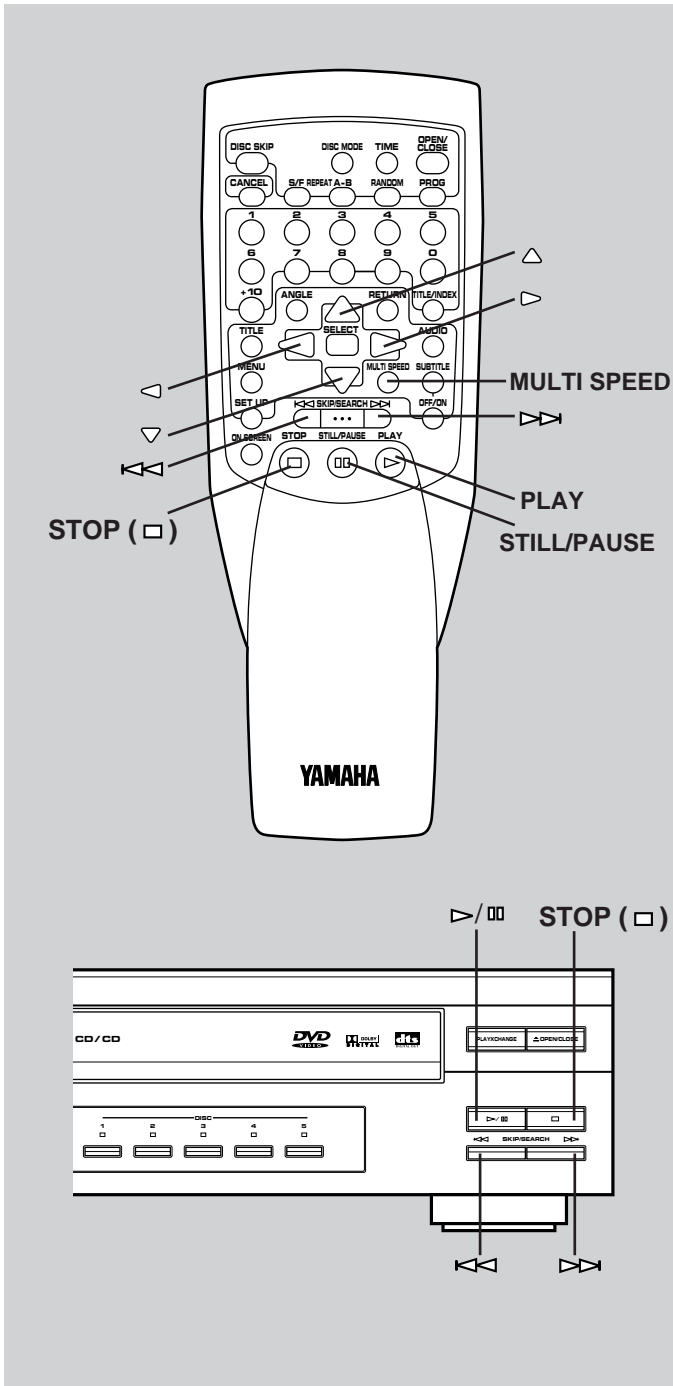

If you want to change the playback direction during playback in a slow or rapid speed

1. Press \triangleright to advance playback, or \triangleleft to reverse playback.
2. Press \triangle or ∇ to select the desired speed.

To cancel the multi-speed playback mode.

Press one of the following buttons.

- On the remote controller:
PLAY, MULTI SPEED, STILL/PAUSE, $\triangleright\triangleright$, $\triangleleft\triangleleft$
- On the front panel:
 \triangleright/\square , $\triangleright\triangleright$, $\triangleleft\triangleleft$
- Press **STOP (□)**.

Notes

- No sound will be heard during this operation.
- For Video CDs, reverse playback cannot be made in slow speed and also by one frame.

Operations unique for a Video CD in the Playback Control mode [VCD only]

If "PBC" is illuminated on the front panel display when a Video CD is played back, this unit is in the Playback Control mode. In this mode, a screen menu appears on the monitor screen after the playback begins.

To select the preferred item on a screen menu
Press the corresponding numeric button(s). The Playback of the item begins.

* Refer to page 18 for how to use the numeric buttons.

If the disc has two or more menus;

Press \blacktriangleright to go on to the next menu.

(Press \blacktriangleleft to return to the previous menu.)

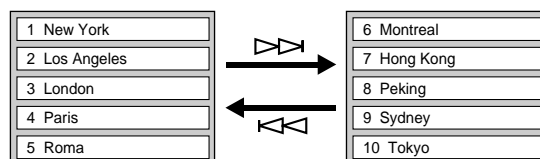

* For some discs, the next screen menu may appear before beginning playback. In that case, select the preferred item again.

To skip to the preferred item (or screen menu) during playback (or being paused)

- Pressing \blacktriangleright locates the beginning of the next item or the next screen menu.
- Pressing \blacktriangleleft locates the beginning of the previous item or the previous screen menu.

To return to the previous screen menu

Press **RETURN**.

* To return to the first screen menu, press **RETURN** repeatedly until the first menu appears.

Note

Disc play in the Playback Control mode depends on the data of the disc used. So, depending on the contents of disc, the above operating method may not be applied to the disc. Be sure to refer to the instruction manual for the disc.

To enjoy Video CDs with the Playback Control turned off

- Change the setting of "1 Playback Control" on the SET UP menu to "OFF". Refer to page 52 for details. Video CDs can be played back in normal playback mode.
- When playback is stopped in the Playback Control mode, making a track search operation cancels the Playback Control mode.

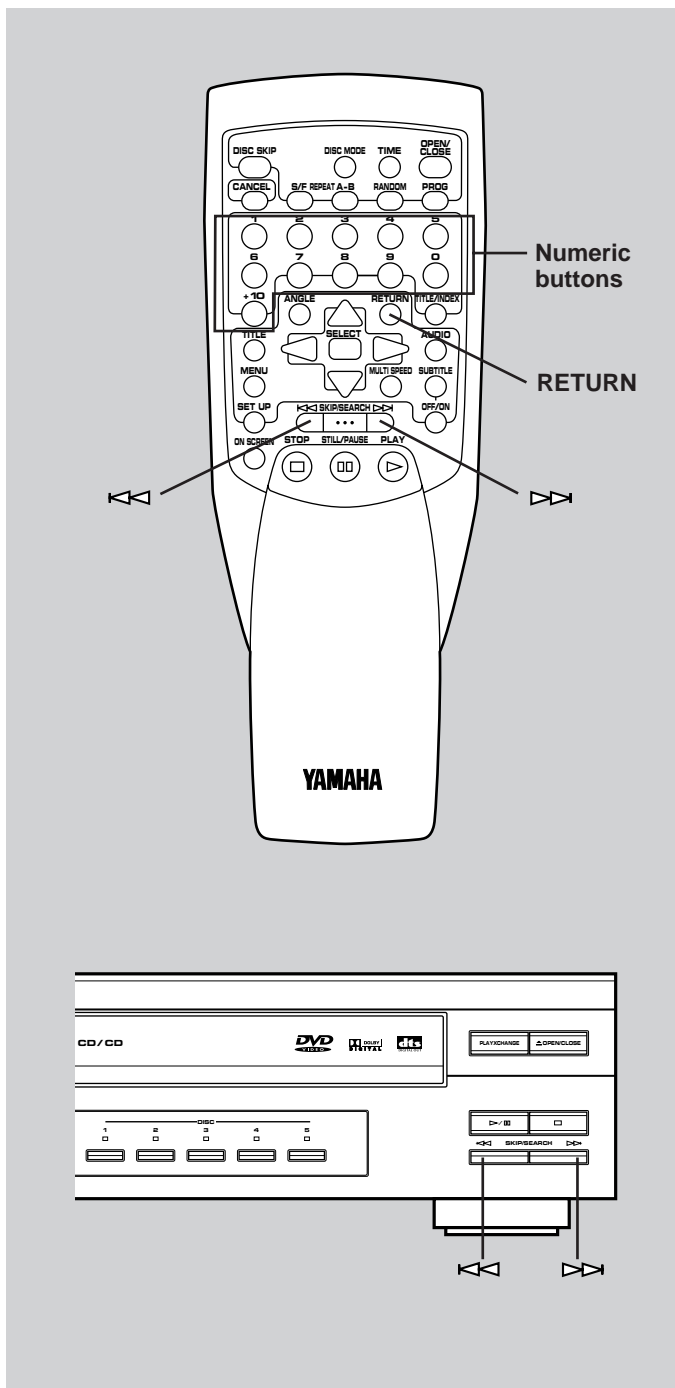

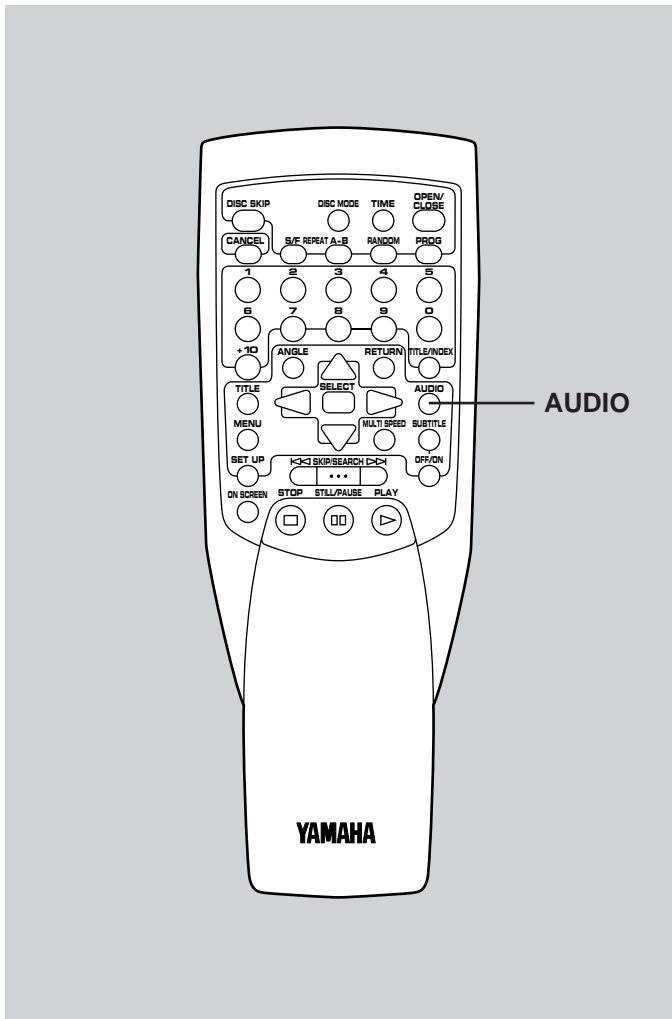

■ Changing the audio output mode (to enjoy using a multisound disc etc.) [VCD and CD only]

You can change the output mode of the MIXED 2CH left and right audio output terminals of this unit. This operation is useful when playing back a multisound karaoke disc etc.

* **<For China and General models only>**

This setting also applies to the 6CH DISCRETE MAIN left and right audio output terminals.

Press **AUDIO** once or more.

* Every time **AUDIO** is pressed, the output mode changes. The current output mode is displayed on the monitor screen and the mode changes among "L", "R" and "Stereo".

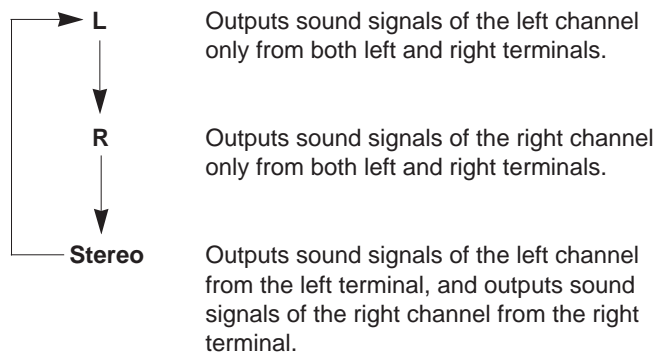

Factory default setting: Stereo

Notes

- This operation also applies to the output mode of the OPTICAL and COAXIAL DIGITAL output terminals of this unit.
- This operation is only effective when playing back a Video CD or CD.
- The output mode is always returned to "Stereo" when you turn on this unit.

Switching the time display

Every time **TIME** is pressed, the front panel display changes as described below.

For DVDs:

[Example]

When the second chapter of the first title is being played back. (Refer to the illustration on the left.)

- ① The elapsed play time for the chapter being played back will be displayed.
* 8 seconds have passed from the beginning of the second chapter.
- ② The remaining play time for the current chapter will be displayed.
* 10 minutes and 58 seconds remain to the end of the second chapter.
- ③ The elapsed play time of the title being played back will be displayed.
(If the unit is in the program play mode, the total elapsed play time of the programmed selections will be displayed.)
* 1 hour, 23 minutes and 45 seconds have passed from the beginning of the title.
- ④ The remaining play time for the current title will be displayed. (If the unit is in the program play mode, the total remaining play time of programmed selections will be displayed.)
* 1 hour and 41 seconds remain to the end of the title.

Note

During random play, only the elapsed play time and remaining play time of the current title will be displayed.

The diagram illustrates the sequence of four display screens (1-4) and the front panel control layout. Screen 1 shows elapsed time (0:08). Screen 2 shows remaining time (10:58). Screen 3 shows total elapsed time (1:23:45). Screen 4 shows total remaining time (1:00:41). The front panel shows the TIME button being pressed.

①

DVD	TITLE	PCM	CHP	TIME	DISC 1
1 2 3 4 5	1	2		0:08	

②

DVD	TITLE	PCM	CHP	REMAIN	TIME	DISC 1
1 2 3 4 5	1	2		10:58		

③

DVD	TITLE	PCM	CHP	TOTAL TIME	DISC 1
1 2 3 4 5	1	2		1:23:45	

④

DVD	TITLE	PCM	CHP	TOTAL TIME	REMAIN	DISC 1
1 2 3 4 5	1	2		1:00:41		

TIME

The front panel control layout includes buttons for DISC SKIP, DISC MODE, TIME, OPEN/CLOSE, CANCEL, S/F REPEAT A-B, RANDOM, PROG, 1-5, 6-0, ANGLE, RETURN, TITLE/INDEX, TITLE, MENU, BET UP, SKIP/SEARCH, and OPTION.

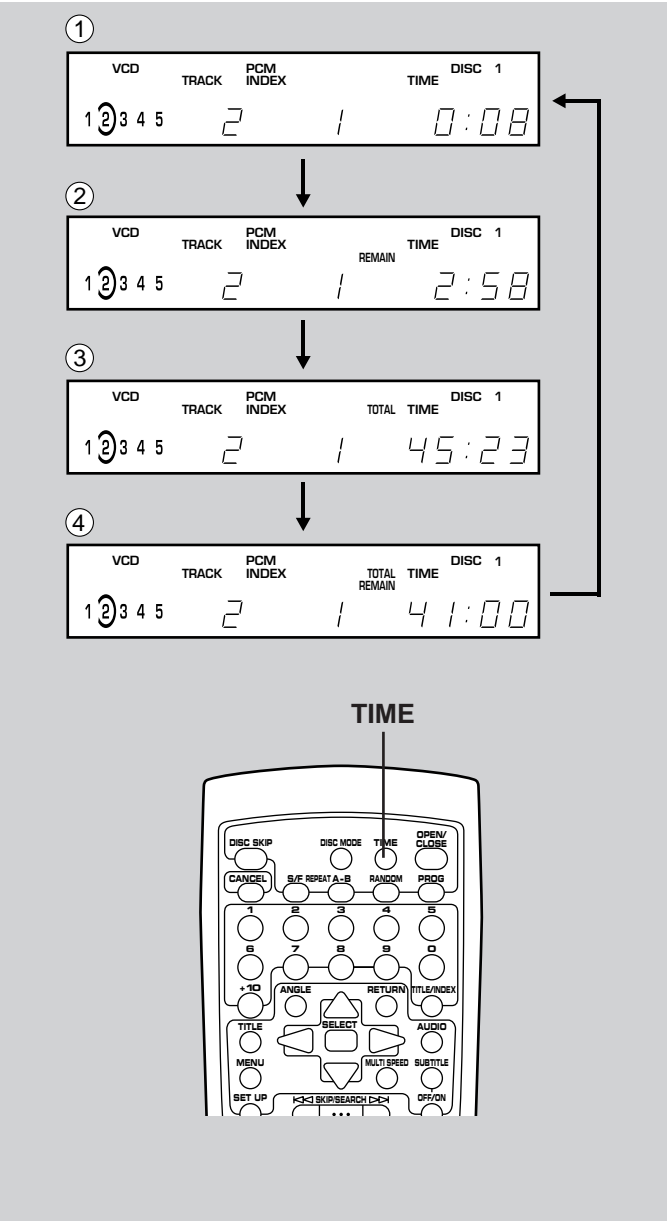

For Video CDs/CDs:

[Example]

When the second track is being played back. (Refer to the illustration on the left.)

- ① The elapsed play time for the track being played back will be displayed.
* 8 seconds have passed from the beginning of the second track.
- ② The remaining play time for the current track will be displayed.
* 2 minutes and 58 seconds remain to the end of the second track.
- ③ The elapsed play time of the disc being played back will be displayed.
(If the unit is in the program play mode, the total elapsed play time of the programmed selections will be displayed.)
* 45 minutes and 23 seconds have passed from the beginning of the disc 2.
- ④ The remaining play time for the current disc will be displayed. (If the unit is in the program play mode, the total remaining play time of programmed selections will be displayed.)
* 41 minutes remain to the end of the disc 2.

Notes

- During random play, only the elapsed play time and remaining play time of the current track will be displayed.
- When the selected Video CD is in the Playback Control mode ("PBC" is illuminated on the display), only the elapsed play time of the current track will be displayed.

On Screen Display

This unit features the OSD (On Screen Display) function to show various information about the current status of this unit and the selected disc on the monitor screen.

To call the OSD screen

Press **ON SCREEN**.

* Every time this button is pressed, the display type changes as shown below.

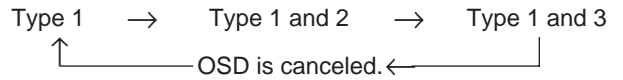

Notes

- The OSD screen cannot be called when the monitor shows the program sequence setting mode.
- This unit may not identify some information on the disc depending on the disc or the mode of this unit. Such information is shown by “-” or a blank.

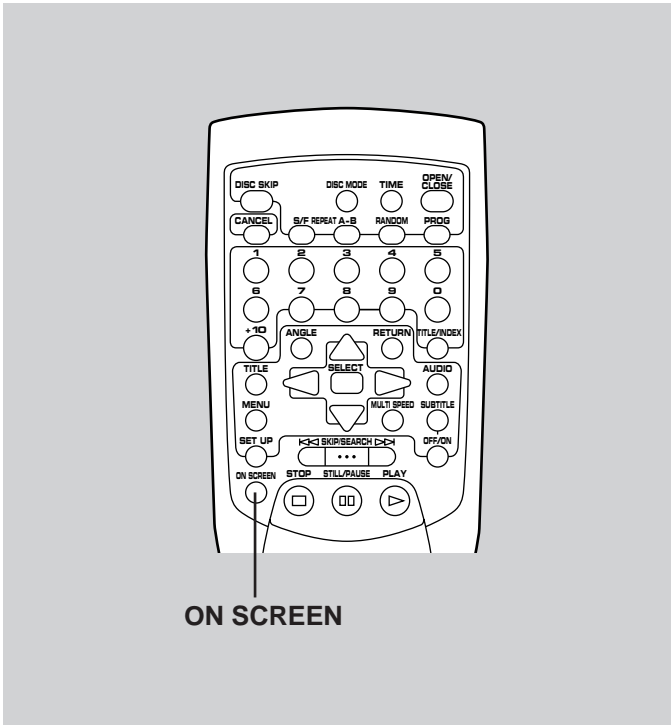

Display description

Type 1

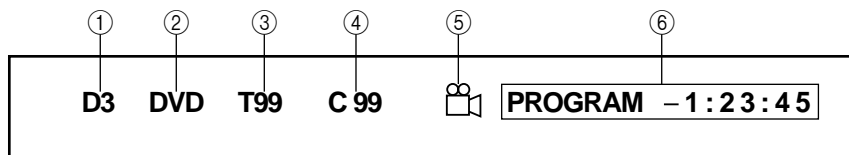

- ① The currently selected disc number
- ② The type of the current disc (DVD, VCD or CD)
- ③ The current title number or track number
- ④ The current chapter number (C00) or index number (I00)
- ⑤ The angle icon is shown during playing back a scene of a DVD source which includes two or more angles of view.

- ⑥ Time display
The time display mode selected by pressing **TIME** is shown.

CHAPTER	0:00:00	The current chapter's elapsed time
CHAPTER	- 0:00:00	The current chapter's remaining time
TRACK	0:00:00	The current track's elapsed time
TRACK	- 0:00:00	The current track's remaining time
TITLE	0:00:00	The current title's elapsed time
TITLE	- 0:00:00	The current title's remaining time
DISC	0:00:00	The current disc's elapsed time
DISC	- 0:00:00	The current disc's remaining time
PROGRAM	0:00:00	Program's elapsed time
PROGRAM	- 0:00:00	Program's remaining time

Type 2

For DVDs

① Title Total Time	1 : 2 3 : 4 5
② Analog Audio Output	Output
③ Digital Audio Output	Ⓐ PCM Ⓑ 48 kHz 16 bit
④ Audio Language	1 English
⑤ Audio Format	Dolby Digital 5.1 ch
⑥ Subtitle Language	2 English OFF
⑦ Angle	2

- ① The total playing time of the current title.
- ② Shows whether the analog AUDIO OUT terminals output signals (Output) or not (Muted).
- ③ The audio format Ⓐ and the format of the digital signals Ⓑ output to the OPTICAL and COAXIAL DIGITAL AUDIO OUT terminals
- ④ The current audio language and its number
- ⑤ The audio format of the source
- ⑥ The current subtitle language and its number, and the setting of subtitle (ON or OFF)
- ⑦ The current angle number is shown during playing back a scene of a DVD source which includes two or more angles of view.
* If the scene has only one angle of view, "--" is shown.

For Video CDs/CDs

① Disc Total Time	1 : 11 : 23
② Analog Audio Output	Output
③ Digital Audio Output	Ⓐ PCM Ⓑ 44.1 kHz 16 bit
④ L/R Mode	Stereo
⑤ VCD Version	2.0
⑥ Playback Control	ON

- ① The total playing time of the current disc.
- ② Shows whether the analog AUDIO OUT terminals output signals (Output) or not (Muted).
- ③ The audio format Ⓐ and the format of the digital signals Ⓑ output to the OPTICAL and COAXIAL DIGITAL AUDIO OUT terminals
- ④ The output mode of the left and right channels is shown.
Stereo Left and right channels
L Left channel only
R Right channel only
- ⑤ **For Video CDs only:**
The version of the current video CD (2.0 or 1.1)
- ⑥ **For Video CDs only:**
Shows whether the Playback Control is ON or OFF.

Type 3

Disc 1	DVD
Disc 2	Unidentified^{*1}
Disc 3	VCD
Disc 4	No Disc
Disc 5	CD

The types of discs on the disc table are shown for each tray number.

*1: Shows that this unit has not identified the type of the disc on the tray 2 because the disc had never been selected before.

Repeat play

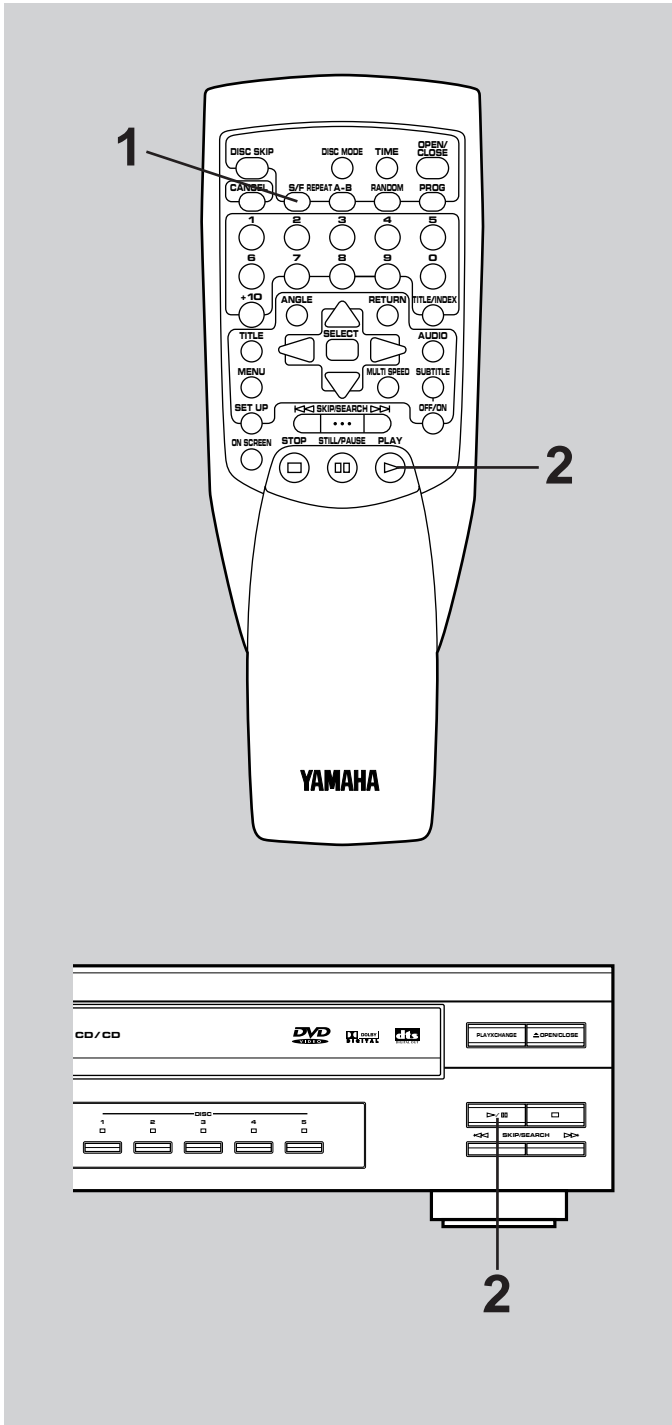

All discs, an entire disc, a single title or track, a sequence of programmed selections, or a sequence of random play selections can be continuously repeated.

* Depending on some discs, the designated repeat play may not be performed

1 Press **S/F REPEAT** once or more to select the desired repeat play mode (REP S or REP F).

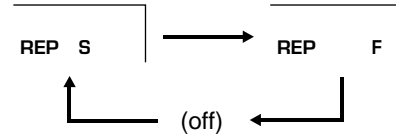

2 Press **PLAY**.

Repeat play modes

SINGLE REPEAT (REP S)

A single title or track is played back repeatedly.

* This is also available in the program play mode and the random play mode. (If the repeat play mode is switched off, the program play mode or the random play mode will be resumed.)

FULL REPEAT (REP F)

When “DISC 1” is illuminated on the front panel display:

A designated disc is played back repeatedly.

* In the random play mode, the selected disc is repeatedly played back, but the order of titles or tracks is different every time.

When “DISC 5” is illuminated on the front panel display:

All discs on the disc table are played back repeatedly.

* In the random play mode, the random play is performed among all discs and repeated with a different order of titles or tracks every time.

Note

In the program play mode, a sequence of programmed titles or tracks is played back repeatedly.

To cancel the repeat play

Press **S/F REPEAT** once or more so that “REP (S, F)” goes off from the front panel display.

Repeat play between specified two points (A-B repeat play)

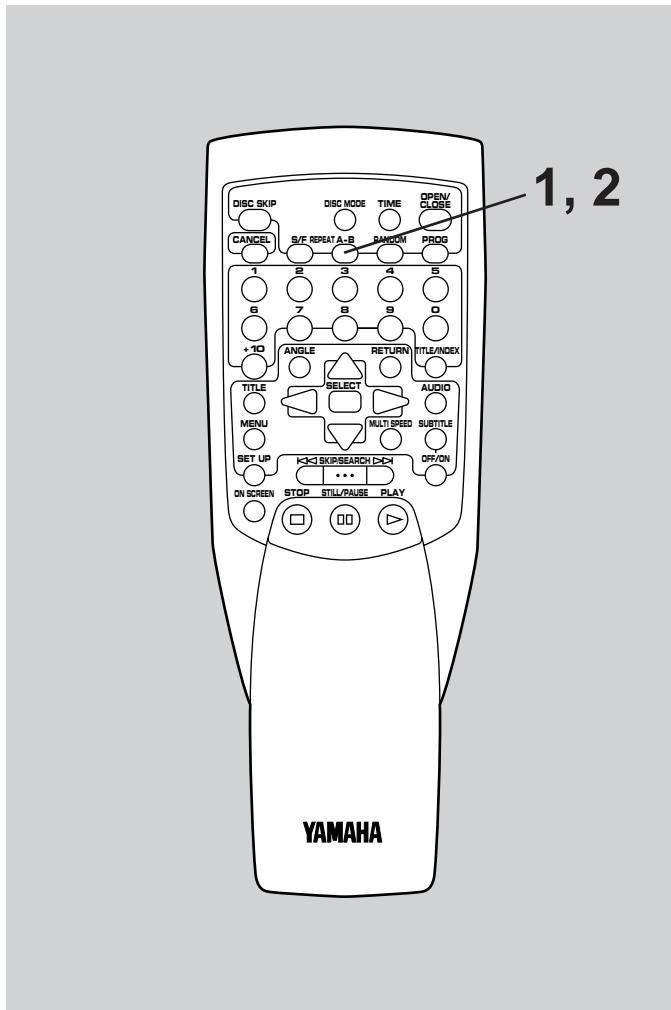

The section between two points you specify on a disc is repeatedly played back.

- 1 During playback, press **A-B** at the point where you want to begin the repeat play.

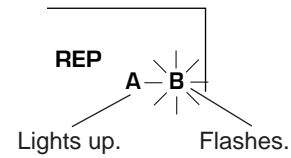

- 2 Press **A-B** again at the point where you want to end the repeat play.

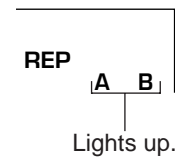

To cancel the A-B repeat play mode

Press **A-B** again.

* Pressing some other buttons may cancel the A-B repeat play mode.

Notes

- In the program play mode, the A-B repeat play can be made within a programmed title or track.
- **For DVDs;**
The A-B repeat play is effective only while playing back a moving picture. On some titles, the A-B repeat play may not work.
- **For Video CDs;**
When this unit is in the Playback Control mode, the A-B repeat play is effective only while playing back a moving picture.

Program play

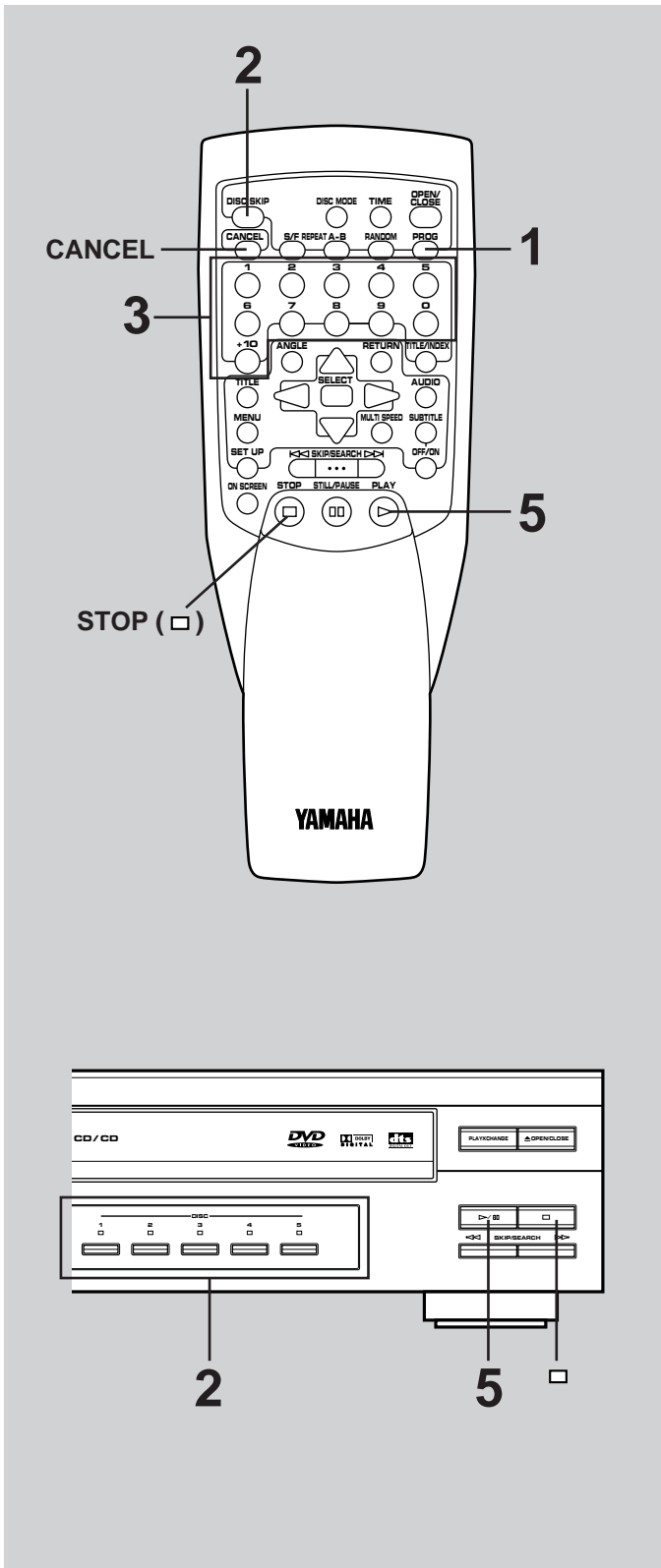

You can program desired titles of DVDs and tracks of Video CDs/CDs on the disc table in any desired order. Any title or track can be programmed as one selection. Up to 40 selections can be programmed in a sequence.

- 1** Press **PROG** when this unit is stopped.
* "PGM" and "P-01" will light up on the front panel display.
- 2** If necessary, select the desired disc by pressing **DISC SKIP** (or **DISC 1-5**).
- 3** Use the numeric buttons to select the preferred title or track number.
* The selected title (or track) number, the total play time of the programmed titles (or tracks) etc. can be checked on the monitor screen and the front panel display.
- 4** Repeat steps 2 and 3 for any other title or track. Up to 40 selections can be programmed.
- 5** Press **PLAY** to start playback of the programmed selections.

When playback of all the programmed selections is completed

This unit stops with the program play mode uncanceled.

- Press **PROG** to cancel the program play mode.
- Press **PLAY** to begin playing back the same programmed selections again.

To delete a title or track already programmed

- 1.** If during playback, press **STOP (□)**.
* If during programming, skip to step 4.
- 2.** Press **STOP (□)** again.
* The program play mode is canceled.
- 3.** Press **PROG**.
* The list of the program data is shown on the monitor screen. (Refer to page 35 for details.)
- 4.** Select the title or track you want to delete by pressing $\Delta/\nabla/\leftarrow/\rightarrow$.
- 5.** Press **CANCEL**.

How to use the numeric buttons to select a number (Example)

- To select number 8.
Press "8".
- To select number 10
Press "+10" and "0" in succession.
- To select number 15
Press "+10" and "5" in succession.
- To select number 26.
Press "+10" twice, then press "6".

Display information during programming

Front panel display

Every time you program a title or track, the total playing time is shown for about one second in place of the program sequence number.

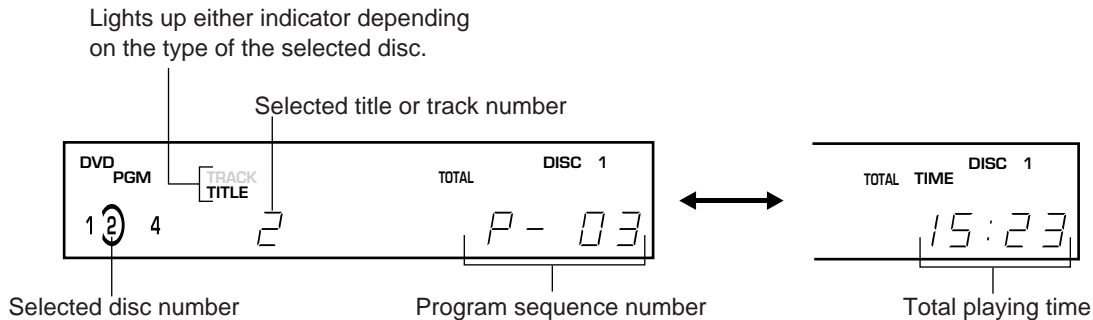

Monitor screen

Program Sequence	No.	Total Time
1-1	4-AL	-
1-2	2-8	-
1-3	2-9	-
1-4	2-10	-
1-5	3-5	-
1-6	-	-
2-3	-	-
2-4	-	-
2-5	-	-
2-6	-	-

① Disc number of the selected title or track.
 ② Title or track number
 ③ "AL" is displayed when "0" is entered to select all titles or tracks on the disc as one selection.
 ④ Program sequence number of the currently selected title or track.
 ⑤ Only "-" is displayed for a program sequence number to which no selection is programmed.
 ⑥ Total play time of the programmed selections

PROG Quit PLAY Play CANCEL Delete

Notes

- You can program a whole disc by pressing "0", instead of one title or one track. At that time, "AL" flashes on the front panel display.
- If you program a track of a Video CD (ver. 2.0), the Playback Control is canceled during the program play.
- Programming is possible only when this unit is stopped.
- There may be some cases that this unit cannot display the total time of the programmed selections.
- Skip search can be performed during playback.
 - * Pressing \blacktriangleright once locates the beginning of the title (or track) of the next program sequence number.
 - * Pressing \blacktriangleleft once locates the beginning of the current title (or track), and pressing \blacktriangleleft twice locates the beginning of the title (or track) of the previous program sequence number.
- If you program a title or track which does not exist or unavailable on the disc, or you program a title or track on an unavailable disc, the title or track will be skipped during program play.
- If a button which does not work in the program play mode is pressed, \odot appears on the monitor screen and the operation is invalid.

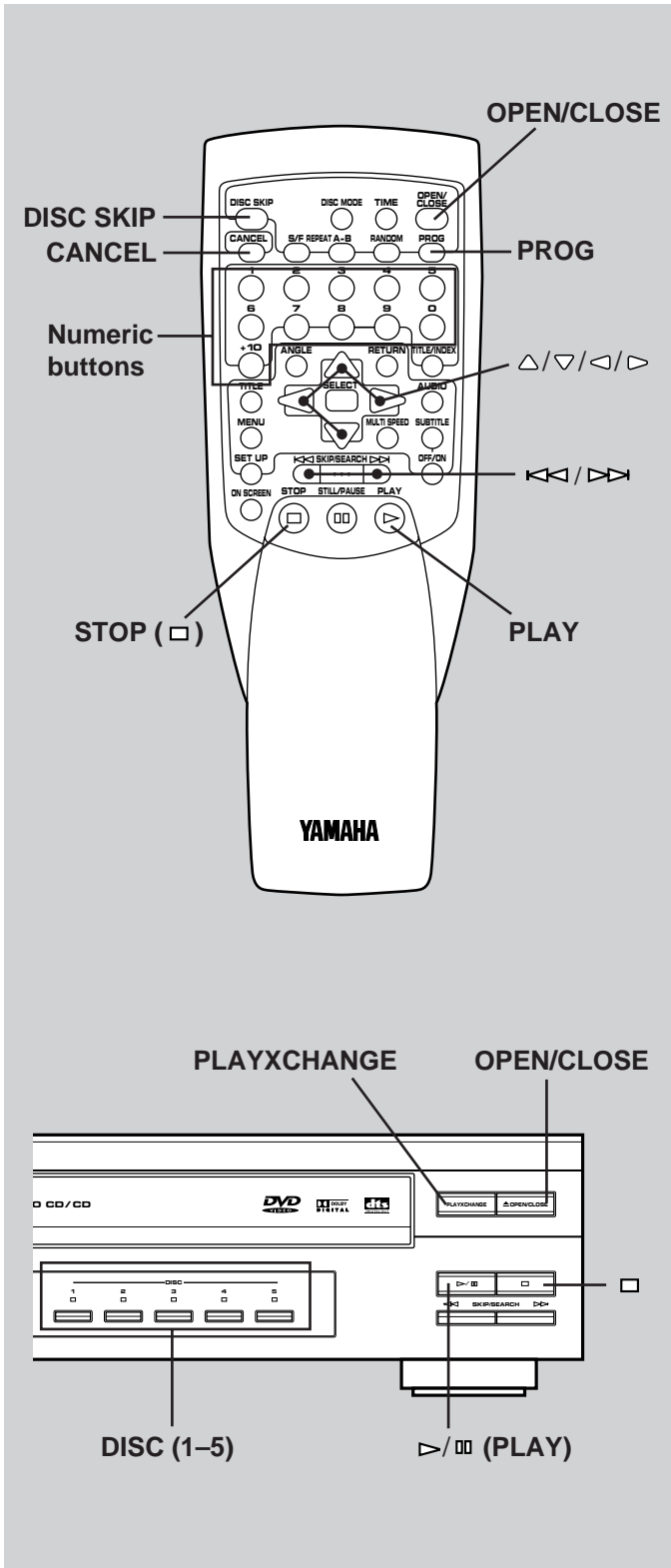

To stop program play

Press **STOP** (□).

* This unit memorizes the point where **STOP** (□) was pressed (**Playback Resumption**).

Press **PLAY** to resume playback from that point.

To cancel the program play mode (and restore the normal play mode)

There are several methods. The following are some of them.

- Press **STOP** (□) or **PROG** when the program play is stopped with the point to resume playback memorized.
- Press **DISC SKIP** or **DISC (1-5)**.

Note: These operations will not delete the program data. Press **PROG** again to restore the program play mode.

To check and correct program data

1. If during playback, press **STOP** (□).
 - * This unit memorizes the point where **STOP** (□) was pressed.
2. Press **STOP** (□) again.
 - * The program play mode is canceled.
3. Press **PROG**.
 - * The list of the program data is shown on the monitor screen. (Refer to page 35 for details.)
4. If you want to correct an already programmed selection, select it by pressing $\Delta/\nabla/\triangleleft/\triangleright$.
5. Select a new title (or track) you want to reprogram.
 - * Select the disc number by using **DISC SKIP** or **DISC (1-5)** and select the title (or track) number by using the numeric buttons.
 - * The already programmed title (or track) will be cleared from the memory and the new one will be programmed.
6. If you correct more selections, repeat step 5.
7. When the check or correction is finished, press **PLAY**.

To clear all program data

- Open the disc table by pressing **OPEN/CLOSE** or **PLAYXCHANGE**.
- Follow steps 1 to 3 of "To check and correct program data" described above, and then press and hold **CANCEL** for more than 3 seconds.

Random play

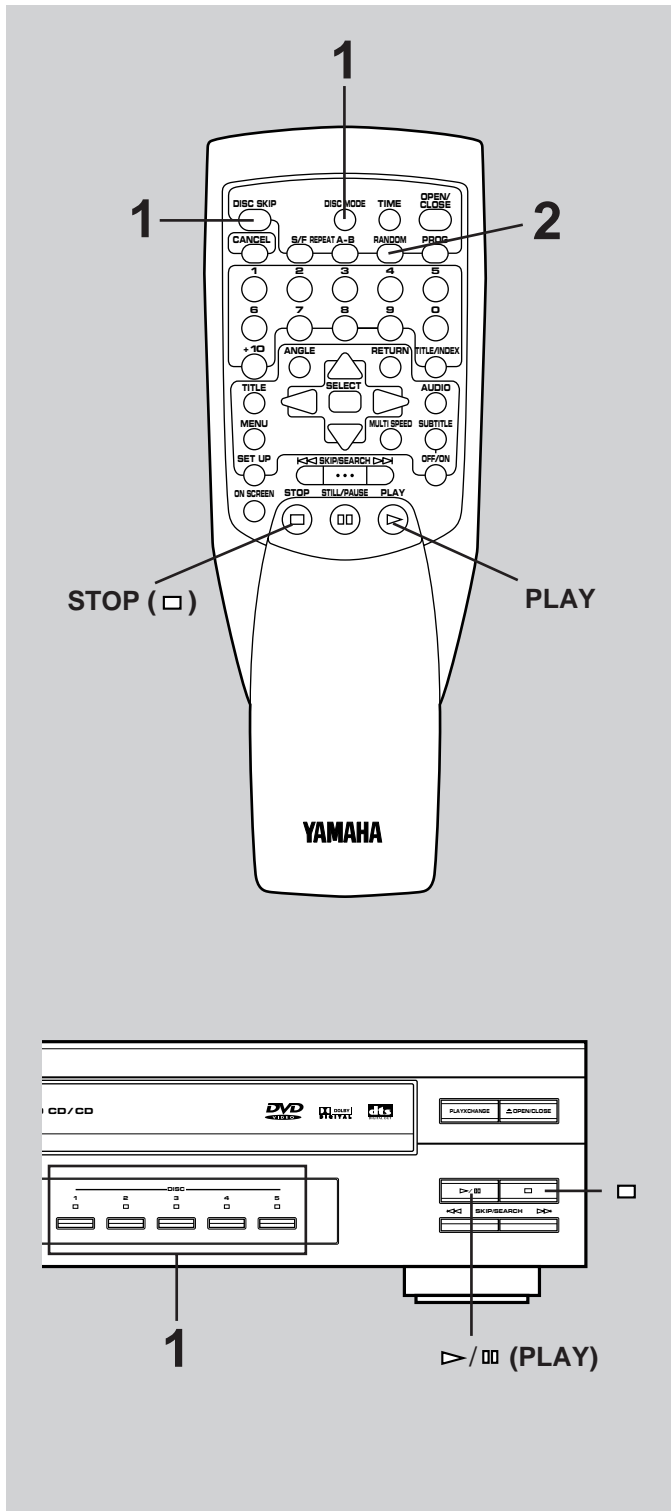

Titles or tracks of a designated disc or all discs on the disc table are played back in a random order.

- 1 If necessary, switch the disc play mode (to “DISC 1” or “DISC 5”) by pressing **DISC MODE** confirming it on the front panel display.

When “DISC 1” is illuminated: Titles or tracks of the selected disc are played back in a random order.

When “DISC 5” is illuminated: Titles and tracks of all discs on the disc table are played back in a random order.

* If “DISC 1” is selected, select the desired disc by pressing **DISC SKIP** or **DISC (1–5)**.

- 2 Press **RANDOM** to begin the random play.

* The “RDM” indicator lights up.

When playback of all the random selections is completed
This unit stops and returns to the normal playback mode.

To stop random play

1. Press **STOP (□)**.
* This unit memorizes the point where **STOP (□)** was pressed (**Playback Resumption**). Press **PLAY**, and playback will resume from that point.
2. Press **STOP (□)** again. The random play mode is canceled.

To cancel the random play mode (and restore the normal play mode)

There are several methods as described below.

- Press **RANDOM**.
- Press **STOP (□)** while the random play is stopped with the point to resume playback memorized.
- Press **OPEN/CLOSE**.
- Perform the title (or track) or time search operation.
* When the search is successfully executed, the random play mode will be canceled.

Notes

- This feature will not function in the program play mode.
- If a track of a Video CD (ver. 2.0) is selected, the Playback Control mode is canceled.
- Skip search, rapid advance and rapid reverse operations can be performed during random play (or while random play is paused) within the range of the random selections.
- Pressing **PLAYXCHANGE** will not disturb the random play mode if the disc play mode is in “DISC 1”.
In “DISC 5” mode, however, pressing **PLAYXCHANGE** will clear the random selections from discs other than the currently selected disc. If the disc table is closed, the random play continues with the selections from those discs renewed.

Changing subtitle language [DVD only]

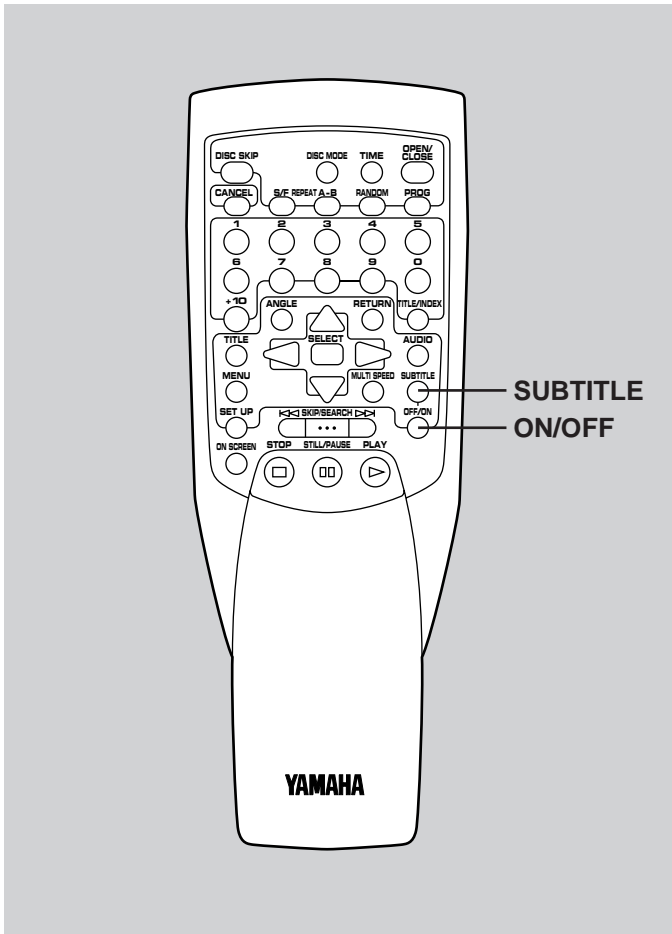

When you play back a disc on which subtitles are recorded, you can turn on or off displaying subtitles on the monitor screen as you prefer.

Moreover, if subtitles are recorded in two or more languages on the disc, you can select the preferred subtitle language.

To turn on/off the display of subtitles

Every time **ON/OFF** is pressed, the display of subtitles turns on and off alternately.

To change the subtitle language

Press **SUBTITLE** during playback repeatedly until the preferred language is displayed.

(Example)

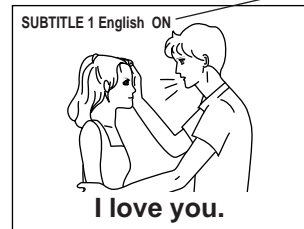
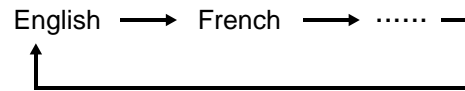

Shows the number of the subtitle language being selected for about 3 seconds.

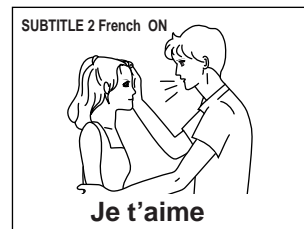

Notes

- Subtitles cannot be displayed on the monitor screen if subtitles are not recorded on the disc being played back.
- Some discs are recorded with subtitles which cannot be turned off.
- Depending on some discs, the subtitle language cannot be changed though two or more languages are recorded on the disc.
- Recorded subtitle languages differ with disc. Refer to the jacket of the disc for the information about subtitle languages etc.

Changing audio sound track language [DVD only]

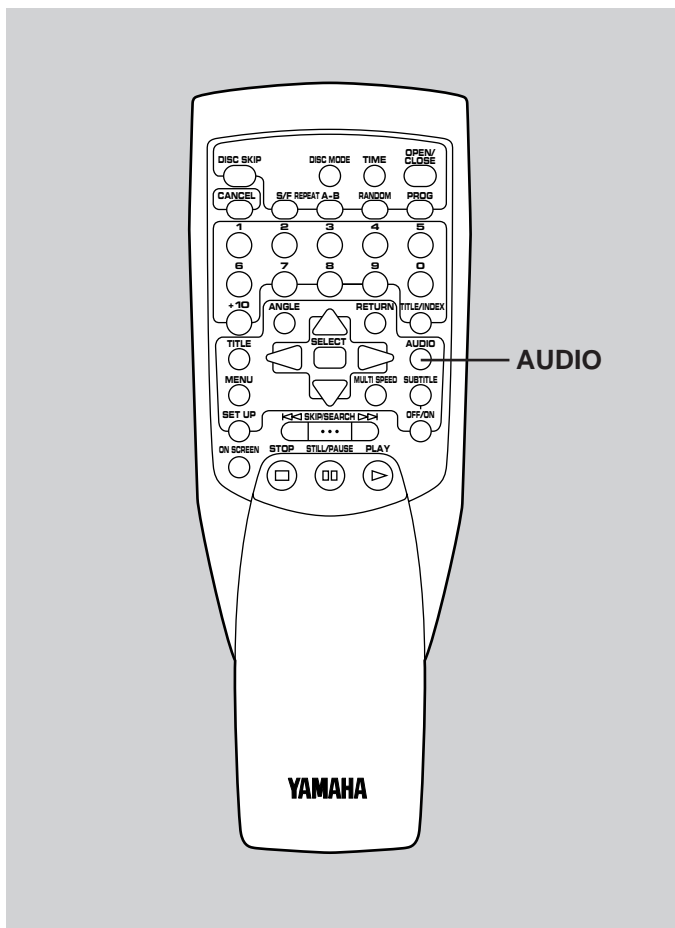

When you play back a disc on which two or more audio sound track languages are recorded, you can select the desired audio sound track language.

Press **AUDIO** during playback repeatedly until the preferred language is selected.

(Example)



Notes

- Depending on some discs, the audio sound track language cannot be changed though two or more languages are recorded on the disc.
- Recorded audio sound track languages differ with discs. Refer to the jacket of the disc for the information about audio sound track languages etc.

Using a title menu [DVD only]

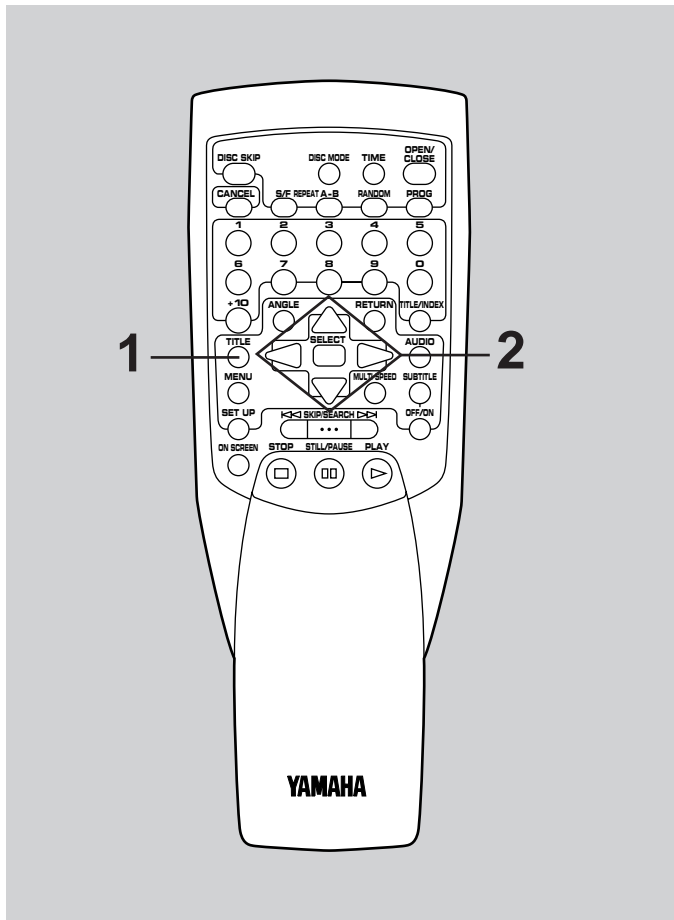

Some discs with movies, for example, may be available with two or more titles. If the disc has a title menu recorded on it, you can select the preferred movie title.
(The details of operation differ depending on the disc used.)

- 1 Press **TITLE** during playback.
* A list of the titles on the disc is displayed on the monitor screen.

(Example)



- 2 Select the preferred title by pressing $\Delta/\nabla/\triangleleft/\triangleright$, and then press **SELECT** [or simply by pressing the numeric button(s)].

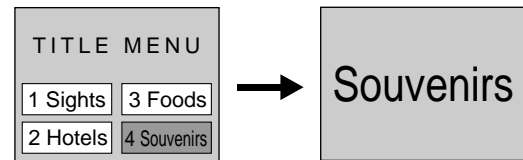

Playback begins from the selected title.

To clear the title menu

Press **TITLE** again.

* Playback resumes from the scene when **TITLE** was first pressed.

Using a DVD menu [DVD only]

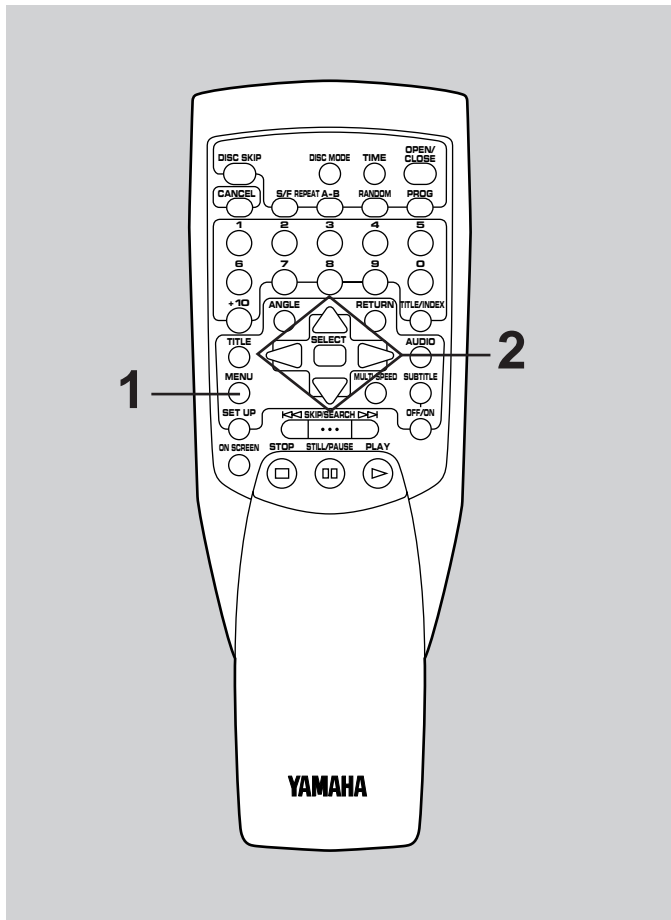

Some DVDs have unique menus called DVD menus. For example, DVDs programmed with complex contents provide guide menus, and those recorded with various languages provide menus for audio and subtitle languages. DVD menu's contents and operation differ depending on the disc used. The following explains basic operation when this feature is used.

1 Press **MENU** during playback.

* The DVD menu available on the disc is displayed on the monitor screen.

(Example)

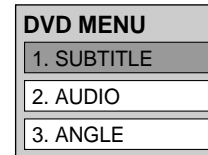

2 Select the preferred item by pressing $\Delta/\nabla/\triangleleft/\triangleright$, and then press **SELECT** [or simply by pressing the numeric button(s)].

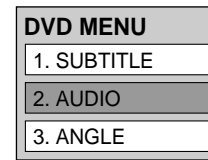

Playback begins from the selected item.

When the menu continues onto another screen.

Repeat step 2.

To clear the menu

Press **MENU** again.

* Playback resumes from the scene when **MENU** was first pressed.

Viewing from another angle [DVD only]

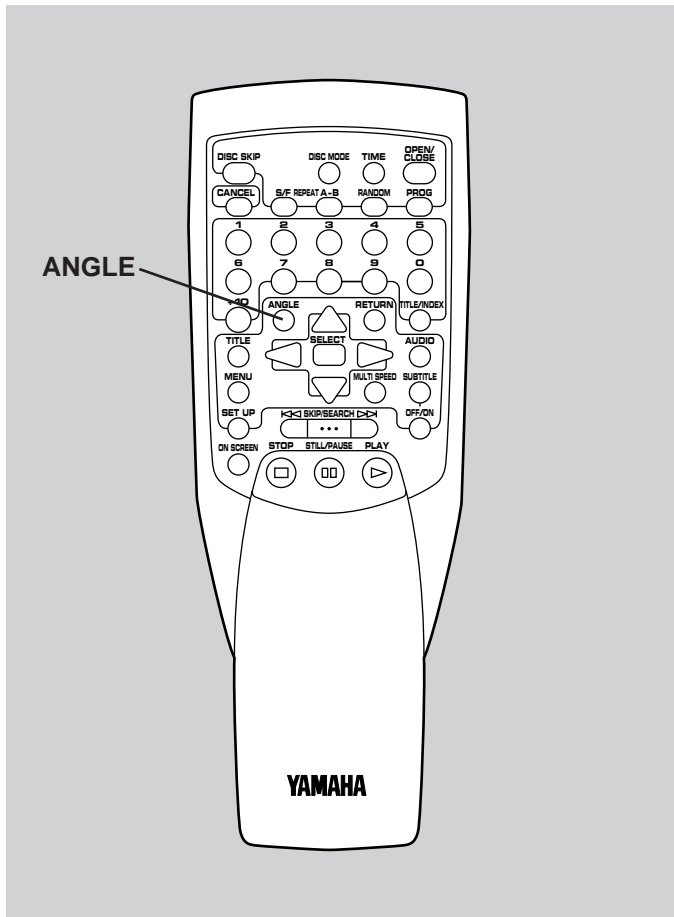

Some DVDs may contain scenes which have been shot from two or more angles simultaneously. For these discs, the same scene can be viewed from each of these different angles using the **ANGLE** button. (The recorded angles differ depending on the disc used.)

Press **ANGLE** during playback repeatedly until the preferred angle is selected.

(Example)

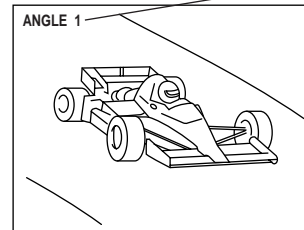

Shows the number of the angle currently selected.

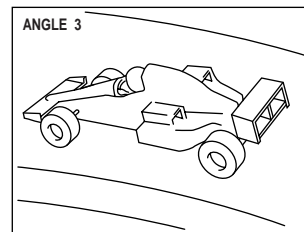
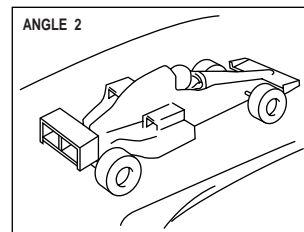

Notes

- This function works only for discs which have scenes shot from two or more angles.
- Scenes recorded in two or more angles, the number of angles etc. differ with discs.

Initial settings (on the SET UP menu)

This unit provides you with the following items to determine the initial status of this unit.

When you first use this unit, check the factory default settings of all the items. If the settings of some items are not suitable for using this unit in your Audio/Video system, change the settings of them.

Once the settings are changed, this unit can always be operated under the same conditions.

The settings will be retained in the memory until the settings are changed even if the power is turned off.

Items

SET UP group	Item
DVD Settings	1 TV type 2 Display Mode 3 Menu Language 4 Subtitle Language 5 Audio Language 6 Rating Level
VCD Settings	1 Playback Control
Display Settings	1 Guide Display 2 OSD Language 3 Background Screen 4 Screen Saver 5 FL Dimmer 6 Signal System Conversion* ¹
Audio Settings	1 Digital Output 2 Dynamic Range Control* ¹ 3 Speaker* ¹

*¹: Provided only for China and General models.

SET UP menu on the monitor screen

Check and change the settings on the monitor screen.

The currently selected SET UP group is shown here.

SET UP groups

* The currently selected SET UP group is highlighted.

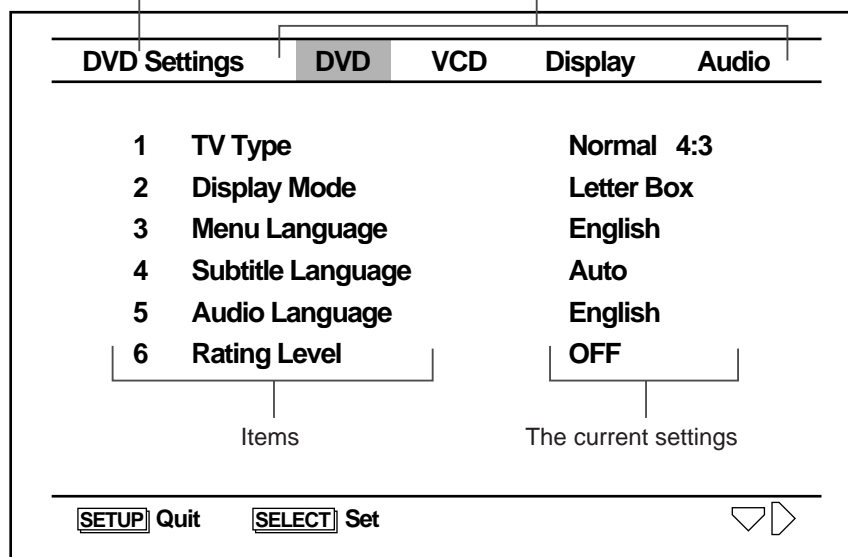

Common procedure for setting change

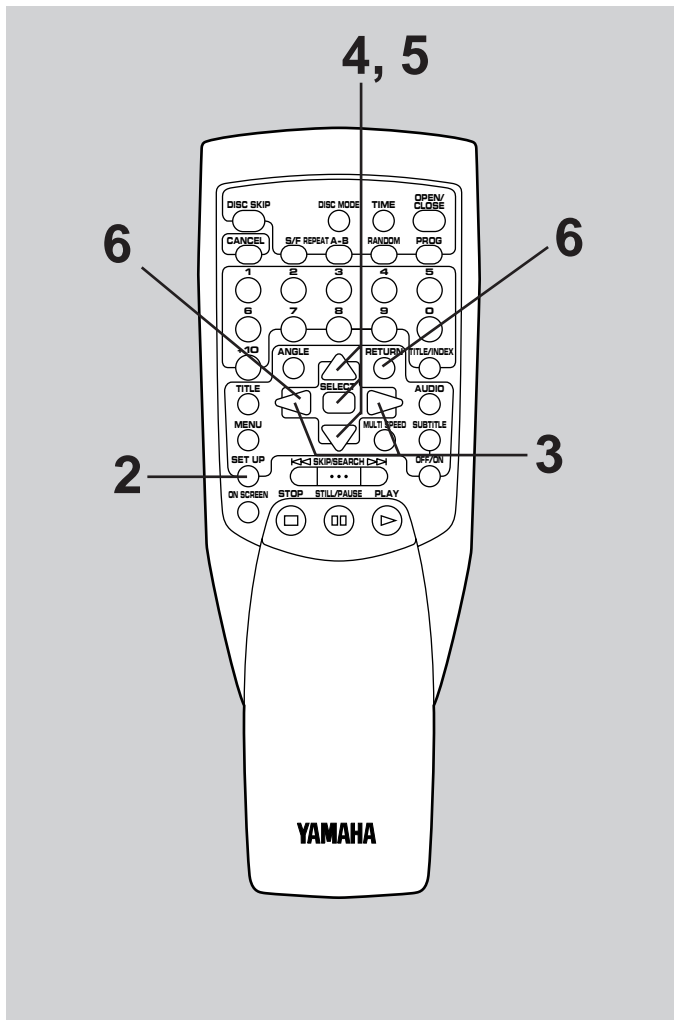

- 1 Turn on this unit and the TV monitor, and load discs.
- 2 Press **SET UP** when this unit is stopped.
* The SET UP menu appears on the monitor screen.
- 3 Press \triangleright or \triangleleft to select the preferred SET UP group.
- 4 Press ∇ or \triangle to select the preferred item, and then press **SELECT**.
* The display on the monitor screen changes to the mode for setting change.
* The current selection is indicated by "*" at the head.
- 5 Press ∇ or \triangle to change the selection, and then press **SELECT**.
* Some items require additional steps. (See the respective pages.)
- 6 When the setting change is finished, press **RETURN** (or \triangleleft) once or more to return to the previous display.
- 7 Repeat steps 3 to 6 for other items.

To return to the previous display

Press **RETURN** or \triangleleft .

To clear the SET UP menu

Press **SET UP**.

To restore the factory default settings for all items

While holding **CANCEL** on the remote controller pressed, press and hold \square on the front panel for more than 5 seconds.

For your reference:

The numeric buttons can also be used for a setting change instead of ∇ or \triangle . In this case, pressing **SELECT** is not necessary.

Note

If the SET UP menu is displayed during playback, you may not be able to change settings on some items. To change them, stop this unit.

Item description and setting change

DVD Settings

The items in this group are only applicable when playing back a DVD.

1 TV Type

Select the appropriate screen type according to your TV monitor; conventional size screen (Normal 4:3) or wide-screen (Wide 16:9).

- 1 When the SET UP group "DVD Settings" is selected, press ∇ or \triangle to select "1 TV Type" and then press **SELECT**.

DVD Settings	DVD	VCD	Display	Audio
1	TV Type		Normal 4:3	
2	Display Mode		Letter Box	
3	Menu Language		English	
4	Subtitle Language		Auto	
5	Audio Language		English	
6	Rating Level		OFF	

- 2 Press ∇ or \triangle to select the preferred type (1 or 2) and then press **SELECT**.

DVD Settings	TV Type	
* 1	Normal	4:3
2	Wide	16:9

1 Normal 4:3

Select this type when a conventional TV monitor is connected.

* When this type is selected, the setting of the next item "2 Display Mode" also becomes important. (Refer to the next page.)

2 Wide 16:9

Select this type when a wide-screen TV monitor is connected.

* A video source of wide-screen type is played in full size. (The TV must also be set to the full size display mode.)

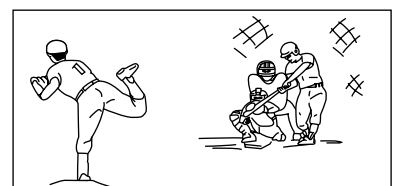

Factory default setting: Normal 4:3

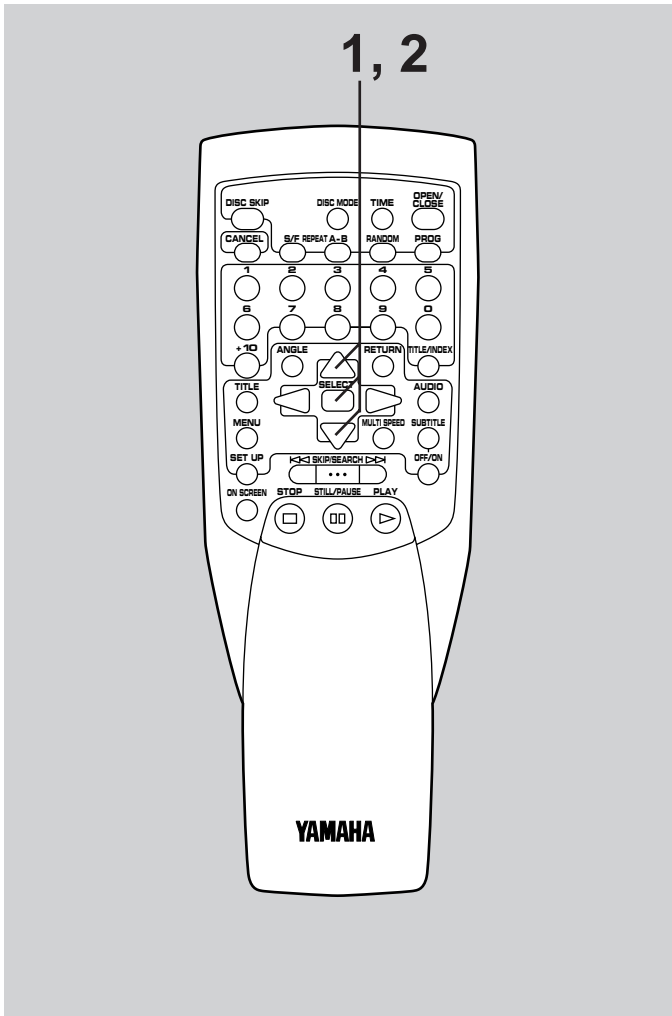

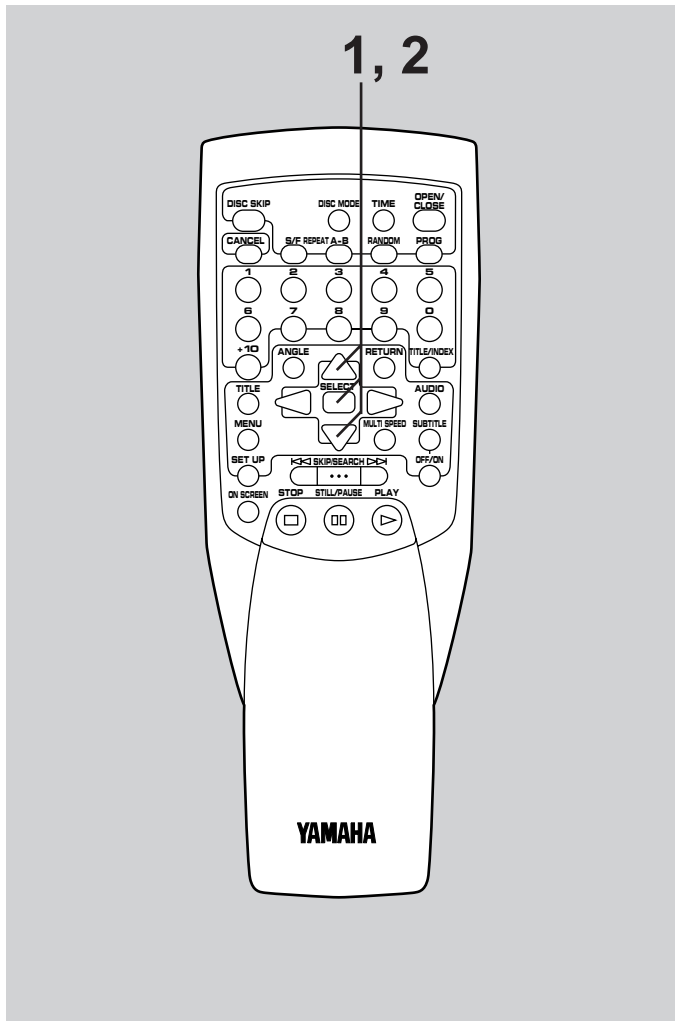

2 Display Mode

If "Normal 4:3" is selected on the item "1 TV Type", select the display mode (Letter box or Pan & Scan) for a video source of wide screen type.

- 1 When the SET UP group "DVD Settings" is selected, press ∇ or \triangle to select "2 Display Mode" and then press **SELECT**.

DVD Settings	DVD	VCD	Display	Audio
1	TV Type		Normal 4:3	
2	Display Mode		Letter Box	
3	Menu Language		English	
4	Subtitle Language		Auto	
5	Audio Language		English	
6	Rating Level		OFF	

- 2 Press ∇ or \triangle to select the preferred mode (1 or 2), and then press **SELECT**.

DVD Settings	Display Mode
* 1	Letter Box
2	Pan Scan

1 Letter Box

A video source is played back in the letter box style. (Black bands appear at the top and bottom of the screen.)

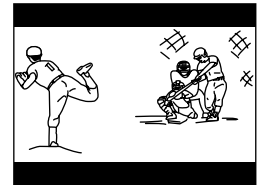

2 Pan Scan

A video source formatted in the Pan & Scan style is played back in that style. (The left and right edges are cut off.)



* A video source not formatted in the Pan & Scan style will be played back in the letter box style.

Factory default setting: Letter Box

3 Menu Language

Select the language which is used to show title menus or DVD menus when playing back a DVD.

- When the SET UP group "DVD Settings" is selected, press ∇ or \triangle to select "3 Menu Language" and then press **SELECT**.

DVD Settings	DVD	VCD	Display	Audio
1	TV Type		Normal	4:3
2	Display Mode		Letter Box	
3	Menu Language		English	
4	Subtitle Language		Auto	
5	Audio Language		English	
6	Rating Level		OFF	

- Press ∇ or \triangle to select the preferred language and then press **SELECT**.

DVD Settings	Menu Language	
1	Disc	9 Others
* 2	English	
3	Japanese	
4	Chinese	
5	Spanish	
6	French	
7	German	
8	Italian	

1 **Disc:** The priority language on the disc.

2 **English**

3 **Japanese**

4 **Chinese**

5 **Spanish**

6 **French**

7 **German**

8 **Italian**

9 **Others:** Another language can be selected by entering the code number for the language. (See the left for details.)

Factory default setting

U.S.A. and General models: **English**

China model: **Chinese**

Note

If you play back a disc which does not have the selected language, the priority language on the disc is used.

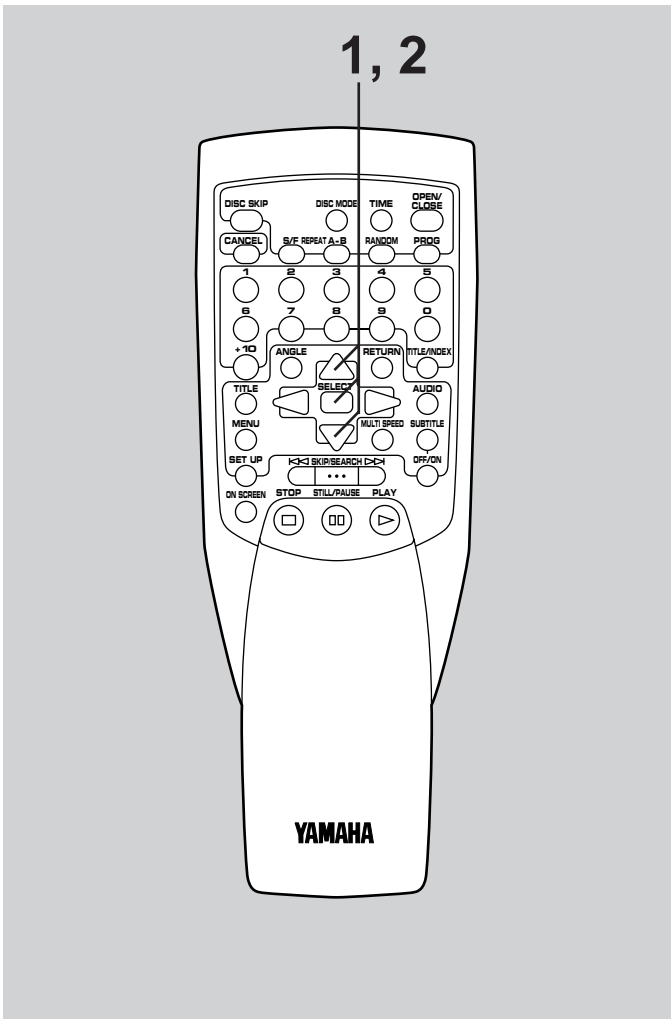

Entering a language code number

- After you select "Others", press **SELECT**.
* "Language Code" appears on the monitor screen.
- Enter a 4-digit number by using the numeric buttons. (Refer to "Language code list" on page 67 for the number of the desired language.

(Example: "8084")

Language Code — 8 0 8 4 —

- Press **SELECT**.

Note: In step 1, if a language code is already set, it is shown as "Others 6565 (for example)". If you wish to change the code number, follow steps 2 and 3.

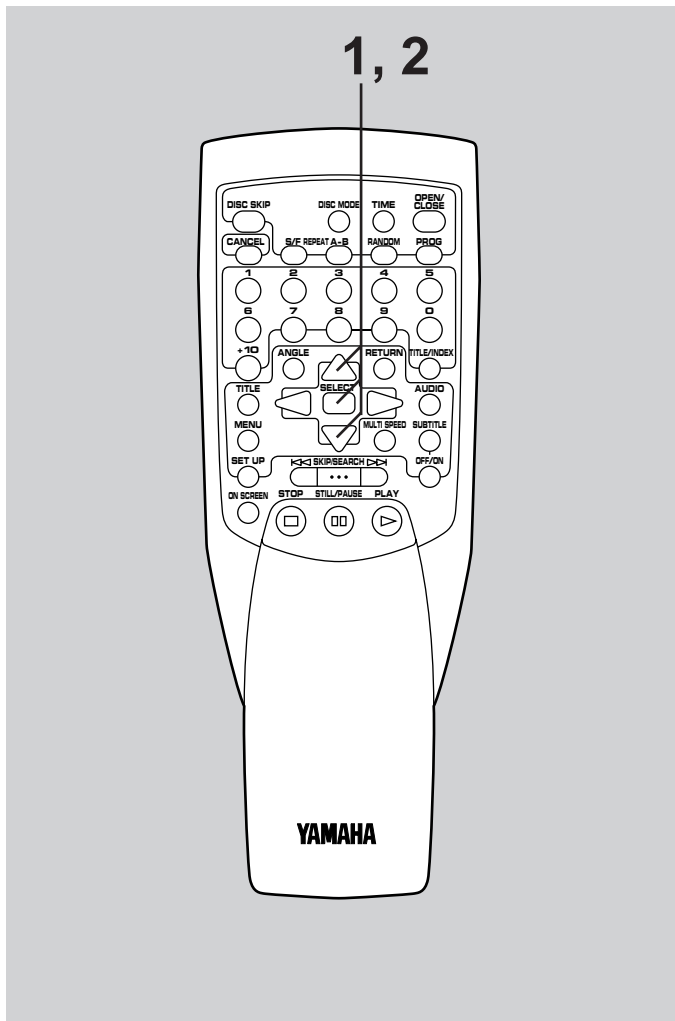

4 Subtitle Language

Select the language which is used to show subtitles when playing back a DVD.

- 1 When the SET UP group “DVD Settings” is selected, press ∇ or \triangle to select “4 Subtitle Language” and then press **SELECT**.

DVD Settings	DVD	VCD	Display	Audio
1	TV Type		Normal 4:3	
2	Display Mode		Letter Box	
3	Menu Language		English	
4	Subtitle Language		Auto	
5	Audio Language		English	
6	Rating Level		OFF	

- 2 Press ∇ or \triangle to select the preferred language and then press **SELECT**.

DVD Settings	Subtitle Language	
* 1	Auto	9 Italian
2	OFF	10 Others
3	English	
4	Japanese	
5	Chinese	
6	Spanish	
7	French	
8	German	

1 Auto: The language is automatically selected according to the setting on the item “5 Audio Language” (on page 49). (See the left for details.)

2 OFF: Subtitles are not displayed.

3 English

4 Japanese

5 Chinese

6 Spanish

7 French

8 German

9 Italian

10 Others: Another language can be selected by entering the code number for the language. (Refer to “Entering a language code number” on page 47 for details.)

Factory default setting: Auto

Notes

- If you play back a disc which does not have the selected language, the priority language on the disc is used.
- You can also change the subtitle language, or turn off or on subtitles by using **SUBTITLE** and **OFF/ON** only while playing back a disc on which two or more subtitle languages are recorded. (Refer to page 38 for details.)

When “1 Auto” is selected in step 2, the subtitle language is automatically selected as follows.

- When the disc is played back with the audio language selected on the item “5 Audio Language” (on page 49), the subtitles of the same language are selected and the display of them is turned off.
- When the disc is not played back with the audio language selected on the item “5 Audio Language” (on page 49) because the language is not recorded on the disc:
 - * If the disc has the subtitles of the same language, the subtitles are displayed.
 - * If the disc does not have the subtitles of the same language, the subtitles are displayed with the priority language on the disc.

5 Audio Language

Select the language which is used for audio sound track when playing back a DVD.

- When the SET UP group “DVD Settings” is selected, press ∇ or \triangle to select “5 Audio Language” and then press **SELECT**.

DVD Settings	DVD	VCD	Display	Audio
1	TV Type		Normal	4:3
2	Display Mode		Letter Box	
3	Menu Language		English	
4	Subtitle Language		Auto	
5	Audio Language		English	
6	Rating Level		OFF	

- Press ∇ or \triangle to select the preferred language, and then press **SELECT**.

DVD Settings	Audio Language
* 1	English
2	Japanese
3	Chinese
4	Spanish
5	French
6	German
7	Italian
8	Others

1 English

2 Japanese

3 Chinese

4 Spanish

5 French

6 German

7 Italian

8 Others: Another language can be selected by entering the code number for the language. (Refer to “Entering a language code number” on page 47 for details.)

Factory default setting

U.S.A. and General models: **English**

China model: **Chinese**

Notes

- If you play back a disc which does not have the selected language, the priority language on the disc is used.
- You can also change the audio sound track language by using **AUDIO** only while playing back a disc on which two or more audio sound track languages are recorded. (Refer to page 39 for details.)

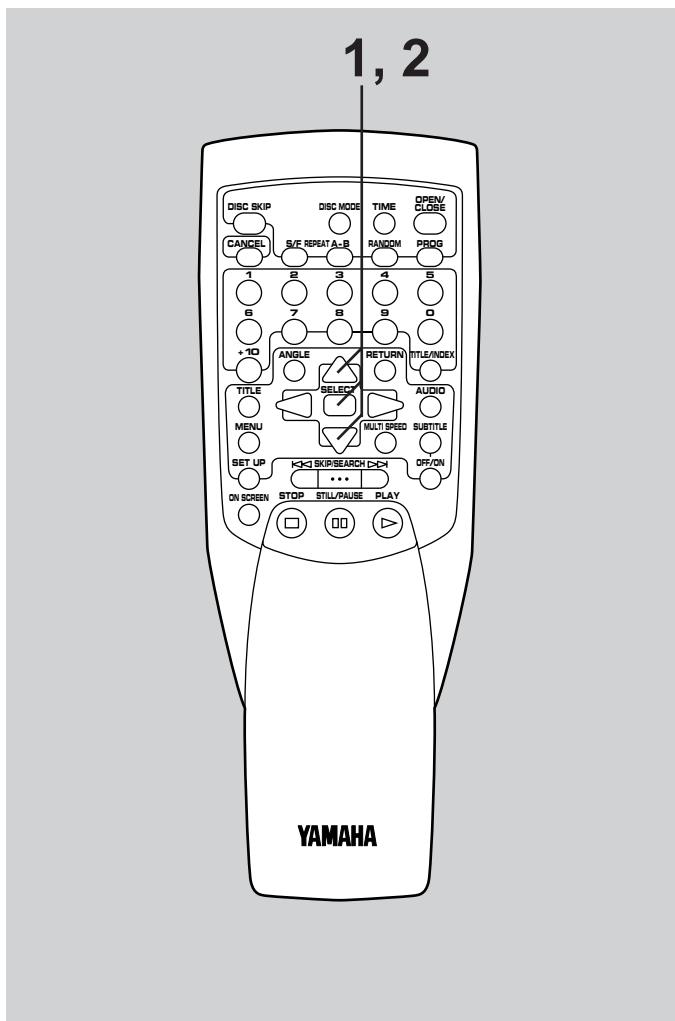

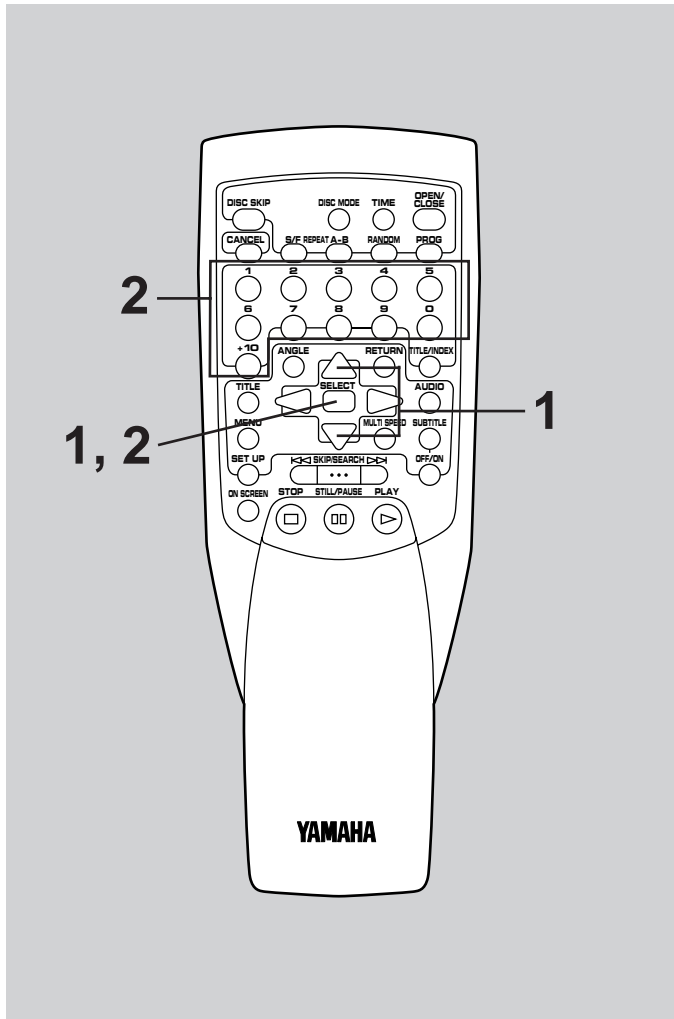

6 Rating Level

Some DVDs are encoded with restriction of playback for scenes unsuitable for children. The level of restriction (rating level) differs depending on the contents of discs. On this item, you can set the rating level to the desired level. When you play back a DVD encoded with the rating level, only the picture which conforms to the level set on this item is played back. The level you set on this item is locked and unchangeable without entering the password you designate. This is for preventing the level from being changed by someone other than you.

- 1 When the SET UP group "DVD Settings" is selected, press ∇ or \triangle to select "6 Rating Level", and then press **SELECT**.

DVD Settings	DVD	VCD	Display	Audio
1	TV Type		Normal 4:3	
2	Display Mode		Letter Box	
3	Menu Language		English	
4	Subtitle Language		Auto	
5	Audio Language		English	
6	Rating Level		OFF	



To set Rating Level, choose an entry password.

Password -----

- 2 Enter a 4-digit number as the password by using the numeric button(s), and then press **SELECT**.

(Example: "4343")

Password -4343-

Note

Do not forget your password.

In the future, if you want to change the rating level, you must enter the password correctly in this step, otherwise you cannot go on to the next step.

* In this case, the password you enter is shown as "****".

- 3** Press ∇ or \triangle to select the preferred level, and then press **SELECT**.

DVD Settings		Rating Level
1	Level 1	9 OFF
2	Level 2	
* 3	Level 3	
4	Level 4	
5	Level 5	
6	Level 6	
7	Level 7	
8	Level 8	

1 Level 1 Restriction is the severest.

2 Level 2

3 Level 3

4 Level 4

5 Level 5

6 Level 6

7 Level 7

8 Level 8 Restriction is the easiest.

9 OFF All DVDs can be played back.

Restriction becomes easier.

Factory default setting: OFF

- 4** Press **SELECT**.

To change the rating level

Follow the procedure above. However, it cannot be changed unless the password you designated is not entered correctly in Step 2.

To clear the password and unlock this item

Holding **CANCEL** pressed, press **STOP** (\square) 3 times continuously.

Notes

- In the following cases, the display on the monitor screen changes to allow you to change the level temporarily for playing back the currently selected disc.
 - * The selected disc cannot be played back in the current rating level.
 - * The selected disc demands to change the level.
- For discs encoded with no rating level information, the rating level set on this item has no effect.

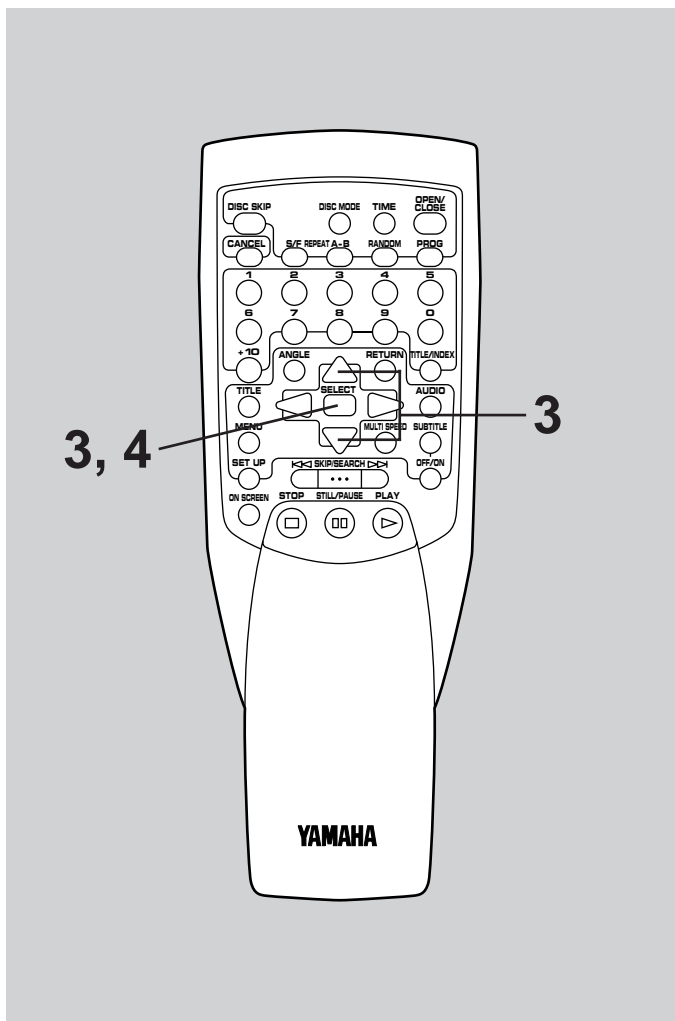

Note for US customers

The restrictions applied to movies in U.S.A. correspond to the following rating levels.

Restriction	Rating level
G	Level 1
PG	Level 3
PG-13	Level 4
R	Level 6
NC-17	Level 7

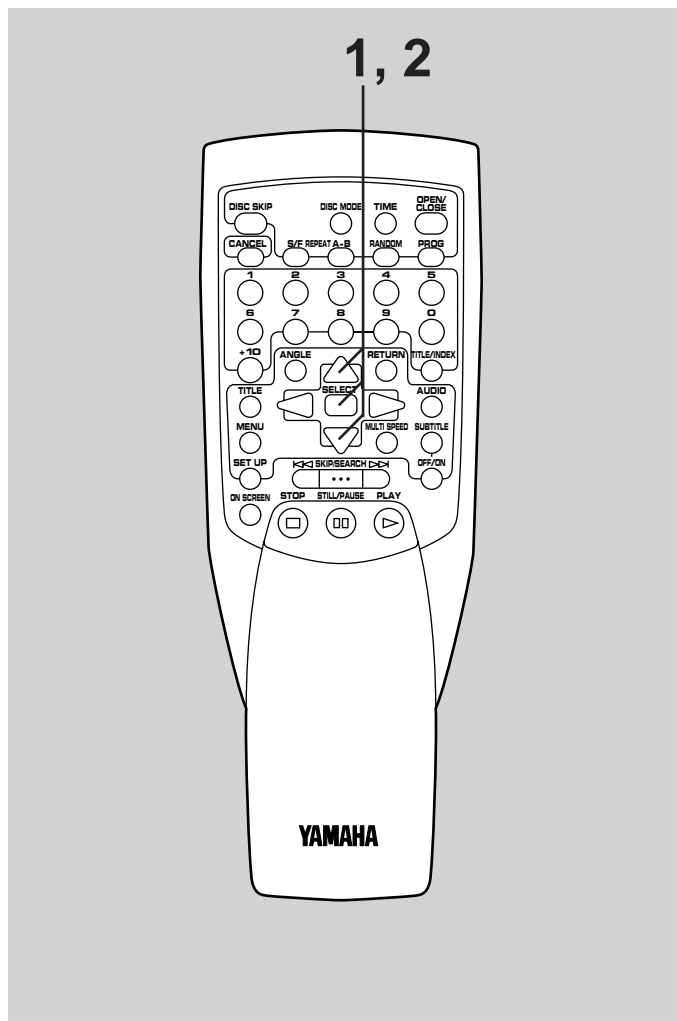

VCD Settings

The item in this group is only effective when playing back a Video CD.

1 Playback Control

Select whether the Playback Control works or not when playing back a Video-CD, ver. 2.0.

- 1 When the SET UP group "VCD Settings" is selected, press ∇ or \triangle to select "1 Playback Control", and then press **SELECT**.

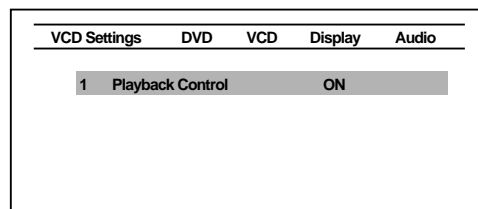

- 2 Press ∇ or \triangle to select ON or OFF, and then press **SELECT**.

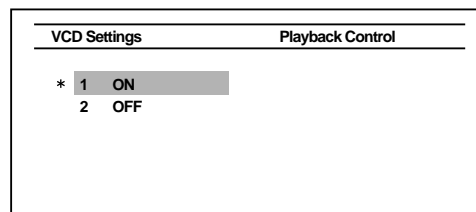

1 ON The Playback Control works when a Video-CD, ver. 2.0 is played back.

2 OFF The Playback Control does not work even when a Video-CD, ver. 2.0 is played back.

Factory default setting: ON

Display Settings

The items in this group controls the ways of displaying information on the monitor screen and the front panel display.

1 Guide Display

Select whether or not the monitor screen shows the operation guide information or other messages.

- When the SET UP group "Display Settings" is selected, press ∇ or \triangle to select "1 Guide Display", and then press **SELECT**.

Display Settings	DVD	VCD	Display	Audio
1	Guide Display		ON	
2	OSD Language		English	
3	Background Screen		Picture 1	
4	Screen Saver		ON	
5	FL Dimmer		Normal	

- Press ∇ or \triangle to select the preferred mode, and then press **SELECT**.

Display Settings	Guide Display
* 1	ON
2	Brief
3	OFF

- 1 ON** Select this to show the operation guide information and other messages.
- 2 Brief** Select this to show the following icons only.
- \otimes : Means that the current operation is prohibited by the disc or this unit, so the operation is invalid.
- $\triangle!$: Means "Warning".
- 3 OFF** Select this to show no operation guide information and no message on the monitor screen.

Factory default setting: ON

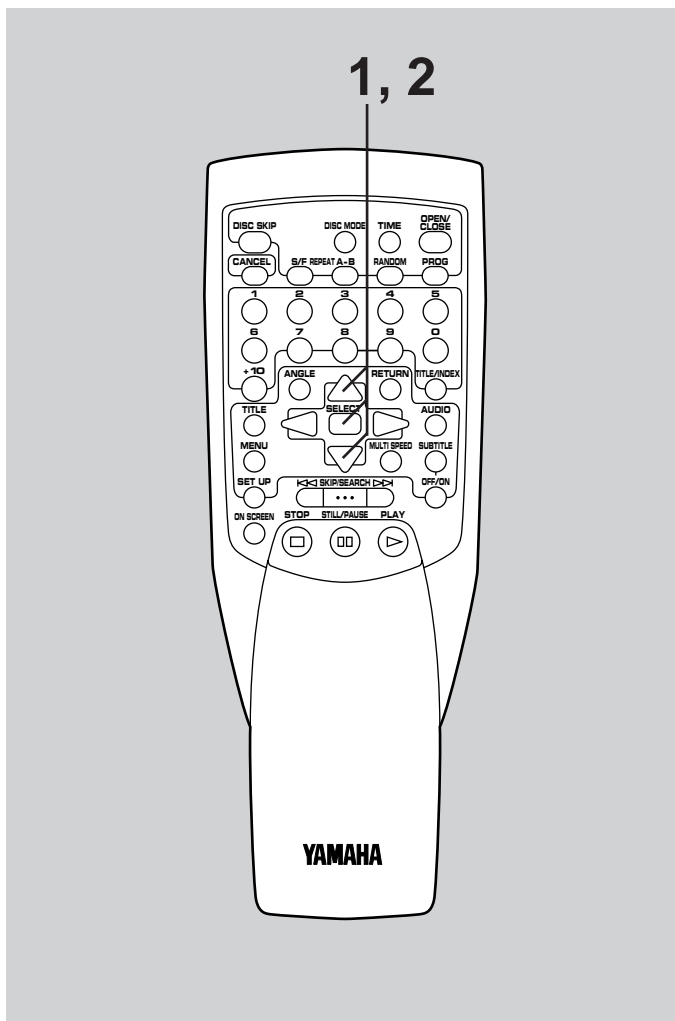

2 OSD Language

Select the language for displaying the OSD (On Screen Display) information.

- 1 When the SET UP group “Display Settings” is selected, press ∇ or \triangle to select “2 OSD Language”, and then press **SELECT**.

Display Settings	DVD	VCD	Display	Audio
1	Guide Display		ON	
2	OSD Language		English	
3	Background Screen		Picture 1	
4	Screen Saver		ON	
5	FL Dimmer		Normal	

- 2 Press ∇ or \triangle to select the preferred language, and then press **SELECT**.

Display Settings	OSD Language		
* 1	English	英語	英文
2	Japanese	日本語	日文
3	Chinese	中国語	中文

1 English	英語	英文
2 Japanese	日本語	日文
3 Chinese	中国語	中文

Factory default setting

U.S.A. and General models: **English**

China model: **Chinese**

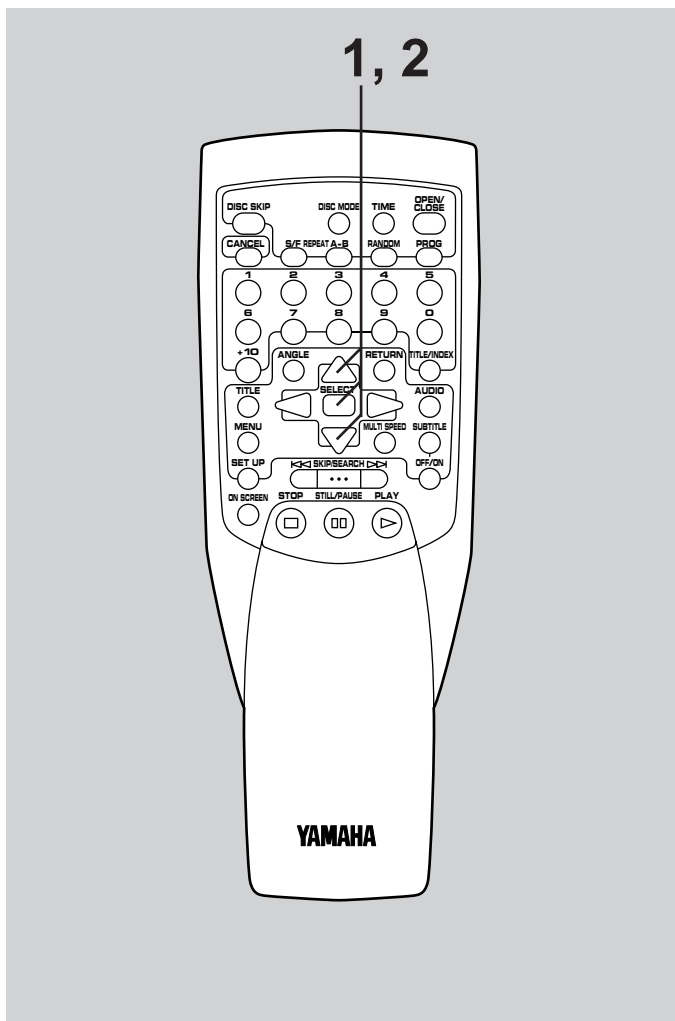

3 Background Screen

Select a background image or color to be shown on the monitor screen when no video source is reproduced on the monitor.

- 1 When the SET UP group "Display Settings" is selected, press ∇ or \triangle to select "3 Background Screen" and then press **SELECT**.

Display Settings	DVD	VCD	Display	Audio
1	Guide Display		ON	
2	OSD Language		English	
3	Background Screen		Picture 1	
4	Screen Saver		ON	
5	FL Dimmer		Normal	

- 2 Press ∇ or \triangle to select the preferred type, and then press **SELECT**.

Display Settings	Background Screen
* 1	Picture 1
2	Picture 2
3	Blue
4	Black

1 **Picture 1** Wallpaper type 1

2 **Picture 2** Wallpaper type 2

3 **Blue** Blue background

4 **Black** Black background

Factory default setting: Picture 1

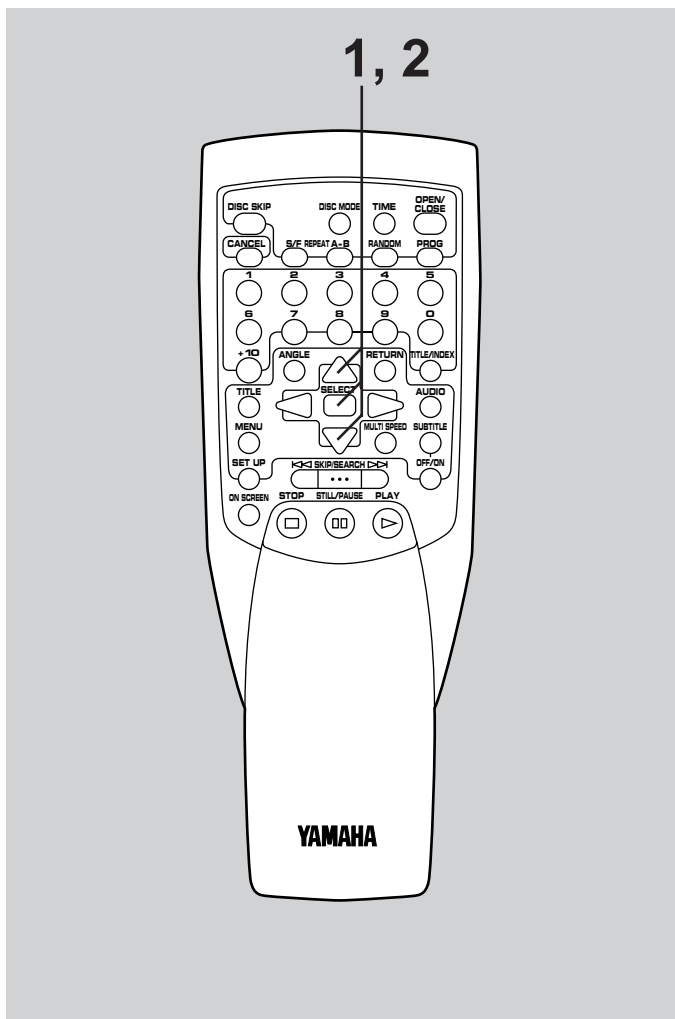

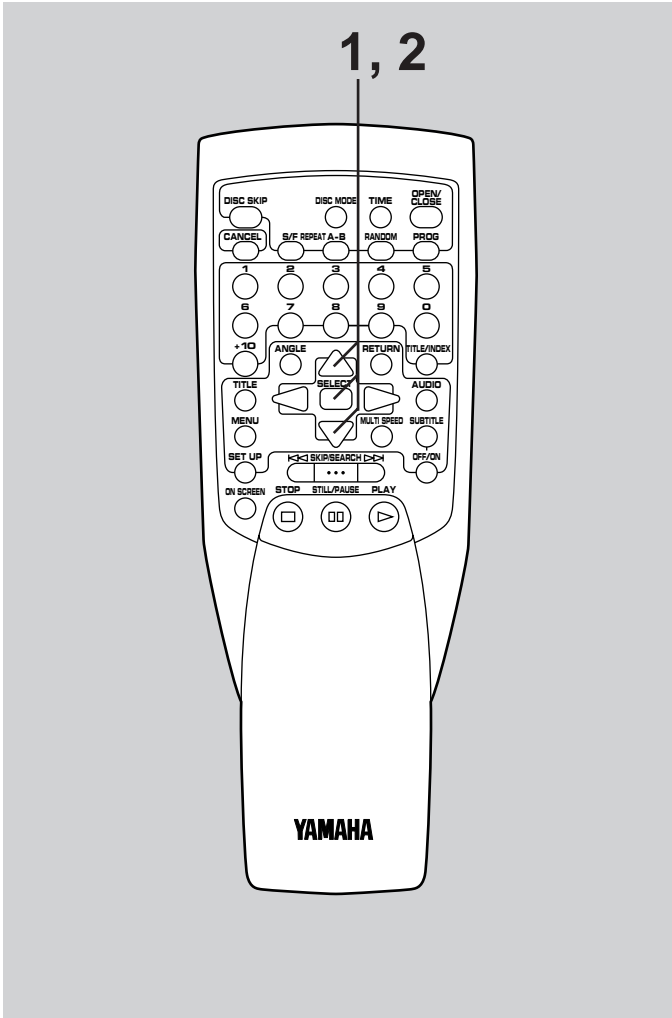

4 Screen Saver

You can select whether to use the built-in screen saver or not.

- 1 When the SET UP group “Display Settings” is selected, press ∇ or \triangle to select “4 Screen Saver”, and then press **SELECT**.

Display Settings	DVD	VCD	Display	Audio
1	Guide Display		ON	
2	OSD Language		English	
3	Background Screen		Picture 1	
4	Screen Saver		ON	
5	FL Dimmer		Normal	

- 2 Press ∇ or \triangle to select ON or OFF, and then press **SELECT**.

Display Settings	Screen Saver
* 1	ON
2	OFF

- 1 **ON** The screen saver will activate automatically after five minutes laps with this unit stopped.
- 2 **OFF** The screen saver will not activate in any status of this unit.

Factory default setting: ON

Note

When the screen saver is working on the TV monitor, pressing any button on the front panel or remote controller cancels the operation of the screen saver.

A button pressed in this case will not execute its original function.

5 FL Dimmer

Select the brightness of the front panel display.

- 1 When the SET UP group "Display Settings" is selected, press ∇ or \triangle to select "5 FL Dimmer", and then press **SELECT**.

Display Settings	DVD	VCD	Display	Audio
1	Guide Display		ON	
2	OSD Language		English	
3	Background Screen		Picture 1	
4	Screen Saver		ON	
5	FL Dimmer		Normal	

- 2 Press ∇ or \triangle to select the preferred mode, and then press **SELECT**.

Display Settings	FL Dimmer
* 1	Normal
2	Dim
3	OFF

- 1 **Normal** Normal brightness
 - 2 **Dim** Dim
 - 3 **OFF** No illumination while playing back a disc.
Dim when this unit is not playing back a disc.
- * The **AUTO DISPLAY OFF** indicator on the front panel lights up.

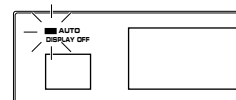

Factory default setting: Normal

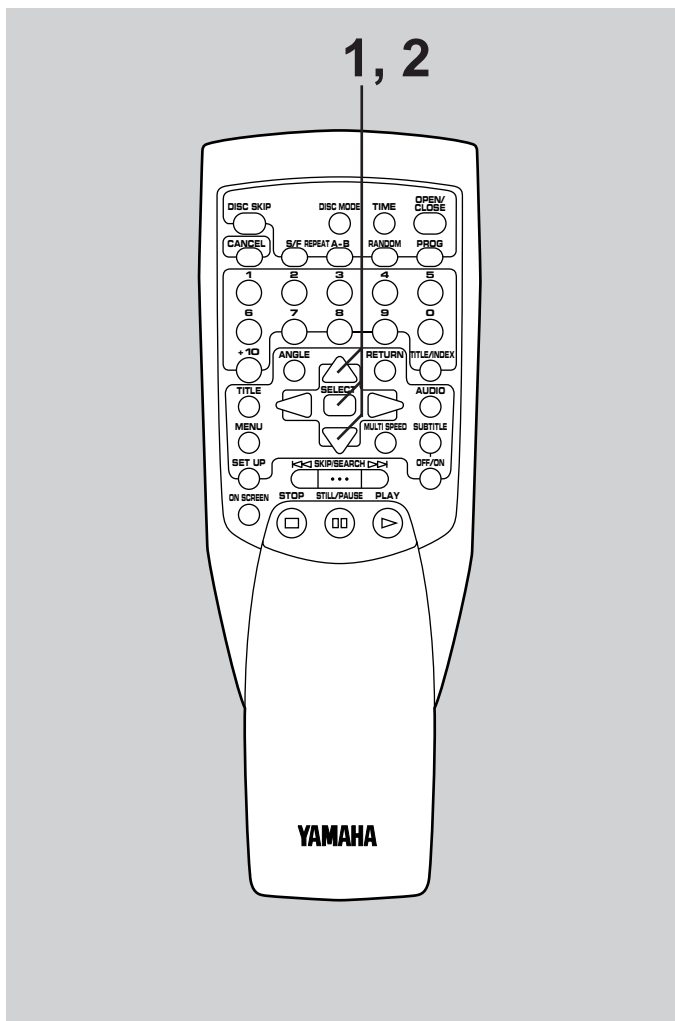

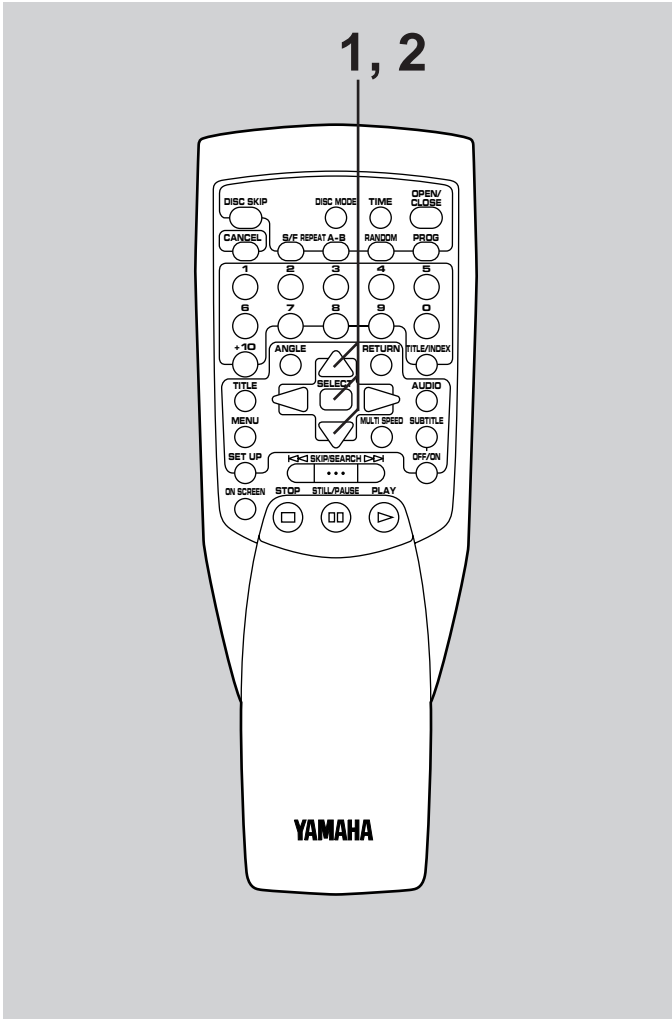

6 Signal System Conversion

[DVD and VCD only]

(for China and General models only)

This unit is designed for use with the NTSC and PAL television formats. You have already selected the format your TV monitor employs with the MODE SELECT (PAL/NTSC) switch on the rear panel.

However, if you prefer, you can change the setting so that this unit outputs video signals in the same format with the disc being played back.

- 1 When the SET UP group “Display Settings” is selected, press ∇ or \triangle to select “6 Signal System Conversion”, and then press **SELECT**.

Display Settings	DVD	VCD	Display	Audio
1	Guide Display		ON	
2	OSD Language		English	
3	Background Screen		Picture 1	
4	Screen Saver		ON	
5	FL Dimmer		Normal	
6	Signal System Conversion		Switch	

- 2 Press ∇ or \triangle to select the preferred format, and then press **SELECT**.

Display Settings	Signal System Conversion
* 1	Switch
2	Disc

- 1 **Switch** Generally select this.
Video signals are output from this unit in the format selected with the MODE SELECT (PAL/NTSC) switch on the rear of this unit. (Refer to page 15.)

- 2 **Disc** Select this if your TV monitor employs both PAL and NTSC formats.
* This unit outputs signals in the same format with the disc currently played back.

Factory default setting: Switch

Audio Settings

The items in this group control audio signals output from the AUDIO OUT terminals on the rear of this unit.

Note: The item No. 2 “Dynamic Range Control” and No. 3 “Speaker” are available for China and General models only.

1 Digital Output

On this item, you can select the format of digital signal to be output from the OPTICAL and COAXIAL DIGITAL output terminals of this unit for respective formats recorded on DVD discs.

Depending on the format of digital signal, you can make this unit convert the disc’s original format of digital signal into PCM (48 kHz) format for outputting signals, or you can make this unit output no signal from the OPTICAL and COAXIAL DIGITAL output terminals of this unit.

- When the SET UP group “Audio Settings” is selected, press ∇ or \triangle to select “1 Digital Output”, and then press **SELECT**.

Audio Settings	DVD	VCD	Display	Audio
1	Digital Output			

- Press ∇ or \triangle to select the format of digital signal for which you will change the current setting, and then press **SELECT**.

Audio Settings	Digital Output	
1	96kHz LPCM	48kHz PCM
2	Dolby Digital	Disc Original
3	DTS	Disc Original
4	MPEG	PCM

- Press ∇ or \triangle to select the preferred mode, and then press **SELECT**.

Audio Settings	96kHz LPCM
* 1	48kHz PCM
2	OFF

Note

The settings on this item are only applicable when playing back a DVD.

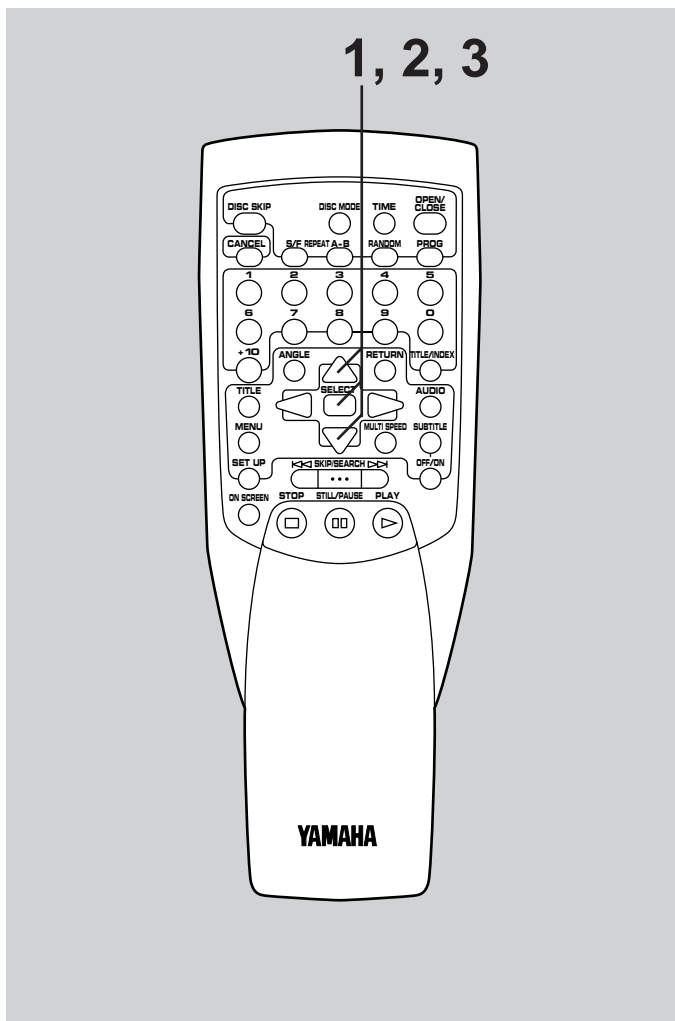

Selectable modes for respective formats of digital signals recorded on DVDs

Format recorded on the disc	Selectable modes	Format of signals output from the OPTICAL and COAXIAL DIGITAL terminals
1 96kHz LPCM [Linear PCM (96 kHz)]	1 48kHz PCM	PCM (2 ch) (48 kHz)
	2 OFF	No output
2 Dolby Digital	1 Disc Original	Dolby Digital bitstream (In this mode, the analog audio output terminals output no signal.)
	2 PCM	PCM (2 ch) (48 kHz/16 bit)
3 DTS	1 Disc Original	DTS bitstream (In this mode, the analog audio output terminals output no signal.)
	2 OFF	No output (In this mode, the analog audio output terminals output no signal.)
4 MPEG (2 or 1)	1 Disc Original	MPEG (2 or 1) bitstream (In this mode, the analog audio output terminals output no signal.)
	2 PCM	PCM (2 ch) (48 kHz/16 bit)

Factory default setting

- 1 96kHz LPCM: 48kHz PCM**
- 2 Dolby Digital: Disc Original**
- 3 DTS: Disc Original**
- 4 MPEG: PCM**

2 Dynamic Range Control (for China and General models only)

If you prefer, you can reduce dynamic range of sound source encoded with Dolby Digital. Dynamic range can be reduced in two steps with this unit.

Notes

- The settings on this item are only applicable when playing back a DVD encoded with Dolby Digital.
- The settings on this item are only effective when the "PCM" mode is selected for "Dolby Digital" of the item "1 Digital Output" on pages 59 and 60.

- 1 When the SET UP group "Audio Settings" is selected, press ∇ or \triangle to select "2 Dynamic Range Control", and then press **SELECT**.

Audio Settings	DVD	VCD	Display	Audio
1	Digital Output			
2	Dynamic Range Control		Maximum	
3	Speaker			

- 2 Press ∇ or \triangle to select the preferred mode, and then press **SELECT**.

Audio Settings	Dynamic Range Control
* 1	Maximum
2	Standard
3	Minimum

1 Maximum

A source is played back in the original sound track's wide dynamic range providing you with powerful sounds like a movie theater. Selecting this mode will be more ideal if you can listen to a source in a high output level in a room specially soundproofed for audio/video enjoyment.

2 Standard

A source is played back in the "compressed" dynamic range of the source suitable for low level listening.

3 Minimum

Dynamic range is more reduced than in the "Standard" position. Selecting this mode will be effective when you must listen to a source in an extremely low level.

* In this mode, it may happen that sound is output faintly or not output normally depending on a source. In that case, select "Maximum" or "Standard".

Factory default setting: Maximum

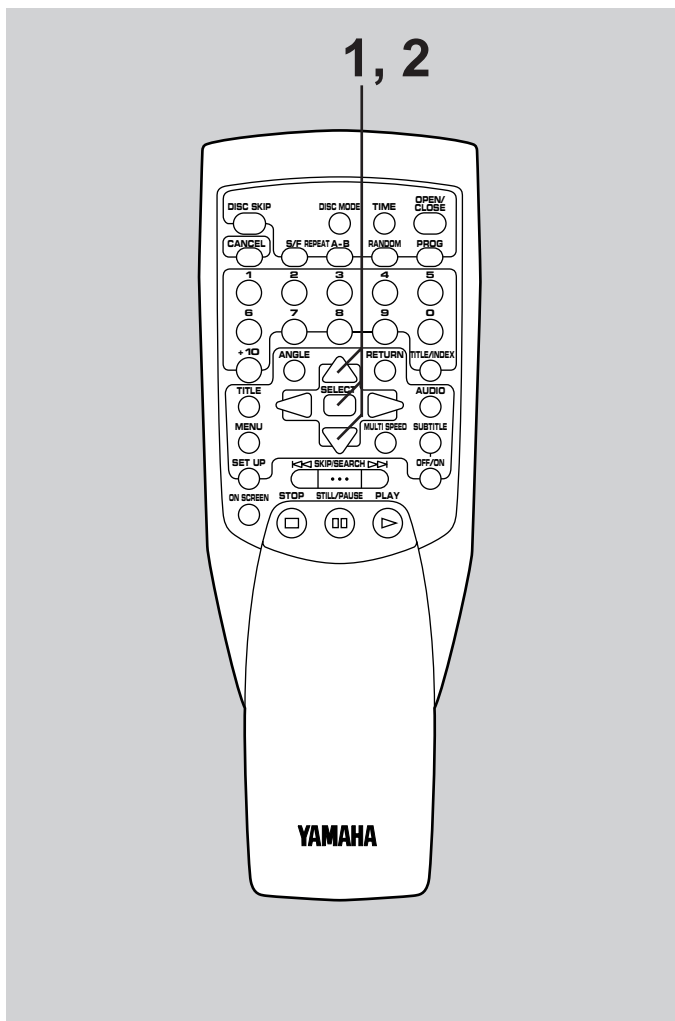

Dynamic range

"Dynamic range" is the difference between the maximum level and the minimum level of sounds. Sounds on a movie originally designed for movie theaters feature very wide dynamic range.

Dolby Digital technology can bring the original sound track into a home audio format with this wide dynamic range unchanged.

Powerful sounds of extremely wide dynamic range are not always suitable for home use. Depending upon the condition of your listening environment, it may not be possible to increase the sound output level as high as a movie theater. However, in a level suitable for listening in your room, the low level parts of source sound cannot be heard well because they will be lost among noises in your environment.

Dolby Digital technology also made it possible to reduce an original sound track's dynamic range for a home audio format by "compressing" the data of sound.

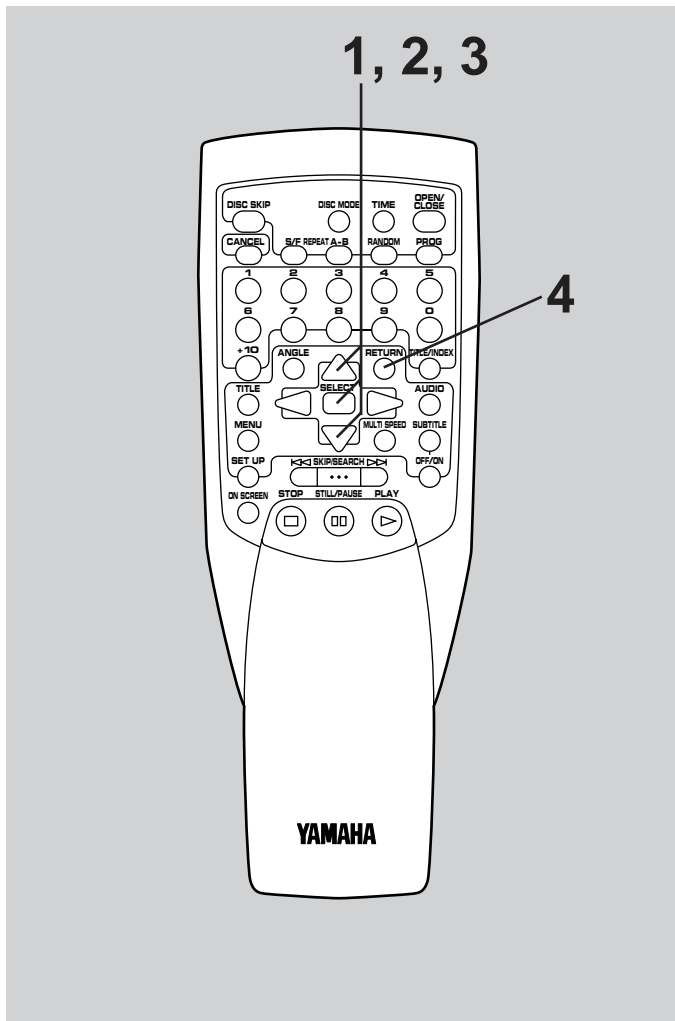

3 Speaker [DVD only] (for China and General models only)

Make this unit memorize what types of speakers are used in your speaker system. In doing so, this unit automatically decides the most efficient output mode of the 6CH DISCRETE terminals to maximize the performance of your speaker system.

1 When the SET UP group "Audio Settings" is selected, press ∇ or \triangle to select "3 Speaker", and then press **SELECT**.

Audio Settings	DVD	VCD	Display	Audio
1	Digital Output			
2	Dynamic Range Control		Maximum	
3	Speaker			

2 Press ∇ or \triangle to select the speaker(s) whose setting you want to change, and then press **SELECT**.

Audio Settings	Speaker
1 Main Speaker	Large
2 Center Speaker	Small
3 Surround Speaker	Small
4 Subwoofer	Yes

- 1 Main Speaker
- 2 Center Speaker
- 3 Surround Speaker
- 4 Subwoofer

3 Press ∇ or \triangle to select the proper mode, and then press **SELECT**.

(In case of "1 Main Speaker")

Audio Settings	Main Speaker
* 1	Large
2	Small

- 1 Large
- 2 Small

* Refer to the table on the next page for details about the selectable modes for respective speaker(s).

4 Press **RETURN** to return to the previous display mode.

5 Repeat steps 2 to 4 to change the setting for other speaker(s).

Selectable modes for respective speakers

Speaker(s)		Mode		Description
1	Main Speaker	1	Large	Select this mode if your main speakers have a high ability for bass reproduction.
		2	Small	Select this mode if your main speakers do not have a high ability for bass reproduction.
2	Center Speaker	1	Large	Select this mode if your center speaker has a high ability for bass reproduction.
		2	Small	Select this mode if you use a center speaker that is smaller than the main speakers.
		3	None	Select this mode if you do not have a center speaker.
3	Surround Speaker	1	Large	Select this mode if your surround speakers have a high ability for bass reproduction.
		2	Small	Select this mode if your surround speakers do not have a high ability for bass reproduction.
		3	None	Select this mode if you do not have surround speakers.
4	Subwoofer	1	Yes	Select this mode if your system includes a subwoofer.
		2	No	Select this mode if your system does not include a subwoofer.

Factory default setting

- 1 Main Speaker: Large
- 2 Center Speaker: Small
- 3 Surround Speaker: Small
- 4 Subwoofer: Yes

Notes

- The settings on this item are only applicable when playing back a DVD encoded with Dolby Digital.
- The settings on this item are only effective when the "PCM" mode is selected for "Dolby Digital" of the item "1 Digital Output" on pages 59 and 60.

Troubleshooting

Refer to the chart below when this unit does not function properly. If the problem you are experiencing is not listed below or if the instruction below does not help, disconnect the power cord and contact your authorized YAMAHA dealer or service center.

Common

Problem	Cause	What to Do
This unit does not turn on when the POWER switch is pressed.	The power cord is not connected or not completely connected.	Securely connect the power cord.
This unit does not work normally.	There is an influence of strong external noise (lightning, excessive static electricity, etc.) or a misoperation on this unit while using this unit.	Turn off this unit and disconnect the AC power cord from the AC outlet. After about 30 seconds have passed, connect the power and operate this unit again.
The disc table does not close completely.	A foreign object is obstructing the table.	Carefully check the disc table and remove the foreign object.
Play does not begin.	The disc is damaged.	Check the disc carefully; replace it if necessary.
	There is moisture on the laser pickup.	Wait 20 to 30 minutes after switching the unit ON before trying to play a disc.
	The disc has been loaded upside down.	Reload the disc with the label side up.
	The disc is dirty.	Clean the disc.
Play is delayed, or begins at the wrong place.	The disc may be scratched or damaged.	Check the disc carefully; replace it if necessary.
No sound.	Improper output cable connections.	Connect the cables properly. If the problem persists, the cables may be defective.
	Improper amplifier operation.	Set the amplifier controls to the correct input selection.
Sound "skips".	This unit is being subjected to vibrations or impacts.	Relocate this unit.
	The disc is dirty.	Clean the disc.
Sound "hums".	Improper cable connections.	Securely connect the audio cables. If the problem persists, the cables may be defective.
Noise from a nearby tuner.	The tuner is too close to this unit.	Move the tuner and this unit farther apart.
Noise from inside of the disc table.	A warped disc may be loaded.	Replace the disc.
The remote controller does not work.	The batteries of this remote controller are too weak.	Replace the batteries with new ones.
	Direct sunlight or lighting (of an inverter type of fluorescent lamp etc.) is striking the remote control sensor of the main unit.	Reposition the main unit.

For DVDs only

Problem	Cause	What to Do
The screen type (4:3 or 16:9) does not match your TV monitor.	The setting of "TV Type" on the SET UP menu is not proper.	Make a proper setting on "TV Type". (See page 45.)
Audio sound track and/or subtitle language is not the one selected on the SET UP menu.	If the audio sound track and/or subtitle language you selected does not exist on the disc, the priority language on the disc is used.	
No subtitles.	The disc does not have subtitles.	
	The display of subtitles is turned off.	Press the SUBTITLE OFF/ON button to turn on the display of subtitles.
Angle cannot be changed.	The scene (or the entire disc) currently played back has only one angle of view.	
Playback is not possible.	The rating level you set is lower than the level of the disc.	Change the setting of "Rating Level" on the SET UP menu to a higher level. (See pages 50 to 51.)
Picture is lightened and darkened alternately.	A disc recoded with copyright protection is played back when this unit is connected to the TV by way of a video cassette recorder.	Connect this unit to the TV directly or by way of an AV amplifier (or receiver).
No sound when digital signals from this unit is selected as the input source on the amplifier (or receiver).	The setting of "Digital Output" on the SET UP menu is not suitable for the digital terminal connections between this unit and the amplifier (or receiver).	Change the setting of "Digital Output" on the SET UP menu to the suitable setting. (See page 59.)
A loud hissing noise is heard when playing back a disc encoded with DTS.	This unit is not connected to a DTS decoder or an amplifier (or receiver) equipped with a DTS decoder.	Use "Digital Output" on the SET UP menu to select the "OFF" mode for "DTS".
A loud hissing noise is heard when playing back a disc encoded with MPEG.	This unit is not connected to a MPEG decoder or an amplifier (or receiver) equipped with a MPEG decoder.	Use "Digital Output" on the SET UP menu to select the "PCM" mode for "MPEG".
No sound when playing back a disc encoded with DTS.	Only analog terminal connections are made between this unit and the amplifier (or receiver).	No sound signals are output from the analog audio signal output terminals of this unit when playing back a disc encoded with DTS.

For Video CDs only

Problem	Cause	What to Do
No menu appears.	The setting of "Playback Control" on the SET UP menu is set to "OFF".	Change the setting of "Playback Control" on the SET UP menu to "ON". (See page 52.)
	The disc does not have a playback control function.	

Definition of terms

Title

"Title" is a unit to divide the contents on a DVD disc. Normally, one title is assigned to one movie. When a disc has two or more titles, they are numbered in sequence as title 1, title 2, etc.

Chapter

A title on a DVD is subdivided into smaller divisions. They are referred as "chapters" and numbered in sequence. They are useful for quick location of the desired scene on a movie etc.

Track

Tunes (or pictures) recorded on a CD or Video CD are referred as "tracks". Tracks are numbered in sequence as track 1, track 2, etc. They are useful for quick search for the desired tune (or picture).

Index

Some track on a Video CD or CD is subdivided into smaller divisions (such as, for example, the movements within classical symphonies) for easier location of those parts. They are referred as "indexes" and numbered in sequence.

Dolby Digital

Dolby Digital is a digital audio format which mainly provides high-quality multi-channel audio for sound tracks of movies. It provides us up to independent 6 channels compatible with the 6 speaker configuration: Left main, right main, center, left surround, right surround and subwoofer. It stores a large volume of digital sound signals (as data) into a laserdisc, DVD, etc. with a high level data-compression technology.

DTS

DTS (Digital Theater Systems) is also a multi-channel digital audio format. It provides us up to 6 channels. DTS encodes high-quality, 20-bit audio onto laserdiscs, compact discs and DVDs with less data-compression.

Linear PCM

A basic digital audio format used in CDs. It is based on Pulse Code Modulation (PCM), an analog-to-digital conversion technology. No compression is applied to the data.

MPEG 1 audio

A digital audio format mainly used in Video CDs. It is based on the MPEG (Moving Picture Expert Group) 1 format, a data compression technology.

MPEG 2 audio

A digital audio format mainly used in Europe, Australia, etc. It provides us high-quality multi-channel audio up to 8 channels in the same way as Dolby Digital and DTS. It is based on the MPEG 2 format, a data compression technology improved more than MPEG 1.

Playback control

This function is recorded on a Video CD, version 2.0. Pictures, music and information you want to play back can be selected on a screen menu shown on the TV monitor.









Language code list

Enter the appropriate code number for "Menu Language", "Subtitle Language" and/or "Audio Language" on the SET UP menu. (See pages 47 to 49.)

Code	Language Name	Code	Language Name	Code	Language Name	Code	Language Name
6565	Afar	7089	Frisian	7771	Malagasy	8377	Samoan
6566	Abkhazian	7165	Irish	7773	Maori	8378	Shona
6570	Afrikaans	7168	Scots Gaelic	7775	Macedonian	8379	Somali
6577	Amharic	7176	Galician	7776	Malayalam	8381	Albanian
6582	Arabic	7178	Guarani	7778	Mongolian	8382	Serbian
6583	Assamese	7185	Gujarati	7779	Moldavian	8383	Siswati
6589	Aymara	7265	Hausa	7782	Marathi	8384	Sesotho
6590	Azerbaijani	7273	Hindi	7783	Malay	8385	Sudanese
6665	Bashkir	7282	Croatian	7784	Maltese	8386	Swedish
6669	Byelorussian	7285	Hungarian	7789	Burmese	8387	Swahili
6671	Bulgarian	7289	Armenian	7865	Nauru	8465	Tamil
6672	Bihari	7365	Interlingua	7869	Nepali	8469	Telugu
6673	Bislama	7375	Inupiaq	7876	Dutch	8471	Tajik
6678	Bengali; Bangla	7378	Indonesian	7879	Norwegian	8472	Thai
6679	Tibetan	7383	Icelandic	7967	Occitan	8473	Tigrinya
6682	Breton	7384	Italian	7977	(Afan) Oromo	8475	Turkmen
6765	Catalan	7387	Hebrew	7982	Oriya	8476	Tagalog
6779	Corsican	7465	Japanese	8065	Punjabi	8478	Setswana
6783	Czech	7473	Yiddish	8076	Polish	8479	Tonga
6789	Welsh	7487	Javanese	8083	Pashto, Pushto	8482	Turkish
6865	Danish	7565	Georgian	8084	Portuguese	8483	Tsonga
6869	German	7575	Kazakh	8185	Quechua	8484	Tatar
6890	Bhutani	7576	Greenlandic	8277	Rhaeto-Romance	8487	Twi
6976	Greek	7577	Cambodian	8278	Kirundi	8575	Ukrainian
6978	English	7578	Kannada	8279	Romanian	8582	Urdu
6979	Esperanto	7579	Korean	8285	Russian	8590	Uzbek
6983	Spanish	7583	Kashmiri	8287	Kinyarwanda	8673	Vietnamese
6984	Estonian	7585	Kurdish	8365	Sanskrit	8679	Volapuk
6985	Basque	7589	Kirghiz	8368	Sindhi	8779	Wolof
7065	Persian	7665	Latin	8731	Sango	8872	Xhosa
7073	Finnish	7678	Lingala	8372	Serbo-Croatian	8979	Yoruba
7074	Fiji	7679	Laotian	8373	Singhalese	9072	Chinese
7079	Faeroese	7684	Lithuanian	8375	Slovak	9085	Zulu
7082	French	7686	Latvian, Lettish	8376	Slovenian		

Region Management Information (for DVDs only)

This DVD/Video CD/CD combi-player is designed and manufactured to conform to the Region Management Information that is recorded on a DVD disc. If the Region number of the DVD disc does not correspond to the Region number of this player, this player cannot play back the disc.

Model	Region number of this player	Region number or mark of discs which this player can play back
U.S.A. model		 ,  or a mark which includes the region number "1".
China model		 ,  or a mark which includes the region number "6".
General model		 ,  or a mark which includes the region number "3".

Notes about handling discs

- To remove a disc from its storage case, open the case and then press down at the center; with a finger through the center hole and the outer edges held as shown in the illustration, lift the disc out carefully.

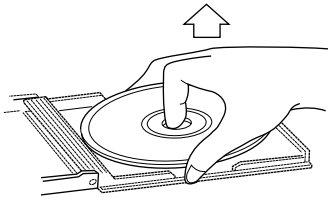

- Discs are not affected by small particles of dust or fingerprints on their playing surface, but even so they should be kept clean. Wipe by using a clean, dry cloth. Do not wipe with a circular motion; wipe straight outward from the center.

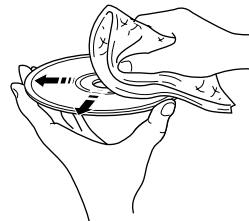

- Always handle the disc with care so that its surface is not scratched.

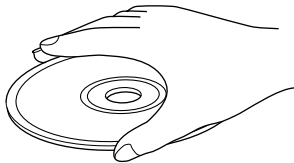

- Do not try to clean the disc's surface by using any type of disc cleaner, record spray, anti-static spray or liquid, or any other chemical-based liquid, because such substances might irreparably damage the disc's surface.
- Do not expose discs to direct sunlight, high temperature or high humidity for a long period of time, because these might warp or otherwise damage the disc.

- Discs are not subjected to wear during play, but damage to the disc surface when the disc is being handled can adversely affect the disc's play.

No!



Specifications

AUDIO SECTION

Frequency response	
DVD (48 kHz Sampling)	2 Hz to 22 kHz
DVD (96 kHz Sampling)	2 Hz to 44 kHz
CD, Video CD	2 Hz to 20 kHz

Harmonic distortion + noise (1 kHz) 0.002% or less

S/N ratio 115 dB or more (Weighted)

Dynamic range

DVD (48 kHz, 24 bit)	104 dB or more
CD, Video CD	100 dB or more

Output level (1 kHz, 0 dB) 2 ±0.3V

VIDEO SECTION

VIDEO output 1 Vp-p (75 ohms)

S VIDEO output

Y output 1 Vp-p (75 ohms)

C output

U.S.A. model	0.286 Vp-p (75 ohms)
China and General models	0.3 Vp-p (75 ohms)

COMPONENT VIDEO output

Y output 1 Vp-p (75 ohms)

Pb output

U.S.A. model	0.648 Vp-p (75 ohms)
China and General models	0.7 Vp-p (75 ohms)

Pr output

U.S.A. model	0.648 Vp-p (75 ohms)
China and General models	0.7 Vp-p (75 ohms)

GENERAL

Power requirements

U.S.A. model	120V, 60 Hz
China model	220V, 50 Hz
General model	110 to 240V, 50/60 Hz

Power consumption 30W

Dimensions (W x H x D)

(Without side panels)	435 x 116 x 404 mm (17-1/8" x 4-9/16" x 15-7/8")
(With side panels)	473 x 116 x 404 mm (18-5/8" x 4-9/16" x 15-7/8")

Weight

(Without side panels)	6.2 kg (13 lbs. 10 oz.)
(With side panels)	7.2 kg (15 lbs. 13 oz.)

Accessories Audio/video connection cord
Remote controller
Batteries (size AA, R6, UM-3)

Please note that all specifications are subject to change without notice.

This product incorporates copyright protection technology that is protected by method claims of certain U.S. patents and other intellectual property rights owned by Macrovision Corporation and other rights owners. Use of this copyright protection technology must be authorized by Macrovision Corporation, and is intended for home and other limited viewing uses only unless otherwise authorized by Macrovision Corporation. Reverse engineering or disassembly is prohibited.



YAMAHA ELECTRONICS CORPORATION, USA 6660 ORANGETHORPE AVE., BUENA PARK, CALIF. 90620, U.S.A.
YAMAHA CANADA MUSIC LTD. 135 MILNER AVE., SCARBOROUGH, ONTARIO M1S 3R1, CANADA
YAMAHA ELECTRONIK EUROPA G.m.b.H. SIEMENSSTR. 22-34, 25462 RELLINGEN BEI HAMBURG, F.R. OF GERMANY
YAMAHA ELECTRONIQUE FRANCE S.A. RUE AMBROISE CROIZAT BP70 CROISSY-BEAUBOURG 77312 MARNE-LA-VALLEE CEDEX02, FRANCE
YAMAHA ELECTRONICS (UK) LTD. YAMAHA HOUSE, 200 RICKMANSWORTH ROAD WATFORD, HERTS WD1 7JS, ENGLAND
YAMAHA SCANDINAVIA A.B. J A WETTERGRENS GATA 1, BOX 30053, 400 43 VÄSTRA FRÖLUNDA, SWEDEN
YAMAHA MUSIC AUSTRALIA PTY, LTD. 17-33 MARKET ST., SOUTH MELBOURNE, 3205 VIC., AUSTRALIA

YAMAHA CORPORATION
Printed in Japan  V267970-1