

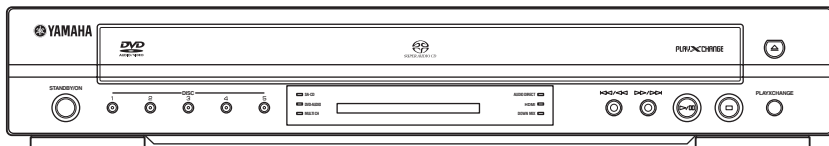

DVD AUDIO/VIDEO SA-CD CHANGER

DVD-C961

OWNER'S MANUAL

IMPORTANT SAFETY INSTRUCTIONS

	CAUTION RISK OF ELECTRIC SHOCK DO NOT OPEN	
CAUTION: TO REDUCE THE RISK OF ELECTRIC SHOCK, DO NOT REMOVE COVER (OR BACK). NO USER-SERVICEABLE PARTS INSIDE. REFER SERVICING TO QUALIFIED SERVICE PERSONNEL.		

- Explanation of Graphical Symbols



The lightning flash with arrowhead symbol, within an equilateral triangle, is intended to alert you to the presence of uninsulated “dangerous voltage” within the product’s enclosure that may be of sufficient magnitude to constitute a risk of electric shock to persons.



The exclamation point within an equilateral triangle is intended to alert you to the presence of important operating and maintenance (servicing) instructions in the literature accompanying the appliance.

IMPORTANT

Please record the serial number of this unit in the space below.

MODEL:

Serial No.:

The serial number is located on the rear of this unit. Retain this owner’s manual in a safe place for future reference.

- 1 Read these instructions.
- 2 Keep these instructions.
- 3 Heed all warnings.
- 4 Follow all instructions.
- 5 Do not use this apparatus near water.
- 6 Clean only with dry cloth.
- 7 Do not block any ventilation openings. Install in accordance with the manufacturer’s instructions.
- 8 Do not install near any heat sources such as radiators, heat registers, stoves, or other apparatus (including amplifiers) that produce heat.
- 9 Do not defeat the safety purpose of the polarized or grounding-type plug. A polarized plug has two blades with one wider than the other. A grounding type plug has two blades and a third grounding prong. The wide blade or the third prong are provided for your safety. If the provided plug does not fit into your outlet, consult an electrician for replacement of the obsolete outlet.
- 10 Protect the power cord from being walked on or pinched particularly at the plugs, convenience receptacles, and the point where they exit from the apparatus.
- 11 Only use attachments/accessories specified by the manufacturer.
- 12 Use only with the cart, stand, tripod, bracket, or table specified by the manufacturer, or sold with the apparatus. When a cart is used, use caution when moving the cart/apparatus combination to avoid injury from tip-over.
- 13 Unplug this apparatus during lightning storms or when unused for a long periods of time.
- 14 Refer all servicing to qualified service personnel. Servicing is required when the apparatus has been damaged in any way, such as power-supply cord or plug is damaged, liquid has been spilled or objects have fallen into the apparatus, the apparatus has been exposed to rain or moisture, does not operate normally, or has been dropped.
- 15 Be sure to allow spaces of at least 2.5 cm (1 inch) above, behind and on both sides of this unit.
- 16 Do not place the following objects on this unit: A vessel with water in it. If the vessel falls by vibrations and water spills, it may cause damage to the unit, and/or you may get an electric shock. Apparatus shall not be exposed to dripping or splashing.



FCC INFORMATION (for US customers)

1. IMPORTANT NOTICE: DO NOT MODIFY THIS UNIT!

This product, when installed as indicated in the instructions contained in this manual, meets FCC requirements. Modifications not expressly approved by Yamaha may void your authority, granted by the FCC, to use the product.

2. IMPORTANT: When connecting this product to accessories and/or another product use only high quality shielded cables. Cable/s supplied with this product MUST be used. Follow all installation instructions. Failure to follow instructions could void your FCC authorization to use this product in the USA.

3. NOTE: This product has been tested and found to comply with the requirements listed in FCC Regulations, Part 15 for Class "B" digital devices.

Compliance with these requirements provides a reasonable level of assurance that your use of this product in a residential environment will not result in harmful interference with other electronic devices. This equipment generates/uses radio frequencies and, if not installed and used according to the instructions found in the users manual, may cause interference harmful to the operation of other electronic devices. Compliance with FCC regulations does not guarantee that interference will not occur in all installations. If this product is found to be the source of interference, which can be determined by turning the product "OFF" and "ON", please try to eliminate the problem by using one of the following measures:
Relocate either this product or the device that is being affected by the interference.

Utilize power outlets that are on different branch (circuit breaker or fuse) circuits or install AC line filter/s.

In the case of radio or TV interference, relocate/reorient the antenna. If the antenna lead-in is 300 ohm ribbon lead, change the lead-in to coaxial type cable.

If these corrective measures do not produce satisfactory results, please contact the local retailer authorized to distribute this type of product. If you can not locate the appropriate retailer, please contact Yamaha Electronics Corp., 6660 Orangethorpe Ave. Buena Park, CA90622.

The above statements apply ONLY to those products distributed by Yamaha Corporation of America or its subsidiaries.

We Want You Listening For A Lifetime



Yamaha and the Electronic Industries Association's Consumer Electronics Group want you to get the most out of your equipment by playing it at a safe level. One that lets the sound come through loud and clear without annoying blaring or distortion - and, most importantly, without affecting your sensitive hearing. Since hearing damage from loud sounds is often undetectable until it is too late, Yamaha and the Electronic Industries Association's Consumer Electronics Group recommend you to avoid prolonged exposure from excessive volume levels.

CAUTION

Use of controls or adjustments or performance of procedures other than those specified herein may result in hazardous radiation exposure.

LASER

Type	Semiconductor laser GaAlAs
Wave length	650 nm (DVD) 780 nm (VCD/CD)
Output Power	7 mW (DVD/VCD/CD)
Beam divergence	60 degrees

CAUTION VISIBLE AND INVISIBLE LASER RADIATION WHEN OPEN. AVOID EXPOSURE TO BEAM

ADVARSEL SYNLIG OG USYNLIG LASERSTRÅLING VED ÅBNING
UNDGÅ UDSÆTTELSE FOR STRÅLING

ADVARSEL SYNLIG OG USYNLIG LASERSTRÅLING NÅR DEKSEL
ÅPNES UNNGÅ EKSPONERING FOR STRÅLEN

WARNING SYNLIG OCH OSYNLIG LASERSTRÅLING NÅR
DENNA DEL ÄR ÖPPNAD BETRÄKTA EJ STRÅLEN

VARO! AVATTAESSA OLET ALTIHINA NÄKYVÄLLE JA
NÄKYMÄTTÖMÄLLE LASER SÄTEILYLLE. ÄLÄ KATSO SÄTEESEEN

VORSICHT SICHTBARE UND UNSICHTBARE LASERSTRAHLUNG
WENN ABDECKUNG GEÖFFNET NICHT DEM STRAHL AUSSETZEN

DANGER VISIBLE AND INVISIBLE LASER RADIATION WHEN
OPEN AVOID DIRECT EXPOSURE TO BEAM

ATTENTION RAYONNEMENT LASER VISIBLE ET INVISIBLE EN
CAS D'OUVERTURE EXPOSITION DANGEREUSE AU FAISCEAU

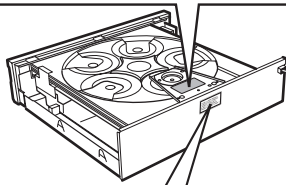

CLASS 1 LASER PRODUCT
LASER KLASSE 1 PRODUKT
LUOKAN 1 LASERLAITE
KLASS 1 LASER APPARAT
PRODUIT LASER DE CLASSE 1

LASER SAFETY

This unit employs a laser. Due to possible eye injury, only a qualified service person should remove the cover or attempt to service this device.

DANGER

This unit emits visible laser radiation when open. Avoid direct eye exposure to beam.

When this unit is plugged into a wall outlet, do not place your eyes close to the opening of the disc tray and other openings or look inside.

CAUTION: READ THIS BEFORE OPERATING THIS UNIT.

- 1 To assure the finest performance, please read this manual carefully. Keep it in a safe place for future reference.
- 2 Install this unit in a well ventilated, cool, dry, clean place — away from direct sunlight, heat sources, vibration, dust, moisture, or cold. In a cabinet, allow about 2.5 cm (1 inch) of free space all around this unit for adequate ventilation.
- 3 Locate this unit away from other electrical appliances, motors, or transformers to avoid humming sounds.
- 4 Do not expose this unit to sudden temperature changes from cold to hot, nor locate this unit in an environment with high humidity (i.e., a room with a humidifier) to prevent condensation inside this unit, which may cause an electrical shock, fire, damage to this unit, and/or personal injury.
- 5 Avoid installing this unit in a location where foreign objects may fall onto this unit or where this unit may be exposed to liquid dripping or splashing. On the top of this unit, do not place:
 - Other components, as they may cause damage and/or discoloration on the surface of this unit.
 - Burning objects (i.e., candles), as they may cause fire, damage to this unit, and/or personal injury.
 - Containers with liquid in them, as they may fall, spilling the liquid and causing an electrical shock to the user and/or damage to this unit.
- 6 Do not cover this unit with a newspaper, tablecloth, curtain, etc. in order not to obstruct heat radiation. If the temperature inside this unit rises, it may cause fire, damage to this unit, and/or personal injury.
- 7 Do not plug in this unit to a wall outlet until all connections are complete.
- 8 Do not operate this unit upside-down. It may overheat, possibly causing damage.
- 9 Do not use excessive force on switches, knobs and/or cords.
- 10 When disconnecting the power cord from the wall outlet, grasp the plug; do not pull the cord.
- 11 Do not clean this unit with chemical solvents; this might damage the finish. Use a clean, dry cloth.
- 12 Use only the voltage specified on this unit. Using this unit with a higher voltage than specified is dangerous and may cause fire, damage to this unit, and/or personal injury. Yamaha will not be held responsible for any damage resulting from use of this unit with a voltage other than as specified.
- 13 Do not attempt to modify or fix this unit. Contact qualified Yamaha service personnel when any service is needed. The cabinet should never be opened for any reason.
- 14 When not planning to use this unit for long periods of time (i.e., vacation), disconnect the AC power plug from the wall outlet.
- 15 Be sure to read the “Troubleshooting” section on common operating errors before concluding that this unit is faulty.
- 16 Before moving this unit, press STANDBY/ON to set the unit in standby mode, then disconnect the AC power plug from the wall outlet.
- 17 Install this unit near the AC outlet and where the AC power plug can be reached easily.
- 18 The batteries shall not be exposed to excessive heat such as sunshine, fire or the like.

The unit is not disconnected from the AC power source as long as it is connected to the wall outlet, even if this unit itself is turned off by STANDBY/ON. This state is called the standby mode. In this state, this unit is designed to consume a very small quantity of power.

FOR CANADIAN CUSTOMERS

To prevent electric shock, match wide blade of plug to wide slot and fully insert.

This Class B digital apparatus complies with Canadian ICES-003.

WARNING

TO REDUCE THE RISK OF FIRE OR ELECTRIC SHOCK, DO NOT EXPOSE THIS UNIT TO RAIN OR MOISTURE.

Be sure to place this unit on a level surface.

If you do not do so, the PLAYXCHANGE operation of this unit may not function correctly, and may damage the disc(s) and/or this unit itself.

Introduction	3
Region codes	3
Supplied accessories	3
Cleaning discs	3
Playable disc formats	3
Patent information	4

Functional Overview	5
Front panel	5
Remote control	6
Rear panel	8

Connections	9
General notes on connections	9
Audio connections	9
Digital connections.....	9
Analog connections	10
Video connections	11
S-video jack <A>	11
Composite video jack	11
Component video jacks <C>.....	11
HDMI connection	12
HDMI jack.....	12
HDMI output	12
Other connection	14
Remote control jacks.....	14
Connecting the power cable	14

Getting Started	15
Step 1: Inserting batteries into the remote control	15
Using the remote control.....	15
Step 2: Turning on the Power	15
Step 3: Setting language preference	16
Setting the OSD language	16
Setting the audio, subtitle and disc menu languages.....	16

Disc Operation	17
Basic operation	17
Selecting a track/chapter	17
Searching backward/forward.....	17
Repeat/Shuffle functions	18
Repeat playback	18
Repeating a section within a chapter/track.....	18
Shuffle playback (except DVD/VCD/SVCD).....	19

Preview functions (DVD/VCD/SVCD/CD)...	19
Previewing DVD/VCD/SVCD	19
Previewing CD	20
Previewing VR format	20

On-screen display (OSD) functions (DVD/VCD/SVCD/CD).....	20
Selecting the title/chapter/track (DVD/VCD/SVCD).....	21
Searching for a time (DVD/VCD/SVCD)	21
Selecting the audio/subtitle/angle (DVD).....	21
Selecting the repeat mode and time display (DVD/VCD/SVCD).....	21
Selecting the title/group and searching for a time (DVD-Audio)	21
Selecting the time display (CD).....	22

Operations for video playback (DVD-Video/VCD/SVCD)	22
Playback in slow motion.....	22
Frame-by-frame playback (DVD-Video/VCD/SVCD/DivX®)	22
Zooming pictures in/out.....	22
Resuming playback from the last stopped point...22	

Special DVD-Video features.....	23
Using the disc menu.....	23
Selecting the camera angle.....	23
Selecting the audio language/format and subtitle language	23

Special VCD/SVCD features.....	23
Using the playback control (PBC) menu	23
Special DVD-Audio features	24
Changing pages.....	24
Playing bonus groups.....	24

Special SA-CD features.....	24
Changing the playback layer and area	24
Playing data discs (MP3/WMA/JPEG/DivX®)	25
Selecting a folder and track/file.....	25

Special picture disc features	25
Using the preview function.....	25
Zooming pictures in.....	26
Rotating pictures (JPEG)	26
Selecting scan effect (JPEG).....	26
Playing MP3 music and JPEG pictures simultaneously	26

Special DivX® features	26
Using the interactive menu	26
Selecting the audio/subtitle language.....	26

Contents

Setup Menu	27
Menu overview	27
Setup menu operation	28
General setup menu	28
Selecting DVD-Audio/Video mode	28
Locking/Unlocking the disc for viewing.....	29
Programming tracks and discs.....	29
OSD language	30
Turning the screen saver on/off.....	30
Setting the sleep timer	30
Turning the auto standby function on/off.....	31
Displaying the DivX® VOD registration code	31
Audio setup menu.....	31
Setting the analog output.....	31
Setting the digital output	32
Setting the HDMI audio output	32
Turning the speaker setup on/off.....	32
Setting the speaker channels	33
Setting the CD upsampling	33
Turning the night mode on/off	34
Video setup menu	34
Setting a color system for your TV	34
Setting the TV display.....	35
Turning the black level on/off.....	35
Turning the closed caption on/off	35
Adjusting the picture settings	36
Adjusting the advanced picture settings	36
Turning the progressive scan function on/off	38
Preference setup menu	38
Audio, subtitle, disc menu.....	38
Restricting playback with parental control.....	38
Selecting the PBC (playback control) function.....	39
Selecting the MP3/JPEG menu	39
Selecting playback of VR format	39
Changing the password	39
Displaying DivX® external subtitle files	40
Resetting the system.....	40

Language Codes	41
Troubleshooting.....	42
Glossary.....	44
Specifications.....	46



Introduction

Thank you for purchasing this unit. This owner's manual explains the basic operation of this unit.

This manual is printed prior to production. Design and specifications are subject to change in part as a result of improvements, etc. In case of differences between the manual and the product, the product has priority.

Region codes

This unit is designed to support the region management system. Check the regional code number on the DVD disc package. If the number does not match the region code of this unit (see the table below or the back of this unit), this unit may be unable to play the disc.

Destination	Region code of this unit	Playable discs
U.S.A., Canada		 

Supplied accessories

- Remote control
- Two batteries (AA, R6, UM-3) for the remote control
- Audio/Video cable
- Power cable
- Owner's manual

Cleaning discs

- When a disc becomes dirty, clean it with a cleaning cloth. Wipe the disc from the center out. Do not wipe in a circular motion.
- Do not use solvents such as benzine, thinner, commercially available cleaners, or antistatic spray intended for analog records.

Playable disc formats

This unit is designed for use with discs having the logos shown below. Do not attempt to load any other type of disc into this unit.



This unit can play:

- DVD-RW discs recorded in VR format (compatible with CPRM)
- MP3, WMA and JPEG files recorded on CD-R/RW, DVD-R/RW, DVD+R/RW
- KODAK picture CDs, FUJICOLOR CDs
- ISO 9660 Level1/Level2 for CD-R/RW
- Maximum 30 character display
- DivX® files recorded on CD-R/RW, DVD-R/RW, DVD+R/RW
 - Official DivX® Ultra Certified product
 - Plays all versions of DivX® video (including DivX® 6) with enhanced playback of DivX® media files and the DivX® Media Format

Notes

- CD-R/RW, DVD-R/RW and DVD+R/RW/R DL cannot be played unless finalized.
- Progressive JPEG and copyright-protected WMA files cannot be played with this unit.
- Some discs cannot be played depending on disc characteristics or recording conditions.
- Be sure to use only CD-R/RW, DVD-R/RW and DVD+R/RW discs made by reliable manufacturers.
- Do not use any non-standard shaped discs (heart-shaped, etc.).
- Do not use discs with tape, seals, paste or many scratches on their surface.
- Do not use discs affixed with labels printed by a commercially available label printer.
- For details about playable formats, see "Specifications" on page 46.

Introduction

Patent information



Manufactured under license from Dolby Laboratories. “Dolby”, “Pro Logic” and the double-D symbol are trademarks of Dolby Laboratories.



“DTS” and “DTS Digital Surround” are registered trademarks of DTS, Inc.



DivX, DivX Ultra Certified, and associated logos are trademarks of DivX, Inc. and are used under license.



“DCDi” is a trademark of Faroudja, a division of Genesis Microchip, Inc.





HDMI

HDMI, the HDMI logo and High Definition Multimedia Interface are trademarks or registered trademarks of HDMI Licensing LLC.

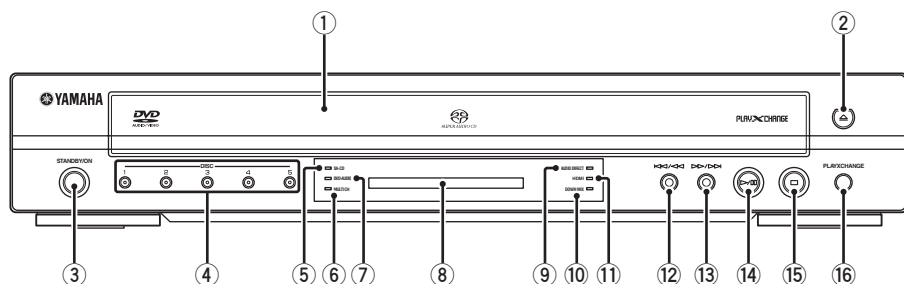
This product incorporates copyright protection technology that is protected by method claims of certain U.S. patents and other intellectual property rights owned by Macrovision Corporation and other rights owners. Use of this copyright protection technology must be authorized by Macrovision Corporation, and is intended for home and other limited viewing uses only unless otherwise authorized by Macrovision Corporation. Reverse engineering or disassembly is prohibited.

Front panel



- 1 Disc tray**
Loads up to 5 discs in the disc tray.
- 2 **
Opens or closes the disc tray.
- 3 **STANDBY/ON****
Turns on this unit or sets it to the standby mode.
- 4 **DISC 1-5 indicators****
Select and directly play back the preferred disc. Each indicator lights up in green when this unit recognizes that the corresponding disc has been loaded.
- 5 **SA-CD indicator****
Lights up when the unit detects SA-CD signals (see page 24).
- 6 **MULTI CH indicator****
Lights up when you play multi-channel audio source.
- 7 **DVD-AUDIO indicator****
Lights up when the unit detects DVD-Audio signals (see page 29).
- 8 **Front panel display****
Shows the current status of this unit.
- 9 **AUDIO DIRECT indicator****
Lights up when you select the audio direct mode by pressing AUDIO DIRECT on the remote control (see page 7).
- 0 **DOWN MIX indicator****
Lights up when playing the disc that allows down mixing of the DVD-Audio multi-channel source (see page 10).
- q **HDMI indicator****
Lights up when an HDMI component is connected, and signals output via the HDMI jack of this unit.
- w **
Moves to the previous (or top of the currently playing) chapter or track. Searches backward.*
- e **
Moves to the next chapter or track. Searches forward.*
- r **
Starts or pauses playback.
- t **
Stops playback.
- y **PLAYXCHANGE****
Reloads or unloads discs without interrupting current disc playback (see page 17).

* Press and hold the button for about two seconds.

Functional Overview

Remote control

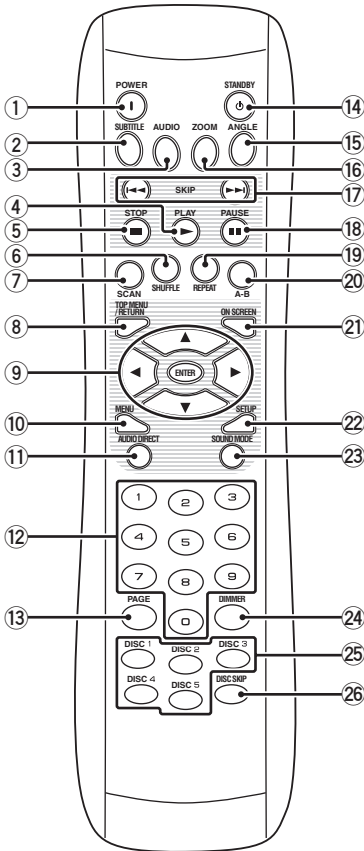

- 1 **POWER (I)**
Turns on this unit.
- 2 **SUBTITLE**
Selects the subtitle language (see pages 23 and 26).
- 3 **AUDIO**
Selects the audio language or format (see pages 23 and 26).
Changes the SA-CD playback layer (see page 24).
- 4 **PLAY (▶)**
Starts playback.
- 5 **STOP (■)**
Stops playback.
- 6 **SHUFFLE**
Accesses or exits from the shuffle mode (see page 19).
- 7 **SCAN**
Previews the content of a chapter/track or whole disc (DVD/VCD/SVCD) (see page 19).
Plays the first 6 seconds or less of each track (CD) (see page 20).
- 8 **TOP MENU/RETURN**
Displays the top-level disc menu (DVD).
Moves back to the previous menu (VCD) (see page 23).
- 9 **◀/▶/▲/▼**
Selects an item in the currently displayed menu.
Search or slow playback.
ENTER
Confirms the menu selection.
- 0 **MENU**
Displays the menu of a disc (DVD/JPEG) (see pages 23 and 25).
Switches PBC on or off (VCD/SVCD) (see page 23).

- q AUDIO DIRECT**
Turns off the video output during audio disc (CD/DVD-Audio/SA-CD) playback in order to improve audio quality. Press again to turn on the video output.
This function is not available for HDMI output. In the AUDIO DIRECT mode, the front panel display dims to "MODE 2".
- s SETUP**
Accesses or exits from the setup menu of this unit (see page 28).
- d SOUND MODE**
Selects a sound mode: stereo, virtual surround or multi-channel.
Changes the SA-CD playback area (see page 24).
- f DIMMER**
Selects from three different levels of brightness for the front panel display:
MODE 1: 70% brightness
MODE 2: 40% brightness and all the indicators on the front panel turn off.
NORMAL: 100% brightness
- g DISC 1-5**
Selects and directly plays back the preferred disc (see page 17).
- h DISC SKIP**
Selects another disc (see page 17).
- * Press and hold the button for about two seconds.
- Notes**
- You can turn on or off the AUDIO DIRECT mode only when playing back CD, DVD-AUDIO, or SA-CD disc.
 - The AUDIO DIRECT mode is canceled when you set this unit to the standby mode.
- w Numeric buttons (0-9)**
Selects numbered items in the currently displayed menu.
- e PAGE**
Selects the DVD-Audio still picture (see page 24).
- r STANDBY (⏻)**
Sets this unit to the standby mode.
- t ANGLE**
Selects the DVD camera angle (see page 23) and scan effect for JPEG (see page 26).
- y ZOOM**
Enlarges or lessens the video image (see pages 22 and 26).
- u SKIP (◀◀ / ▶▶)**
Moves to the previous (top of the currently playing)/next chapter or track.
Searches backward/forward (see page 17).*
- i PAUSE (⏸)**
Pauses playback temporarily.
Frame-by-frame playback.
- o REPEAT**
Accesses or exits from the repeat mode (see page 18).
- p A-B**
Repeats a specific segment (see page 18).
- a ON SCREEN**
Accesses or exits from the on-screen display (OSD) menu during playback (see page 20).

Functional Overview

Rear panel

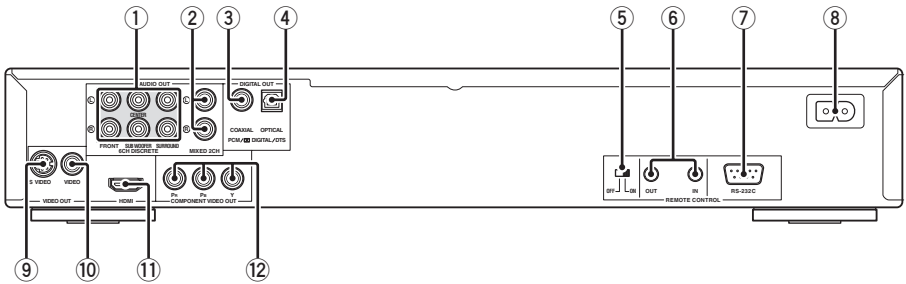

- 1 **AUDIO OUT (6CH DISCRETE) jacks**
Connect to the 6-channel input jacks of your AV receiver (see page 10).
- 2 **AUDIO OUT (MIXED 2CH) jacks**
Connect to the audio input jacks of your AV receiver or stereo system (see page 10).
- 3 **DIGITAL OUT (COAXIAL) jack**
Connect to the coaxial input jack of your AV receiver (see page 9).
- 4 **DIGITAL OUT (OPTICAL) jack**
Connect to the optical input jack of your AV receiver (see page 9).
- 5 **REMOTE CONTROL (ON, OFF) switch**
Switches the remote control on or off.
When using REMOTE CONTROL (IN, OUT) jacks or REMOTE CONTROL (RS-232C) terminal, set this switch to ON.
- 6 **REMOTE CONTROL (IN, OUT) jacks**
Connect to the remote control output/input jack of your Yamaha AV receiver/component (see page 14).
- 7 **REMOTE CONTROL (RS-232C) terminal**
Use as an expansion terminal for commercial use.
Consult your dealer for details.
- 8 **AC inlet**
Connect the supplied power cable (see page 14).
- 9 **VIDEO OUT (S VIDEO) jack**
Connect to the S-video input jack of your AV receiver (see page 11).
- 0 **VIDEO OUT (VIDEO) jack**
Connect to the composite video input jack of your AV receiver (see page 11).
- q **HDMI jack**
Connect to the HDMI input jack of your HDMI component (see page 12).
- w **COMPONENT VIDEO OUT (Y, Pb, Pr) jacks**
Connect to the component input jacks of your AV receiver (see page 11).

Note

Do not touch the inner pins of the jacks on the rear panel of this unit. Electrostatic discharge may cause permanent damage to this unit.

■ RS-232C terminal

The REMOTE CONTROL (RS-232C) terminal is used in custom installation. Do not connect any cables to this terminal during normal use.

General notes on connections

Be sure to turn off this unit and unplug the power cable before you make or change connections.

- Depending on the component you want to connect, there are various ways to make connections. Possible connections are described below.
- Refer to the manuals supplied with your other components as necessary to make the best connections.
- Do not connect this unit via your VCR. The video quality could be distorted by the copy protection system.
- Do not connect the audio out jack of this unit to the phono in jack of your audio system.

Audio connections

This unit has digital coaxial, digital optical, analog 6-channel discrete and analog mixed 2-channel output jacks. Connection depends on the availability of audio jacks on your component.

Digital connections

This unit has both coaxial and optical digital output jacks. Connect the DIGITAL OUT (COAXIAL) and/or DIGITAL OUT (OPTICAL) jack of this unit to your AV receiver equipped with a Dolby Digital, DTS, or MPEG decoder using a commercially available coaxial and/or optical cable.

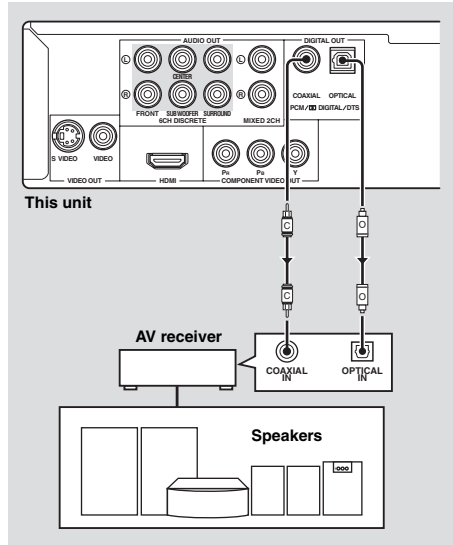

Notes

- You need to set [DIGITAL OUTPUT] to [ALL] (see "DIGITAL OUTPUT" on page 32).
- If the audio format of the digital output does not match the capabilities of your receiver, the receiver produces a distorted sound or no sound at all. Make sure to select the appropriate audio format from the menu screen on the disc. Pressing AUDIO on the remote control once or more may change not only the audio languages but also the audio format. The selected format appears in the front panel display for several seconds.
- SA-CD audio signals are not output at the DIGITAL OUT jacks.
- If you want to enjoy Dolby Digital, DTS and MPEG format, you must connect this unit to an AV receiver that supports these formats.

Connections

Analog connections

This unit has two types of analog output jacks.

■ 6-channel discrete jacks

If you want to reproduce multi-channel Super Audio CD (SA-CD) and DVD-Audio, connect AUDIO OUT (6CH DISCRETE) jacks of this unit to the corresponding input jacks of your AV receiver using commercially available audio pin cables.

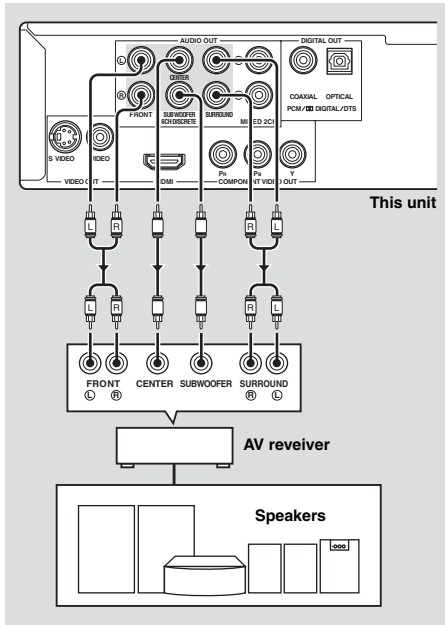

You can also enjoy Dolby Digital Surround and DTS Surround formats if your AV receiver does not support these formats.

In this case, set [ANALOG OUTPUT] to [MULTI-CHANNEL] (see “Setting the analog output” on page 31).

■ Mixed 2-channel jacks

Connect AUDIO OUT (MIXED 2CH) jacks of this unit to the corresponding input jacks of your audio component (such as a stereo amplifier) using the supplied audio/video cable. You can connect a subwoofer to the SUBWOOFER jack.

Multi-channel audio signals are down mixed to 2-channel audio signals. If you play back a down mix prohibited DVD-Audio, only the front L/R channel audio is output.

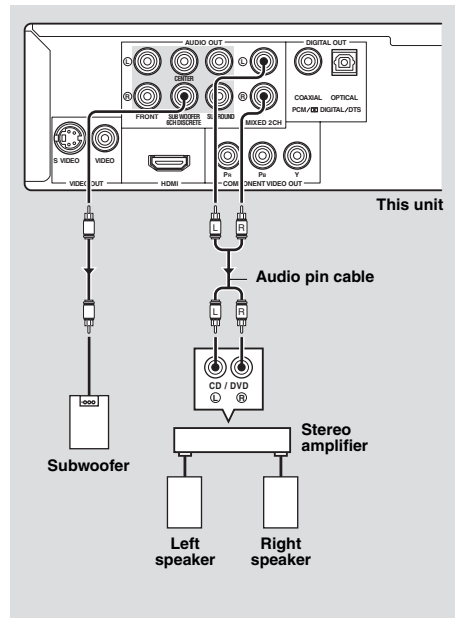

When you play back a down mix prohibited DVD-Audio, “NO DOWN MIX” appears in the front panel display, and the DOWN MIX indicator goes out.

Video connections

If your AV receiver has video output jacks, connect your receiver and then your TV so that you can use one TV for several different video sources (LD, VCR, etc.) by simply switching the input source selector of your receiver.

This unit has several types of video output jacks. Use the one that corresponds to the input jacks of the component to be connected.

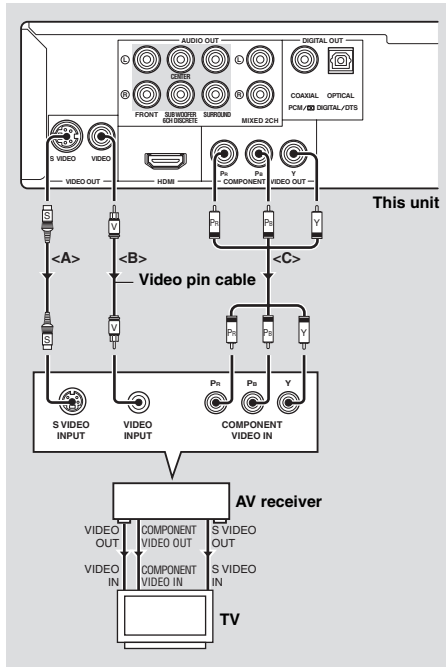

S-video jack <A>

S-video connections achieve a clearer picture than composite video connections by transmitting video signals on separate wires for luminance (Y) and chrominance (C). Connect the VIDEO OUT (S VIDEO) jack of this unit to an S-video input jack of your AV receiver and then to that of your TV using a commercially available S-video cable.

Composite video jack

Connect the VIDEO OUT (VIDEO) jack of this unit to a video input jack of your AV receiver and then to that of your TV using the supplied audio/video cable.

Component video jacks <C>

Component video connections achieve higher fidelity color reproduction than S-video connections by transmitting video signals on separate wires for luminance (Y: green) and chrominance (PB: blue, PR: red).

Connect the COMPONENT VIDEO OUT (Y, PB, PR) jacks of this unit to component input jacks of your AV receiver and then to those of your TV using a commercially available component cable. Observe the color of each jack when you make connections.

If your receiver does not have component output jacks, you can achieve a better video image by connecting the component output jacks of this unit directly to the component input jacks of your TV.



If your AV receiver is equipped with the video conversion function, you can connect the receiver and your TV using the different cables from shown above. For details, refer to the manual supplied with your receiver.

Connections

HDMI connection

HDMI jack

HDMI provides high quality digital audio and video on a single connection.

Connect the HDMI jack of this unit to an HDMI input jack of your AV receiver, and then to that of your TV using a commercially available HDMI cable.

If your receiver does not have an HDMI input jack, you can achieve a better video image by connecting the HDMI jack of this unit directly to the HDMI input jack of your TV.

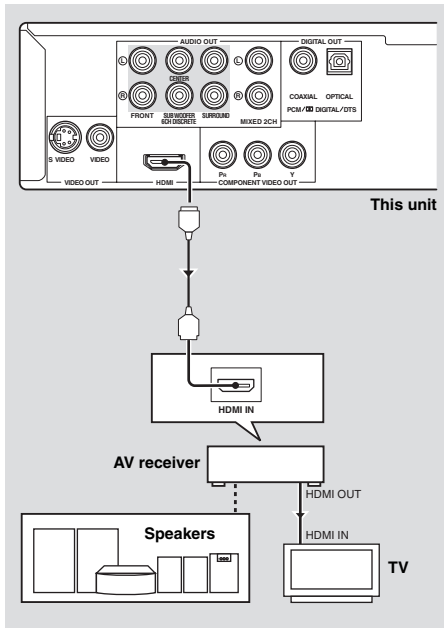

Notes

- You need to make appropriate audio connections if the connected component does not input audio signals (see “Audio connections” on page 9).
- This unit is not compatible with HDCP-incompatible HDMI or DVI components.
- You need a commercially available HDMI/DVI conversion cable when you connect this unit to other DVI components. In this case, the HDMI jack of this unit does not output any audio signals.
- Do not disconnect or turn off the power of the HDMI/DVI component connected to the HDMI jack of this unit while data is being transferred. Doing so may disrupt playback or cause noise.



When connecting an HDMI component, refer to the manual supplied with your component.

HDMI output

■ HDMI video output

This unit is compatible with the following video formats: 480p/60 Hz, 576p/50 Hz, 720p/60 Hz, 1080i/60 Hz, and 1080p/60 Hz.

Notes

- You need to set [HDMI VIDEO] (see page 37).
- Depending on the connected DVI component, black and white in the image may not be distinct. In that case, adjust the picture setting of the connected DVI component.

■ HDMI audio output

Audio format		Analog output	HDMI AUDIO		
			AUTO	PCM	OFF
DVD-Video	Dolby Digital Multi-channel	Multi	Dolby Digital*1,2	PCM Multi-channel*2	
		Stereo/V Surr		PCM 2-channel	
	Dolby Digital 2-channel	Multi/Stereo/V Surr	Dolby Digital*1	PCM 2-channel	
	DTS Multi-channel	Multi	DTS*1,2	PCM Multi-channel*2	
		Stereo/V Surr		PCM 2-channel	
	DTS 2-channel	Multi/Stereo/V Surr	DTS*1	PCM 2-channel	
	MPEG Multi-channel	Multi	MPEG*1,2	PCM Multi-channel*2	
		Stereo/V Surr		PCM 2-channel	
MPEG 2-channel	Multi/Stereo/V Surr	MPEG*1	PCM 2-channel		
PCM 2-channel*4	Multi/Stereo/V Surr	PCM 2-channel	PCM 2-channel		
DVD-Audio	Multi-channel	Multi	PCM (PPCM) Multi-channel*2,3	PCM (PPCM) Multi-channel*2,3	
		Stereo/V Surr	PCM (PPCM) 2-channel*3	PCM (PPCM) 2-channel*3	
	2-channel*4	Multi/Stereo/V Surr	PCM (PPCM) 2-channel	PCM (PPCM) 2-channel	
CD/MP3/WMA/DivX®	2-channel	Multi/Stereo/V Surr	PCM 2-channel	PCM 2-channel	
DTS-CD	Multi-channel	Multi	DTS*1,2	PCM Multi-channel*2	
		Stereo/V Surr		PCM 2-channel	
	2-channel	Multi/Stereo/V Surr	DTS*1	PCM 2-channel	
VCD	2-channel	Multi/Stereo/V Surr	PCM 2-channel	PCM 2-channel	
SVCD	Multi-channel	Multi	MPEG*1,2	PCM Multi-channel*2	
		Stereo/V Surr		PCM 2-channel	
	2-channel	Multi/Stereo/V Surr	MPEG*1	PCM 2-channel	
SA-CD	Multi-channel area	Multi	PCM Multi-channel*2,5	PCM Multi-channel*2,5	
	Stereo area	Stereo/V Surr	PCM 2-channel*5	PCM 2-channel*5	

Off

- *1: If the connected HDMI component does not support bitstream signals (Dolby Digital, DTS, and MPEG), the audio output is automatically changed from bitstream signals to PCM signals.
- *2: If the connected HDMI component does not support multi-channel audio signals, the audio output is automatically changed from PCM multi-channel signals to PCM stereo signals and 48 kHz/16 bits signals or less.
- *3: If the audio source is prohibited downmixing, the front L/R channel audio and 48 kHz/16 bits signals or less are output instead of downmixed stereo.
- *4: If the connected HDMI component does not support more than 48 kHz, the audio output is automatically changed to 48 kHz/16 bits signals or less.
- *5: If the connected HDMI component does not support the copy control information on disc, HDMI audio is muted and "AUDIO CANNOT BE OUTPUT FROM HDMI" appears on the bottom of the SA-CD menu.

Note

You need to set [HDMI AUDIO OUT] (see page 32).

Connections

Other connection

Remote control jacks

This unit has remote control input/output jacks. If your AV receiver is a Yamaha product and has the capability to transmit of SCENE control signals, you can use the SCENE function.

Connect the REMOTE CONTROL (IN) jack of this unit to a remote control output jack of your receiver using a commercially available monaural mini-jack cable so that this unit starts playback automatically by simply pressing a button of your receiver.

When using the REMOTE CONTROL (IN, OUT) jacks, set the REMOTE CONTROL (ON, OFF) switch to ON.

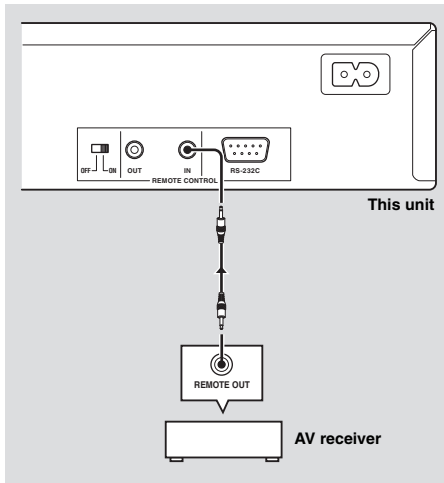

Connecting the power cable

After all other connections are complete, plug the supplied power cable into the AC inlet of this unit and then plug the power cable to an AC outlet.

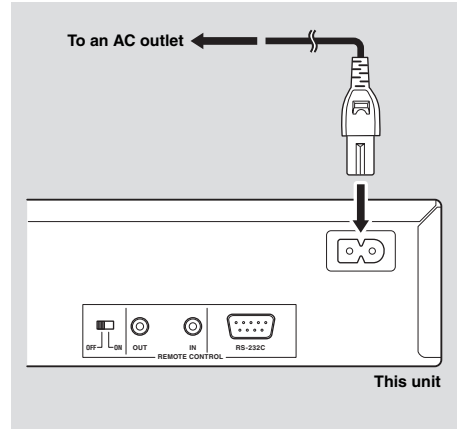

- For details about the SCENE function, refer to the owner's manual supplied with your Yamaha AV receiver.
- The REMOTE CONTROL (IN, OUT) jacks are also used in custom installation.

You can customize the various settings of this unit using the setup menu.



If the setting you have selected are not appropriate, you can reset all settings to the initial factory settings (see “Resetting the system” on page 40).

Step 1: Inserting batteries into the remote control

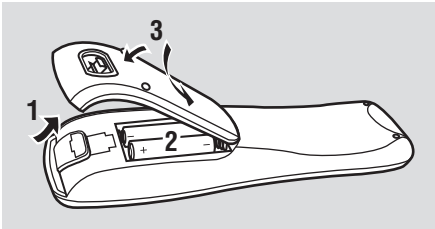

- 1 Open the battery compartment.
- 2 Insert the two supplied batteries (AA, R6, UM-3) following the indications (+/-) inside the compartment.
- 3 Close the cover.

Notes

- Insert batteries correctly according to the polarity markings (+/-). Batteries inserted in the opposite orientation may leak.
- Replace the exhausted batteries immediately with new ones to prevent leakage.
- Remove the batteries from the compartment if the remote control is not used for more than a month.
- If the batteries have leaked, dispose of them immediately. Avoid touching the leaked material or letting it come into contact with clothing, etc. Clean the battery compartment thoroughly before installing new batteries.
- Do not use old batteries together with new ones.
- Do not use different types of batteries (such as alkaline and manganese batteries) together. Read the packaging carefully as these different types of batteries may have the same shape and color.
- Dispose of the batteries correctly in accordance with your local regulations.

Using the remote control

Use the remote control within 6 m (approximately 20 ft) of this unit and point it toward the remote control sensor.

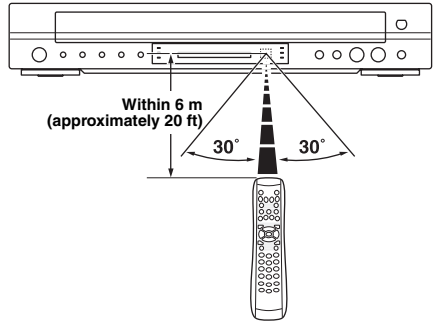

Notes

- Do not spill water or other liquids on the remote control.
- Do not drop the remote control.
- Do not leave or store the remote control in the following types of conditions:
 - places of high humidity, such as near a bath
 - places of high temperature, such as near a heater or stove
 - places of extremely low temperature
 - dusty places

Step 2: Turning on the Power

- 1 Make sure the power cable is plugged into an AC outlet.
- 2 Turn on your TV and AV receiver.
- 3 Select the appropriate input source of the AV receiver (refer to the manual supplied with your AV receiver).
- 4 Press **STANDBY/ON** on the front panel or **POWER (I)** on the remote control to turn on this unit.
 - The front panel display lights up.
- 5 Set the TV to the correct video input (refer to the manual supplied with your TV).
 - The default screen appears on the TV.

Getting Started

Step 3: Setting language preference

You can customize this unit using the setup menu displayed on the TV screen.



- Unless stated otherwise, all operations described here are carried out using the supplied remote control.
- To return to the previous menu, press ◀.
- To exit from the menu, press **SETUP**.
- To change settings other than [OSD LANGUAGE], [AUDIO], [SUBTITLE] and [DISC MENU], refer to “Setup Menu” on page 27.

Setting the OSD language

You can select your own preferred language for the setup menu. This setting remains once selected.



- 1 Press **SETUP**.
- 2 Press ◀/▶ to select “GENERAL SETUP PAGE”.
- 3 Press ▲/▼ to highlight [OSD LANGUAGE], and then press ▶.
- 4 Press ▲/▼ to select a language, and then press **ENTER**.

Setting the audio, subtitle and disc menu languages

You can select your own preferred language for the audio, subtitle and disc menu. This unit automatically switches to the selected language whenever you load a disc. If the selected language is not available on the disc, the default language of the disc will be used instead. These settings are only available for DVD-Video discs.



- 1 Press **STOP (■)** twice, and then press **SETUP**.
 - 2 Press ▶ repeatedly to select “PREFERENCE PAGE”.
 - 3 Press ▲/▼ to highlight one of the following options, and then press ▶.
 - **AUDIO** (audio language)
 - **SUBTITLE** (subtitle language)
 - **DISC MENU** (disc menu language)
 - 4 Press ▲/▼ to select a language, and then press **ENTER**.
 - 5 Repeat steps **3-4** for other language settings.
- **To select a language not in the list**
- 1 Select [OTHERS] in [AUDIO] or [SUBTITLE] or [DISC MENU].
 - 2 Use the **numeric buttons (0-9)** to enter the 4-digit language code (see “Language Codes” on page 41), and then press **ENTER**.



- If the prohibited icon (⊘) appears on the TV screen when a button is pressed, the function for that button is not available on the current disc or at the current time.
- Unless stated otherwise, all operations described here are carried out using the supplied remote control.
- Depending on the disc, some operations may operate differently or be restricted. Refer to the instruction supplied with the disc.

Note

Do not push on the disc tray or put any objects other than discs on the disc tray. Doing so may cause this unit to malfunction.

Basic operation

- 1 Make sure this unit is turned on.
- 2 Press \triangle on the front panel to open the disc tray.
- 3 Place the discs in the disc tray with the printed side up.

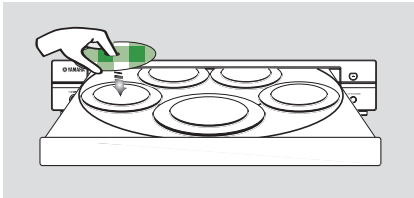

- 4 Press \triangle again to close the disc tray.
 - After recognizing the disc, this unit starts playback automatically.
 - If you press **PLAY** (\blacktriangleright) when the disc tray is open, the disc tray closes and playback starts automatically.

- 5 To play back a specific disc directly, press **DISC 1-5**.
 - You can also use the **DISC SKIP** button to play back a specific disc directly.
 - Press **PLAYXCHANGE** on the front panel to open the disc tray and reload/unload discs without interrupting current disc playback.
 - When the disc tray is opened, press $\blacktriangleright/\square$, \triangle , **PLAYXCHANGE** or **DISC 1-5** on the front panel to close the disc tray automatically.
- 6 To pause playback, press **PAUSE** (\parallel) during playback.
 - Playback is paused and the sound is muted.
- 7 To resume normal playback, press **PLAY** (\blacktriangleright).
- 8 To stop playback, press **STOP** (\blacksquare).

Selecting a track/chapter

- 1 Press **SKIP** ($\blacktriangleleft/\blacktriangleright$) or use the **numeric buttons (0-9)** to select a track/chapter number.
- 2 During repeated playback, press **SKIP** ($\blacktriangleleft/\blacktriangleright$) to replay the same track/chapter.

Searching backward/forward

- 1 Press and hold **SKIP** ($\blacktriangleleft/\blacktriangleright$) for about two seconds or press $\blacktriangleleft/\blacktriangleright$.
- 2 While searching, press **SKIP** ($\blacktriangleleft/\blacktriangleright$) or $\blacktriangleleft/\blacktriangleright$ repeatedly to select the desired speed (5 steps).
- 3 To resume normal playback, press **PLAY** (\blacktriangleright).

Notes

- The $\blacktriangleleft/\blacktriangleright$ button may not be available with some discs.
- For MP3 and WMA, the search function allows you to search the track currently being played.

Disc Operation

Repeat/Shuffle functions

Repeat playback

■ Repeating chapter/title/disc (DVD-Video)

Each time you press **REPEAT**, the display on the TV screen changes as follows:

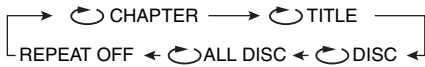

- ↻ **CHAPTER:** repeats the current chapter.
 - ↻ **TITLE:** repeats the current title.
 - ↻ **DISC:** repeats the entire disc.
 - ↻ **ALL DISC:** repeats all discs loaded in the tray.
- REPEAT OFF:** exits from the repeat mode.

Note

↻ **CHAPTER** and ↻ **DISC** features may not be available with some discs.

■ Repeating track/disc (except DVD)

Each time you press **REPEAT**, the display on the TV screen changes as follows:

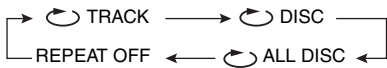

- ↻ **TRACK:** repeats the current track.
 - ↻ **DISC:** repeats the entire disc.
 - ↻ **ALL DISC:** repeats all discs loaded in the tray.
- REPEAT OFF:** exits from the repeat mode.

■ Repeating track/group/disc (DVD-Audio)

Each time you press **REPEAT**, the display on the TV screen changes as follows:



- ↻ **TRACK:** repeats the current track.
 - ↻ **GROUP:** repeats the current group.
 - ↻ **DISC:** repeats the entire disc.
 - ↻ **ALL DISC:** repeats all discs loaded in the tray.
- REPEAT OFF:** exits from the repeat mode.



If only one disc is available in the disc tray, it is continuously played when ↻ **ALL DISC** is selected.

Note

For VCD and SVCD, repeat playback is not available when the PBC mode is on.

Repeating a section within a chapter/track

- 1 While playing a disc, press **A-B** at the desired starting point.
 - ➔ “SET A” appears in the front panel display.
- 2 Press **A-B** again at the desired end point.
 - A and B can only be set within the same chapter/track.
 - ➔ “RPT AB” appears in the front panel display and the selected section repeats continuously.
- 3 To exit from the sequence, press **A-B**.

Shuffle playback (except DVD/VCD/SVCD)

You can play back tracks in a random order.

Each time you press **SHUFFLE**, the display on the TV screen changes as follows:

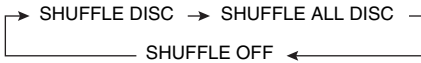

SHUFFLE DISC:

shuffles all tracks on the disc currently playing.

SHUFFLE ALL DISC:

shuffles tracks from all discs loaded in the tray.

SHUFFLE OFF:

exits from the shuffle mode.



- In the SHUFFLE DISC mode, hybrid SA-CD tracks on the SA-CD layer are played by default.
- In the SHUFFLE ALL DISC mode, only tracks from CD and SA-CD (CD layer) are played if the disc currently playing is a CD.
- In the SHUFFLE ALL DISC mode, tracks on the disc currently playing are played if that disc is SA-CD (SA-CD layer), MP3, WMA or DivX®. When all the tracks on that disc have been played, shuffle playback continues with the next disc.

Preview functions (DVD/VCD/SVCD/CD)

Previewing DVD/VCD/SVCD

1 Press **SCAN**.

→ A list appears on the TV screen.

```

SELECT DIGEST TYPE:
TITLE DIGEST
CHAPTER DIGEST
TITLE INTERVAL
CHAPTER INTERVAL
  
```

(Example of a list for DVD-Video)

2 Press **▲/** to highlight [TITLE DIGEST]/[GROUP DIGEST], [CHAPTER DIGEST]/[TRACK DIGEST], [TITLE INTERVAL]/[GROUP INTERVAL]/[DISC INTERVAL] or [CHAPTER INTERVAL]/[TRACK INTERVAL].

TITLE DIGEST (DVD-Video)/ GROUP DIGEST (DVD-Audio):

minimizes the picture for every title/group, and displays six at a time on the screen.

**CHAPTER DIGEST (DVD-Video)/
TRACK DIGEST (DVD-Audio/VCD/SVCD):** minimizes the picture for every chapter/track, and displays six at a time on the screen.

TITLE INTERVAL (DVD-Video)/ GROUP INTERVAL (DVD-Audio)/ DISC INTERVAL (VCD/SVCD):

divides a title/group/disc into six parts at regular intervals, and displays them on one page.

**CHAPTER INTERVAL (DVD-Video)/
TRACK INTERVAL (DVD-Audio/VCD/SVCD):** divides a single chapter/track into six parts at regular intervals, and displays them on one page.

Note

For VCD and SVCD, you can select [TRACK INTERVAL] only when the PBC function is turned off.

3 Press **ENTER**.

→ Thumbnail pictures appear on the TV screen.

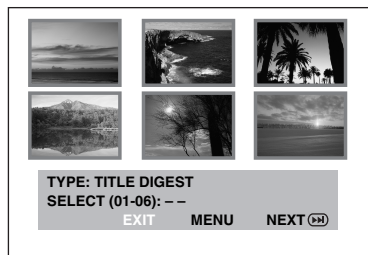

(Example of 6 thumbnails in the display)

Disc Operation

4 Use ◀/▶/▲/ to select a chapter/track or use the **numeric buttons (0-9)** to input the selected chapter/track number next to [SELECT].

5 Press **SKIP** (◀◀/▶▶) to open the previous or next page.

6 Press **ENTER** to play back the selected chapter/track.

■ To quit the preview function

Use ◀/▶/▲/ to highlight [EXIT] and press **ENTER**.

■ To return to the preview menu

Use ◀/▶/▲/ to highlight [MENU] and press **ENTER**.

Previewing CD

When playback is stopped, press **SCAN**.

→ Each track is played for a few seconds.

Previewing VR format

1 During playback, press **SCAN**.

→ A list appears on the TV screen.

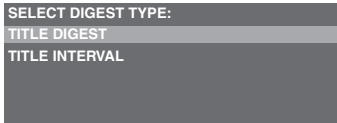

2 Press ▲/ to highlight [TITLE DIGEST], [TITLE INTERVAL].

TITLE DIGEST:

minimizes the picture for every title, and displays six at a time on the screen.

In [ORIGINAL LIST] mode, the originally recorded titles on the disc are displayed.

In [PLAY LIST] mode, every title in the playlist is displayed.

TITLE INTERVAL:

divides the contents of each title into six parts at regular intervals, and displays them on one page. If the title being played back is short, the TITLE DIGEST function is performed instead.



For details about [ORIGINAL LIST] and [PLAY LIST], see “Selecting playback of VR format” on page 39.

3 Follow the procedure in “Previewing DVD/VCD/SVCD” on page 19.

On-screen display (OSD) functions (DVD/VCD/SVCD/CD)

The OSD menu shows disc playback information (e.g., the title or chapter number, elapsed playing time or audio/subtitle language). A number of operations are possible without interrupting disc playback.

1 During playback, press **ON SCREEN**.

→ A list of available disc information appears on the TV screen.

DVD



VCD/SVCD

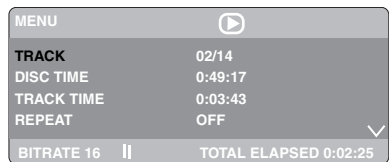

2 Press ▲/ to scroll the information and press **ENTER** to access the selected item.

3 Use the **numeric buttons (0-9)** to input the number/time or press ▲/ to make the selection, and then press **ENTER**.

→ Playback changes to the selected time or to the selected title/chapter/track.

Selecting the title/chapter/track (DVD/VCD/SVCD)

- 1 Press **▲/** to select [TITLE] or [CHAPTER] (DVD) or [TRACK] (VCD/SVCD).
- 2 Press **ENTER**.
- 3 Select a title, chapter or track number using the **numeric buttons (0-9)**.

Searching for a time (DVD/VCD/SVCD)

- 1 Press **▲/** to select [TT TIME] / [CH TIME] (DVD) or [TRACK TIME] / [DISC TIME] (VCD/SVCD).
 - [TT TIME] refers to the total time of the current title, and the [CH TIME] refers to the total time of the current chapter.
- 2 Press **ENTER**.
- 3 Enter hours, minutes and seconds from left to right using the **numeric buttons (0-9)** (e.g. 0:34:27).

Selecting the audio/subtitle/angle (DVD)

You can change [AUDIO], [SUBTITLE] or [ANGLE] if these functions are available on the disc you are playing.

- 1 Press **▲/** to select [AUDIO], [SUBTITLE] or [ANGLE].
- 2 Press **ENTER**.
- 3 For Audio and Subtitle:
Press **▲/** to highlight your selection and press **ENTER**.

For Angle:
Select an angle using the **numeric buttons (0-9)**.

Selecting the repeat mode and time display (DVD/VCD/SVCD)

You can change the repeat mode (see “Repeat playback” on page 18) and time display.

- 1 Press **▲/** to select [REPEAT] or [TIME DISP.].
- 2 Press **ENTER**.
- 3 Press **▲/** to highlight your selection, and then press **ENTER**.

Selecting the title/group and searching for a time (DVD-Audio)

Each time you press **ON SCREEN**, the menu on the TV screen changes as follows:

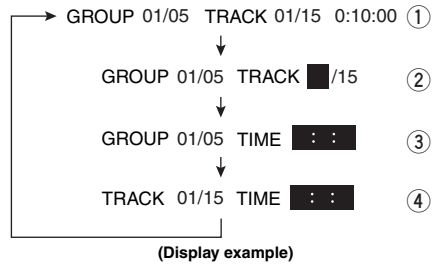

- 1 Displays the current group number/total number, the current track number/total number and elapsed playing time.
- 2 To select a track/group:
 - 1 Use **◀/▶** to highlight GROUP or TRACK.
 - 2 Enter a group/track number using the **numeric buttons (0-9)**.
 - 3 Press **ENTER** to confirm the selection, or wait for about 5 seconds without performing any operation.
- 3 To search for a time in a group:
Enter hours, minutes and seconds from left to right using the **numeric buttons (0-9)**.

Disc Operation

- To search for a time in a track:
Enter hours, minutes and seconds from left to right using the **numeric buttons (0-9)**.



If you enter a time outside the total time for the group/track currently being played during time search, “**INPUT INVALID**” is displayed on the TV screen.

Selecting the time display (CD)

Each time you press **ON SCREEN**, the menu on the TV screen changes as follows:

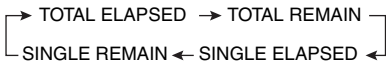

Operations for video playback (DVD-Video/VCD/SVCD)

Playback in slow motion

You can play back video in slow motion.

- Press **▲** for reverse slow motion or **▶** for forward slow motion.
- During slow motion, press **▲/▶** repeatedly to select the desired speed (1/2, 1/4, 1/8 or 1/16).
- To resume normal playback, press **PLAY (▶)** or **ENTER**.

Note

For VCD and SVCD, reverse slow motion is not available.

Frame-by-frame playback (DVD-Video/VCD/SVCD/DivX®)

You can play back a disc frame by frame.

- Press **PAUSE (||)** during playback.
→ Playback is paused and the sound is muted.
- Press **PAUSE (||)** repeatedly.
- To resume normal playback, press **PLAY (▶)**.

Zooming pictures in/out

You can enlarge or shrink the picture on the TV screen and pan through the enlarged picture.

- During playback, press **ZOOM** repeatedly to display the picture at different scales (2, 3, 4x, 1/2, 1/3 or 1/4).
 - Use **◀/▶/▲/▼** to pan through the enlarged/lessened picture.→ Playback continues.
- Press **ZOOM** repeatedly to return to the original size.

Resuming playback from the last stopped point

You can resume playback of the last ten discs, even if the discs were ejected or the power of this unit was turned off.

- Load one of the last ten discs.
→ “LOADING” appears on the TV screen.
- Press **PLAY (▶)** while “LOADING” is displayed on the TV screen.
→ “RESUME PLAY” appears on the TV screen and the disc is played back from the last point.

■ To cancel the resume mode

When playback is stopped, press **STOP** (■) again.

Note

For DivX®, resume playback is not available if the discs were ejected.

Special DVD-Video features

Using the disc menu

1 Press **MENU**.

- The disc title menu appears on the TV screen.
- Depending on the disc, a menu may appear on the TV screen once you load the disc.

2 Use **◀/▶/▲/▼** or the **numeric buttons (0-9)** to select a playback option.

3 Press **ENTER**.

■ To exit from the menu

Press **MENU**.

Selecting the camera angle

If the disc contains multi-angle options, you can view the picture from a number of different angles.



Viewing angles available for each disc may vary. Refer to the operating instructions in the disc menu or on its jacket.

Press **ANGLE** repeatedly to select the desired angle.

- The angle icon appears on the TV screen.

Selecting the audio language/ format and subtitle language

If the disc contains multi-language options, you can select audio/subtitle languages.



Languages available for each disc may vary. Refer to the operating instructions in the disc menu or on its jacket.

■ To select an audio language/format

Press **AUDIO** repeatedly to select an audio language and/or format.

■ To select a subtitle language

Press **SUBTITLE** repeatedly to select a subtitle language.

Special VCD/SVCD features

Using the playback control (PBC) menu

For a VCD/SVCD with a playback control (PBC) feature (version 2.0 only)

1 Press **MENU** to toggle between “PBC ON” and “PBC OFF”.

- If you select “PBC ON”, the disc menu appears (if available) on the TV screen.

2 Use the **numeric buttons (0-9)** to select a playback option.

- Press **SKIP** (◀◀/▶▶) to move to the previous/next page (if available).

3 During playback, press **TOP MENU/RETURN** to return to the menu screen.

■ To skip the index menu and play back a disc from the beginning

Press **MENU** to turn off the PBC function.

Disc Operation

Special DVD-Audio features

Changing pages

Many DVD-Audio discs include slide show and page turn functions. You can display information pages for photo galleries, artist biographies, lyrics, etc. if these functions are available on the disc.

Press ◀/▶ to move to the previous/next page.

OR

Press **PAGE** repeatedly to move to the next page.

Playing bonus groups

Some DVD-Audio discs contain bonus groups that require a four-digit password to gain access. In this case, refer to the disc jacket and other packaging for information.

- 1 When playback is stopped, enter the desired bonus group number using the **numeric buttons (0-9)**, and then press **ENTER**.
- 2 Enter a four-digit password using the **numeric buttons (0-9)**, and then press **ENTER**.

OR

- 1 During playback, press **ON SCREEN** twice.
→ The group and track list appears on the TV screen.
- 2 Press ◀ to highlight a group.
- 3 Enter the desired bonus group number using the **numeric buttons (0-9)**, and then press **ENTER**.
- 4 Enter a four-digit password using the **numeric buttons (0-9)**, and then press **ENTER**.

Special SA-CD features

Changing the playback layer and area

There are three types of SA-CD (Super Audio CD) discs: single-layer, dual-layer and hybrid. Each type may contain up to two areas of recorded information: a high quality stereo area and a high quality multi-channel area. You can switch between the SA-CD multi-channel and SA-CD stereo areas.

Note

SA-CD text is not supported with this unit.



For details about SA-CD, see "Super Audio CD" on page 45.

■ To change the playback area

During playback, press **SOUND MODE**.

OR

- 1 When playback is stopped, press ◀ to display folders.
- 2 Press ▲/ to select the folder, and then press **ENTER**.
- 3 Press ▲/ to select the track, and then press **ENTER**.

Note

Even when you change the playback area using **SOUND MODE**, this unit selects the playback area according to [ANALOG OUTPUT] setting in "AUDIO SETUP PAGE" for other discs.

■ To change the playback layer

- 1 Press **STOP (■)** to stop playback.
- 2 Press **AUDIO**.
→ SA-CD indicator lights up only when the SA-CD layer is selected.
 - Once CD layer is selected, this unit always starts playing the CD layer until this unit is set to the standby mode.

Playing data discs (MP3/WMA/JPEG/DivX®)

- 1 Load a data disc.
 - The disc reading time may exceed 30 seconds due to the complexity of the directory/file configuration.
 - The data disc menu appears on the TV screen.



- 2 Playback starts automatically. If not, press **PLAY** (▶).
- 3 Press **SKIP** (◀◀/▶▶) to select another track/file in the current folder.

Notes

- For JPEG, this unit is compatible with size of 3072 x 2048 pixels or less. However, some files may not be displayed correctly depending on the aspect ratio of the image.
- The file name that can be displayed conforms to ISO 9660.
- This unit can play up to 298 folders and up to 648 files per folder with up to 8 hierarchies.
- It may not be possible to play certain MP3/WMA/JPEG/DivX® discs due to the configuration and characteristics of the disc or the recording conditions.
- Also see “Specifications” on page 46 for more information.

Selecting a folder and track/file

- 1 Press ▲/ to select the folder and press **ENTER** to open the folder.
- 2 Press ▲/ to select a track/file.

- 3 Press **ENTER**.
 - Playback starts from the selected file to the end of the folder.

Special picture disc features

- 1 Load a picture disc (JPEG, Kodak Picture CD or Fujicolor CD).
 - For JPEG, the picture menu appears on the TV screen.
 - For Kodak Picture CD and Fujicolor CD, the slideshow begins.

■ For JPEG

- 2 Press **PLAY** (▶) to start the slideshow.

Using the preview function

This function displays the content of the current folder or the entire disc.

- 1 Press **STOP** (■) during playback.
 - 12 thumbnails appear on the TV screen.

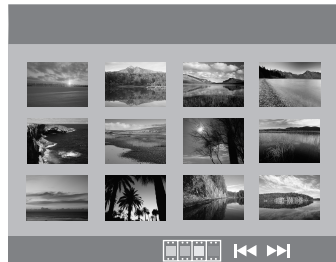

- 2 Press **SKIP** (◀◀/▶▶) to display the other thumbnails on the previous/next page.
- 3 Use ◀/▶/▲/ to highlight one of the thumbnails, and then press **ENTER** to start playback.

OR

Move the cursor to highlight [] on the bottom of the page to start playback from the first thumbnail on the current page.

■ For JPEG

- 4 Press **MENU** to return to the JPEG disc menu.

Disc Operation

Zooming pictures in

- 1 During playback, press **ZOOM** repeatedly to display the picture at different scales (ZOOM 100%, 125%, 150% or 200%).
 - Use ◀/▶/▲/▼ to pan through the enlarged picture.
- 2 Press **ZOOM** repeatedly to return to the original size.

Rotating pictures (JPEG)

During playback, press ◀/▶/▲/▼ to rotate the picture on the TV screen.

- ◀: rotates the picture counter-clockwise
- ▶: rotates the picture clockwise
- ▲: flips the picture vertically
- ▼: flips the picture horizontally

Selecting scan effect (JPEG)

During playback, press **ANGLE** repeatedly to select the desired scan effect.

Playing MP3 music and JPEG pictures simultaneously

- 1 Load a disc that contains both music and picture data.
 - The disc menu appears on the TV screen.
- 2 Select an MP3 music track.
- 3 During MP3 music playback, select a JPEG picture file from the TV screen and then press **PLAY** (▶).
 - The picture files are played back one after another until the end of the folder.
- 4 To quit simultaneous playback, press **MENU** and then **STOP** (■).

Note

Some files cannot be played correctly depending on disc characteristics or recording conditions.

Special DivX® features

DivX® files including DMF (DivX® Media Format) features only

Using the interactive menu

- 1 Load a disc.
 - The interactive menu appears on the TV screen.
 - 2 Use ◀/▶/▲/▼ to select a chapter.
 - 3 Press **ENTER** or **PLAY** (▶) to start playback of the selected chapter.
- **To access the interactive menu**
During playback, press **MENU**.
 - **To return to the data disc menu screen**

When the interactive menu is displayed, press **STOP** (■).

Selecting the audio/subtitle language

- **To select an audio language**
During playback, press **AUDIO** to switch the audio language recorded on the contents.
- **To select a subtitle language**
During playback, press **SUBTITLE** to switch or turn on/off the subtitle language recorded on the contents.



For information about external subtitle files, see "Displaying DivX® external subtitle files" on page 40.

Menu overview

The bold items/parameters listed below are the default settings.

Setup page	Menu item	Setting Item/Submenu	Setting item/Parameter	Page
GENERAL SETUP PAGE	DVD-AUDIO	DVD-AUDIO MODE , DVD-VIDEO MODE		28
	DISC LOCK	LOCK , UNLOCK		29
	PROGRAM	FTS , FDS		29
	OSD LANGUAGE	ENGLISH , FRANÇAIS, ESPAÑOL, 中文		30
	SCREEN SAVER	ON , OFF		30
	SLEEP	15, 30, 45, 60 MINS, OFF		30
	AUTO STANDBY	ON , OFF		31
	DIVX(R) VOD CODE	(DivX® registration code is displayed)		31
AUDIO SETUP PAGE	ANALOG OUTPUT	STEREO, VIRTUAL SURR, MULTI-CHANNEL		31
	DIGITAL AUDIO	DIGITAL OUTPUT	OFF, ALL , PCM ONLY	32
		LPCM OUT	48KHz , 96KHz	
	HDMI AUDIO OUT	AUTO , PCM, OFF		32
	SPEAKER SETUP	ON , OFF		32
	SPEAKERS	FRONT SPEAKER	LARGE , SMALL	33
		CENTER SPEAKER, SURROUND SP	OFF, LARGE , SMALL	
		SUBWOOFER	ON , OFF	
		SPEAKERS VOLUME	-12dB to 0dB (-6dB)	
		SPEAKERS DELAY	0 MS to 15 MS	
CD UPSAMPLING	OFF , 88.2kHz (X2), 176.4kHz (X4)		33	
NIGHT MODE	ON , OFF		34	
VIDEO SETUP PAGE	TV TYPE	PAL, NTSC , MULTI		34
	TV DISPLAY	4:3 PAN SCAN, 4:3 LETTER BOX, 16:9		35
	BLACK LEVEL	ON , OFF		35
	CLOSED CAPTION	ON , OFF		35
	PICTURE SETTING	STANDARD , BRIGHT, SOFT		36
		PERSONAL (BRIGHTNESS)	-20 to +20 (0)	
		(SHARPNESS)	-7 to +7 (0)	
		(CONTRAST)	-16 to +16 (0)	
		(TINT, COLOR)	-9 to +9 (0)	
	ADV PICTURE	DCDI	OFF, ON	36
		GAMMA	-7 to +7 (0)	
		CHROMA DELAY	-3 to +3 (0)	
		WIDE SCREEN FORMAT	NL STRETCH, 4:3 PILLAR BOX, OFF	37
		HDMI VIDEO	480P, 576P, 720P, 1080i, 1080P, AUTO	
		TRUE LIFE	0 to 5 (0)	
		DVI OUTPUT RANGE	ENHANCED, STANDARD	
PROGRESSIVE	OFF , ON	38		
PREFERENCE PAGE	AUDIO	ENGLISH (for [AUDIO] and [DISC MENU]),	38	
	SUBTITLE	OFF (for [SUBTITLE]), etc.		
	DISC MENU			
	PARENTAL	1 KID SAFE, 2 G, 3 PG, 4 PG 13, 5 PGR, 6 R, 7 NC 17, 8 ADULT	38	
	PBC	ON , OFF	39	
	MP3/JPEG NAV	WITH MENU, WITHOUT MENU	39	
	VR LIST	ORIGINAL LIST , PLAY LIST	39	
	PASSWORD	CHANGE	39	
	DIVX SUBTITLE	GROUP1 , GROUP2	40	
DEFAULT	RESET	40		

Setup Menu

Setup menu operation

Setup is carried out via the TV, enabling you to customize this unit to suit your own particular requirements. Follow the procedures below to start the setup menu operations.



- To return to the previous menu, press **◀**.
- To exit from the menu, press **SETUP**.
- If the settings you have selected are not appropriate, you can reset all settings to the initial factory settings (see “Resetting the system” on page 40).
- Refer to the following pages for details of the menu that requires a particular operation.

Note

You cannot select “PREFERENCE PAGE” during playback. Press **STOP (■)** twice to display this page.

1 Press **SETUP**.

→ The setup page and menu items appear on your TV.

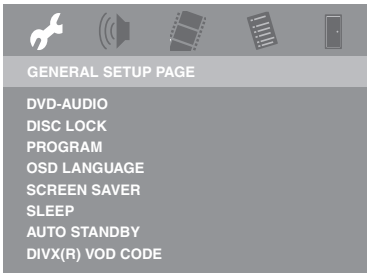

2 Press **◀/▶** to select the desired setup page.

3 Press **▲/▼** to highlight the desired menu item.

→ Menu items and setting items appear.

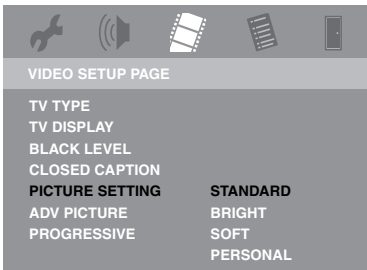

→ If setting items do not appear, the selected menu item has submenus. In this case, press **ENTER** and then repeat step 3.

4 Press **▶**.

5 Press **▲/▼** to select the desired setting item, and then press **ENTER**.

→ If the parameter appears, press **◀/▶** to adjust the setting and then press **ENTER**.



General setup menu

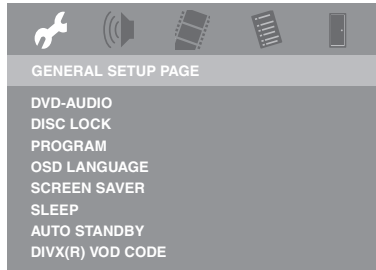

Selecting DVD-Audio/Video mode

Some DVD-Audio discs contain the DVD-Video content in addition to the DVD-Audio content. You can select DVD-Audio or DVD-Video mode.

- Select [DVD-AUDIO] in “GENERAL SETUP PAGE”.

DVD-AUDIO MODE

Select this to play back both DVD-Audio and DVD-Video contents. Only the DVD-Audio content may be played back depending on the disc.

DVD-VIDEO MODE

Select this to play back only the DVD-Video content.

Note

This setting is only available when the DVD-Audio disc is loaded and playback is stopped.



- When a DVD-Audio disc is played back in [DVD-AUDIO MODE], the DVD-AUDIO indicator lights up.
- When you select [DVD-VIDEO MODE], the DVD-AUDIO indicator goes out.

Locking/Unlocking the disc for viewing

Not all discs are rated or coded by the manufacturer of the disc. You can prevent playback of a specific disc by locking the disc. You can lock up to 40 discs on this unit.

- Select [DISC LOCK] in “GENERAL SETUP PAGE”.

LOCK

Select this to lock playback of the current disc. Subsequent access to a locked disc requires a six-digit password.

The default password is “000 000” (see “Changing the password” on page 39).

UNLOCK

Select this to unlock the disc and allow future playback.

Programming tracks and discs

Programming tracks (except SA-CD/ Picture CD/MP3/WMA/DivX®)

You can play back the contents of a disc in the desired order by programming the tracks to be played. You can store up to 20 tracks per disc with a maximum of ten discs.

- 1 Select [PROGRAM] in “GENERAL SETUP PAGE”.

- 2 Press **▶** to select [F.TS], and then press **ENTER**.

→ The input menu appears on the TV screen.

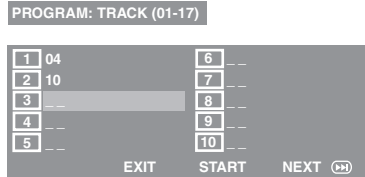

■ To input your favorite tracks/ chapters

- 3 Use the **numeric buttons (0-9)** to enter a valid track/chapter number.

- 4 Use **◀/▶/▲/▼** to move the cursor to the next position.

- If the track/chapter number is more than ten, press **SKIP (▶▶)** to move to the next page, and then proceed with programming.

OR

- Use **◀/▶/▲/▼** to highlight [NEXT] on the program menu, and then press **ENTER**.

- 5 Repeat steps **3-4** to input another track/ chapter number.

■ To remove a track

- 6 Use **◀/▶/▲/▼** to move the cursor to the track you want to remove.

- 7 Press **ENTER** to remove this track from the program menu.



For SA-CD, you can program tracks on the CD layer.

Setup Menu

Programming discs

You can play back discs in the desired order by programming the discs to be played. You can store up to 5 discs.

- 1 Select [PROGRAM] in “GENERAL SETUP PAGE”.
- 2 Press ► to select [FDS], and then press **ENTER**.
→ The input menu appears on the TV screen.

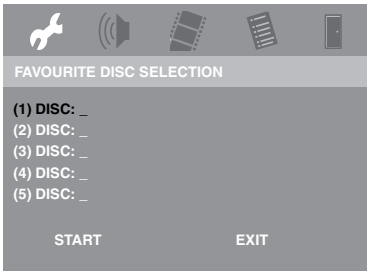

■ To input your favorite discs

- 3 Use the **numeric buttons (0-9)** to enter a valid disc number.
- 4 Use ◀/▶/▲/ to move the cursor to the next position.
- 5 Repeat steps 3-4 to input another disc number.

■ To remove a disc

- 6 Use ◀/▶/▲/ to move the cursor to the disc you want to remove.
- 7 Press **0** on the **numeric buttons (0-9)** to remove this disc from the program menu.

■ To start program playback

- 8 Use ◀/▶/▲/ to highlight [START] on the program menu, and then press **ENTER**.
→ Playback starts for the selected tracks or discs in the programmed sequence.

■ To exit from program playback

- 9 Use ◀/▶/▲/ to highlight [EXIT] on the program menu, and then press **ENTER**.



Program playback is canceled once tracks/discs on the menu are played back to the end.

OSD language

This menu contains various options for the on-screen display (OSD) language. For details, see “Setting the OSD language” on page 16.

Turning the screen saver on/off

This function is used to turn on or off the screen saver. You can prevent the display from burning by turning on the screen saver.

- Select [SCREEN SAVER] in “GENERAL SETUP PAGE”.

ON

Select this to turn off the TV screen when disc playback is stopped or paused for more than 15 minutes.

OFF

Select this to disable the screen saver function.

Setting the sleep timer

This function automatically sets this unit to the standby mode after a certain elapsed period.

- Select [SLEEP] in “GENERAL SETUP PAGE”.

15, 30, 45, 60 MINS

Select one to set the sleep timer function.

OFF

Select this to cancel the sleep timer function.

Turning the auto standby function on/off

This function is used to turn on or off the auto standby function.

- Select [AUTO STANDBY] in “GENERAL SETUP PAGE”.

ON

Select this to set this unit to the standby mode automatically when disc playback is stopped for more than 30 minutes or when the disc menu is displayed for more than three hours without performing any operation.

OFF

Select this to disable the auto standby function.

Displaying the DivX® VOD registration code

Yamaha provides you with a DivX® VOD (Video On Demand) registration code that allows you to rent and purchase videos using the DivX® VOD service. For more information, visit “<http://www.divx.com/vod>”.

- 1 Select [DIVX(R) VOD CODE] in “GENERAL SETUP PAGE”, and then press ►.
→ The registration code appears.
- 2 Press **ENTER** to exit.



To purchase or rent the videos from DivX® VOD service at “<http://www.divx.com/vod>”, use the registration code and download the video onto a CD-R for playback on this unit.

Note

All of the downloaded videos from DivX® VOD can only be played back on this unit.

Audio setup menu

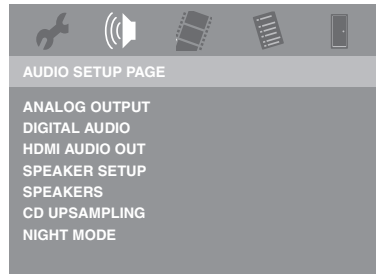

Setting the analog output

Set the analog output to match the playback capability of this unit.

- Select [ANALOG OUTPUT] in “AUDIO SETUP PAGE”.

STEREO

Select this to change channel output to stereo, which only delivers sound from the two front speakers and subwoofer.

VIRTUAL SURR

Select this to reproduce the surround channels virtually.

MULTI-CHANNEL

Select this setting when using a multi-channel audio/(video) receiver with 6 channel inputs. In this mode, this unit performs DTS decoding or Dolby Digital 5.1-channel decoding when applicable, and Dolby Pro Logic decoding on DVD-Video, CD, VCD and SVCD discs with 2-channel sound tracks. No Dolby Pro Logic decoding is done with DVD-Audio and SA-CD discs.

Notes

- Even if you select [STEREO], audio signals are not output at the subwoofer when [SUBWOOFER] is set to [OFF] (see pages 33).
- Dolby Pro Logic II is not available for signals output at the HDMI jack.

Setup Menu

Setting the digital output

You can set the digital output and LPCM output.

- Select [DIGITAL AUDIO] in “AUDIO SETUP PAGE”.

DIGITAL OUTPUT

Set the digital output according to your optional audio component connections.

OFF

Select this to turn off the digital output.

ALL

Select this if you have connected the digital audio output jack to a multi-channel decoder/receiver.

Dolby Digital, DTS, MPEG-2 and PCM digital audio signals are output.

Also refer to the manual supplied with the connected component.

PCM ONLY

Select this only if your receiver is not capable of decoding multi-channel audio signals.

Multi-channel audio signals are converted to 2-channel linear PCM audio signals.

LPCM OUT

Select this if you have connected this unit to a PCM-compatible receiver via a digital jack, such as a coaxial jack. In this case, you may need to adjust [LPCM OUT].

Discs are recorded at a certain sampling rate. The higher the sampling rate, the better the sound quality.

48KHz

Select this to play back discs recorded at the sampling rate of 48 kHz. All higher than 48 kHz PCM data streams (if available) are converted to the sampling rate of 48 kHz or lower.

96KHz

Select this to play back discs recorded at the sampling rate of 96 kHz. If higher than 48 kHz disc is copy protected, the digital output is automatically converted to the sampling rate of 48 kHz or lower.

Notes

- When HDMI audio signals are output, you cannot select [DIGITAL AUDIO].
- When Dolby Pro Logic II decoder is activated, the sampling rate of digital output is limited to 48 kHz or lower.

Setting the HDMI audio output

When you connect this unit to an HDMI compatible component via the HDMI jack, set the HDMI audio output to match the connected component. For details about the relationship between the audio format and the setting, see “HDMI audio output” on page 13.

- Select [HDMI AUDIO OUT] in “AUDIO SETUP PAGE”.

AUTO

Select this to set this unit to the best setting automatically based on the component you have connected via the HDMI jack.

PCM

Select this to output the decoded multi-channel or 2-channel PCM audio signals via the HDMI jack. To select multi-channel or 2-channel output, set [ANALOG OUTPUT] (see page 31).

OFF

Select this to turn off the HDMI audio output.

Notes

- If the monitor/receiver connected to this unit using HDMI does not support HDMI audio signal input, set this setting to [OFF].
- When [HDMI AUDIO OUT] is set to [AUTO] or [PCM], digital output signals are muted.

Turning the speaker setup on/off

This function is used to enable or disable the speaker settings.

- Select [SPEAKER SETUP] in “AUDIO SETUP PAGE”.

ON

Select this to enable to set [SPEAKERS] (see pages 33).

OFF

Select this to disable to set [SPEAKERS].
 In this setting, [SPEAKERS] is automatically set to the following options:
 FRONT SPEAKER/CENTER SPEAKER/
 SURROUND SP: LARGE
 SUBWOOFER: ON
 SPEAKERS VOLUME: 0dB.
 SPEAKERS DELAY: 0 MS.

Setting the speaker channels

You can set the sizes, volume levels and delay times for individual speakers.

- Select [SPEAKERS] in “AUDIO SETUP PAGE”.

FRONT SPEAKER, CENTER SPEAKER, SURROUND SP

Set the sizes for front/center/surround speakers.

OFF ([CENTER SPEAKER] and [SURROUND SP] only)

Select this when no speakers are connected.

LARGE

Select this if the connected speakers can reproduce low frequency signals below 120 Hz.

SMALL

Select this if the connected speakers cannot reproduce low frequency signals below 120 Hz.

SUBWOOFER

Select on or off for the subwoofer.

ON

Select this if a subwoofer is connected.

OFF

Select this if no subwoofer is connected.

SPEAKERS VOLUME

Adjust the volume level for individual speakers.

Control range: **-12dB to 0dB**

SPEAKERS DELAY

Adjust the delay time in relation to the listening position/distance for center and surround speakers.

Control range: **0 MS to 15 MS**

Notes

- When [SPEAKER SETUP] is set to [OFF], you cannot select [SPEAKERS].
- When [FRONT SPEAKER] is set to [SMALL], [SUBWOOFER] is automatically set to [ON].
- When audio signals are output at the HDMI jack, [SPEAKER SETUP] is automatically set to [OFF].



- Use a longer delay time setting when the surround speakers are closer to the listener than the front speakers.
- A test tone is automatically generated to help you judge the sound level of each speaker.

Setting the CD upsampling

You can convert your music CD to a higher sampling rate using sophisticated digital signal processing for better sound quality. If you activate the upsampling function, this unit automatically switches to the stereo mode.

- Select [CD UPSAMPLING] in “AUDIO SETUP PAGE”.

OFF

Select this to disable CD-upsampling.

88.2kHz (X2)

Select this to convert the sampling rate of CD to twice that of the original.

176.4kHz (X4)

Select this to convert the sampling rate of CD to four times that of the original.

Note

Even when you select [176.4kHz (X4)], the digital output signals are upsampled to 88.2 kHz.

Setup Menu

Turning the night mode on/off

In the night mode, high volume output is softened and low volume output is brought upward to an audible level. It is useful when you want to watch your favorite action movie without disturbing others at night.

- Select [NIGHT MODE] in “AUDIO SETUP PAGE”.

ON

Select this to level out the volume. This feature is only available for movies with the Dolby Digital mode.

When you select this setting, invalidate the dynamic range compression (DRC) of the connected component.

OFF

Select this when you want to enjoy the full dynamic range of surround sound.

Video setup menu

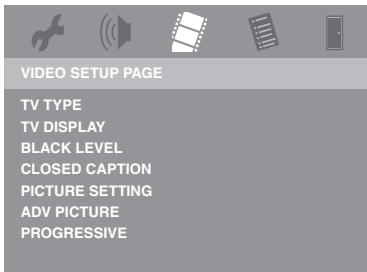

Setting a color system for your TV

This unit is compatible with both NTSC and PAL video formats. Select the color system that matches your TV.

- Select [TV TYPE] in “VIDEO SETUP PAGE”.

PAL

Select this if the connected TV is a PAL system TV. It will change the video signals of NTSC discs and output them in PAL format.

NTSC

Select this if the connected TV is an NTSC system TV. It will change the video signals of PAL discs and output them in NTSC format.

MULTI

Select this if the connected TV is compatible with both NTSC and PAL formats (such as a multi-system TV).

The output format will be in accordance with the video signals of the disc.

Notes

- Before changing the current TV standard setting, ensure that your TV supports the selected TV type.
- If the picture is not displayed properly on your TV, wait for 15 seconds for this unit to activate automatic recovery.
- When making HDMI connections, you cannot select [TV TYPE].

■ Video output table when progressive is on

Disc format	TV TYPE	Output format	
		Component video	Composite video/S-video
NTSC	PAL	576p	480i
	NTSC	480p	480i
	MULTI	480p	480i
PAL	PAL	576p	575i
	NTSC	480p	575i
	MULTI	576p	575i

Note

When [PROGRESSIVE] is set to [ON] (see pages 38), composite video/S-video output depends on the format of the disc.

Setting the TV display

Set the aspect ratio of this unit to match your TV. The format you select must be available on the disc. Otherwise, the TV display setting will not affect the picture during playback.

- Select [TV DISPLAY] in “VIDEO SETUP PAGE”.

4:3 PAN SCAN

Select this if the aspect ratio of your TV is 4:3 and you want both sides of the picture to be trimmed or formatted to fit your TV screen.

4:3 LETTER BOX





Select this if the aspect ratio of your TV is 4:3. In this case, a wide picture with black bands on the upper and lower portions of the TV screen are displayed.

16:9



Select this if you have a widescreen TV.

■ The relationship between the setting of this unit and the TV display

When the aspect ratio of your TV is 4:3:

Setting	Playback disc	TV display	
4:3 PAN SCAN	16:9		*1
	4:3		
4:3 LETTER BOX	16:9		
	4:3		

When the aspect ratio of your TV is 16:9:

Setting	Playback disc	TV display	
16:9	16:9		
	4:3		*2

*1: If the disc is not assigned to playback in panscan, it is played in letterbox.

*2: The side of the picture may be stretched depending on the TV. In this case, check the screen size and aspect ratio of your TV.

Turning the black level on/off

If [TV TYPE] is set to [NTSC] (see page 34), set the black level to on to improve the color contrast during playback. The black level setting has no effect if [TV TYPE] is set to [PAL].

- Select [BLACK LEVEL] in “VIDEO SETUP PAGE”.

ON

Select this to enhance the black level.

OFF

Select this for the standard black level setting.

Note

This function is available for interlaced video format only.

Turning the closed caption on/off

Closed captions are data hidden in the video signals of specific discs and are invisible without the use of a special decoder. The difference between subtitles and captions is that subtitles are intended for hearing persons and captions are for the hearing impaired. Subtitles rarely show all of the audio. For example, captions show sound effects (e.g., “phone ringing”, “footsteps”), while subtitles do not.

Before you select this function, ensure that the disc contains closed caption information and your TV also supports this function.

- Select [CLOSED CAPTION] in “VIDEO SETUP PAGE”.

ON

Select this to enable the closed caption function.

OFF

Select this to disable the closed caption function.

Note

This function is available for interlaced video format only.

Setup Menu

Adjusting the picture settings

This unit comes with three predefined sets of picture color settings and one personal setting that you can define yourself.

- Select [PICTURE SETTING] in “VIDEO SETUP PAGE”.

STANDARD

Select this for the standard picture setting.

BRIGHT

Select this to make the TV picture brighter.

SOFT

Select this to make the TV picture softer.

PERSONAL

Select this to personalize your picture color by adjusting the brightness, sharpness, contrast, tint and color (saturation).

BRIGHTNESS

Increase or decrease the value to adjust the overall brightness. Zero (0) is the average brightness setting value.

Control range: **-20 to +20**

SHARPNESS

Increase or decrease the value to adjust the sharpness of edges in the image. Zero (0) is the average sharpness setting value.

Control range: **-7 to +7**

CONTRAST

Increase or decrease the value to adjust the contrast between a light portion and dark portion. Zero (0) is the average contrast setting value.

Control range: **-16 to +16**

TINT

Increase or decrease the value to adjust the density of color. Zero (0) is the average tint setting value.

Control range: **-9 to +9**

COLOR

Increase or decrease the value to adjust the red/green balance. Zero (0) is the average color setting value.

Control range: **-9 to +9**

Note

All picture settings are not available for HDMI output.

Adjusting the advanced picture settings

You can fine-tune the following video parameters.

We recommend setting the aspect ratio on your TV if the function is available.

- Select [ADV PICTURE] in “VIDEO SETUP PAGE”.

DCDi

DCDi (Directional Correction Deinterlacing) computes and tracks the angle of the screen edge to fill in the missing pixel on the TV screen. DCDi optimizes the image quality significantly, especially during the slow motion playback. This function is available for progressive scan output only.

OFF

Select this to disable the DCDi function.

ON

Select this to enable the DCDi function.

GAMMA

Adjust the intensity of the picture non-linearly. A positive value enables you to bring out low level detail in dark scenes, while a negative value emphasizes contrast. This function is not available for HDMI output.

Control range: **-7 to +7**

CHROMA DELAY

The chroma (color) and luminance (brightness) signals are not synchronized. You can adjust the advance delay of the chroma signal to yield a perfectly clear picture. This function is not available for HDMI output.

Control range: **-3 to +3**

WIDE SCREEN FORMAT

Set the aspect ratio of the projected images on the screen. This function is only available for progressive scan and HDMI output.

NL STRETCH

Select this to display a 4:3 image on the 16:9 screen with non-linear stretching (center position of screen is stretched less than the sides).

4:3 PILLAR BOX

Select this to display a 4:3 image on the 16:9 screen without stretching.

OFF

No aspect ratio adjustment is made when this option is selected.

Note

[WIDE SCREEN FORMAT] setting is effective when [TV DISPLAY] is set to [16:9] and the aspect ratio of the image is 4:3.

HDMI VIDEO

Set the resolution depending on the monitor you are using. This function is only available when you connect this unit to an HDMI compatible component via the HDMI jack.

480P

480p/60 Hz progressive-scan video

576P

576p/50 Hz progressive-scan video

720P

720p/60 Hz progressive-scan video

1080I

1080i/60 Hz interlace video

1080P

1080p/60 Hz progressive-scan video

AUTO

The resolution is automatically selected to match the component you are using.

Notes

- For settings other than [AUTO], HDMI video signals may not be output properly if a resolution output setting is not supported by the HDMI component you are using. In this case, follow the steps below to change the [HDMI VIDEO] to [480P].
 - Press \triangle on the front panel to open the disc tray.
 - Press \blacktriangleleft .
 - Press **AUDIO**.

Do not perform this operation while playing back a disc on this unit.
- When [PROGRESSIVE] is set to [ON] (see page 38) and HDMI signals are output, component video is muted.

TRUE LIFE

Adjust the intensity of the picture details. A positive value enables you to reproduce the minute signals of video sources.

This function is only available for progressive scan (using the component video jacks) and HDMI output.

Control range: **0 to 5**

DVI OUTPUT RANGE

Set the DVI output range to match the connected component. This function is only available when you connect this unit to an DVI-D-compatible component via the HDMI jack.

ENHANCED

Select this if black and white in the image is not distinct.

STANDARD

Select this if you cannot see the correct image when you select [ENHANCED].

Setup Menu

Turning the progressive scan function on/off

This feature is only available if you have connected this unit to a progressive scan TV through the component video jacks (see “Component video jacks <C>” on page 11).

- Select [PROGRESSIVE] in “VIDEO SETUP PAGE”.

OFF

Select this to disable the progressive scan function.

ON

Select this to enable the progressive scan function.

Notes

- Ensure that your TV is equipped with progressive scan.
- Connect using a component video cable.
- If [PROGRESSIVE] is set to [ON] and the video signal is output at the HDMI jack, no video signal is output at the component video jacks.
- You can turn off the progressive scan without using the setup mode if no picture is displayed. See “Troubleshooting” on page 42.

CONSUMERS SHOULD NOTE THAT NOT ALL HIGH DEFINITION TELEVISION SETS ARE FULLY COMPATIBLE WITH THIS PRODUCT AND MAY CAUSE ARTIFACTS TO BE DISPLAYED IN THE PICTURE. IN CASE OF 525 OR 625 PROGRESSIVE SCAN PICTURE PROBLEMS, IT IS RECOMMENDED THAT THE USER SWITCH THE CONNECTION TO THE “STANDARD DEFINITION” OUTPUT. IF THERE ARE QUESTIONS REGARDING OUR VIDEO MONITOR COMPATIBILITY WITH THIS MODEL 525P AND 625P DVD PLAYER, PLEASE CONTACT OUR CUSTOMER SERVICE CENTER.

This unit is compatible with the complete line of Yamaha products, including the projectors DPX-1300, DPX-830 and the plasma monitor PDM-4220.

Preference setup menu

Note

You cannot select “PREFERENCE PAGE” during playback. Press **STOP** (■) twice to display this page.

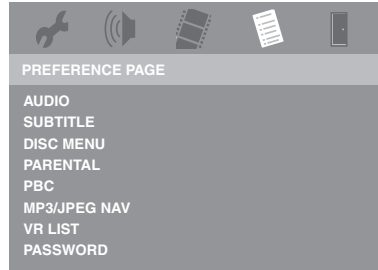

Audio, subtitle, disc menu

These menus contain various language options for the audio, subtitles and disc menus recorded on the DVD-Video. For details, see “Setting the audio, subtitle and disc menu languages” on page 16.

Restricting playback with parental control

Some DVD discs have a parental level assigned to the complete disc or to certain scenes on the disc. The rating levels are from 1 to 8 and are country dependent.

You can prohibit playback certain discs that are not suitable for your children or play certain discs in alternative scenes.

- 1 Select [PARENTAL] in “PREFERENCE PAGE”.
- 2 Press ▲/▼ to highlight a rating level for the loaded disc, and then press **ENTER**.
 - To disable parental controls and have all discs play, select [8 ADULT].
- 3 Use the **numeric buttons (0-9)** to enter the six-digit password (see “Changing the password” on this page).
 - DVD discs that are rated the level you selected do not play unless you enter your six-digit password.

Notes

- VCD, SVCD, CD and SA-CD discs have no level indication, so the parental control function has no effect with these types of discs. This also applies to most illegal DVD discs.
- Some DVD discs are not encoded with a rating though the movie rating may be printed on the disc cover. The rating level feature does not work for such discs.

Selecting the PBC (playback control) function

You can set playback control (PBC) to on or off. This function is available only on Video CD 2.0 with the playback control (PBC) feature.

- Select [PBC] in “PREFERENCE PAGE”.

ON

Select this to display a disc menu.

OFF

Select this to not display a disc menu. Playback starts from the beginning of a disc.



You can also use the MENU button on the remote control to turn on or off the playback control (PBC) function (see “Using the playback control (PBC) menu” on page 23).

Selecting the MP3/JPEG menu

MP3/JPEG navigator can be set only if the disc was recorded with a menu. It allows you to select different display menus for easy navigation.

- Select [MP3/JPEG NAV] in “PREFERENCE PAGE”.

WITH MENU

Select this to display only the folder menu of the MP3/Picture CD.

WITHOUT MENU

Select this to display all the files contained in the MP3/Picture CD.

Selecting playback of VR format

There are two ways to play back a disc in VR (Video Recording) format: ORIGINAL and PLAY LIST. This function is not available with non-VR format discs.

- Select [VR LIST] in “PREFERENCE PAGE”.

ORIGINAL LIST

Select this to play the originally recorded titles on the disc.

PLAY LIST

Select this to play the edited version of the disc. This function is only available when a play list has been created.

■ To play back a disc in VR format

- 1 Press **SETUP** to exit the setup menu.
- 2 Press **PLAY (▶)** to begin to play back the disc with the setting you selected.

Changing the password

The same password is used for both [PARENTAL] and [DISC LOCK]. Enter your six-digit password when prompted on the screen. The default password is “000 000”.

- 1 Select [PASSWORD] in “PREFERENCE PAGE”.
- 2 Press ▶ to select [CHANGE], and then press **ENTER**.
→ “Password change page” appears.

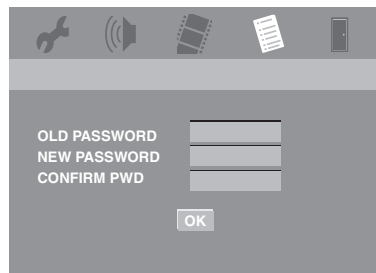

Setup Menu

- 3** Use the **numeric buttons (0-9)** to enter your old six-digit password.
 - When doing this for the first time, enter “000 000”.
 - If you forget your old six-digit password, enter “000 000”.
- 4** Enter the new six-digit password.
- 5** Enter the new six-digit password again to confirm the password.
- 6** Press **ENTER** to confirm your new password.
 - The new six-digit password is now valid.

Displaying DivX® external subtitle files

The font sets listed below are available for DivX® external subtitle files. This setting allows you to see the proper font set on-screen to match the subtitle file.

- Select [DIVX SUBTITLE] in “PREFERENCE PAGE”.

GROUP1

Albanian (sq), Breton (br), Catalan (ca), Danish (da), Dutch (nl), English (en), Faroese (fo), Finnish (fi), French (fr), Gaelic (gd) German (de), Icelandic (is), Irish (ga), Italian (it), Norwegian (no), Portuguese (pt), Spanish (es), Swedish (sv)

GROUP2

Croatian (hr), Czech (cs), Hungarian (hu), Polish (pl), Romanian (ro), Serbian (sr), Slovak (sk), Slovenian (sl)

Notes

- Some discs cannot be played depending on disc characteristics or recording conditions.
- Some external subtitle files may be displayed incorrectly or not at all.
- For external subtitle files, the following subtitle format filename extensions are supported (note that these files are not shown within the disc navigation menu): .srt, .sub, .ssa, .smi
- The filename of the movie file has to be repeated at the beginning of the filename for the external subtitle file.
- The number of external subtitle files that can be switched for the same movie file is limited to a maximum of ten.

Resetting the system

You can reset all options and your personal settings to the initial factory settings, excluding your password for [PARENTAL] and [DISC LOCK].

- 1** Select [DEFAULT] in “PREFERENCE PAGE”.
- 2** Press ► to select [RESET], and then press **ENTER**.
 - All settings are reset to the initial factory settings.

These codes can be used to select other languages. This does not affect the options in “AUDIO”, “SUBTITLE” or “DISC MENU”.

Abkhazian	6566	Gaelic	7168	Macedonian	7775	Sardinian	8367
Afar	6565	Gallegan	7176	Malagasy	7771	Scottish Gaelic	7168
Afrikaans	6570	Georgian	7565	Malay	7783	Serbian	8382
Albanian	8381	German	6869	Malayalam	7776	Shona	8378
Amharic	6577	Gikuyu	7573	Maltese	7784	Sindhi	8368
Arabic	6582	Greek	6976	Manx	7186	Sinhalese	8373
Armenian	7289	Guarani	7178	Maori	7773	Slovak	8375
Assamese	6583	Gujarati	7185	Marathi	7782	Slovenian	8376
Avestan	6569	Hausa	7265	Marshallese	7772	Somali	8379
Aymara	6589	Hebrew	7269	Moldavian	7779	Sotho, Southem	8384
Azerbaijani	6590	Herero	7290	Mongolian	7778	South Ndebele	7882
Bashkir	6665	Hindi	7273	Nauru	7865	Spanish	6983
Basque	6985	Hiri Motu	7279	Navaho	7886	Sundanese	8385
Belarusian	6669	Hungarian	7285	Navajo	7886	Swahili	8387
Bengali	6678	Icelandic	7383	Ndebele, North	7868	Swati	8383
Bihari	6672	Ido	7379	Ndebele, South	7882	Swedish	8386
Bislama	6673	Indonesian	7368	Ndonga	7871	Tagalog	8476
Bokmål, Norwegian	7866	Interlingua (International)	7365	Nepali	7869	Tahitian	8489
Bosnian	6683	Interlingue	7369	Northern Sami	8369	Tajik	8471
Breton	6682	Inuktitut	7385	North Ndebele	7868	Tamil	8465
Bulgarian	6671	Inupiaq	7375	Norwegian	7879	Tatar	8484
Burmese	7789	Irish	7165	Norwegian Bokmål	7866	Telugu	8469
Castilian	6983	Italian	7384	Norwegian Nynorsk	7878	Thai	8472
Catalan	6765	Japanese	7465	Nyanja	7889	Tibetan	6679
Chamorro	6772	Javanese	7486	Nynorsk, Norwegian	7878	Tigrinya	8473
Chechen	6769	Kalaallisut	7576	Occitan (post 1500)	7967	Tonga (Tonga Islands)	8479
Chewa	7889	Kannada	7578	Old Bulgarian	6785	Tsong	8483
Chichewa	7889	Kashmiri	7583	Old Church Slavonic	6785	Tswana	8478
Chinese	9072	Kazakh	7575	Old Slavonic	6785	Turkish	8482
Chuang	9065	Khmer	7577	Oriya	7982	Turkmen	8475
Church Slavic	6785	Kikuyu	7573	Oromo	7977	Twi	8487
Church Slavonic	6785	Kinyarwanda	8287	Ossetian	7983	Uighur	8571
Chuvash	6786	Kirghiz	7589	Ossetic	7983	Ukrainian	8575
Cornish	7587	Komi	7586	Pali	8073	Urdu	8582
Corsican	6779	Korean	7579	Panjabi	8065	Uzbek	8590
Croatian	7282	Kuanyama	7574	Persian	7065	Vietnamese	8673
Czech	6783	Kurdish	7585	Polish	8076	Volapük	8679
Danish	6865	Kwanyama	7574	Portuguese	8084	Walloon	8765
Dutch	7876	Lao	7679	Provençal	7967	Welsh	6789
Dzongkha	6890	Latin	7665	Pushto	8083	Wolof	8779
English	6978	Latvian	7686	Quechua	8185	Xhosa	8872
Esperanto	6979	Letzeburgesch	7666	Raeto-Romance	8277	Yiddish	8973
Estonian	6984	Limburgan	7673	Romanian	8279	Yoruba	8979
Faroese	7079	Limburger	7673	Rundi	8278	Zhuang	9065
Fijian	7074	Limburgish	7673	Russian	8285	Zulu	9085
Finnish	7073	Lingala	7678	Samoan	8377		
French	7082	Lithuanian	7684	Sango	8371		
Frisian	7089	Luxembourgish	7666	Sanskrit	8365		

Troubleshooting

Refer to the chart below when this unit does not function properly. If the problem you are experiencing is not listed below or if the instruction below does not help, set this unit to the standby mode, disconnect the power cable, and contact the nearest authorized Yamaha dealer or service center.

Problem	Solution
No power	Connect the power cable properly.
	Press STANDBY/ON on the front panel to turn on the power.
No picture	Refer to the manual supplied with your TV to select the video input channel correctly. Change the TV channel until you see the DVD screen.
	Turn on your TV.
	Check the video connection.
No picture is displayed when you make HDMI connections (using the HDMI jacks)	Follow the steps below to change the [HDMI VIDEO] to [480P]. 1. Press \triangle on the front panel or press and hold STOP (■) on the remote control to open the disc tray. 2. Press \blacktriangleleft on the remote control. 3. Press AUDIO on the remote control.
No picture is displayed when you make component video connections (using the component video jacks)	Follow the steps below to turn off the progressive scan. 1. Press \triangle on the front panel or press and hold STOP (■) on the remote control to open the disc tray. 2. Press \blacktriangleleft on the remote control. 3. Press ANGLE on the remote control to deactivate the progressive scan.
Completely distorted picture or black/white picture or no picture	Check that the disc is compatible with this unit (see “Playable disc formats” on page 3).
	Check that the TV type of this unit is set to match that of the disc and your TV (see “Setting a color system for your TV” on page 34). Follow the steps below to return to the initial setting of [TV TYPE]. 1. Press \triangle on the front panel or press and hold STOP (■) on the remote control to open the disc tray. 2. Press \blacktriangleright on the remote control. 3. Press AUDIO on the remote control.
Distorted picture	Occasionally, a small amount of picture distortion may appear depending on the disc being played back. This is not a malfunction.
The screen size looks unnatural, or the caption is displayed only partially on the TV monitor or is not displayed at all	Check that the TV setting of this unit matches the screen size of your TV (see “Setting the TV display” on page 35).
	Change the screen size and the aspect ratio of your TV.
No sound or distorted sound	Adjust the volume.
	Check that the speakers are connected correctly.
	For MP3/WMA, check that the sampling rate and bit rate are compatible with this unit (see “Specifications” on page 46).
No audio from subwoofer during stereo	Check that all speaker settings in the setup menu have been changed to small instead of large.

Problem	Solution
No audio at digital output	Check the digital connections.
	If you are playing a DTS source, check that your receiver can decode DTS, and that [DIGITAL OUTPUT] is set to [ALL] (see page 32).
	If you are playing an MPEG-2 source, check that your receiver can decode MPEG-2. Otherwise, check that [DIGITAL OUTPUT] is set to [PCM ONLY] (see page 32).
	Check that the audio format of the selected audio language matches your receiver capabilities.
Disc does not play	The CD-R/RW, DVD+R/RW/R DL and DVD-R/RW must be finalized.
	Check that the disc label is facing up.
	Check whether the disc is defective by trying another disc.
	If you have recorded a JPEG, MP3 or WMA disc yourself, check that your disc contains at least ten JPEG picture files or five MP3/WMA music tracks.
	For MP3/WMA, check that the sampling rate and bit rate are compatible. For JPEG, check that the resolution is compatible (see "Specifications" on page 46).
	Check the region code (see "Region codes" on page 3).
Picture freezes momentarily during playback	Check the disc for fingerprints/scratches and clean it with a soft cloth wiping from center to edge.
This unit does not respond to the remote control	Aim the remote control directly at the remote control sensor on the front panel.
	Reduce the distance of the remote control from this unit.
	Replace the batteries in the remote control.
	Reinsert the batteries with their polarities (+/- signs) as indicated.
Buttons do not work	To completely reset this unit, unplug the power cable from the AC outlet for 5-10 seconds.
This unit does not respond to some operating commands during playback	Some operations may not be permitted by the disc. Refer to the instructions of the disc jacket.
This unit cannot read CD or DVD	Use a commonly available CD/DVD lens cleaner to clean the lens before sending this unit for repair.
"NO DISC" appears in the front panel display	Check that the disc is placed in the disc tray correctly.
"UN DISC" appears in the front panel display	The disc being loaded is not supported by this unit. Check the disc type (see "Playable disc formats" on page 3).
Menu items cannot be selected	Press STOP (■) twice on the remote control before selecting the setup menu.
	Depending on the disc availability, some menu items cannot be selected.
No sound during DivX® movie playback	The audio codec may not be supported by this unit.

Glossary

■ Analog

Sound that has not been converted into numerical values. Analog sound varies, while digital sound has specific numerical values. These jacks send audio through two channels, the left and right.

■ Aspect ratio

The ratio of vertical and horizontal sizes of a displayed image. The horizontal vs. vertical ratio of conventional TVs is 4:3, and that of widescreens is 16:9.

■ Audio output jacks

Jacks on the back of the DVD player that send audio to another system (TV, Stereo, etc.).

■ Bit rate

The amount of data used to hold a given length of music, measured in kilobits per seconds (kbps). Or, the speed at which you record. Generally, the higher the bit rate, or the higher the recording speed, the better the sound quality. However, higher bit rates use more space on a disc.

■ Chapter

Sections of a picture or a music piece on a DVD that are smaller than titles. A title is composed of several chapters. Each chapter is assigned a chapter number enabling you to locate the chapter you want.

■ Component video output jacks

Jacks on the back of the DVD player that send high-quality video to a TV that has component video input jacks (R/G/B, Y/Pb/Pr, etc.).

■ Disc menu

A screen display prepared for allowing selection of images, sounds, subtitles, multi-angles, etc. recorded on a DVD.

■ Digital

Sound that has been converted into numerical values. Digital sound is available when you use the digital audio output jacks. These jacks send audio through multiple channels, instead of just two channels as analog does.

■ DivX®

DivX® is a popular media technology created by DivX®, Inc. DivX® media files contain highly compressed video with high visual quality while maintaining a relatively small file size. DivX® files can also include advanced media features like menus, subtitles, and alternate audio tracks. Many DivX® media files are available for download online, and you can create your own using your personal content and easy-to-use tools from DivX®.com.

■ DivX® Ultra

DivX® Ultra Certified products provide enhanced playback of advanced media features supported by the DivX® Media Format. Key features include interactive video menus, subtitles, alternate audio tracks, video tags and chapter points.

■ DMF (DivX® Media Format)

The DivX® Media Format supports advanced media features, adding controls for an interactive media experience: interactive video menus, chapter points, multi-language subtitles and alternate audio tracks.

■ Dolby Digital

A surround sound system developed by Dolby Laboratories containing up to six channels of digital audio (front left and right, surround left and right, center and subwoofer).

■ DTS

The 5.1-channel surround system adopted by most movie theaters. With an abundance of audio data, it is able to provide authentic-sounding effects.

■ DVD-Audio

It has developed for the sole purpose of creating high quality pure sound with Linear PCM (LPCM) and Packed PCM (PPCM) (lossless coding) in up to six audio-channels. Sampling frequencies of 192 kHz/24 bits are supported.

■ HDMI

HDMI (High-Definition Multimedia Interface) is the first industry-supported, uncompressed, all-digital audio/video interface. Providing an interface between any source (such as a set-top box or AV receiver) and an audio/video monitor (such as a digital television), HDMI supports standard, enhanced or high-definition video as well as multi-channel digital audio using a single cable. HDMI transmits all ATSC (Advanced Television Systems Committee) HDTV standards and supports 8-channel digital audio, with bandwidth to spare to accommodate future enhancements and requirements.

When used in combination with HDCP (High-bandwidth Digital Content Protection), HDMI provides a secure audio/video interface that meets the security requirements of content providers and system operators. For further information on HDMI, visit the HDMI website at “www.hdmi.org/”.

■ HDCP

HDCP (High-bandwidth Digital Content Protection) developed by Intel corporation, is a method to encrypt digital video and audio data for purpose of content protection.

For further information on HDCP, visit the HDCP website at “www.digital-cp.com/”.

■ Interactive menu

Interactive video menus offer unprecedented convenience and control so you can quickly navigate between various scenes or bonus features, and select from audio track and subtitle options.

■ JPEG

A very common digital still picture format. A still-picture data compression system proposed by the Joint Photographic Expert Group, which features small decrease in image quality in spite of its high compression ratio.

■ MP3

A file format with a sound data compression system. "MP3" is the abbreviation of Motion Picture Experts Group 1 (or MPEG-1) Audio Layer 3. By using MP3 format, one CD-R or CD-RW can contain about ten times as much data as a regular CD can.

■ Multi-channel

DVD is specified to have each sound track constitute one sound field. Multi-channel refers to a structure of sound tracks having three or more channels.

■ Parental control

A function of the DVD to limit playback of the disc by the age of the users according to the limitation level in each country. The limitation varies from disc to disc; when it is activated, playback will be prohibited if the software's level is higher than the user-set level.

■ PCM (Pulse Code Modulation)

A system for converting analog sound signals to digital signals for later processing, with no data compression used in conversion.

■ Playback control (PBC)

Refers to the signal recorded on video CDs or SVCDs for controlling reproduction. By using menu screens recorded on a Video CD or SVCD that supports PBC, you can enjoy interactive-type software as well as software having a search function.

■ Play list

A list of selected titles to be played back in a specific order. This option is only available with VR format and must be created beforehand.

■ Progressive scan

It displays all the horizontal lines of a picture at one time, as a signal frame. This system can convert the interlaced video from DVD into progressive format for connection to a progressive display. It dramatically increases the vertical resolution.

■ Region code

A system for allowing discs to be played back only in the region designated beforehand. This unit will only play discs that have compatible region codes. You can find the region code of your unit by looking on the product label. Some discs are compatible with more than one region (or ALL regions).

■ S-video

Produces a clear picture by sending separate signals for the luminance and the color. You can use S-video only if your TV has S-video input jack.

■ Super Audio CD

Audio format based upon the current CD standards but includes a greater amount of information that provides higher quality sound. There are three types of discs: single layer, dual layer and hybrid discs. The hybrid disc can be played on existing CD players as well as Super Audio CD players since it contains both standard audio CD and Super Audio CD information.

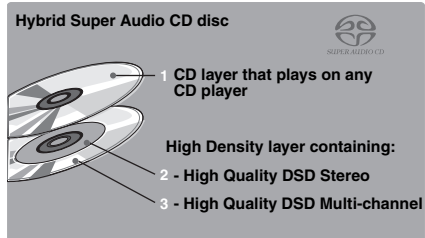
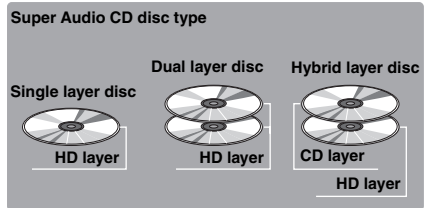

■ Surround

A system for creating realistic three dimensional sound fields full of realism by arranging multiple speakers around the listener.

■ Title

The longest section of a picture or music feature on DVD, music, etc., in video software, or the entire album in audio software. Each title is assigned a title number enabling you to locate the title you want.

■ Video output jack

Jack on the back of the DVD player that sends video to a TV.

■ VR (Video Recording) format

A format which enables you to create a DVD disc that can be extensively re-edited.

Specifications

PLAYABLE DISC FORMATS

- DVD-Video
- DVD-Audio
- DVD-R, DVD-RW
- DVD+R, DVD+RW, DVD+R DL
- Video CD, SVCD
- SA-CD multi-channel and SA-CD stereo
- CD
- PICTURE CD
- CD-R, CD-RW
- MP3 (ISO 9660) fs 16, 22.05, 24, 32, 44.1, 48 kHz /
96, 128, 256 kbps (CBR only)
- WMA fs 44.1 kHz, 62-192 kbps (CBR only) /
fs 48 kHz, 128-192 kbps (CBR only)
- DivX®
- JPEG 3072 x 2048 pixels or less

VIDEO PERFORMANCE

- Video (CVBS) output 1 Vpp into 75 ohm
- S-Video output Y: 1 Vpp into 75 ohm
C: 0.3 Vpp into 75 ohm
- Component video output Y: 1 Vpp into 75 ohm
Pb/Cb Pr/Cr: 0.7 Vpp into 75 ohm
- Black Level Shift On/Off

AUDIO FORMAT

- Digital
Dolby Digital, DTS, MPEG Compressed digital
PCM fs 44.1, 48, 96 kHz / 16, 20, 24 bits
MP3 (ISO 9660) fs 16, 22.05, 24, 32, 44.1, 48 kHz /
24, 32, 56, 64, 96, 128, 256 kbps
WMA 32-192 kbps, mono, stereo
- Full decoding of Dolby Digital and DTS multi-channel
sound
- Analog sound Stereo
- Dolby Surround Compatible Downmix from Dolby
Digital multi-channel sound
- Dolby Pro Logic II
- 3D sound for virtual 5.1 channel sound on 2 speakers

AUDIO PERFORMANCE

- DA Converter 24 bit, 192kHz
- Signal-Noise (1 kHz) 105 dB
- Dynamic range (1 kHz) 100 dB
- DVD fs 96 kHz, 2 Hz-44 kHz /
fs 48 kHz, 2 Hz-22 kHz
- SVCD fs 48 kHz, 2 Hz-22 kHz /
fs 44.1 kHz, 2 Hz-20 kHz
- CD/VCD fs 44.1 kHz, 2 Hz-20 kHz
- Distortion and Noise (1 kHz) 0.0035%

TV STANDARD

- Number of lines PAL: 625, NTSC: 525
- Vertical frequency PAL: 50 Hz, NTSC: 60 Hz
- Playback Multistandard (PAL/NTSC)

CONNECTIONS

- Video output RCA/Phono x 1 (yellow)
- S-video output Mini DIN, 4 pins x 1
- Component video output
Y output RCA/Phono x 1 (green)
Pb output RCA/Phono x 1 (blue)
Pr output RCA/Phono x 1 (red)
- 2-channel audio output (L+R)
..... RCA/Phono x 1 pair (white/red)
- 6-channel audio output
Audio front L/R RCA/Phono x 1 pair (white/red)
Audio surround L/R RCA/Phono x 1 pair (white/red)
Audio center RCA/Phono x 1 (black)
Audio subwoofer RCA/Phono x 1 (black)
- Digital output
Coaxial RCA/Phono x 1
(IEC60958 for CDDA, LPCM /
IEC61937 for MPEG2, Dolby Digital, DTS)
Optical RCA/Phono x 1
(IEC60958 for CDDA, LPCM /
IEC61937 for MPEG2, Dolby Digital, DTS)
HDMI Type A x 1
- Remote Control
Input ϕ 3.5 mm mini jack x 1
Output ϕ 3.5 mm mini jack x 1

CABINET

- Dimensions (W x D x H) 435 x 425 x 75 mm
(17-1/8 x 16-3/4 x 2-15/16 inch)
- Weight Approx. 5.5 kg (12 lbs. 2oz.)

POWER SUPPLY

- Power inlet AC 120 V, 60 Hz
- Power consumption Approx. 20 W
- Standby power consumption Less than 0.5 W

Specifications are subject to change without prior notice.



©2007 YAMAHA CORPORATION All rights reserved.

YAMAHA ELECTRONICS CORPORATION, USA 6660 ORANGETHORPE AVE., BUENA PARK, CALIF. 90620, U.S.A.

YAMAHA CANADA MUSIC LTD. 135 MILNER AVE., SCARBOROUGH, ONTARIO M1S 3R1, CANADA

YAMAHA ELECTRONIK EUROPA G.m.b.H. SIEMENSSTR. 22-34, 25462 RELLINGEN BEI HAMBURG, GERMANY

YAMAHA ELECTRONIQUE FRANCE S.A. RUE AMBROISE CROIZAT BP70 CROISSY-BEAUBOURG 77312 MARNE-LA-VALLEE CEDEX02, FRANCE

YAMAHA ELECTRONICS (UK) LTD. YAMAHA HOUSE, 200 RICKMANSWORTH ROAD WATFORD, HERTS WD18 7GQ, ENGLAND

YAMAHA SCANDINAVIA A.B. J A WETTERGRENS GATA 1, BOX 30053, 400 43 VÄSTRA FROLUNDA, SWEDEN

YAMAHA MUSIC AUSTRALIA PTY, LTD. 17-33 MARKET ST., SOUTH MELBOURNE, 3205 VIC., AUSTRALIA

YAMAHA CORPORATION

Printed in China  3139 245 27382