



DVD-C996

*DVD / VIDEO CD / CD PLAYER
LECTEUR DE DVD CHANGEUR*



OWNER'S MANUAL
MODE D'EMPLOI
BEDIENUNGSANLEITUNG
BRUKSANVISNING
MANUALE DI ISTRUZIONI
MANUAL DE INSTRUCCIONES
GEBRUIKSAANWIJZING

CAUTION: READ THIS BEFORE OPERATING YOUR UNIT.

- 1 To assure the finest performance, please read this manual carefully. Keep it in a safe place for future reference.
- 2 Install this unit in a well ventilated, cool, dry, and clean place with at least 5 cm above, behind and on the both sides of this unit - away from direct sunlight, heat sources, vibration, dust, moisture, and/or cold.
- 3 Position this unit away from other electrical appliances, motors and transformers to avoid humming sounds, do not place this unit where it may get exposed to rain or any kind of liquid to prevent fire or electrical shock.
- 4 Avoid extreme temperature swings or excessive use of humidifier in the room where this unit is installed to prevent condensation inside this unit, which may cause an electrical shock, fire, damage to this unit, and/or personal injury.
- 5 Do not cover this unit with a newspaper, a tablecloth, a curtain, etc. in order not to obstruct heat radiation. If the temperature inside this unit rises, it may cause fire, damage to this unit and/or personal injury.
- 6 Avoid installing is unit in a place where foreign objects and liquid might fall. It might cause a fire, damage to this unit and/or personal injury. Do not place the following objects on this unit:
 - Other components, as they may cause damage and/or discoloration on the surface of this unit.
 - Burning objects (i.e., candles), as they may cause fire, damage to this unit and/or personal injury.
 - Containers with liquid in them, as they may cause an electrical shock to the user and/or damage to this unit.
- 7 Do not operate this unit upside-down. It may overheat, possibly causing damage.
- 8 Do not use force on switches, controls or connection cables. Never pull the cables when disconnecting them.
- 9 Only voltage specified on this unit must be used. Using this unit with a higher voltage than specified is dangerous and may result in fire or other accidents. YAMAHA will not be held responsible for any damage resulting from the use of this unit with a voltage other than that specified.
- 10 Do not attempt to clean this unit with chemical solvents; this might damage the finish. Use a clean, dry cloth.
- 11 Disconnect the power cord from the wall outlet when not planning to use this unit for a long period of time, or during an electrical storm, as they may cause damage by lightning.
- 12 Do not attempt to modify or fix this unit. Contact the qualified YAMAHA service personnel when any service is needed. Cabinet should never be opened for any reasons.
- 13 Be sure to read 'TROUBLESHOOTING' section regarding common operating errors before concluding that this unit is faulty.

DANGER

Visible laser radiation when open. Avoid direct exposure to beam.

When this unit is plugged to the wall outlet, do not place your eyes close to the opening of the disc tray and other openings to look into inside.

Laser component in this product is capable of emitting radiation exceeding the limit for Class 1.

CAUTION

This unit is designed for home use only. Do not use this unit for business purposes.

Be sure to place this unit on a level surface. If not so, this unit will fail to work normally at the PLAYXCHANGE operation and cause damage to the disc(s) and this unit itself.

Caution for moving this unit

- When moving this unit, first remove all discs from the disc table and close the table by pressing the **OPEN/CLOSE** button, and then switch off the power after you confirm that the front panel display indicates as follows.

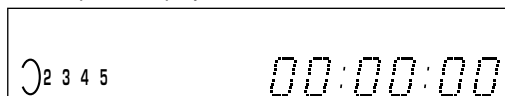

Never switch off the power if the front panel display is not pictured as above, otherwise the unit will break down during moving because the internal mechanism is not locked.

- When moving this unit, be sure to first disconnect the power cord from the AC outlet and disconnect all cords connecting this unit to other equipment.

■ For U.K. customers

If the socket outlets in the home are not suitable for the plug supplied with this appliance, it should be cut off and an appropriate 3 pin plug fitted. For details, refer to the instructions described below.

Note

- The plug severed from the mains lead must be destroyed, as a plug with bared flexible cord is hazardous if engaged in a live socket outlet.

■ Special Instructions for U.K. Model

IMPORTANT

THE WIRES IN MAINS LEAD ARE COLOURED IN ACCORDANCE WITH THE FOLLOWING CODE:

Blue: NEUTRAL

Brown: LIVE

As the colours of the wires in the mains lead of this apparatus may not correspond with the coloured markings identifying the terminals in your plug, proceed as follows:

The wire which is coloured BLUE must be connected to the terminal which is marked with the letter N or coloured BLACK. The wire which is coloured BROWN must be connected to the terminal which is marked with the letter L or coloured RED.

Making sure that neither core is connected to the earth terminal of the three pin plug.

FEATURES

- 5-Disc Auto-changer for playing DVD-Video, audio CD and Video CD
- PLAYXCHANGE; Disc Changing Capability while playing another
- 1 OPTICAL and 1 COAXIAL Digital Outputs for Dolby Digital, DTS, MPEG and Linear PCM
- 96 kHz, 24 Bit Audio DAC for high sound quality
- Compatible with almost all features of DVD discs (Multi-angle, Multi-language, Parental control, etc.)
- Easy Operation through On-screen Menu (Graphical User Interface)
- Multi-speed Playback Capability
- Component Video [U.S.A, Canada, Australia and General models], S-Video Outputs for high picture quality

CONTENTS

INTRODUCTION

| | |
|-------------------------------------|----------|
| FEATURES | 1 |
| GETTING STARTED | 2 |
| Checking the Package Contents | 2 |
| Disc Information | 2 |
| CONTROLS AND FUNCTIONS | 4 |
| Front Panel/Remote Control | 4 |
| Display | 6 |

PREPARATION

| | |
|---|----------|
| REMOTE CONTROL | 7 |
| Installing Batteries in the Remote Control ... | 7 |
| Battery Replacement | 7 |
| Using the Remote Control | 7 |
| CONNECTIONS | 8 |
| Notes about Audio Connections | 8 |
| Digital Terminals | 9 |
| Analog Terminals | 9 |
| Video Terminals | 10 |
| Remote Control in/out Terminals [U.S.A. and Canada models] | 11 |

PLAYBACK

| | |
|--|-----------|
| BASIC OPERATION | 12 |
| Before Starting Playback | 12 |
| Playing a Disc | 13 |
| Search (to advance or reverse playback rapidly) | 14 |
| Skipping Chapters / Tracks | 14 |
| Still Picture (to pause playback) | 15 |
| Frame Advance / Reverse | 15 |
| Slow-Motion Play | 15 |
| SELECTING PLAY MODES | 16 |
| Repeat Play | 16 |
| A-B Repeat | 17 |
| Random-Sequence Play [VCD] [CD] | 17 |
| Program Play [VCD] [CD] | 18 |

| | |
|--|-----------|
| ADVANCED FEATURES | 19 |
| Menu Screen [DVD] | 19 |
| Playback Control [VCD] | 19 |
| Switching Audio Tracks [DVD] [VCD] | 20 |
| Switching Subtitle Tracks [DVD] | 21 |
| Switching Camera Angles | 21 |
| ON-SCREEN MENU | 22 |
| Operating On-Screen Menu | 22 |
| Disc Information Screen | 23 |
| Player's Information Screen | 24 |
| Shuttle Screen | 24 |

SETUP MENU

| | |
|---------------------------------------|-----------|
| SETUP MENU | 25 |
| Operating the Setup Menu | 25 |
| DESCRIPTION OF EACH ITEM | 26 |
| 1. Disc Language [DVD] | 26 |
| 2. Ratings [DVD] | 27 |
| 3. Menu Language | 28 |
| 4. On-Screen Messages | 28 |
| 5. FL Display | 28 |
| 6. TV Aspect | 28 |
| 7. Digital Audio Output | 29 |
| 9. Other Settings | 30 |

APPENDIX

| | |
|---------------------------------|-----------|
| TROUBLESHOOTING | 31 |
| GLOSSARY | 33 |
| LANGUAGE CODE LIST | 33 |
| SPECIFICATIONS | 34 |



Manufactured under license from Dolby Laboratories. "Dolby", "Pro Logic" and the double-D symbol are trademarks of Dolby Laboratories. Confidential Unpublished Works. ©1992 - 1997 Dolby Laboratories, Inc. All rights reserved.

GETTING STARTED

Checking the Package Contents

Check that the following items are included in your package.

Remote control

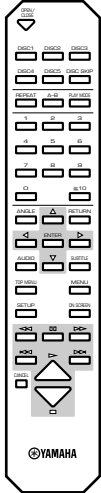

Batteries (AA, R06, UM-3)

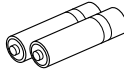

RCA pin cable (audio/video)

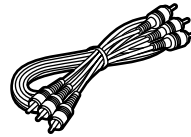

Disc Information

This DVD changer is designed for use with following types of disc only. Never attempt to load any other type of disc into this unit because it may damage this unit.

| Type of disc | DVD-Video 8 cm disc/12 cm disc | Video CD 8 cm disc/12 cm disc | Audio CD 8 cm disc/12 cm disc |
|--------------------------|-----------------------------------|----------------------------------|----------------------------------|
| Mark printed on the disc | | | |

Notes













- This unit is not compatible with CD-R, CD-RW, Photo-CD, CD-ROM, DVD-Audio, DVD-ROM, DVD-RAM, SVCD, CDV, etc.
- Do not use any non standard shaped discs (heart, etc.).
- Do not use disc with tape, seals, or paste on it, damage to the unit may result.
- To reproduce DTS sound, it is necessary to connect a DTS decoder to this unit.
- Some DVD and VCD features described in this manual may not be available or may operate in a different way because they are subject to software producer's design. Check each disc's instruction.

Example:

'⊙' appears when you press the skip buttons to move to the next section.

■ Region management information DVD

This DVD player is designed to meet DVD standard that supports region management system. Check the regional code number marked on the disc packages. If the number does not match this unit's region number (see the below table or the back of this unit), this unit refuses to play that disc.

| Model | Region number of this unit | Discs can be played |
|--------------------------|---|--|
| U.S.A. and Canada models |  |  ,  or a mark which includes the region number '1'. |
| Europe and U.K. models |  |  ,  or a mark which includes the region number '2'. |
| General model |  |  ,  or a mark which includes the region number '3'. |
| Australia model |  |  ,  or a mark which includes the region number '4'. |

■ Notes about handling discs

- Hold discs by touching only the edges or center hole.

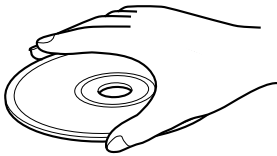

- When a disc is not currently being loaded on the disc tray, store it in an appropriate case.
- Playback of discs is generally not affected by small particles of dust or fingerprints on their playing surface. Even so, they should be kept clean. Wipe by using a clean, dry cloth. Do not wipe with a circular motion; wipe straight outward from the center.

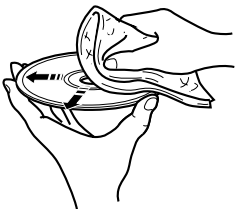

- Do not try to clean the disc's surface by using any type of disc cleaner, record spray, anti-static spray or liquid, or any other chemical-based liquid, because such substances might irreparably damage the disc's surface.
- Do not expose discs to direct sunlight, high temperature or high humidity for a long period of time, because these might warp or otherwise damage the disc.

No!

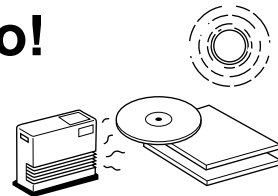

CONTROLS AND FUNCTIONS

Front Panel/Remote Control

Front Panel

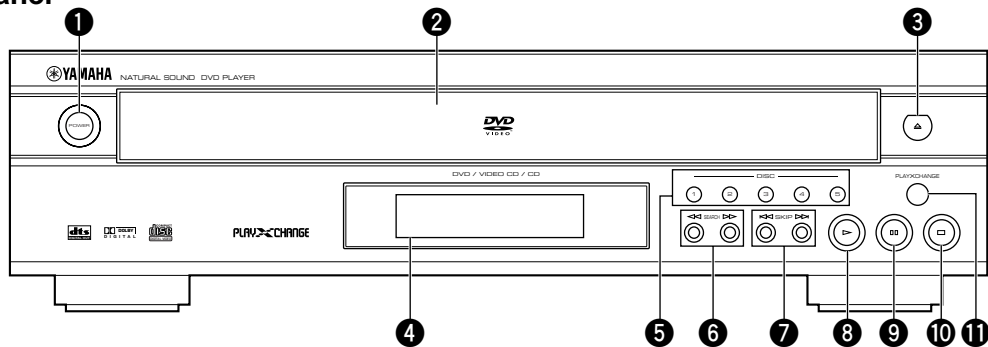

Remote Control

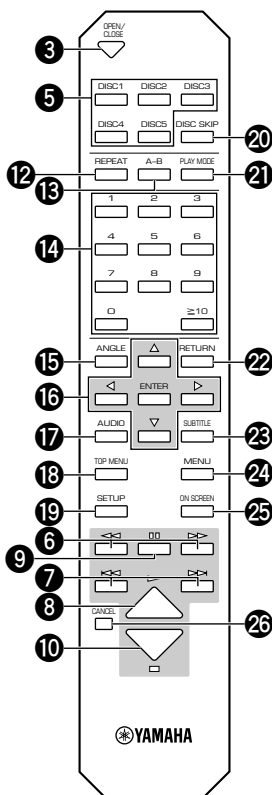

❶ POWER (p.13)

Press to turn the power on and off.

❷ Disc tray (p.13)

Up to 5 discs can be loaded on this tray.

❸ open/close (OPEN/CLOSE) (p.13)

Press to open and close the disc tray.

❹ Display panel

See p.6.

❺ DISC (1,2,3,4,5) (p.13)

Press to play the disc loaded on the guide of the corresponding number.

❻ <<<, >>> (SEARCH) (p.14)

Use to advance or reverse playback rapidly.

❼ <<<, >>> (SKIP) (p.14)

>>>: Press to skip to the beginning of the next chapter (track).

<<<: Press to skip to the beginning of the currently played chapter (track).

❽ ▷ (PLAY) (p.13)

Press to start playback.

❾ ◻◻ (PAUSE) (p.15)

Press to pause.

❿ ◻ (STOP) (p.13)

Press to stop playback.

⓫ PLAYXCHANGE (p.14)

Press to open and close the disc tray during playback. You can exchange discs other than the one being played.

12 REPEAT (p.16)

Press to repeat playback of a title, chapter, track, etc.

13 A-B (p.17)

Press to specify two points and to repeat playback between them.

14 Numeric buttons

Use to select a title, chapter, track, etc.

15 ANGLE

Press to change angles when the scene of the disc being played contains two or more angles.

16 Cursor buttons, ENTER

Use to select and determine an item on menu screen, etc.

17 AUDIO (p.20)

Press to change audio track language and/or format when the disc being played contains two or more different audio tracks.

18 TOP MENU

Press to go to the initial screen when operating in the menu screen.

19 SETUP (p.25)

Press to call up SETUP MENU screen.

20 DISC SKIP

Press to select another disc.

21 PLAY MODE (p.17, 18)

Press to switch among random play, program play, and normal play.

22 RETURN (p.25)

Press to go back to the previous screen when operating in the menu screen.

23 SUBTITLE (p.21)

Press to change subtitles when the disc being played contains several subtitles.

24 MENU (p.19)

Press to call up menu screen contained in the disc.

25 ON SCREEN (p.22)

Press to turn the on-screen menu (GUI icons) on and off on the video monitor.

26 CANCEL

Press to cancel a specific mode or a setting.

Display

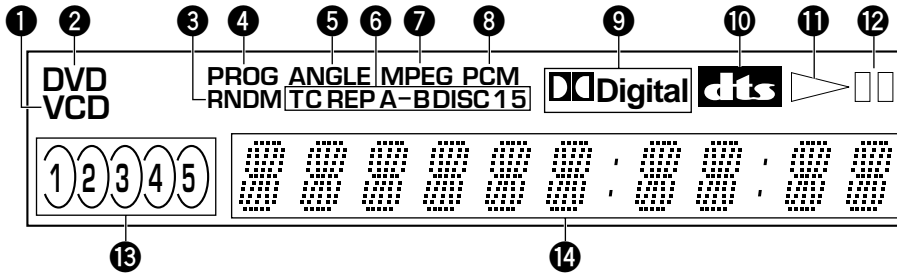

1 VCD

VCD lights up when a Video CD is selected and CD lights up when a CD is selected.

2 DVD

Lights up when a DVD is selected.

3 RNDM

Lights up during random-sequence play.

4 PROG

Lights up during program play.

5 ANGLE

Lights up when the scene currently played contains different angle(s).

6 Repeat mode indicator

- T and REP light up when repeating a title or a track.
- C and REP light up when repeating a chapter.
- REP and A-B light up when repeating between the two points you have specified.
- REP and DISC 1 light up when repeating the currently selected disc.
- REP and DISC 5 light up when repeating all the discs loaded on the disc tray.

7 MPEG DVD

Lights up when an audio track encoded with MPEG format is selected.

8 PCM DVD

Lights up when an audio track encoded with Linear PCM format is selected.

9 Digital DVD

Lights up when an audio track encoded with Dolby digital format is selected.

10 dts DVD CD

Lights up when an audio track encoded with DTS format is selected.

11 ▷

Lights up during playback.

12 ◻◻

Lights up while playback is paused.

13 1 2 3 4 5

One of these numbers lights up to show the currently selected disc, which is loaded on the guide of the corresponding number.

14 Multi-information display

Shows various information such as title, chapter or track number, elapsed playing time etc.

REMOTE CONTROL

Installing Batteries in the Remote Control

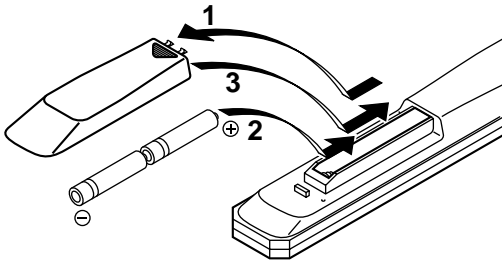

- 1** Turn the remote control over and slide the battery compartment cover in the direction of the arrow.
- 2** Insert the batteries (AA, R06, UM-3 type) according to the polarity markings on the inside of the battery compartment.
- 3** Close the battery compartment cover.

Battery Replacement

If the remote control operates only when it is close to the unit, the batteries are weak. Replace all the batteries with new ones.

Notes

- Use only AA, R06 or UM-3 batteries for replacement.
- Be sure the battery polarity is correct. (See the illustration inside the battery compartment.)
- Remove the batteries if the remote control will not be used for an extended period of time.
- If the batteries have leaked, dispose of them immediately. Avoid touching the leaked material or letting it come into contact with clothing, etc. Clean the battery compartment thoroughly before installing new batteries.

Using the Remote Control

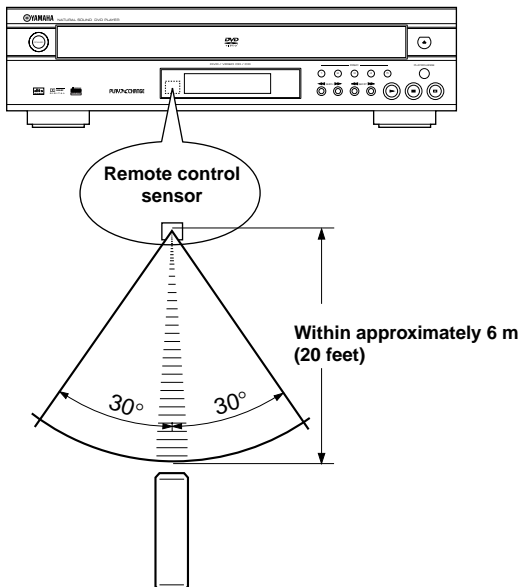

The remote control transmits a directional infrared beam. Be sure to aim the remote control directly at the infrared sensor during operation. When the sensor is covered or there is a large object between the remote control and the sensor, the sensor cannot receive signals. The sensor may not be able to receive signals properly when it is exposed to direct sunlight or a strong artificial light (such as a fluorescent or strobe light). In this case, change the direction of the light or reposition the unit to avoid direct lighting.

Notes

- Handle the remote control with care.
- Do not spill water, tea or other liquids on the remote control.
- Do not drop the remote control.
- Do not leave or store the remote control in the following conditions:
 - high humidity or temperature such as near a heater, stove or bath;
 - dusty places; or
 - extremely low temperature.

CONNECTIONS

CAUTION

- Never connect this unit and other equipment to power supply until all connections have been completed.

Be sure all connections are made correctly, observing the color-coding of terminals of both this unit and the equipment to be connected. Also refer to the instructions of the equipment to be connected.

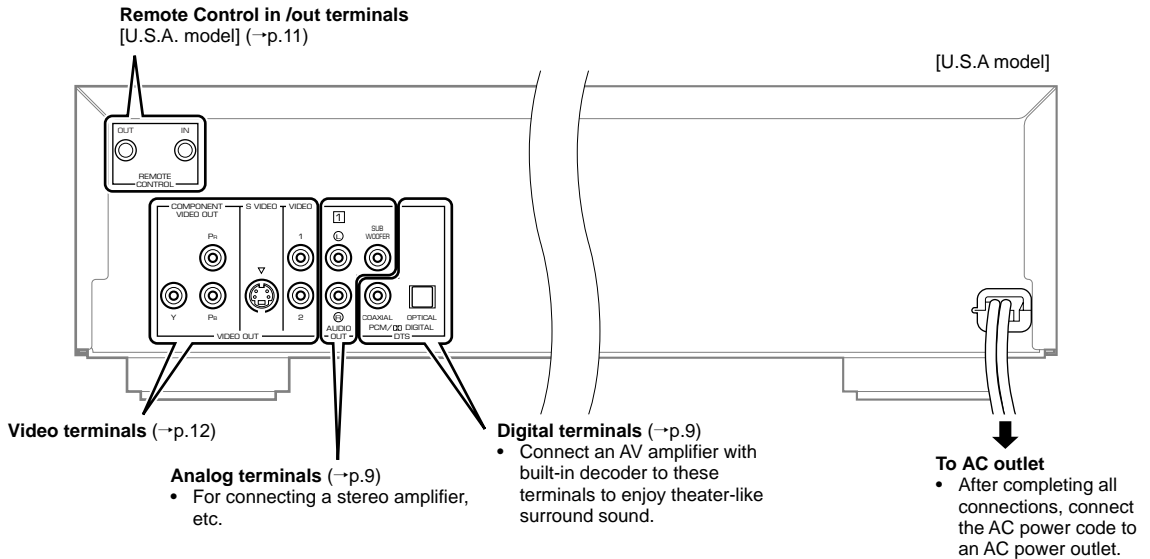

Notes about Audio Connections

Select the correct output format at '7 Digital Audio Output' on the SETUP MENU in accordance with your AV system.

| Equipment to be connected | Appropriate settings at '7 Digital Audio Output' | | | |
|--|--|------------------|-------------------------|---|
| | 1. PCM Down Conversion* | 2. Dolby Digital | 3. DTS Digital Surround | 4. MPEG (Europe, U.K. and Australia models) |
| AV amplifier with digital input(s) and Dolby Digital/DTS/MPEG decoder | Yes | Bitstream | Bitstream | Bitstream |
| AV amplifier with digital input(s) and Dolby Digital/ MPEG*1 decoder (without DTS decoder) | Yes | Bitstream | Off** | Bitstream |
| AV amplifier with Dolby Prologic decoder | Yes | PCM*** | Off** | PCM*** |
| Stereo amplifier without digital input | No | PCM*** | Off** | PCM*** |

* Select 'No' when the connected equipment has 96-kHz/24-bit D/A converter to enjoy high-fidelity audio. However, no digital signal is output if the disc you play is copyright-protected.

** No signal is output from this unit's digital audio output terminal.

*** Multi-channel signals are downmixed to 2-channels Linear PCM and then output from both digital and analog output terminals.

- See p.29 for further information.

Digital Terminals

[U.S.A. model]

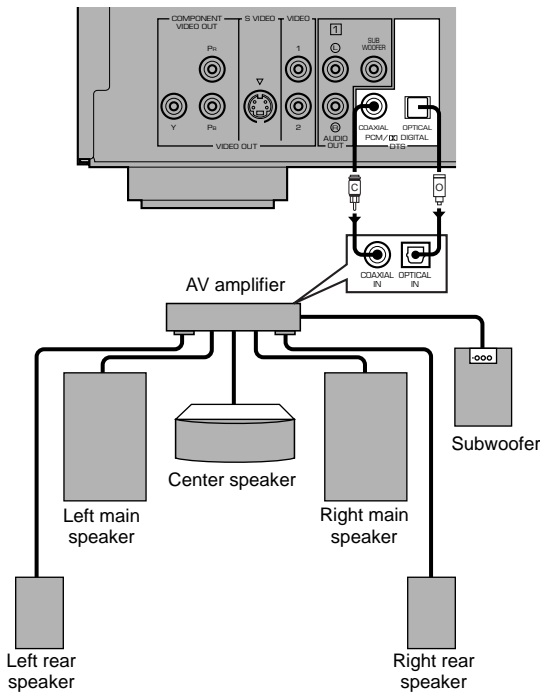

This unit has COAXIAL and OPTICAL digital output terminals. Connect one or both of them to your AV amplifier equipped with Dolby digital, DTS, or MPEG decoder using each specific cable (separate purchase).

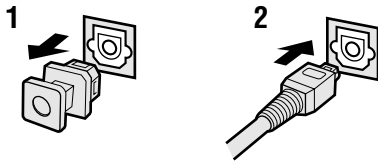

■ When connecting the optical fiber cable

- Remove the cover when using the OPTICAL terminal. Keep the cover and attach it when the terminal is not being used to protect it from dust.
- Bend an optical cable as little as possible.
- Use commercially available optical fiber cable that conforms to EIA standards. Other cables may not function correctly.

Analog Terminals

[U.S.A. model]

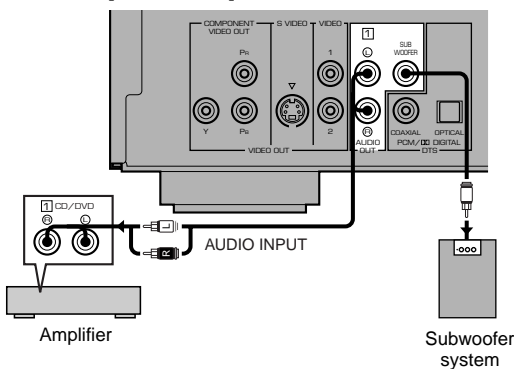

Connect AUDIO OUT L (left) and R (right) terminals of this unit to corresponding input terminals of your audio equipment such as stereo amplifier.

If the audio equipment does not have subwoofer output, you can use this unit's SUBWOOFER terminal to connect your subwoofer system (subwoofer with built-in amplifier). In that case, set the 'subwoofer' item on the on-screen menu to 'ON' (→p.24).

Video Terminals

[U.S.A. model]

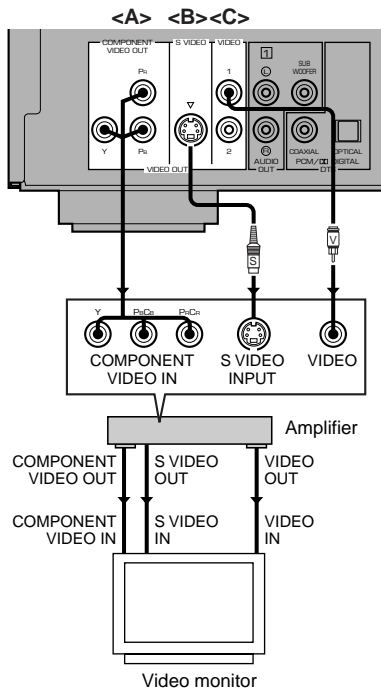

If your AV amplifier has video output terminals, connect your amplifier (and then to your video monitor) so that you can use one video monitor for several different video sources (LD, VCR etc.) by simply switching the input source selector of your amplifier.

This unit has three types of video output terminals. Use one of them in accordance with the input terminals of the equipment to be connected.

Note

- Do not connect this unit to a video monitor through a video cassette recorder. If you do so, the picture may not be played back properly due to the copyright protection technology incorporated in this unit.

Component Video terminal <A>

U.S.A, Canada, Australia and General models

Component video connection achieves high fidelity in reproducing colors (better performance than S-video connection), separating video signal into luminance (Y, terminal color-coded as green), and color difference (Pb, blue/Pr, red). Use commercially available coaxial cables. Amplifier (and Video monitor) with component input is required. Observe the color of each terminal when connecting. If your amplifier does not have component output terminals, connecting this unit's component output directly to your video monitor's component input can reproduce better video image.

Note

- Do not connect this unit's COMPONENT VIDEO OUT terminals to component video input terminals special for HD (High-Definition) TV.

S-Video terminal

S (separate) video connection achieves a clearer picture than composite video connection by separating color and luminance when transmitting signals. Use commercially available S-video cable. Amplifier (and Video monitor) with S-video input is required.

Composite Video terminal (1, 2) <C>

Use RCA video cable supplied with this unit when connecting this unit to a video monitor.

VIDEO 1, 2 terminals of VIDEO OUT output the same signal. You can connect one to your amplifier's input using supplied RCA cable, and the other to another amplifier or a video monitor.

[U. K. model]

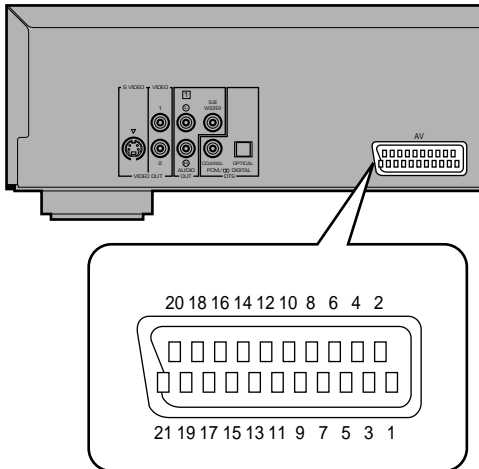

■ 21-pin SCART terminal

U.K. and Europe models

If your video monitor has only 21-pin terminal for video input, and you want to connect it directly to this unit, you can use this unit's 21-pin SCART output terminal (this terminal does not output RGB component signals).

| Pin no. | Video | S video |
|---------|-------------------|------------------------|
| 1 | Audio output (R) | Audio output (R) |
| 3 | Audio output (L) | Audio output (L) |
| 4 | Audio GND | Audio GND |
| 8 | Switching voltage | Switching voltage |
| 13 | No connection | S video (C) output GND |
| 14 | Blanking GND | Blanking GND |
| 15 | No connection | S video (C) output |
| 16 | Blanking | Blanking |
| 17 | Video output GND | S video (Y) output GND |
| 18 | Video input GND | Video input GND |
| 19 | Video output | S video (Y) output |
| 21 | GND | GND |

(Pin no.2, 5 to7, 9 to 12, 20: no connection)

- You can select 'Video' or 'S-Video' at the '6 AV output' on the setup menu '9.Other settings'. See p.30.

Remote Control in/out Terminals [U.S.A. and Canada models]

[U.S.A. model]

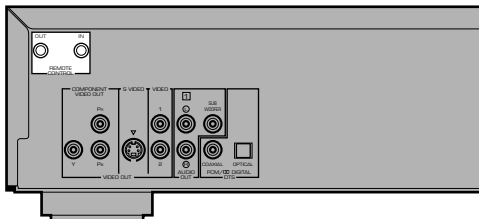

These terminals are used for custom installation system that transmits remote control signals via cables. Connect this unit's REMOTE CONTROL IN to the Remote control output of the control unit of your system.

By connecting this unit's REMOTE CONTROL OUT to another piece of equipment's Remote control input terminal, you can also operate that equipment with the system remote control.

BASIC OPERATION

Before Starting Playback

To play a disc properly, you need to adjust the formats of audio and video signals output from this unit in accordance with the equipment connected to this unit. See p.25 to 30 for more detailed information.

CAUTION

- Be sure to select the appropriate positions at '7 Digital Audio Output' on the SETUP MENU. Otherwise, there may be a case where digital signal which the connected equipment cannot process will be output and its noise could damage your ears and your speakers.

■ 6 TV Aspect

| Type of the connected video monitor | Appropriate setting |
|-------------------------------------|---------------------|
| Conventional type | 1. 4:3 |
| Widescreen type | 2. 16:9 |

■ 7 Digital Audio Output

- To output digital signal from this unit

| The connected audio equipment has | Corresponding item | Appropriate setting |
|-----------------------------------|---------------------------------------|---------------------|
| 96-kHz/24-bit D/A converter | 1. PCM Down Conversion | No |
| Dolby Digital decoder | 2. Dolby Digital | Bitstream |
| DTS decoder | 3. DTS | Bitstream |
| MPEG decoder | 4. MPEG [Europe and U.K. models only] | Bitstream |

Notes

- When you select 'No' at 1. PCM Down Conversion, digital signal may not be output depending on the disc you play.
- Make sure to connect digital terminals of both this unit and the audio equipment as instructed on page 9.

- To output analog signal from this unit

| Item in '7 Digital Audio Output' | Appropriate setting |
|---------------------------------------|---------------------|
| 1. PCM Down Conversion | No |
| 2. Dolby Digital | PCM |
| 3. DTS | Off |
| 4. MPEG [Europe and U.K. models only] | PCM |

- Adjust some other settings such as on-screen display language, ratings, etc. as necessary. See SETUP MENU (p.25 to 30) for detail.

Playing a Disc

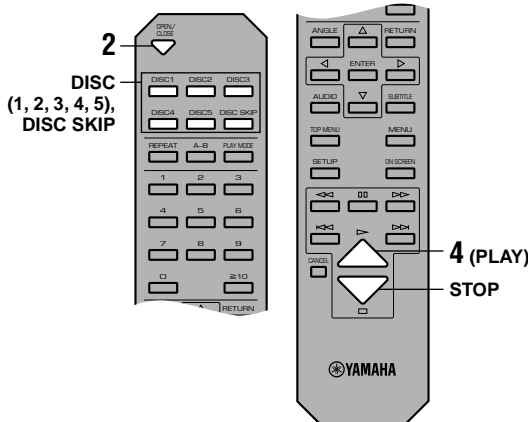
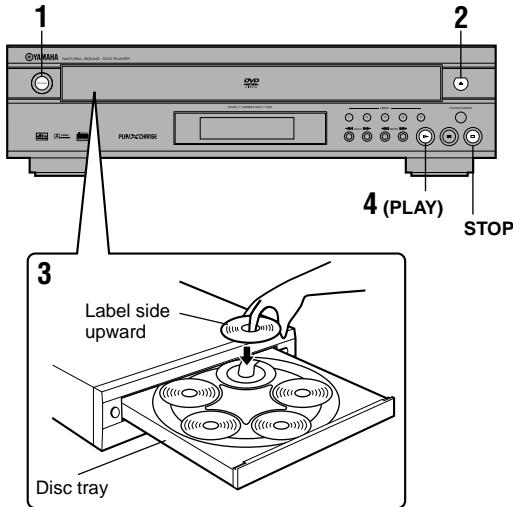

U.S.A., Canada and General models

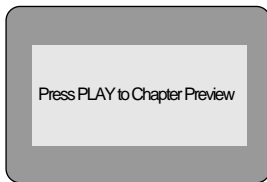

Europe, U.K. and Australia models

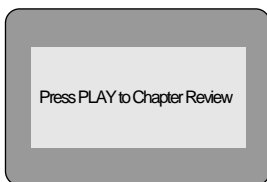

■ Preparation

Select DVD as the input source on your AV amplifier.

- 1 Press POWER to turn the power on.**
- 2 Press OPEN/CLOSE (or Δ) to open the disc tray.**
- 3 Load discs.**
Use the disc guides (numbered, 1 to 5) to align the discs correctly.
- 4 Press \triangleright (PLAY).**
The disc tray closes and playback starts. This unit plays all discs on the tray in sequence.



- If necessary, select a desired disc using DISC SKIP or one of the DISC (1, 2, 3, 4 or 5) buttons.
- When a menu screen appears:
DVD See 'Menu Screen' in p.19.
VCD See 'Playback Control' in p.19.

Note

- When this unit finishes playing a DVD, this unit stops playback or shows the menu screen and does not start playing the next disc.

■ To stop playback

Press \square (STOP).

Resume function

This unit memorizes where \square (STOP) was pressed (\blacktriangleright indicator flashes on the display). When you press \triangleright (PLAY) in this status, playback resumes from where it was stopped. To clear the memory, press \square (STOP) once more so that the \blacktriangleright indicator goes off.

Notes

- This function may not work with some discs or on some part of a disc.
- If you turn the power off, resume function is cleared.

Chapter review function [DVD]

This function plays the first few seconds of each chapter from the beginning of the title up to where the operation was stopped before starting normal playback so that you can review previous chapters.

- 1 Press \triangleright (PLAY) while the message as illustrated on the left is displayed on the screen.**
- 2 Press \triangleright (PLAY) again while the message is displayed on the screen.**

Notes

- This function may not work with some DVDs.
- Canceling resume function will also clear the chapter review function.

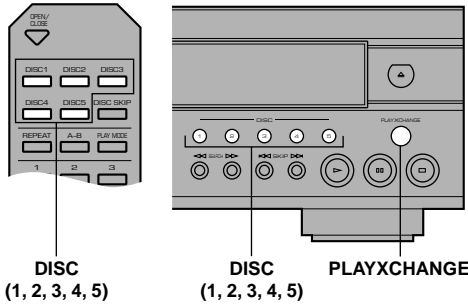

■ After operation

When this unit is not in use, remove discs and press POWER.

■ To select a specific disc

Press DISC (1, 2, 3, 4 or 5).

Playxchange

By pressing PLAYXCHANGE, you can open the disc tray and load or replace discs without interrupting play. **However, never load a disc on the guide half hidden inside the unit because the disc currently being played is to be placed there.**

Search (to advance or reverse playback rapidly)

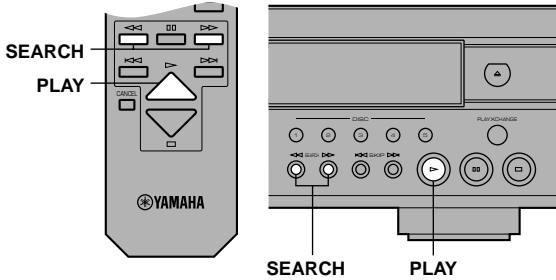

Press SEARCH $\triangleright\triangleright$ (or $\triangleleft\triangleleft$) to search forward (or backward) during playback.

- To return to normal play, press \triangleright (PLAY).



- Pressing the button repeatedly increases searching speed.

Skipping Chapters / Tracks

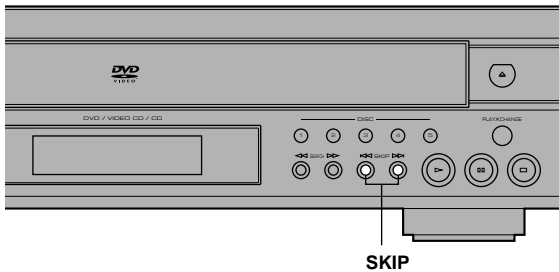

Press SKIP $\triangleright\triangleright$ to skip forward or $\triangleleft\triangleleft$ to skip backward. Press once for each chapter (track) to be skipped.

Note

- When playing a VCD with playback control, skip operation may not function as described above.

■ To select a specific track VCD CD

Enter a desired track number using numeric buttons. To select a two-digit number, press $[\geq 10]$ and then enter the upper figure and the last figure successively.

Example (to select track 17):

- 1 Press $[\geq 10]$
- 2 Press [1].
- 3 Press [7].

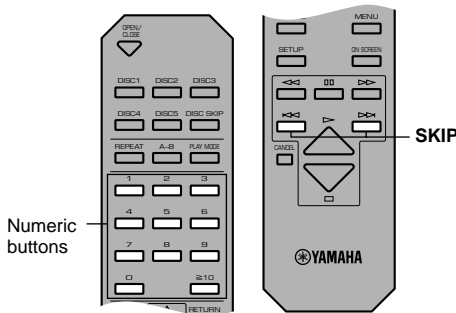

Still Picture (to pause playback)

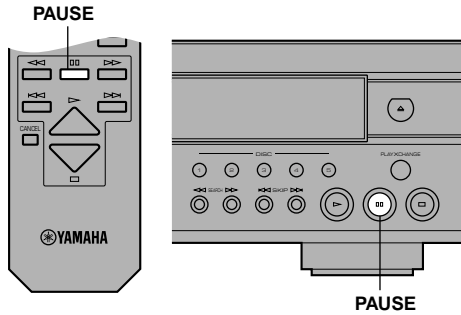

Press **⏸** (PAUSE).

- To resume play, press **▶** (PLAY).

Frame Advance / Reverse

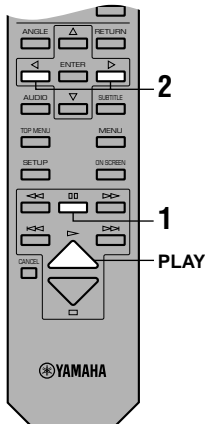

DVD VCD

- 1 Press **⏸** (PAUSE) during playback.
- 2 Press the cursor buttons [**◀**, **▶**].

Each press advances (or reverses) still picture by one frame.

- To return to normal play, press **▶** (PLAY).

Slow-Motion Play

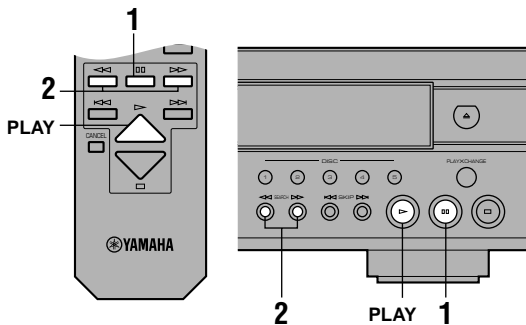

DVD VCD

- 1 Press **⏸** (PAUSE) during playback.
- 2 Press [**◀◀**, **▶▶**].

- To return to normal play, press **▶** (PLAY).



- Pressing the button repeatedly increases the speed.

SELECTING PLAY MODES

Repeat Play

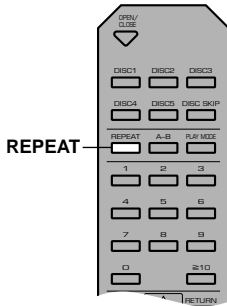

This function allows you to play your desired chapter, track or disc repeatedly.

Press [REPEAT] during playback.

Each time this button is pressed, repeat mode changes as follows. The name of the selected repeat mode scrolls once on the multi-information display and the corresponding indicators light up.

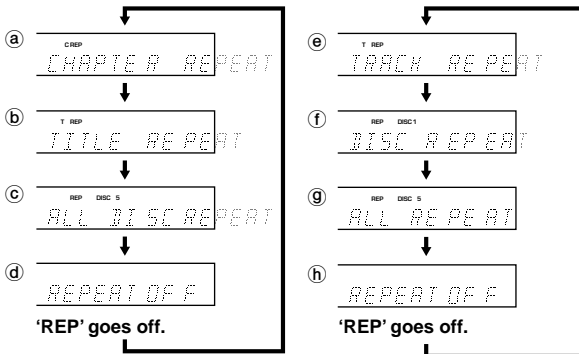

Program repeat

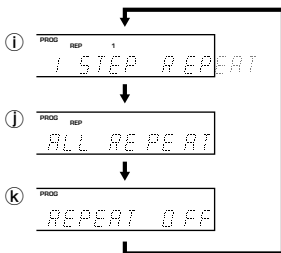

Random-sequence repeat

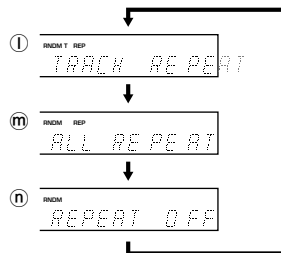

DVD

- (a) **CHAPTER REPEAT**: The current chapter is played repeatedly.
- (b) **TITLE REPEAT**: The current title is played repeatedly.
- (c) **ALL REPEAT**: All the discs loaded on the tray (DVD, VCD or CD) are played repeatedly.
- (d) **REPEAT OFF**: Repeat play mode is canceled.

VCD CD

- (e) **TRACK REPEAT**: The current track is played repeatedly.
- (f) **DISC REPEAT**: The current disc is played repeatedly.
- (g) **ALL REPEAT**: All the discs loaded on the tray (DVD, VCD or CD) are played repeatedly.
- (h) **REPEAT OFF**: Repeat play mode is canceled.

Pressing [REPEAT] while playback is stopped switches 'ALL REPEAT' to 'REPEAT OFF' or vice versa.

Program repeat VCD CD

If REPEAT is pressed during program play (p.18), repeat mode changes as follows.

- (i) **1 STEP REPEAT**: Repeating the track being played
- (j) **ALL REPEAT**: Repeating all the programmed tracks
- (k) **REPEAT OFF**: Canceling repeat mode (go back to normal program play)

Random-sequence repeat VCD CD

If REPEAT is pressed during random-sequence play (p.17), repeat mode changes as follows.

- (l) **TRACK REPEAT**: Repeating the track being played
- (m) **ALL REPEAT**: Playing all the tracks repeatedly, each time in different random-sequence.
- (n) **REPEAT OFF**: Canceling repeat mode (go back to normal random-sequence play)

Notes

- Repeat play may not work properly with some DVDs.
- Repeat play does not work with an interactive DVD or during menu play of a VCD with playback control.

A-B Repeat

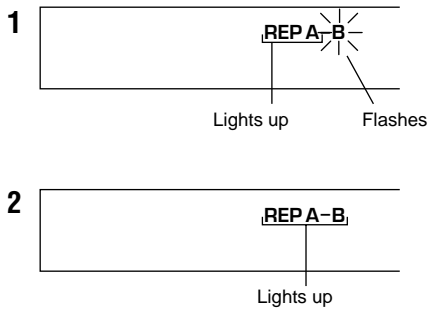
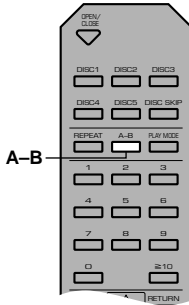

This function allows you to specify two points and play between them repeatedly.

1 Press A-B during play at the point where you want to start A-B repeat.
‘REP’ and ‘A-’ light up and ‘B’ flashes on the display.

2 Press A-B at the point where you want to end A-B repeat.
REP A-B appears on the display and repeat play of the section between point A and B starts.

To cancel A-B repeat

Press A-B repeatedly until A-B indicator on the display goes off.

Notes

- This function may not be available with some DVDs.
- This function works only within a title (DVD) or a track (VCD, CD).

Random-Sequence Play [VCD] [CD]

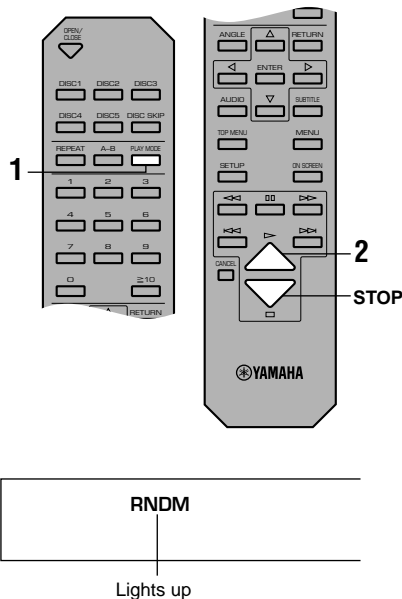

When you select this mode, this unit plays all tracks on all CDs and/or Video CDs loaded on the disc tray in random sequence.

1 Press PLAY MODE once or more while playback is stopped.
RNDM indicator lights up on the display.

2 Press ▷ (PLAY) to start random-sequence play.

To cancel random-sequence mode

- 1 Press □ (STOP) twice during play.
Random-sequence play is suspended.
- 2 Press PLAY MODE once.
RNDM indicator goes off.

If you press ▷ (PLAY) successively, normal playback starts from the beginning of the disc having been played before canceling random-sequence mode.

Opening the disc tray also cancels this mode.

Note

When this unit is in random-sequence mode while a Video CD (ver.2.0) is loaded, playback control is canceled during random-sequence playback.

Program Play [VCD] [CD]

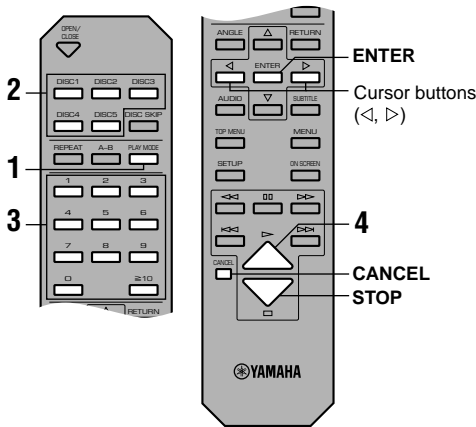

You can enjoy listening to your favorite tracks selected from one or more discs in any desired order by programming tracks.

1 Press PLAY MODE once or more while playback is stopped.

The display shows the step information.

- To exit programming mode, press PLAY MODE twice.

2 Press DISC (1-5) to select the disc.

3 Press numeric buttons to select the track.

- Repeat step 2 and 3 to program other tracks in your desired order.
- See p.14 about how to enter the track with numeric buttons.
- To program a whole disc, press ENTER ('ALL' appears on the display).
- Pressing □ (STOP) cancels all tracks programmed so far.

You can program up to 32 tracks to be played in desired order.

4 Press ▷ (PLAY) to start program play.

To cancel the programmed tracks

- 1 Press the cursor buttons (▷, ◁) to select the track you want to cancel.
- 2 Press CANCEL.

Opening the disc tray also cancels this mode.

Note

When you program a track of a Video CD (ver.2.0), playback control is canceled during program play.

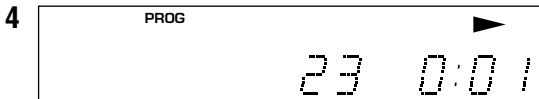
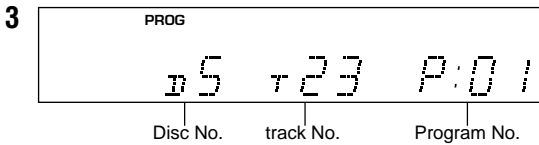
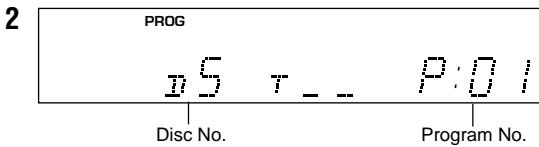

ADVANCED FEATURES

Refer to the discographic information of each disc to determine whether the disc supports these features.

Menu Screen [DVD]

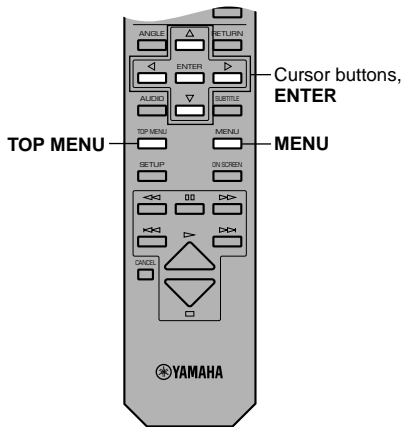

There are DVDs which contain DVD menu screens that enable you to select title, chapter and audio track language, etc or other interactive operations. This section gives you general instruction about how to operate these screens. However, the operation methods may differ depending on the disc.

- 1 Press TOP MENU or MENU during playback to show menu screen.**
 - With some discs, menu screen appears automatically when you start playback.
- 2 Press the cursor buttons (Δ , ∇ , \triangleleft , \triangleright) to select the desired item.**
- 3 Press ENTER to go to the screen of the selected item or to start playing the selected item.**
 - You may also use the numeric buttons to operate steps 2 and 3.

Playback Control [VCD]

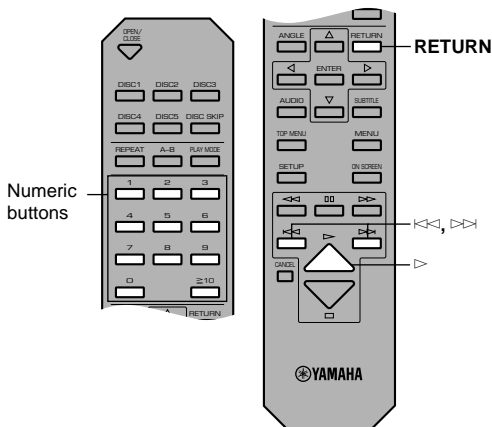

When 'PBC' appears on the display, this unit is in playback control mode. Menu screen appears on the video monitor so that you can use interactive functions supported by the disc being played.

■ To operate menu screen

- You can operate menu screens using the following buttons.
 - Numeric buttons: Press to select the desired item.
 - RETURN:** Press to go back to the previous screen
 - \triangleright : Press to play the selected item
 - $\triangleright \triangleright$: Press to show the next screen
 - $\triangleleft \triangleleft$: Press to show the previous screen

■ To cancel playback control

Press \square (STOP) when the playback control screen appears.

Note

Playback control is automatically canceled during program play or random-sequence play.

Switching Audio Tracks [DVD] [VCD]

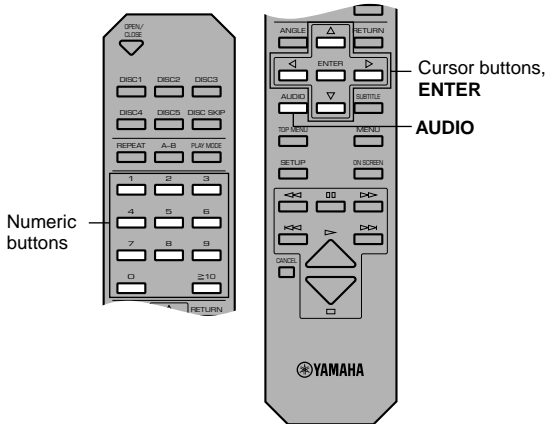

Audio track

Soundtrack number being played (“-” indicates a soundtrack is not recorded.)

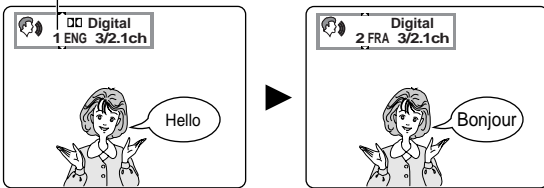

Karaoke Discs

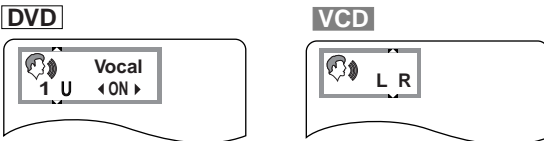

Some DVDs are encoded with several audio tracks so that you can select the language, and/or the sound format.

- 1 Press AUDIO during playback.**
The current audio track appears on the video monitor.
- 2 Press AUDIO repeatedly to select the desired audio track.**
 - You can also use the cursor buttons (Δ, ∇) or the numeric buttons.

Note

With some discs, switching audio tracks during playback is prohibited. In that case, use SETUP MENU (p.26) to select it.

Turning on and off vocal for Karaoke disc

1. Press AUDIO during playback.
2. Press the cursor buttons [Δ, ∇, ◀, ▶] or press AUDIO to change the setting.

| | |
|-------------|---|
| DVD Karaoke | Solo —: Vocal OFF ON: Vocal ON |
| | Duet —: Vocal OFF 1+2: Vocal 1,2 ON V1: Vocal 1 ON, Vocal 2 OFF V2: Vocal 2 ON, Vocal 1 OFF |
| VIDEO CD | LR: Vocal heard from the right L: Vocal OFF R: Vocal heard from both left and right |

Note

With some discs, you may need to operate additional steps. Refer to the disc’s instructions.

To turn the display off

Press ENTER.

Switching Subtitle Tracks [DVD]

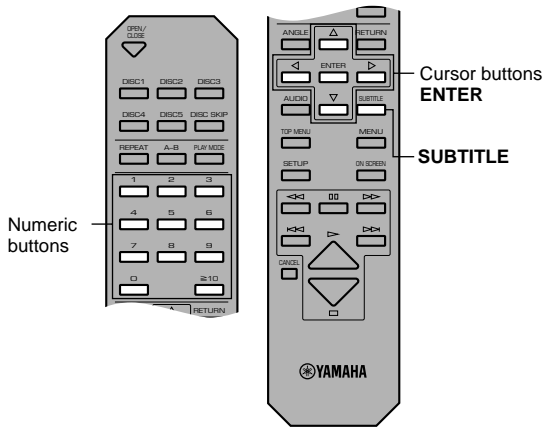

Some DVDs are encoded with multilingual subtitle tracks so that you can select one of them.

1 Press SUBTITLE during playback.

On-screen display that shows currently selected subtitle track language appears on the video monitor.

2 Press SUBTITLE repeatedly to select the desired subtitle track.

- You can also use the cursor buttons (Δ , ∇) or the numeric buttons.
- Pressing the cursor buttons (\leftarrow , \rightarrow) switches subtitles on and off.

Note

'-' appears if the disc does not have a subtitle.

■ To turn the display off

Press ENTER.

Subtitle

Subtitle language number being played

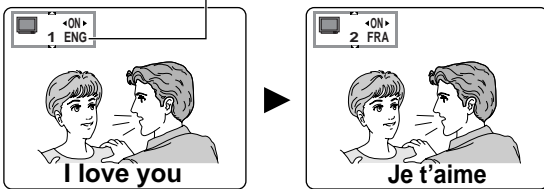

Switching Camera Angles

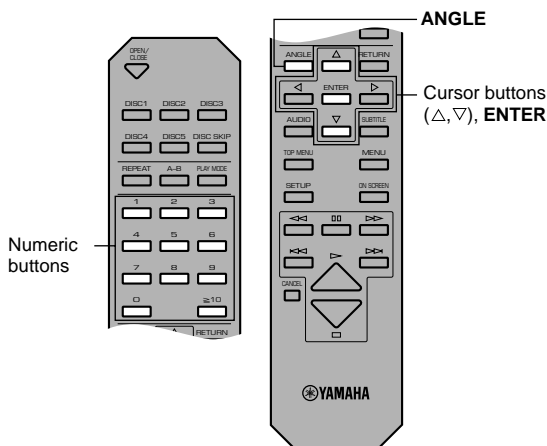

Some DVDs have scenes encoded with multiple camera angles so that different viewpoint can be selected during playback. ANGLE lights up on the front panel display while a scene encoded with multiple angles is being played.

1 Press ANGLE while ANGLE on the front panel display lights up.

On-screen display that shows currently selected angle appears on the video monitor.

2 Press ANGLE repeatedly to select the desired angle.

- You can also use the cursor buttons (Δ , ∇) or the numeric buttons.

■ To turn the display off

Press ENTER.

Angle

Angle number being played

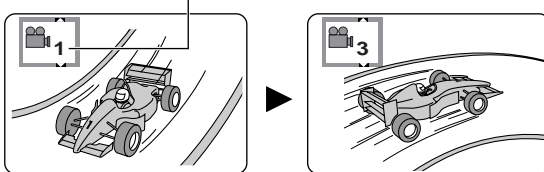

ON-SCREEN MENU

This unit features On-Screen Menu icons (Graphical User Interface) that makes operation easy and intuitive. Graphics that represent the functions appear in alignment on the upper side of the video monitor.

Operating On-Screen Menu

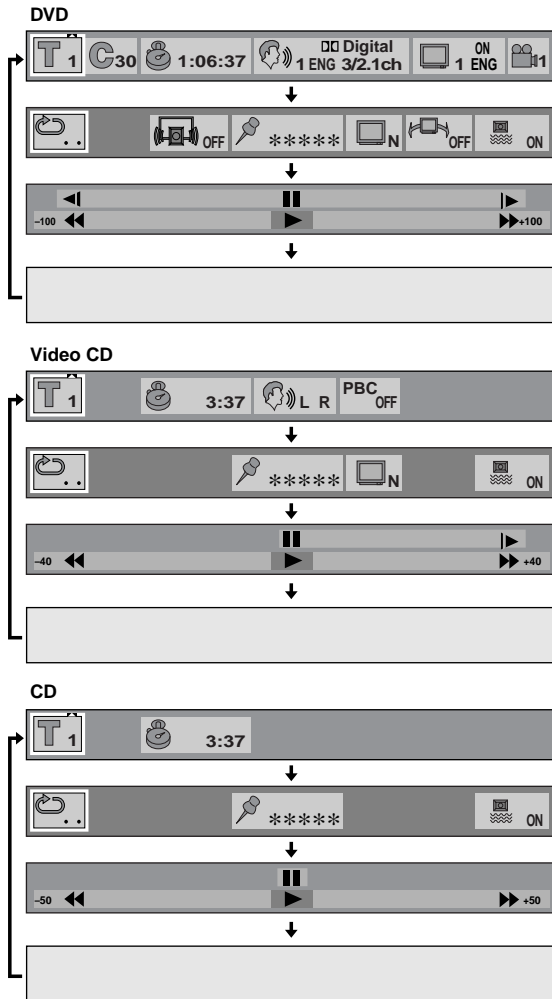

1 Press ON SCREEN.

Each time ON SCREEN is pressed, the screen changes and appears on the video monitor as below.

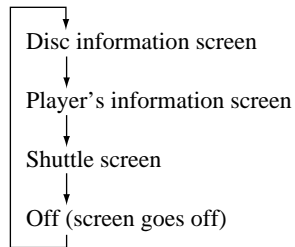

2 Press the cursor buttons (◀, ▶) to select the item you want to adjust.

The selected item is highlighted in yellow.

3 Press the cursor buttons (△, ▽) to change setting.

- With some items, you need to press ENTER or ▶ (PLAY) to determine the setting.
- You can also use the numeric buttons when entering numbers to select a chapter, etc.
- You can also use RETURN or CANCEL to turn the screen off.
- △ and ▽ around the icon means that the item can be changed using the cursor buttons [△, ▽].

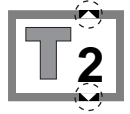

Note

- These screens may not be displayed, or partly cut off depending on the disc being played, or when the video monitor (TV)'s automatic zoom function is on. You can change their position lower at '4 On-Screen Message' on the SETUP MENU.

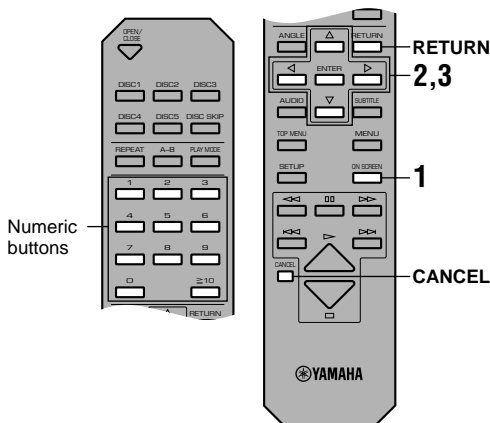

Disc Information Screen

Each icon shows the status of the currently played disc.

| | |
|--|---|
| | Title No. DVD Track No. VCD CD Select the desired title/track number and press ENTER to start playback. |
| | Chapter No. DVD Select the desired chapter number and press ENTER to start playback. |
| | Time Index (hour:minute:second) DVD Enter the time and press ENTER to start playback from there. Example: To specify 1:06:37, press the numeric buttons 1, 0, 6, 3 and 7. |
| | Time display (minute:second) VCD CD Elapsed time cannot be changed. When playing a VCD with playback control, elapsed time does not appear. Each time the cursor buttons (Δ, ∇) is pressed, the display changes as below. Elapsed time → Time remaining on the current track → Time remaining on the disc |
| | Audio Track DVD Select the desired audio track (language and sound format). Each time the cursor buttons (Δ, ∇) is pressed, the combination of language and sound format switches to another, in accordance with the disc's available audio tracks. Example: 1 ENG/LPCM → 1 ENG/Digital → 2 FRA/LPCM → 2 FRA/Digital... a Language: See the table a . b Sound format: See the table b for detail. |
| | Audio Track VCD Select the desired channel(s) from LR (both left and right channels), L (left channel output from both left and right speakers) or R (right channel output from both left and right speakers). There are VCDs that contain one language on the left channel and another on the right so that you can select the desired language from the two. |
| | Subtitle, ON/OFF DVD Select the desired subtitle track. See the table a . |
| | Angle DVD Select the desired camera angle while a scene encoded with multiple angles is played. |
| | Playback Control VCD Shows whether playback control is on or off (cannot be changed here). • To cancel the playback control function, see p.19. |

a Language

| | | |
|--------------|-----------------|-----------------|
| ENG: English | SVE: Swedish | CHI: Chinese |
| FRA: French | NOR: Norwegian | KOR: Korean |
| DEU: German | DAN: Danish | MAL: Malay |
| ITA: Italian | POR: Portuguese | VIE: Vietnamese |
| ESP: Spanish | RUS: Russian | THA: Thai |
| NLD: Dutch | JPN: Japanese | *: Others |

b Sound format







| | |
|--|---|
| LPCM | 96k/48k: Sampling frequency (kHz) |
| | 16b/20b/24b: Number of sample signals (bit) |
| Digital/DTS/MPEG [Europe, U.K. and Australia models] | ch: number of channels 3 / 2 . 1 ch (example) └─ Low frequency effect output from the subwoofer └─ Two rear channels output from Surround (left/right) speakers └─ Three front channels output from main (left/right) and center speakers |

Notes

- Display may differ in accordance with the disc's specification.
- Time remaining on the disc does not appear during program or random-sequence play.
- MPEG multi-channels may not appear properly (Europe, U.K. and Australia models).

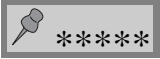
Player's Information Screen

This screen enables you to operate various features equipped with this unit to expand your enjoyment for audio listening and video watching.

| | |
|--|---|
|  | <p>A-B Repeat Press ENTER during playback to specify the point A, then press ENTER again to specify the point B. This unit starts A-B repeat play. Pressing ENTER one more time cancels A-B repeat.</p> |
|  | <p>Cinema Dialogue DVD Turn this function on and off using the cursor buttons (Δ, ▽). When this function is on, volume level for dialogue increases so that you can catch it clearly even playing a disc at low volume.</p> |
|  | <p>Marker You can mark up to five parts so that you can start playback these parts immediately. First press ENTER to select this item, then select one from five asterisks with the cursor buttons (◀, ▶) and press ENTER during playback to specify the point to start (the selected asterisk turns to be the marker no.). Press ENTER again to specify the point to complete marking.</p> <ul style="list-style-type: none"> • To recall a marker : Select the marker no. using the cursor buttons [◀, ▶] and press ENTER. • To clear a marker : Select the marker no. using the cursor buttons [◀, ▶] and press CANCEL. Markers are all cleared when you open the tray or turn this unit off. |
|  | <p>Cinema Image DVD VCD (for U.S.A. and Canada models) You can select the preferred video image. N: Normal C: Cinema (suited for movie viewing)</p> |
|  | <p>Virtual Surround Sound (V.S.S) DVD When this function is on, you can enjoy a surround-like effect without using rear surround speakers. For optimum effect, keep the distance from main speakers to your listening position about 3 to 4 times the distance between the left and right main speakers. OFF: V.S.S off 1: V.S.S natural effect 2: V.S.S emphasized effect</p> |
|  | <p>Subwoofer Output Decide whether to output signals from this unit's subwoofer output terminal. ON: Select this position if a subwoofer is connected to this unit's subwoofer output terminal. OFF: Select this position if this unit's subwoofer output terminal is not used.</p> |

Notes

- Subtitles around the markers may not appear.
- Virtual surround sound is only effective with discs encoded with multi-channel Dolby Digital format (except for karaoke discs).
- When virtual surround sound is on, only the main speakers output the sound.

Shuttle Screen

You can operate multi-speed playback with this screen.

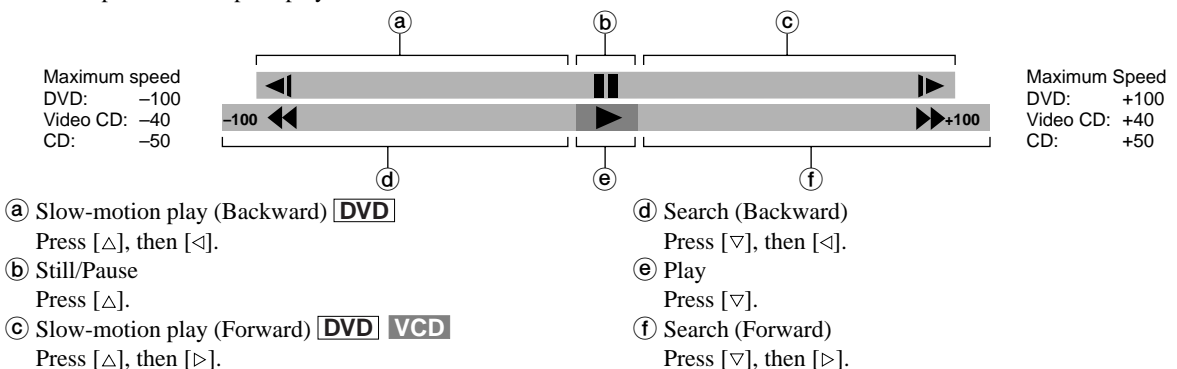

- Pressing the cursor button [▶] (or [◀]) increases (or decreases) the speed of searching and slow-motion play up to five steps.

SETUP MENU

This unit provides you with the following items on the Setup menu to maximize the performance of this unit and your AV system. Select the appropriate positions as necessary.

1. Disc Language (→ p.26)
2. Ratings (→ p.27)
3. Menu Language (→ p.28)
4. On-Screen Messages (→ p.28)
5. FL Display (→ p.28)
6. TV aspect (→ p.28)
7. Digital Audio Output (→ p.29)
9. Other Settings (→ p.30)

Note

- Item no.8 does not exist.

Operating the Setup Menu

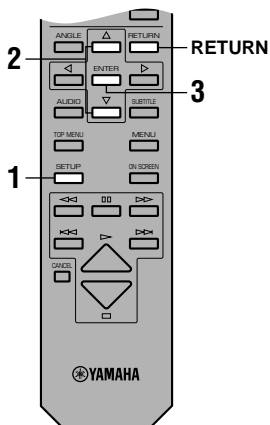

This section shows common procedures (some items require additional steps). Use the remote control to operate the setup menu.

1 Press SET UP while playback is stopped.

The menu screen appears on the video monitor.

2 Select the desired item using the cursor buttons (Δ, ▽) and press ENTER.

Operating screen of the selected item appears on the video monitor.

3 Select the desired position using the cursor buttons (Δ, ▽) and press ENTER.



- To go back to the previous screen, press RETURN.
- To get out from the Setup menu mode, press SET UP.

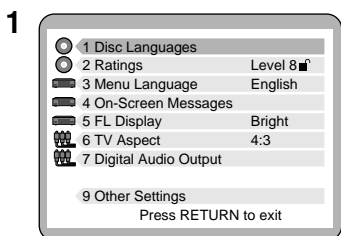

DESCRIPTION OF EACH ITEM

1. Disc Language [DVD]



You can select the language of audio track, subtitle track and disc menu.

U.S.A. and Canada models

| | | | |
|------------|-----------------------------|------------------------|-----------|
| 1 Audio | 1 English 4 Original* | 2 French 5 Other** | 3 Spanish |
| 2 Subtitle | 1 Automatic*** 4 Spanish | 2 English 5 Other** | 3 French |
| 3 Menus | 1 English 4 Other** | 2 French | 3 Spanish |

Europe, U.K. and Australia models

| | | | |
|------------|---|------------------------|-------------------------|
| 1 Audio | 1 English 4 Italian 7 Other** | 2 French 5 Spanish | 3 German 6 Original* |
| 2 Subtitle | 1 Automatic*** 4 German 7 Other** | 2 English 5 Italian | 3 French 6 Spanish |
| 3 Menus | 1 English 4 Italian | 2 French 5 Spanish | 3 German 6 Other** |

General model

| | | | |
|------------|-----------------------------|-----------|-------------|
| 1 Audio | 1 English 4 Other** | 2 Chinese | 3 Original* |
| 2 Subtitle | 1 Automatic*** 4 Other** | 2 English | 3 Chinese |
| 3 Menus | 1 English | 2 Chinese | 3 Other** |

* The original language of each disc is selected.

** You can select another language by selecting this position and entering the code for the desired language (see the 'Language code list' on p.33).

*** Subtitle track language is automatically determined according to the current status on '1 Audio'.

- When the audio track language reproduced during playback is the one selected at '1 Audio', the subtitle is not shown.
- When the audio track language reproduced during playback is other than the one selected at '1 Audio', subtitle is shown in the language selected at '1 Audio'.

Notes

- If the disc does not have audio track of the selected language, the language designated by each disc is reproduced.
- Subtitle does not appear if the disc does not have one.

2. Ratings [DVD]

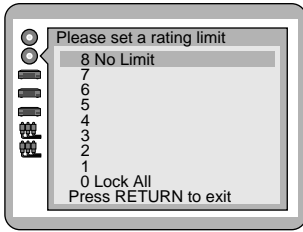

Depending on software capability, you can prevent discs or scenes with objectionable material from being played according to your desired rating. You can select the level and lock it by designating password.

| | |
|--------------|--|
| Level 8 | All DVDs can be played. |
| Level 7 to 1 | Level of restriction becomes severer as the number gets smaller. |
| Level 0 | All DVDs cannot be played. |

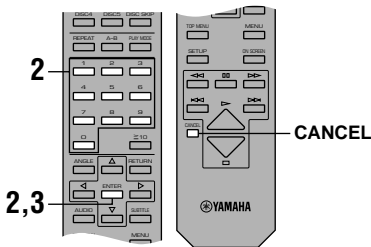

■ Setting method

1 Follow steps 1 to 3 of 'Operating the Setup Menu' (see p.25) to select the desired level.

2 Enter 4-digit number with numeric buttons and press ENTER.

- Press CANCEL if you want to re-enter other number.
The screen that confirms your password appears. Do not forget your password.

3 Press ENTER.



When you select a disc that exceeds the rating you have set, a message appears on the monitor. If you want to play the disc, select 'Yes' and enter your password. The unit unlocks the setting temporarily, locking again when the disc tray is opened or the unit is turned off.

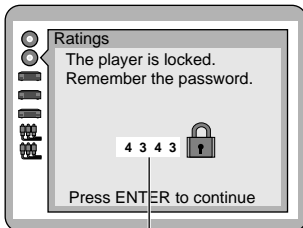
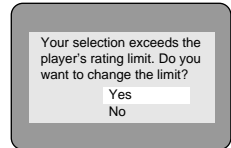

Example: "4343"

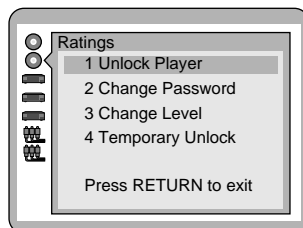

■ To Change Settings

You must enter your designated password when you unlock the player (level is set to 8), change the level, change the password, or unlock the playback of currently selected disc.

Select '2 Ratings' and then follow each procedure appears on the screen.

Note

- In case you have lost the password and if you want to change the ratings settings, you must return the entire setup menu to the factory setting to cancel the previously specified password. See p.32 about resetting method.

3. Menu Language

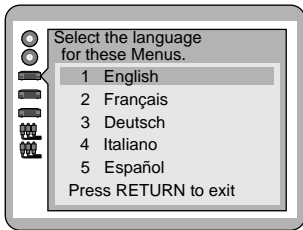

Select the language used for on-screen display and setup menu.

U.S.A. and Canada models

- 1 English
- 2 Français
- 3 Español

Example: If you selected "2 Français"

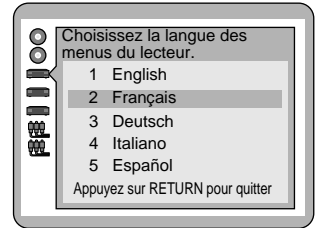

Europe, U.K. and Australia models

- 1 English
- 2 Français
- 3 Deutsch
- 4 Italiano
- 5 Español

General model

- 1 English
- 2 中文

4. On-Screen Messages

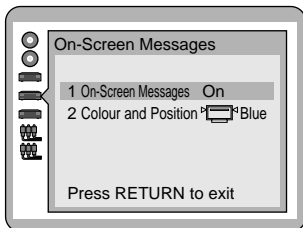

You can select whether to show on-screen message (information of the current status such as Play, Still, etc.) or not, and its color and position.

| | | | |
|--------------------|-------|--|--------|
| On-Screen Messages | 1 On | | |
| | 2 Off | | |
| Color and Position | 1 | | Blue |
| | 2 | | Violet |
| | 3 | | Green |
| | 4 | | Blue |
| | 5 | | Violet |
| | 6 | | Green |

Shown slightly lower. Select if the top of the screen is cut off.

5. FL Display

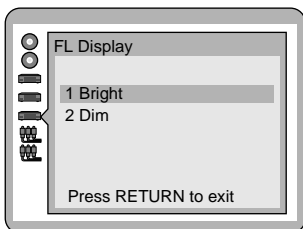

Select the brightness of the front panel display.

- 1 Bright
- 2 Dim

6. TV Aspect

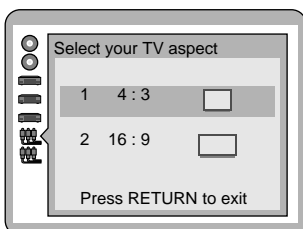

Change the setting to suit your type of video monitor.

- 1 4:3
Select when a conventional 4:3 aspect ratio video monitor is connected.
- 2 16:9
Select when a wide-screen type video monitor is connected.

- Regardless of the above description, select the optimum setting for your video monitor.

7. Digital Audio Output

Select the appropriate position for your AV system (AV amplifier, etc.) which this unit is connected to. When you setup your AV system, you must adjust this setting before starting playback. Otherwise, there may be a digital signal which the connected equipment cannot process and the consequent noise could damage your ears and your speakers.

U.K., Europe and Australia models

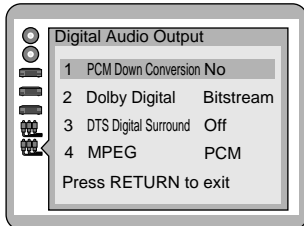

U.S.A, Canada and General models

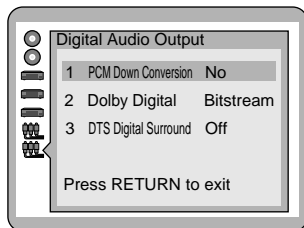

| | |
|---|--|
| <p>1 PCM Down Conversion When playing a 96 kHz linear PCM disc, you can choose whether to output high-fidelity analog signal, or convert it down to 48 kHz to output digital signal.</p> | <p>1 No When playing a DVD recorded in 96 kHz linear PCM, signal of 96 kHz /24 bit sampling frequency is output and you can enjoy high quality sound. If the DVD is copyright-protected, no digital signal is output unless converted to 48 kHz.</p> <ul style="list-style-type: none"> • Select this position when connecting equipment without digital input. <p>2 Yes When playing a DVD recorded in 96 kHz linear PCM, signal is converted to 48 kHz /16 bit sampling frequency and can be output from digital output terminal even if the DVD is copyright-protected.</p> <ul style="list-style-type: none"> • It is recommended to select this position when connecting equipment with digital input.* |
| <p>2 Dolby Digital To select the signal format output from this unit when playing a DVD encoded with Dolby Digital.</p> | <p>1 Bitstream Dolby Digital bitstream signal is output from this unit's digital output.</p> <ul style="list-style-type: none"> • Select this position when connecting equipment incorporates Dolby Digital decoder. <p>2 PCM** Signals converted to 2ch linear PCM is output from this unit.</p> <ul style="list-style-type: none"> • Select this position when connecting equipment which does not have Dolby Digital decoder. |
| <p>3 DTS Digital Surround Select whether to output DTS digital signal or not.</p> | <p>1 Off** No digital signal is output even though the disc being played is encoded with DTS to prevent digital signal to be output.</p> <ul style="list-style-type: none"> • Select this position when connecting equipment which does not have a DTS decoder. <p>2 Bitstream DTS bitstream is output when playing a disc encoded with DTS format.</p> <ul style="list-style-type: none"> • Select this position when connecting equipment incorporates a DTS decoder. |
| <p>Europe, U.K. and Australia models</p> <p>4 MPEG To select the signal format output from this unit when playing a DVD encoded with MPEG audio.</p> | <p>1 PCM** Signals converted to 2ch linear PCM is output from this unit.</p> <ul style="list-style-type: none"> • Select this position when connecting equipment which does not have a MPEG decoder. <p>2 Bitstream*** MPEG bitstream signal is output from this unit's digital output.</p> <ul style="list-style-type: none"> • Select this position when connecting equipment incorporates a MPEG decoder. |

* Select 'No' if the digital audio input of your audio equipment (AV amplifier, etc.) can handle 96 kHz /24 bit signal. If it is not acceptable for 96 kHz /24 bit digital audio signal, or the 96 kHz linear PCM disc you want to play is copyright-protected, it is recommended to set '1 No' and make analog connection to enjoy high quality sound. If it is set to '2 Yes', signal is converted to linear PCM 48 kHz before being output from analog output.

** When connecting equipment which does not have decoder for each format, be sure to select this position to prevent noise output as it could damage your ears and your speakers.

*** Depending on disc's capability, MPEG audio bitstream may not be output properly.

9. Other Settings

U.S.A. and Canada models

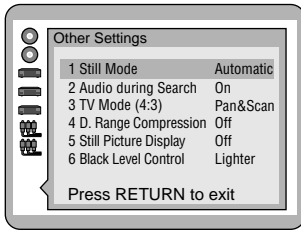

U.K. and Europe models

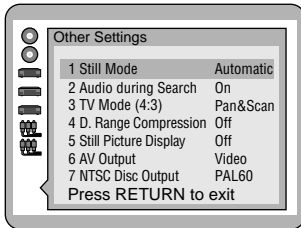

General and Australia models

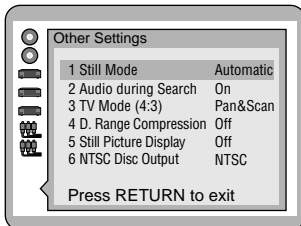

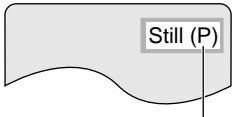
| | |
|---|---|
| <p>1 Still Mode To adjust the quality of still picture.</p> | <p>1 Automatic 2 Field If jittering occurs when '1 Automatic' is selected, switch to this position. 3 Frame If detail such as small patterns or letters of still picture is not clear when '1 Automatic' is selected, switch to this position.</p> |
| <p>2 Audio during Search To select whether to hear audio during search forward at the initial search speed when playing DVD or VCD (CD can be heard at any speed).*</p> | <p>1 On 2 Off</p> |
| <p>3 TV Mode (4:3) To select the picture style when playing a widescreen video disc on a standard 4:3 width-to-height ratio video monitor.</p> | <p>1 Pan & Scan The video appears in pan and scan style, with either one or both ends cut off. 2 Letterbox The video appears in letterbox style, with black bands on top and bottom of the monitor.</p> |
| <p>4 D.(Dynamic) Range Compression To compress the dynamic range (the difference between the maximum level and the minimum level of sounds) as necessary. This item is only effective for Dolby Digital DVD.</p> | <p>1 Off Played back with disc's original dynamic range. 2 On The range is compressed to make it easier to hear dialog, etc. even at low volume level. Select this position in occasions such as viewing late at night.</p> |
| <p>5 Still Picture Display [DVD] To show I, P or B** during still picture mode.</p> | <p>1 Off 2 On</p> <div style="text-align: right;">  <p>Example: 'P' Picture</p> </div> |

* DTS audio is not heard during search regardless of the setting.

** I/P/B: When 'I' appears, it indicates that the frame is the original one and has greater amount of information than that of 'P' or 'B'. 'P' is made from 'I', and 'B' is to fill in the space between 'I' and 'P'. It is recommended to use 'I' picture for adjusting video image.

| | |
|--|--|
| <p>Black Level Control U.S.A. and Canada models To adjust luminosity of black color according to the type of video connection you have made.</p> | <p>1 Lighter Select when you made video connection through the composite or S-video terminals. 2 Darker Select when you made video connection through the component terminals.</p> |
| <p>AV output Europe and U.K. models To select the video signal type (composite or S-video) to be output from the SCART terminal.</p> | <p>1 Video Composite signal is output. 2 S Video S-video signal is output.</p> |
| <p>NTSC Disc Output Europe, U.K., General and Australia models To select video signal format (PAL 60 or NTSC) to be output when playing NTSC disc.</p> | <p>1 PAL 60 Select when the connected video monitor can accept PAL 525/60 system. 2 NTSC Select when a Multi-system video monitor is connected.</p> |

TROUBLESHOOTING

If this unit fails to operate normally, check the following points to determine whether the fault can be corrected, or if the fault is not listed in the PROBLEM column, disconnect the power cord and contact your authorized YAMAHA dealer or service center.

■ General

| PROBLEM | POSSIBLE CAUSE | WHAT TO DO | Refer to Page |
|---|---|---|---------------|
| This unit fails to turn on when the POWER switch is pressed. | The power cord is not connected or the plug is not completely inserted. | Firmly connect the power cord. | — |
| | The voltage selector on the rear panel is not set to the proper position. | Disconnect the power cord and set the selector to the position for your local main voltage. | — |
| This unit does not work normally. | This unit is affected by an external shock (lightning, excessive static electricity, incorrect operation, etc.) | Turn the power off and disconnect the power cord. After about 30 seconds have passed, connect the power and operate the unit again. | — |
| Playback does not start. | The disc is damaged. | Check the disc carefully; replace it if necessary. | — |
| | There is moisture on the laser pickup. | Wait 20 to 30 minutes after switching the unit ON before trying to play a disc. | — |
| | The disc has been loaded upside down. | Reload the disc with the label side facing up. | 13 |
| | The disc is dirty. | Clean the disc. | 3 |
| No picture. | Incorrect video connections. | Connect this unit and other equipment properly. | 10 |
| | This unit's video input is not selected at the video monitor. | Set the video input at the video monitor to the position where this unit is connected (e.g. VCR2). | — |
| Play is delayed, or starts at the wrong place. | The disc may be scratched or damaged. | Check the disc carefully; replace it if necessary. | — |
| This unit does not recognize discs ('No disc' appears on the display, or the display shows the status when no disc is loaded). | The disc(s) is not placed properly. | Place the disc(s) correctly along the guide(s). | — |
| No sound. | Incorrect output cable connections. | Connect the cables properly. If the problem persists, the cables may be defective. | 9 |
| | Incorrect amplifier operation. | Set the amplifier controls to the correct input selection. | — |
| Sound distorted. | V.S.S effect is emphasized too much. | Turn V.S.S. off. | 24 |
| Sound 'skips'. | This unit is being subjected to vibrations or impacts. | Relocate the unit. | — |
| | The disc is dirty. | Clean the disc. | 3 |
| Sound 'hums'. | Incorrect cable connections. | Securely connect the audio cables. If the problem persists, the cables may be defective. | 9 |
| Noise from a nearby tuner. | The tuner is too close to the unit. | Place the tuner and the unit farther apart. | — |
| Noise from inside of the unit. | The disc maybe warped. | Replace the disc. | — |
| The remote control does not work. | The batteries are weak. | Replace all batteries with new ones. | 7 |
| | Direct sunlight or lighting (from an inverter type of fluorescent lamp, etc.) is striking the remote control sensor of this unit. | Relocate the unit. | 7 |

■ DVD

| PROBLEM | POSSIBLE CAUSE | WHAT TO DO | Refer to Page |
|---|---|---|---------------|
| Picture does not match your video monitor. | The setting at '6 TV Aspect' on the setup menu is not correct. | Select the proper position. | 28 |
| Audio track and/or subtitle language is not the selected one. | The disc does not contain the language you have selected. | | — |
| No subtitles. | The disc does not have subtitles. | | — |
| | Subtitle is turned off. | Show subtitles by pressing SUBTITLE or using on-screen menu. | 21, 23 |
| Angle cannot be changed. | The disc or the scene being played does not support multi-angle. | | — |
| No sound from effect speakers (center and rear left/right) when digital signals from this unit are selected as the input source on your AV amplifier. | The setting at '7 Digital Audio Output' on the setup menu is not correct. | If your AV amplifier has built-in decoders for Dolby Digital, DTS or MPEG, Select 'Bitstream' at corresponding position. | 29 |
| No sound when playing a disc encoded with DTS. | Digital connection is not made between this unit and your amplifier. | Make digital connection between this unit and your amplifier and adjust the settings at '7 Digital Audio Output' on the setup menu. | 9, 29 |
| The password for setting parental level has been forgotten. | | Clear all settings on the setup menu. See 'Returning setup menu to the factory-setting' below this table. | — |

■ Returning setup menu to the factory-setting

While playback is stopped, press and hold **PAUSE**, and then **PLAYXCHANGE** on the front panel until 'Initialized' appears on the video monitor. All settings on the setup menu return to the factory settings.

■ Video CD

| PROBLEM | POSSIBLE CAUSE | WHAT TO DO | Refer to Page |
|-----------------------|---|------------|---------------|
| Menu does not appear. | The disc does not have playback control function. | | — |

GLOSSARY / LANGUAGE CODE LIST

■ Title

'Title is a unit to divide the contents on a DVD disc. Generally, one title is assigned to one movie. When a disc has two or more titles, they are numbered in sequence as title 1, title 2, etc.

■ Chapter

A title on a DVD is subdivided into smaller divisions. They are referred as 'chapters' and numbered in sequence. You can use them to search the desired scene on a movie, etc.

■ Track

Tunes (or pictures) recorded on a CD or Video CD are referred as 'tracks'. Tracks are numbered in sequence as track 1, track 2, etc. They are useful for quick search for the desired tune (or picture).

■ Dolby Digital

Dolby Digital is a digital audio format which mainly provides high-quality multi-channel audio tracks for movies. It provides up to 6 independent channels compatible with 6 speaker configurations: Left main, right main, center, left surround, right surround and subwoofer. It stores a large volume of digital sound signals as data into a DVD, etc. with a high level data-compression technology.

■ DTS

DTS (Digital Theater System) is also a multi-channel digital audio format, providing 6 channel audio track. DTS encodes high-quality, 20 bit audio onto a compact disc, and a DVD with less data-compression.

■ Linear PCM

A basic digital audio format used in CDs. It is based on Pulse Code Modulation (PCM), an analog-to-digital conversion technology. No compression is applied to the data.

■ MPEG

There are two types of MPEG (Moving Picture Expert Group) audio format. MPEG 1 is mainly used in Video CDs. MPEG 2, improved from MPEG 1, provides high-quality multi-channel audio track up to 8 channels. MPEG 2 technology is mainly used in Europe, Australia, etc.

■ Playback control

This function is recorded on a Video CD, version 2.0. Pictures, music, etc. you want to play can be selected on a screen menu shown on the video monitor.

Language code list

| | | | | | |
|-----------------------|--------------------|-------------------|------------------------|----------------------|------------------|
| 6565: Afar | 6890: Bhutani | 7285: Hungarian | 7679: Laotian | 8084: Portuguese | 8469: Telugu |
| 6566: Abkhazian | 6976: Greek | 7289: Armenian | 7684: Lithuanian | 8185: Quechua | 8471: Tajik |
| 6570: Afrikaans | 6978: English | 7365: Interlingua | 7686: Latvian, Lettish | 8277: Rhaeto-Romance | 8472: Thai |
| 6577: Ameharic | 6979: Esperanto | 7378: Indonesian | 7771: Malagasy | 7771: Malagasy | 8473: Tigrinya |
| 6582: Arabic | 6983: Spanish | 7383: Icelandic | 7773: Maori | 8279: Romanian | 8475: Turkmen |
| 6583: Assamese | 6984: Estonian | 7384: Italian | 7775: Macedonian | 8285: Russian | 8476: Tagalog |
| 6588: Aymara | 6985: Basque | 7387: Hebrew | 7776: Malayalam | 8365: Sanskrit | 8479: Tonga |
| 6590: Azerbaijani | 7065: Persian | 7465: Japanese | 7778: Mongolian | 8368: Sindhi | 8482: Turkish |
| 6665: Bashkir | 7073: Finnish | 7473: Yiddish | 7779: Moldavian | 8372: Serbo-Croatian | 8484: Tatar |
| 6669: Byelorussian | 7074: Fiji | 7487: Javanese | 7782: Marathi | 8373: Singhalese | 8487: Twi |
| 6671: Bulgarian | 7079: Faroese | 7565: Georgian | 7783: Malay | 8375: Slovak | 8575: Ukrainian |
| 6672: Bihari | 7082: French | 7575: Kazakh | 7784: Maltese | 8376: Slovenian | 8582: Urdu |
| 6678: Bengali; Bangla | 7089: Frisian | 7576: Greenlandic | 7789: Burmese | 8377: Samoan | 8590: Uzbek |
| 6679: Tibetan | 7165: Irish | 7577: Cambodian | 7865: Nauru | 8378: Shona | 8673: Vietnamese |
| 6682: Breton | 7168: Scots Gaelic | 7578: Kannada | 7869: Nepali | 8379: Somali | 8679: Volapük |
| 6765: Catalan | 7176: Galician | 7579: Korean | 7876: Dutch | 8381: Albanian | 8872: Wolof |
| 6779: Corsican | 7178: Guarani | 7583: Kashmiri | 7879: Norwegian | 8382: Serbian | 8872: Xhosa |
| 6783: Czech | 7185: Gujarati | 7585: Kurdish | 7982: Oriya | 8385: Sundanese | 8979: Yoruba |
| 6789: Welsh | 7265: Hausa | 7589: Kirghiz | 8065: Punjabi | 8386: Swedish | 9072: Chinese |
| 6865: Danish | 7273: Hindi | 7665: Latin | 8076: Polish | 8387: Swahili | 9085: Zulu |
| 6869: German | 7282: Croatian | 7678: Lingala | 8083: Pashto, Pushto | 8465: Tamil | |

SPECIFICATIONS

■ Audio Section

Frequency response

| | |
|------------------------|----------------------|
| DVD (48 kHz sampling): | 2 Hz to 22 kHz |
| DVD (96 kHz sampling): | 2 Hz to 44 kHz |

CD, Video CD: 2 Hz to 20 kHz

Harmonic distortion + noise (1 kHz): 0.002%

S/N ratio: 115 dB (Weighted)

Dynamic range

| | |
|-----------------------|--------------|
| DVD (48 kHz, 24 bit): | 103 dB |
| CD, Video CD: | 99 dB |

Output level (1 kHz, 0 dB): 2±0.3 V

■ Video Section

VIDEO output: 1 Vp-p (75 ohms)

S VIDEO output

| | |
|---------------------------|----------------------------|
| Y output: | 1 Vp-p (75 ohms) |
| C output: | |
| [U.S.A and Canada models] | 0.286 Vp-p (75 ohms) |
| [Other than above models] | 0.3 Vp-p (75 ohms) |

COMPONENT VIDEO output

| | |
|------------------------|--------------------------|
| Y output: | 1 Vp-p (75 ohms) |
| P _B output: | 0.7 Vp-p (75 ohms) |
| P _R output: | 0.7 Vp-p (75 ohms) |

■ General

Power supply:

| | |
|----------------------------|-----------------------------------|
| [U.S.A. and Canada models] | 120 V, 60 Hz |
| [Europe and U.K. models] | 230 V, 50 Hz |
| [Australia model] | 240 V, 50 Hz |
| [General model] | 110/120/220/240 V, 50/60 Hz |

Power consumption: 18W

Laser pickup:

| | |
|---|-------------------------------|
| Wave length | 665nm |
| Laser power | CLASS II |
| Laser output | Max. 1.0mW (Continuous) |
| Output value determined by 21 CFR CHAPTER1, SUBCHAPTER J | |

Dimensions: 435 (W) × 404 (D) × 116 (H) mm

Weight: 6.1 kg

Accessories: RCA pin cable (audio/video)
..... Remote control
..... Batteries (AA, R6, UM-3)

This product incorporates copyright protection technology that is protected by method claims of certain U.S. patents and other intellectual property rights owned by Macrovision Corporation and other rights owners. Use of this copyright protection technology must be authorized by Macrovision Corporation, and is intended for home and other limited viewing uses only unless otherwise authorized by Macrovision Corporation. Reverse engineering or disassembly is prohibited.

CAUTION

Use of controls or adjustments or performance of procedures other than those specified herein may result in hazardous radiation exposure.

ATTENTION

L'emploi de commandes, de réglages ou un choix de procédures différents des spécifications de cette brochure peut entraîner une exposition à d'éventuelles radiations pouvant être dangereuses.

ACHTUNG

Die Verwendung von Bedienungselementen oder Einstellungen oder die Durchführung von Bedienungsvorgängen, die nicht in dieser Anleitung aufgeführt sind, kann zu einem Kontakt mit gefährlichen Laserstrahlen führen.

OBSERVERA

Användning av kontroller och justeringar eller genomförande av procedurer andra än de som specificeras i denna bok kan resultera i att du utsätter dig för farlig strålning.

ATTENZIONE

Uso di controlli o regolazioni o procedure non specificamente descritte può causare l'esposizione a radiazioni di livello pericoloso.

PRECAUCIÓN

El uso de los controles o los procedimientos de ajuste o utilización diferentes de los especificados en este manual pueden causar una exposición peligrosa a la radiación.

VOORZICHTIG

Gebruik van bedieningsorganen of instellingen, of uitvoeren van handelingen anders dan staan beschreven in deze handleiding kunnen leiden tot blootstelling aan gevaarlijke stralen.

VARO!

AVATTAESSA JA SUOJALUKITUS OHITETTAESSA OLET ALTTIINA NÄKYMÄTTÖMÄLLE LASERSÄTEILYLLE. ÄLÄ KATSO SÄTEESEEN.

WARNING!

OSYNLIG LASERSTRÅLNING NÄR DENNA DEL ÄR ÖPPNAD OCH SPÄRREN ÄR URKOPPLAD. BETRAKTA EJ STRÅLEN.

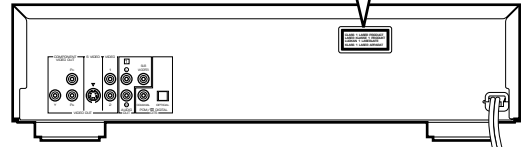
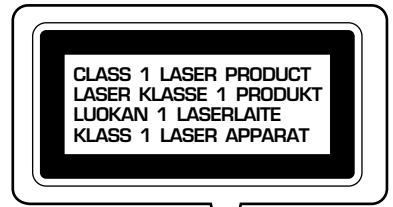

(Except U.S.A. model)

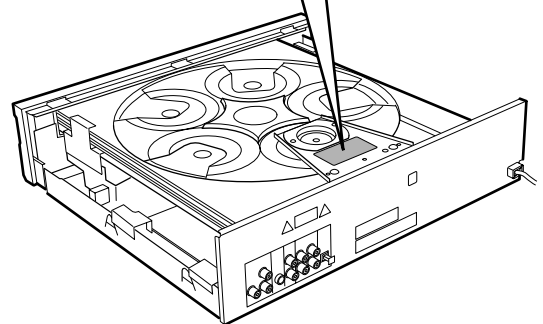
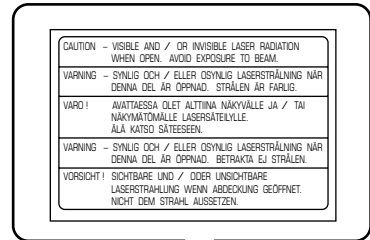



YAMAHA ELECTRONICS CORPORATION, USA 6660 ORANGETHORPE AVE., BUENA PARK, CALIF. 90620, U.S.A.
YAMAHA CANADA MUSIC LTD. 135 MILNER AVE., SCARBOROUGH, ONTARIO M1S 3R1, CANADA
YAMAHA ELECTRONIK EUROPA G.m.b.H. SIEMENSSTR. 22-34, 25462 RELLINGEN BEI HAMBURG, F.R. OF GERMANY
YAMAHA ELECTRONIQUE FRANCE S.A. RUE AMBROISE CROIZAT BP70 CROISSY-BEAUBOURG 77312 MARNE-LA-VALLÉE CEDEX02, FRANCE
YAMAHA ELECTRONICS (UK) LTD. YAMAHA HOUSE, 200 RICKMANSWORTH ROAD WATFORD, HERTS WD1 7JS, ENGLAND
YAMAHA SCANDINAVIA A.B. J A WETTERGRENS GATA 1, BOX 30053, 400 43 VÄSTRA FRÖLUNDA, SWEDEN
YAMAHA MUSIC AUSTRALIA PTY, LTD. 17-33 MARKET ST., SOUTH MELBOURNE, 3205 VIC., AUSTRALIA

YAMAHA CORPORATION
Printed in Malaysia  V624870-1