

# GS1910/XGS1910 Series

*GbE Smart Managed Switch*

## *User's Guide*

### Default Login Details

IP Address	http://192.168.1.1
User Name	admin
Password	1234

Version 1.00  
Edition 1, 05/2012

[www.zyxel.com](http://www.zyxel.com)

The logo for ZyXEL, featuring the brand name in a bold, blue, sans-serif font. The 'Z' and 'Y' are connected, and the 'X' is stylized with a gap in the middle.

---

**IMPORTANT!**

**READ CAREFULLY BEFORE USE.**

**KEEP THIS GUIDE FOR FUTURE REFERENCE.**

Note: This guide is a reference for a series of products. Therefore some features or options in this guide may not be available in your product.

Graphics in this book may differ slightly from the product due to differences in operating systems, operating system versions, or if you installed updated firmware/software for your device. Every effort has been made to ensure that the information in this manual is accurate.

### **Related Documentation**

- Web Configurator Online Help

Click the help icon in any screen for help in configuring that screen and supplementary information.

# Table of Contents

<b>Table of Contents .....</b>	<b>3</b>
<b>Chapter 1</b>	
<b>Getting to Know Your Switch.....</b>	<b>5</b>
1.1 Introduction .....	5
1.1.1 Bridging Example .....	5
1.1.2 High Performance Switching Example .....	6
1.1.3 Gigabit Ethernet to the Desktop .....	7
1.1.4 IEEE 802.1Q VLAN Application Example .....	7
1.1.5 IPv6 Support .....	8
1.2 Ways to Manage the Switch .....	8
1.3 Good Habits for Managing the Switch .....	8
<b>Chapter 2</b>	
<b>Hardware Installation and Connection .....</b>	<b>11</b>
2.1 Freestanding Installation .....	11
2.2 Mounting the Switch on a Rack .....	12
2.2.1 Rack-mounted Installation Requirements .....	12
2.2.2 Attaching the Mounting Brackets to the Switch .....	12
2.2.3 Mounting the Switch on a Rack .....	13
<b>Chapter 3</b>	
<b>Hardware Overview .....</b>	<b>15</b>
3.1 Front Panel Connections .....	15
3.1.1 Ethernet Ports .....	17
3.1.2 Dual Personality Interfaces .....	18
3.1.3 SFP/SFP+ Slots .....	18
3.1.4 Console Port .....	20
3.2 Rear Panel .....	20
3.2.1 Power Connector .....	21
3.3 LEDs .....	22
<b>Chapter 4</b>	
<b>The Web Configurator .....</b>	<b>25</b>
4.1 Introduction .....	25
4.2 System Login .....	25
4.3 The Web Configurator Layout .....	26
4.3.1 Change Your Password .....	32
4.4 Switch Lockout .....	32

4.5 Logging Out of the Web Configurator .....	32
4.6 Help .....	32
<b>Chapter 5</b>	
<b>Tutorials.....</b>	<b>33</b>
5.1 How to Change Switch Management IP Address .....	33
5.2 How to Configure Login Accounts and Privilege Levels .....	34
5.3 How to Manage a Configuration File .....	36
5.3.1 Backing up a Configuration File .....	36
5.3.2 Restoring a Configuration File .....	37
5.4 How to Create a VLAN .....	38
5.4.1 Setting Port VID .....	39
5.5 How to Set Up a Guest VLAN with IEEE 802.1x Authentication .....	41
5.5.1 Creating a VLAN for Port which is not IEEE 802.1x enabled .....	41
5.5.2 Enabling IEEE 802.1x Port Authentication and Guest VLAN .....	42
5.6 How to Use Private VLAN to Do Port Isolation in a VLAN .....	44
5.6.1 Creating a Private VLAN .....	44
5.6.2 Enabling Port Isolation .....	45
5.7 How to Use IP Source Guard and DHCP Snooping to Prevent Spoofed Traffic .....	45
5.8 How to Use DHCP Relay on the Switch .....	48
5.8.1 Creating a VLAN .....	49
5.8.2 Configuring DHCP Relay .....	49
5.8.3 Troubleshooting .....	50
5.9 How to Use Link Aggregation to Group Multiple Ports into One Logical Link .....	50
5.9.1 Static Port Trunking .....	50
5.9.2 Dynamic Port Trunking .....	51
5.10 How to Analyze Traffic Using Mirroring .....	52
5.10.1 Configuring Mirroring .....	53
5.10.2 Configuring Remote Port Mirroring .....	54
5.11 How to Use IGMP Snooping to Reduce Multicast Traffic Passing through your Switch .....	60
5.12 How to Configure Access Control List (ACL) for Packets Filtering .....	63
5.13 How to Reset the Switch via the Console Port .....	66
<b>Chapter 6</b>	
<b>Troubleshooting.....</b>	<b>69</b>
6.1 Power, Hardware Connections, and LEDs .....	69
6.2 Switch Access and Login .....	70
Appendix A Legal Information.....	73
<b>Index .....</b>	<b>75</b>

# Getting to Know Your Switch

This chapter introduces the main features and applications of the Switch.

## 1.1 Introduction

Your Switch is a Gigabit Ethernet (GbE) switch with 20, 44 or 48 10/100/1000 Mbps Ethernet ports. The GS1910-24, GS1910-24HP, XGS1910-24 or XGS1910-48 also has four GbE dual personality interfaces. A dual personality interface includes one Gigabit Ethernet port and one slot for a mini-GBIC transceiver (SFP module) with one port active at a time. The GS1910-48 and GS1910-48HP have four SFP slots.

The Ethernet ports on the GS1910-24HP or GS1910-48HP are all IEEE802.3at High Power over Ethernet (PoE) compliant and can supply power of up to 30W per Ethernet port.

The XGS1910-24 or XGS1910-48 is stackable and provides two or four SFP+ slots for uplink or stacking. They can operate together with other XGS1910-24 or XGS1910-48 switches and need to be directly connected for stacking. The configurations are done on the master switch, which then maintains and manages the slave switches in the stack. You can stack up to eight XGS1910-24 or XGS1910-48 switches per stack.

With its built-in web configurator, managing and configuring the Switch is easy. In addition, the Switch can also be managed via third-party SNMP management.

### 1.1.1 Bridging Example

In this example the Switch connects different company departments (**RD** and **Sales**) to the corporate backbone. It can alleviate bandwidth contention and eliminate server and network bottlenecks. All users that need high bandwidth can connect to high-speed department servers via

the Switch. You can provide a super-fast uplink connection by using the optional 10 Gigabit uplink module on the Switch.

**Figure 1** Bridging Application

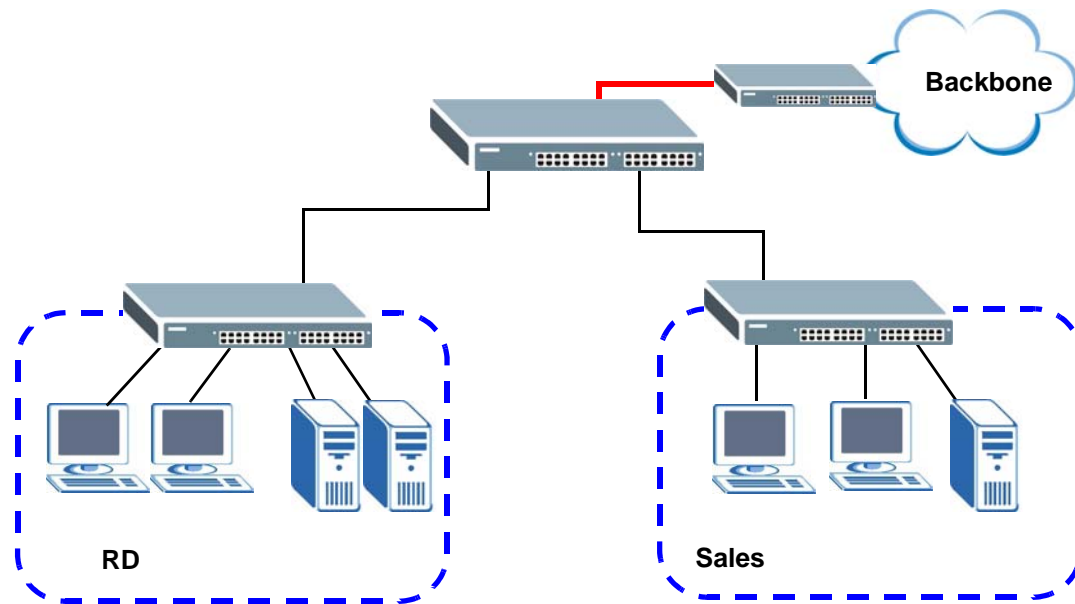

### 1.1.2 High Performance Switching Example

The Switch is ideal for connecting two geographically dispersed networks that need high bandwidth. In the following example, a company uses the optional 10 Gigabit uplink modules to connect the headquarters to a branch office network. Within the headquarters network, a company can use trunking to group several physical ports into one logical higher-capacity link. Trunking can be used if for example, it is cheaper to use multiple lower-speed links than to under-utilize a high-speed, but more costly, single-port link.

**Figure 2** High Performance Switching

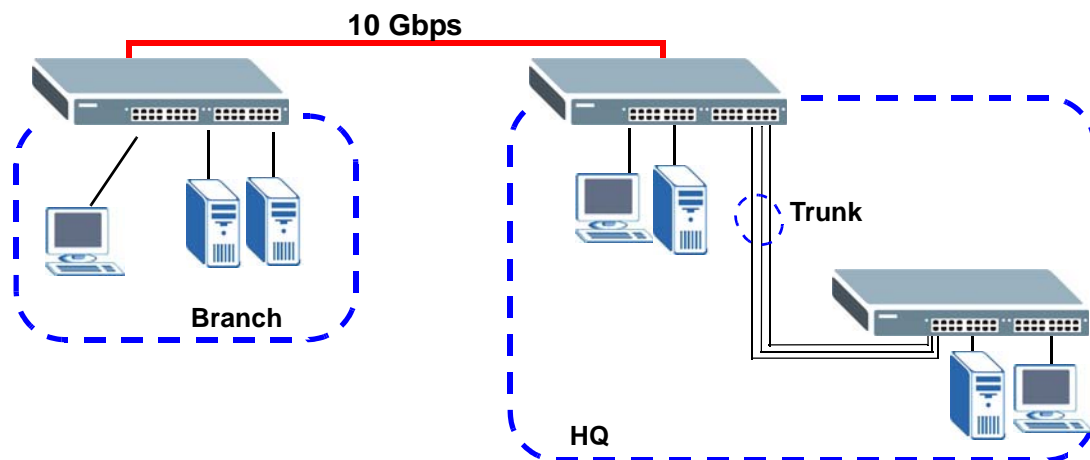

### 1.1.3 Gigabit Ethernet to the Desktop

The Switch is an ideal solution for small networks which demand high bandwidth for a group of heavy traffic users. You can connect computers and servers directly to the Switch's port or connect other switches to the Switch. Use the optional 10 Gigabit uplink module to provide high speed access to a data server and the Internet. The uplink module supports a fiber-optic connection which alleviates the distance limitations of copper cabling.

In this example, all computers can share high-speed applications on the server and access the Internet. To expand the network, simply add more networking devices such as switches, routers, computers, print servers and so on.

**Figure 3** Gigabit to the Desktop

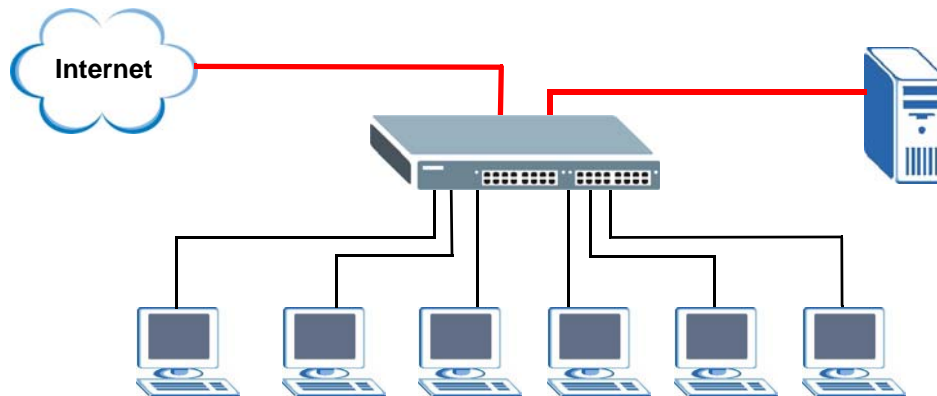

### 1.1.4 IEEE 802.1Q VLAN Application Example

A VLAN (Virtual Local Area Network) allows a physical network to be partitioned into multiple logical networks. Stations on a logical network belong to one or more groups. With VLAN, a station cannot directly talk to or hear from stations that are not in the same group(s) unless such traffic first goes through a router.

For more information on VLANs, refer to [Chapter 9 on page 111](#).

#### 1.1.4.1 Tag-based VLAN Example

Ports in the same VLAN group share the same frame broadcast domain, thus increasing network performance by reducing broadcast traffic. VLAN groups can be modified at any time by adding, moving or changing ports without any re-cabling.

Shared resources such as a server can be used by all ports in the same VLAN as the server. In the following figure only ports that need access to the server need to be part of VLAN 1. Ports can belong to other VLAN groups too.

**Figure 4** Shared Server Using VLAN Example

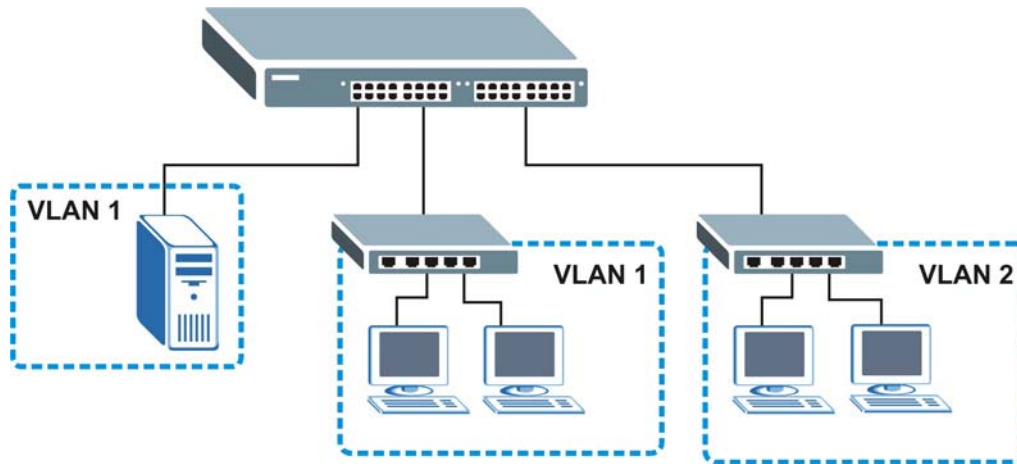

### 1.1.5 IPv6 Support

IPv6 (Internet Protocol version 6), is designed to enhance IP address size and features. The increase in IPv6 address size to 128 bits (from the 32-bit IPv4 address) allows up to  $3.4 \times 10^{38}$  IP addresses. At the time of writing, the Switch supports the following features.

- Static address assignment and stateless auto-configuration
- Neighbor Discovery Protocol (a protocol used to discover other IPv6 devices in a network)
- Remote Management using ping SNMP, telnet and HTTP services
- ICMPv6 to report errors encountered in packet processing and perform diagnostic functions, such as "ping"
- IPv4/IPv6 dual stack; the Switch can run IPv4 and IPv6 at the same time
- Multicast Listener Discovery (MLD) snooping and proxy

## 1.2 Ways to Manage the Switch

Use any of the following methods to manage the Switch.

- Web Configurator. This is recommended for everyday management of the Switch using a (supported) web browser.
- SNMP. The device can be monitored and/or managed by an SNMP manager.

## 1.3 Good Habits for Managing the Switch

Do the following things regularly to make the Switch more secure and to manage the Switch more effectively.

- Change the password. Use a password that's not easy to guess and that consists of different types of characters, such as numbers and letters.
- Write down the password and put it in a safe place.
- Back up the configuration (and make sure you know how to restore it). Restoring an earlier working configuration may be useful if the device becomes unstable or even crashes. If you forget your password, you will have to reset the Switch to its factory default settings. If you backed up an earlier configuration file, you would not have to totally re-configure the Switch. You could simply restore your last configuration.



# Hardware Installation and Connection

This chapter shows you how to install and connect the Switch.

## 2.1 Freestanding Installation

- 1 Make sure the Switch is clean and dry.
- 2 Set the Switch on a smooth, level surface strong enough to support the weight of the Switch and the connected cables. Make sure there is a power outlet nearby.
- 3 Make sure there is enough clearance around the Switch to allow air circulation and the attachment of cables and the power cord.
- 4 Remove the adhesive backing from the rubber feet.
- 5 Attach the rubber feet to each corner on the bottom of the Switch. These rubber feet help protect the Switch from shock or vibration and ensure space between devices when stacking.

**Figure 5** Attaching Rubber Feet

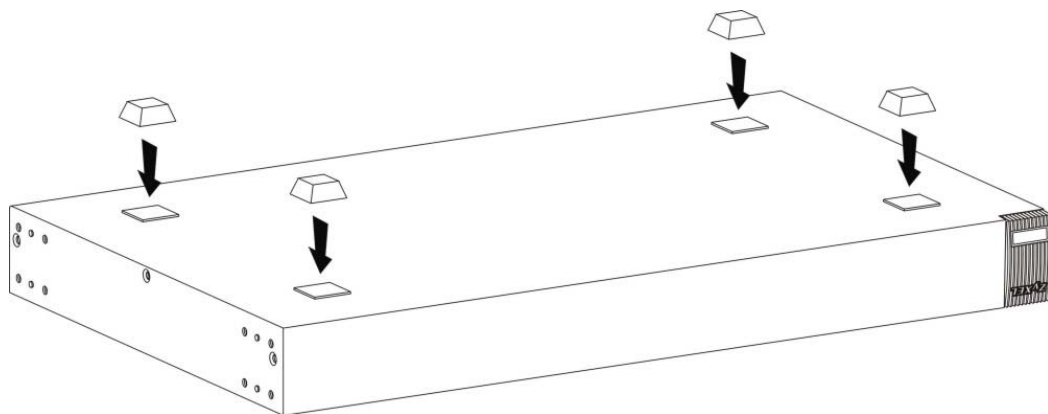

Note: Do NOT block the ventilation holes. Leave space between devices when stacking.

Note: For proper ventilation, allow at least 4 inches (10 cm) of clearance at the front and 3.4 inches (8 cm) at the back of the Switch. This is especially important for enclosed rack installations.

## 2.2 Mounting the Switch on a Rack

This section lists the rack mounting requirements and precautions and describes the installation steps.

### 2.2.1 Rack-mounted Installation Requirements

- Two mounting brackets.
- Eight M3 flat head screws and a #2 Philips screwdriver.
- Four M5 flat head screws and a #2 Philips screwdriver.

**Failure to use the proper screws may damage the unit.**

#### 2.2.1.1 Precautions

- Make sure the rack will safely support the combined weight of all the equipment it contains.
- Make sure the position of the Switch does not make the rack unstable or top-heavy. Take all necessary precautions to anchor the rack securely before installing the unit.

### 2.2.2 Attaching the Mounting Brackets to the Switch

- 1 Position a mounting bracket on one side of the Switch, lining up the four screw holes on the bracket with the screw holes on the side of the Switch.

**Figure 6** Attaching the Mounting Brackets

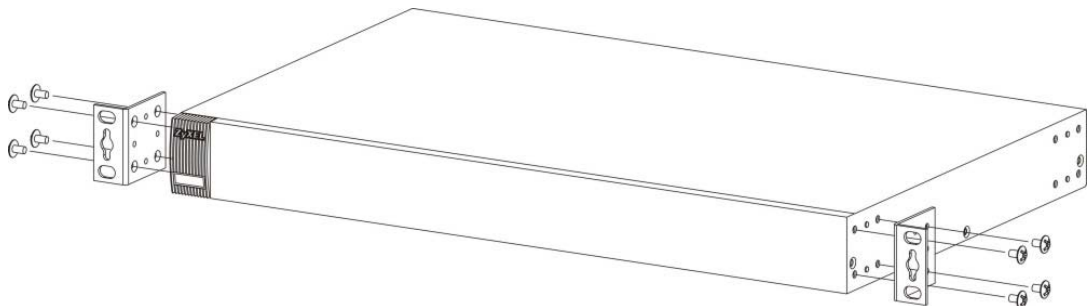

- 2 Using a #2 Philips screwdriver, install the M3 flat head screws through the mounting bracket holes into the Switch.
- 3 Repeat steps 1 and 2 to install the second mounting bracket on the other side of the Switch.
- 4 You may now mount the Switch on a rack. Proceed to the next section.

### 2.2.3 Mounting the Switch on a Rack

- 1 Position a mounting bracket (that is already attached to the Switch) on one side of the rack, lining up the two screw holes on the bracket with the screw holes on the side of the rack.

**Figure 7** Mounting the Switch on a Rack

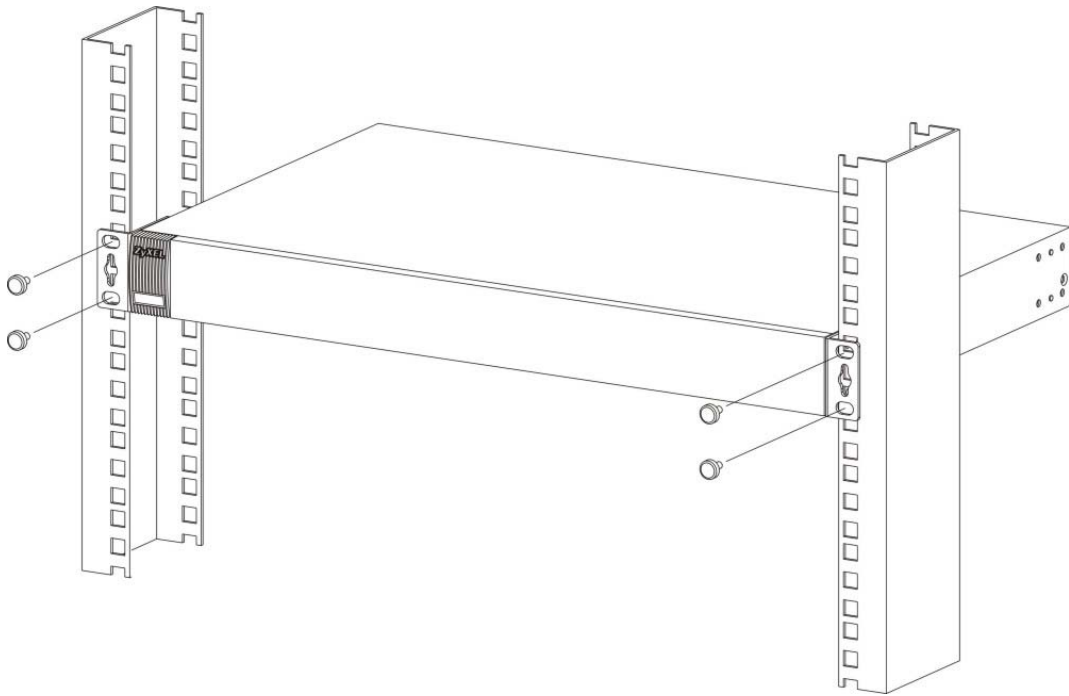

- 2 Using a #2 Philips screwdriver, install the M5 flat head screws through the mounting bracket holes into the rack.
- 3 Repeat steps 1 and 2 to attach the second mounting bracket on the other side of the rack.



# Hardware Overview

This chapter describes the front panel and rear panel of the Switch and shows you how to make the hardware connections.

## 3.1 Front Panel Connections

The figure below shows the front panel of the Switch.

**Figure 8** Front Panel: GS1910-24

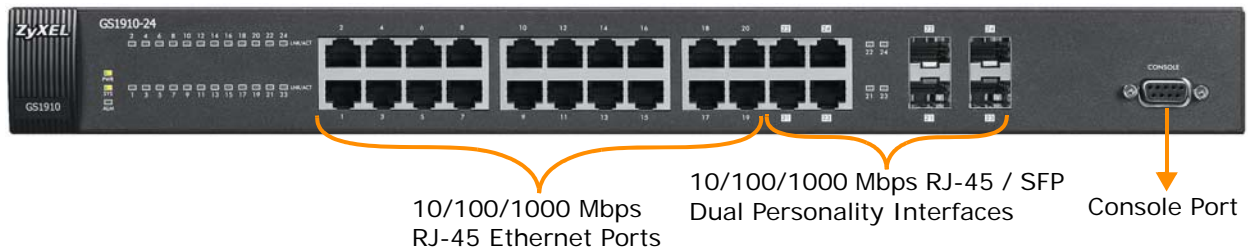

**Figure 9** Front Panel: GS1910-24HP

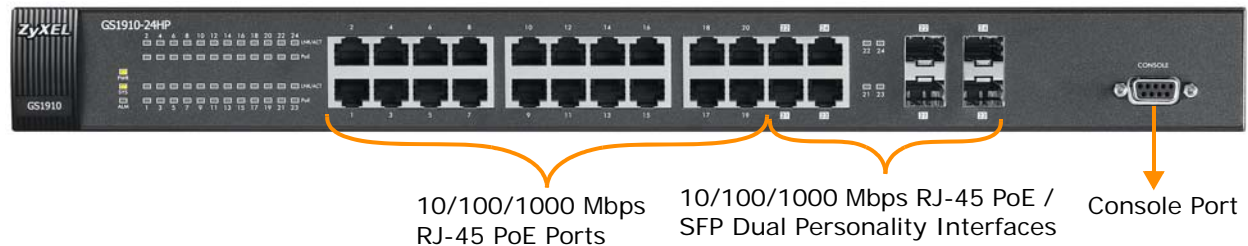

**Figure 10** Front Panel: GS1910-48

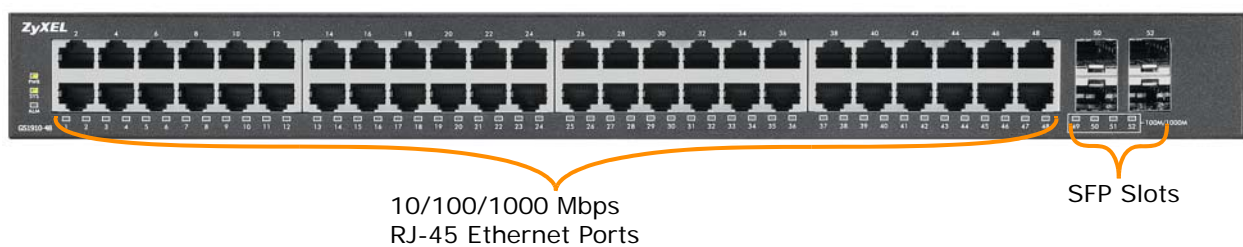

**Figure 11** Front Panel: GS1910-48HP

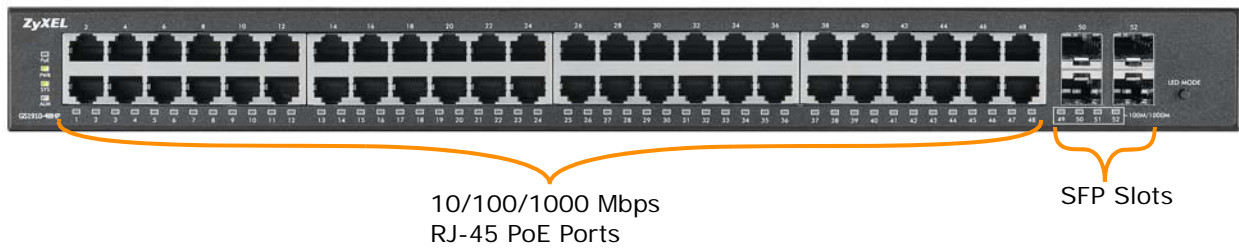

**Figure 12** Front Panel: XGS1910-24

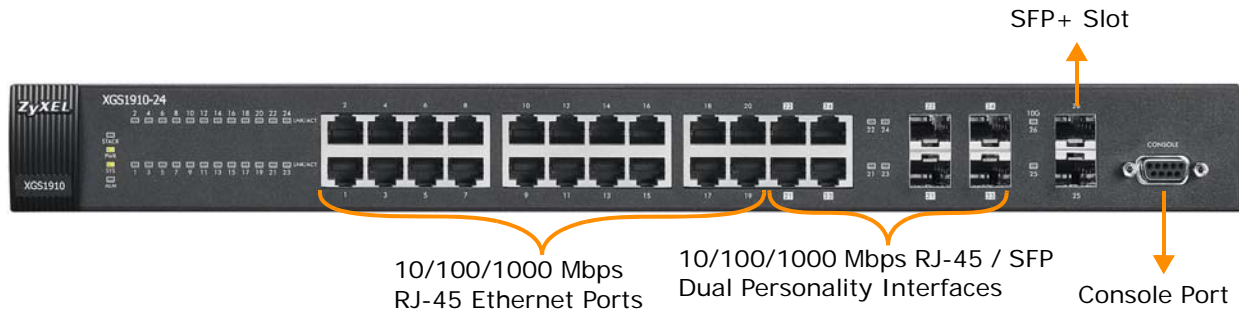

**Figure 13** Front Panel: XGS1910-48

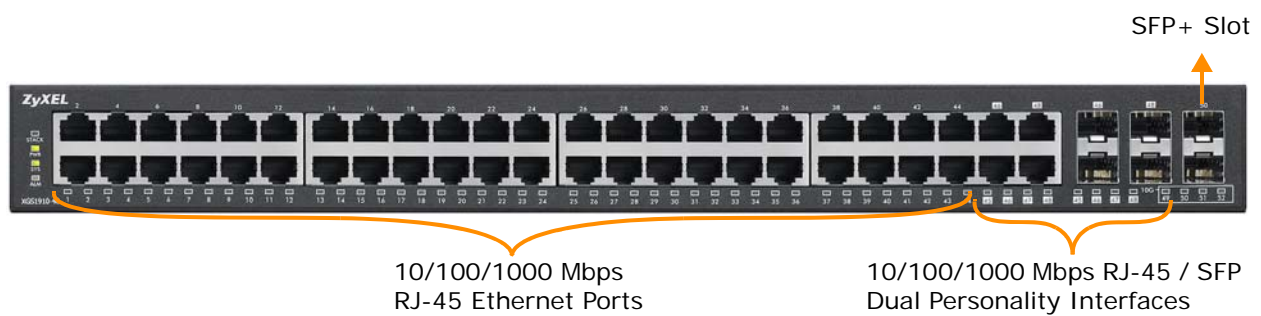

The following table describes the ports.

**Table 1** Panel Connections

CONNECTOR	DESCRIPTION
10/100/1000 Mbps RJ-45 Ethernet Ports	Connect these ports to a computer, a hub, an Ethernet switch or router.
10/100/1000 Mbps RJ-45 PoE Ports (GS1910-24HP and GS1910-48HP only)	Connect these ports to a computer, a hub, an Ethernet switch or router.

**Table 1** Panel Connections (continued)

CONNECTOR	DESCRIPTION
Dual Personality Interfaces	<p>Each interface has one 10/100/1000Base-T RJ-45 port and one Small Form-Factor Pluggable (SFP) slot (also called a mini-GBIC (Gigabit Interface Converter) slot), with one port active at a time.</p> <ul style="list-style-type: none"> <li>10/100/1000Base-T Ports or 10/100/1000Base-T PoE Ports (GS1910-24HP and GS1910-48HP only): Connect these ports to high-bandwidth backbone network Ethernet switches using Category 5/5e/6 1000Base-T Ethernet cables. Use an 8-wire Ethernet cable for Gigabit connections. Using a 4-wire Ethernet cable limits your connection to 100 Mbps. Note that the connection speed also depends on what the Ethernet device at the other end can support.</li> <li>SFP Slots: Use SFP transceivers in these ports for 1000Base-X fiber-optic connections to backbone Ethernet switches.</li> </ul>
SFP Slots (GS1910-48 and GS1910-48HP only)	Use SFP transceivers in these slots for fiber-optic or copper connections to backbone Ethernet switches.
SFP+ Slots (XGS1910-24 and XGS1910-48 only)	Use SFP+ transceivers in these slots for fiber-optic connections to backbone Ethernet switches.
Console Port	At the time of writing, this port is reserved for future use, such as firmware upgrade using an RS-232 cable.

## 3.1.1 Ethernet Ports

The Switch has 1000Base-T auto-negotiating, auto-crossover Ethernet ports. In 10/100/1000 Mbps Gigabit Ethernet, the speed can be 10Mbps, 100 Mbps or 1000 Mbps. The duplex mode can be both half or full duplex at 100 Mbps and full duplex only at 1000 Mbps.

An auto-negotiating port can detect and adjust to the optimum Ethernet speed (10/100/1000 Mbps) and duplex mode (full duplex or half duplex) of the connected device.

An auto-crossover (auto-MDI/MDI-X) port automatically works with a straight-through or crossover Ethernet cable.

### 3.1.1.1 Default Ethernet Settings

The factory default negotiation settings for the Ethernet ports on the Switch are:

- Speed: Auto
- Duplex: Auto
- Flow control: Off
- Dual Personality Interface: Fiber-optic module first

## 3.1.2 Dual Personality Interfaces

There are four dual personality interfaces, comprising four 1000Base-T/SFP combo ports. For each interface you can connect either to the 1000Base-T port or the SFP slot. If an SFP transceiver is inserted in the SFP slot, the corresponding 1000Base-T port will be disabled.

Note: Connect the 1000Base-T RJ-45 port only after the transceiver is removed from the corresponding SFP slot.

## 3.1.3 SFP/SFP+ Slots

These are slots for Small Form-Factor Pluggable (SFP) or SFP+ transceivers. The SFP is also referred to as a mini-GBIC. The SFP+ (SFP Plus) is an enhanced version of the SFP and supports data rates of 10 Gbps. A transceiver is a single unit that houses a transmitter and a receiver. Use a transceiver to connect a fiber-optic cable to the Switch. The Switch does not come with transceivers. You must use transceivers that comply with the Small Form-Factor Pluggable (SFP) Transceiver MultiSource Agreement (MSA). See the SFF committee's INF-8074i specification Rev 1.0 for details.

You can change transceivers while the Switch is operating. You can use different transceivers to connect to Ethernet switches with different types of fiber-optic connectors.

- Type: SFP connection interface
- Connection speed: 1 Gigabit per second (Gbps) or 10 Gigabit per second (Gbps)

**To avoid possible eye injury, do not look into an operating fiber-optic module's connectors.**

### 3.1.3.1 Transceiver Installation

Use the following steps to install a transceiver (SFP or SFP+ module).

- 1 Insert the transceiver into the slot with the exposed section of PCB board facing down.

**Figure 14** Transceiver Installation Example

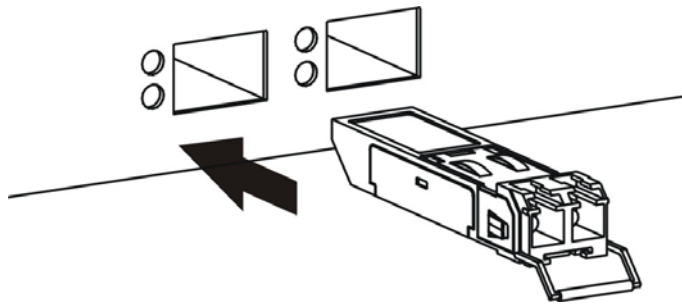

- 2 Press the transceiver firmly until it clicks into place.
- 3 The Switch automatically detects the installed transceiver. Check the LEDs to verify that it is functioning properly.

**Figure 15** Installed Transceiver

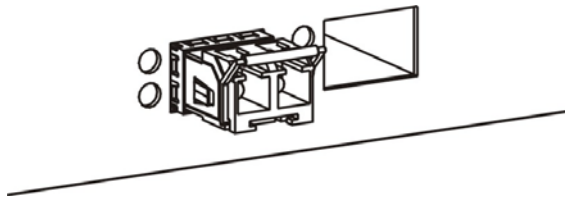

### 3.1.3.2 Transceiver Removal

Use the following steps to remove a transceiver (SFP or SFP+ module).

- 1 Open the transceiver's latch (latch styles vary).

**Figure 16** Opening the Transceiver's Latch Example

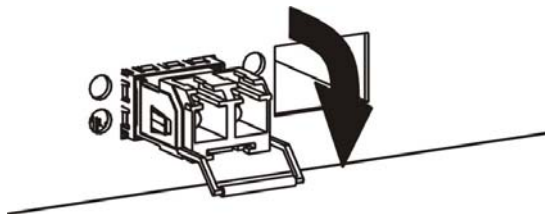

- 2 Pull the transceiver out of the slot.

**Figure 17** Transceiver Removal Example

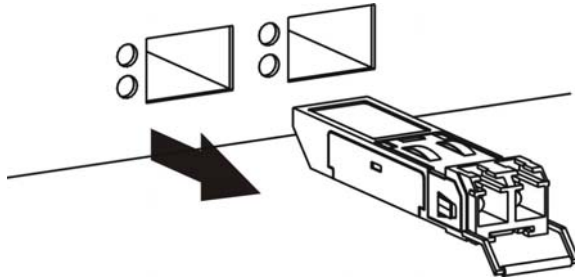

### 3.1.4 Console Port

For local management, you can use a computer with terminal emulation software configured to the following parameters:

- VT100 terminal emulation
- 115200 bps
- No parity, 8 data bits, 1 stop bit
- No flow control

Connect the male 9-pin end of the RS-232 console cable to the console port of the Switch. Connect the female end to a serial port (COM1, COM2 or other COM port) of your computer.

## 3.2 Rear Panel

The following figure shows the rear panel of the Switch. The rear panel contains a connector for the power receptacle. The GS1910-48 and GS1910-48HP also have a console port on the rear panel. The XGS1910-48 has one console port and two SFP+ slots on the rear panel.

**Figure 18** Rear Panel: GS1910-24



**Figure 19** Rear Panel: GS1910-24HP**Figure 20** Front Panel: GS1910-48**Figure 21** Front Panel: GS1910-48HP**Figure 22** Front Panel: XGS1910-24**Figure 23** Front Panel: XGS1910-48

### 3.2.1 Power Connector

Make sure you are using the correct power source as shown on the panel and that no objects obstruct the airflow of the fans.

Use the following procedures to connect the Switch to a power source after you have installed it.

- 1 Connect the female end of the power cord to the power socket of your Switch.
- 2 Connect the other end of the cord to a power outlet.

**Keep the power supply switch and the Switch's power switch in the OFF position until you come to the procedure for turning on the power.**

Note: Use only power wires of the required diameter for connecting the Switch to a power supply.

## 3.3 LEDs

The following table describes the LEDs.

**Table 2** LEDs

LED	COLOR	STATUS	DESCRIPTION
PoE (GS1910-48HP only)	Green	On	Each Ethernet port's LED is changed to act as a PoE LED by using the <b>LED MODE</b> button on the front panel.
		Off	Each Ethernet port's LED is changed back to act as a LNK/ACT LED by using the <b>LED MODE</b> button on the front panel.
STACK (XGS1910-24 and XGS1910-48 only)	Green	On	The Switch is acting as the master in stacking.
	Amber	On	The Switch is acting as the backup master device in stacking.
		Blinking	The Switch is acting as a slave member in stacking and is being selected by the master in its web configurator stack screen.
		Off	The Switch is not working in stacking mode.
PWR	Green	On	The system is turned on.
		Off	The system is off.
SYS	Green	Blinking	The system is rebooting and performing self-diagnostic tests.
		On	The system is on and functioning properly.
		Off	The power is off or the system is not ready/malfunctioning.
ALM	Red	On	There is a hardware failure.
		Off	The system is functioning normally.
10/100/1000 Mbps RJ-45 Ports			
LNK/ACT	Green	Blinking	The system is transmitting/receiving to/from a 10/1000 Mbps Ethernet network.
		On	The link to a 10/1000 Mbps Ethernet network is up.
	Amber	Blinking	The system is transmitting/receiving to/from a 100 Mbps Ethernet network.
		On	The link to a 100 Mbps Ethernet network is up.
		Off	The link to an Ethernet network is down.
PoE (GS1910-24HP and GS1910-48HP only)	Green	On	Power supplied to all PoE Ethernet ports meets the IEEE 802.3at standard.
	Amber	On	Power supplied to all PoE Ethernet ports meets the IEEE 802.3af standard.
		Off	There is no power supplied.
SFP Slots			

**Table 2** LEDs (continued)

LED	COLOR	STATUS	DESCRIPTION
LNK/ACT	Green	Blinking	The system is transmitting/receiving to/from a 1000 Mbps Ethernet network.
		On	The link to a 1000 Mbps Ethernet network is up.
	Amber	Blinking	The system is transmitting/receiving to/from a 100 Mbps Ethernet network.
		On	The link to a 100 Mbps Ethernet network is up.
		Off	The link to an Ethernet network is down.
10G SFP+ Slots			
LNK/ACT	Blue	On	The port has a successful connection.
		Blinking	The port is receiving or transmitting data.
		Off	This link is disconnected.



# The Web Configurator

This section introduces the configuration and functions of the web configurator.

## 4.1 Introduction

The web configurator is an HTML-based management interface that allows easy Switch setup and management via Internet browser. Use Internet Explorer 7.0 and later or Firefox 10.0 and later versions. The recommended screen resolution is 1024 by 768 pixels.

In order to use the web configurator you need to allow:

- Web browser pop-up windows from your device. Web pop-up blocking is enabled by default in Windows XP SP (Service Pack) 2.
- JavaScript (enabled by default).
- Java permissions (enabled by default).

## 4.2 System Login

- 1 Start your web browser.
- 2 Type "http://" and the IP address of the Switch (for example, the default management IP address is 192.168.1.1) in the Location or Address field. Press [ENTER].

- The login screen appears. The default username is **admin** and associated default password is **1234**.

**Figure 24** Web Configurator: Login



- Click **OK** to view the first web configurator screen.

## 4.3 The Web Configurator Layout

The **Port State Overview** screen is the first screen that displays when you access the web configurator.

The following figure shows the navigating components of a web configurator screen.

**Figure 25** The Web Configurator Layout

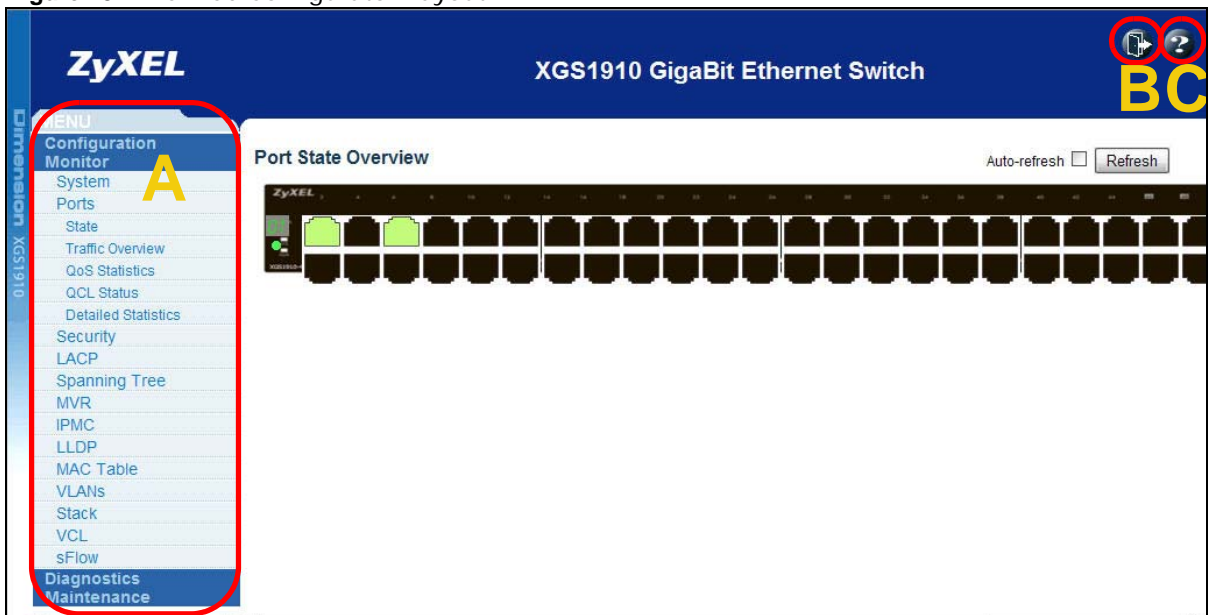

**A** - Click the menu items to open submenu links, and then click on a submenu link to open the screen in the main window.

**B, C** - These are quick links which allow you to perform certain tasks no matter which screen you are currently working in.

**B** - Click this link to log out of the web configurator.

**C** - Click this link to display web help pages. The help pages provide descriptions for all of the configuration screens.

In the navigation panel, click a main link to reveal a list of submenu links.

**Table 3** Navigation Panel Sub-links Overview

CONFIGURATION	MONITOR	DIAGNOSTICS	MAINTENANCE

The following table describes the links in the navigation panel.

**Table 4** Navigation Panel Links

LINK	DESCRIPTION
Configuration	
System	
Information	This link takes you to a screen where you can configure general identification information and time settings for the Switch.
IP	This link takes you to a screen where you can configure the IPv4 address, subnet mask (necessary for Switch management) and DNS (domain name server) settings.
IPv6	This link takes you to a screen where you can configure the Switch's IPv6 address and prefix length.
NTP	This link takes you to a screen where you can configure the NTP time servers from which the Switch gets the time and date.
Log	This link takes you to screens where you can setup a system log server.
Power Reduction	
EEE	This link takes you to a screen where you can enable EEE (Energy Efficient Ethernet) standard on a port to help reduce power consumption.

**Table 4** Navigation Panel Links (continued)

LINK	DESCRIPTION
Ports	This link takes you to a screen where you can configure speed, flow control, the maximum frame size and power control settings for individual Switch ports.
Security	
Switch	This link takes you to screens where you can change the system login password, manage the privilege levels for login accounts, and configure SNMP, remote management and RMON (Remote Network Monitor).
Network	This link takes you to screens where you can set the maximum number of MAC addresses to learn on a port, configure IEEE 802.1x port authentication as well as MAC authentication for clients communicating via the Switch, configure the access control list, DHCP snooping, DHCP relay, IP source guard and ARP inspection settings.
AAA	This link takes you to a screen where you can configure authentication and accounting services via external servers. The external servers can be either RADIUS (Remote Authentication Dial-In User Service) or TACACS+ (Terminal Access Controller Access-Control System Plus).
Aggregation	
Static	This link takes you to a screen where you can logically aggregate physical links to form one logical, higher-bandwidth link.
LACP	This link takes you to a screen where you can configure dynamic link aggregation.
Spanning Tree	
Bridge Settings	This link takes you to a screen where you can activate one of the STP modes and configure the STP settings on the Switch.
MSTI Mapping	This link takes you to a screen where you can configure the MSTI (Multiple Spanning Tree Instance) to VLAN mapping settings.
MSTI Priorities	This link takes you to a screen where you can configure MSTI priority settings.
CIST Ports	This link takes you to a screen where you can configure CIST (Common and Internal Spanning Tree) ports.
MSTI Ports	This link takes you to a screen where you can configure MSTI ports.
MVR	This link takes you to a screen where you can create multicast VLANs and select the receiver port(s) and a source port for each multicast VLAN.
IPMAC	
IGMP Snooping	This link takes you to screens where you can configure IGMP snooping.
MLD Snooping	This link takes you to screens where you can configure MLD snooping.
LLDP	
LLDP	This link takes you to a screen where you can configure LLDP (Link Layer Discovery Protocol) on the Switch. LLDP allows a network device to advertise its identity and capabilities on the local network. It also allows the device to maintain and store information from adjacent devices which are directly connected to the network device.
LLDP-MED	This link takes you to a screen where you can configure Link Layer Discovery Protocol-Media Endpoint Discovery (LLDP- MED) for multimedia devices and IP Phones.
MAC Table	This link takes you to a screen where you can view the MAC address and VLAN ID of a device attached to a port. You can also view what kind of MAC address it is.
VLANs	
VLAN Membership	This link takes you to a screen where you can configure and view 802.1Q VLAN parameters for the Switch.
Ports	This link takes you to a screen where you can configure the static VLAN (IEEE 802.1Q) settings on a port.
Private VLANs	

**Table 4** Navigation Panel Links (continued)

LINK	DESCRIPTION
PVLAN Membership	This link takes you to a screen where you can create private VLANs on the Switch. This screen is not available on the XGS1910-24 or XGS1910-48.
Port Isolation	This link takes you to a screen where you can enable port isolation on ports in a private VLAN or IEEE 802.1Q tagged VLAN to prevent communication between ports in the same VLAN.
VCL	
MAC-based VLAN	This link takes you to a screen where you can configure a MAC-based VLAN.
Protocol-based VLAN	This link takes you to a screen where you can configure a protocol-based VLAN.
Voice VLAN	
Configuration	This link takes you to a screen where you can configure a Voice VLAN for voice traffic.
OUI	This link takes you to a screen where you can configure an Organizationally Unique Identifier (OUI) address table that can be used for telephony devices detecting.
QoS	
Port Classification	This link takes you to a screen where you can configure QoS classification settings for incoming traffic on a port.
Port Policing	This link takes you to a screen where you can configure QoS policers that allow you to limit the transmission rate of incoming traffic on a port.
Port Scheduler	This link takes you to a screen where you can configure QoS queues for outgoing traffic on a port.
Port Shaping	This link takes you to a screen where you can configure traffic shaping for a queue and a port.
Port Tag Remarking	This link takes you to a screen where you can configure how the Switch sets the priority level and drop eligible indicator field in the VLAN tag for traffic on an egress port.
Port DSCP	This link takes you to a screen where you can configure whether and how the Switch modifies the DSCP value for traffic on a port.
DSCP-Based QoS	This link takes you to a screen where you can configure the DSCP to QoS class and drop precedence level mapping for all incoming traffic.
DSCP Translation	This link takes you to a screen where you can configure the DSCP translation/mapping table for incoming and/or outgoing traffic.
DSCP Classification	This link takes you to a screen where you can configure the DSCP to QoS class mapping table.
QoS Control List	This link takes you to a screen where you can configure a QoS control list to classify and give different drop precedence levels and DSCP numbers to different packet types.
Storm Control	This link takes you to a screen where you can limit the number of unicast, broadcast and unknown packets the Switch receives per second on the ports.
WRED	This link takes you to a screen where you can configure the weighted Random Early Detection (RED) settings for QoS queues 0 to 5.
Port Mirroring	This link takes you to a screen where you can copy traffic from one port or ports to another port in order that you can examine the traffic from the first port without interference.
UPnP	This link takes you to a screen to enable UPnP.
Stack	This link takes you to a screen to enable stacking and manage other members in the stack.
sFlow	This link takes you to a screen where you can configure an sFlow receiver (collector) and sFlow data sampling settings on the Switch.
Monitor	

**Table 4** Navigation Panel Links (continued)

LINK	DESCRIPTION
System	
Information	This link takes you to a screen that displays general system information.
CPU Load	This link takes you to a screen that displays what percentage of the Switch's processing ability is currently used.
Log	This link takes you to a screen that displays view system logs for the level that you selected.
Detailed Log	This link takes you to a screen that displays an individual log.
HW monitor	This link takes you to a screen that displays hardware monitoring information.
Ports	
State	This link takes you to a screen where you can view the status of the Switch connections.
Traffic Overview	This link takes you to a screen where you can view the port statistics.
QoS Statistics	This link takes you to a screen where you can view the Switch's QoS-related packet statistics.
QCL Status	This link takes you to a screen where you can view the QoS control list status.
Detailed Statistics	This link takes you to a screen where you can check detailed performance data about an individual port on the Switch.
Security	
Access Management Statistics	This link takes you to a screen where you can view the packet statistics for access control.
Network	This link takes you to a screen where you can view the status and settings of port security, port authentication, access control list, DHCP snooping, DHCP relay, IP source guard and ARP inspection.
AAA	This link takes you to a screen where you can view the status and statistics for authentication and accounting servers.
Switch	This link takes you to a screen where you can view the settings or traffic statistics of RMON groups which contain detailed information about specific activities.
LACP	
System Status	This link takes you to a screen where you can view the Switch's link aggregation status.
Port Status	This link takes you to a screen where you can view the LACP settings on a port.
Port Statistics	This link takes you to a screen where you can view LACP statistics on a port.
Spanning Tree	
Bridge Status	This link takes you to a screen where you can view the status of STP bridge instances.
Port Status	This link takes you to a screen where you can view STP port role and port state.
Port Statistics	This link takes you to a screen where you can view STP packet statistics on a port.
MVR	
Statistics	This link takes you to a screen where you can view Multicast VLAN Registration (MVR) statistics.
MVR Channel Groups	This link takes you to a screen where you can view MVR channels (groups) information.
MVR SFM Information	This link takes you to a screen where you can view MVR SFM (Source-Filtered Multicast) information.
IPMC	
IGMP Snooping	This link takes you to a screen where you can view IGMP snooping status, IGMP group information and SFM (Source-Filtered Multicast) information.

**Table 4** Navigation Panel Links (continued)

LINK	DESCRIPTION
MLD Snooping	This link takes you to a screen where you can view MLD snooping status, MLD group information and SFM (Source-Filtered Multicast) information..
LLDP	
Neighbours	This link takes you to a screen where you can view the LLDP neighboring device information.
LLDP-MED Neighbours	This link takes you to a screen where you can view the LLDP-MED neighboring device information.
EEE	This link takes you to a screen where you can view the EEE information exchanged via LLDP.
Port Statistics	This link takes you to a screen where you can view LLDP traffic statistics on the Switch or on a port.
MAC Table	This link takes you to a screen where you can view the MAC address and VLAN ID of a device attached to a port. You can also view what kind of MAC address it is.
VLANs	
VLAN Membership	This link takes you to a screen where you can view status of the VLAN group.
VLAN Port	This link takes you to a screen where you can view detailed VLAN settings on a port.
Stack	This link takes you to a screen where you can see whether stacking is enabled on the Switch.
VCL	
MAC-based VLAN	This link takes you to a screen where you can view the MAC-based VLAN settings.
sFlow	
sFlow Statistics	This link takes you to a screen where you can view sFlow receiver state and sFlow packet statistics on each port.
Diagnostic	
Ping	This link takes you to a screen where you can ping IPv4 addresses to test connections.
Ping6	This link takes you to a screen where you can ping IPv6 addresses to test connections.
VeriPHY	This link takes you to a screen where you can perform a physical wire-pair test of the Ethernet connections on the specified port(s).  VeriPHY® cable diagnostics provide extensive network cable information such as cable length, termination status, and open/short fault location.
Maintenance	
Restart Device	This link takes you to a screen where you can reboot the system without turning the power off.
Factory Defaults	This link takes you to a screen where you can to reset the Switch back to the factory defaults.
Software	
Upload	This link takes you to a screen where you can upload firmware to the Switch.
Image Select	This link takes you to a screen where you can switch to use a second firmware image if available.  This screen is not available on the XGS1910-24 or XGS1910-48.
Configuration	
Backup	This link takes you to a screen where you can back up your current Switch configuration to a computer.
Upload	This link takes you to a screen where you can restore a previously saved configuration from your computer to the Switch.

### 4.3.1 Change Your Password

After you log in for the first time, it is recommended you change the default administrator password. Click **Configuration > Security > Switch > Users** to display the next screen.

**Figure 26** Change Administrator Login Password

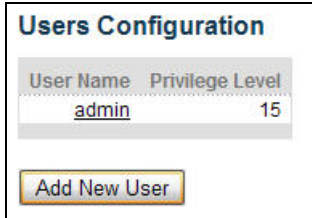

## 4.4 Switch Lockout

You could block yourself (and all others) from using in-band-management (managing through the data ports) if you do one of the following:

- 1 Delete the management VLAN (default is VLAN 1).
- 2 Disable all ports.
- 3 Misconfigure the text configuration file.
- 4 Forget the password and/or IP address.
- 5 Prevent all services from accessing the Switch.
- 6 Change a service port number but forget it.

Note: Be careful not to lock yourself and others out of the Switch.

## 4.5 Logging Out of the Web Configurator

Click **Logout** in a screen to exit the web configurator. You have to log in with your password again after you log out. This is recommended after you finish a management session for security reasons.

## 4.6 Help

The web configurator's online help has descriptions of individual screens and some supplementary information.

Click the **Help** link from a web configurator screen to view an online help description of that screen.

## Tutorials

This chapter provides some examples of using the Web Configurator to set up and use the Switch. The tutorials include:

- [How to Change Switch Management IP Address](#)
- [How to Configure Login Accounts and Privilege Levels](#)
- [How to Manage a Configuration File](#)
- [How to Create a VLAN](#)
- [How to Set Up a Guest VLAN with IEEE 802.1x Authentication](#)
- [How to Use Private VLAN to Do Port Isolation in a VLAN](#)
- [How to Use IP Source Guard and DHCP Snooping to Prevent Spoofed Traffic](#)
- [How to Use DHCP Relay on the Switch](#)
- [How to Use Link Aggregation to Group Multiple Ports into One Logical Link](#)
- [How to Analyze Traffic Using Mirroring](#)
- [How to Use IGMP Snooping to Reduce Multicast Traffic Passing through your Switch](#)
- [How to Configure Access Control List \(ACL\) for Packets Filtering](#)
- [How to Reset the Switch via the Console Port](#)

### 5.1 How to Change Switch Management IP Address

The default management IP address of the Switch is 192.168.1.1. You can configure the IP address to be in the same subnet as your network or have the Switch obtain a dynamic IP address from a DHCP server in your network. The following figure shows an example.

**Figure 27** Initial Setup Example: Management IP Address

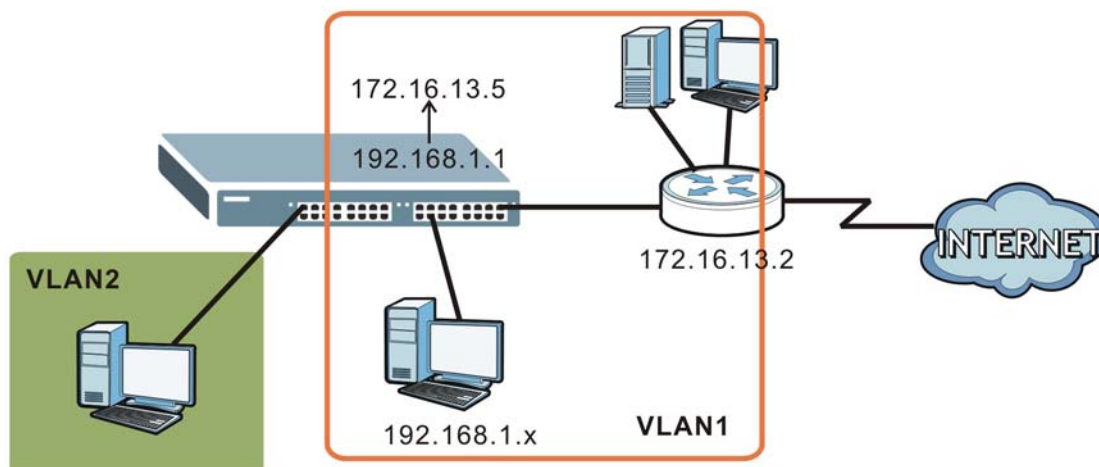

- 1 Connect your computer to the Switch's port which is in VLAN1 (the default management VLAN).
- 2 Open your web browser and enter 192.168.1.1 (the default management IP address) in the address bar to access the web configurator. See [Section 4.2 on page 25](#) for more information. Your computer must have an IP address in the range between "192.168.1.2" and "192.168.1.254".
- 3 Log in with the admin account.
- 4 Click **Configuration > System > IP** in the navigation panel.
- 5 Enter 172.16.13.5 as the Switch's new management IP address, 255.255.255.0 as the subnet mask and 172.16.13.2 as the gateway's IP address.

	Configured	Current
DHCP Client	<input type="checkbox"/>	<input type="checkbox"/> Renew
IP Address	172.16.13.5	192.168.1.1
IP Mask	255.255.255.0	255.255.255.0
IP Router	172.16.13.2	0.0.0.0
VLAN ID	1	1
DNS Server	0.0.0.0	0.0.0.0

**IP DNS Proxy Configuration**

DNS Proxy

Save Reset

Alternatively, you can select the **DHCP Client** check box to have the Switch act as a DHCP client and get an IP address from the DHCP server to which the Switch is connected. Click **Renew** to update the IP address and DNS server information after you click **Save**. The IP address assigned by a DHCP server has priority over the IP address you manually configured.

- 6 The **VLAN ID** field lets you enter the ID of the VLAN group to which you want this management IP address to belong. This is the same as the VLAN ID you configure in the **Configuration > VLANs > VLAN Membership** screen. In this example, leave the field at 1.
- 7 Click **Save** to save your changes back to the Switch.

Note: The Web Configurator may no longer be accessible unless you log in with the new IP address. Check the DHCP server for the Switch's dynamically assigned IP address when it is working as a DHCP client.

## 5.2 How to Configure Login Accounts and Privilege Levels

The admin account has a privilege level of 15, so the administrator can perform all types of system configuration. You cannot change the user name and privilege level of the admin account. You can create new login accounts the user used to log in to the Switch and manage the privilege levels for login accounts.

In this example, you create a login account with the following information.

USER NAME	PASSWORD	PRIVILEGE LEVEL
user1	qwerty12345	10

- 1 Log into the Switch's Web Configurator with the admin account.
- 2 Click **Configuration** > **Security** > **Switch** > **Users** in the navigation panel. Click **Add New User** to create a new login account.

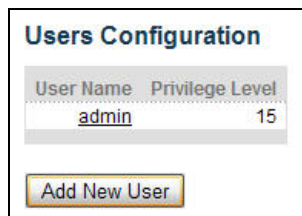

**Users Configuration**

User Name	Privilege Level
admin	15

- 3 Specify the user name, password and privilege level of the login account.
- 4 Click **Save** to apply your changes.

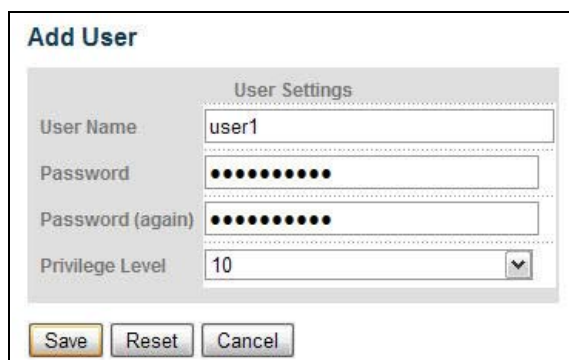

**Add User**

**User Settings**

User Name:

Password:

Password (again):

Privilege Level:

- 5 By default, you cannot use a login account with a privilege level of 10 to do system maintenance, such as configuring login accounts, uploading firmware or resetting to the factory defaults. To change the access privilege level for each feature group, go to **Configuration > Security > Switch > Privilege Levels**.

**Privilege Level Configuration**

Group Name	Privilege Levels			
	Configuration	Configuration/Execute	Status/Statistics	Status/Statistics
	Read-only	Read/write	Read-only	Read/write
Aggregation	5	10	5	10
Debug	15	15	15	15
Diagnostics	5	10	5	10
EEE	5	10	5	10
Fan_Control	5	10	5	10
IP	5	10	5	10
IPMC_LIB	5	10	5	10
IPMC_Snooping	5	10	5	10
LACP	5	10	5	10
LLDP	5	10	5	10
LLDP_MED	5	10	5	10
MAC_Table	5	10	5	10
MVR	5	10	5	10
Maintenance	15	15	15	15
Mirroring	5	10	5	10
Port_Security	5	10	5	10

Save Reset

## 5.3 How to Manage a Configuration File

Configuration files define the Switch's settings. You can use the **Configuration** screens to back up configuration files from the Switch to your computer and restore them from your computer to the Switch.

### 5.3.1 Backing up a Configuration File

Backing up your Switch configurations allows you to create various "snap shots" of your device from which you may restore at a later date.

To backup your configuration file,

- 1 Click **Maintenance > Configuration > Save** and click **Save Configuration**.

**Configuration Save**

Save Configuration

- 2 Click **Save** to display the **File Download** screen.

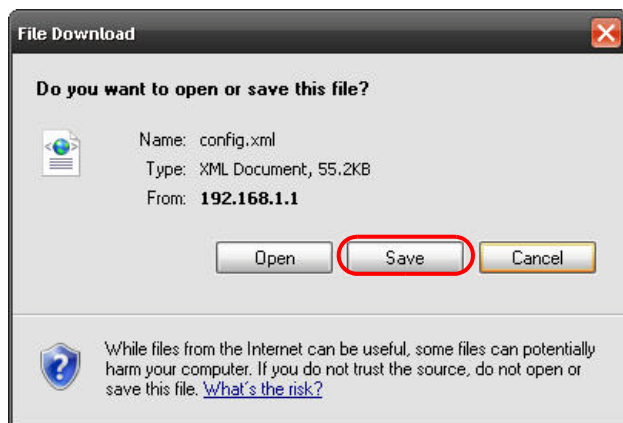

- 3 Choose a location to save the file on your computer from the **Save in** drop-down list box and type a descriptive name for it in the **File name** list box.
- 4 Click **Save** to save the configuration file to your computer.

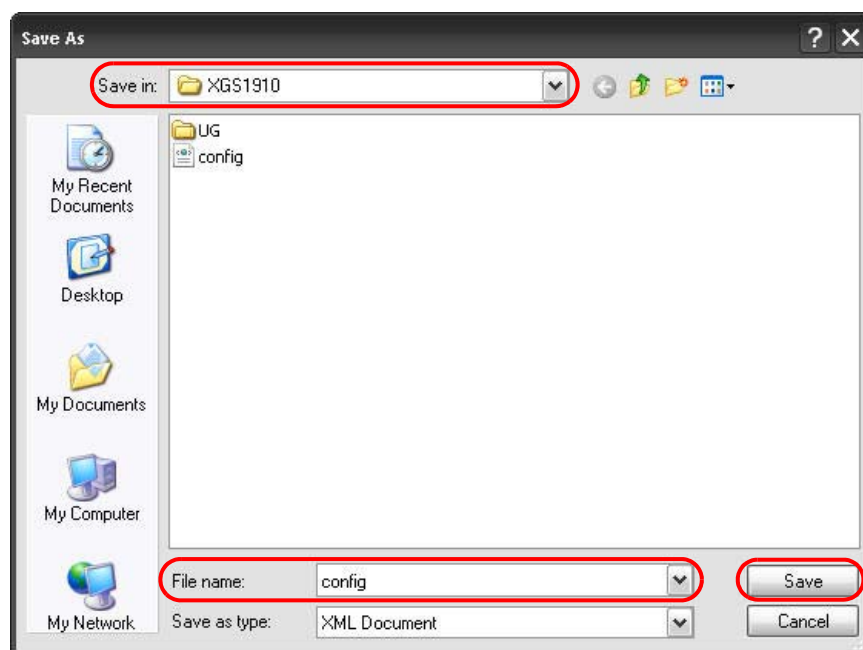

### 5.3.2 Restoring a Configuration File

If you want to upload a previously saved configuration file from your computer to the Switch, go to **Maintenance > Configuration > Upload**. Select the \*.xml file from its path and click **Upload**.

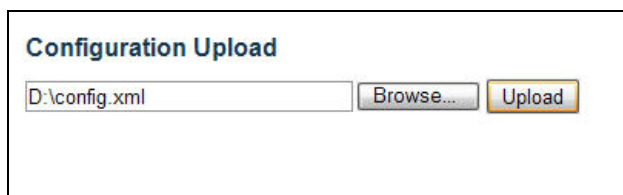

After the upload is successful, the following screen displays.



"config" is the name of the configuration file on the Switch, so your backup configuration file is automatically renamed when you restore using this screen.

## 5.4 How to Create a VLAN

VLANs confine broadcast frames to the VLAN group in which the port(s) belongs. You can do this using IEEE 802.1Q tagged static VLAN with fixed port members.

A tagged VLAN uses an explicit tag (VLAN ID) in the MAC header to identify the VLAN membership of a frame across bridges - they are not confined to the switch on which they were created. The VLANs can be created statically by hand or dynamically through Multiple VLAN Registration Protocol (MVRP). The VLAN ID associates a frame with a specific VLAN and provides the information that switches need to process the frame across the network.

Each port on the Switch is capable of passing tagged or untagged frames. To forward a frame from an 802.1Q VLAN-aware switch to an 802.1Q VLAN-unaware switch, the Switch first decides where to forward the frame and then strips off the VLAN tag. To forward a frame from an 802.1Q VLAN-unaware switch to an 802.1Q VLAN-aware switch, the Switch first decides where to forward the frame, and then inserts a VLAN tag reflecting the ingress port's default VID. The default PVID is VLAN 1 for all ports, but this can be changed.

A broadcast frame (or a multicast frame for a multicast group that is known by the system) is duplicated only on ports that are members of the VID (except the ingress port itself), thus confining the broadcast to a specific domain.

By default, all ports on the Switch are in VLAN 1. In this example, you want to configure port 1 as a member of VLAN 2.

**Figure 28** VLAN Example

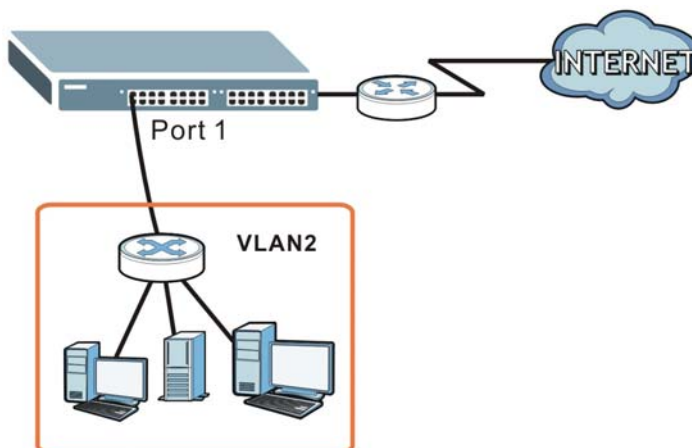

- 1 Access the Switch through **http://192.168.1.1**. Log into the Switch with the admin account.
- 2 Click **Configuration > VLANs > VLAN Membership** in the navigation panel. Click **Add New VLAN** to create VLAN2.

**VLAN Membership Configuration** Refresh |<< >>

Start from VLAN  with  entries per page.

Delete	VLAN ID	VLAN Name	Port Members																									
			1	2	3	4	5	6	7	8	9	10	11	12	13	14	15	16	17	18	19	20	21	22	23	24	25	26
<input type="checkbox"/>	1	default	<input checked="" type="checkbox"/>	<input checked="" type="checkbox"/>	<input checked="" type="checkbox"/>	<input checked="" type="checkbox"/>	<input checked="" type="checkbox"/>	<input checked="" type="checkbox"/>	<input checked="" type="checkbox"/>	<input checked="" type="checkbox"/>	<input checked="" type="checkbox"/>	<input checked="" type="checkbox"/>	<input checked="" type="checkbox"/>	<input checked="" type="checkbox"/>	<input checked="" type="checkbox"/>	<input checked="" type="checkbox"/>	<input checked="" type="checkbox"/>	<input checked="" type="checkbox"/>	<input checked="" type="checkbox"/>	<input checked="" type="checkbox"/>	<input checked="" type="checkbox"/>	<input checked="" type="checkbox"/>	<input checked="" type="checkbox"/>	<input checked="" type="checkbox"/>	<input checked="" type="checkbox"/>	<input checked="" type="checkbox"/>	<input checked="" type="checkbox"/>	<input checked="" type="checkbox"/>
<b>Add New VLAN</b>																												
Save Reset																												

- 3 Enter 2 in the **VLAN ID** field and enter a descriptive name in the **VLAN Name** field for the **VLAN2** network.

**VLAN Membership Configuration** Refresh |<< >>

Start from VLAN  with  entries per page.

Delete	VLAN ID	VLAN Name	Port Members																									
			1	2	3	4	5	6	7	8	9	10	11	12	13	14	15	16	17	18	19	20	21	22	23	24	25	26
<input type="checkbox"/>	1	default	<input checked="" type="checkbox"/>	<input checked="" type="checkbox"/>	<input checked="" type="checkbox"/>	<input checked="" type="checkbox"/>	<input checked="" type="checkbox"/>	<input checked="" type="checkbox"/>	<input checked="" type="checkbox"/>	<input checked="" type="checkbox"/>	<input checked="" type="checkbox"/>	<input checked="" type="checkbox"/>	<input checked="" type="checkbox"/>	<input checked="" type="checkbox"/>	<input checked="" type="checkbox"/>	<input checked="" type="checkbox"/>	<input checked="" type="checkbox"/>	<input checked="" type="checkbox"/>	<input checked="" type="checkbox"/>	<input checked="" type="checkbox"/>	<input checked="" type="checkbox"/>	<input checked="" type="checkbox"/>	<input checked="" type="checkbox"/>	<input checked="" type="checkbox"/>	<input checked="" type="checkbox"/>	<input checked="" type="checkbox"/>	<input checked="" type="checkbox"/>	<input checked="" type="checkbox"/>
<input type="checkbox"/>	2	VLAN2	<input checked="" type="checkbox"/>	<input type="checkbox"/>	<input type="checkbox"/>	<input type="checkbox"/>	<input type="checkbox"/>	<input type="checkbox"/>	<input type="checkbox"/>	<input type="checkbox"/>	<input type="checkbox"/>	<input type="checkbox"/>	<input type="checkbox"/>	<input type="checkbox"/>	<input type="checkbox"/>	<input type="checkbox"/>	<input type="checkbox"/>	<input type="checkbox"/>	<input type="checkbox"/>	<input type="checkbox"/>	<input type="checkbox"/>	<input type="checkbox"/>	<input type="checkbox"/>	<input type="checkbox"/>	<input type="checkbox"/>	<input type="checkbox"/>	<input type="checkbox"/>	<input type="checkbox"/>
<b>Add New VLAN</b>																												
Save Reset																												

- 4 Since the **VLAN2** network is connected to port 1 on the Switch, select port 1's check box under **Port Members** to configure port 1 to be a permanent member of the VLAN.
- 5 Click **Save** to save the settings to the Switch.

## 5.4.1 Setting Port VID

Use PVID to add a tag to incoming untagged frames received on that port so that the frames are forwarded to the VLAN group that the tag defines.

In the example network, configure 2 as the port VID on port 1 so that any untagged frames received on that port get sent to VLAN 2.

**Figure 29** Port VID Example

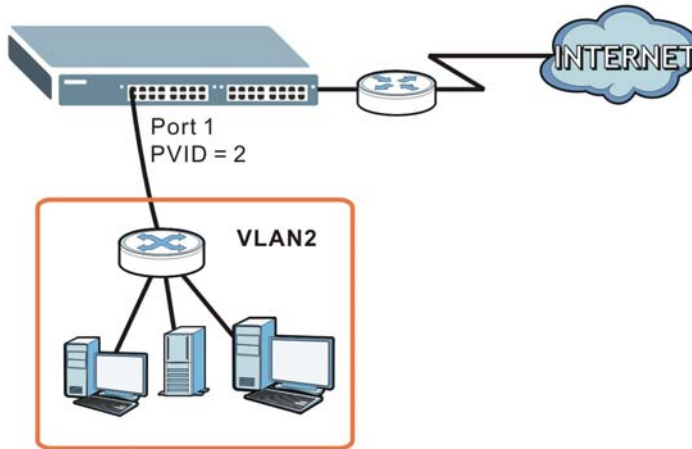

- 1 Click **Configuration** > **VLANs** > **Ports** in the navigation panel.
- 2 Set **Port VLAN Mode** to **Specific** and enter 2 in the **Port VLAN ID** field for port 1.
- 3 To ensure that VLAN-unaware devices (such as computers and hubs) can receive frames properly, you can either select **Untag\_all** in the **TX Tag** field to set the Switch to remove any VLAN tags before sending or leave the **TX Tag** field at **Untag\_pvid** to have the Switch remove a frame's VLAN tag when the frame's VLAN ID is the same as the PVID of the port on which the frame is transmitted.
- 4 click **Save** to save your changes back to the Switch.

**VLAN Port Configuration** Auto-refresh  Refresh

Port	Ingress Check	Frame Type	Port VLAN Mode	ID	Tx Tag
*	<input checked="" type="checkbox"/>	<>	<>	1	<>
1	<input checked="" type="checkbox"/>	All	Specific	2	Untag_all
2	<input checked="" type="checkbox"/>	All	Specific	1	Untag_pvid
3	<input checked="" type="checkbox"/>	All	Specific	1	Untag_pvid
4	<input checked="" type="checkbox"/>	All	Specific	1	Untag_pvid
5	<input checked="" type="checkbox"/>	All	Specific	1	Untag_pvid
6	<input checked="" type="checkbox"/>	All	Specific	1	Untag_pvid
7	<input checked="" type="checkbox"/>	All	Specific	1	Untag_pvid
8	<input checked="" type="checkbox"/>	All	Specific	1	Untag_pvid

Save Reset

## 5.5 How to Set Up a Guest VLAN with IEEE 802.1x Authentication

All ports on the Switch are in VLAN 1 by default. Say you enable IEEE 802.1x authentication on ports 1 to 8. Clients that connect to these ports should provide the correct user name and password in order to access the ports. You want to assign clients that connect to ports 1, 2 or 3 to a guest VLAN (200 for example) when they fail to authenticate with the authentication server. In this guest VLAN, clients can surf the Internet through a gateway attached to port 10, but are not allowed to access other network resources, such as the mail server or local data base.

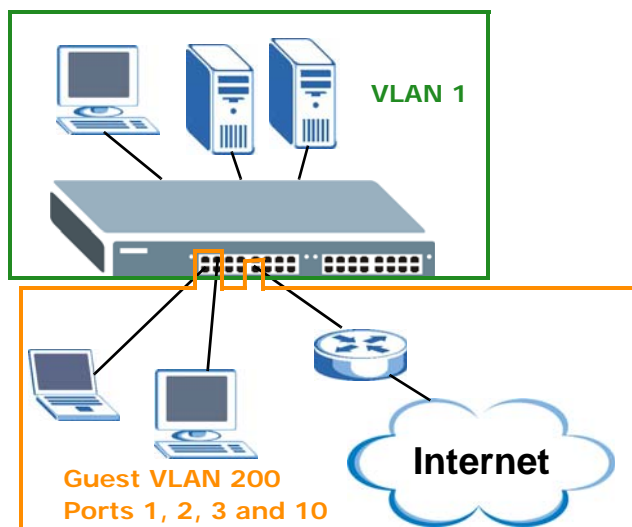

### 5.5.1 Creating a VLAN for Port which is not IEEE 802.1x enabled

Follow the steps below to configure port 10 as a member of VLAN 200.

- 1 Access the web configurator through the Switch's port which is not in VLAN 200.
- 2 Click **Configuration > VLANs > VLAN Membership** in the navigation panel. Click **Add New VLAN** to create VLAN2.

**VLAN Membership Configuration** Refresh |<< >>

Start from VLAN  with  entries per page.

			Port Members																									
Delete	VLAN ID	VLAN Name	1	2	3	4	5	6	7	8	9	10	11	12	13	14	15	16	17	18	19	20	21	22	23	24	25	26
<input type="checkbox"/>	1	default	✓	✓	✓	✓	✓	✓	✓	✓	✓	✓	✓	✓	✓	✓	✓	✓	✓	✓	✓	✓	✓	✓	✓	✓	✓	✓

**Add New VLAN** (circled in red)

Save Reset

- 3 Enter 200 in the **VLAN ID** field and enter a descriptive name (VLAN200 for example) in the **VLAN Name** field for this VLAN.
- 4 Configure port 10 to be a permanent member of the VLAN.

- Click **Save** to save the settings to the Switch.

VLAN Membership Configuration

Start from VLAN 1 with 20 entries per page.

Delete	VLAN ID	VLAN Name	Port Members																									
			1	2	3	4	5	6	7	8	9	10	11	12	13	14	15	16	17	18	19	20	21	22	23	24	25	26
<input type="checkbox"/>	1	default	<input checked="" type="checkbox"/>	<input checked="" type="checkbox"/>	<input checked="" type="checkbox"/>	<input checked="" type="checkbox"/>	<input checked="" type="checkbox"/>	<input checked="" type="checkbox"/>	<input checked="" type="checkbox"/>	<input checked="" type="checkbox"/>	<input checked="" type="checkbox"/>	<input checked="" type="checkbox"/>	<input checked="" type="checkbox"/>	<input checked="" type="checkbox"/>	<input checked="" type="checkbox"/>	<input checked="" type="checkbox"/>	<input checked="" type="checkbox"/>	<input checked="" type="checkbox"/>	<input checked="" type="checkbox"/>	<input checked="" type="checkbox"/>	<input checked="" type="checkbox"/>	<input checked="" type="checkbox"/>	<input checked="" type="checkbox"/>	<input checked="" type="checkbox"/>	<input checked="" type="checkbox"/>	<input checked="" type="checkbox"/>	<input checked="" type="checkbox"/>	<input checked="" type="checkbox"/>
<input type="checkbox"/>	200	VLAN200	<input type="checkbox"/>	<input type="checkbox"/>	<input type="checkbox"/>	<input type="checkbox"/>	<input type="checkbox"/>	<input type="checkbox"/>	<input type="checkbox"/>	<input type="checkbox"/>	<input type="checkbox"/>	<input checked="" type="checkbox"/>	<input type="checkbox"/>	<input type="checkbox"/>	<input type="checkbox"/>	<input type="checkbox"/>	<input type="checkbox"/>	<input type="checkbox"/>	<input type="checkbox"/>	<input type="checkbox"/>	<input type="checkbox"/>	<input type="checkbox"/>	<input type="checkbox"/>	<input type="checkbox"/>	<input type="checkbox"/>	<input type="checkbox"/>	<input type="checkbox"/>	<input type="checkbox"/>

Buttons: Add New VLAN, Save, Reset

- Click **Configuration > VLANs > Ports** in the navigation panel.
- Set **Port VLAN Mode** to **Specific** and enter 200 in the **Port VLAN ID** field for port 10 to add a tag to incoming untagged frames received on these ports so that the frames are forwarded to the VLAN group that the tag defines.
- To ensure that VLAN-unaware devices (such as computers and hubs) can receive frames properly, select **Untag\_all** in the **Tx Tag** field to set the Switch to remove VLAN tags before sending frames out of these ports.
- click **Save** to save your changes back to the Switch.

VLAN Port Configuration

Port	Ingress Check	Frame Type	Port VLAN Mode	ID	Tx Tag
*	<input checked="" type="checkbox"/>	<>	<>	1	<>
1	<input checked="" type="checkbox"/>	All	Specific	1	Untag_pvid
2	<input checked="" type="checkbox"/>	All	Specific	1	Untag_pvid
3	<input checked="" type="checkbox"/>	All	Specific	1	Untag_pvid
4	<input checked="" type="checkbox"/>	All	Specific	1	Untag_pvid
5	<input checked="" type="checkbox"/>	All	Specific	1	Untag_pvid
6	<input checked="" type="checkbox"/>	All	Specific	1	Untag_pvid
7	<input checked="" type="checkbox"/>	All	Specific	1	Untag_pvid
8	<input checked="" type="checkbox"/>	All	Specific	1	Untag_pvid
9	<input checked="" type="checkbox"/>	All	Specific	1	Untag_pvid
10	<input checked="" type="checkbox"/>	All	Specific	200	Untag_all
11	<input checked="" type="checkbox"/>	All	Specific	1	Untag_pvid

Buttons: Save, Reset

## 5.5.2 Enabling IEEE 802.1x Port Authentication and Guest VLAN

Follow the steps below to enable port authentication to validate access to ports 1–8 to clients based on a RADIUS server.

- Click **Configuration > Security > Network > NAS**. Select **Enabled** in the **Mode** field to activate IEEE 802.1x authentication on the Switch.

- 2 Select the **Reauthentication Enabled** check box to have a subscriber periodically re-enter his or her username and password to stay connected to the port.
- 3 Select the **Guest VLAN Enabled** check box and enter the guest VLAN ID (200 in this example) to enable the guest VLAN on the Switch. The Switch will automatically create the guest VLAN and configure the IEEE 802.1x-enabled ports as a member of the guest VLAN.
- 4 Set **Admin State** to **Port-based 802.1x** for ports 1 to 8 to turn on IEEE 802.1x authentication on these ports.
- 5 Select the **Guest VLAN Enabled** check box on ports 1, 2 and 3. The Switch puts unauthenticated clients in the specified guest VLAN.
- 6 Click **Save**. Clients that attach to port 1, 2 or 3 and fail to authenticate with the RADIUS server now should be in VLAN 200 and can access the Internet via the Internet access gateway connected to port 10 which is also in VLAN 200, but cannot communicate with devices in VLAN 1.

### Network Access Server Configuration Refresh

#### System Configuration

Mode Enabled ▾

Reauthentication Enabled

Reauthentication Period 3600 seconds

EAPOL Timeout 30 seconds

Aging Period 300 seconds

Hold Time 10 seconds

RADIUS-Assigned QoS Enabled

RADIUS-Assigned VLAN Enabled

Guest VLAN Enabled

Guest VLAN ID 200

Max. Reauth. Count 2

Allow Guest VLAN if EAPOL Seen

#### Port Configuration

Port	Admin State	RADIUS-Assigned QoS Enabled	RADIUS-Assigned VLAN Enabled	Guest VLAN Enabled	Port State	Restart
1	Port-based 802.1X ▾	<input type="checkbox"/>	<input type="checkbox"/>	<input checked="" type="checkbox"/>	Globally Disabled	Reauthenticate Reinitialize
2	Port-based 802.1X ▾	<input type="checkbox"/>	<input type="checkbox"/>	<input checked="" type="checkbox"/>	Globally Disabled	Reauthenticate Reinitialize
3	Port-based 802.1X ▾	<input type="checkbox"/>	<input type="checkbox"/>	<input checked="" type="checkbox"/>	Globally Disabled	Reauthenticate Reinitialize
4	Port-based 802.1X ▾	<input type="checkbox"/>	<input type="checkbox"/>	<input type="checkbox"/>	Globally Disabled	Reauthenticate Reinitialize
5	Port-based 802.1X ▾	<input type="checkbox"/>	<input type="checkbox"/>	<input type="checkbox"/>	Globally Disabled	Reauthenticate Reinitialize
6	Port-based 802.1X ▾	<input type="checkbox"/>	<input type="checkbox"/>	<input type="checkbox"/>	Globally Disabled	Reauthenticate Reinitialize
7	Port-based 802.1X ▾	<input type="checkbox"/>	<input type="checkbox"/>	<input type="checkbox"/>	Globally Disabled	Reauthenticate Reinitialize
8	Port-based 802.1X ▾	<input type="checkbox"/>	<input type="checkbox"/>	<input type="checkbox"/>	Globally Disabled	Reauthenticate Reinitialize
9	Force Authorized ▾	<input type="checkbox"/>	<input type="checkbox"/>	<input type="checkbox"/>	Globally Disabled	Reauthenticate Reinitialize
10	Force Authorized ▾	<input type="checkbox"/>	<input type="checkbox"/>	<input type="checkbox"/>	Globally Disabled	Reauthenticate Reinitialize
11	Force Authorized ▾	<input type="checkbox"/>	<input type="checkbox"/>	<input type="checkbox"/>	Globally Disabled	Reauthenticate Reinitialize

Save Reset

## 5.6 How to Use Private VLAN to Do Port Isolation in a VLAN

This tutorial is not applicable to the XGS1910-24 or XGS1910-48.

Port isolation prevents communication between ports. You want to do port isolation in a VLAN but still allow ports to access the Internet or network resources through the uplink port in the same VLAN. You use private VLAN to do port isolation in a VLAN instead of assigning each port to a separate VLAN and creating a different IP routing domain for each individual port.

By default, all ports on the Switch are in VLAN 1 and private VLAN 1. An isolated port is a port on which port isolation is enabled. An isolated port cannot communicate with other isolated ports even when they are in the same VLAN and same private VLAN.

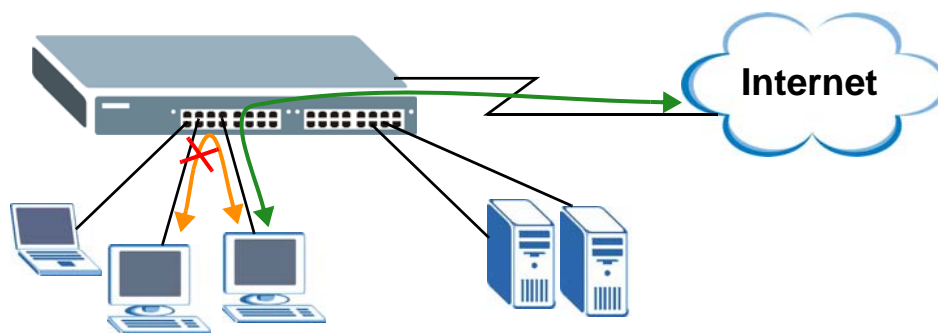

In this example, you put ports 2 to 4 and 25 in private VLAN 25 and enable port isolation to block traffic between ports 2, 3 and 4.

### 5.6.1 Creating a Private VLAN

Follow the steps below to configure port 2, 3, 4 and 25 as a member of private VLAN 25.

- 1 Access the web configurator through the Switch's port on which port isolation will not be enabled.
- 2 Go to **Configuration > Private VLANs > PVLAN Membership**. Click **Add New Private VLAN**.

**Private VLAN Membership Configuration** Auto-refresh

		Port Members																									
Delete	PVLAN ID	1	2	3	4	5	6	7	8	9	10	11	12	13	14	15	16	17	18	19	20	21	22	23	24	25	26
<input type="checkbox"/>	1	<input checked="" type="checkbox"/>	<input checked="" type="checkbox"/>	<input checked="" type="checkbox"/>	<input checked="" type="checkbox"/>	<input checked="" type="checkbox"/>	<input checked="" type="checkbox"/>	<input checked="" type="checkbox"/>	<input checked="" type="checkbox"/>	<input checked="" type="checkbox"/>	<input checked="" type="checkbox"/>	<input checked="" type="checkbox"/>	<input checked="" type="checkbox"/>	<input checked="" type="checkbox"/>	<input checked="" type="checkbox"/>	<input checked="" type="checkbox"/>	<input checked="" type="checkbox"/>	<input checked="" type="checkbox"/>	<input checked="" type="checkbox"/>	<input checked="" type="checkbox"/>	<input checked="" type="checkbox"/>	<input checked="" type="checkbox"/>	<input checked="" type="checkbox"/>	<input checked="" type="checkbox"/>	<input checked="" type="checkbox"/>	<input checked="" type="checkbox"/>	<input checked="" type="checkbox"/>

- 3 Enter a private VLAN ID (25 for example) in the **PVLAN ID** field.
- 4 Select ports 2, 3, 4 and 25 to be members of this private VLAN.



If you want to use dynamic bindings to filter unauthorized ARP packets (typical implementation), you have to enable DHCP snooping before you enable ARP inspection.

## Trusted vs. Untrusted Ports

Every port is either a trusted port or an untrusted port for DHCP snooping.

Trusted ports are connected to DHCP servers or other switches. The Switch learns dynamic bindings from trusted ports.

Note: The Switch will drop all DHCP requests if you enable DHCP snooping and there are no trusted ports.

Untrusted ports are connected to subscribers. The Switch discards DHCP packets from untrusted ports in the following situations:

- The packet is a DHCP server packet (for example, OFFER, ACK, or NACK).
- The source MAC address and source IP address in the packet do not match any of the current bindings.
- The packet is a RELEASE or DECLINE packet, and the source MAC address and source port do not match any of the current bindings.

In the following example, you only want DHCP server **A** connected to port 5 to assign IP addresses to all devices in VLAN 100. Create a VLAN containing ports 5, 6 and 7. Connect a computer (**M**) to the Switch's port which is not in VLAN 100.

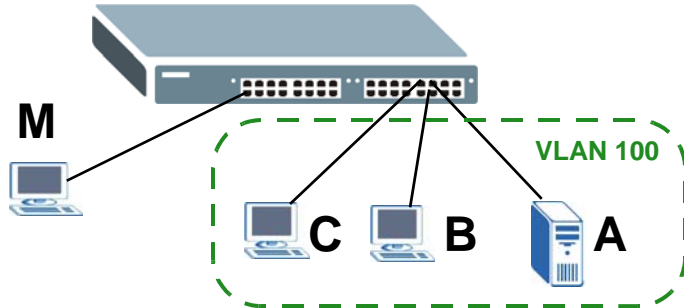

The settings in this tutorial are as the following.

**Table 5** Settings in this Tutorial

HOST	PORT CONNECTED	VLAN	PVID	DHCP SNOOPING PORT TRUSTED
DHCP Server (A)	5	1 and 100	100	Yes
DHCP Client (B)	6	1 and 100	100	No
DHCP Client (C)	7	1 and 100	100	No

- 1 Access the Switch through **http://192.168.1.1**. Log into the Switch by entering the username (default: **admin**) and password (default: **1234**).
- 2 See [Section 5.4 on page 38](#) for how to create a VLAN and configure ports to join the VLAN.

- 3 Go to **Configuration > Security > Network > DHCP > Snooping** to activate DHCP snooping on the Switch.
- 4 Specify whether ports are trusted or untrusted ports for DHCP snooping. Select **Trusted** in the **Mode** field for port 5 because the DHCP server is connected to port 5. Set ports 6 and 7 to **Untrusted** as they are connected to DHCP clients. Click **Save**.

**DHCP Snooping Configuration**

Snooping Mode: Enabled

**Port Mode Configuration**

Port	Mode
*	<>
1	Trusted
2	Trusted
3	Trusted
4	Trusted
5	Untrusted
6	Untrusted
7	Untrusted
8	Trusted
9	Trusted
10	Trusted

Save Reset

- 5 Connect your DHCP server to port 5 and a computer (as DHCP client) to either port 6 or 7. The computer should be able to get an IP address from the DHCP server. If you put the DHCP server on port 6 or 7, the computer will not be able to get an IP address.

- 6 Click **Configuration > Security > Network > IP Source Guard > Configuration** and enable IP source guard on the Switch and on ports 6 and 7. Set the maximum number of DHCP clients to learn dynamically on ports 6 and 7. Click **Save**.

**IP Source Guard Configuration**

Mode: **Enabled** ▼

Translate dynamic to static

**Port Mode Configuration**

Port	Mode	Max Dynamic Clients
*	<> ▼	<> ▼
1	Disabled ▼	Unlimited ▼
2	Disabled ▼	Unlimited ▼
3	Disabled ▼	Unlimited ▼
4	Disabled ▼	Unlimited ▼
5	Disabled ▼	Unlimited ▼
6	<b>Enabled</b> ▼	Unlimited ▼
7	<b>Enabled</b> ▼	Unlimited ▼
8	Disabled ▼	Unlimited ▼
9	Disabled ▼	Unlimited ▼
10	Disabled ▼	Unlimited ▼

Save Reset

- 7 Go to **Monitor > Security > Network > IP Source Guard** to look at the current dynamic bindings for DHCP snooping. You should see an IP binding for port 6 or 7 in VLAN 100.

**Dynamic IP Source Guard Table** Auto-refresh  Refresh |<< >>

Start from Port 1 ▼, VLAN 1 and IP address 0.0.0.0 with 20 entries per page.

Port	VLAN ID	IP Address	MAC Address
7	100	172.16.3.7	00-31-85-0c-24-4b

## 5.8 How to Use DHCP Relay on the Switch

If the DHCP clients and the DHCP server are not in the same broadcast domain, the Switch can help to relay network information (such as the IP address and subnet mask) between a DHCP client and a DHCP server. This tutorial describes how to configure your Switch to forward DHCP client requests to a specific DHCP server. The DHCP server can then assign a specific IP address based on the information in the DHCP requests.

In this example, you have configured your DHCP server (192.168.2.3) and want to have it assign a specific IP address (say 172.16.1.18) and gateway information to DHCP client **A** based on the slot

ID, VLAN ID and port number in the DHCP request. Client **A** connects to the Switch's port 2 in VLAN 102.

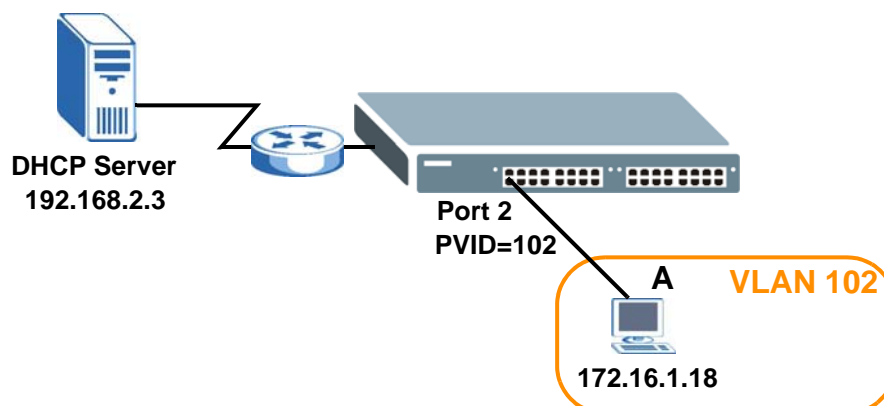

## 5.8.1 Creating a VLAN

- 1 Access the web configurator through the Switch's port which is in VLAN 1.
- 2 Configure port 2 as a member of VLAN 102. See [Section 5.4 on page 38](#) for how to create a VLAN and configure ports to join the VLAN.

## 5.8.2 Configuring DHCP Relay

- 1 Click **Configuration > Security > Network > DHCP > Relay**.
- 2 Select **Enabled** in the **Relay Mode** field to enable DHCP relay on the Switch.
- 3 Enter the DHCP server's IP address (192.168.2.3 in this example) in the **Relay Server** field.
- 4 Select **Enabled** in the **Relay Information Mode** field to allow the Switch to add relay agent information (such as the VLAN ID) to DHCP requests.
- 5 Select **Replace** in the **Relay Information Policy** field to have the Switch remove the original DHCP relay agent information (if any) and add new information in the DHCP requests.
- 6 Click **Save** to save your changes back to the Switch.

**DHCP Relay Configuration**

Relay Mode	Enabled <input type="button" value="v"/>
Relay Server	192.168.2.3
Relay Information Mode	Enabled <input type="button" value="v"/>
Relay Information Policy	Replace <input type="button" value="v"/>

- 7 The DHCP server can then assign a specific IP address based on the DHCP request.

### 5.8.3 Troubleshooting

Check the client **A**'s IP address. If it did not receive the IP address 172.16.1.18, make sure:

- 1 Client **A** is connected to the Switch's port 2 in VLAN 102.

## 5.9 How to Use Link Aggregation to Group Multiple Ports into One Logical Link

Link aggregation (trunking) is the grouping of physical ports into one logical higher-capacity link. You may want to trunk ports if for example, it is cheaper to use multiple lower-speed links than to under-utilize a high-speed, but more costly, single-port link.

However, the more ports you aggregate then the fewer available ports you have. A trunk group is one logical link containing multiple ports.

The beginning port of each trunk group must be physically connected to form a trunk group.

The Switch supports both static and dynamic link aggregation. The Switch supports the IEEE 802.3ad standard for static and dynamic (LACP) port trunking. This standard describes the Link Aggregation Control Protocol (LACP), which is a protocol that dynamically creates and manages trunk groups.

Note: In a properly planned network, it is recommended to implement static link aggregation only. This ensures increased network stability and control over the trunk groups on your Switch.

### 5.9.1 Static Port Trunking

This example shows you how to create a static port trunk group for ports 2-5.

- 1 **Make your physical connections** - make sure that the ports that you want to belong to the trunk group are connected to the same destination. The following figure shows ports 2-5 on switch A connected to switch B.



- 2 **Configure static trunking** - Click **Configuration > Aggregation > Static**. In this screen select the traffic distribution type(s) used by this group and select the ports that should belong to this group as shown in the figure below. Packets from the same source and/or to the same destination are sent over the same link within the trunk. If the Switch is behind a router, the packet's destination or source MAC address will be changed. In this case, set the Switch to distribute traffic based on its IP address to make sure port trunking can work properly.
- Click **Save** when you are done.

### Aggregation Mode Configuration

**Hash Code Contributors**

Source MAC Address

Destination MAC Address

IP Address

TCP/UDP Port Number

### Aggregation Group Configuration

Group ID	Port Members																										
	1	2	3	4	5	6	7	8	9	10	11	12	13	14	15	16	17	18	19	20	21	22	23	24	25	26	
Normal	<input type="radio"/>	<input type="radio"/>	<input type="radio"/>	<input type="radio"/>	<input type="radio"/>	<input type="radio"/>	<input type="radio"/>	<input type="radio"/>	<input type="radio"/>	<input type="radio"/>	<input type="radio"/>	<input type="radio"/>	<input type="radio"/>	<input type="radio"/>	<input type="radio"/>	<input type="radio"/>	<input type="radio"/>	<input type="radio"/>	<input type="radio"/>	<input type="radio"/>	<input type="radio"/>	<input type="radio"/>	<input type="radio"/>	<input type="radio"/>	<input type="radio"/>	<input type="radio"/>	<input type="radio"/>
1	<input type="radio"/>	<input type="radio"/>	<input type="radio"/>	<input type="radio"/>	<input type="radio"/>	<input type="radio"/>	<input type="radio"/>	<input type="radio"/>	<input type="radio"/>	<input type="radio"/>	<input type="radio"/>	<input type="radio"/>	<input type="radio"/>	<input type="radio"/>	<input type="radio"/>	<input type="radio"/>	<input type="radio"/>	<input type="radio"/>	<input type="radio"/>	<input type="radio"/>	<input type="radio"/>	<input type="radio"/>	<input type="radio"/>	<input type="radio"/>	<input type="radio"/>	<input type="radio"/>	<input type="radio"/>
2	<input type="radio"/>	<input type="radio"/>	<input type="radio"/>	<input type="radio"/>	<input type="radio"/>	<input type="radio"/>	<input type="radio"/>	<input type="radio"/>	<input type="radio"/>	<input type="radio"/>	<input type="radio"/>	<input type="radio"/>	<input type="radio"/>	<input type="radio"/>	<input type="radio"/>	<input type="radio"/>	<input type="radio"/>	<input type="radio"/>	<input type="radio"/>	<input type="radio"/>	<input type="radio"/>	<input type="radio"/>	<input type="radio"/>	<input type="radio"/>	<input type="radio"/>	<input type="radio"/>	<input type="radio"/>
3	<input type="radio"/>	<input type="radio"/>	<input type="radio"/>	<input type="radio"/>	<input type="radio"/>	<input type="radio"/>	<input type="radio"/>	<input type="radio"/>	<input type="radio"/>	<input type="radio"/>	<input type="radio"/>	<input type="radio"/>	<input type="radio"/>	<input type="radio"/>	<input type="radio"/>	<input type="radio"/>	<input type="radio"/>	<input type="radio"/>	<input type="radio"/>	<input type="radio"/>	<input type="radio"/>	<input type="radio"/>	<input type="radio"/>	<input type="radio"/>	<input type="radio"/>	<input type="radio"/>	<input type="radio"/>
4	<input type="radio"/>	<input type="radio"/>	<input type="radio"/>	<input type="radio"/>	<input type="radio"/>	<input type="radio"/>	<input type="radio"/>	<input type="radio"/>	<input type="radio"/>	<input type="radio"/>	<input type="radio"/>	<input type="radio"/>	<input type="radio"/>	<input type="radio"/>	<input type="radio"/>	<input type="radio"/>	<input type="radio"/>	<input type="radio"/>	<input type="radio"/>	<input type="radio"/>	<input type="radio"/>	<input type="radio"/>	<input type="radio"/>	<input type="radio"/>	<input type="radio"/>	<input type="radio"/>	<input type="radio"/>
5	<input type="radio"/>	<input type="radio"/>	<input type="radio"/>	<input type="radio"/>	<input type="radio"/>	<input type="radio"/>	<input type="radio"/>	<input type="radio"/>	<input type="radio"/>	<input type="radio"/>	<input type="radio"/>	<input type="radio"/>	<input type="radio"/>	<input type="radio"/>	<input type="radio"/>	<input type="radio"/>	<input type="radio"/>	<input type="radio"/>	<input type="radio"/>	<input type="radio"/>	<input type="radio"/>	<input type="radio"/>	<input type="radio"/>	<input type="radio"/>	<input type="radio"/>	<input type="radio"/>	<input type="radio"/>
6	<input type="radio"/>	<input type="radio"/>	<input type="radio"/>	<input type="radio"/>	<input type="radio"/>	<input type="radio"/>	<input type="radio"/>	<input type="radio"/>	<input type="radio"/>	<input type="radio"/>	<input type="radio"/>	<input type="radio"/>	<input type="radio"/>	<input type="radio"/>	<input type="radio"/>	<input type="radio"/>	<input type="radio"/>	<input type="radio"/>	<input type="radio"/>	<input type="radio"/>	<input type="radio"/>	<input type="radio"/>	<input type="radio"/>	<input type="radio"/>	<input type="radio"/>	<input type="radio"/>	<input type="radio"/>
7	<input type="radio"/>	<input type="radio"/>	<input type="radio"/>	<input type="radio"/>	<input type="radio"/>	<input type="radio"/>	<input type="radio"/>	<input type="radio"/>	<input type="radio"/>	<input type="radio"/>	<input type="radio"/>	<input type="radio"/>	<input type="radio"/>	<input type="radio"/>	<input type="radio"/>	<input type="radio"/>	<input type="radio"/>	<input type="radio"/>	<input type="radio"/>	<input type="radio"/>	<input type="radio"/>	<input type="radio"/>	<input type="radio"/>	<input type="radio"/>	<input type="radio"/>	<input type="radio"/>	<input type="radio"/>
8	<input type="radio"/>	<input type="radio"/>	<input type="radio"/>	<input type="radio"/>	<input type="radio"/>	<input type="radio"/>	<input type="radio"/>	<input type="radio"/>	<input type="radio"/>	<input type="radio"/>	<input type="radio"/>	<input type="radio"/>	<input type="radio"/>	<input type="radio"/>	<input type="radio"/>	<input type="radio"/>	<input type="radio"/>	<input type="radio"/>	<input type="radio"/>	<input type="radio"/>	<input type="radio"/>	<input type="radio"/>	<input type="radio"/>	<input type="radio"/>	<input type="radio"/>	<input type="radio"/>	<input type="radio"/>
9	<input type="radio"/>	<input type="radio"/>	<input type="radio"/>	<input type="radio"/>	<input type="radio"/>	<input type="radio"/>	<input type="radio"/>	<input type="radio"/>	<input type="radio"/>	<input type="radio"/>	<input type="radio"/>	<input type="radio"/>	<input type="radio"/>	<input type="radio"/>	<input type="radio"/>	<input type="radio"/>	<input type="radio"/>	<input type="radio"/>	<input type="radio"/>	<input type="radio"/>	<input type="radio"/>	<input type="radio"/>	<input type="radio"/>	<input type="radio"/>	<input type="radio"/>	<input type="radio"/>	<input type="radio"/>
10	<input type="radio"/>	<input type="radio"/>	<input type="radio"/>	<input type="radio"/>	<input type="radio"/>	<input type="radio"/>	<input type="radio"/>	<input type="radio"/>	<input type="radio"/>	<input type="radio"/>	<input type="radio"/>	<input type="radio"/>	<input type="radio"/>	<input type="radio"/>	<input type="radio"/>	<input type="radio"/>	<input type="radio"/>	<input type="radio"/>	<input type="radio"/>	<input type="radio"/>	<input type="radio"/>	<input type="radio"/>	<input type="radio"/>	<input type="radio"/>	<input type="radio"/>	<input type="radio"/>	<input type="radio"/>
11	<input type="radio"/>	<input type="radio"/>	<input type="radio"/>	<input type="radio"/>	<input type="radio"/>	<input type="radio"/>	<input type="radio"/>	<input type="radio"/>	<input type="radio"/>	<input type="radio"/>	<input type="radio"/>	<input type="radio"/>	<input type="radio"/>	<input type="radio"/>	<input type="radio"/>	<input type="radio"/>	<input type="radio"/>	<input type="radio"/>	<input type="radio"/>	<input type="radio"/>	<input type="radio"/>	<input type="radio"/>	<input type="radio"/>	<input type="radio"/>	<input type="radio"/>	<input type="radio"/>	<input type="radio"/>
12	<input type="radio"/>	<input type="radio"/>	<input type="radio"/>	<input type="radio"/>	<input type="radio"/>	<input type="radio"/>	<input type="radio"/>	<input type="radio"/>	<input type="radio"/>	<input type="radio"/>	<input type="radio"/>	<input type="radio"/>	<input type="radio"/>	<input type="radio"/>	<input type="radio"/>	<input type="radio"/>	<input type="radio"/>	<input type="radio"/>	<input type="radio"/>	<input type="radio"/>	<input type="radio"/>	<input type="radio"/>	<input type="radio"/>	<input type="radio"/>	<input type="radio"/>	<input type="radio"/>	<input type="radio"/>
13	<input type="radio"/>	<input type="radio"/>	<input type="radio"/>	<input type="radio"/>	<input type="radio"/>	<input type="radio"/>	<input type="radio"/>	<input type="radio"/>	<input type="radio"/>	<input type="radio"/>	<input type="radio"/>	<input type="radio"/>	<input type="radio"/>	<input type="radio"/>	<input type="radio"/>	<input type="radio"/>	<input type="radio"/>	<input type="radio"/>	<input type="radio"/>	<input type="radio"/>	<input type="radio"/>	<input type="radio"/>	<input type="radio"/>	<input type="radio"/>	<input type="radio"/>	<input type="radio"/>	<input type="radio"/>

## 5.9.2 Dynamic Port Trunking

When you enable LACP link aggregation on a port, the port can automatically negotiate with the ports at the remote end of a link to establish trunk groups. LACP also allows port redundancy, that is, if an operational port fails, then one of the “standby” ports become operational without user intervention. Please note that:

- You must connect all ports point-to-point to the same Ethernet Switch and configure the ports for LACP trunking.
- LACP only works on full-duplex links.
- All ports in the same trunk group must have the same media type, speed, duplex mode and flow control settings.

To configure the settings:

- 1 Click **Configuration > Aggregation > LACP**. Enable LACP on ports for which you want to create a trunk group using LACP. Leave the other fields to their default settings. Click **Save**.

**LACP Port Configuration**

Port	LACP Enabled	Key	Role
*	<input type="checkbox"/>	<>	<>
1	<input type="checkbox"/>	Auto	Active
2	<input checked="" type="checkbox"/>	Auto	Active
3	<input checked="" type="checkbox"/>	Auto	Active
4	<input checked="" type="checkbox"/>	Auto	Active
5	<input checked="" type="checkbox"/>	Auto	Active
6	<input type="checkbox"/>	Auto	Active
7	<input type="checkbox"/>	Auto	Active
8	<input type="checkbox"/>	Auto	Active
9	<input type="checkbox"/>	Auto	Active

Save Reset

## 5.10 How to Analyze Traffic Using Mirroring

With mirroring, you can copy a traffic flow (passing through the source port(s)) to another port (a destination port you copy the traffic to) in order that you can examine the traffic from the destination port without interference.

You can also use remote port mirroring to monitor multiple switches across your network. In remote port mirroring, the traffic from the source port(s) is forwarded to a specific remote port mirroring VLAN through a reflector port and copied to an intermediate port. Traffic are then carried over the VLAN and sent to a destination port in a remote switch through the intermediate ports that connect to other switches.

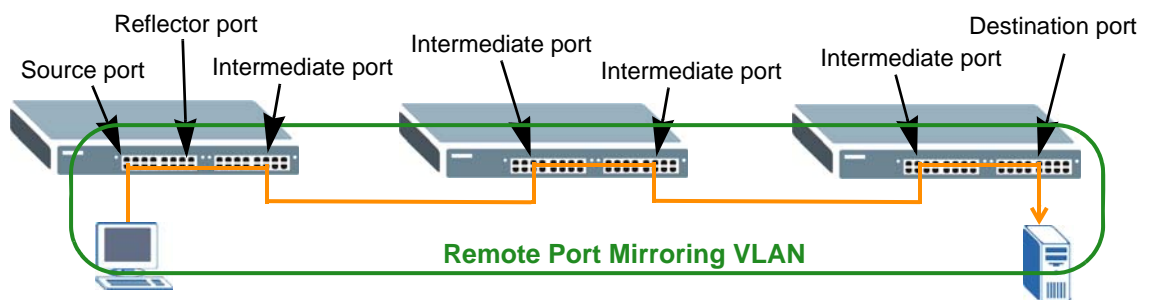

## 5.10.1 Configuring Mirroring

In this example, you are attached to port 2 but want to copy traffic received or transmitted on port 7 for analysis.

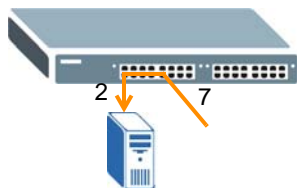

- 1 Access the Switch through **http://192.168.1.1**. Log into the Switch by entering the username (default: **admin**) and password (default: **1234**).
- 2 Go to **Configuration > Port Mirroring**. Select **Enabled** in the **Mode** field to activate mirroring on the Switch.
- 3 Set **Type** to **Mirror** to do mirroring in one standalone switch.
- 4 Configure port 2 to act as a destination port to which the Switch copy traffic from the source port(s).
- 5 Select the direction of traffic flow you want to copy (**Both** in this example) on port 7.
- 6 Click **Save**. You then should be able to receive a copy of the traffic passing through port 7 to examine it in more detail without interfering with the traffic flow on the original port.

**Mirroring & Remote Port Mirroring Configuration**

Session Number: 1

Mode: **Enabled**

Type: **Mirror**

VLAN ID: 200

Reflector Port: Port 1

Port	Source	Intermediate	Destination
1	Disabled	<input type="checkbox"/>	<input type="checkbox"/>
2	Disabled	<input type="checkbox"/>	<input checked="" type="checkbox"/>
3	Disabled	<input type="checkbox"/>	<input type="checkbox"/>
4	Disabled	<input type="checkbox"/>	<input type="checkbox"/>
5	Disabled	<input type="checkbox"/>	<input type="checkbox"/>
6	Disabled	<input type="checkbox"/>	<input type="checkbox"/>
7	<b>Both</b>	<input type="checkbox"/>	<input type="checkbox"/>
8	Disabled	<input type="checkbox"/>	<input type="checkbox"/>
9	Disabled	<input type="checkbox"/>	<input type="checkbox"/>

Save Reset

## 5.10.2 Configuring Remote Port Mirroring

In this example, there are three switches (**A**, **B** and **C**) in your network. You are connected to port **10** of switch **C** but want to monitor traffic received or transmitted on port **4** of switch **A**. The copied traffic is forwarded to remote port mirroring VLAN 100.

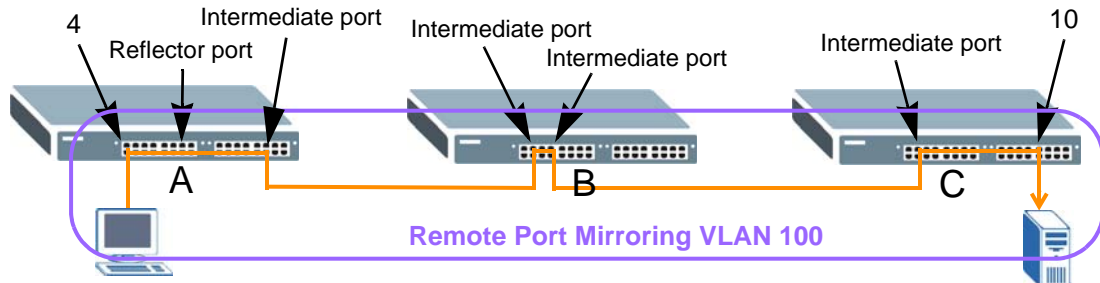

### In Switch A:

- 1 Access the Switch through **http://192.168.1.1**. Log into the Switch by entering the username (default: **admin**) and password (default: **1234**).
- 2 Go to **Configuration > Port Mirroring**. Select **Enabled** in the **Mode** field to activate mirroring on the Switch.
- 3 Set **Type** to **Source** to configure a source port on Switch **A**.
- 4 Enter the remote port mirroring VLAN ID number (**100** in this example) and select a reflector port (**Port 7** for example) through which copied traffic is forwarded to the specified VLAN. The Switch will automatically create the remote port mirroring VLAN and configure the reflector and intermediate ports as a member of the remote port mirroring VLAN.
- 5 Select the direction of traffic flow you want to copy (**Both** in this example) on the source port (port 4 in this example).
- 6 Configure port 12 to act as an intermediate port to which traffic from the source port is copied that connects to Switch **B**.

- 7 Click **Save**.

**Mirroring & Remote Port Mirroring Configuration**

Session Number: 1

Mode: Enabled

Type: Source

VLAN ID: 100

Reflector Port: Port 7

Port	Source	Intermediate	Destination
1	Disabled	<input type="checkbox"/>	<input type="checkbox"/>
2	Disabled	<input type="checkbox"/>	<input checked="" type="checkbox"/>
3	Disabled	<input type="checkbox"/>	<input type="checkbox"/>
4	Both	<input type="checkbox"/>	<input type="checkbox"/>
5	Disabled	<input type="checkbox"/>	<input type="checkbox"/>
6	Disabled	<input type="checkbox"/>	<input type="checkbox"/>
7	Disabled	<input type="checkbox"/>	<input type="checkbox"/>
8	Disabled	<input type="checkbox"/>	<input type="checkbox"/>
9	Disabled	<input type="checkbox"/>	<input type="checkbox"/>
10	Disabled	<input type="checkbox"/>	<input type="checkbox"/>
11	Disabled	<input type="checkbox"/>	<input type="checkbox"/>
12	Disabled	<input checked="" type="checkbox"/>	<input type="checkbox"/>
13	Disabled	<input type="checkbox"/>	<input type="checkbox"/>
14	Disabled	<input type="checkbox"/>	<input type="checkbox"/>

Save Reset

- Click **Configuration > Spanning Tree > CIST Ports** to disable (R)STP on the reflector port to prevent the port from entering blocking state.

### STP CIST Port Configuration

**CIST Aggregated Port Configuration**

Port	STP Enabled	Path Cost	Priority	Admin Edge	Auto Edge	Restricted Role	TCN	BPDU Guard	Point-to-point
-	<input checked="" type="checkbox"/>	Auto	128	Non-Edge	<input checked="" type="checkbox"/>	<input type="checkbox"/>	<input type="checkbox"/>	<input type="checkbox"/>	Forced True

**CIST Normal Port Configuration**

Port	STP Enabled	Path Cost	Priority	Admin Edge	Auto Edge	Restricted Role	TCN	BPDU Guard	Point-to-point
*	<input checked="" type="checkbox"/>	<>	<>	<>	<input checked="" type="checkbox"/>	<input type="checkbox"/>	<input type="checkbox"/>	<input type="checkbox"/>	<>
1	<input checked="" type="checkbox"/>	Auto	128	Non-Edge	<input checked="" type="checkbox"/>	<input type="checkbox"/>	<input type="checkbox"/>	<input type="checkbox"/>	Auto
2	<input checked="" type="checkbox"/>	Auto	128	Non-Edge	<input checked="" type="checkbox"/>	<input type="checkbox"/>	<input type="checkbox"/>	<input type="checkbox"/>	Auto
3	<input checked="" type="checkbox"/>	Auto	128	Non-Edge	<input checked="" type="checkbox"/>	<input type="checkbox"/>	<input type="checkbox"/>	<input type="checkbox"/>	Auto
4	<input checked="" type="checkbox"/>	Auto	128	Non-Edge	<input checked="" type="checkbox"/>	<input type="checkbox"/>	<input type="checkbox"/>	<input type="checkbox"/>	Auto
5	<input checked="" type="checkbox"/>	Auto	128	Non-Edge	<input checked="" type="checkbox"/>	<input type="checkbox"/>	<input type="checkbox"/>	<input type="checkbox"/>	Auto
7	<input type="checkbox"/>	Auto	128	Non-Edge	<input checked="" type="checkbox"/>	<input type="checkbox"/>	<input type="checkbox"/>	<input type="checkbox"/>	Auto
8	<input checked="" type="checkbox"/>	Auto	128	Non-Edge	<input checked="" type="checkbox"/>	<input type="checkbox"/>	<input type="checkbox"/>	<input type="checkbox"/>	Auto

- Go to **Configuration > MAC Table** to disable MAC address learning on the reflector and intermediate ports so that the Switch will NOT filter or forward a frame based on the frame's destination MAC address, or even drop the frame whose MAC address is not in the MAC address table on these ports.

### MAC Address Table Configuration

#### Aging Configuration

Disable Automatic Aging

Aging Time:  seconds

#### MAC Table Learning

		Port Members																										
		1	2	3	4	5	6	7	8	9	10	11	12	13	14	15	16	17	18	19	20	21	22	23	24	25	26	
Auto	<input type="radio"/>	<input type="radio"/>	<input type="radio"/>	<input type="radio"/>	<input type="radio"/>	<input type="radio"/>	<input type="radio"/>	<input type="radio"/>	<input type="radio"/>	<input type="radio"/>	<input type="radio"/>	<input type="radio"/>	<input type="radio"/>	<input type="radio"/>	<input type="radio"/>	<input type="radio"/>	<input type="radio"/>	<input type="radio"/>	<input type="radio"/>	<input type="radio"/>	<input type="radio"/>	<input type="radio"/>	<input type="radio"/>	<input type="radio"/>	<input type="radio"/>	<input type="radio"/>	<input type="radio"/>	<input type="radio"/>
Disable	<input type="radio"/>	<input type="radio"/>	<input type="radio"/>	<input type="radio"/>	<input type="radio"/>	<input type="radio"/>	<input type="radio"/>	<input type="radio"/>	<input type="radio"/>	<input type="radio"/>	<input type="radio"/>	<input type="radio"/>	<input type="radio"/>	<input type="radio"/>	<input type="radio"/>	<input type="radio"/>	<input type="radio"/>	<input type="radio"/>	<input type="radio"/>	<input type="radio"/>	<input type="radio"/>	<input type="radio"/>	<input type="radio"/>	<input type="radio"/>	<input type="radio"/>	<input type="radio"/>	<input type="radio"/>	<input type="radio"/>
Secure	<input type="radio"/>	<input type="radio"/>	<input type="radio"/>	<input type="radio"/>	<input type="radio"/>	<input type="radio"/>	<input type="radio"/>	<input type="radio"/>	<input type="radio"/>	<input type="radio"/>	<input type="radio"/>	<input type="radio"/>	<input type="radio"/>	<input type="radio"/>	<input type="radio"/>	<input type="radio"/>	<input type="radio"/>	<input type="radio"/>	<input type="radio"/>	<input type="radio"/>	<input type="radio"/>	<input type="radio"/>	<input type="radio"/>	<input type="radio"/>	<input type="radio"/>	<input type="radio"/>	<input type="radio"/>	<input type="radio"/>

#### Static MAC Table Configuration

			Port Members																									
Delete	VLAN ID	MAC Address	1	2	3	4	5	6	7	8	9	10	11	12	13	14	15	16	17	18	19	20	21	22	23	24	25	26
Add New Static Entry																												

### In Switch B:

- Access the Switch through **http://192.168.1.1**. Log into the Switch by entering the username (default: **admin**) and password (default: **1234**).
- Go to **Configuration > Port Mirroring**. Select **Enabled** in the **Mode** field to activate mirroring on the Switch.
- Set **Type** to **Intermediate** to configure the intermediate ports that help forward traffic.
- Enter the remote port mirroring VLAN ID number (**100** in this example). The Switch will automatically create the remote port mirroring VLAN and configure the intermediate ports as a member of this VLAN.
- Configure ports (3 and 4 for example) to act as the intermediate ports that connect to Switch **A** and Switch **C**.

- Click **Save**.

### Mirroring & Remote Port Mirroring Configuration

Session Number: 1

Mode: Enabled

Type: Intermediate

VLAN ID: 100

Reflector Port: Disabled

Port	Source	Intermediate	Destination
1	Disabled	<input type="checkbox"/>	<input type="checkbox"/>
2	Disabled	<input type="checkbox"/>	<input checked="" type="checkbox"/>
3	Disabled	<input checked="" type="checkbox"/>	<input type="checkbox"/>
4	Disabled	<input checked="" type="checkbox"/>	<input type="checkbox"/>
5	Disabled	<input type="checkbox"/>	<input type="checkbox"/>
6	Disabled	<input type="checkbox"/>	<input type="checkbox"/>
7	Disabled	<input type="checkbox"/>	<input type="checkbox"/>
8	Disabled	<input type="checkbox"/>	<input type="checkbox"/>

Save Reset

- Go to **Configuration > MAC Table** to disable MAC address learning on the intermediate ports so that the Switch will NOT filter or forward a frame based on the frame's destination MAC address, or even drop the frame whose MAC address is not in the MAC address table on these ports.

### MAC Address Table Configuration

#### Aging Configuration

Disable Automatic Aging:

Aging Time: 300 seconds

#### MAC Table Learning

	Port Members																									
	1	2	3	4	5	6	7	8	9	10	11	12	13	14	15	16	17	18	19	20	21	22	23	24	25	26
Auto	<input checked="" type="radio"/>	<input checked="" type="radio"/>	<input checked="" type="radio"/>	<input checked="" type="radio"/>	<input checked="" type="radio"/>	<input checked="" type="radio"/>	<input checked="" type="radio"/>	<input checked="" type="radio"/>	<input checked="" type="radio"/>	<input checked="" type="radio"/>	<input checked="" type="radio"/>	<input checked="" type="radio"/>	<input checked="" type="radio"/>	<input checked="" type="radio"/>	<input checked="" type="radio"/>	<input checked="" type="radio"/>	<input checked="" type="radio"/>	<input checked="" type="radio"/>	<input checked="" type="radio"/>	<input checked="" type="radio"/>	<input checked="" type="radio"/>	<input checked="" type="radio"/>	<input checked="" type="radio"/>	<input checked="" type="radio"/>	<input checked="" type="radio"/>	<input checked="" type="radio"/>
Disable	<input checked="" type="radio"/>	<input checked="" type="radio"/>	<input checked="" type="radio"/>	<input checked="" type="radio"/>	<input checked="" type="radio"/>	<input checked="" type="radio"/>	<input checked="" type="radio"/>	<input checked="" type="radio"/>	<input checked="" type="radio"/>	<input checked="" type="radio"/>	<input checked="" type="radio"/>	<input checked="" type="radio"/>	<input checked="" type="radio"/>	<input checked="" type="radio"/>	<input checked="" type="radio"/>	<input checked="" type="radio"/>	<input checked="" type="radio"/>	<input checked="" type="radio"/>	<input checked="" type="radio"/>	<input checked="" type="radio"/>	<input checked="" type="radio"/>	<input checked="" type="radio"/>	<input checked="" type="radio"/>	<input checked="" type="radio"/>	<input checked="" type="radio"/>	<input checked="" type="radio"/>
Secure	<input type="radio"/>	<input type="radio"/>	<input type="radio"/>	<input type="radio"/>	<input type="radio"/>	<input type="radio"/>	<input type="radio"/>	<input type="radio"/>	<input type="radio"/>	<input type="radio"/>	<input type="radio"/>	<input type="radio"/>	<input type="radio"/>	<input type="radio"/>	<input type="radio"/>	<input type="radio"/>	<input type="radio"/>	<input type="radio"/>	<input type="radio"/>	<input type="radio"/>	<input type="radio"/>	<input type="radio"/>	<input type="radio"/>	<input type="radio"/>	<input type="radio"/>	<input type="radio"/>

#### Static MAC Table Configuration

	Port Members																											
Delete	VLAN ID	MAC Address	1	2	3	4	5	6	7	8	9	10	11	12	13	14	15	16	17	18	19	20	21	22	23	24	25	26

Add New Static Entry

Save Reset

## In Switch C:

- 1 Access the Switch through **http://192.168.1.1**. Log into the Switch by entering the username (default: **admin**) and password (default: **1234**).
- 2 Go to **Configuration > Port Mirroring**. Select **Enabled** in the **Mode** field to activate mirroring on the Switch.
- 3 Set **Type** to **Destination** to configure the intermediate ports that help forward traffic.
- 4 Enter the remote port mirroring VLAN ID number (**100** in this example). The Switch will automatically create the remote port mirroring VLAN and configure the intermediate and destination ports as a member of this VLAN.
- 5 Configure a port (2 for example) to act as the intermediate port that connects to Switch **B**.
- 6 Configure a port (10 for example) to act as the destination port that receives the copy of traffic from the source port on Switch **A** for analysis.
- 7 Click **Save**.

**Mirroring & Remote Port Mirroring Configuration**

Session Number: 1

Mode: Enabled

Type: Destination

VLAN ID: 100

Reflector Port: Port 1

Port	Source	Intermediate	Destination
1	Disabled	<input type="checkbox"/>	<input type="checkbox"/>
2	Disabled	<input checked="" type="checkbox"/>	<input type="checkbox"/>
3	Disabled	<input type="checkbox"/>	<input type="checkbox"/>
4	Disabled	<input type="checkbox"/>	<input type="checkbox"/>
5	Disabled	<input type="checkbox"/>	<input type="checkbox"/>
6	Disabled	<input type="checkbox"/>	<input type="checkbox"/>
7	Disabled	<input type="checkbox"/>	<input type="checkbox"/>
8	Disabled	<input type="checkbox"/>	<input type="checkbox"/>
9	Disabled	<input type="checkbox"/>	<input type="checkbox"/>
10	Disabled	<input type="checkbox"/>	<input checked="" type="checkbox"/>
11	Disabled	<input type="checkbox"/>	<input type="checkbox"/>
12	Disabled	<input type="checkbox"/>	<input type="checkbox"/>

Save Reset

- 8 Go to **Configuration > MAC Table** to disable MAC address learning on the intermediate and destination ports so that the Switch will NOT filter or forward a frame based on the frame's destination MAC address, or even drop the frame whose MAC address is not in the MAC address table on these ports.

### MAC Address Table Configuration

#### Aging Configuration

Disable Automatic Aging

Aging Time  seconds

#### MAC Table Learning

	Port Members																										
	1	2	3	4	5	6	7	8	9	10	11	12	13	14	15	16	17	18	19	20	21	22	23	24	25	26	
Auto	<input type="radio"/>	<input type="radio"/>	<input type="radio"/>	<input type="radio"/>	<input type="radio"/>	<input type="radio"/>	<input type="radio"/>	<input type="radio"/>	<input type="radio"/>	<input type="radio"/>	<input type="radio"/>	<input type="radio"/>	<input type="radio"/>	<input type="radio"/>	<input type="radio"/>	<input type="radio"/>	<input type="radio"/>	<input type="radio"/>	<input type="radio"/>	<input type="radio"/>	<input type="radio"/>	<input type="radio"/>	<input type="radio"/>	<input type="radio"/>	<input type="radio"/>	<input type="radio"/>	<input type="radio"/>
Disable	<input type="radio"/>	<input type="radio"/>	<input type="radio"/>	<input type="radio"/>	<input type="radio"/>	<input type="radio"/>	<input type="radio"/>	<input type="radio"/>	<input type="radio"/>	<input type="radio"/>	<input type="radio"/>	<input type="radio"/>	<input type="radio"/>	<input type="radio"/>	<input type="radio"/>	<input type="radio"/>	<input type="radio"/>	<input type="radio"/>	<input type="radio"/>	<input type="radio"/>	<input type="radio"/>	<input type="radio"/>	<input type="radio"/>	<input type="radio"/>	<input type="radio"/>	<input type="radio"/>	<input type="radio"/>
Secure	<input type="radio"/>	<input type="radio"/>	<input type="radio"/>	<input type="radio"/>	<input type="radio"/>	<input type="radio"/>	<input type="radio"/>	<input type="radio"/>	<input type="radio"/>	<input type="radio"/>	<input type="radio"/>	<input type="radio"/>	<input type="radio"/>	<input type="radio"/>	<input type="radio"/>	<input type="radio"/>	<input type="radio"/>	<input type="radio"/>	<input type="radio"/>	<input type="radio"/>	<input type="radio"/>	<input type="radio"/>	<input type="radio"/>	<input type="radio"/>	<input type="radio"/>	<input type="radio"/>	<input type="radio"/>

#### Static MAC Table Configuration

	Port Members																											
Delete	VLAN ID	MAC Address	1	2	3	4	5	6	7	8	9	10	11	12	13	14	15	16	17	18	19	20	21	22	23	24	25	26
Add New Static Entry																												

## 5.11 How to Use IGMP Snooping to Reduce Multicast Traffic Passing through your Switch

The Switch can passively snoop on IGMP packets transferred between IP multicast routers/switches and IP multicast hosts to learn the IP multicast group membership. It checks IGMP packets passing through it, picks out the group registration information, and configures multicasting accordingly. IGMP snooping allows the Switch to learn multicast groups without you having to manually configure them.

The Switch forwards multicast traffic destined for multicast groups (that it has learned from IGMP snooping or that you have manually configured) to ports that are members of that group. IGMP snooping generates no additional network traffic, allowing you to significantly reduce multicast traffic passing through your Switch.

The Switch can perform IGMP snooping on up to 32 VLANs. You can configure the Switch to automatically learn multicast group membership of any VLANs.

Follow the steps below to enable IGMP snooping on the Switch and a specific VLAN. You also have the Switch act as an IGMP proxy to report group changes to a connected multicast router (R).

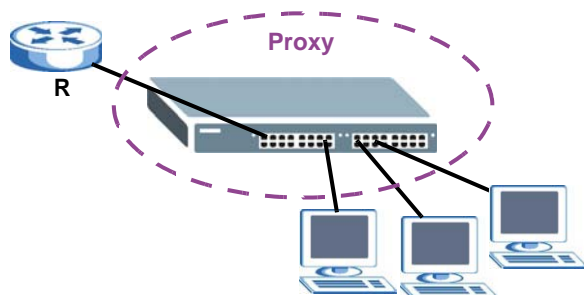

- 1 Access the Switch through **http://192.168.1.1**. Log into the Switch by entering the username (default: **admin**) and password (default: **1234**).
- 2 Go to **Configuration > IPMAC > IGMP Snooping > Basic Configuration**. Select the **Snooping Enabled** check box to activate IGMP snooping on the Switch.
- 3 The **Unknown Multicast Flooding Enabled** check box is selected by default and the Switch will send the frame(s) to all ports when the it receives an unknown multicast frame.
- 4 In the **IGMP SSM Range** field, specify the source address range of the multicast group the clients will listen to. The Switch forwards the packets with the configured source address(es) to the clients that join this group. This help prevent the clients from receiving traffic resulting from unwanted sources.
- 5 Set **Leave Proxy Enabled** and **Proxy Enabled** to allow the Switch to send a leave message with its MAC address to the multicast router/switch only when it receives the leave message from the last host in a multicast group. The Switch also replaces the source MAC address in an IGMP v1/v2 report with its own MAC address before forwarding to the multicast router/switch. When the Switch receives more than one IGMP v1/v2 join reports that request to join the same multicast group, it only sends a new join report with its MAC address. This helps reduce the number of multicast join and leave messages passed to the multicast router/switch.
- 6 Select a router port (port 1 in this example) that connects to the multicast router or switch. The Switch forwards IGMP control messages (Query, Join and Leave) to the router port.
- 7 Enable **Fast Leave** on the ports that connect to the hosts/clients (ports 7, 8 and 9 in this example). In fast leave mode, the Switch removes an IGMP snooping membership entry immediately from the forwarding table when an IGMP leave message is received on the port from a host. This helps speed up the leave process.
- 8 Also set the maximum number of multicast groups the ports can join.

- 9 Click **Save**.

**IGMP Snooping Configuration**

**Global Configuration**

Snooping Enabled

Unknown Multicast Flooding Enabled

IGMP SSM Range  /

Leave Proxy Enabled

Proxy Enabled

**Port Related Configuration**

Port	Router Port	Fast Leave	Throttling
*	<input type="checkbox"/>	<input type="checkbox"/>	<> ▼
1	<input checked="" type="checkbox"/>	<input type="checkbox"/>	unlimited ▼
2	<input type="checkbox"/>	<input type="checkbox"/>	unlimited ▼
3	<input type="checkbox"/>	<input type="checkbox"/>	unlimited ▼
4	<input type="checkbox"/>	<input type="checkbox"/>	unlimited ▼
5	<input type="checkbox"/>	<input type="checkbox"/>	unlimited ▼
6	<input type="checkbox"/>	<input type="checkbox"/>	unlimited ▼
7	<input type="checkbox"/>	<input checked="" type="checkbox"/>	5 ▼
8	<input type="checkbox"/>	<input checked="" type="checkbox"/>	5 ▼
9	<input type="checkbox"/>	<input checked="" type="checkbox"/>	5 ▼
10	<input type="checkbox"/>	<input type="checkbox"/>	unlimited ▼
11	<input type="checkbox"/>	<input type="checkbox"/>	unlimited ▼

- 10 Configure both the router port and the ports to which the multicast clients connect as a member of VLAN 1234. See [Section 5.4 on page 38](#) for how to create a VLAN and configure ports to join the VLAN.
- 11 Go to **Configuration > IPMAC > IGMP Snooping > VLAN Configuration**.
- 12 Select **Snooping Enabled** for VLAN 1234 to allow the Switch to learn the IP multicast group membership of this VLAN.
- 13 Select **IGMP Querier** for VLAN 1234 to allow the Switch to act as the querier in the VLAN to send IGMP General Query (GQ) and Group-Specific Query (GSQ) messages to this VLAN. A querier sends out an IGMP Group-Specific Query (GSQ) message to determine whether the hosts connected to the port should remain in the specific multicast group.

- 14 Click **Save**.

**IGMP Snooping VLAN Configuration** Refresh | << | >>

Start from VLAN  with  entries per page.

Delete	VLAN ID	Snooping Enabled	IGMP Querier	Compatibility	RV	QI (sec)	QRI (0.1 sec)	LLQI (0.1 sec)	URI (sec)
<input type="checkbox"/>	1	<input checked="" type="checkbox"/>	<input checked="" type="checkbox"/>	IGMP-Auto	2	125	100	10	1
Delete	1234	<input type="checkbox"/>	<input checked="" type="checkbox"/>	IGMP-Auto	2	125	100	10	1

## 5.12 How to Configure Access Control List (ACL) for Packets Filtering

Access Control List (ACL) can be used as a simple packet filtering firewall to filter incoming traffic and prevent certain traffic from entering your network. ACL groups traffic into data flows according to specific criteria such as the source address, destination address, source port number, destination port number or incoming port number, and also define actions to be performed for a classified traffic flow.

The Switch checks traffic against the ACL rules in the order you list them.

In this example, you configure an ACL rule to identify all traffic coming from host **A** connected to port 9 and restrict the host's access to a specific IPv4 network.

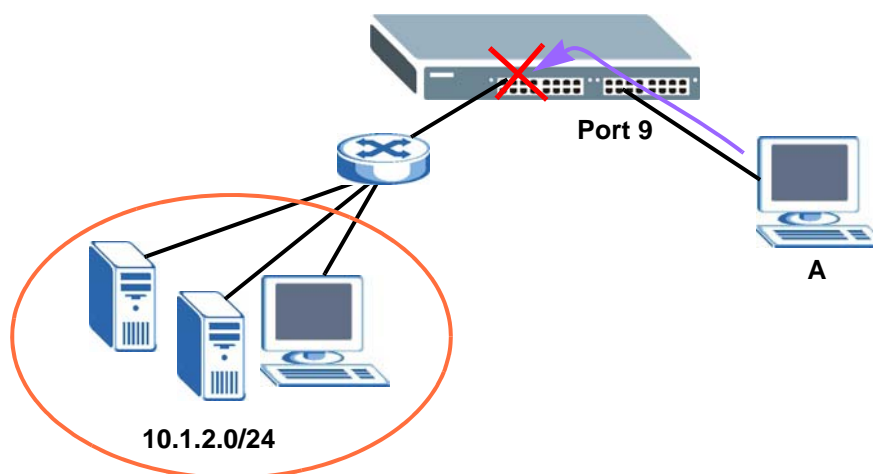

- 1 Access the Switch through **http://192.168.1.1**. Log into the Switch by entering the username (default: **admin**) and password (default: **1234**).

- 2 Go to **Configuration > Security > Network > ACL > Access Control List**. Click the **Add** icon to create a new ACL policy.



- 3 Select the port on which the matched traffic is received (**All** ports in this example).
- 4 Set **Policy Filter** to **Specific** and **Policy Bitmask** to **Oxff** to give this policy one ID number in the **Policy Value** field. You then can apply this policy to a port using this policy ID.
- 5 Select **IPv4** in the **Frame Type** field.
- 6 Select **Network** in the **DIP Filter** field and specify the destination address and subnet mask of matched traffic in this policy.
- 7 Set **Action** to **Deny** to block all matted traffic.

- 8 Click **Save**. The ordering of your rules is very important as rules are applied in the order that they are listed.

This tutorial uses the XGS1910-24 screens as an example. The screens may vary slightly for different models.

### ACE Configuration

Ingress Port	All
Policy Filter	Specific
Policy Value	2
Policy Bitmask	0xff
Frame Type	IPv4

Action	Deny
Rate Limiter	Disabled
Port Redirect	Disabled
Logging	Disabled
Shutdown	Disabled
Counter	0

### MAC Parameters

DMAC Filter	Any
-------------	-----

### VLAN Parameters

VLAN ID Filter	Any
Tag Priority	Any

### IP Parameters

IP Protocol Filter	Any
IP TTL	Any
IP Fragment	Any
IP Option	Any
SIP Filter	Any
DIP Filter	Network
DIP Address	10.1.2.0
DIP Mask	255.255.255.0

### Access Control List Configuration

Auto-refresh

Ingress Port	Policy / Bitmask	Frame Type	Action	Rate Limiter	Port Redirect	Counter
All	2 / 0xff	IPv4 DIP:10.1.2.0/24	Deny	Disabled	Disabled	0

- 9 Go to **Configuration > Security > Network > ACL > Ports**. Enter the ID of the ACL policy you just created in the **Policy ID** field of the port to which you want to apply this policy, that is, port **9** to which host **A** is connected in this example.

- 10 Click **Save**. The ACL configurations in the **Ports** page (such as **Action** or **Rate Limiter ID**) apply only to traffic that does NOT matched the specified ACL policy.

**ACL Ports Configuration** Refresh Clear

Port	Policy ID	Action	Rate Limiter ID	Port Redirect	Logging	Shutdown	State	Counter
*	0	<>	<>	<>	<>	<>	<>	*
1	0	Permit	Disabled	Disabled	Disabled	Disabled	Enabled	0
2	0	Permit	Disabled	Disabled	Enabled	Disabled	Enabled	0
3	0	Permit	Disabled	Disabled	Disabled	Disabled	Enabled	0
4	0	Permit	Disabled	Disabled	Disabled	Disabled	Enabled	0
5	0	Permit	Disabled	Disabled	Disabled	Disabled	Enabled	0
6	0	Permit	Disabled	Disabled	Disabled	Disabled	Enabled	0
7	0	Permit	Disabled	Disabled	Disabled	Disabled	Enabled	0
8	0	Permit	Disabled	Disabled	Disabled	Disabled	Enabled	0
9	2	Permit	Disabled	Disabled	Disabled	Disabled	Enabled	0
10	0	Permit	Disabled	Disabled	Disabled	Disabled	Enabled	0

Save Reset

## 5.13 How to Reset the Switch via the Console Port

If you lock yourself (and others) from the Switch or forget the administrator password, you will need to reload the factory-default configuration file or reset the Switch back to the factory defaults.

Uploading the factory-default configuration file replaces the current configuration file with the factory-default configuration file. This means that you will lose all previous configurations and the speed of the console port will be reset to the default of 9600bps with 8 data bit, no parity, one stop bit and flow control set to none. The password will also be reset to "1234" and the IP address to 192.168.1.1.

To upload the configuration file, do the following:

- 1 Connect to the console port using a computer with terminal emulation software. See [Section 3.1.4 on page 20](#) for details.
- 2 Disconnect and reconnect the Switch's power to begin a session. When you reconnect the Switch's power, you will see the initial screen.
- 3 When you see the message "Executing boot script in 3.000 seconds - enter ^C to abort" press the Ctrl-c key combination to stop the automatic boot and then type default.
- 4 Type reset after the "Erase from 0x40080000-0x4017ffff: ....." message.

- 5 After the Switch restarts, you can use the default user name and password to log in.

```

>+M25PXX : Init device with JEDEC ID 0xC22018.
Jaguar-1 board detected (VSC7460 Rev. B).

RedBoot(tm) bootstrap and debug environment [ROMRAM]
Non-certified release, version 1_12_2-customized-z-XGS - built 19:04:36, Feb  8 2012

Copyright (C) 2000, 2001, 2002, 2003, 2004, 2005, 2006, 2007, 2008, 2009
Free Software Foundation, Inc.
RedBoot is free software, covered by the eCos license, derived from the
GNU General Public License. You are welcome to change it and/or distribute
copies of it under certain conditions. Under the license terms, RedBoot's
source code and full license terms must have been made available to you.
Redboot comes with ABSOLUTELY NO WARRANTY.

Platform: VCore-III (MIPS32 24KEc) JAGUAR
RAM: 0x80000000-0x88000000 [0x800214d8-0x87fe1000 available]
FLASH: 0x40000000-0x40ffffff, 256 x 0x10000 blocks
== Executing boot script in 3.000 seconds - enter ^C to abort
^C
RedBoot> default
... Erase from 0x40080000-0x4017ffff: .....
RedBoot> reset
+M25PXX : Init device with JEDEC ID 0xC22018.
Jaguar-1 board detected (VSC7460 Rev. B).

RedBoot(tm) bootstrap and debug environment [ROMRAM]
Non-certified release, version 1_12_2-customized-z-XGS - built 19:04:36, Feb 8 2012

Copyright (C) 2000, 2001, 2002, 2003, 2004, 2005, 2006, 2007, 2008, 2009
Free Software Foundation, Inc.
RedBoot is free software, covered by the eCos license, derived from the
GNU General Public License. You are welcome to change it and/or distribute
copies of it under certain conditions. Under the license terms, RedBoot's
source code and full license terms must have been made available to you.
Redboot comes with ABSOLUTELY NO WARRANTY.

Platform: VCore-III (MIPS32 24KEc) JAGUAR
RAM: 0x80000000-0x88000000 [0x800214d8-0x87fe1000 available]
FLASH: 0x40000000-0x40ffffff, 256 x 0x10000 blocks
== Executing boot script in 3.000 seconds - enter ^C to abort
RedBoot> diag -a
Hardware self-test: ... Passed
IS0 TCAM self-test: ... Passed
IS1 TCAM self-test: ... Passed
IS2 TCAM self-test: ... Passed
ES0 TCAM self-test: ... Passed
L3 TCAM self-test: ... Passed
DDR SDRAM: Testing [0x800214d8-0x87fe1000] - Zero Sweep Done
DDR SDRAM: Testing [0x800214d8-0x87fe1000] - Write Sweep .....
..... Done
DDR SDRAM: Testing [0x800214d8-0x87fe1000] - Read Sweep .....
..... Done
3 tests completed successfully.
RedBoot> fis load -d managed
Image loaded from 0x80040000-0x806a4d20
RedBoot> go

Username:

```



# Troubleshooting

This chapter offers some suggestions to solve problems you might encounter. The potential problems are divided into the following categories.

- [Power, Hardware Connections, and LEDs](#)
- [Switch Access and Login](#)

## 6.1 Power, Hardware Connections, and LEDs

---

The Switch does not turn on. None of the LEDs turn on.

---

- 1 Make sure the Switch is turned on (in DC models or if the DC power supply is connected in AC/DC models).
- 2 Make sure you are using the power adaptor or cord included with the Switch.
- 3 Make sure the power adaptor or cord is connected to the Switch and plugged in to an appropriate power source. Make sure the power source is turned on.
- 4 Turn the Switch off and on (in DC models or if the DC power supply is connected in AC/DC models).
- 5 Disconnect and re-connect the power adaptor or cord to the Switch (in AC models or if the AC power supply is connected in AC/DC models).
- 6 If the problem continues, contact the vendor.

---

The **ALM** LED is on.

---

- 1 Turn the Switch off and on (in DC models or if the DC power supply is connected in AC/DC models).
- 2 Disconnect and re-connect the power adaptor or cord to the Switch (in AC models or if the AC power supply is connected in AC/DC models).
- 3 If the problem continues, contact the vendor.

---

One of the LEDs does not behave as expected.

---

- 1 Make sure you understand the normal behavior of the LED. See [Section 3.3 on page 22](#).
- 2 Check the hardware connections. See [Section 3.1 on page 15](#).
- 3 Inspect your cables for damage. Contact the vendor to replace any damaged cables.
- 4 Turn the Switch off and on (in DC models or if the DC power supply is connected in AC/DC models).
- 5 Disconnect and re-connect the power adaptor or cord to the Switch (in AC models or if the AC power supply is connected in AC/DC models).
- 6 If the problem continues, contact the vendor.

## 6.2 Switch Access and Login

---

I forgot the IP address for the Switch.

---

- 1 The default management IP address is **192.168.1.1**.
- 2 Use the console port to log in to the Switch.
- 3 If this does not work, you have to reset the device to its factory defaults. See [Section 5.13 on page 66](#).

---

I forgot the username and/or password.

---

- 1 The default username is **admin** and the default password is **1234**.
- 2 If this does not work, you have to reset the device to its factory defaults. See [Section 5.13 on page 66](#).

---

I cannot see or access the **Login** screen in the web configurator.

---

- 1 Make sure you are using the correct IP address.
  - The default management IP address is **192.168.1.1**.
  - If you changed the IP address, use the new IP address.

- If you changed the IP address and have forgotten it, see the troubleshooting suggestions for [I forgot the IP address for the Switch](#).
- 2 Check the hardware connections, and make sure the LEDs are behaving as expected. See [Section 3.3 on page 22](#).
  - 3 Make sure your Internet browser does not block pop-up windows and has JavaScripts and Java enabled.
  - 4 Make sure your computer is in the same subnet as the Switch. (If you know that there are routers between your computer and the Switch, skip this step.)
  - 5 Reset the device to its factory defaults, and try to access the Switch with the default IP address. See [Section 5.13 on page 66](#).
  - 6 If the problem continues, contact the vendor.

---

I can see the **Login** screen, but I cannot log in to the Switch.

---

- 1 Make sure you have entered the user name and password correctly. The default user name is **admin**, and the default password is **1234**. These fields are case-sensitive, so make sure [Caps Lock] is not on.
- 2 If you have configured a secured client IP address in **Configuration > Security > Switch > Access Management**, your computer's IP address must match it.
- 3 Disconnect and re-connect the cord to the Switch.
- 4 If this does not work, you have to reset the device to its factory defaults. See [Section 5.13 on page 66](#).

---

[Pop-up Windows, JavaScripts and Java Permissions](#)

---

In order to use the web configurator you need to allow:

- Web browser pop-up windows from your device.
- JavaScripts (enabled by default).
- Java permissions (enabled by default).

---

[There is unauthorized access to my Switch via HTTP.](#)

---

Use the **Monitor > System > Log** screen to check for unauthorized access to your Switch. To avoid unauthorized access, configure the secured client setting in the **Configuration > Security > Switch > Access Management** screen for HTTP/HTTPS and SNMP. Computers not belonging to the secured client set cannot get permission to access the Switch.



# Legal Information

## Copyright

Copyright © 2012 by ZyXEL Communications Corporation.

The contents of this publication may not be reproduced in any part or as a whole, transcribed, stored in a retrieval system, translated into any language, or transmitted in any form or by any means, electronic, mechanical, magnetic, optical, chemical, photocopying, manual, or otherwise, without the prior written permission of ZyXEL Communications Corporation.

Published by ZyXEL Communications Corporation. All rights reserved.

## Disclaimer

ZyXEL does not assume any liability arising out of the application or use of any products, or software described herein. Neither does it convey any license under its patent rights nor the patent rights of others. ZyXEL further reserves the right to make changes in any products described herein without notice. This publication is subject to change without notice.

## Trademarks

Trademarks mentioned in this publication are used for identification purposes only and may be properties of their respective owners.

## Certifications

### Federal Communications Commission (FCC) Interference Statement

This device complies with Part 15 of FCC rules. Operation is subject to the following two conditions:

- This device may not cause harmful interference.
- This device must accept any interference received, including interference that may cause undesired operations.

### FCC Warning

This device has been tested and found to comply with the limits for a Class A digital switch, pursuant to Part 15 of the FCC Rules. These limits are designed to provide reasonable protection against harmful interference in a commercial environment. This device generates, uses, and can radiate radio frequency energy and, if not installed and used in accordance with the instruction manual, may cause harmful interference to radio communications. Operation of this device in a residential area is likely to cause harmful interference in which case the user will be required to correct the interference at his own expense.

### CE Mark Warning:

This is a class A product. In a domestic environment this product may cause radio interference in which case the user may be required to take adequate measures.

### Taiwanese BSMI (Bureau of Standards, Metrology and Inspection) A Warning:

警告使用者

這是甲類的資訊產品，在居住的環境使用時，

可能造成射頻干擾，在這種情況下，

使用者會被要求採取某些適當的對策。

### Notices

Changes or modifications not expressly approved by the party responsible for compliance could void the user's authority to operate the equipment.

Cet appareil numérique de la classe A est conforme à la norme NMB-003 du Canada.

CLASS 1 LASER PRODUCT

APPAREIL À LASER DE CLASS 1

PRODUCT COMPLIES WITH 21 CFR 1040.10 AND 1040.11.

PRODUIT CONFORME SELON 21 CFR 1040.10 ET 1040.11.

## Viewing Certifications

Go to <http://www.zyxel.com> to view this product's documentation and certifications.

## ZyXEL Limited Warranty

ZyXEL warrants to the original end user (purchaser) that this product is free from any defects in material or workmanship for a specific period (the Warranty Period) from the date of purchase. The Warranty Period varies by region. Check with your vendor and/or the

authorized ZyXEL local distributor for details about the Warranty Period of this product. During the warranty period, and upon proof of purchase, should the product have indications of failure due to faulty workmanship and/or materials, ZyXEL will, at its discretion, repair or replace the defective products or components without charge for either parts or labor, and to whatever extent it shall deem necessary to restore the product or components to proper operating condition. Any replacement will consist of a new or re-manufactured functionally equivalent product of equal or higher value, and will be solely at the discretion of ZyXEL. This warranty shall not apply if the product has been modified, misused, tampered with, damaged by an act of God, or subjected to abnormal working conditions.

### Note

Repair or replacement, as provided under this warranty, is the exclusive remedy of the purchaser. This warranty is in lieu of all other warranties, express or implied, including any implied warranty of merchantability or fitness for a particular use or purpose. ZyXEL shall in no event be held liable for indirect or consequential damages of any kind to the purchaser.

To obtain the services of this warranty, contact your vendor. You may also refer to the warranty policy for the region in which you bought the device at [http://www.zyxel.com/web/support\\_warranty\\_info.php](http://www.zyxel.com/web/support_warranty_info.php).

### Registration

Register your product online to receive e-mail notices of firmware upgrades and information at [www.zyxel.com](http://www.zyxel.com) for global products, or at [www.us.zyxel.com](http://www.us.zyxel.com) for North American products.

## Open Source Licenses

This product contains in part some free software distributed under GPL like licenses. Open source licenses are provided with the firmware package. You can download the latest firmware at [www.zyxel.com](http://www.zyxel.com). To obtain the source code covered under those Licenses, please contact [support@zyxel.com.tw](mailto:support@zyxel.com.tw) to get it.

## Safety Warnings

- Do NOT use this product near water, for example, in a wet basement or near a swimming pool.
- Do NOT expose your device to dampness, dust or corrosive liquids.
- Do NOT store things on the device.
- Do NOT install, use, or service this device during a thunderstorm. There is a remote risk of electric shock from lightning.
- Connect ONLY suitable accessories to the device.
- Do NOT open the device or unit. Opening or removing covers can expose you to dangerous high voltage points or other risks. ONLY qualified service personnel should service or disassemble this device. Please contact your vendor for further information.
- Make sure to connect the cables to the correct ports.
- Place connecting cables carefully so that no one will step on them or stumble over them.
- Always disconnect all cables from this device before servicing or disassembling.
- Use ONLY an appropriate power adaptor or cord for your device. Connect it to the right supply voltage (for example, 110V AC in North America or 230V AC in Europe).
- Do NOT allow anything to rest on the power adaptor or cord and do NOT place the product where anyone can walk on the power adaptor or cord.
- Do NOT use the device if the power adaptor or cord is damaged as it might cause electrocution.
- If the power adaptor or cord is damaged, remove it from the device and the power source.
- Do NOT attempt to repair the power adaptor or cord. Contact your local vendor to order a new one.
- Do not use the device outside, and make sure all the connections are indoors. There is a remote risk of electric shock from lightning.
- Do NOT obstruct the device ventilation slots, as insufficient airflow may harm your device.
- The PoE (Power over Ethernet) devices that supply or receive power and their connected Ethernet cables must all be completely indoors.
- This product is for indoor use only (utilisation intérieure exclusivement).

Your product is marked with this symbol, which is known as the WEEE mark. WEEE stands for Waste Electronics and Electrical Equipment. It means that used electrical and electronic products should not be mixed with general waste. Used electrical and electronic equipment should be treated separately.



# Index

## A

applications  
  bridging [5](#)  
  IEEE 802.1Q VLAN [7](#)  
  switched workgroup [6](#)

## B

basic setup tutorial [33](#)  
binding [45](#)  
binding table [45](#)  
  building [45](#)

## C

certifications  
  notices [73](#)  
  viewing [73](#)  
changing the password [32](#)  
console port  
  settings [20](#)  
copyright [73](#)

## D

DHCP snooping [45](#)  
  trusted ports [46](#)  
  untrusted ports [46](#)  
disclaimer [73](#)  
documentation  
  related [2](#)

## E

Ethernet ports [17](#)  
  default settings [17](#)

## F

FCC interference statement [73](#)  
front panel [15](#)

## G

getting help [32](#)

## H

hardware installation [11](#)  
  mounting [12](#)  
hardware overview [15](#)

## I

Installation  
  Rack-mounting [12](#)  
installation  
  freestanding [11](#)  
  precautions [12](#)  
Internet Protocol version 6, see IPv6  
introduction [5](#)  
IP source guard [45](#)  
  DHCP snooping [45](#)  
IPv6 [8](#)  
  Neighbor Discovery Protocol [8](#)  
  ping [8](#)

**L**

LEDs [22](#)  
lockout [32](#)  
login [25](#)  
    password [32](#)

**M**

managing the device  
    good habits [8](#)  
    using SNMP. See [SNMP](#).  
    using the web configurator. See [web configurator](#).  
mini GBIC ports [18](#)  
    connection speed [18](#)  
    connector type [18](#)  
    transceiver installation [18](#)  
    transceiver removal [19](#)  
mounting brackets [12](#)  
MSA (MultiSource Agreement) [18](#)

**O**

other documentation [2](#)

**P**

password [32](#)  
power wires [21](#)  
product registration [74](#)  
PVID [38](#)  
PVID (Priority Frame) [38](#)

**R**

registration  
    product [74](#)  
related documentation [2](#)  
rubber feet [11](#)

**S**

SNMP [8](#)  
status  
    LED [22](#)  
switch lockout [32](#)

**T**

tagged VLAN [38](#)  
trademarks [73](#)  
transceiver  
    installation [18](#)  
    removal [19](#)  
trusted ports  
    DHCP snooping [46](#)  
tutorials [33](#)  
    DHCP snooping [45](#)

**U**

untrusted ports  
    DHCP snooping [46](#)

**V**

ventilation holes [12](#)  
VID [38](#)  
VLAN  
    ID [38](#)

**W**

warranty [73](#)  
    note [74](#)  
web configurator [8, 25](#)  
    getting help [32](#)  
    layout [26](#)  
    login [25](#)  
    logout [32](#)  
    navigation panel [27](#)